

Draft Regulatory Impact Analysis: Changes to Renewable Fuel Standard Program

Draft Regulatory Impact Analysis: Changes to Renewable Fuel Standard Program

Assessment and Standards Division
Office of Transportation and Air Quality
U.S. Environmental Protection Agency

NOTICE

This technical report does not necessarily represent final EPA decisions or positions. It is intended to present technical analysis of issues using data that are currently available. The purpose in the release of such reports is to facilitate the exchange of technical information and to inform the public of technical developments.

Table of Contents

Statement of Need.....	iii
Overview.....	iv
List of Acronyms and Abbreviations.....	vi
Chapter 1: Renewable Fuel Production and Consumption.....	11
Chapter 2: Lifecycle GHG Analysis.....	278
Chapter 3: Impacts of the Program on Non-GHG Pollutants.....	436
Chapter 4: Impacts on Cost of Renewable Fuels, Gasoline, and Diesel	516
Chapter 5: Economic Impacts and Benefits.....	642
Chapter 6: Impacts on Water.....	705
Chapter 7: Initial Regulatory Flexibility Analysis.....	733
Appendix A: Biodiesel Effects on Heavy-Duty Highway Engines and Vehicles.....	743
Endnotes.....	771

Statement of Need

The current Renewable Fuel Standard (RFS) program was originally adopted by EPA to implement the provisions of the Energy Policy Act of 2005 (EPAct), which added section 211(o) to the Clean Air Act (CAA). With the passage of the Energy Independence and Security Act of 2007 (EISA), Congress recently made several important revisions to these renewable fuel requirements. This proposal would revise the RFS program regulations to implement these EISA provisions.

Overview

Chapter 1: Renewable Fuel Production and Consumption

This chapter describes the various feedstocks and renewable fuel types that could potentially be used to meet the EISA biofuel standards. The availability and challenges of harvesting, storing, and transporting these feedstocks are discussed, as well as the different biofuel production technologies, industry plans, and potential growth projections for future facilities. A discussion of biofuel distribution and consumption is included.

Chapter 2: Lifecycle GHG Analysis

This chapter describes the methodology used to determine the lifecycle greenhouse gas (GHG) emissions of the renewable fuels required by EISA, and to determine which qualify for the four GHG reduction thresholds established in EISA. Future inclusion of other feedstocks and fuel is discussed, as well as the overall GHG benefits of the RFS program.

Chapter 3: Impacts of the Program on Non-GHG Pollutants

This chapter discusses the expected impacts of this proposed program on emissions of hydrocarbons (HC), oxides of nitrogen (NO_x), carbon monoxide (CO), particulate matter (PM₁₀ and PM_{2.5}), sulfur oxides (SO_x), ammonia (NH₃), ethanol, and air toxic emissions of benzene, 1,3-butadiene, acetaldehyde, formaldehyde, acrolein, and naphthalene. Emissions from vehicles and off-road equipment, as well as emissions from the entire fuel production and distribution chain are considered.

Chapter 4: Impacts on Cost of Renewable Fuels, Gasoline, and Diesel

The impact of the proposed program on the production and distribution costs of ethanol, biodiesel, gasoline and diesel are discussed. Per-gallon and nationwide costs are presented with and without ethanol subsidies.

Chapter 5: Economic Impacts and Benefits of the Program

This chapter summarizes the impacts of the RFS2 proposal on the U.S. and international agricultural sector, U.S. petroleum imports, and the consequences of reduced oil imports on U.S. energy security. Also, it examines the greenhouse gas benefits and the co-pollutant health and environmental impacts from the wider use of biofuels in the U.S. from this proposal.

Chapter 6: Impacts on Water

The impacts of this proposed program on different bodies of water are discussed. Aspects include feedstock production, ecological impacts, climate change, ethanol production, biodiesel production, and drinking water and public health issues.

Chapter 7: Initial Regulatory Flexibility Analysis

The Initial Regulatory Flexibility Analysis (IRFA) evaluates the potential impacts of the proposed standards on small entities. In developing the IRFA, we conducted outreach and held meetings with representatives from the various small entities that could be affected by the rulemaking. Small business recommendations are discussed.

Appendix

EPA conducted a comprehensive analysis of the emission impacts of biodiesel using heavy-duty, in-use diesel chassis and engine exhaust emissions data. The emission impacts on NO_x, PM, HC, and CO of 20 volume percent biodiesel fuels produced from various animal- and plant-based feedstock materials tested under several cycles in this analysis.

List of Acronyms and Abbreviations

ACE	American Coalition for Ethanol
ACS	American Cancer Society
ADM	Archer Daniels Midland
AEO	Annual Energy Outlook (an EIA publication)
AHC	Aromatic hydrocarbons
ARMS	Agricultural Resource Management Survey
ASTM	American Society of Testing and Materials
B0, B5, B20, etc	Percent of biodiesel, e.g., B5= 5% biodiesel, 95% diesel
bbl	Barrel
BEA	Bureau of Economic Analysis
Bgal, bgal, bilgal, bg	Billions of gallons
BGY	Billions of gallons per year
BPCD	Barrels Per calendar day
BPSD	Barrels per stream day
bpd, bbbls/day	Barrels Per Day
Brix	A measurement of the sugar content of a solution at a given temperature
BTL	Biomass-to-liquid
BTU	British Thermal Unit
BU	Bushel
Bu/acre	Bushels per acre
BZ	Benzene
C	Carbon
C&D	Construction and Demolition
CA	California
CAA	Clean Air Act
CAIR	Clean Air Interstate Rule
CARB	California Air Resources Board
CaRFG3	California Phase 3 RFG
CBG	Cleaner Burning Gasoline
CBI	Caribbean Basin Initiative
CB05	Carbon Bond 05
CD	Census Division
CFEIS	EPA's Certification and Fuel Economy Information System
CFR	Code of Federal Regulations
c/gal	Cents per gallon
CG	Conventional Gasoline
CH ₃ CHO	Acetaldehyde
CH ₃ C(O)OO·	Acetyl peroxy radical
CH ₃ C(O)OONO ₂	Peroxyacetyl nitrate
CHF	Congestive heart failure
CHP	Combined Heat and Power Technology
CIMT	Carotid intima-media thickness
CMAQ	Community Multi-scale Air Quality model
CO	Carbon Monoxide
CO ₂	Carbon Dioxide
COHb	Carboxyhemoglobin
Co-op	Cooperative
CRC	Coordinating Research Council
CRGNSA	Columbia River Gorge National Scenic Area
CRP	Conservation Reserve Program

CTL	Coal-to-liquid
DDGS	Distillers' Dried Grains with Solubles
DGS	Distillers' Grains with Solubles
DHHS	Department of Health and Human Services
DOE	Department of Energy
DRIA	Draft Regulatory Impact Analysis
dt	Dry ton
E&C	Engineering and Construction
E0	Gasoline Blend which Does Not Contain Ethanol
E10	Gasoline Blend containing a nominal 10 percent ethanol by volume
E85	Gasoline Blend containing 85 percent ethanol by volume
E200	Percent of Fuel Evaporated at 200 Degrees F (ASTM D 86)
E300	Percent of Fuel Evaporated at 300 Degrees F (ASTM D 86)
EIA	Energy Information Administration (part of the U.S. Department of Energy)
EISA	Energy Independence and Security Act
Energy Act	Energy Policy Act of 2005 (also the Act)
EPA	Environmental Protection Agency
EPAct	Energy Policy Act of 2005 (also 'the Energy Act' or 'the Act')
ETBE	Ethyl Tertiary Butyl Ether
ETOH	Ethanol
EU	European Union
ex CA	Excluding California
F, °F	Fahrenheit
F-T	Fischer-Tropsch
FAME	Fatty acid methyl ester
FAPRI	Farm and Agricultural Policy Research Institute
FASOM	Forestry and Agriculture Sector Optimization Model
FBP	Feed Boiling Point (also Final Boiling Point)
FCC	Fluidized Catalytic Cracker
FCCU	Fluidized Catalytic Cracking Unit
FHWA	Federal Highway Administration
FOEB	Fuel Oil Equivalent Barrel
FR	Federal Register
FRM	Final Rulemaking
FRTTP	Fixed Reduction Trigger Point
FFV	Flexible Fuel Vehicle
FTP	Federal test procedure
g/Btu	Grams per Btu
g/day	Grams per day
Gal, gal	Gallon
GDP	Gross Domestic Product
GEOS	Goddard Earth Observing System
GHG	Greenhouse Gases
GPA	Geographic Phase-in Area
GREET	Greenhouse Gas, Regulated Emissions, and Energy Use in Transportation model
GWP	Global warming potentials
ha	Hectare
H ₂ O	Water
HC	Hydrocarbon(s)
HCO	Heavy Cycle Oil (a refinery stream)
HCHO	Formaldehyde
HDN	Naphtha Hydrotreater (also Hydro-Denitrogenation Unit)
HEI	Health Effects Institute

HNO ₃	Nitric acid
HSR	Heavy Straight Run (a refinery stream)
HVGO	Heavy Vacuum Gas Oil (a refinery stream)
IARC	International Agency for Research on Carcinogens
IBP	Initial Boiling Point
IRFA	Initial Regulatory Flexibility Analysis
k	Thousand
kbbbl	Thousand barrels
kg	kilogram
kwh	Kilowatt Hour
L, l	Liter
Lb, lb	Pound
LCC	Land Capability Classification
LCO	Light Cycle Oil (a refinery stream)
LEV	Low emission vehicle
LLE	Liquid-Liquid Extraction
LNS	Light Naphtha Splitter
LP	Linear Programming (a type of refinery model)
LSR	Light Straight Run (a refinery stream)
m ²	Square meter
MCIP	Meteorology-Chemistry Interface Processor
mg/m ³	Milligrams per cubic meter
MGY, MMgy	Million Gallons per Year
mm	Millimeter
MM	Million
MMBTU	Million British Thermal Units
MMbbls/cd	Millions of barrels per calendar day
MMGal/yr	Millions of gallons per year
MOBILE (5, 6, 6.2)	EPA's Motor Vehicle Emission Inventory Model (versions)
MON	Motor Octane Number
MOVES	Motor Vehicle Emissions Simulator
MOVES2006	EPA's Next Generation Highway Vehicle Emission Model
MSAT	Mobile Source Air Toxics
MSAT1	2001 Mobile Source Air Toxics Rule
MSAT2	2006 Proposed Mobile Source Air Toxics Rule
MSW	Municipal Solid Waste
Mt	Metric ton
MTBE	Methyl Tertiary-Butyl Ether
N	Nitrogen
NAAQS	National Ambient Air Quality Standards
NAICS	North American Industrial Classification System
NASS	National Agricultural Statistics Service
NATA	National Air Toxic Assessment
NBB	National Biodiesel Board
NCGA	National Corn Growers Association
NCI	National Cancer Institute
NCLAN	National Crop Loss Assessment Network
NCSU	North Carolina State University
NGL	Natural gas plant liquids
NH ₃	Ammonia
NIOSH	National Institute of Occupational Safety and Health
NMHC	Non-Methane Hydrocarbons
NMIM	National Mobile Inventory Model (EPA software tool)

NMOG	Non-methane organic gases
NONROAD	EPA's Non-road Engine Emission Model
NONROAD2005	EPA's Non-road Engine Emission Model Released in 2005
NO	Nitric oxide
NO ₂	Nitrogen dioxide
NO _x	Oxides of nitrogen
NPRM	Notice of Proposed Rulemaking
NRC	National Research Council
NRCS	Natural Resource Conservation Service
NREL	National Renewable Energy Laboratory
O ₃	Ozone
OA	Organic aerosol
OC	Organic carbon
·OH	Hydroxyl radical
OM	Organic mass
OMB	Office of Management and Budget
OMHCE	Organic Material Hydrocarbon Equivalent
ORD	Office of Research and Development
ORNL	Oak Ridge National Laboratory
OTAQ	Office of Transportation and Air Quality
Oxy-fuel, oxyfuel	Winter oxygenated fuel program
PADD	Petroleum Administration for Defense District
PAHs	Polycyclic aromatic hydrocarbons
PAN	Peroxyacetyl nitrate
PM	Particulate Matter
PM ₁₀	Coarse Particle
PM _{2.5}	Fine Particle
PM AQCD	Particulate Matter Air Quality Criteria Document
PMA	Petroleum Marketing Annual (an EIA publication)
POM	Polycyclic Organic Matter
PONA	Paraffin, Olefin, Naphthene, Aromatic
ppb	Parts per billion
ppm	Parts Per million
PPN	Peroxypropionyl nitrate
P RTP	Percentage Reduction Trigger Point
PSI	Pounds per Square Inch
QBtu	Quadrillion btu
Quadrillion	10 ¹⁵
(R+M)/2	Octane calculation (RON+MON)/2
R&D	Research and Development
RBOB	Reformulated Blendstock for Oxygenate Blending
rd	Renewable diesel
RFA	Regulatory Flexibility Act
RFG	Reformulated Gasoline
RFS	Renewable Fuels Standard
RFS1	Renewable Fuels Standard Program promulgated in 2007.
RFS2	Renewable Fuels Standard Changes
RIA	Regulatory Impact Analysis
RIMS	Regional Input-Output Modeling System
RIN	Renewable Identification Number
RON	Research octane number
RPMG	Renewable Products Marketing Group
RSM	Response Surface Model

RVP	Reid Vapor Pressure
S	Sulfur
SBA	Small Business Administration
SBAR Panel, or 'the Panel'	Small Business Advocacy Review Panel
SBREFA	Small Business Regulatory Enforcement Fairness Act (of 1996)
scf	Standard cubic feet
SER	Small Entity Representative
SI	Spark Ignition
SOA	Secondary Organic Aerosol
SOC	Secondary organic carbon
SOC	Soil organic carbon
SO _x	Oxides of Sulfur
SULEV	Super ultra low emission vehicle
SVOC	Semi-volatile organic compound
T50	Temperature at which 50% (by volume) of fuel evaporates (ASTM D 86)
T90	Temperature at which 90% (by volume) of fuel evaporates (ASTM D 86)
TAME	Tertiary Amyl Methyl Ether
Ton	2000 lbs
Tonne	Metric tonne (equivalent to 1.1 tons); also metric ton
TRQ	Tariff rate quotas
ULEV	Ultra low emission vehicle
U.S.C.	United States Code
USDA	U.S. Department of Agriculture
VGO	Vacuum Gas Oil (a refinery stream)
VMT	Vehicle Miles Traveled
VOC	Volatile Organic Compound
vol%	Percent by volume, volume percent
WDGS	Wet Distillers Grain w/ Solubles
wt%	Percent by weight, weight percent
yr, y	Year

Chapter 1: Renewable Fuel Production and Consumption

1.1 Biofuel Feedstock Availability

Currently, the main feedstocks used for renewable fuel production are corn for ethanol and soy for biodiesel. As technologies improve, we expect more emphasis on using cellulosic feedstocks such as agricultural residues, forestry residues, etc. However, limitations may occur due to concerns over sustainable removal rates for initial cellulosic feedstocks. Thus, dedicated energy crops which are touted as requiring low fertilizer and energy inputs as well as having the ability of being grown on marginal lands may also enter the market. The following sections discuss the current and potential availability of biofuel feedstocks and the potential challenges that must be overcome in order for enough feedstock to be collected to meet the EISA requirement of 36 billion gallons of renewable fuel by 2022.

1.1.1 Starch/Sugar Feedstocks

The following sections describe starch and sugar feedstocks that can be used to produce ethanol. Currently, the majority of ethanol is produced from corn/grain. Recently, there have also been plans to convert sugarcane grown in the U.S. into ethanol. We also describe feedstocks used in the production of ethanol outside the U.S.

1.1.1.1 Corn/Grain Ethanol

Today's ethanol is primarily corn-based ethanol, which accounts for the majority of the estimated 9.0 billion gallons of domestic fuel ethanol produced in 2008. According to multiple sources, anywhere from 12-18 billion gallons of corn ethanol could be produced by the 2015-16 timeframe, see Table 1.1-1.¹ Studies indicate, however, that current sustainable production of corn for fuel in the U.S. may be no more than 15 billion gallons per year at most, and perhaps only 12-14 billion gallons.^{2,3} For this proposal, we modeled 15 billion gallons of corn ethanol as required to meet the EISA standards using the agricultural models FASOM and FAPRI in order to assess the impact on crop acreage, crop allocation to fuel vs. other uses, and costs. See Chapter 5 of the DRIA for more details on the modeling. In addition to acres harvested and crop allocation, factors such as crop yields and ethanol yield per bushel of feedstock impact the amount of biofuel that can be produced.

Table 1.1-1. Corn Ethanol Production Forecast Parameters and Corresponding Years

Source (cited in text above)	Fuel Volumes/Year (billion gallons)	Acres Planted (millions)	Yield (bu/acre)	Corn Allocation to Ethanol	Ethanol Conversion (gal/bu) ^b
USDA Baseline	12/2016	90	170	31%	2.76
USDA Study	15/2016	92	170	37%	2.8
NCGA Analysis ^c	12.8-17.8/2016	76-78 ^a	178-193	33-40%	2.9-3.0
This Proposal	15/2022	92/87 ^a	183	35%	2.85

^aAcres harvested

^bOur proposed scenarios assume all figures include denaturant, but most references do not specify; Differences also occur depending on whether dry or wet mills are assumed, wet mills have slightly lower yields

^cNational Corn Growers Association

Corn is mainly grown in 12 states within the United States: Illinois, Indiana, Iowa, Kansas, Kentucky, Michigan, Minnesota, Missouri, Nebraska, Ohio, South Dakota, and Wisconsin. See Table 1.1-2.

**Table 1.1-2.
U.S. Corn Harvested in 2007 by State**

State	Total Harvested (Acres)
Total	72,222,500
Illinois	13,050,000
Indiana	6,351,700
Iowa	13,850,000
Kansas	3,700,000
Kentucky	1,360,000
Michigan	2,315,900
Minnesota	7,784,500
Missouri	3,239,200
Nebraska	9,199,700
Ohio	3,604,300
South Dakota	4,488,400
Wisconsin	3,278,800

Corn yield per acre has been increasing at an average rate of about 1.7 percent per year for the past three decades.^{A,4} See Figure 1.1-1. In our economic modeling assessment, the national average corn yield is approximately 183 bu/acre in 2022, although yields are calculated at the regional level. Therefore, the national average depends on crop production in each region in a given year (see Chapter 5 of this DRIA). These yield increases over time are generally consistent with the United States Department of Agriculture (USDA) projections.⁵

^A Calculated from 1977-2007.

Figure 1.1-1. U.S. Corn Yields (1978-2008)

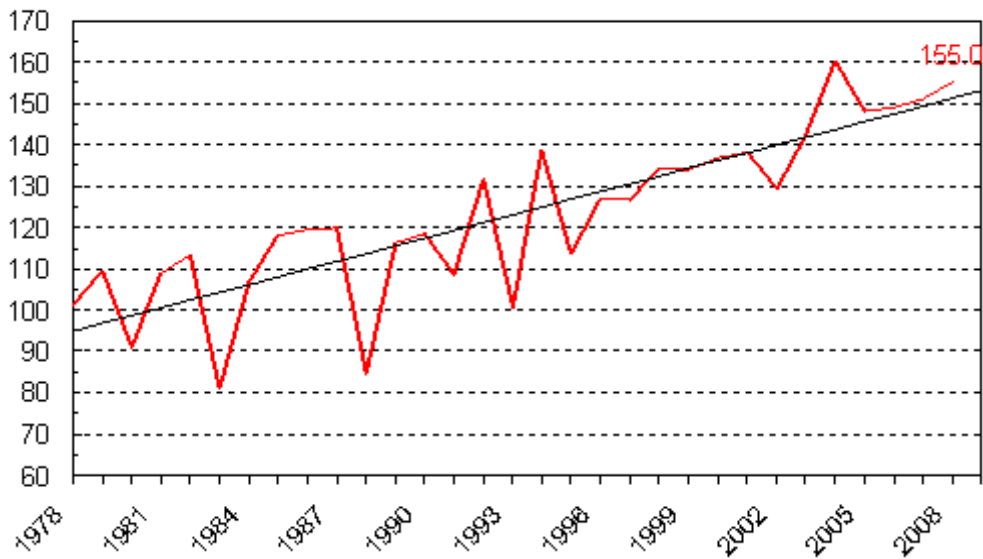

USDA-NASS
08-12-08

The percent of U.S. corn produced allocated to ethanol has increased in recent years. In 2006, the percent of U.S. corn used for ethanol was around 20 percent and in 2007 the percent had increased to 23 percent. Today, the majority of corn is still being used as animal feed (44 percent), with smaller portions going to ethanol (33 percent), exports (16 percent), human food, and seed.⁶ The FASOM projects that approximately 35 percent of corn would need to be allocated to the ethanol industry by 2022. The amount of corn allocated to fuel vs. other uses has caused much controversy over the production and use of corn-based ethanol in the past few years. There is concern that the use of corn for fuel could potentially divert corn needed to feed people. On the other hand, it is entirely possible that other countries (e.g. Argentina or Brazil) could increase their production of corn to match the increase in demand for food *and* fuel, thus meeting both needs. As many factors are in play, we can not be certain of the future. We rely on our modeling results to help inform us of the potential impacts.

Over the last 15 years, ethanol industry optimization of cooking, mashing, and fermentation conditions has increased the amount of ethanol produced from a bushel of corn. According to USDA reports, by about 2010 we can expect all plants on-line to yield an average of 2.76 gallons per bushel.^{7,8} In addition, based on discussions with USDA, we believe it is reasonable to expect an increase in corn kernel starch content of 2-4 percent over the next decade. Combining these figures, we project industry average denatured ethanol yields to reach 2.85 gallons per bushel by 2022 for dry mills and 2.63 gallons per bushel for wet mills. See section 1.4 of this DRIA for more information on corn ethanol biofuel production technologies, e.g. dry mill vs. wet mill.

1.1.1.2 Sugar Ethanol

Currently, there are no U.S. plants producing ethanol from sugar feedstocks.⁹ Brazil and several other countries are producing ethanol from sugarcane, sugar beets, and molasses,

showing that it is economically feasible to convert these feedstocks into ethanol (see section 1.1.1.3). However, the economics of producing ethanol from sugar feedstocks in these countries is not directly comparable to the economics of producing ethanol from sugar feedstocks in the U.S. Over the longer term, the profitability of producing ethanol from sugarcane, sugar beets, and molasses depends on the prices of these crops, the costs of conversion, and the price of gasoline.

Recent news indicates that there are plans in the U.S. to produce ethanol from sugar feedstocks. For instance, sugarcane has been grown in California's Imperial Valley specifically for the purpose of making ethanol and using the cane's biomass to generate electricity to power the ethanol distillery as well as export excess electricity to the electric grid.¹⁰ There are at least two projects being developed at this time that could result in several hundred million gallons of ethanol produced. One company is California Ethanol and Power which is currently in the development stage and plans to build a facility that produces 60 million gallon per year of sugarcane ethanol and 50 megawatts of electricity.¹¹ The company plans to break ground by late 2009 and be operational by 2011. The sugarcane is being grown on marginal and existing cropland that is unsuitable for food crops and will replace forage crops like alfalfa, Bermuda grass, Klein grass, etc. Harvesting is expected to be fully mechanized. Another company is Pacific West Energy LLC which plans to produce 12-15 million gallons per year of ethanol on the island of Kauai in Hawaii, perhaps as early as 2010. Hawaii is well suited for sugarcane ethanol production due to several factors, including lower costs for feedstock compared to those in the continental U.S., high prices for electricity and liquid fuels, and state production incentives.¹² Thus, there is potential for these projects and perhaps others to help contribute to the EISA biofuels mandate.

1.1.1.3 Imported Ethanol

In 2006, around 47% of world fuel ethanol production was produced from sugar crops, i.e. sugarcane and sugar beets, with the remainder mostly from grains.¹³ Sugar beets are mainly grown in France, Germany, and in the U.S., with the majority of the feedstock typically used to produce sugar for food and feed. Compared to sugar beets, sugarcane is produced in much higher volume and has been able to support a growing sugar and ethanol market. Due to a higher availability of sugarcane feedstock for ethanol production, we expect that imported ethanol to the U.S. will likely come from sugarcane.

World production of sugarcane is approximately 1.4 billion metric tons (MT) and is concentrated mainly in tropical regions, particularly in Latin America, Africa, and South and Southeast Asia. Roughly 100 countries produce sugarcane today.¹⁴ Brazil is currently the world's largest producer of sugarcane (487 million MT in the 2007/8 harvest season) and offers the greatest potential for growth, due primarily to the availability of suitable lands for expanding sugarcane cultivation.¹⁵

As far as land availability is concerned, Brazil has large potential for expanding sugarcane production. Sugarcane area in Brazil is forecasted to grow by 50% by 2010, with construction and extension of mills especially in the Centre-South. Currently expansions have mainly been into pastureland areas and not into native scrubland. In Brazil, just 20% of the

arable land is cultivated, totaling 156 million acres. The following Table 1.1-3., describes the land available/used in 2007. As there are 494 million acres of pastureland and a considerable area of unused arable land (190 million acres), it is believed that there could be a large expansion in sugarcane.¹⁶

Table 1.1-3. Brazil Land Areas in 2007.¹⁷

Million Acres	
Brazil (Total Area)	2100
Total Preserved Areas and Other Uses*	1260
Total Arable Area	840
Cultivated Land (All Crops)	156
Soybeans	51
Corn	35
Oranges	2
Sugar Cane	19
Sugar Area	11
Ethanol Area	8
Pastureland	494
Available land (ag, livestock)	190

***Areas include Amazon Rain Forest, protected areas, conservation and reforestation areas, cities and towns, roads, lakes, and rivers.**

The statistics above, however, do not indicate whether the land available requires any additional usage of water or has the proper soil and climate conditions for sugar cane. According to one study, there is at least 148 million acres of additional land available with proper soil and climate conditions for sugar cane without utilizing environmentally protected land (i.e. Amazon and native reserves) and without the use of irrigation.¹⁸ This translates to approximately 90 billion gallons of ethanol potential (using a yield of approximately 600 gal/acre which is a conservative estimate based on existing technology). Although it is not probable that all this land will be converted to sugar cane ethanol, the estimate puts into prospective the large potential for sugarcane ethanol to be produced in Brazil.

Another study commissioned by the Brazilian Government produced an analysis in which Brazil's arable land was evaluated for its suitability for cane. The benefit of this study is that it provides more detail on the land quality and yield assumptions used in its estimates than the study and statistics shown above.¹⁹ The study eliminated areas protected by environmental regulations and those with a slope greater than 12% (those not suitable for mechanized farming). The following Table 1.1-4 shows the available land calculated for sugarcane expansion at various crop yields with and without irrigation and the potential volumes that could be attained. As can be seen, there are potentially large areas of land available for sugarcane expansion in Brazil.

Table 1.1-4.
Potential Volumes Utilizing Available Land for Sugarcane Expansion^{B,19,20}

Potential	Ethanol Yield (gal/acre)	Potential Area (million acres)		Potential Ethanol Volume (billion gallons)	
		w/o irrigation	w/ irrigation	w/o irrigation	w/ irrigation
High	659	20	94	13	62
Good	592	281	242	166	143
Average	524	369	414	193	217
Inadequate	0	224	143	0	0
Total		894	894	373	422

The actual potential for ethanol from sugarcane will, however, be further limited by the amount of sugarcane diverted towards food and other uses. Taking into account demands for food and feed, the Oak Ridge National Laboratory (ORNL) Biofuel Feedstock Assessment for Selected Countries report suggests that perhaps more than 20 billion gallons of gasoline equivalent fuel could be produced from available sugarcane supply by 2017. Brazil is estimated to produce approximately 2/3 of the potential supply. The majority of this supply would likely be consumed within the country, with the leftover potentially available for export to the U.S. and other countries. Recent government and industry estimates indicate that approximately 3.8-4.2 bgal of ethanol could be available for export from Brazil by 2022 (with close to 17 billion gallons being produced and 13 billion gallons consumed domestically). See section 1.5.2.1.1 of this DRIA for further details on Brazilian ethanol production and consumption. Thus, there appears to be a large enough potential for Brazil to increase production of sugarcane to meet its internal demands as well as export to the United States and other countries.

Countries other than Brazil lack the land resources, appropriate soils, and climate for large expansion of sugarcane production.²¹ India and China are the second and third largest producers, however, most of the cultivatable land area is already in use and government policies discourage reallocation of arable land for biofuel production. Although Argentina and Columbia have significant underutilized lands available, these resources generally do not have suitable soil and climate characteristics for sugarcane production. Due to these factors, Brazil is the most likely country able to produce substantial volumes of sugarcane for biofuel production in the future.

1.1.2 Cellulosic Biofuel Feedstocks

Various cellulosic feedstocks can potentially be used to produce cellulosic biofuel. These include agricultural residues, forest residues, urban waste, and dedicated energy crops. We describe each type in the following sections.

^B Adapted from CGEE, ABDI, Unicamp, and NIPE, Scaling Up the Ethanol Program in Brazil. Assumed a conversion factor of 20 gallons of ethanol per tonne of sugarcane feedstock to compute gal/acre. A “high” potential refers to ethanol yields that are higher than current industry averages, while “good” refers to good quality land and productivity that is about equal to the current average. Explanations for “Average” and “Inadequate” were not provided.

1.1.2.1 Agricultural Residues

We estimated how much crop residue could potentially be produced, and of that, how much could be removed or harvested to determine the total amount that will be available to produce ethanol in 2022. The amount of residue that can be harvested is limited by how much residue must be left on the field to maintain soil health and by the mechanical efficiency (inefficiency) of the harvesting operation. We discuss harvesting limitations due to maintaining soil health below, while mechanical efficiencies, storage, and transport issues are discussed in section 1.3 of this DRIA. Feedstock costs are discussed in Chapter 4 of the DRIA.

Corn (*Zea mays* L.) and wheat are receiving the most attention across the industry due to their concentrated production areas and because between them they generate about the majority of total residue that's produced. This also means they will more likely be able to support commercial scale production. In aggregate, the other residues provide fairly significant quantities of material, but because they are spread out, e.g., less densely planted both in the field and in a county or state, they are viewed as less likely to support commercial operations. Later, we discuss how these other lower-quantity residue crops may supplement the larger operations.

We analyzed various reports on the availability of agricultural residues. These are summarized in Table 1.1-5. The agricultural residue estimates in Table 1.1-5 are based on historical/recent data, and thus, could be considered conservative in comparison to the future (2022) which would typically have higher crops yields or increases in acres harvested.

Table 1.1-5. Estimated Agricultural Residue Feedstock Availability (per year)^{22,23,24,25,26}

Source	Total Available	Total Sustainably Removable	Crops Analyzed
USDA	> 500 million tons	not specified	Eight leading U.S. crops, e.g. corn, wheat, soy, oats, barley, rice (did not specify other two)
NREL	495 million tons	173 million tons	Corn, wheat, soybeans, cotton, sorghum, barley, oats, rice, rye, canola, beans, peas, peanuts, potatoes, safflower, sunflower, sugarcane, and flaxseed
Gallagher	not specified	156 million tons	Corn, wheat, sorghum, barley, oats, rice
Walsh	not specified	144 million tons at \$40/dry ton, ~150 million tons at >\$40/dry ton for corn; 7 million tons at \$40/dry ton, ~10-11 million tons at >\$40/dry ton for wheat	Corn and wheat
Graham	216 million tons	65 million tons at 30% removal rate and current conditions; 112 million tons at 50% removal rate using no-till conditions	Corn

Based on our FASOM modeling, corn stover was chosen as the most economical agricultural feedstock to be used to produce ethanol in order to meet the 16 Bgal EISA cellulosic biofuel requirement. We estimate that by 2022 greater than 400 million tons of corn stover could be produced. Approximately 82 million tons would be needed to produce 7.8 billion gallons of

cellulosic biofuel that our modeling projects to come from corn stover by 2022.^C See Table 1.1-6. Smaller amounts will be required from sugarcane (bagasse) as well as sweet sorghum pulp to produce another 1.3 billion gallons of cellulosic biofuel.^D Thus, the residue collected to meet EISA would be a small fraction of the total residue produced. See section 1.5.3.4 for more details on the use of agricultural residues for our cellulosic plant siting analysis.

^C Assuming conversion yield of 94 gal/dry ton

^D Bagasse is technically a by-product of the sugarcane process and not an agricultural residue, we include it here for simplification. Sweet sorghum pulp is also a by-product of sweet sorghum processing.

Table 1.1-6.
FASOM Estimated Agricultural Residue Feedstock Availability in 2022 (million tons)^E

State/Region	Barley	Corn	Oats	Rice	Sorghum	Wheat	Total
Alabama	0.0	1.9	0.0	0.0	0.1	0.2	2.2
Arizona	0.1	0.1	0.0	0.0	0.0	0.4	0.7
Arkansas	0.0	2.7	0.0	6.3	1.5	2.8	13.3
California	0.4	1.6	0.1	1.9	0.1	3.1	7.3
Colorado	0.3	5.5	0.0	0.0	0.4	7.7	13.9
Connecticut	0.0	0.0	0.0	0.0	0.0	0.0	0.0
Delaware	0.0	0.2	0.0	0.0	0.0	0.0	0.3
Florida	0.0	0.2	0.0	0.0	0.0	0.0	0.2
Georgia	0.0	5.7	0.1	0.0	0.1	0.3	6.2
Idaho	1.3	0.4	0.0	0.0	0.0	4.5	6.2
Illinois	0.0	70.6	0.0	0.0	0.4	4.1	75.1
Indiana	0.0	34.6	0.0	0.0	0.0	1.8	36.4
Iowa	0.0	79.2	0.4	0.0	0.2	0.1	79.9
Kansas	0.0	16.1	0.0	0.0	7.5	23.2	47.0
Kentucky	0.1	7.5	0.0	0.0	0.1	1.6	9.3
Louisiana	0.0	0.5	0.0	4.0	0.1	0.1	4.8
Maine	0.0	0.1	0.0	0.0	0.0	0.0	0.2
Maryland	0.1	2.0	0.0	0.0	0.0	0.6	2.8
Massachusetts	0.0	0.0	0.0	0.0	0.0	0.0	0.0
Michigan	0.0	9.6	0.1	0.0	0.0	2.6	12.3
Minnesota	0.2	40.3	0.3	0.0	0.0	3.8	44.6
Mississippi	0.0	4.6	0.0	0.7	0.5	1.2	7.0
Missouri	0.0	12.9	0.1	0.4	3.0	2.4	18.8
Montana	1.1	0.0	0.1	0.0	0.0	6.5	7.8
Nebraska	0.0	59.6	0.1	0.0	1.2	6.7	67.5
Nevada	0.0	0.0	0.0	0.0	0.0	0.0	0.1
NewHampshire	0.0	0.0	0.0	0.0	0.0	0.0	0.0
NewJersey	0.0	0.2	0.0	0.0	0.0	0.1	0.3
NewMexico	0.0	0.5	0.0	0.0	0.7	1.6	2.8
NewYork	0.0	2.1	0.3	0.0	0.0	0.5	3.0
NorthCarolina	0.1	4.6	0.1	0.0	0.1	1.5	6.4
NorthDakota	1.8	5.7	0.2	0.0	0.0	14.0	21.7
Ohio	0.0	18.2	0.2	0.0	0.0	4.0	22.4
Oklahoma	0.0	0.3	0.0	0.0	0.8	9.7	10.9
Oregon	0.2	0.2	0.1	0.0	0.0	0.6	1.1
Pennsylvania	0.1	3.2	0.2	0.0	0.0	0.7	4.2
Rhodelsland	0.0	0.0	0.0	0.0	0.0	0.0	0.0
SouthCarolina	0.0	1.1	0.0	0.0	0.0	1.0	2.2
SouthDakota	0.1	17.1	0.2	0.0	0.5	6.8	24.7
Tennessee	0.0	2.7	0.0	0.0	0.1	0.9	3.8
Texas	0.0	15.2	0.1	1.2	5.5	3.5	25.6
Utah	0.1	0.1	0.0	0.0	0.0	1.0	1.2
Vermont	0.0	0.2	0.0	0.0	0.0	0.0	0.2
Virginia	0.1	1.2	0.0	0.0	0.0	0.7	1.9
Washington	1.1	0.8	0.0	0.0	0.0	6.9	8.8
WestVirginia	0.0	0.1	0.0	0.0	0.0	0.0	0.1
Wisconsin	0.0	14.2	0.2	0.0	0.0	1.2	15.7
Wyoming	0.2	0.3	0.0	0.0	0.0	0.4	0.9
Total	7.7	444.4	3.1	14.6	23.1	128.8	621.8

^E Assumes straw to grain ratio for barley and wheat (1.5:1) and for corn, oats, rice, and sorghum (1:1); Also assumes 0.024 ton/bu for barley and oats, 0.028 ton/bu for corn, 0.05 ton/cwt for rice and sorghum, and 0.03 on/bu for wheat.

Soil Health

In terms of soil health, residues perform many positive functions for agricultural soils. Recent studies and reviews have attempted to address these issues. Despite a few shortcomings, existing research can be used to some extent to guide practices or make estimates, especially for corn stover harvest in the Corn Belt, which has been studied more extensively than the other residues except, perhaps, wheat.

In a review by five USDA Agricultural Research Service (ARS) scientists, Wilhelm et al. acknowledged the complexity of interactions between soil type, climate, and management when considering crop residue effects on soil. They recommended that removal rates be based on regional yield, climatic conditions and cultural practices, with no specific rates given.²⁷ Using the Revised Universal Soil Loss Equation (RUSLE) technology and the Wind Erosion Equation (WEQ), Nelson predicted safe residue removal rates for minimizing soil loss in the Eastern and Midwestern U.S. These predictions varied widely over time and location as a result of the complex interactions discussed by Wilhelm et al.^{28,29} In another recent review, sponsored by the U.S. Department of Energy (DOE), Mann et al. concluded that before specific recommendations could be made, more information was needed on the long term effects of residue harvest, including: 1) water quality; 2) soil biota; 3) transformations of different forms of soil organic carbon (SOC); and 4) subsoil SOC dynamics.³⁰ Current USDA Natural Resource Conservation Service (NRCS) practice standards for residue management shy away from specific residue quantities and point to the use of the RUSLE2 model for guidance (without specifics on how to do so).³¹ Despite broad recognition of the need for specific guidelines for residue removal, none yet exist.

With the upsurge in biofuels and the obvious prospects of removing significant quantities of residue, many questions remain regarding the long-term effects on soils of residue removal. Residues haven't yet been removed at the contemplated rates over a period sufficiently long for the effects to be clearly determined. Another difficulty is that while the effects of removing a residue may appear to one observer to have affected the soil in a certain manner, it may not be completely clear that the observed effects were totally related to the residue removal or, were in fact related to a change or to combinations of changes in other variables that were simply missed. A second observer may view the same results in an honest, but different manner. There are so many variables with so many different interactions among them that assigning effects is very difficult at best. There simply are no real-world data available for determining long-term effects. Nevertheless, we can describe some of the interactions that take place and how they can potentially affect soil health.

Soil Erosion

Soil erosion is an extremely important national issue. Most, if not all, agricultural cropland in the United States experiences some degree of soil erosion each year due to rainfall (water) and/or wind forces. Rainfall erosion (sheet and rill) occurs when rain directly strikes the soil, dislodging particles in the top layer.^F When soil becomes saturated, particles are

^F rill: A small intermittent watercourse with steep sides, usually only a few inches deep; www.hancockcoingov.org/surveyor/drainage_glossary_of_terms.asp.

transported down the slope of the field. Soil erosion due to wind occurs in much the same manner as rainfall with wind forces dislodging soil particles and carrying them along and above the field surface (creep and saltation) or suspending them above the field.^G While eroded soil does not disappear, the erosion process moves soil particles to other locations in the field (either downslope or downwind) where they can be transferred into waterways or onto non-croplands.

The amount of soil erosion that agricultural cropland experiences is a function of many factors: field operations (field preparation, tillage, etc.) in preparation for the next crop, timing of field operations, present throughout the year, soil type, field characteristics such as field slope, and the amount of residue (cover) left on the field from harvest until the next crop planting. Crop rotation cover provided by agricultural crop residues, both fallen and standing, helps to minimize rainfall and wind energy as it strikes or blows across the ground as well as helping to keep soil particles from being transported after they have been dislodged. Climatic conditions such as rainfall, wind, temperature, etc. must be accounted for. Studies predict that up to 30% of surface residue can be removed from some no-till systems without increased erosion or runoff.

The NRCS has established tolerable soil loss limits (T values) for all soil types in all counties throughout the United States. The tolerable soil loss values denote the maximum rate of soil erosion that can occur for a particular soil type that does not lead to prolonged soil deterioration and/or loss of productivity. Tolerable soil loss limits take into account the rate of topsoil formation, role of topsoil formation, loss of nutrients, erosion rate at which gully erosion would commence, and potential erosion-control factors that farmers would be able to implement. However, T values are not a function of the type of crop grown.

Soil Tilth

Another important aspect associated with soil conservation involves soil tilth. Soil tilth is defined as the physical condition of the soil as related to its ease of tillage, fitness as a seed bed, impedance to seedling emergence and root penetration, and all other physical conditions that influence crop development. Tilth depends upon soil granulation and its stability (soil workability) as well as organic matter content, moisture content, porosity, water retention, degree of aeration, rate of water infiltration, drainage, and capillary-water capacity, all of which are affected by crop residue removal. Preliminary values of required tilth have been estimated by the NRCS.

Tillage

Various tillage operations are associated with management of agricultural crop residues and planting preparation throughout the year. Type and number of tillage operations employed for any particular crop from the time of harvest until the next planting have a tremendous effect on the amount of soil lost to erosion during the year, and hence, the amount of residue that can possibly be removed for energy purposes. It must be noted that even though crop residues may be used for energy purposes, the farmer is, first and foremost, in the business of producing grain. Therefore, he will be concerned with using those tillage operations that will provide him with the

^G saltation: the movement of sand-sized particles by a skipping and bouncing action in the direction the wind is blowing uizlet.com/print/10948/

highest possible yield at the next harvest, and not necessarily those that tend to maximize erosion control on his lands.³²

In summary, all agricultural cropland upon which nearly any crop is grown within a particular county can exhibit a wide variation in soil erodibility, field slope and length, climate conditions, and management practices. Within any one particular county there can be many different soil types (50 or more) used to grow agricultural crops. In addition, and possibly more importantly, not all soil types within a county may be suitable for agricultural crop production. Some soils possess characteristics that make them highly susceptible to erosion that may not be able to sustain certain cropping practices. Production of conventional agricultural crops on these lands may severely and/or permanently reduce the soil's ability to provide sustained, economical production. For this reason, the NRCS implemented a land capability classification (LCC) that ranges from I (one) to VIII (eight) that is applied to all soils within a county.

Organic Matter, Carbon, and Nutrients

With added nitrogen fertilizers, residues can increase soil organic matter (SOM). However, roots appear to be the largest contributor to new SOM, making residues less important for carbon accrual. Residue removal leading to higher erosion and runoff rates would greatly decrease SOM and nutrients. Residue harvest would also require increased fertilizer inputs to make up for nutrients removed in the plant material. When returned to the land, crop residue also replenishes soil organic carbon (SOC) that typically has already been reduced 30 to 50% of precultivation levels through crop production activities. Soil organic carbon retains and recycles nutrients, improves soil structure, enhances water exchange characteristics and aeration, and sustains microbial life within the soil. It's been reported that crop yield and the value of environmental services (C and N sequestration) were greater for soils with greater SOC. Limited research has shown that removing stover reduces grain and stover yield of subsequent crops and further lowers soil organic matter levels.³³

Beneficial and Deleterious Soil Organisms

Residue removal can result in detrimental changes in many biological soil quality indicators including soil carbon, microbial activity, fungal biomass and earthworm populations, indicating reduced soil function. Some disease-producing organisms are enhanced by residue removal, others by residue retention, depending on crop and region.

Available Water and Drought Resistance

Residue cover can reduce evaporation from the soil surface, thereby conserving moisture and increasing the number of days a crop can survive in drought conditions. Improved soil physical properties related to crop residues, such as reduced bulk density, e.g., the soil is looser and lighter, and greater aggregate stability, also lead to better water infiltration and retention.

Soil Temperature and Crop Yield

In colder climates, residues are linked to reduced yields due to lower soil temperatures resulting in poor germination. Stubble mulching, as opposed to residue chopping, can help overcome this problem. Even though residue-associated yield reductions have been found on poorly drained, fine-textured soils, these soils often have low erosion risk and residues might safely be removed.

Summary

Despite the many important benefits of crop residues, research shows their effects can vary. For instance, some reports showed lower yields in systems with high crop residues due to increased disease or poor germination; others reported higher yields when soil moisture is limiting. Other studies suggest that residues do not contribute significantly to soil carbon. Many studies found that additional N fertilizer is needed when residues are left on soils to avoid N uptake (immobilization) from soil or allow for soil carbon accrual. For appropriate residue removal recommendations, the conditions leading to these varied effects of residues must be elucidated.

Soil health as related to residue removal is an extremely complex issue for which, as yet, there are no specific guidelines for residue removal. Wrong decisions, carried out over extended periods could have far reaching deleterious effects. Sustainable residue removal rates for biofuel production vary by system, according to such factors as management and cropping practice, crop yield, climate, topography, soil type and existing soil quality. Keeping in mind that gravimetric rates are not the same as percent soil cover (% mass is not the same as % coverage), appropriate conversion is necessary and varies by crop and region. While areas with low slopes and high yields may support residue harvest, in many areas the residue amounts required to maintain soil quality could be even higher than current practices. What is meant by ‘high’ and ‘low’ slopes has yet to be absolutely determined, which determination also depends on soil type and other cropping practices. Removal rates will need to be reduced as climates become warmer or more humid, for lower C:N residue or lower yielding crops, as soil disturbance (e.g. tillage) increases, or as soils become coarser textured, compared to the conditions in which most studies occurred (in the U.S. Midwest Corn Belt for no-till corn).³⁴ The most important aspect of this is that any or all of the interacting variables that determine how much residue can be removed, can, and usually do, change from year-to-year, across both wide regions of the country as well as across single counties and farms. A change in one variable nearly always changes how all the variables interact.

Given all the issues we’ve discussed regarding residue removal and soil health, rather than try to predict, county-by-county how much residue will be available, we assumed in our FASOM modeling that the available amount will be somewhere between 0% and 50%, at least until the issues we’ve been discussing are settled. We based the amount removable based on the tillage practice: 0% removed for conventional tillage, 35% removed for conservational tillage, and 50% removed for no-till for corn stover.³⁵ Removal rates for wheat straw were based on the billion-ton study.³⁶ We believe that given the uncertainties in removal rates, our assumptions are reasonable.

1.1.2.2 Forest Residues

There is a substantial amount of forestland here in the U.S. It is estimated that 749 million acres, or one-third, of the U.S. land area is forested. Of this forested land, two-thirds (504 million acres) is considered timberland which contains more than 20 ft³ of woody material per acre – the other one-third of the forest land contains less than 20 ft³ of woody material per acre. Most of this forested land, 58 percent, is privately owned, another 29 percent of the forest land is publicly owned, and 13 percent is owned by the forest industry. A higher percentage of the land is privately owned in the East, and a higher percentage of the land is publicly owned in the West.

Of the 749 million acres of forestland, 77 are reserved as parks or wilderness and would likely be considered off limits for harvesting for biomass. Also, 168 million acres of timberland is believed to be not suitable for harvesting for biomass because of poor soil, lack of moisture, high elevation, or rockiness.³⁷

The U.S. forestry industry harvests a portion of this forest land to produce its products, and in the process of doing so, it generates woody residues that can be recovered for the purpose of producing cellulosic biofuels. Major sources of solid waste wood generated in the U.S. include forestry residues, primary and secondary mill residues, and urban wood residues. In addition, forests which are not currently harvested for wood could be thinned. This thinning of the forests would not just be to provide biomass, but as part of a strategy which may be beneficial for the forests, or to avoid external costs such as forest fires. Each of these categories is further described below:

Forestry residues

In-forest operations generally include four major sources of materials: logging residues, other removals, fuelwood, and fuel treatment wood.³⁸ In the process of removing, or logging, the larger woody portion of the trees (5 inch diameter and greater), the logging industry creates logging residues. Logging residues typically include tops of harvested trees and unwanted trees cut or knocked down and left on site, including dead and cull trees. Other removals are growing stock and other sources cut and burned or otherwise destroyed in the process of converting forest land to non-forest uses, such as for making way for new housing or industrial developments. They also include growing stock removed in forestry cultural operations. Forest residues are also available from fuelwood, which is harvested wood used in the residential and industrial sectors for energy. Thus, forest residues are already being created or harvested today.

Primary and secondary mill residues

Harvested wood from forests is converted into consumer products at wood processing mills. Primary mills convert roundwood products (i.e., tree trunks and logs) into other wood products, including sawmills that produce lumber, pulp mills, veneer mills, etc. Secondary mills use the products from primary mills to produce other products such as millwork, containers and pallets, buildings and mobile homes, furniture, flooring and paper and paper products. While primary and secondary mills are typically separate facilities, both primary wood processing and secondary conversion to finished consumer products can occur in the same facility.³⁹

Both primary and secondary mills produce residue and waste woody material. For example, the residue generated by primary mills includes bark, slabs and edgings, sawdust and peeler cares. This waste material could be used as feedstock to produce biofuels.

Urban wood residues

The two principal sources of urban wood residues are municipal solid waste (MSW) and construction and demolition (C&D) debris. Municipal solid waste contains solid wood from both wastewood and yard trimmings. Yard trimmings include herbaceous material and woody trimmings. Information on the composition of MSW is limited. However, it has been assumed in one report that approximately two thirds of the total volume consists of woody material.⁴⁰ Construction waste is made of contemporary building materials with little contamination. Sources include new residential construction, new nonresidential building construction and repair and remodeling of existing buildings. Demolition waste, on the other hand, is a heterogeneous mixture of material from demolishing buildings and structures and is difficult to separate as it is often contaminated. The potential contribution of urban wood residues to the production of biofuels will be addressed in the section 1.1.2.3 of this DRIA.

The Thinning of Forests

While the above categories are associated with existing forest harvesting or other removal activities, the thinning of forests would largely be a new activity. Many U.S. forests have become overgrown and very dense with forest material, and a portion of this overgrown forest will die, dry out and decay. This decaying forest material can provide a source of fuel for forest fires that are expensive to fight or contain. Over the previous 10 years forest fires have consumed 49 million acres and cost the U.S. taxpayer \$8.2 billion.⁴¹ This cost does not include the additional cost due to the loss of human life, the loss of personal property and the impact on the environment. Thinning forests involves the removal of excess forest material from the forests that could help to prevent some of these forest fires, or at least help to reduce their impact. Also, thinning these forests to prevent them from becoming overly dense could potentially help them to remain healthier. There are many thinning operations today, but the material is burned or left to decompose instead. The removed excess woody material from overgrown forests could provide a source of biomass for producing biofuels.

Despite the availability of woody residues for producing cellulosic biofuels, there are several obstacles for woody residues that are not present when utilizing feedstocks such as agricultural residues. For instance, forestlands will likely be managed less intensively than agricultural lands because forests provide multiple-use benefits (e.g., wildlife habitat, recreation, and ecological and environmental services).⁴² This in effect makes it more difficult to take steps to increase the productivity of forest areas. Also, there are factors or site conditions that can affect tree growth, including poor soils, lack of moisture, high elevation, and rockiness. The limits caused by some of these factors would likely not be overcome, resulting in lower productivity than what could be theoretically possible. Also, a couple of these factors, the high elevation and rockiness, results in areas of forestland which is inaccessible by forestry equipment. Forestry residues are also demanded for other purposes other than for production of

a transportation fuel (e.g. for process fuel). These reasons would make it more challenging to collect and use woody residues in large quantities compared to agricultural residues.

On the other hand, there may be some benefits to the use of woody residues. One example is the removal of excess forestry biomass to reduce the risk of fires and/or to improve forest health. In addition, resources such as primary and secondary mill residues and urban wood residues are already collected at the processing facility and it seems probable that some cellulosic facilities could be co-located to mills and/or landfills to increase the likelihood of having close and steady feedstocks readily available. Some states may also be endowed with larger wood resources than agricultural residues.

The following sections further describe some of the additional factors to consider when determining the potential availability of woody feedstocks.

Harvest, Transport, and Storage

The largest portion of woody material to produce biofuels is available as forestry residues. However, unlike residues such as primary or secondary mill residues and urban wood residues that could be available on-site at a processing facility, forestry residues would need to be collected and transported similarly to conventional forest products. The amount of residues potentially available is a function of harvest amount, logging method, and type and location of timberlands.⁴³ In addition, residue availability is limited by economic factors. According to one study, “the actual operations of harvesting, collecting, processing and transporting loose forest residues are costly and present an economic barrier to recovery and utilization of wood for energy”.⁴⁴ Thus, there are still challenges that need to be addressed before large-scale use of forestry residues is possible.

Currently, the most cost-effective method of recovering forest residue for biomass is in-woods chipping.⁴⁵ This method is suitable for operations where there is whole-tree skidding to roadside, good road access to chip vans and chippers, and sufficient biomass volume per acre. However, in-woods chipping systems are not as effective when ground-based skidding is restricted or when there are no merchantable products other than biomass. In addition, the chip vans designed to haul wood chips were built for highway use and often do not have sufficient suspension systems for remote forest roads. There are also high costs for wood grinders with low production rates.⁴⁶ Fortunately, there have been developments in alternative methods to reduce the costs of biomass collection systems.

Much of the focus has been on developing methods of densifying residues in order to increase productivity of handling operations (i.e. hauling, skidding, and loading). New approaches to removing forestry residues are currently being evaluated (e.g. slash bundling machines, horizontal grinders, and roll on/off container transport). One of the advantages of using slash bundling machines, for example, is the ability to store biomass longer than in chip form. Storing biomass at roadside in the form of biomass bundles could provide a more secure and stable biomass supply than with chips which are smaller and have greater surface area for potential weathering. The use of horizontal grinders was also found to be the best at reducing

bundles. Utilizing roll on/off containers allows for recovery of residue from difficult-to-access locations and in such situations could be competitive with regular highway chip vans.

While these are just some of the ways to improve recovery operations for forestry residues, these methods still have challenges. For example, there are some difficulties with bundling of brittle residues or short, large diameter pieces. In addition, some residues may include rocks or trash that can result in additional saw maintenance and reduced utilization. With millions of acres of forest, there is no single residue treatment option that will meet the needs of all situations. Forest land managers will need to weigh the different options for dealing with forest residues to determine the most cost-effective means for residue removal in their specific locations.

In making estimates of potential forest residue availability, certain assumptions about accessibility and recoverability are typically made. For example, some studies assume that residue collection is completed at the same time as harvesting, meaning that all residues are regarded as one hundred percent accessible.⁴⁷ This might become possible due to integrated harvesting systems which could harvest forest biomass in a single pass operation such that residual forest residue for producing biofuels could be produced along with conventional forest products.⁴⁸ Other estimates for accessibility have been lower, with about sixty percent of North American temperate forest considered accessible (not reserved or high-elevation and within 15 miles of major transportation infrastructure).⁴⁹ In terms of recoverability, some studies have assumed sixty-five percent of logging residues and fifty percent of other removal residues as being recoverable while others report an average potential recovery of sixty percent and as much as sixty-five percent when utilizing newer technology.⁵⁰

Sustainable Removal

While there has been some discussion of sustainable removal practices for crop residues, there has been less review on the topic for woody residues. As forest residues have been traditionally left in the forest to decompose, there remains much to be learned about the harvesting of forest residues in a sustainable way that still leaves sufficient nutrients to maintain the forest and to replenish the soil. This is reiterated in reports on woody residue removal which emphasize the need for more detailed studies on the range of ecological effects, from wildlife to soils.

Currently, practices for how much forest residue shall be maintained in the forest to maintain forest health vary substantially. For example, a district for one study on the removal of forestry residues required about 5 tons per acre be left whereas other districts had no such requirements.⁵¹ In a different source, a summary of national forest land management plans from 1995 indicated about 60 percent of western national forest timberland base to be suitable for timber production operations.⁵² This issue is not only applicable in the United States, but also in Europe, where the use of forest biomass for energy is also being considered. A Swedish study showed that the main incentive for forest owners not to sell forestry residues was concerns for soil fertility.⁵³ Therefore, although there have been limitations to the amount of residue suitable for removal there has yet to be consensus over the optimal amount.

Yet another issue regarding sustainable removal is the affect of forest residue extraction on biodiversity. The removal of forest residue may affect biodiversity because lower amounts of wood in the forest imply fewer habitats for species using wood for breeding. Species may also be threatened because certain insects colonize in wood that may be burned for energy purposes. Quantitative predictions about how much habitat loss various species can tolerate are almost impossible to make. Instead, one study recommended making qualitative predictions on which types of habitats or wood types are most threatened. For instance, this study examined Sweden’s forest fuel extractions and concluded that coniferous wood can be harvested to a rather large extent, whereas deciduous tree species should be retained to a larger degree.⁵⁴ As different regions will certainly have species specific to their own regions, more research is necessary to determine appropriate recommendations on maintaining biodiversity.

Another issue that has been considered is the occurrence of soil disturbance due to the use of forest residue collection equipment. Studies have shown that the growth of woody plants and yields of harvestable plant products are decreased by soil compaction from residue collection equipment, because of the combined effects of high soil strength, decreased infiltration of water and poor soil aeration.⁵⁵ In another study, the use of a residue bundling machine caused some measurable amounts of soil disturbance and an increase in “soil exposed” area at some locations.⁵⁶ Thus, it is important to limit the severity of soil disturbances with minimal passes and relatively low ground pressure.

Energy Content of Forest Residue and Biofuel

Woody material obtained by the harvesting or thinning of forest is somewhat more energy dense compared to other forms of biomass. On its Biomass Program webpage, the Department of Energy lists the higher heating values (lower heating values were not available) for many different types of biomass for dry samples.⁵⁷ These values for woody biomass are summarized in Table 1.1-7.

Table 1.1-7. Energy Content of Forest Material

Tree name	Higher Heating Value (BTU/lb dry wood)
Hybrid Poplar	8,384 - 8,491
Black Locust	8,409 - 8,582
Eucalyptus	8,384 - 8,432
American Sycamore	8,354 - 8,481
Eastern Cottonwood	8,431
Monterey Pine	8,422

Because woody material is energy dense, it can produce a large amount of renewable fuels per ton of feedstock. Based on the data in FASOM, we assumed that 89 gallons of ethanol could be produced per each ton of dry (15 percent moisture) woody feedstock in 2022.

Quantity of Forest Residue

The quantity of forest residue available to produce biofuels was estimated by two different studies. We summarize those two studies, and then summarize data which we received directly from the U.S. Forest Service

Billion Ton Study

A landmark assessment of the potential biomass available from existing forest land in the U.S. was recently conducted by the USDA and the Department of Energy (DOE).⁵⁸ This landmark assessment was titled “Biomass as Feedstock for a Bioenergy and Bioproducts Industry: The Technical Feasibility of a Billion Ton Supply,” which is also known as the Billion Ton Study. We reviewed this study and are summarizing much of the information contained in that report here because it is very useful background about U.S. forest land and its potential contribution to biofuels.

The total forest inventory is estimated to be about 20.2 billion dry tons. The report authors estimated that about 2.2 percent of the total forest inventory is harvested each year, which corresponds to 444 million dry tons. This removal rate is estimated to be less than the annual average forest growth, which suggests, at least on an aggregate basis, that this removal rate is sustainable. It is estimated that 78 percent of this removal was for roundwood products (sawlogs, pulpwood, veneer logs and fuel wood), 16 percent was logging residue and about 6 percent was classified as other removals. Thus, the Billion Ton study authors estimate that 67 million dry tons of logging residue would potentially be available for biofuel production, which is comprised of 49 million dry tons of primary logging residue, and 18 million dry tons of other removals. The Billion Ton study estimates that 65 percent of the total logging and other residue would be recovered for use. The two reasons cited for not collecting the other 35 percent is that some of the logging residue is comprised of small pieces, such as small branches and leaves, which would not be economically recoverable, and that it would be necessary leave behind a portion of the logging residue would be to protect the sustainability of the forest as well as the wildlife which thrives in the forest. For these reasons, the Billion Ton Study authors estimated that 41 million dry tons of forest residue could be sustainably removed from the U.S. forests as byproduct from existing logging operations. Virtually all this removal is from privately owned land where the logging operations occur today.

Additional forest residue is available downstream of the logging operations at mills. In the process of making their products, primary wood processing mills create some waste or residue. However, almost all of this waste wood is recovered or burned for process heat. For example, the bark from the logged wood is burned as fuel or converted into mulch. However, the Billion Ton authors estimated that just under 2 million dry tons per year of residue would be available from the primary wood processing mills as feedstock for producing biofuels.

The Billion Ton study estimates that additional wood waste could also be available from secondary wood processing mills, which refine crude wood into more refined products. The report authors could not find any data on how much residue is produced by these secondary wood processing mills, however, a study of these facilities did provide an estimate.

Approximately 15.6 million dry tons per year would be available from the smaller of these secondary wood processing mills, however, the report estimated that only 40 percent, or 6 million dry tons per year, would be available for biofuels production.

Another industry which processes the harvested wood is the pulp and paper mills. These companies process wood into fiber to make paper and cardboard. Most of the pulp and paper mills use the Kraft process or sulfate pulping process which converts half of the woody material into fiber, while the other half is a byproduct termed black liquor. The black liquor contains a substantial amount of biomass. The pulp and paper industry is already using all of this black liquor, plus purchasing and using some fossil fuels, to generate the electricity and heat that it needs for its plants. Therefore, the authors of the Billion Ton Study estimated that there would not be any residue available from the pulp and paper industry to produce biofuels.

The Billion Ton study estimates that another potential source of biomass from forests would be the selective thinning of forests to help reduce the risk of fire, or to facilitate the fighting of fires in the case that fires break out (as discussed above). Using a forest evaluation tool called the Fuel Treatment Evaluator, the Forest Service has estimated tree densities for forests all across the U.S. and has identified forests which contain excess woody material. The forests which contain excess woody material are candidates for providing additional biomass for producing biofuels. The Forest Service has estimated that the total amount of excess woody material to be 8.4 billion dry tons.

The Forest Service next estimated the portion of this excess woody material that could be harvested for biofuels production. Despite the fact that this inventory exists today, the Billion Ton Study authors assumed that this excess woody inventory would be used over a 30 year period to reflect a sustainable removal rate. This assumption reduces the total yearly available amount of excess woody biomass to 280 million dry tons per year. Another limiting factor is that much of our nations forest is remote, thus, only 60 percent of this excess woody material was estimated to be removable for use. The next assumption made is that the best of this woody material, which is the woody material more than 5 inches in diameter and which comprises 70 percent of this material, would be used for feedstock for the logging industry. Thus, the remaining 30 percent would be residue that would serve as feedstock for the biofuels industry. Finally, the last assumption made is that of the excess woody material harvested, 15 percent would be lost between harvesting and use, thus the total amount of woody biomass was adjusted to be 15 percent lower. These assumptions result in 18 million dry tons of additional woody biomass that could be used to supply the biofuels industry annually, and 42 million dry tons that would supply the logging industry.

As shown below in Table 1.1-8, the Billion Ton Study estimates that a total of 67 million dry tonnes per year would be available from non-urban forests.

**Table 1.1-8.
Quantity of Forest Biomass Available for Producing Biofuels**

	Quantity (million dry tons)
Logging Residue	41
Primary Mill Residue	2
Secondary Mill Residue	6
Forest Thinnings	18
Total	67

The Billion Ton Study authors projected that forest harvesting and mill activity will increase in the future, thus increasing the amount of forest residues that would be available for producing biofuels. The authors estimated the future forest residue supply in the year 2050 and concluded that the logging residue is expected to increase from 41 million dry tons to 64 million dry tons. Also in 2050, the primary and secondary mill residue quantity is projected to increase from a total of 8 million dry tons per year to a total of 24 million dry tons per year. No estimate was provided for any increase, or decrease, in the amount of forest woody material that would be available from thinning forests. If the projected 39 million dry ton increases in forest residue comes to fruition, then the total amount of forest residue that would be available for producing biofuels in 2050 would be 106 million dry tons per year. We are primarily interested in compliance with the RFS2 biofuels standard in 2022, which is just over 1/3rd of the way between today and 2050. Thus, by interpolating the projected future forest residue in 2022 relative to current levels and those in 2050, the report supports the conclusion that 79 million dry tons of forest residue would be available in 2022 .

U.S. Cellulosic Biomass Study

Another estimate for the amount of forest residue that could be used to produce biofuels was made by Marie Walsh, formerly of the Oak Ridge National Laboratory (ORNL).⁵⁹ The report was titled “US Cellulosic Biomass Supplies and Distribution” and it is dated January of 2008. This report also uses the Forest Service data base for its estimates, so its conclusions resemble those of the Billion Ton study. However, an important difference between this Cellulosic Biomass Study and the Billion Ton Study is that Marie Walsh estimated a cost curve for amount of biomass available for her Cellulosic Biomass study for multiple future years.

In this report, Marie Walsh estimates that 63 million dry tons of logging residue is created in the lower 48 states. Of this total amount of logging residue, 65 percent is estimated to be accessible by roads, and not all the accessible logging residue is considered recoverable because some of it is too small to recover. This study also estimates the cost for recovering this available logging residue for future years for five year intervals through 2030. The amount of logging residue available at different price points and for different years is summarized in Table 1.1-9.

Table 1.1-9. Quantity of Logging Residue Available at Varying Prices

	\$20/dt	\$25/dt	\$30/dt	\$35/dt	\$40/dt	\$45/dt	\$50/dt	\$75/dt	\$100/dt
2007	0.06	1.84	6.22	10.89	24.02	31.29	31.29	36.19	38.50
2010	0.065	1.81	6.41	13.23	29.37	38.70	38.70	45.02	47.89
2015	0.065	1.95	6.80	13.62	29.99	39.35	39.35	45.71	48.60
2020	0.067	2.10	7.22	14.41	31.51	41.20	41.20	47.79	50.77
2025	0.067	2.17	7.46	14.81	32.32	42.19	42.19	48.90	51.95
2030	0.068	2.25	7.70	15.22	33.12	43.17	43.17	50.01	53.13

Marie Walsh also identified the quantity of woody material that would be available at specific prices from other removal supplies – trees removed to make way for the construction of buildings. Marie Walsh estimates that a total of approximately 24 million dry tons of forest residue falls within this category. She estimated that perhaps 50 percent of this material would be available for biofuel production. Marie Walsh added the other removal supplies to the logging residue and estimated their availability at different price points, increasing the available biomass by 25 percent. The combined total is summarized in Table 1.1-10.

**Table 1.1-10.
Quantity of Forest Residue and Other Removals Available at Varying Prices**

	\$20/dt	\$25/dt	\$30/dt	\$35/dt	\$40/dt	\$45/dt	\$50/dt	\$75/dt	\$100/dt
2007	0.09	2.63	10.49	15.16	32.16	41.62	41.62	47.71	50.49
2010	0.09	2.63	10.76	17.59	38.08	49.17	49.17	56.68	60.03
2015	0.09	2.79	11.26	18.08	38.87	50.00	50.00	57.56	60.93
2020	0.09	2.96	11.80	19.00	40.58	52.04	52.04	59.84	63.31
2025	0.10	3.07	12.15	19.50	41.56	53.21	53.21	61.15	64.68
2030	0.10	3.17	12.51	30.02	42.55	54.39	54.39	62.47	66.07

This report also estimates the amount of primary and secondary mill residues available for biofuels production. Like the Billion Ton study, Marie Walsh also concludes that only a very small amount of primary mill residue is estimated to be currently unused and available for producing biofuels. She concludes that out of the 88.7 million dry tons of primary mill residue which are generated, that only 1.3 million dry tons is not used for fuel, fiber or other sources as discussed above. However, she provides an additional assessment that, at the right price, the primary mill residue could be drawn away from these other users of the primary mill residue. The assumption is that for fiber uses, the primary mill residue could be drawn away from the current users at 35% of the product price. For other uses, including for fuel, it is assumed that at 65% of the market price of the raw wood value, the primary mill residue could be purchased away from the current users. Table 1.1-11 below estimates the price that specific estimated primary mill residue volumes could be available for producing biofuels.

**Table 1.1-11.
Quantity of Primary Mill Residue is Available at Varying Prices**

	\$20/dt	\$25/dt	\$30/dt	\$35/dt	\$40/dt	\$45/dt	\$50/dt	\$75/dt	\$100/dt
2007	0.43	4.93	6.03	19.34	20.14	41.46	42.38	50.31	51.04
2010	0.55	5.70	7.29	21.91	22.80	46.03	47.37	56.29	57.33
2015	0.56	5.93	7.51	22.88	23.77	48.00	49.34	58.55	59.61
2020	0.58	6.16	7.74	23.85	24.73	49.97	51.31	60.82	61.88
2025	0.59	6.34	7.93	24.58	25.47	51.46	52.82	62.55	63.61
2030	0.60	6.52	8.12	25.31	26.20	52.96	54.31	64.28	65.35

The author also attempted to estimate the amount of secondary mill residue that could be available for producing biofuels. She observed that data is scant on the amount of secondary mill residue. She referenced a study (Rooney, 1998) that estimated that only a very small volume of secondary mill residue would be available for producing biofuels. Of 12.5 million dry tons of secondary mill residue which is generated, only 1.2 million dry tons is available for producing biofuels. Unlike the analysis conducted for primary mill residue, the author did not attempt to estimate the extent that biofuels producers could bid the secondary mill residue away from the current users.

Marie Walsh also assumes that three very difficult-to-quantify sources of forest material could be available as biomass for producing biofuels. One of these potential sources is the forest material that could be available through the thinning of overgrown forests to help reduce the fire risk within these forests. Marie Walsh referenced one study which estimated that 100 to 200 million acres of overgrown forest could be harvested. No estimate, however, was provided for the amount of this forest material that could be available from forest thinning.

Another potential source of forest material for biofuel production that the study discussed is a portion of the estimated 35.4 million tons of fuel wood used to heat homes and to provide heat for industries. The author cited a report which estimated that fuel wood use decreased from 1986 to 2000, but began to increase again and is expected to increase through 2050. This presumably means that if the demand for fuel wood is lower than previously, that some of that fuel wood could be available for producing biofuels. However, in this report, Marie Walsh did not make any firm estimate for this.

The Marie Walsh report also discussed that forest pulpwood supply is exceeding demand in the Southeast. The demand of forest pulpwood decreased from 131 to 121 million tons per year from 1993 to 2003, and this demand is expected to further decrease through 2020, and some have projected that this decrease in demand will continue beyond 2020. During the period between 1993 and 2003, pulpwood acreage and management intensity have increased, which suggests that the Southeast is and will continue to be over supplied. This oversupply of forest pulpwood could potentially provide additional biomass to the biofuels industry, although she did not provide any firm estimate for this.

While both of these studies provide quality assessments for the total amount of forest residue available for producing biomass, they both have an important limitation as well. The

limitation is that these reports did not assess whether the forest residue in any particular area, along with other potential biomass, is of sufficient density to adequately supply a potential cellulosic biofuel plant. This feedstock density assessment must also consider the feedstock availability requirements made by cellulosic plant investors or banks, which may choose to require that a certain excess amount of feedstock be available to justify the use of that biomass in a cellulosic ethanol plant. Without considering these limitations, these studies may overestimate the quantity of biomass that would be truly usable and also the ultimate amount of biofuel that could be produced.

U.S. Forest Service Data

To assess forest residue supply within the feedstock density and supply constraints, we obtained county-by-county forest residue data from the U.S. Forest Service.⁶⁰ The information was provided by the subcategories of logging residue, primary mill residue, timberland thinnings, and other removals. The information also included urban forest residue, however, because that material is included with the other MSW, we did not consider it here. Like the studies discussed above, the national forest lands are omitted from consideration, and the urban forest residue is not considered here, but in the section discussing MSW. The information was also provided at different price points. The quantities of forest residues are summarized by source type in Tables 1.1-12, 1.1-13 and 1.1-14. To avoid presenting a huge amount of data, we aggregated the county data by state, and we are presenting the data at specific price points: \$30/dry ton, \$45/dry ton and \$70/dry ton.

**Table 1.1-12.
Volume of Forest Residue Available for Producing Biofuel
Biomass Available at \$30/ton**

	Logging Residue	Other Removals	Timberland Thinnings	Primary Mill Residue	Total Quantity
Alabama	2,405,083	507,240	867,038	7,117	3,786,478
Arizona	17,698	44,871	66,171	1,351	130,091
Arkansas	1,703,543	770,985	738,165	12,889	3,225,582
California	669,740	0	1,742,702	65,088	2,477,530
Colorado	18,405	14	0	2,302	20,721
Connecticut	8,391	30,678	20,929	3,949	63,948
Delaware	30,101	24,218	9,835	0	64,155
Florida	1,070,430	515,407	481,893	2,202	2,069,932
Georgia	3,113,907	993,262	1,107,254	45,138	5,259,561
Idaho	253,145	0	83,095	6,006	342,247
Illinois	278,202	235,178	230,863	18,523	762,766
Indiana	562,483	104,173	396,225	10,627	1,073,508
Iowa	112,098	55,160	97,983	159	265,400
Kansas	14,658	88,405	19,353	8,720	131,136
Kentucky	1,027,977	664,358	689,896	55,196	2,437,427
Louisiana	2,634,279	880,585	601,848	30,075	4,146,788
Maine	2,412,877	940	160,628	42,483	2,616,927
Maryland	181,443	830	81,988	17,067	281,327
Massachusetts	70,921	62,087	27,602	0	160,610
Michigan	758,926	244,952	655,280	13,763	1,672,922
Minnesota	697,614	662,985	265,424	26,878	1,652,900
Mississippi	3,097,069	710,142	850,688	95,138	4,753,038
Missouri	774,868	530,292	684,154	79,787	2,069,100
Montana	262,670	0	133,185	9,136	404,990
Nebraska	21,145	18,771	23,414	4,971	68,302
Nevada	29	105	0	0	134
New Hampshire	314,642	348	95,604	7,019	417,613
New Jersey	5,918	77	4,847	1,437	12,279
New Mexico	23,858	2,557	51,796	4,902	83,113
New York	734,006	109,342	326,672	27,390	1,197,410
North Carolina	2,026,330	1,259,265	1,121,627	12,811	4,420,033
North Dakota	2,906	15,202	7,644	265	26,017
Ohio	370,795	18,106	167,351	22,600	578,853
Oklahoma	347,738	197,587	106,086	495	651,906
Oregon	1,520,552	63	1,055,405	16,316	2,592,335
Pennsylvania	1,087,327	1,372	449,956	170,972	1,709,626
Rhode Island	1,769	45,721	5,600	389	53,478
South Carolina	1,429,102	696,577	603,700	1,051	2,730,431
South Dakota	13,944	28,873	5,986	2,294	51,096
Tennessee	633,412	489,840	847,812	187,583	2,158,647
Texas	1,233,553	436,927	371,437	3,021	2,044,938
Utah	5,946	0	19,817	4,437	30,200
Vermont	209,752	37,304	96,790	0	343,845
Virginia	1,483,346	813,600	873,740	39,366	3,210,052
Washington	1,282,288	44	1,850,958	21,446	3,154,736
West Virginia	976,712	49,428	323,306	118,779	1,468,225
Wisconsin	1,137,600	982,264	520,587	60,410	2,700,862
Wyoming	22,685	0	28,100	34,014	84,799
Total	37,061,885	12,330,137	18,970,435	1,295,560	69,658,018

**Table 1.1-13.
Tons of Forest Residue Available for Producing Biofuel
Biomass Available at \$45/ton**

	Logging Residue	Other Removals	Timberland Thinnings	Primary Mill Residue	Total Quantity
Alabama	2,405,083	507,240	1,012,090	7,117	3,931,530
Arizona	27,131	49,020	69,934	1,351	147,436
Arkansas	1,703,543	770,985	858,827	12,889	3,346,244
California	1,166,955	0	1,898,937	65,088	3,130,980
Colorado	20,112	22	61,238	2,302	83,674
Connecticut	8,601	32,190	20,929	3,949	65,670
Delaware	35,863	28,290	13,400	0	77,554
Florida	1,070,430	515,407	533,194	2,202	2,121,234
Georgia	3,113,907	993,262	1,288,591	45,138	5,440,898
Idaho	432,605	0	105,188	6,006	543,799
Illinois	278,305	235,178	230,863	18,523	762,869
Indiana	562,928	104,173	443,691	10,627	1,121,419
Iowa	112,100	55,215	99,102	159	266,576
Kansas	14,658	88,405	19,353	8,720	131,136
Kentucky	1,027,977	664,358	814,743	55,196	2,562,273
Louisiana	2,634,279	880,585	661,023	30,075	4,205,963
Maine	2,561,023	989	204,885	42,483	2,809,379
Maryland	189,159	842	81,988	17,067	289,054
Massachusetts	78,254	66,382	27,602	0	172,239
Michigan	783,465	257,201	820,603	13,763	1,875,033
Minnesota	717,037	683,787	319,980	26,878	1,747,683
Mississippi	3,097,069	710,142	935,870	95,138	4,838,219
Missouri	774,868	530,292	932,163	79,787	2,317,110
Montana	431,194	0	141,549	9,136	581,879
Nebraska	21,419	18,867	23,414	4,971	68,672
Nevada	44	142	0	0	186
New Hampshire	331,037	395	115,132	7,019	453,583
New Jersey	6,368	79	4,847	1,437	12,731
New Mexico	34,478	2,575	53,724	4,902	95,679
New York	768,914	113,104	379,391	27,390	1,288,799
North Carolina	2,026,330	1,259,265	1,336,840	12,811	4,635,245
North Dakota	2,907	15,202	7,644	265	26,018
Ohio	372,045	18,139	177,144	22,600	589,927
Oklahoma	347,738	197,587	125,400	495	671,220
Oregon	2,502,187	68	1,095,253	16,316	3,613,824
Pennsylvania	1,092,836	1,386	604,355	170,972	1,869,549
Rhode Island	1,913	50,079	5,600	389	57,981
South Carolina	1,429,102	696,577	704,036	1,051	2,830,767
South Dakota	23,743	31,161	6,505	2,294	63,704
Tennessee	633,412	489,840	1,015,395	187,583	2,326,230
Texas	1,233,553	436,927	438,374	3,021	2,111,876
Utah	7,515	0	21,571	4,437	33,524
Vermont	217,084	38,363	107,673	0	363,120
Virginia	1,483,346	813,600	1,048,745	39,366	3,385,057
Washington	2,135,174	46	1,963,678	21,446	4,120,344
West Virginia	976,712	49,428	482,367	118,779	1,627,287
Wisconsin	1,153,876	998,604	654,054	60,410	2,866,943
Wyoming	36,327	0	36,405	34,014	106,745
Total	40,084,609	12,405,402	22,003,291	1,295,560	75,788,862

Table 1.1-14.
Tons of forest residue Available for Producing Biofuels
Biomass available at \$70/ton

	Logging Residue	Other Removals	Timberland Thinnings	Primary Mill Residue	Total Quantity
Alabama	2,405,083	507,240	1,163,309	7,117	4,082,749
Arizona	27,131	49,020	77,357	1,351	154,859
Arkansas	1,703,543	770,985	984,188	12,889	3,471,605
California	1,166,955	0	2,001,231	65,088	3,233,274
Colorado	20,112	22	61,238	2,302	83,674
Connecticut	8,601	32,190	20,929	3,949	65,670
Delaware	35,863	28,290	13,400	0	77,554
Florida	1,070,430	515,407	664,706	2,202	2,252,745
Georgia	3,113,907	993,262	1,553,823	45,138	5,706,130
Idaho	432,605	0	123,852	6,006	562,463
Illinois	278,305	235,178	230,863	18,523	762,869
Indiana	562,928	104,173	443,691	10,627	1,121,419
Iowa	112,100	55,215	99,102	159	266,576
Kansas	14,658	88,405	19,353	8,720	131,136
Kentucky	1,027,977	664,358	927,808	55,196	2,675,339
Louisiana	2,634,279	880,585	750,104	30,075	4,295,044
Maine	2,561,023	989	332,233	42,483	2,936,728
Maryland	189,159	842	81,988	17,067	289,054
Massachusetts	78,254	66,382	27,602	0	172,239
Michigan	783,465	257,201	1,066,214	13,763	2,120,643
Minnesota	717,037	683,787	401,197	26,878	1,828,900
Mississippi	3,097,069	710,142	1,033,196	95,138	4,935,545
Missouri	774,868	530,292	1,287,857	79,787	2,672,803
Montana	431,194	0	166,045	9,136	606,375
Nebraska	21,419	18,867	23,414	4,971	68,672
Nevada	44	142	0	0	186
New Hampshire	331,037	395	116,195	7,019	454,646
New Jersey	6,368	79	4,847	1,437	12,731
New Mexico	34,478	2,575	64,375	4,902	106,330
New York	768,914	113,104	385,701	27,390	1,295,109
North Carolina	2,026,330	1,259,265	1,600,910	12,811	4,899,315
North Dakota	2,907	15,202	7,644	265	26,018
Ohio	372,045	18,139	177,144	22,600	589,927
Oklahoma	347,738	197,587	163,268	495	709,088
Oregon	2,502,187	68	1,133,187	16,316	3,651,758
Pennsylvania	1,092,836	1,386	680,995	170,972	1,946,189
Rhode Island	1,913	50,079	5,600	389	57,981
South Carolina	1,429,102	696,577	791,111	1,051	2,917,842
South Dakota	23,743	31,161	8,258	2,294	65,457
Tennessee	633,412	489,840	1,033,100	187,583	2,343,935
Texas	1,233,553	436,927	507,340	3,021	2,180,841
Utah	7,515	0	29,434	4,437	41,386
Vermont	217,084	38,363	142,210	0	397,658
Virginia	1,483,346	813,600	1,260,733	39,366	3,597,045
Washington	2,135,174	46	2,059,970	21,446	4,216,636
West Virginia	976,712	49,428	575,278	118,779	1,720,198
Wisconsin	1,153,876	998,604	841,550	60,410	3,054,440
Wyoming	36,327	0	43,195	34,014	113,536
Total	40,084,609	12,405,402	25,186,746	1,295,560	78,972,317

The U.S. Forest Service data reveals that there is a lot of forest material in the Southeast, the far Northeast and the Northwest portions of the U.S. The data also shows that the price curve for this forest material is fairly flat over the range summarized here. This suggests that the forests which are already accessible by roads provide access to low cost forest material from the thinning of timberland. However, to access more and more of the timberland, the costs ramp up quickly to gain access to more of the timberland.

Summary

We compared the quantity of potential biomass supplies projected to be available in 2022 by the two studies and the data that the Forest Service provided us in Table 1.1-15.

**Table 1.1-15.
Forest Biomass Availability in 2022 at Different Prices (million dry tons/yr)**

Price (\$/ton)	30	45	70
Billion Ton Study	79		
U.S. Cellulosic Biofuels	20	103	118
Forest Service Data	70	76	79

1.1.2.3 Urban wastes

Cellulosic feedstocks available at the lowest cost to the ethanol producer will likely be chosen first. This suggests that urban waste which is already being gathered today and typically incurs a fee for its disposal may be among the first to be used. Urban wood wastes are used today in a variety of ways. Most commonly, wastes are ground into mulch, dumped into landfills, or incinerated with other MSW or construction and demolition (C&D) debris. Estimating the amount of urban waste available for biofuel production involves understanding the types of materials that can be found in urban waste, potential competing uses of urban waste, and the challenges with separating a mixed feedstock.

1.1.2.3.1 Municipal Solid Waste

MSW consists of paper, glass, metals, plastics, wood, yard trimmings, food scraps, rubber, leather, textiles, etc. See Figure 1.1-2 for the percent composition of MSW generated (before recycling) in 2006.⁶¹ Construction and demolition debris is not included in the estimate.

**Figure 1.1-2.
Total MSW Generation (by Material), 2006
251 Million Tons (Before Recycling).**

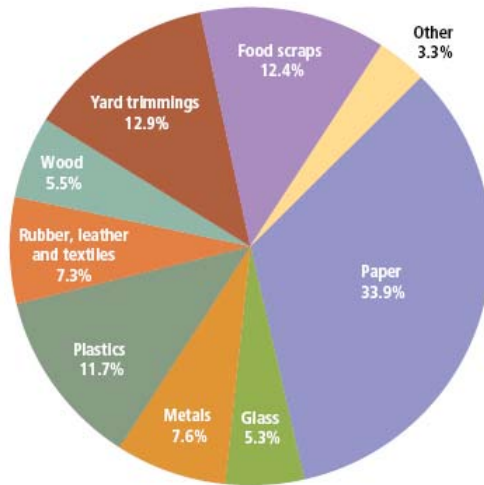

The portion of MSW containing cellulosic material and typically the focus for biofuel production is wood and yard trimmings. In addition, paper, which made up approximately 34 percent of the total MSW generated in 2006, could potentially be converted to cellulosic biofuel. Food scraps could also be converted to cellulosic biofuel, however, it was noted by an industry group that this feedstock could be more difficult to convert to biofuel due to challenges with separation and the materials degrading.

Although recycling/recovery rates are increasing over time, there appears to still be a large fraction of biogenic material that ends up unused and in landfills. In order to project the portion of material that can potentially be used for biofuel purposes, we must understand how the composition of landfilled material changes over time. To do this, we first analyzed the trends from 1960-2006 for the percent composition of total MSW generated from paper/paperboard, wood, and yard trimmings over time as shown in Table 1.1-16 in order to project the percent composition of total MSW generated for the year 2022 for those categories (i.e. calculated to be 26.9% paper, 5.5% wood, and 12.7% yard trimmings).⁶² In general, there appears to be a decrease in the percentage of total MSW generated from paper and yard trimmings while the composition of wood relatively remained stable.

**Table 1.1-16. Percent Composition of Total MSW Generated
(including recyclable material): Paper, Wood, and Yard Trimmings**

	1960	1970	1980	1990	2000	2002	2004	2005	2006	...	2022
Material											
Paper/paperboard	34	36.6	36.4	35.4	36.8	35.1	35.1	34.3	33.9	...	26.9
Wood	3.4	3.1	4.6	6.0	5.5	5.6	5.5	5.6	5.5	...	5.5
Yard Trimmings	22.7	19.2	18.1	17.1	12.8	13.0	12.7	12.9	12.9	...	12.7

We also analyzed the trends from 1960-2006 for the percent composition of total MSW discarded (i.e. after recycling has occurred) to project the percent compositions for the year 2022

(i.e. calculated to be 11% paper, 8% wood, and 2% yard trimmings), see Table 1.1-17 and Table 1.1-18. Comparing Table 1.1-16 and Table 1.1-17, we note that there is a lower percent of paper and yard trimmings that is discarded than generated for MSW. This makes sense because a large percentage of these materials are recycled. Other than recycling, some MSW material is also combusted for energy use. This material we assume would be unavailable for biofuel use, and therefore report in Table 1.1-18 the percent composition of total MSW discarded after accounting for both recycling and combustion for energy use. Therefore, we have taken into account MSW that could potentially be diverted towards recycling instead of future biofuel production.

**Table 1.1-17. Percent Composition of Total MSW Discarded
(not including recycled material): Paper, Wood, and Yard Trimmings**

	1960	1970	1980	1990	2000	2002	2004	2005	2006
<u>Material</u>									
Paper/paperboard	30.2	33.2	31.7	30.5	29.7	27.3	27.3	25.5	24.3
Wood	3.7	3.3	5.1	7.0	7.0	7.2	7.3	7.4	7.4
Yard Trimmings	24.2	20.5	20.1	17.9	8.7	9.0	7.0	7.2	7.3

**Table 1.1-18. Percent Composition of Total MSW Discarded
(not including recycled or combusted material): Paper, Wood, and Yard Trimmings**

	1960	1970	1980	1990	2000	2002	2004	2005	2006	...	2022
<u>Material</u>											
Paper/paperboard	30.2	33.1	28.8	26.1	25.5	23.5	23.5	22.1	21.3	...	11.2
Wood	3.7	3.3	4.6	6.0	6.0	6.2	6.3	6.4	6.5	...	7.6
Yard Trimmings	24.2	20.4	18.3	15.3	7.5	7.7	6.0	6.2	6.4	...	1.9

The total amount of MSW generated (prior to recycling) is assumed to increase over time due to population growth. Biocycle magazine (2006) reports MSW estimates for each state in the U.S. based off of 2004 population data.⁶³ We used U.S. Census Bureau population projections by state to scale up or down the MSW estimates depending on whether the state populations increase or decrease by 2022. The total amount of MSW generated (prior to recycling) was estimated to be 391 million tons. As we are interested in the volume of MSW available for biofuel use, we focused only on waste estimated to be landfilled, which is a portion of the total MSW generated. We used estimates on the percentage of MSW landfilled by state from Biocycle in order to estimate the amount of MSW potentially available to biofuels (after recycling).

Knowing the total amount of MSW landfilled is only part of the picture. We also need to understand the types of cellulosic material likely to make up the MSW landfilled. For this, we were able to gather state composition data (i.e. percent wood vs. paper vs. other materials) of landfills for MSW *generated*, however, we were in fact interested in acquiring state composition data for the MSW *landfilled*.^{64,65,66,67,68,69,70,71,72,73,74} Using the state composition data, we estimated the percent composition of MSW landfilled by state using a ratio of percent composition of national material generated (estimated in Table 1.1-16) and landfilled (estimated in Table 1.1-18) and state percent composition data for MSW generated (gathered from the

multiple state reports). We then multiplied the volume of MSW (in tons) generated for each state in the year 2022 by the percent of MSW estimated to be landfilled (provided in Biocycle) and by the percent composition of MSW landfilled by state. Some states did not provide composition data, therefore, we estimated average percentages based on the states within a similar location in the U.S. where data was provided (e.g. if Utah data was unavailable, we assumed compositions would be similar to other rocky mountain states).

Furthermore, the amount of MSW potentially available is limited by assumptions on percent moisture and percent contamination. We assumed that paper, wood, and yard trimmings have a 10%, 20%, and 40% moisture content, respectively.^{75,76} We also assumed that wood is approximately 50% contaminated, due to objects such as nails, paint, chemicals, etc. typically associated with such feedstocks. Paper and yard trimmings are assumed to be mostly uncontaminated, assuming 75% uncontaminated. We account for contamination because it is likely to affect the quality of the wood waste and could potentially cause problems in the processing steps of cellulosic material to biofuel. Thus, for this analysis we assumed that the estimated contaminated portions would not be used for biofuel production. In addition, not all yard trimming can be assumed to be wood, only 25% is assumed to be from wood.⁷⁷ We estimate that 22 million tons could be available from paper, 0.2 million tons from yard trimmings and 4 million tons from wood.

At the time of this proposal we did not include food scraps in our estimates for urban wastes as this source was observed to have difficulties in separation and more easily degraded, making an assessment of this feedstock complex. Food scraps made up 12.4% of the total MSW generated in 2006, meaning that potentially 31 million tons (and perhaps more by the year 2022) could be available for cellulosic biofuel production.

1.1.2.3.2 Construction and Demolition (C&D) Debris

C&D debris mostly comes from building demolition and renovation, and the rest comes from new construction.⁷⁸ Roughly equal percentages of building-related waste are estimated to come from the residential and commercial building sectors. The composition of C&D materials varies significantly, depending on the type of project from which it is being generated. For example, materials from older buildings is likely to contain plaster and lead piping, while new construction materials may contain significant amounts of drywall, laminates, and plastics. For building materials, EPA estimates the overall percentage of debris in C&D materials falls within the following ranges:

Table 1.1-19.
Percentage Composition of C&D Debris
(by volume)

Concrete and mixed rubble	40-50%
Wood	20-30%
Drywall	5-15%
Asphalt roofing	1-10%
Metals	1-5%
Bricks	1-5%
Plastics	1-5%

In 1996, total C&D debris generated was estimated to be approximately 124 million metric tons.⁷⁹ As seen in Table 1.1-19 above, only a portion of this, however, would be made of woody material. We based our estimate of C&D wood in 2022 on the equation adopted from Wiltsee's analysis.⁸⁰ The equation estimated C&D wood based on population size. We estimated approximately 31 million tons could be available from this resource by 2022; however, we assumed that 50% of that could potentially be contaminated. Thus, we estimate that only 15.4 million tons would be available for biofuels.

1.1.2.4 Dedicated Energy Crops

Crops developed and grown specifically as a renewable source of cellulosic material for biofuel production are not yet commercial, but have the potential for negating some of the problems surrounding other feedstocks. Currently, crops such as corn that are grown and harvested for energy uses in the United States are also used for agricultural purposes and serve many important uses other than biofuel production. This competition could be reduced by the use of non-agricultural feedstocks for cellulosic biofuel production. Urban wastes and forest and agriculture residues will likely be the first feedstocks used in cellulosic biofuel production; However, there are many uncertainties over land availability and sustainable removal rates for residues.

Most energy crops will be perennial species grown from roots or rhizomes that remain in the ground after harvesting the above-ground biomass. While most agricultural crops are annual species, perennials are considered beneficial in many ways. Dedicated perennial energy crops have the potential to grow on marginal lands, produce high yields, and may have low input needs. Once a perennial crop is established costs are reduced, as the need for tillage is lowered. The root system that remains in the soil can also facilitate the acquisition of nutrients thus decreasing the need for large fertilizer inputs. In southern climates, perennials have the potential for higher yield per acre of land than other annual crops. This is due to the fact that perennial plants develop more quickly in the spring and the canopy of foliage can sustain for longer in the fall. This makes it possible for the plants to be more photosynthetically active and have a more efficient energy conversion system. Perennial energy crops also increase soil productivity, sequester carbon, and provide refuge for wildlife.

1.1.2.4.1 Types of Energy Crops

The following sections describe several of the most commonly discussed dedicated energy crops (switchgrass, miscanthus, and hybrid poplars) as well as some less familiarly known crops.

1.1.2.4.1.1 Switchgrass

The energy crop that has received the most attention is switchgrass. Switchgrass (*Panicum virgatum*) is perennial warm season grass that is native to the United States. It typically reaches heights of 3-5 feet, but can grow to more than 10 feet in some southern regions. It has a deep root system that extends many feet below the earth. It may be the ideal energy crop mainly because it can tolerate many soil types and climates from drought conditions to floods. It is also resistant to many pests and diseases. The photosynthetic pathway of switchgrass (and other perennials) allows it to produce high biomass yields with low amounts of chemical input. In the spring, switchgrass develops a photosynthetic canopy of biomass more quickly, and it also persists longer in the fall than annual plants, allowing for a high net conversion of solar energy per year.⁸¹

Highly variable yields have been estimated at 1-12 dry tons/acre per year (3-30 dry tons/ha) depending on soil, location, and variety. A yield of 4-5.5 tons/acre (10-13 tons/ha) is a reasonable commercial average today.⁸² In a long term study sponsored by the DOE, average yield after 10 years of growth was 4.8-7.6 tons/acre (12-19 tons/ha) for switchgrass when harvested annually.^{H,83} Biannual harvests were also done experimentally to try and achieve the maximum yields possible but show little difference in total yield. Biannual harvests result in approximately 70% of the yield for the first cut and 30% for the second.⁸⁴

Water and nitrogen availability are the main resources that limit production of warm-weather grasses such as switchgrass. Nitrogen accessibility for these plants depends on many factors. Harvesting frequency, soil content, and removal rates all affect the nitrogen available to the plant. In the previously mentioned study by S.B. McLaughlin, initial nitrogen fertilization rates were 40-120 kg/acre (36-107 lbs/acre); however they discovered that a reduction to only 20 kg/ha (17.8 lbs/acre) of nitrogen was sufficient to produce similar yields in single cut systems in the mid-Atlantic region.⁸⁵ Reduced nitrogen amounts were similar in other regions of the country. In comparison, the US fertilization rate for corn is an average of 138 lbs/acre.

With commercial growth of switchgrass, growers would sell the crop for conversion to cellulosic ethanol. Our economic modeling shows that in order to meet the cellulosic biofuel goal of 16 Bgal set by the EISA mandates, dedicated energy crops will need to be utilized.^I

^H Switchgrass variety used in this study was Alamo. Other varieties could result in different yields.

^I Assuming 16 Bgal cellulosic biofuel total, 2.2 Bgal from urban waste, and 3.8 Bgal from forestry biomass; 10 Bgal of cellulosic biofuel for ag residues and/or energy crops would be needed.

1.1.2.4.1.2 Miscanthus

Miscanthus is a tall perennial grass that has been evaluated as a potential energy crop most extensively in Europe where it is already being produced for biofuel. The genus is primarily tropic or sub-tropic in origin but there is a wide climactic range at the species level.⁸⁶ This characteristic makes it more suitable for establishment over the ranging climates of North America. Giant miscanthus (*Miscanthus x giganteus*) is a hybrid variety that can grow 12-14 feet tall. It is a cold-tolerant warm season grass and has similar characteristics of switchgrass with high yields and low amounts of input.⁸⁷

Research on miscanthus is currently being conducted at the University of Illinois. In the Midwest, the growing season is April to October. The plant grows large green foliage that maximizes in approximately late August. As the temperature falls the foliage fades and drops off leaving the stem. The stem is the commercially important part of the plant and resembles bamboo. Stems can reach nine feet in length, ½ to ¾ in diameter, and are harvested in the winter after drying occurs.⁸⁸

Establishment of a crop takes approximately 2 years, with maximum yields reached in the third year depending on soil fertility. The grass could require 4-5 years on low quality soils. In established crops 5-10 shoots per square foot can be developed. Yields in various studies from the University of Illinois were 9-16 tons/acre in various regions in Illinois. The southern regions of the state with poor soil quality also saw high yields illustrating that miscanthus is suitable for growth and high achievable yields on marginal land.⁸⁹ Yields in Europe ranged widely, with irrigated crops reaching 12 tons/acre and un-irrigated yields of 4-10 tons/acre in the fall. According to trials conducted in Europe, the quality of miscanthus biomass for conversion to biofuel improves by delaying harvesting until after the winter months and the plant has time to dry sufficiently. However, this reduced yields by 30 percent.⁹⁰ In comparison to switchgrass, research out of Illinois also concluded that miscanthus can yield more biomass for conversion to biofuel because of its even higher photosynthetic efficiency and longer growing season.⁹¹ In terms of input, miscanthus uses nitrogen extremely efficiently and therefore does not need to be fertilized for high yields to be achieved. There is also no need for pesticides; however, herbicides have been used to control weed populations.⁹²

Challenges in growing and producing miscanthus crop include high establishment costs, problems in winter survival during the first year, and high water needs. European cost estimates are similar to other perennial plants at approximately \$64 per dry ton; however they estimate that a growing cycle of 10-12 years is required to recover the start-up costs of \$267 per planted acre.⁹³ The bulk of the high initial cost comes from planting and harvesting machinery. Establishment of a stronger market for growing these energy crops, as well as increased knowledge of propagation of the species, will inevitably lower overhead costs.⁹⁴

1.1.2.4.1.3 Hybrid Poplar

The poplar tree (*Populus trichocarpa*) is another option being investigated for use as a dedicated energy crop. Herbaceous or woody perennial plants have some of the same characteristics of the perennial grasses that make them suitable for possible use as an energy

crop. They retain significant amounts of root biomass below ground, require little tillage thus decreasing labor and erosion, grow fast large canopies, and require less fertilization than their agricultural counterparts.

Technological advances in harvesting and genetics must be utilized in order to produce species that will be more suitable for use as an energy crop. Genetic information has helped to understand the characteristics the poplar tree. The complex genetic information obtained from the genome of this plant will make possible the engineering of faster growing trees with more biomass available for harvest.⁹⁵

1.1.2.4.1.4 Other Potential Feedstocks

Several other perennial plants have the possibility to be used as dedicated energy crops. As previously described, the characteristics of perennial species make some optimal for use in this capacity. Because these plants have not been grown in agricultural sectors, they have not been extensively researched and developed for optimization. Corn is a crop that has been scientifically studied for decades because of its continued importance in the market. Dedicated energy crops must see this type of investment to bring about further knowledge of basic biology which will lead to advances in breeding and eventual domestication of the species that have promise. The DOE along with university research have implicated several other plants as potential energy crops. These include additional types of grasses such as reed canary grass and sorghum. Hybrid willow, silver maple, black locust, sweetgum, and eucalyptus are other perennial woody plants that are possibilities.⁹⁶

Significantly accelerated testing and selection for populations will be necessary in establishing these plants. Breeding for desired traits and adaptability across a wide array of environments in multiple physiologic and geographic regions will be necessary. No single species of dedicated energy plant will be optimal for all areas of the country, especially considering the amount of biofuels needed. Temperature, rainfall, and soil composition are highly variable across the continental United States; therefore, using a diverse group of plant species optimal for each growing region is a likely strategy. With current information and characteristics of each plant, the DOE has estimated where the possible growing areas could occur (see Figure 1.1-3).⁹⁷

**Figure 1.1-3.
Possible Geographic Distribution of Dedicated Biomass Crops**



^A U.S Department of Energy. Breaking the Biological Barriers to Cellulosic Ethanol: A Joint Research Agenda. (2006).

1.1.2.4.2 Land Assessment

There is evidence that perennial species are suitable for growth on marginal lands that are not useful for growth of food crops. A new study by Elliot Campbell out of Stanford University assessed abandoned land availability and the potential for this land to be used for energy crops. Because of the increased demand for biomass energy, using abandoned crop or pasture lands to grow some of these crops could be a better alternative than converting forested areas or using food agriculture lands. This study estimated the amount of global abandoned land available, the amount of biomass that could be grown on these lands, and the corresponding energy that could be obtained. Historical land use data, satellite imagery, and a global ecosystem model were used for the estimates. They considered “abandoned land” as land that was previously used for pasture or crops but has since been abandoned and not converted to urban or forested areas. Historical land use data was obtained from the History Database of the Global Environment 3.0 (HYDE) which consisted of gridded maps which show the fraction of crop and pasture land within each grid cell for decades between 1700 and 2000. Also, the Center for Sustainability and the Global Environment (SAGE) land use database was used to check and supplement the HYDE database. They used a MODIS satellite map to exclude areas that have transitioned into forest or urban areas. Two different mathematical approaches were then used to estimate a conservative and a high estimate of total land available. Biomass production was estimated using the Carnegie-Ames-Stanford Approach ecosystem model which takes into account climate data, soil texture, land cover and the normalized difference vegetation index (NDVI), but does not take into account fertilizer use or irrigation, which could increase yields (see Figure 1.1-4).⁹⁸

Figure 1.1-4. Global View of Crop and Pasture Abandoned Lands

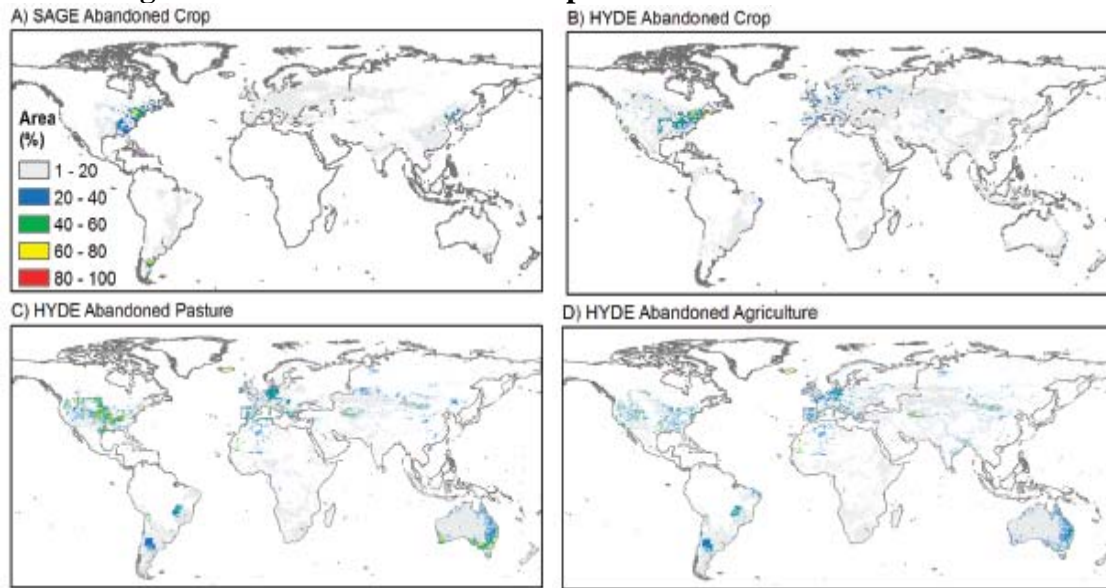

Obtained from: Campbell, J.E. et al. The global potential of bioenergy on abandoned agriculture lands. *Environ. Sci. Technology*. (2008). (A) SAGE supplemental data showing abandoned crop lands. (B) HYDE data showing crop lands that have been converted to uses other than cropping. (C) HYDE data showing former pasture lands that have been converted to uses other than for pasture. (D) HYDE data showing an average of total abandoned agriculture land (excludes areas of land use transition of crop to pasture, pasture to crop, agriculture to forest, and agriculture to urban).

The low and high estimates for global abandoned land, excluding forested and urban areas are 385 and 472 million hectares. The authors found that these lands could produce between 1.6 and 2.1 billion tons of biomass respectively. In the United States an average of approximately 58 million ha (146 million acres) of abandoned land was estimated. Assuming natural growth on these lands, approximately 321 million tons/year of biomass could be produced. At 80 gallons of ethanol per ton of biomass, there would be the potential to produce approximately 26 billion gallons from a grass crop such as switchgrass. It is pointed out that there will be significant differences between crop types and management styles which will effect growth and yields. There is not a specified crop type; however, as the author's point out that growing conventional crops such as corn on this land could increase erosion and polluted runoff. Growing perennial grasses such as switchgrass, for use as a feedstock would be the best option.⁹⁹ Although perennial grasses are able to grow on these lands, yields may be lower than they would be on more suitable agricultural lands.

On a state-by-state basis, the areas with the highest amount of available abandoned lands are in the West. Wyoming, Utah, Oregon, New Mexico, Nevada, Colorado and California all contribute over 5 million abandoned acres to the total. Texas has the largest amount of abandoned land estimated at 10.37 million acres. Midwestern states including Iowa, Wisconsin, Illinois, and Ohio have approximately 3-4 million acres of abandoned land each (see Table 1.1-20). These lands may be more conducive to crop production than the more arid parts of the West. However, the condition and quality of these lands is unknown at this time. It would be difficult to estimate the specific types of energy crops that could be grown on these lands. Also, in the DOE assessment previously referenced, most of the Western states are not implicated as areas of possible biomass growth (above Figure 1.1-3).

Table 1.1-20. Abandoned Agriculture Land and Potential Production by State¹⁰⁰

State	Area (Million ha)	Area (Million acres)	Production (MM tons biomass/yr)	Ethanol Production Rate (gallons/tons)
Alabama	1.4	3.46	13.2	3.82
Alaska	0.3	0.74	0.4	0.54
Arizona	1.9	4.69	2.4	0.51
Arkansas	1.1	2.72	11.1	4.09
California	3.6	8.89	13.2	1.48
Colorado	2.7	6.67	8.1	1.21
Connecticut	0.1	0.25	0.6	2.43
Delaware	0.1	0.25	0.5	2.02
District of Columbia	0	0	0	0
Florida	0.5	1.24	2.7	2.19
Georgia	1.6	3.95	15.2	3.85
Idaho	1.4	3.46	4.7	1.36
Illinois	1.6	3.95	11.4	2.88
Indiana	1.2	2.96	8.5	2.87
Iowa	1.6	3.95	12.7	3.21
Kansas	0.3	0.74	1.8	2.43
Kentucky	0.8	1.98	6.7	3.39
Louisiana	0.9	2.22	7.8	3.51
Maine	0.1	0.25	0.8	3.24
Maryland	0.4	0.99	2.7	2.73
Massachusetts	0.2	0.49	1.1	2.23
Michigan	1.5	3.71	9	2.43
Minnesota	1.6	3.95	10.7	2.71
Mississippi	1	2.47	9.1	3.68
Missouri	1.5	3.71	14.1	3.81
Montana	1.7	4.2	6.8	1.62
Nebraska	0.4	0.99	2.2	2.23
Nevada	2.1	5.19	3	0.58
New Hampshire	0	0	0.3	0
New Jersey	0.2	0.49	1.9	3.85
New Mexico	3	7.41	5.4	0.73
New York	1.7	4.2	10.2	2.43
North Carolina	0.7	1.73	6.2	3.59
North Dakota	1	2.47	4.4	1.78
Ohio	1.4	3.46	8.9	2.57
Oklahoma	1.1	2.72	8.8	3.24
Oregon	2.2	5.43	8.2	1.51
Pennsylvania	1	2.47	8.2	3.32
Rhode Island	0	0	0.2	0
South Carolina	0.8	1.98	7.3	3.69
South Dakota	0.3	0.74	2	2.7
Tennessee	1.1	2.72	10.3	3.79
Texas	4.2	10.37	25.3	2.44
Utah	2.6	6.42	4.7	0.73
Vermont	0.1	0.25	1	4.05
Virginia	0.7	1.73	6.7	3.88
Washington	0.9	2.22	4	1.8
West Virginia	0.1	0.25	0.5	2.02
Wisconsin	1.4	3.46	9.9	2.86
Wyoming	2.8	6.92	6.1	0.88
Totals	58.9	145.5	321	
Total Ethanol Volume ^a				25.68 Bgal Ethanol/yr

a. Assuming 80 gal/ton conversion rate

The estimates of abandoned agricultural land do not include land enrolled in the Conservation Reserve Program (CRP), which could be an additional source of land available for energy crops. Land in this program is farmland that is converted to trees, grass, and areas for wildlife cover, but is considered crop land by the models in the abandoned land study. Environmental benefits of this land include the creation of wildlife habitat, increasing soil productivity, reducing soil erosion and improving ground and surface water quality.¹⁰¹ As of July 2008, there were 34.67 million acres under the CRP contract which is down 2.1 million acres from last year.¹⁰² Approximately 28 million CRP acres are growing with native or introduced grasses, suggesting that there is a significant amount of switchgrass already in the environment. Figure 1.1-21 shows the land allocation in the United States in 2007.¹⁰³ Recently, the 2008 Farm Bill capped the number of acres in the CRP at 32 million acres for 2010-2012. Following historical trends, it is assumed that some of these acres will go into crop production. While some of this land may go for biofuel production, the benefits of producing energy crops will have to be weighed against the benefits of having the land in the CRP.

Figure 1.1-5. CRP land in 2007
CRP Enrollment, FY 2007 (Cumulative)
 CRP Acres, All Signup Types and Practices

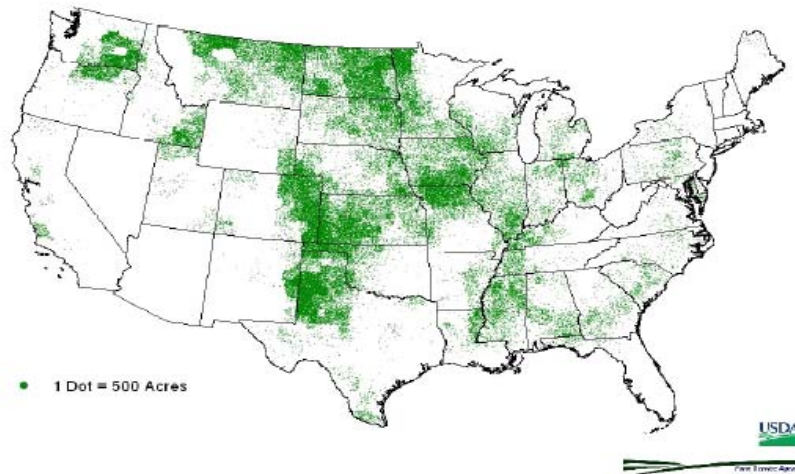

USDA. Farm Services Agency. Conservation Reserve Program Summary and Enrollment Statistics. FY 2007

1.1.3 Biodiesel & Renewable Diesel Feedstocks

In general, plant and animal oils are valuable commodities with many uses other than transportation fuel. Therefore we expect the primary limiting factor in the supply of both biodiesel and renewable diesel to be feedstock availability and price. Primary drivers for this are increasing worldwide demand as incomes rise in developing countries, as well as increased recognition that these materials have value based on their energy or hydrocarbon content as substitutes for petroleum. Expansion of biodiesel market volumes beyond the mandates is dependent on it being able to compete on a price basis with the petroleum diesel being displaced.

The primary feedstock for domestic biodiesel production in the U.S. has historically been soybean oil, with other plant and animal fats and recycled greases making up a small portion of

the biodiesel pool. We estimate that 2-4 percent of biodiesel came from waste cooking oils and greases in calendar year 2007.¹⁰⁴

1.1.3.1 Virgin Plant Oils

Agricultural commodity modeling we have done for this proposal (see Chapter 5 of this document) suggests that soybean oil production will stay relatively flat in the future, meaning supplies will be tight and prices supported at a high level as biofuels demand increases. Modeling scenarios conducted for the year 2022 with the EISA mandates indicates that domestic soy oil production could support about 560 million gallons of biodiesel production. The model also projects that some food-grade corn oil will also be directed to biodiesel production based on its price and availability, resulting in an additional 109 million gallons of fuel from this source in 2022. These materials are most likely to be processed by biodiesel plants due to the large available capacity of these facilities and their proximity to soybean production. Compared to other feedstocks, virgin plant oils are most easily processed into biofuel via simple transesterification due to their homogeneity of composition and lack of contaminants.

1.1.3.2 Corn Oil Extracted During Ethanol Production

A source of feedstock which could provide significant volume is oil extracted from corn or fermentation co-products in the dry mill ethanol production process. Often called corn fractionation or dry separation, these are a collection of processes used get additional product streams of value from the corn. This idea is not new, as existing wet mill plants create several streams of product from their corn input, including oil. In a dry mill setting, the kernel can be separated into the bran, starch, and germ components ahead of fermentation, or alternatively, oil can be extracted from the distillers' grains after fermentation. Both have advantages and disadvantages related to plant capital cost and energy consumption, as well as yield of ethanol and the other coproducts.

Extraction of oil from the thin stillage or distillers' grains with solubles (DGS) streams is a proven technology that can be retrofit to existing plants relatively cheaply. Front-end separation requires more intensive capital investment than is required to extract oil from the DGS, and therefore is best designed into the plant at the time of construction. However, it yields a larger array of co-products, and generally also results in ethanol process energy savings since less unfermentable material is going through the process train. We expect that this technology will be increasingly deployed in new plants in parallel to existing plants pursuing extraction of oil from DGS. For the sake of simplicity, for this proposal we have chosen to focus for cost and volume estimates on the DGS extraction process.

Specifically, our estimates come from a process developed and marketed by GS Cleantech, Inc., though there are others who will likely develop and market similar processes. Depending on the configuration, this system can extract 20-50 percent of the oil from the fermentation co-products, producing a distressed corn oil stream which can be used as feedstock by biodiesel facilities. Since it offers another stream of revenue from the corn flowing into ethanol plants, we assumed approximately 40 percent of projected total ethanol production will implement this or other oil extraction process by 2022, generating approximately 150 million

gallons per year of corn oil biofuel feedstock.^{105,J} We expect this material to be processed in biodiesel plants for the same reasons given above for soy oil. At this time it is uncertain whether there will be third party aggregators of this extracted oil, or whether individual ethanol plants will contract directly with nearby biodiesel facilities, which may ultimately impact where and how this feedstock is processed.

1.1.3.3 Yellow Grease and Other Rendered Fats

Rendered animal fats and reclaimed cooking oils and greases are another potentially significant source of biodiesel feedstock. In 2007, Tyson Foods announced plans to produce renewable diesel at multiple sites in joint venture with ConocoPhillips and Syntroleum Corp, suggesting these operations are technologically feasible if market conditions are right.

National Renderer's Association gives a quantity of approximately 11 billion lbs of fats and greases available annually for all uses, and suggests this will grow by 1% per year.¹⁰⁶ This figure is broken down into several categories, and includes "yellow grease" and "other grease" collected and processed by rendering companies each year. NRA defines yellow grease as material primarily derived from restaurant grease or cooking oil (they do not define "other grease" but we can assume this is trap grease or other reclaimed material). Adding together the NRA's "yellow grease" and "other grease" categories, we arrive at 2.7 billion lbs per year (all figures there are for 2005).

Similarly, a 2004 report prepared for New York State Energy Research and Development Authority by LECG, LLC describes yellow grease as material produced by restaurants and food service.¹⁰⁷ (This report describes grease recovered from sewer traps as brown grease, and suggests it is too low in quality to be used for biodiesel production.) Based on USDA and US Census data, LECG shows production of yellow grease by restaurants to be on the order of 9 lbs per capita per year, equivalent to about 2.7 billion lbs/yr. Unfortunately, it's not clear whether this quantity would include or be in addition to the NRA figures, but given the similarity of numbers, it seems reasonable to suspect that the NRA total includes the same sources of grease as assessed by LECG.

Thus, the figures we use here assume that the NRA figures already include collection of a large portion of restaurant and trap grease by rendering companies; we have not included additional waste greases that other studies have suggested might be available based on per-capita use of cooking oils, wastewater treatment disposal, etc. Perhaps there is some additional waste grease out there not being collected or counted by NRA that is, or could be, aggregated and funneled into biofuel production, but there is unfortunately no good way for us to determine this.

In addition to the named sources above, there is also a written statement by David Meeker of the NRA asserting that not more than 30% of the 11 billion lbs could be directed to biofuel production on a long-term basis.¹⁰⁸ So, along with the total volume of fats and greases as estimated above, we have 0.3×11 billion lbs per year / 7.6 lbs per gallon = 434 million gallons. With 1% annual growth between 2005 (the year of the figures cited) and 2022, we

^J The projected fraction of plants doing corn oil extraction was based on a conversation with someone working in the ethanol industry, as well as Table 3 of the Mueller report referenced in this paragraph.

arrive at a potential 514 million gallons of biodiesel per year from all available sources. Our projections in this proposal suggest that 375 million gallons or 73% of this will be actually be utilized for biofuel. This figure was derived from FASOM modeling of other sources of feedstock we expect to be available (such as soy oil), as well as our assumptions about corn oil extracted at ethanol plants, in the context of the standard set forth in the EISA. This 73% seems reasonable considering market inefficiencies and potential competition from other high-value, non-fuel uses of these feedstocks.

Much of biodiesel production seems to rely on niches of feedstock availability and market outlets. Thus we could assume that the 2-4% of biodiesel volume to be produced from fats and greases as reported by FO Licht for 2007 will continue indefinitely. We speculate that much of any new fat and grease feedstock use would be routed to renewable diesel in the long term, however, because that process appears to have lower operating costs for this material, and because there have been intent or construction announcements for RD plants to utilize a significant portion of the 375 MMgal. Furthermore, we suspect that some of the feedstock these plants will use may be obtained through direct contract or joint venture with animal processing or rendering operations, such that it would not typically be available on the open market to 5 or 10 or 20 MMgal/yr biodiesel plants in a different county or state. Thus we chose to assume the vast majority of this feedstock would be routed to RD production by the time of the fully phased-in RFS2 program, and ignored its use in biodiesel production.

1.1.3.4 Jatropha

Jatropha is a genus of plants, consisting of both shrubs and trees, some of which hold some promise as a feedstock for the production of biofuels. One species in particular, *Jatropha curcas*, yields seeds that contain between 25-45 percent lipids, which can be processed to produce biodiesel. Claims regarding the production potential of *J. curcas* have led to the popularity of the crop as a potential biofuel feedstock. In particular, these claims state that the crop:

- grows on marginal lands and reclaims wasteland,
- is tolerant of drought,
- requires low nutrient input,
- requires low labor inputs,
- does not compete with food production, and
- has a high oil yield.

J. curcas has been traditionally cultivated for living fences, to conserve soil moisture, reclaim soil, control erosion, and used locally in soap production, insecticide, and medicinal application.^{109,110} *J. curcas* is also a toxic plant. Safety of large-scale *J. curcas* plantations is also a concern, especially for children. Accidental ingestion can have severe consequences. “Hundreds of cases have been reported from different parts of India. In Meerut (in Uttar Pradesh), over 50 children were recently hospitalized due to jatropha poisoning.”¹¹¹ Even two *J. curcas* seeds are like a strong purgative, while four to five seeds can cause death.

J. curcas has recently been cultivated as an energy crop. *J. curcas* originated in Central America, mainly growing in arid and semi-arid conditions; now it is also found in the tropical regions of Africa, Asia, and North and South America.¹¹² Because of *J. curcas*' deep root system, it can grow in lands that have been previously heavily cultivated or otherwise have low levels of essential minerals and nutrients in the top levels of soil; this results in the recycling of nutrients from deeper soil levels.^{113,114} In addition, because the plant is a perennial (living up to 50 years) the root system stays in place, which can significantly reduce erosion and even reverse desertification.^{115,116} However, *J. curcas* may not produce efficiently on marginal lands without significant extra expense.

1.1.3.4.1 Jatropha Input and Cultivation

As a wild plant which has not yet been domesticated, *J. curcas* may be considered drought-tolerant. However, "there is little known on water use efficiency of *J. curcas* as a crop."¹¹⁷ Even though *J. curcas* can survive moderate droughts by dropping its leaves, the effect of water starvation on seed yield and oil content in the seeds is mostly unknown. No studies relating water use and yield of *Jatropha curcas* were available. Water use efficiency of sister species *Jatropha pandurifolia* and *Jatropha gossypifolia* are reported as 3.68 and 2.52 mol CO₂ / mol H₂O, respectively.¹¹⁸ This is similar to that of other oil seed species like soybean, with a water use efficiency of 3.90 mol CO₂ / mol H₂O.¹¹⁹ Thus, it is conceivable that water requirements of *J. curcas* will be similar to that of other oil seed species; although the plant may survive droughts, it may not produce efficiently or economically when it is water-deprived.¹²⁰ Obviously, further studies relating water use to crop production must be performed.

Because *J. curcas* has been observed growing on low quality soils with low nutrient amounts, it was assumed that the plant would be able to grow as a crop in these conditions. However, research indicates that *J. curcas* growth and production of seed is severely limited by soil fertility.^{121,122} In the initial growth phase of the plantation, when competition between plants for radiation, water, and nutrients is negligible, "nutrient content in mature leaves is not significantly affected by crop density."¹²³ However, in the competition phase, "nutrient uptake from the soil was negatively correlated with plant density;"^{124,125} fertilization with *J. curcas* seedcake significantly increased seed yield.¹²⁶ This indicates that *J. curcas* plantations should at least be fertilized with remaining seedcake (bulk of seed after oil is pressed out), which is very nutrient rich. Thus, this seedcake cannot be sold as a fertilizer, or burned for energy production to make the cultivation of the plant more cost effective, as was suggested in various studies,^{127,128} if *J. curcas* cultivation is to require low external nutrient input. Even in the case that the seedcake and other oil extraction by-products is recycled to maintain soil fertility, "initiating a plantation on low or non fertile soils ... implies the need to use other fertilizers, at least at the start, to boost crop growth and seed production in the initial stages."¹²⁹ The long-term impact of monocultures of jatropha on soil health has not been studied. Although *J. curcas* can potentially grow on marginal land, whether it is safe to plant on current crop land is still unknown. There are some indications that *J. curcas* will not be sustainable, unless specific steps are taken to ensure the plantations' long term health.^{130,131}

Because it was observed that *J. curcas* thrived on marginal soils, it was assumed that the labor required to maintain the crop and harvest the seeds would be minimal. However, in order to

prepare *J. curcas* for use as an energy crop, significant labor is required, including: preparing land, setting up nurseries, planting, irrigating, fertilizing, pruning, harvesting, and processing.¹³² At present, there are no data to show that any of these labor intensive activities, which are assumed in the cultivation of other perennials, can be eliminated. Labor input required for crop maintenance actually rose from 22 person days / ha / year to 70 person days / ha / year from the 1st to 6th year in one study, indicating that there will be no reduction in labor inputs required even as the plantations mature.¹³³ Especially in the United States, where labor costs are high, this is a severe hindrance for the cultivation of *J. curcas* on a large scale. Furthermore, the development of any sort of mechanized harvesting will be problematic, as “continuous flowering results in a sequence of reproductive development stages on the same branch, from mature fruits at the base, to green fruits in the middle, and flowers at the top of the branch;” seeds still need to be picked by hand.^{134,135}

Because it was assumed that *J. curcas* could thrive on marginal land with low resource inputs, it was thought that the crop’s cultivation would not compete with that of food crops.¹³⁶ However, until present, most studies on the crop’s oil production have been carried out given optimal growing conditions that may be unrealistic in many parts of the world. “A major constraint for the extended use of *J. curcas* seems to be the lack of knowledge about its potential yield under sub-optimal and marginal conditions;” it is unknown whether *J. curcas* can produce economically on marginal lands.¹³⁷ Even if *J. curcas* could be grown successfully on these lands, it is likely that, in order to achieve economic yields, significant resource inputs will be needed. In this case, food crops could likely be grown on these same lands anyways; in addition, the cultivation of *J. curcas* will draw scarce water and labor resources from food crops. There are examples of farmers leaving successful food crop plantations to cultivate *J. curcas*, leading to increased food scarcity.¹³⁸ Finally, even if successful cultivation of *J. curcas* were entirely possible on marginal lands with low inputs, the widespread success of the crop “might lead to rapid expansion of production at the cost of food crops.”¹³⁹ Although advances are being made on several of these fronts, currently, *J. curcas* can likely not be cultivated on a large scale without displacing food crops because of land, water, and labor constraints.

1.1.3.4.2 Jatropha Yield

Optimal seed production of 1.5-7.5 tons/ha occurs with 1200 to 1500 mm water/year under different trial conditions.¹⁴⁰ However, a minimum of 500 to 600 mm water/year is required to produce approximately 1 seed ton/ha.¹⁴¹ It is unknown whether this variation is a result of environmental or genetic variation, or a combination of both. Maximum production is attained in mature plantations, about 3-5 years after planting, with a maximum productive life of over 30 years.^{142,143}

The seed of *J. curcas* has a lipid content of roughly 25-45 percent by weight.^{144,145} However, the oil content of the seed was “significantly higher in soils that had not been used for arable farming before (42.3 vs 35 percent).¹⁴⁶ Thus, assuming a seed oil content of 35 percent and an extraction efficiency of 75 percent, this would yield 404-2040 kg oil / ha or 439-2217 liter oil/ha.¹⁴⁷ This is somewhat higher than other oil producing crops like soybean, sesame, sunflower, rapeseed, and castor with a range of 375-1200 liter oil/ha. However, at this time, it is difficult to assess production potentials on marginal land because of the lack of data. “The hype

in *J. curcas* oil production is not sufficiently supported by hard data on crop production, well controlled or optimal management production conditions, and environmental impact.”^{148,149,150,151}

Table 1.1-21. Jatropha Yield^{152,153,154}

	Conservative projection	Optimistic projection
Oil	500 liter/ha (53 gal/acre)	2000 liter/ha (213.8 gal/acre)
Biodiesel	460 liter/ha (49 gal/acre)	1840 liter/ha (196.7 gal/acre)
(1 L/ha = 0.1069 US gallons per acre)		

J. curcas is only currently present in 2 states (Florida and Hawaii) in the United States.¹⁵⁵ Because of *J. curcas*' intolerance to frost, only small portions of the United States can be considered for cultivation. Areas with the most suitable climate conditions for cultivation can extend as far as 30° N in latitude; this would include the southern parts of Texas and Louisiana, and most of Florida.¹⁵⁶ Assuming no irrigation (as *J. curcas* is assumed to be a low-input crop), an absolute minimum of 500 mm of rainfall is required for substantial production, this occurs in the easternmost portions of Texas, and all of Louisiana and Florida.¹⁵⁷ The University of Florida has done some breeding and genetic manipulation of *J. curcas*, with the goal of increasing hardiness and tolerance to colder climates; no results have yet been published.¹⁵⁸

Table 1.1-22. Timeline (for US cultivation)^{159,160}

	Conservative projection	Optimistic projection
Test plantations	5-10 years	2-5 years
Commercialization	10-20 years	6 years

Cost data for US cultivation of *J. curcas* is not available. Because of high labor costs, the need to reuse seedcake as organic fertilizer (instead of selling it for further economic gain), and irrigation needs, *J. curcas* biodiesel production in the United States will likely may not be economic. Other countries with significantly lower labor costs may find it more economic to use jatropha as a biodiesel feedstock.

1.1.3.4.3 Jatropha Conclusions

It is unlikely that *Jatropha curcas* will be able to help the United States meet its energy needs in the future without disrupting current food crops, water resources, and other US interests. Currently active large projects to cultivate *J. curcas* around the world are based on very optimistic assumptions; many of the strong selling points of *J. curcas* a may not be valid under more reasonable assumptions. Still very little is known about the crop's sustainability impacts, its long-term yields, or its ability to be grown economically as a monoculture. Even under optimal conditions, jatropha yields are unlikely to be radically different from that of other conventional oil plants; thus, its possible impact on US energy supply is limited.

1.1.3.5 Algae

Microalgae are single-celled algae species that grow quickly and have high lipid content, and thus are a promising feedstock for biofuel production. While the majority of algae

companies are focusing on the use of algae for biodiesel production, it is important to note that algae can alternatively be used for producing ethanol or crude oil for gasoline or diesel which could also help contribute to the advanced biofuel mandate.^K Some of the benefits of using algae as a biofuel feedstock are that it:

- grows on marginal land,
- requires low water inputs,
- can recycle waste streams from other processes,
- does not compete with food production, and
- has high oil yield.

1.1.3.5.1 Algae Overview

Mass cultivation of microalgae has been ongoing since the 1950s for medical and pharmaceutical purposes. Since the 1980s, algae-to-biofuel research has been heavily funded by governments such as Japan, France, Germany and the United States. The research program in the US was especially large. The Aquatic Species Program, backed by the National Renewable Energy Laboratory, ran from 1978-1996 to look at the use of aquatic plants, specifically algae, as sources of energy. From about 1982 through the termination of the program, research concentrated on algae for biofuel production, specifically in open ponds.¹⁶¹ Two branches to research large scale algaculture systems were funded: the “High Rate Pond” and the “Algae Raceway Production System” from 1980 to 1987. By 1988 several large (1,000 m²) systems were designed and built at the “Outdoor Test Facility.”¹⁶² However, overall productivity of the ponds was lower than expected at around 10 grams algae / m² / day, due to cold temperatures and native species of algae taking over the ponds.

Recently, many small companies in the United States and Europe have begun developing processes for algae-to-biodiesel production, most notably, GreenFuel Technologies, Solazyme, LiveFuels, Solix Biofuels, and AlgaeLink.¹⁶³ Even large energy corporations have shown interest in algae development: Chevron, for example, has partnered with NREL to collaborate on research to produce transportation fuel using algae.¹⁶⁴

Microalgae, which can have a high mass percentage of triacylglycerols, or natural oils, can be cultivated using either of two methods. One method that is currently in use, and was studied widely by the Aquatic Species Program, involves using large, open ponds to grow algae; these are often called “raceway” ponds, as their shape is similar to an oval racetrack. They use a paddle wheel to keep the water in motion around the pond. The other method of algae cultivation utilizes closed “photobioreactors;” these are long, clear tubes through which the algae-water mixture flows. The mixture is still exposed to sunlight and CO₂ (through gas bubblers) but is shielded from contaminants that may occur in the environment.

After the algae are grown, the oil must still be extracted from the mixture. Usually this involves a dewatering process, to dry the algae, which is followed by an oil extraction process. The oil may be extracted using presses, expellers, or chemical processes. The triacylglycerols

^KAlgenol and Sapphire Energy, see <http://www.algenolbiofuels.com/> and <http://www.sapphireenergy.com/>

can then be processed into biodiesel by transesterification, a chemical process. The transesterification process is discussed further in section 1.4.4 of this document.

1.1.3.5.2 Algae Input and Cultivation

Because algae are marine species and can be grown wherever sufficient water is available, algaculture does not require fertile lands. While other oil crops such as soy, sunflower, rapeseed, and jatropha need large amounts of agricultural land in order to meet a sizable portion of US liquid fuel demand, algae do not displace agricultural crops.^{165,166,167} Algae grow most effectively in regions with high solar insolation, such as the US southwest, as discussed later.

When cultivated in enclosed photobioreactors, evaporation of water is limited, and water extracted during the drying process can be mostly reclaimed.¹⁶⁸ Even in open raceway-style ponds where evaporation is not negligible, water requirements are still considerably lower than with conventional agricultural crops. It is estimated that, in order to produce enough algal biomass for 60 billion gallon biodiesel/year, 20-120 trillion gallons of water/year are needed. This is several orders of magnitude lower than the 4,000 trillion gallon/year used to irrigate the entire US corn crop.¹⁶⁹ (This, if used exclusively for the production of conventional ethanol, would not reach the energy equivalent of 60 billion gallons of algae biodiesel).

Algae can also thrive in brackish water, with salt concentrations up to twice that of seawater, which is often available in saline groundwater aquifers in the southwest.^{170, 171} The salt, other minerals, and contaminants may pose a problem to the dewatering and extraction process, depending on the method used. However, this is a technical, not fundamental, issue with the use of saltwater. Thus, water usage is not a constraint and should not displace conventional crops, as no water currently used for conventional crops will need to be diverted to algae.^{172,173}

Aside from sunlight, algae require two main physical inputs for growth: CO₂ and nutrients.¹⁷⁴ These nutrients can be obtained from conventional fertilizers, or from domestic or industrial waste sources, such as farm refuse and manure.¹⁷⁵ Co-locating algae farms with animal husbandry, in order to directly use the manure as a nutrient, would reduce transportation costs.¹⁷⁶ In addition, both of these inputs can be obtained from waste streams from other energy processes. They can be coupled with coal-burning power plants or even ethanol plants, and can effectively recycle between 50% and 90% of flue gasses, depending on the size of the algae farm.^{177,178,179} The highly controlled environment of algae photobioreactors make them especially suitable to process and recycle CO₂ in flue gasses, as the gas can be bubbled or channeled into the water.¹⁸⁰ One study shows approximately 1,700 power plants in the United States have enough unused surrounding land to support a commercial-scale algae biofuel system.¹⁸¹ A more localized analysis of Arizona, one of the more promising algae cultivation states, only identified 7 coal-burning power plants suitable for co-location with algae farms.

1.1.3.5.3 Algae Yield

Certain species of algae can produce 80 percent of their body weight as oils, and oil levels of 20-50 percent are common.^{182,183} Thus, the projected outputs of algae farms are many

times higher than traditional farms, on the order of 30,000 to 130,000 liter oil/ha/yr, which can be processed into 27,600 to 119,600 liter biodiesel/ha/yr (2,950 to 12,780 gallons biodiesel/acre/yr).^{184,185,186,187,188} See Table 1.1-23, below.

Raceway systems are low-cost but have low productivity compared to photobioreactors. Most current research focuses on the photobioreactor system of cultivation for optimal pH, gas level, salinity, and temperature control, and to prevent contamination from invasive algae species.^{189,190} Photobioreactors also increase the concentration of algae in the water, by around 30 times, somewhat simplifying the dewatering process.¹⁹¹

Table 1.1-23. Potential Algae Yield (assuming photobioreactor system)^{192,193,194}

	Conservative projection	Optimistic projection
Oil	30,000 liter/ha/yr (3207 gals/acre)	130,000 liter/ha/yr (13898 gals/acre)
Biodiesel	28,000 liter/ha/yr (2993 gals/acre)	120,000 liter/ha/yr (12829 gals/acre)

1.1.3.5.4 Algae Timeline and Cost Projections

The projected timeline for commercial production of algae oil for biofuel varies depending on expert opinion. As shown in Table 1.1-24, some estimate as early as the next few years for algae biofuel to be produced at commercial scale.

Table 1.1-24. Algae Timeline^{195,196,197,198,199}

	Optimistic projection	Conservative projection
Commercialization	2-3 years	10 years

One company, AlgaeLink, has developed the first made-to-order industrial algae production facility in the world, though it is currently selling it at high cost.²⁰⁰ Also, a company called XL Renewables has developed an approach to use a potentially lower cost photobioreactor system for algae production.²⁰¹ Estimated costs are detailed in the Table 1.1-25, below.

Table 1.1-25. Algae Costs (assuming photobioreactor system)^{202,203}

	Conservative projection	Optimistic projection
Algae biomass	\$0.47/kg (\$0.21/pound)	\$0.05/kg (\$0.02/pound)
Oil (recovered; estimate)	\$2.80/liter (\$10.60/gallon)	\$0.20/liter (\$0.75/gallon)
Biodiesel	\$2.95/liter (\$11.17/gallon)	\$0.35/liter (\$1.32/gallon)

Concrete information about harvesting and oil extraction costs is not available, but may be up to 50% of the cost of recovered algae oil. Refining of algae oil into biodiesel will add roughly \$0.57/gallon.²⁰⁴ Thus, a large production facility of 10,000 tons algae biomass/year using current algaculture technology could produce algae oil at roughly \$10.60/gallon, and algae biodiesel at \$11.17/gallon under conservative projections. Assuming more optimistic projections, algae oil could be produced for \$0.75/gallon and biodiesel for \$1.32/gallon. In comparison, during 2006, the cheapest vegetable oil available (crude palm oil) cost roughly \$1.97/gallon, and palm oil biodiesel roughly \$2.50/gallon.

1.1.3.5.5 Possible U.S. Locations

The US southwest is the most promising location for economic algae-for-biofuel cultivation, due to its high solar insolation (see Figure 1.1-6), availability of saltwater aquifers, and relatively low current land use.^{205,206} Ideally, algae farms could be co-located with coal-burning power plants in order to recycle the carbon emissions and increase algae. However, although one study states that 1,700 power plants throughout the United States have enough surrounding land to support a commercial-scale algae system, only a limited number of these are in the southwest, due to lower population densities.²⁰⁷

Figure 1.1-6.
PV Solar Radiation in the United States

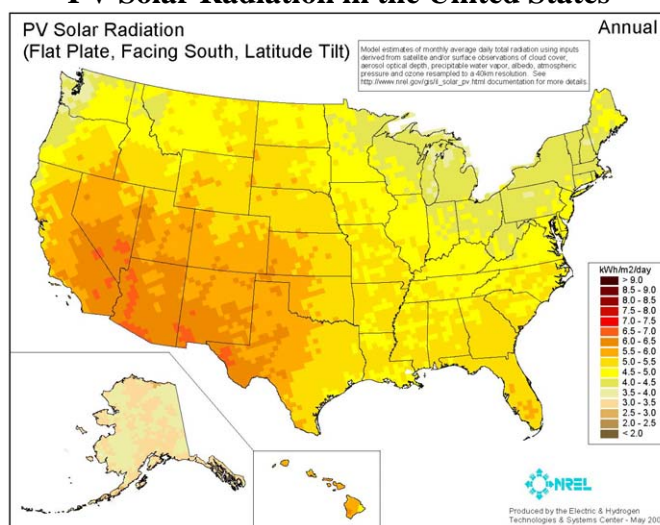

1.1.3.5.6 Algae Challenges

Unlike other feedstocks that have fundamental land use, water use, and yield/efficiency issues, the main problem facing future development of algae-to-biodiesel systems is underdeveloped technology and high cost. “Producing microalgal biomass is generally more expensive than growing crops.”²⁰⁸ The high cost is due mainly to the relative complexity of cultivation, harvesting, and oil extraction systems needed for algae, which translates to high capital and operating costs.^{209,210,211,212} “Economics of producing microalgal biodiesel need to improve substantially to make it competitive with petrodiesel, but the level of improvement necessary appears to be attainable.”²¹³ Specific technological hurdles include temperature control, dewatering methods and lipid extraction. Harvesting the algae is particularly difficult and energy intensive, but is made somewhat easier with photobioreactors, which yield higher algae concentrations in the water than open-ponds.

1.1.3.5.7 Algae Conclusions

Algae-to-biofuel production has significant potential because of high oil yields and

ability to be cultivated on marginal land. Indeed, algae could supply the United States as much as 60 billion gallons of biodiesel/year using a land area as small as 6 million acres (about 8% of Arizona's land area).²¹⁴ However, several technical hurdles must still be overcome, and costs must come down significantly, before algae are viable as a commercial biofuel feedstock.

1.1.3.6 Imported Biodiesel

In 2007, the EU produced 58 percent of worldwide biodiesel. Another 20 percent was produced in the U.S., with the remainder split between South America and the rest of the world.²¹⁵

In terms of historical production, EU biodiesel output increased from 200 million gallons in 2000 to almost 1,500 million gallons in 2007.²¹⁶ According to some analysts, however, the EU does not have the capacity to expand oilseed areas and in comparison to other climates, the climate in the EU is not particularly good for oilseed production.²¹⁷ Estimates for future EU biodiesel production appear to be roughly 2.5 billion gallons by 2017.²¹⁸

In addition to leading production, the EU is currently the largest market for biodiesel in the world, consuming around 700 million gallons in 2005. Biodiesel consumption in 2007 increased to approximately 1,800 million gallons.²¹⁹ Even with the increase in domestic production, however, it seems likely that the EU's future biofuels consumption goals will not be met.

In 2007, the European Commission (EC) proposed a binding minimum target requiring 10 percent biofuel use for transport by 2020.^{220,221} The International Energy Outlook forecasts OECD European countries will consume 147 billion gasoline gallons equivalent (gge) of transportation fuel in 2010, growing to 151 gge by 2020. Currently, approximately 60 percent of the EU's transportation fuel demand is met by diesel. Assuming this split continues in the future, a 10 percent biofuel requirement would translate to roughly 8 billion gallons of biodiesel demand by 2017. Thus, it appears likely that the EU will not be able to produce enough biodiesel to meet its goals by 2020 and will need to depend on other countries to make up the remaining 5.8 billion gallon demand (after accounting for domestic production of 2.2 billion gallons as estimated from above). So not only will the EU, the largest current producer of biodiesel, not have any biodiesel available for export in the future; they will likely be a net importer competing with the U.S. for surplus biodiesel supplies.

As imports of finished biodiesel (or biodiesel feedstocks) are relatively new in the U.S. domestic market, volumes are currently small and not well-tracked by industry groups and EIA. Therefore, there is limited historical data from which to better understand the U.S.'s position to import biodiesel. Alternatively, in order to answer these questions, we analyzed the following countries that have been noted as having a large potential for producing biodiesel: Brazil, Malaysia, Indonesia, and India.

Currently, there is a large interest in Brazil to develop a strong biodiesel program. As Brazil has mandates of B2 by 2008 and B5 by 2013 much of its production of biodiesel will be consumed domestically before any biodiesel will be available for exports.²²² If the mandates as

well as Brazil's biodiesel production goals are met, this would mean that approximately 500 million gallons could be available for exports by 2010 and around 600 million gallons by 2020.²²³ Although this is a relatively large amount compared to what is produced today, this volume is still not enough to meet all of the EU's demand for biodiesel. Therefore, the amount of biodiesel exported from Brazil will likely be split among those countries demanding biodiesel, with the amount allocated to the U.S. uncertain at this point in time.

We also analyzed the biodiesel situation in the top two world producers of palm oil, Malaysia and Indonesia. Although Malaysia and Indonesia have a large potential for biodiesel production from palm oil, these countries appear to be marketing their exports to European and Asian nations as well as implementing their own biofuels goals. In fact, Malaysia is anticipating biodiesel export opportunities in the European market and is expected to export biodiesel specifically to Europe in the range of 100-120 million gallons by 2010.²²⁴ This volume is still relatively small in comparison to the production of biodiesel in the U.S. from domestic sources. The prospect for Indonesian palm oil biodiesel is similar as most Indonesian exports of biodiesel are to China and other Asian markets.

As far as mandates are concerned, Malaysia is planning on introducing a B5 mandate which could demand up to 166 million gallons of biodiesel.²²⁵ Indonesia has a smaller mandate of B2.5, as a decline in fossil fuel prices and the increase in crude palm oil prices resulted in the decrease from its original B5 mandate.²²⁶ In fact, historically, palm oil prices have been lower than soybean and rapeseed oil, suggesting that the use of palm oil could be the most cost-effective.²²⁷ However, in 2006, palm oil prices began to track soybean and rapeseed oil prices.²²⁸ Since feedstock costs make up the largest portion of production costs for biodiesel, this suggests that the production of biodiesel may not be profitable if palm oil prices remain high. With Malaysia and Indonesia's eyes set on importing biodiesel to the EU and Asian nations, possible biodiesel mandates in the future, and increases in palm oil feedstock costs, it seems unlikely that the U.S. will receive large volumes of biodiesel from this part of the world.

As described above, another potential source of biofuel feedstock is jatropha. Although the potential for India to produce biodiesel from jatropha is large, there are still great uncertainties as to whether India can meet even its own biodiesel goals (i.e., B20 by 2020)²²⁹, let alone the goals of other nations. Historically, India has neither imported nor exported bio-fuels for fuel purposes, nor does the government provide any financial assistance for these products. Thus, India's lack of experience in transporting large volumes of biofuels to other nations may limit how much is available internationally. Given that large-scale cultivation of jatropha has yet to be seen, and that jatropha has unpredictable yields, it seems unlikely that India could provide large volumes of biodiesel to the U.S.²³⁰

Our analysis of the countries with the most potential to produce and consume biodiesel in the future suggests that there will be very limited supplies of biodiesel available to the US from other nations. Supplies to the U.S. will be limited by factors such as mandates and goals of other countries, preferential shipment of biodiesel to European and Asian nations, and how quickly non-traditional crops such as jatropha can be developed. Thus, we are estimating that there will be negligible amounts of biodiesel available to the U.S. in the future.

1.1.3.7 Biodiesel Feedstock Summary

**Table 1.1-26.
Estimated 2022 Potential Biodiesel & Renewable Diesel Volumes
Based on Feedstock Availability (million gallons of fuel)**

	Biomass-based diesel		Other advanced biofuel		Totals	
	From FASOM	Outside FASOM	From FASOM	Outside FASOM	From FASOM	Outside FASOM
Soy oil	551				551	
Corn oil (food grade)	109				109	
Corn oil (fractionation)		150				150
Etallow	14		14		28	
NonETallow	29		29		57	
Lard	26		26		52	
YGrease	94		94		188	
Poultry fat		25		25		50
Subtotals	823	175	163	25	985	200
Totals		998		188		1,185

1.2 RFS2 Biofuel Volumes

Our assessment of the renewable fuel volumes required to meet the Energy Independence and Security Act (EISA) necessitates establishing a primary set of fuel types and volumes on which to base our assessment of the impacts of the new standards. EISA contains four broad categories: cellulosic biofuel, biomass-based diesel, total advanced biofuel, and total renewable fuel. As these categories could be met with a wide variety of fuel choices, in order to assess the impacts of the rule, we projected a set of reasonable renewable fuel volumes based on our interpretation at the time we began our analysis of likely fuels that could come to market.

The following subsections detail our rationale for projecting the amount and type of fuels needed to meet EISA. For cellulosic biofuel we have assumed that the entire volume will be domestically produced cellulosic ethanol. Biomass-based diesel is assumed for our analyses to be comprised of a majority of fatty-acid methyl ester (FAME) biodiesel and a smaller portion of non-co-processed renewable diesel. Subsequent to the analyses being conducted, our lifecycle analysis was completed showing that biomass-based diesel from soy oil failed to meet the 50% GHG threshold. The analyses contained in this DRIA are still based on the presumption that soy and other virgin plant oils used for biodiesel would qualify as biomass-based diesel. Adjustments in the analysis will be conducted for the FRM. The portion of the advanced biofuel category not met from cellulosic biofuel and biomass-based diesel is assumed to come mainly from imported (sugarcane) ethanol with a smaller amount from co-processed renewable diesel. The total renewable fuel volume not required to be comprised of advanced biofuels is assumed to be met with corn ethanol.

In addition, the following subsections also describe other fuels that have the potential to contribute to meeting EISA, but because of their uncertainty of use, or because their use likely might be negligible we have chosen to not assume any use for our analysis. Examples of these types of renewable fuels or blendstocks include bio-butanol, biogas, cellulosic diesel, cellulosic gasoline, biofuel from algae, jatropha, or palm, imported cellulosic ethanol, other biomass-to-liquids (BTL), and other alcohols or ethers.

1.2.1 Cellulosic Biofuel

As defined in EISA, cellulosic biofuel means renewable fuel produced from any cellulose, hemicellulose, or lignin that is derived from renewable biomass and that has lifecycle greenhouse gas emissions, as determined by the Administrator, that are at least 60% less than the baseline lifecycle greenhouse gas emissions.

When many people think of cellulosic biofuel, they immediately think of cellulosic ethanol. However, cellulosic biofuel could be comprised of other alcohols synthetic gasoline, synthetic diesel fuel, and synthetic jet fuel, propane, and biogas. Whether cellulosic biofuel is ethanol will depend on a number of factors, including production costs, the form of tax subsidies, credit programs, and issues associated with blending the biofuel into the fuel pool. It will also depend on the relative demand for gasoline and diesel fuel. For instance, European refineries have been undersupplying the European market with diesel fuel supply and oversupplying it with gasoline, and based on the recent diesel fuel price margins over gasoline, it seems that the U.S. is falling in line with Europe. Therefore, if the U.S. trend is toward being relatively oversupplied with gasoline, there could be a price advantage towards producing renewable fuels that displace diesel fuel rather than a gasoline fuel replacement like ethanol.

Current efforts in converting cellulosic feedstocks into fuels focus on biochemical and thermochemical conversion processes. In terms of production costs, at least for the main technologies of focus, neither biochemical nor thermochemical platforms (comparing enzymatic biochemical processing to ethanol and thermochemical processing to cellulosic diesel) appear to have clear advantages in capital costs or operating costs.²³¹ We further discuss these technologies in Section 1.4 of the DRIA, while feedstock and production costs are discussed in Chapter 4 of the DRIA. The economic competitiveness of cellulosic biofuels will also depend on the extent of financial support from the government. Under the Farm Bill of 2008, both cellulosic ethanol and cellulosic diesel receive the same tax subsidies (\$1.01 per gallon each). The tax subsidy, however, gives ethanol producers a considerable advantage over those producing cellulosic diesel due to the feedstock quantity needed per gallon produced (i.e. typically the higher the energy content of the product, the more feedstock that is required). On an energy basis, cellulosic ethanol would receive approximately \$13/mmBtu while cellulosic diesel would receive approximately \$8/mmBtu. In a similar manner, if we were to finalize our co-proposal for Equivalence Values such that they are generated based on volume rather than energy content, this would likewise provide an advantage for the production of cellulosic ethanol over cellulosic diesel.

One large advantage that cellulosic diesel has over ethanol is the ability for the fuel to be blended easily into the current distribution infrastructure at sizeable volumes. There are currently factors tending to limit the amount of ethanol that can be blended into the fuel pool (see Section 1.7. of the DRIA for more discussion). Thus, the production of cellulosic diesel instead of cellulosic ethanol could help increase consumption of renewable fuels.

Thus, there is uncertainty as to which mix of cellulosic biofuels will be produced to fulfill the 16 Bgal mandate by 2022. The latest release of AEO 2009, for example, estimates a mixture of cellulosic diesel and ethanol produced for cellulosic biofuel. For assessing the impacts of the

RFS2 standards, we made the simplifying assumption that cellulosic biofuel would only consist of ethanol, though market realities may also result in cellulosic diesel and other products.

Cellulosic biofuel could also be produced internationally. One example of internationally produced cellulosic biofuel is ethanol produced from bagasse or straw from sugarcane processing in Brazil. Currently, Brazil burns bagasse to produce steam and generate bioelectricity. However, improving efficiencies over the coming decade may allow an increasing portion of bagasse to be allocated to other uses, including cellulosic biofuel, as the demand for bagasse for steam and bioelectricity could remain relatively constant.

One recent study assessed the biomass feedstock potential for selected countries outside the United States and projected supply available for export or for biofuel production.^{L,232} For the study's baseline projection in 2017, it was estimated that approximately 21 billion ethanol-equivalent gallons could be produced from cellulosic feedstocks at \$36/dry tonne or less. The majority (~80%) projected is from bagasse, with the rest from forest products. Brazil was projected to have the most potential for cellulosic feedstock production from both bagasse and forest products. Other countries including India, China, and those belonging to the Caribbean Basin Initiative (CBI) also have some potential although much smaller feedstock supplies are projected as compared to Brazil. Although international production of cellulosic biofuel is possible, it is uncertain whether this supply would be available primarily to the U.S. or whether other nations would consume the fuel domestically. Therefore, for our analyses we have chosen to assume that all the cellulosic biofuel used to comply with RFS2 would be produced domestically.

1.2.2 Biomass-Based Diesel

Biomass-based diesel as defined in EISA means renewable fuel that is biodiesel as defined in section 312(f) of the Energy Policy Act of 1992 with lifecycle greenhouse gas emissions, as determined by the Administrator, that are at least 50% less than the baseline lifecycle greenhouse gas emissions.^M Biomass-based diesel can include fatty acid methyl ester (FAME) biodiesel, renewable diesel (RD) that has not been co-processed with a petroleum feedstock, as well as cellulosic diesel. Although cellulosic diesel produced through the Fischer-Tropsch (F-T) process or other processes could potentially contribute to the biomass-based diesel category, we have assumed for our analyses that the fuel and its corresponding feedstocks (cellulosic biomass) are already accounted for in the cellulosic biofuel category as discussed in the previous Section 1.2.1.

FAME and RD processes can make acceptable quality fuel from vegetable oils, fats, and greases, and thus will generally compete for the same feedstock pool. For our analyses, we have assumed that the volume contribution from FAME biodiesel and RD will be a function of the available feedstock types. For our analysis we assumed that virgin plant oils would be

L Countries evaluated include Argentina, Brazil, Canada, China, Colombia, India, Mexico, and CBI

^M Subsequent to the analyses being conducted, our lifecycle analysis was completed showing that biomass-based diesel from soy oil failed to meet the 50% GHG threshold. The analyses contained in this DRIA are still based on the presumption that soy and other virgin plant oils used for biodiesel would qualify as biomass-based diesel. Adjustments in the analysis will be conducted for the FRM.

preferentially processed by biodiesel plants, while the majority of fats and greases would be routed to RD production.^{N,O} This is because the RD process involves hydrotreating (or thermal depolymerization), which is more severe and uses multiple chemical mechanisms to reform the fat molecules into diesel range material. The FAME process, by contrast, relies on more specific chemical mechanisms and requires pre-treatment if the feedstocks contain more than trace amounts of free fatty acids or other contaminants which are typical of recycled fats and greases. In terms of volume availability of feedstocks, supplies of fats and greases are more limited than virgin vegetable oils. As a result, our control case assumes the majority of biomass-based diesel volume is met using biodiesel facilities processing vegetable oils, with RD making up a smaller portion and using solely fats and greases.

The RD production volume must be further classified as co-processed or non-co-processed, depending on whether the renewable material was mixed with petroleum during the hydrotreating operations (more details on this definition are in Section III.B.1 of the preamble). EISA specifically forbids co-processed RD from being counted as biomass-based diesel, but it can still count toward the total advanced biofuel requirement. What fraction of RD will ultimately be co-processed is uncertain at this time, since little or no commercial production of RD is currently underway, and little public information is available about the comparative economics and feasibility of the two methods. We assumed in our control case that half the material will be non-co-processed and thus qualify as biomass-based diesel.

We assumed that all biomass-based diesel would be produced from soy oil, corn oil, tallow, lard, yellow grease, and poultry fats. In the future, however, other feedstocks such as algae and jatropha may develop as discussed previously in Section 1.1 of the DRIA.

1.2.3 Other Advanced Biofuel

As defined in EISA, advanced biofuel means renewable fuel, other than ethanol derived from corn starch, that has lifecycle greenhouse gas emissions, as determined by the Administrator, that are at least 50% less than baseline lifecycle greenhouse gas emissions. As defined in EISA, advanced biofuel includes the cellulosic biofuel, biomass-based diesel, and co-processed renewable diesel categories that were mentioned in Section 1.2.1 and Section 1.2.2 above. However, EISA requires greater volumes of advanced biofuel than just the volumes required of these fuels. It is entirely possible that greater volumes of cellulosic biofuel, biomass-based diesel, and co-processed renewable diesel than required by the Act could be produced in the future. Our control case, however, does not assume that cellulosic biofuel and biomass-based diesel volumes will exceed those required under EISA.^P As a result, to meet the total advanced biofuel volume required under EISA, advanced biofuel types are needed other than cellulosic biofuel, biomass-based diesel, and co-processed renewable diesel through 2022.

^N Recent changes to federal tax subsidies and market shifts may warrant changes to this assumption. We will reevaluate the relative production volumes of biodiesel and renewable diesel for the FRM.

^O This analysis was conducted prior to the completion of our lifecycle analysis and assumes the fuels will meet the required GHG threshold

^P While cellulosic biofuel will not be limited by feedstock availability, it likely will be limited by the very aggressive ramp up in production volume for an industry which is still being demonstrated on the pilot scale and therefore is not yet commercially viable. On the other hand, biomass-based diesel derived from agricultural oils and animal fats are faced with relatively high feedstock costs which limit feedstock supply.

We have assumed for the analyses conducted that for our control case the most likely source of advanced fuel other than cellulosic biofuel, biomass-based diesel, and co-processed renewable diesel would be from imported sugarcane ethanol. Our assessment of international fuel ethanol production and demand indicate that anywhere from 3.8-4.2 Bgal of sugarcane ethanol from Brazil could be available for export by 2020/2022. If this volume were to be made available to the U.S., then there would be sufficient volume to meet the advanced biofuel standard. To calculate the amount of imported ethanol needed to meet the EISA standards, we took the difference between the total advanced biofuel category and cellulosic biofuel, biomass-based diesel, and co-processed renewable diesel categories. The amount of imported ethanol required by 2022 is approximately 3.2 Bgal. Refer to Section 1.5.2 for a more detailed discussion on imported ethanol.

Recent news indicates that there are also plans for sugarcane ethanol to be produced in the U.S in places where the sugar subsidy does not apply. For instance, sugarcane has been grown in California's Imperial Valley specifically for the purpose of making ethanol and using the cane's biomass to generate electricity to power the ethanol distillery as well as export excess electricity to the electric grid.^Q There are at least two projects being developed at this time that could result in several hundred million gallons of ethanol produced. The sugarcane is being grown on marginal and existing cropland that is unsuitable for food crops and will replace forage crops like alfalfa, Bermuda grass, Klein grass, etc. Harvesting is expected to be fully mechanized. Thus, there is potential for these projects and perhaps others to help contribute to the EISA biofuels mandate. This could lower the volume needed to be imported from Brazil.

Butanol is another potential motor vehicle fuel which could be produced from biomass and used in lieu of ethanol to comply with the RFS2 standard. Production of butanol is being pursued by a number of companies including a partnership between BP and Dupont. Other companies which have expressed the intent to produce biobutanol are Baer Biofuels and Gevo. The near term technology being pursued for producing butanol involves fermentation of starch compounds, although it can also be produced from cellulose. Butanol has several inherent advantages compared to ethanol. First, it has higher energy density than ethanol which would improve fuel economy (mpg). Second, butanol is much less water soluble which may allow the butanol to be blended in at the refinery and the resulting butanol-gasoline blend then more easily shipped through pipelines. This would reduce distribution costs associated with ethanol's need to be shipped separately from its gasoline blendstock and also save on the blending costs incurred at the terminal. Third, butanol can be blended in higher concentrations than 10% which would likely allow butanol to be blended with gasoline at high enough concentrations to avoid the need for most or all of high concentration ethanol-gasoline blends, such as E85, that require the use of fuel flexible vehicles. For example, because of butanol's lower oxygen content, it can be blended at 16% (by volume) to match the oxygen concentration of ethanol blended at 10% (by volume). Because of butanol's higher energy density, when blending butanol at 16% by volume, it is the renewable fuels equivalent to blending ethanol at about 20%. Thus, butanol would enable achieving most of the RFS2 standard by blending a lower concentration of renewable fuel than having to resort to a sizable volume of E85 as in the case of ethanol. The need to blend

^Q Personal communication with Nathalie Hoffman, Managing Member of California Renewable Energies, LLC, August 27, 2008

ethanol as E85 provides some difficult challenges. The use of butanol may be one means of avoiding these blending difficulties.

At the same time, butanol has a couple of less desirable aspects relative to ethanol. First, butanol is lower in octane compared to ethanol – ethanol has a very high blending octane of around 115, while butanol’s octane ranges from 87 octane numbers for normal butanol and 94 octane numbers for isobutanol. Potential butanol producers are likely to pursue producing isobutanol over normal butanol because of isobutanol’s higher octane content. Higher octane is a valuable attribute of any gasoline blendstock because it helps to reduce refining costs. A second negative property of butanol is that it has a much higher viscosity compared to either gasoline or ethanol. High viscosity makes a fuel harder to pump, and more difficult to atomize in the combustion chamber in an internal combustion engine. The third downside to butanol is that it is more expensive to produce than ethanol, although the higher production cost is partially offset by its higher energy density.

Another potential source of renewable transportation fuel is biomethane refined from biogas. Biogas is a term meaning a combustible mixture of methane and other light gases derived from biogenic sources. It can be combusted directly in some applications, but for use in highway vehicles it is typically purified to closely resemble fossil natural gas for which the vehicles are typically designed. The definition of biogas as given in EISA is sufficiently broad to cover combustible gases produced by biological decomposition of organic matter, as in a landfill or wastewater treatment facility, as well as those produced via thermochemical decomposition of biomass.

Currently, the largest source of biogas is landfill gas collection, where the majority of fuel is combusted to generate electricity, with a small portion being upgraded to methane suitable for use in heavy duty vehicle fleets. Current literature suggests approximately 16 billion gasoline gallons equivalent of biogas (referring to energy content) could potentially be produced in the long term, with about two thirds coming from biomass gasification and about one third coming from waste streams such as landfills and human and animal sewage digestion.^{233, 234}

Because the majority of the biogas volume estimates assume biomass as a feedstock, we have chosen not to include this fuel in our analyses since we are projecting most available biomass will be used for cellulosic liquid biofuel production in the long term. The remaining biogas potentially available from waste-related sources would come from a large number of small streams requiring purification and connection to storage and/or distribution facilities, which would involve significant economic hurdles. An additional and important source of uncertainty is whether there would be a sufficient number of vehicles configured to consume these volumes of biogas. Thus, we expect future biogas fuel streams to continue to find non-transportation uses such as electrical power generation or facility heating.

1.2.4 Other Renewable Fuel

The remaining portion of total renewable fuel not met with advanced biofuel is assumed to come from corn-based ethanol. The Act essentially sets a limit for participation in the RFS program of 15 Bgal of corn ethanol by 2022. It should be noted, however, that there is no

specific “corn-ethanol” mandated volume, and that any advanced biofuel produced above and beyond what is required for the advanced biofuel requirements could reduce the amount of corn ethanol needed to meet the total renewable fuel standard. This occurs in our projections during the earlier years (2009-2014) in which we project that some fuels could compete favorably with corn ethanol (e.g. biodiesel and imported ethanol). Beginning around 2015, fuels qualifying as advanced biofuels likely will be devoted to meeting the increasingly stringent volume mandates for advanced biofuel. It is also worth noting that more than 15 Bgal of corn ethanol could be produced and RINs generated for that volume under our proposed RFS2 regulations. However, obligated parties would not be required to purchase more than 15 Bgal worth of corn ethanol RINs.

We are assuming for our analysis that sufficient corn ethanol will be produced to meet the 15 Bgal limit. However, this assumes that in the future corn ethanol production is not limited due to environmental constraints, such as water quantity issues (see Section 6.10 of this DRIA). This also assumes that in the future either corn ethanol plants are constructed or modified to meet the 20% GHG threshold, or that sufficient corn ethanol production exists that is grandfathered and not required to meet the 20% threshold. Our current projection is that up to 15 Bgal could be grandfathered, but actual volumes will be determined at the time of facility registration. Refer to Section 1.5.1.4 for more information. Since our current lifecycle analysis estimates that much of the current corn ethanol would not meet the 20% GHG reduction threshold required of non-grandfathered facilities without facility upgrades, then if actual grandfathered corn volumes are less than 15 Bgal it may be necessary to meet the volume mandate with other renewable fuels or through the use of advanced technologies that could improve the corn ethanol lifecycle GHG estimates.

1.2.5 Control Case for Analyses

Table 1.2-1 summarizes the fuel types used for the control case and their corresponding volumes for the years 2009-2022.

**Table 1.2-1.
Control Case Projected Renewable Fuel Volumes (billion gallons)**

Year	Advanced Biofuel					Non-Advanced Biofuel	Total Renewable Fuel
	Cellulosic Biofuel	Biomass-Based Diesel ^a		Other Advanced Biofuel			
	Cellulosic Ethanol	FAME ^b Biodiesel	Non-Co-processed Renewable Diesel	Co-processed Renewable Diesel	Imported Ethanol	Corn Ethanol	
2009	0.00	0.50	0.00	0.00	0.50	9.85	10.85
2010	0.10	0.64	0.01	0.01	0.29	11.55	12.60
2011	0.25	0.77	0.03	0.03	0.16	12.29	13.53
2012	0.50	0.96	0.04	0.04	0.18	12.94	14.66
2013	1.00	0.94	0.06	0.06	0.19	13.75	16.00
2014	1.75	0.93	0.07	0.07	0.36	14.40	17.58
2015	3.00	0.91	0.09	0.09	0.83	15.00	19.92
2016	4.25	0.90	0.10	0.10	1.31	15.00	21.66
2017	5.50	0.88	0.12	0.12	1.78	15.00	23.40
2018	7.00	0.87	0.13	0.13	2.25	15.00	25.38
2019	8.50	0.85	0.15	0.15	2.72	15.00	27.37
2020	10.50	0.84	0.16	0.16	2.70	15.00	29.36
2021	13.50	0.83	0.17	0.17	2.67	15.00	32.34
2022	16.00	0.81	0.19	0.19	3.14	15.00	35.33

^aBiomass-Based Diesel includes FAME biodiesel, cellulosic diesel, and non-co-processed renewable diesel.

^bFatty acid methyl ester (FAME) biodiesel

We needed to make this projection soon after EISA was signed to allow sufficient time to conduct our long lead-time analyses. As a result, we used the same ethanol-equivalence basis for these projections as was used in the RFS1 rulemaking. However, as described in Section III.D.1 of the preamble, we are also co-proposing that volumes of renewable fuel be counted on a straight gallon-for-gallon basis under RFS2, such that all Equivalence Values would be 1.0. While the control case volumes used as the basis for our analyses do not reflect this approach to Equivalence Values, the net effect on projected volumes is very small; instead of 36 billion gallons of renewable fuel in 2022, our control case includes 35.3 billion gallons. We do not believe that this difference will substantively affect the analyses that are based on our projected control case volumes.

1.2.6 Construction Feasibility for Cellulosic Ethanol Industry

Start-up of cellulosic ethanol plants is expected to begin in earnest with a few small plants in 2010-11, followed by addition of industry capacity continuing at an increasing pace due to more plant starts per year as well as increasing plant size. This is typical as an industry progresses up the learning curve, and investors become more confident and are willing to fund larger, more efficient plants. During the period from 2010-12, we also expect a slowing of starch ethanol plant construction, such that engineering and construction personnel and equipment fabricators would potentially be able to transition to work on cellulosic ethanol facilities.

Here we examine the build rate required to construct cellulosic plants in time to meet the standards in Table 1.2-1, and we compare this to the historic build rate of capacity in the starch ethanol industry. Figure 1.2-1 depicts these construction trends.

**Figure 1.2-1.
Historic and projected U.S. ethanol production trends 2001-2022.**

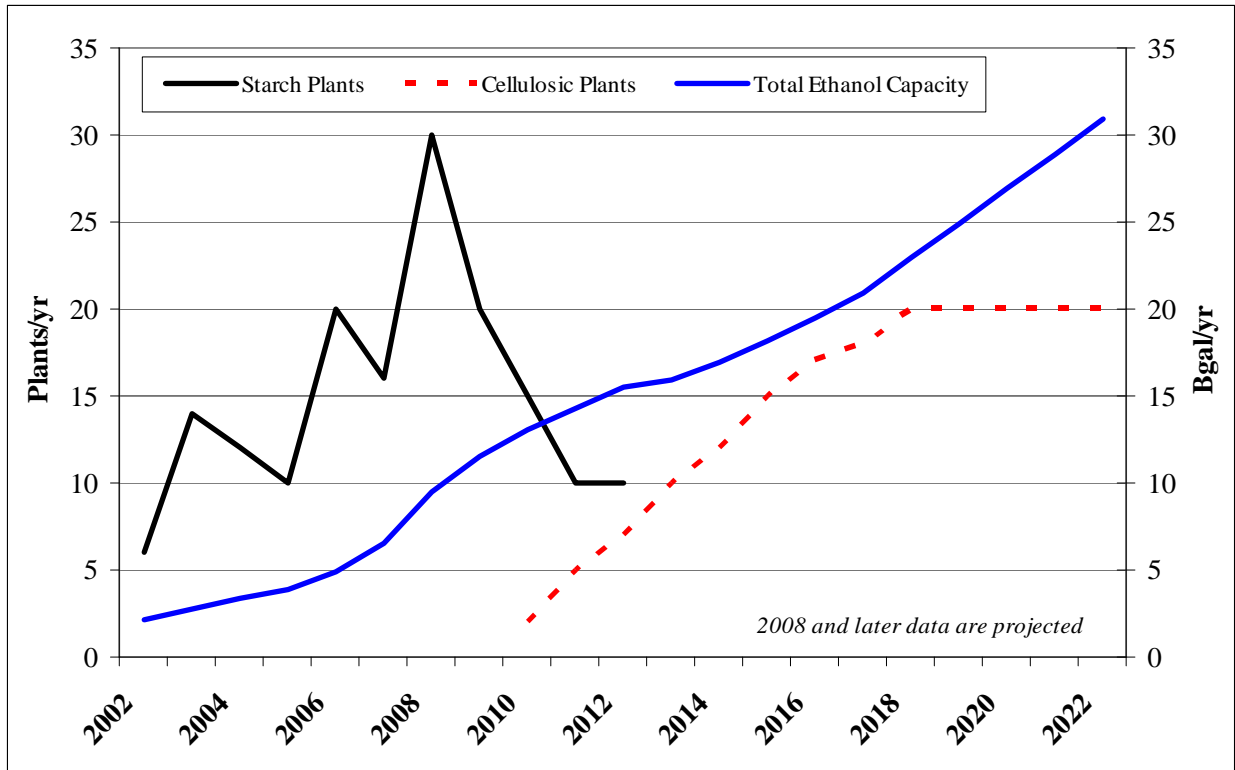

Historical plant build rates for starch ethanol were derived from figures in Chapter 1.5 of this DRIA (see Figure 1.5-1). Average plant capacity figures were estimated from existing capacity and plant counts, and we project that the recent trend toward larger plant sizes continues going forward. Approximately 200 starch ethanol plants are expected to be operating by 2022.

For cellulosic ethanol plant construction, we assumed new plant size would begin relatively small at 40 million gal/yr for 2010-13, increasing to 80 million gal/yr for 2014-17, and 100 million gal/yr afterwards. Given the volume standards laid out in the EISA, as well as the number of cellulosic ethanol plants projected in Chapter 1.5 to be roughly 180 by 2022 (see Table 1.5-36), we arrive at a maximum required build rate of approximately 2 billion gal/yr from 2018-2022. This is similar to the rate of starch ethanol construction in recent years. Table 1.2-2 shows a summary of the figures used in the analysis.

Table 1.2-2.
Summary of figures used in the ethanol plant construction rate analysis 2001-2022.

Year	Starch Ethanol				Cellulosic Ethanol			
	Build Rate	Avg Plant Capacity	Capacity Change	Industry Capacity	Build Rate	Avg Plant Capacity	Capacity Change	Industry Capacity
	<i>Plants/yr</i>	<i>Mgal/yr</i>	<i>Bgal/yr</i>	<i>Bgal/yr</i>	<i>Plants/yr</i>	<i>Mgal/yr</i>	<i>Bgal/yr</i>	<i>Bgal/yr</i>
2001				1.8				
2002	6	50	0.3	2.1				
2003	14	50	0.7	2.8				
2004	12	50	0.6	3.4				
2005	10	50	0.5	3.9				
2006	20	50	1.0	4.9				
2007	16	100	1.6	6.5				
2008	27	100	2.7	9.2				
2009	20	100	2.0	11.2				
2010	15	100	1.5	12.7	2	40	0.1	0.1
2011	10	100	1.0	13.7	5	40	0.2	0.3
2012	8	100	0.8	14.5	7	40	0.3	0.6
2013	5	100	0.5	15.0	10	40	0.4	1.0
2014				15.0	12	80	1.0	1.9
2015				15.0	15	80	1.2	3.1
2016				15.0	17	80	1.4	4.5
2017				15.0	18	80	1.4	5.9
2018				15.0	20	100	2.0	7.9
2019				15.0	20	100	2.0	9.9
2020				15.0	20	100	2.0	11.9
2021				15.0	20	100	2.0	13.9
2022				15.0	20	100	2.0	15.9

This work suggests that it may be feasible to construct plants quickly enough to meet the standard if plant starts can reach a rate as high as for starch ethanol in recent years. While cellulosic plant technology is still developing, it is expected that the plants will be considerably more complex and expensive to construct than the starch ethanol plants being built today. Therefore, we believe the market will need to react even more quickly with capital funding, as well as design and construction resources.

1.3 Agricultural Residue Harvesting, Storage & Transport

The amount of agricultural residue that can be removed is limited by how much residue must be left on the field to maintain soil health and by the mechanical efficiency (inefficiency) of the harvesting operation. We have already discussed sustainable removal rates in Section 1.1 and will discuss the technical challenges related to the harvesting, storage, and transport of agricultural residues in the following sections.

1.3.1 Harvesting Technologies

The amount of residue that can be harvested from any one field is dependent on the combined mechanical inefficiencies of the harvesting operation and on the health of the soil.

Even if 100% of the residue could be removed, from a soil health perspective, the mechanical inefficiencies of the harvest operation make it impossible to remove that much residue. A controlling principle is that increasing amounts of dry matter are lost as the stover is handled by increasing numbers of different machines.

Corn stover harvest, at present, requires multiple machines: combines, shredders, rakes, balers, bale wagons, and stackers just to get the stover bales to the side of the field; dry matter is lost during each operation. Currently, there are no harvesting machines designed specifically for residue harvest, other than perhaps, for small grain straws that use common hay equipment. One proposal for corn stover harvest is to shut the spreader off on the grain combine in order to form a windrow, of sorts, following which the windrow is baled.²³⁵ However, modern combines leave most of the stalk standing. In order to harvest as much of the stover as possible, it is necessary to shred the standing stalks and then rake all of it together prior to baling.²³⁶ The baler pickup must be set high enough to avoid picking up dirt and dirt clods, the dirt-particles from which are very hard on harvesting equipment and that would demand a cleanup stage in downstream processing, which of itself would translate into overall dry matter losses. As such, it is likely that the baler will leave some amount of stover.

Small grain straws, such as those from wheat, oats, barley, and rice have been harvested for many years. A significant difference between the harvesting equipment used for corn stover and these grains, is that the small grain plant is cut off near the ground and passes through the combine at the time of harvest. It falls to the ground from the harvester into somewhat of a windrow; in some cases, the windrow may need to be raked together before baling to gain maximum removal efficiency. Since the whole grain plant had dried prior to harvest, it's not necessary to wait for the straw to dry before it's baled. Small grain straws can be baled, hauled, and stacked in standard small bales or in larger 3' x 4' x 8' square bales with current hay equipment.

Sugarcane bagasse is not harvested, in the sense we've discussed 'a harvest.' It is a byproduct of sugar production from sugarcane, delivered by truck and trailer from the sugar processing facility to the ethanol plant.

We anticipate that by 2022, the corn stover harvest will actually be reduced to a single-pass operation during which the amount of residue left on the field will be less a function of harvest efficiency and more a function of the farmer/grower and the harvesting company being able to determine how much residue must be left to maintain soil health. A combine designed specifically for the job must still be constructed, but we expect that it will cut the whole stalk a few inches above the soil, leaving some stalk anchored to the ground. A single-pass harvester could cut the entire plant a few inches above the ground and pull all of it, e.g., stalks, leaves, cobs, and grain into the combine, where they become a single, mixed grain and stover stream. The harvester blows the entire stream into tractor-pulled grain-carts that run along-side the harvester. When a cart is filled, it is replaced by an empty cart, and the full cart is hauled to the field side, where it's unloaded into bulk 'walking-floor' semi trailers, and hauled to a co-op or depot type elevator/facility for further processing and storage. At the elevator, the stover/grain mix is unloaded into equipment for further processing before it's sent to storage. Although a facility (equipment, buildings, etc.) at an elevator for separating the corn grain from the stover

has not been constructed, we anticipate that it could operate very much like a modern grain harvester/combine, except it will obviously be stationary. The entire stream could be fed, by chain or belt, where it drops between a cylinder covered with rough steel bars and a piece of equipment called a concave. As the cobs are rubbed between the steel bars and concave, the corn grain rubs off and drops onto a perforated belt; most of the stover remains are larger than corn grain pieces, and is moved rearward toward the spreader. The corn grain and small stover particle fall through and are carried to a chaffer.

One of the issues yet to be solved is how the proper quantity of residue required for soil maintenance is either left on or returned to the field and how it will be evenly spread. This of course could add another operation or two and would likely require heavy equipment to travel on fields, which would undoubtedly exacerbate compaction problems. We don't anticipate any major future changes in the way the small grain straws will be harvested.

1.3.2 Feedstock Storage

We expect corn stover bales and small grain straw bales will be stored in similar ways. There has been some discussion about storing bales (of any of the feedstocks) out in the open, on gravel; few suggest storing them on dirt. Large, round stover bales store better in the open than large square bales, in that rain and particularly snow collect on flat surfaces more readily than on round. Another important issue that impacts whether round or square bales are used is that round bales can usually be stacked only three-bales high, in a kind of pyramid-shaped stack. One result of stacking round bales higher is that because of the low bale density, they tend to deform and the stack becomes unstable and there is an increased chance of dry matter loss. Square bales can be stacked as many as five-high and remain stable.

As discussed in Section 1.3.1, we anticipate that the stover harvest could become a single-pass operation. Equipment at the elevator/depot separates the stover from the grain, following which the stover is chopped and dried. This distributed preprocessing facility can provide significant cost benefits by producing a higher value feedstock with improved handling, transporting, and merchandising potential. In addition, data supporting the preferential deconstruction of feedstock materials due to their bio-composite structure identifies the potential for significant improvements in equipment efficiencies and compositional quality upgrades.²³⁷ The stover, now with flowability characteristics similar to small cereal grains, is moved by standard grain loading and unloading systems into large corrugated steel bins for intermediate storage. In this harvest format, the stover is handled by only two machines before it reaches the roadside and never hits the ground. Dry matter losses should be significantly reduced.

Harvesting wet stover as chopped material, similar to animal forage, and ensiling it in a silo bag can be done successfully, with dry-matter (DM) matter loss at about 11% after seven months storage. Harvesting wet stover by baling and tube wrapping was also successful with DM losses of 3.6%. Dry stover bales stored indoors or outdoors had average DM losses of 5% and 15%, respectively. Wrapping dry bales in net wrap and storing on a well drained surface significantly reduced DM loss compared to storing twine wrapped dry bales on the ground.²³⁸

Indoor storage is, in most cases, a concrete slab with a roof, supported by poles, with open sides (pole-barn). Depending on the number of bales to be stored, the slab must be sized to include aprons around all four edges with aisles between stacks to accommodate stacking and hauling equipment and for fire safety. Corn stover is usually harvested only once per year during an approximately 50- to 70-day period; this period is bounded by the time the corn grain harvest begins and the onset of winter weather, which is usually wet, and could include snow cover. As a result, the quantity of stover an ethanol plant expects to use until the next harvest (~one-year) must be harvested and stored during the same period. We don't expect that a full-year's worth of feedstock for most ethanol plants will be stored at the plant site; for larger plants the storage site would cover several hundred acres and the logistics of hauling and stacking the required number of bales would be impossible. If the bales are to be stored as large, square baled, in satellite storage, we anticipate that pole-barn type storage will be used. A similar slab and pole-barn would be constructed at the ethanol plant to store three- or four-days of feedstock.^R

Sugarcane bagasse is high in moisture, typically 60 to 75 percent, that is packed in storage and sealed as much as possible to reduce the amount of oxygen that would otherwise promote rotting. On the other hand, the anaerobic fermentation in the ensilage creates lactic acid that acts as a preservative.

In the future, as we described in Section 1.3.1, we expect stover will be ground into particles that are small and stable enough that they can be handled and stored using methods and equipment currently used for grains of all kinds, e.g., silos or tanks.

1.3.3. Feedstock Transport

Baled Format: Following the baling operation, we expect stover bales will be picked up from the field in 10-bale loads, by vehicles designed for that purpose (such vehicles are currently used to gather hay bales); the bales are subsequently unloaded or dropped at the field-edge. Later, the bales are loaded onto wagons pulled by high-speed tractors that haul as many as 20-bales per load to satellite storage (the pole-barns described in Section 1.3.2). The bales are unloaded and stacked for storage until they are needed at the ethanol plant. Transport to the plant is by over-the-road trucks and trailers that can haul net-loads of up to about 45- to 50-tons. However, because the bale density is low (on average, about half the weight of a similarly sized hay bale), the maximum number of bales a truck can haul usually weighs much less than the maximum allowable weight. We expect small grain straws will be handled in much the same way. Sugarcane bagasse can contain as much as 60% to 75% moisture and is usually hauled in open-topped metal trailers from which the bagasse can be dumped onto belts or into auger hoppers that convey it to ensilage type storage.

As we pointed out in the previous paragraph, low bale density usually means that trucks and trailers can't haul the maximum allowable weight, which translates into increased transportation costs. We anticipate that drying and grinding the stover (and possibly the other residues) will increase its bulk density and allow the transports to haul maximum weight loads to the ethanol plant.

^R We discuss this information in greater detail in subsection 4.1.1.2 of this chapter.

Grain Elevator Format: According to process requirement, an ethanol plant could pick up its feedstock from the elevator/depot in trucks and trailers for transport to the facility. We believe stover feedstock in the ground format will have a significantly higher bulk-density than baled stover, which should translate into lower transportation costs.

1.4 Biofuel Production Technologies

Biofuel production technologies continue to evolve with research and development efforts focused on reducing costs and increasing efficiencies. Improvements include increasing conversion yields for various feedstocks, reducing energy and materials usage, eliminating or reducing wastes, finding alternative uses for by-products, etc. For those technologies not yet commercial, researchers are combining their innovative ideas to develop cost-effective processes to produce biofuel at low enough costs to compete with their petroleum counterparts. The following sections describe both proven and new technologies which may be used to produce renewable fuels to meet the EISA 36 billion gallon standard by 2022.

1.4.1 Corn Ethanol

There are two primary processes for converting corn (and other similarly processed grains) into ethanol: wet milling and dry milling. The main difference between the two is in the treatment of the grain. Dry mill plants grind the entire kernel (shown below in Figure 1.4-1) and generally produce only one primary co-product: distillers grains with solubles (DGS). The co-product is sold wet (WDGS) or dried (DDGS) to the agricultural market as animal feed. Wet mill ethanol plants separate the grain kernel prior to processing into its component parts and produce other co-products (usually gluten feed, gluten meal, and food-grade corn oil) in addition to DGS. Each process is described in greater detail in the subsections that follow.

Figure 1.4-1. Components of the Corn Kernel

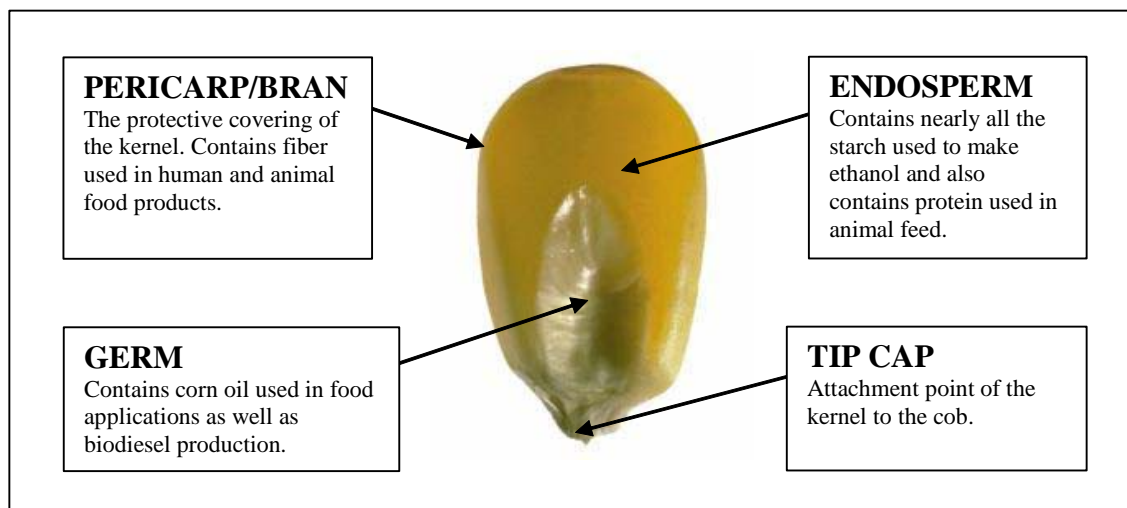

1.4.1.1 Dry Milling Technology²³⁹

In traditional dry mill plants, first the corn is screened to remove any unwanted debris. Then, it goes through a hammer mill where it is ground into course flour also know as “meal.” Next the meal is cooked to physically and chemically prepare the starch for fermentation.

The first step of the cooking process is to form a hot slurry. The meal is mixed with water, the pH is adjusted, and an alpha-amylase enzyme is added. The slurry is heated to 180–190°F for about 30–45 minutes to reduce viscosity.

The second step in the cooking process is liquefaction, which occurs in two steps. First the hot slurry is pumped through a pressurized jet cooker at approximately 220°F and held for about 5 minutes. The mixture is then cooled by an atmospheric or vacuum flash condenser. After cooling, the mixture is held for 1–2 hours at 180–190°F to give the alpha-amylase enzyme time to break down the starch into short-chain carbohydrates also know as “dextrins.” Once cooking is complete, a pH and temperature adjustment is made, a second enzyme (glucoamylase) is added, and the resulting mixture (also know as “mash”) is pumped into the fermentation tanks.

During the fermentation process, the glucoamylase enzyme breaks down the dextrins to form simple sugars. Yeast is added to convert the sugar into ethanol and carbon dioxide. The mash is then allowed to ferment for 50–60 hours. The result is a mixture that contains 10-15% ethanol by volume (20 to 30-proof) as well as solids from the grain and added yeast.

From here, the fermented mash is pumped into a multi-column distillation system where additional heat is added. The columns utilize the differences in the boiling points of ethanol and water to boil off and separate the ethanol. By the time the product stream leaves the distillation columns, it contains about 95% ethanol by volume (190-proof). The residue from this process, called stillage, contains non-fermentable solids and water and is pumped out from the bottom of the columns into the centrifuges.

The final step in the ethanol production process is dehydration to remove the remaining 5% water. The ethanol is passed through a molecular sieve to physically separate the water from the ethanol based on the different sizes of the molecules. This result is 200-proof anhydrous (waterless) ethanol. At this point, denaturant is added (making it unfit for human consumption) and the ethanol is placed into storage.

During the ethanol production process, two primary co-products are created: carbon dioxide and distillers grains. As yeast ferment the sugar, they release large amounts of carbon dioxide gas. In some plants it’s released into the atmosphere, but where local markets exist, it’s captured and purified with a scrubber and sold to the food processing industry for use in carbonated beverages and flash-freezing applications.

The stillage from the bottom of the distillation columns contains solids from the grain and added yeast as well as liquid from the water added during the process. It is separated via centrifuge into thin stillage (a liquid with 5–10% solids) and wet distillers grain.

Some of the thin stillage is routed back to the cooking tanks as makeup or “backset” water, reducing the amount of fresh water required by the cooking process. The rest is sent through a multiple-effect evaporation system where it is concentrated into a condensed distillers solubles or “syrup” containing 25–50% solids. This syrup, which is high in protein and fat content, is then mixed back in with the distillers grain to make wet distillers grains with solubles.

Wet distillers grains with solubles (WDGS) contain most of the nutritive value of the original feedstock (plus added yeast) and can be easily conveyed as a wet cake for transport. As such, WDGS makes an excellent cattle ration for local feedlots and dairies. However, WDGS must be used soon after it’s produced because the wet grains spoil easily. Since many ethanol plants are located in areas where there are not enough nearby cattle to utilize all the feed, a portion or all of the WDGS is sent through a drying system to remove moisture and extend the shelf life. The resulting dried distillers grains with solubles (DDGS) are commonly used as a high-protein ingredient in cattle, swine, poultry, and fish diets. Distillers grains are also being researched for human consumption. A schematic of a typical dry-mill ethanol plant is shown below in Figure 1.4-2.

Figure 1.4-2. Dry Milling Process

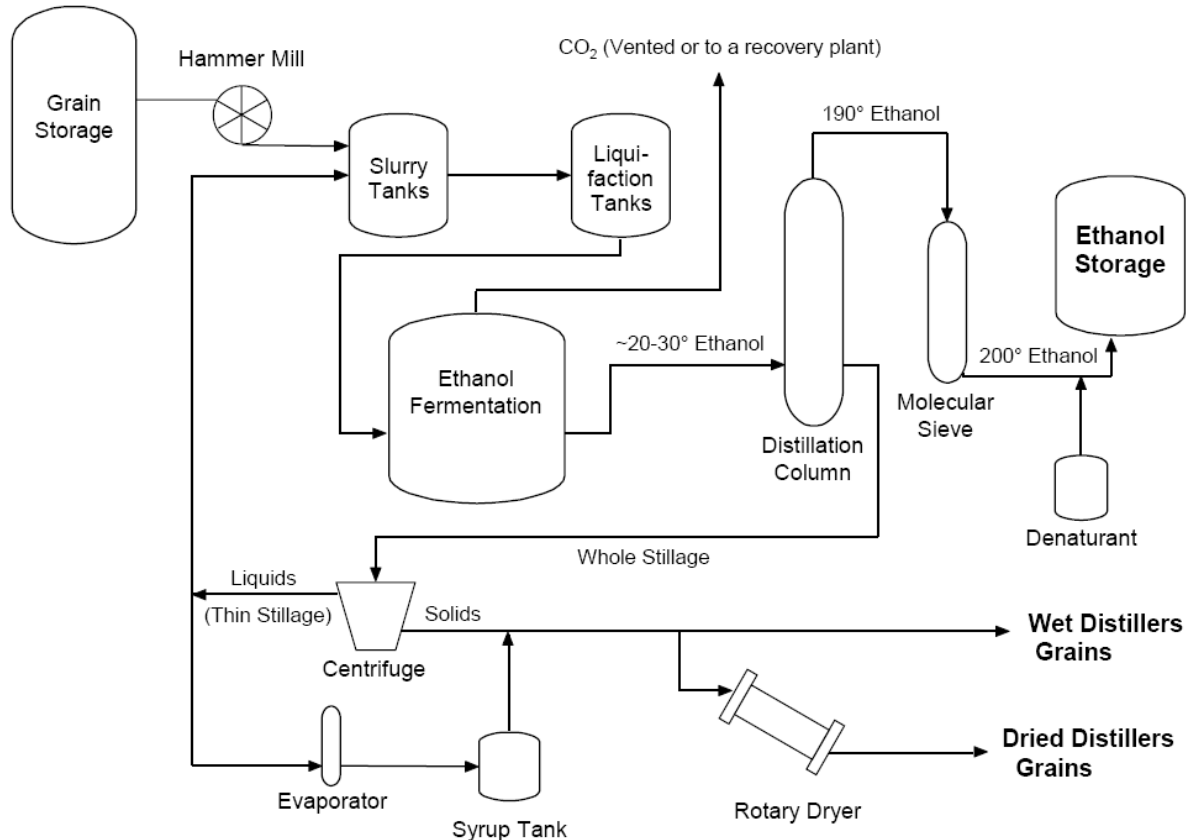

1.4.1.2 Wet Milling Technology²⁴⁰

In wet mill plants, first the corn is soaked or "steeped" in a dilute sulfurous acid solution for 24-48 hours. The steeping process facilitates the separation of the corn kernel into germ, fiber, gluten, and starch.

After steeping, the corn slurry is processed through a series of grinders to separate out the germ. The germ is either extracted on-site or sold to crushers who extract the corn oil. The corn oil in its crude state can be sold to the biodiesel or renewable diesel industry. However, most wet mill plants refine the product into food-grade corn oil for use in cooking applications. The remaining fiber, gluten and starch components are further segregated using centrifugal, screen, and hydroclonic separators.

The steeping liquor is concentrated in an evaporator. This concentrated product, heavy steep water, is co-dried with the fiber component and is then sold as corn gluten feed to the livestock industry. Heavy steep water is also sold by itself as a feed ingredient and is used as a component in Ice Ban, an environmentally-friendly alternative to salt for removing ice from

roads.

The gluten component (protein) is filtered and dried to produce the corn gluten meal co-product. This product is highly sought after as a feed ingredient in poultry broiler operations.

The starch and any remaining water from the mash is generally processed in one of three ways: fermented into ethanol, dried and sold as dried or modified corn starch, or processed into corn syrup. If made into ethanol, the fermentation process is very similar to the dry mill ethanol production process described above. A schematic of the wet milling process is shown below in Figure 1.4-3.

Figure 1.4-3. Wet Milling Process

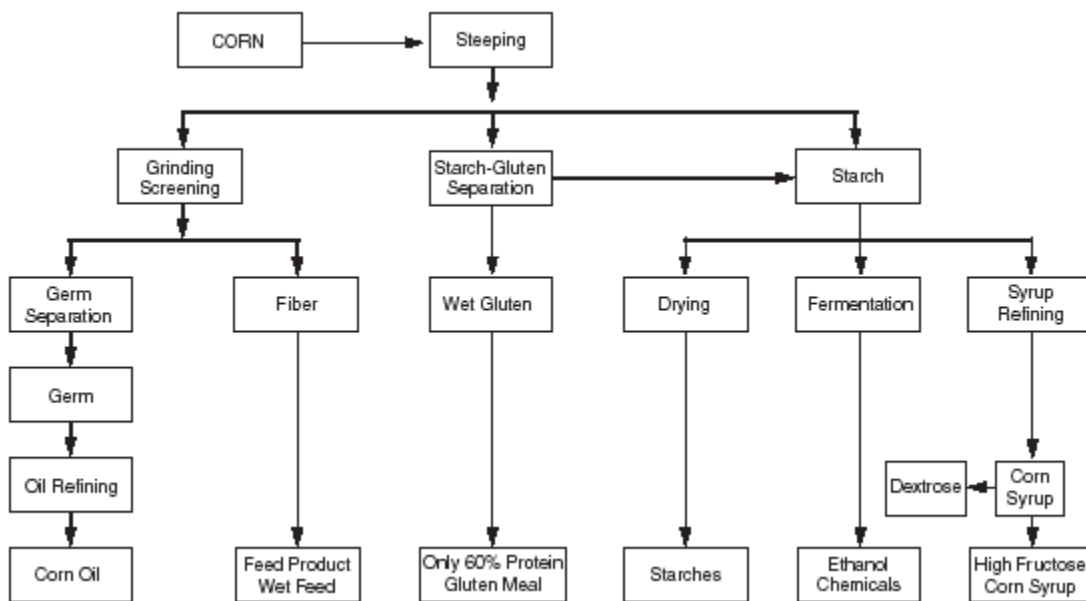

1.4.1.3 Advanced Technologies

A number of corn ethanol plants are pursuing technological advancements such as cold starch fermentation, dry fractionation, and corn oil extraction to improve plant yields and reduce energy requirements. Research is also being done that looks at adding membranes to reduce ethanol distillation requirements. Finally a growing number of companies are utilizing alternative boiler fuels and/or incorporating combined heat and power (CHP) technology into their facilities to reduce to plant energy requirements, and in some cases, produce excess power for the grid. The advanced technologies currently being pursued by the corn ethanol industry are described in more detail below.

*Cold Starch Fermentation*²⁴¹²⁴²

POET Biorefining, the United States' largest corn ethanol producer^S, has developed a cold starch fermentation process that uses raw-starch hydrolysis to convert starch to sugar, which then ferments to ethanol without heat. The patent-pending POET technology eliminates the cooking process that has been part of ethanol production for years. According to POET, the BPX™ process not only reduces energy costs, but also releases additional starch for conversion to ethanol, increases protein content and quality of co-products, increases co-product flowability, potentially increases plant throughput, and significantly decreases plant emissions. The benefits of the process include reduced energy costs, increased ethanol yields, increased nutrient quality in the distillers grains and decreased plant emissions. At the time of our industry assessment, BPX™ was reportedly used in 20 of POET's 22 U.S. ethanol plants. According to POET, the BPX™ process, which yields 20% ethanol in fermentation, increases theoretical ethanol yields from the industry standard of 2.7 gallons of ethanol per bushel of corn up to 3 gallons per bushel. Earlier this year, POET also announced that it was funding a research collaboration with Iowa State University to help improve the efficiency of the BPX™ process.

Dry Fractionation

Dry fractionation is a mechanical separation of the corn kernel into its three component pieces, the germ, bran, and endosperm before fermentation. This separation decreases the amount of non-fermentable material sent through the process and allows each of the components to be processed separately to produce new, higher-value co-products. As shown in Figure 1.4-1, the germ is a small, non-fermentable part of the kernel consisting predominantly of protein and oil. Food grade corn oil can be extracted from the germ. After the oil has been extracted, the remainder of the germ can then be blended into the DGS to increase its protein content. The bran, or pericarp, is the protective outer covering of the kernel. The bran can be sold as cattle feed, human fiber additive, or corn fiber for oil extraction. It can also be burned to reduce the amount of coal or natural gas required for ethanol production. The endosperm, which contains approximately 98% of the starch and is the only fermentable portion of the kernel, is sent to the fermentation vessels. Decreasing the amount of non-fermentable materials (germ and bran) in the process has many beneficial effects, including increasing the production capacity of the plant, decreasing the energy required to dry the DGS, and potentially decreasing the enzyme requirement of the plant but up to 30%. Dry fractionation is currently only used by a few ethanol plants; however several companies, including ICM, Delta-T, and POET currently offer dry fractionation options for new or existing plants.

*Corn Oil Extraction*²⁴³

Several dry mill corn ethanol plants have implemented corn oil extraction to produce fuel-grade corn oil for the biodiesel industry. The crude corn oil can either be extracted from the thin stillage (the non-ethanol liquid left after fermentation) before it enters the evaporator, or from the DGS after it has been dried. While the corn oil is of a lower quality and value than that produced from corn fractionation, the equipment can be easily added to existing ethanol production facilities and is relatively inexpensive. In addition to generating an additional

^S At the time of our May 2008 plant assessment. For more information, refer to Figure 1.5-4 in Section 1.5.1.1.

revenue stream from the fuel-grade corn oil, reducing the oil content of the DGS improves its flowability and concentrates its protein content. The de-fatted DGS is more marketable than DGS containing corn oil as higher quantities can be included in dairy and beef cattle feed.

Membrane Replacement

Several companies are currently working to produce commercially viable polymeric membranes that could potentially reduce the energy used in distillation and eliminate the need for molecular sieve units currently used in most ethanol plants. One such company, Vaperma, has partnered with GreenField Ethanol to prove the viability of its Siftek™ technology. Siftek™ membranes have been successfully installed in GreenField's Tiverton, Ontario demonstration plant and are scheduled to be installed in their Chatham, Ontario plant, which produces 187 million liters of ethanol per year, by the end of 2008. Vaperma claims its Siftek™ membranes are capable of producing a fuel grade ethanol product from an ethanol/water mixture that contains as much as 60% water. These membranes would replace the rectifier unit as well as the molecular sieves used in a conventional ethanol plant, potentially reducing the energy consumption of the ethanol dehydration process by up to 50%. Another way for these membranes to be used is to treat the ethanol/water vapor collected when the molecular sieve units are regenerated. This stream is usually recycled to the rectifier and makes up approximately one third of the feed to the rectifying column. Using Siftek™ technology to treat this stream reduces the feed to the rectifier, reducing energy consumption and increasing production rate by 20% or more. While membrane replacement technology has the potential to significantly reduce the energy demands of an ethanol plant, they are likely at least a couple of years from being commercially available. It is not expected that membrane replacement units would be retrofitted into existing plants due to the significant capital costs. These two factors will effectively limit the use of membrane separation units to new ethanol plants built in 2010 or later.

An alternative method of membrane replacement is to use ethanol-permeating membranes to eliminate the need for the beer column, followed by a water-selective membrane for final dehydration. Eliminating the need for the beer column as well as the rectifier and molecular sieve units would significantly reduce the capital costs of an ethanol plant, as well as lowering the energy requirements of ethanol separation. While this technology has the potential to significantly lower the cost and energy demands of an ethanol plant, it is highly unlikely that it will be available for near term commercialization. It has therefore not been considered section 1.5.1.3 on the forecasted growth of advanced ethanol technologies. If more information becomes available we will consider including this method in the energy usage forecast for the final rule.

Combined Heat and Power²⁴⁴

Ethanol production is a relatively resource-intensive process that requires the use of water, electricity, and steam. In most cases, water and electricity are purchased from the municipality and steam is produced on-site using boilers fired by natural gas, coal, or in some cases, alternative fuels (described in more detail below).^T However a growing number of ethanol

^T There are a few ethanol producers that we have been made aware of from EPA Region 7 that pull their steam from a nearby utility.

producers are pursuing combined heat and power (CHP) technology. CHP, also known as cogeneration, is a mechanism for improving overall plant efficiency by using a single fuel to generate both power and thermal energy. The most common configuration in ethanol plants involves using the boiler to power a turbine generator unit that produces electricity, and using waste heat to make process steam. In some cases, the generator produces excess electricity that can be sold to the grid. While the thermal energy demand for an ethanol plant using CHP technology is slightly higher than that of a conventional plant, the additional energy used is far less than what would be required to produce the same amount of electricity in a central power plant. The increased efficiency is due to the ability of the ethanol plant to effectively utilize the waste heat from the electricity generation process.

The CHP system can be owned and operated solely by the ethanol plant, or jointly operated with the local utility company. In these cases it is common for the utility company to purchase the generator and to split the cost of the generator fuel with the ethanol plant. The utility company receives the electricity produced, while the ethanol plant uses the waste heat. These arrangements reduce the energy costs for both parties, as well as reducing the green house gas emissions that would be produced by operating the generator and boiler separately. An illustration of the more common CHP configuration typically seen in ethanol plants is shown below in Figure 1.4-4.

Figure 1.4-4. Steam Boiler with Steam Turbine

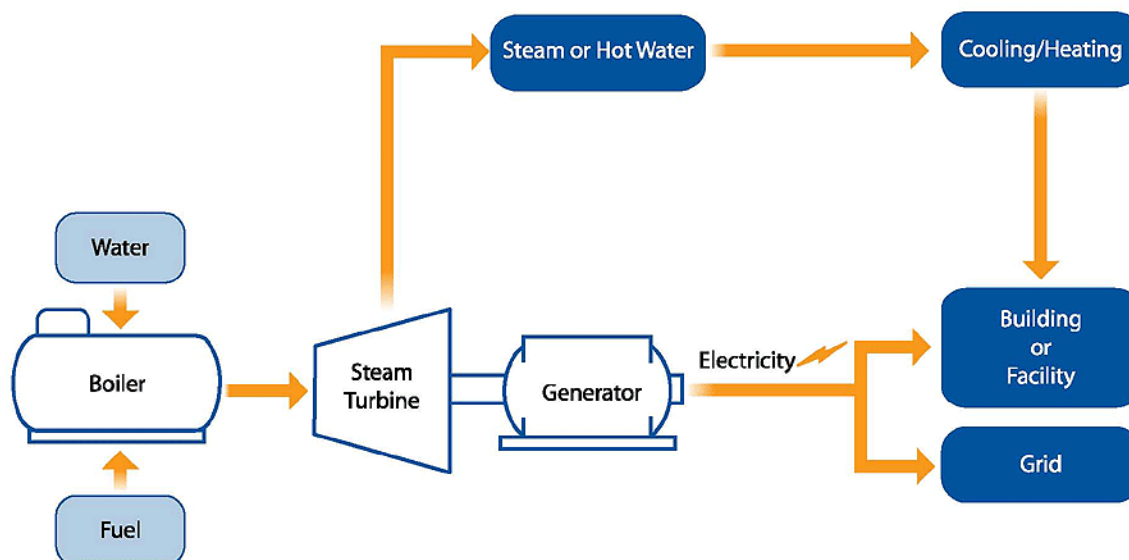

Alternative Boiler Fuels

In addition to CHP (or sometimes in combination), a growing number of ethanol producers are turning to alternative fuel sources to replace traditional boiler fuels (i.e., natural gas and coal), improve their carbon footprint, and/or become more self-sustainable. Alternative boiler fuels currently used or being pursued by the ethanol industry include biomass (wood and other organic feedstocks), co-products from the ethanol production process (bran, thin stillage or

syrup), manure biogas (methane from nearby animal feedlots), and landfill gas (generated from the digestion of municipal solid waste).

For a breakdown of current and near-term^U utilization of CHP technology and alternative boiler fuels, refer to Sections 1.5.1.1 and 1.5.1.2. For our 2022 projections of the potential utilization of these and other advanced technologies, refer to Section 1.5.1.3.

1.4.2 Ethanol from Sugarcane Juice and Molasses

The production of ethanol from sugarcane juice or molasses is the least complicated method to use biomass to produce ethanol since sugarcane contains six-carbon sugars that can be directly fermented. This is currently the method used to produce ethanol in Brazil. In contrast, starch or cellulosic feedstocks require additional steps before sugars are released for use in the fermentation step. In addition to ethanol, sugarcane also yields trash, bagasse, filter cake mud, and vinasse. These by-products are described below:

Trash (Leaves and Tops)

The tops, brown and green leaves of sugarcane are commonly referred to as trash. Sugarcane trash is not currently harvested for production of ethanol. Much of the U.S. sugarcane trash is currently mechanically harvested and delivered to the factory with stalks, where it detrimentally affects industrial processing. However, there has been growing interest to use hydrolysis (cellulosic) technologies to convert trash to ethanol because it is easier to hydrolyze than bagasse, as the trash contains less lignin. Sugarcane trash can also be converted into bioelectricity.

Bagasse

Bagasse is the fibrous material left over after juice is extracted from the crushed stalk of the sugarcane plant. It mainly consists of hemicellulose, cellulose and lignin valued mainly for being a fossil fuel and wood substitute in steam energy generation. U.S. factories and other industrial units have used bagasse mainly for steam production, but a few are producing electricity (co-generation) as well. In Brazil, some facilities are able to produce more energy than needed and have exported excess electricity to the grid.

Filter Cake Mud

Filter cake is the dried, leftover solid material from precipitated mud after the sugarcane juice clarification (via lime addition) at the facility. It is sometimes reapplied to sugarcane fields as a fertilizer.

Vinasse

Vinasse is the liquid waste product from the ethanol distillation process. It is rich in minerals, organic material, and water. It is produced and used throughout the harvest in Brazil.

^U Based on current company plants.

Some countries are allowed to spray vinasse on sugarcane crop as fertilizer (not allowed in the U.S.). There is environmental legislation which prohibits inappropriate disposal of vinasse into rivers, lakes, the ocean, and soils.

In the production of sugarcane ethanol and sugar from sugarcane juice or molasses, the cane stalks are shredded and the juice is extracted across tandem mills or a diffuser. The juice contains most of the soluble sugars and the leftover sugarcane fiber is bagasse. Next, the cane juice is filtered then heated and limed to precipitate impurities during the clarification process. The resultant clarified juice is then concentrated across an evaporation station (14-16°Brix up to 65°Brix). The syrup produced is then further evaporated in vacuum pans and seed crystallized, leading to a mixture of sucrose crystals surrounded by molasses with a concentration of 91-93°Brix. The sugar crystals and molasses are subsequently separated by centrifugation. In ethanol production in Brazil, the sugars in juice or diluted are fermented into ethanol by the addition of yeast. Fermentation varies from 4-12 hours, with ethanol yields ranging from 80-90%. The fermented mixture is then distilled to produce hydrous (96 % ethanol) or anhydrous ethanol (99.7 % ethanol). The production of anhydrous ethanol is normally done by addition of cyclohexane. See Figure 1.4.5 for a diagram of the sugarcane ethanol and sugar production process.²⁴⁵ The production of sugar (for food and export) or ethanol depends on the supply and demand changes for both products.

Figure 1.4-5. Simplified Overview of Sugarcane Ethanol and Sugar Production Process

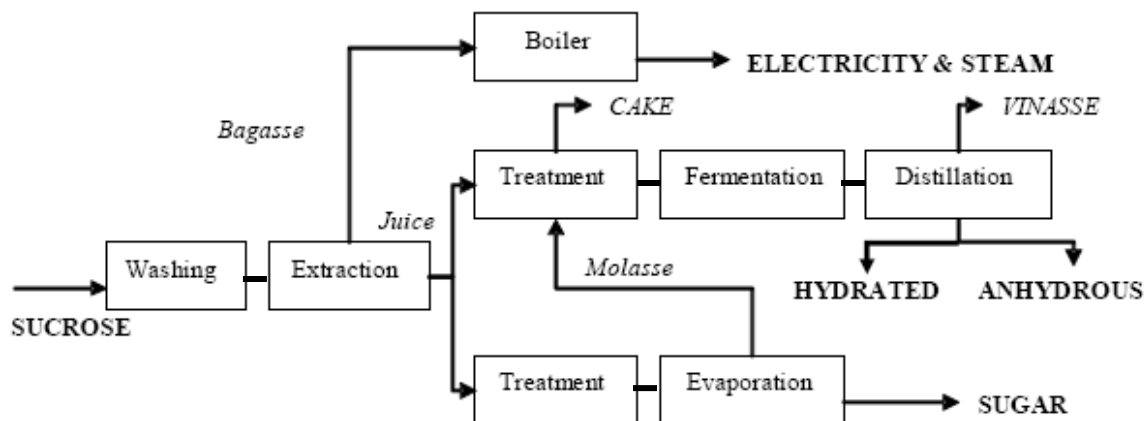

1.4.3 Cellulosic Biofuel

The following sections contain descriptions of cellulosic ethanol and cellulosic diesel production technologies. Section 1.4.3.1 introduces the two primary pathways for the production of cellulosic ethanol, through biochemical and thermochemical processes while Section 1.4.3.2 discusses cellulosic diesel which is produced through thermochemical processes. We end the section with specific company descriptions of cellulosic biofuel technologies and briefly describe how they differ from generic process discussions.

1.4.3.1 Cellulosic Ethanol

Cellulosic biomass has long been recognized as a potential source of mixed sugars for fermentation to fuel ethanol. The Germans may have been one of the earliest to try commercializing a process to produce ethanol from a cellulosic feedstock, probably from wood in the late 1890s. They used dilute acid to hydrolyze the cellulose to glucose and xylose, but were able to only produce a little less than 20 gallons per ton of feedstock; they soon improved the process enough to generate yields of around 50 gallons per ton. Eventually, two commercial-sized plants that used dilute sulfuric acid hydrolysis were constructed in the U.S. Yields from the U.S. facilities were roughly half that of the German plants, however, the production rate from U.S. facilities was significantly higher. Lumber production decreased following World War I, which resulted in the close down of cellulosic plants.^{246, 247} Although corn-grain ethanol was used in the early 20th Century, especially by high-performance race cars and as an additive to raise gasoline octane, petroleum-derived gasoline eventually replaced it as the primary fuel for automobiles and light-duty trucks. From the early 1970's and up through the present, ethanol from corn, has been increasingly used as a fuel; however, recently, ethanol from cellulose is being viewed with increasing interest.

Several processing options are currently available to convert cellulosic biomass into ethanol. These conversion technologies generally fall into two main categories: biochemical and thermochemical. Biochemical conversion refers to the fermentation of sugars liberated from the breakdown of biomass feedstock. Thermochemical conversion includes the gasification and pyrolysis of biomass material into a synthesis gas for subsequent fermentation or catalysis. The main benefit of gasification/pyrolysis over the biochemical route is that thermochemical processes can more easily convert low-carbohydrate or "non-fermentable" biomass materials such as forest and wood residues to alcohol fuels and can more readily accept a wider variety of feedstocks.²⁴⁸ However, the thermochemical process does have some drawbacks, such as tar production and clean-up gas procedures that require additional capital investment.

Since commercial production of cellulosic ethanol has not yet begun, it is unclear which process options will prove most viable or whether additional variations will emerge. At least in the near future, there have been plans to build both stand-alone biochemical and thermochemical ethanol processing plants. In addition, some investors are currently supporting research and development in both cellulosic processing procedures, neither choosing one conversion over the other.²⁴⁹ The following subsections describe the process steps, current challenges, and targeted areas for improvement for each conversion method.

1.4.3.1.1 Biochemical Conversion

Unlike grain feedstocks where the major carbohydrate is starch, lignocellulosic biomass is composed mainly of cellulose (40-60 %) and hemicellulose (20-40 %). The remainder consists of lignin, a complex polymer which serves as a stiffening and hydrophobic (water-hating) agent in cell walls.²⁵⁰ Cellulose and hemicellulose are made up of sugars residues linked together in long chains called polysaccharides. Once hydrolyzed, they can be fermented into ethanol. Currently, lignin cannot be fermented into ethanol, but could be burned as a by-product to generate electricity.

Both starch (corn grain) and cellulosic feedstocks must be hydrolyzed prior to fermentation. Structural differences at the molecular level make it far more difficult, and therefore more costly, to hydrolyze cellulosic biomass than it is to hydrolyze starch. Glucose, $C_6H_{12}O_6$, the repeating monomer in both starch and cellulose, is a six-sided ring, similar in conformation to the classic 'chair' conformation of cyclohexane or benzene, except one carbon atom in the ring is replaced by an oxygen atom. For uniformity (and ease) of discussion, it is generally assumed that the first carbon atom next to the oxygen, is carbon #1; the numbering, 2-5, continues around the ring with oxygen in the 6th position; one of the four bonds of the fifth carbon atom is attached to the oxygen atom to complete the ring, one is attached to hydrogen atom and the fourth to a $-CH_2OH$ group. Thus, a glucose molecule/monomer is a six-sided molecule, but not a six-carbon ring (although there are six-carbon molecules present, one of which is in the $-methylhydroxy$ group).

The main difference between starch and cellulosic plant matter is that starch polysaccharides are made up of α -glucose monomers, uniformly strung together by α -linked 1,4-glucosidic bonds whereas cellulosic polysaccharides are made up of β -glucose monomers, strung together through β -linked 1,4-glucosidic bonds. In starch with the α -conformation, the hydroxyl group on carbon #1 is in the axial or α -position, which causes the $-OH$'s on each successive glucose monomer to end up on the same side of the polymer. There are also 1,6-linked glucose branches that occur irregularly on approximately one in twenty-five glucose units.²⁵¹ The $-OH$ groups on the same side of the polymer, along with the randomly attached 1,6-glucose branches, leaves starch polymers relatively weak, flexible, and able to easily wrap and twist together to form tiny granules, e.g., common, everyday corn starch.

Cellulosic polysaccharides are in the β -conformation with the hydroxyl group on carbon #1 is positioned away from the ring, in the equatorial or β -position, which causes the $-OH$'s on each successive glucose monomer, added to the chain, to end up on opposite sides of the polymer. The hydroxyl groups lined up evenly and uniformly along opposite sides of each polymer strand allow intra-molecular hydrogen bonds to develop within each monomer. They also allow inter-molecular hydrogen bonds to develop between adjacent polymers to form tight, rigid, strong, mostly straight polymer bundles called microfibrils that act as the core constituent in the formation of plant cell walls that are also insoluble in water and resistant to chemical attack. The β -conformation and the resulting hydrogen bonds stabilize the glucose chair structure to help minimize the polymer's flexibility (which hinders hydrolysis) and to add to its strength.

The second cellulosic component is called hemicellulose. It consists mainly of a random mixture of highly branched and heavily substituted five- and six-carbon rings. The five-carbon residues are usually D-xylose and L-arabinose; the six-carbon residues are usually D-galactose, D-glucose, and D-mannose, and uronic and acetic acid. Hemicellulose is not as rigid or strong as cellulose, but does contribute additional strength and helps protect the plant cell wall against attack by microbes or water. Hemicellulose is relatively easy to hydrolyze, due to its highly branched, somewhat random or non-uniform structure.

Lignin, the third principle component, is a complex, cross-linked polymeric, high molecular weight substance derived principally from coniferyl alcohol by extensive condensation

polymerization. Covalently bonded to the hemicellulose, it is essentially a glue-like polymer that covers the cellulose and hemicellulose polymer cell walls and helps hold them together, provides additional strength, helps resist microbial decay, and perhaps most importantly, for this discussion, inhibits hydrolysis. Its molecular weight is around 10,000.²⁵² While both cellulose and hemicellulose contribute to the amount of fermentable sugars for ethanol production, lignin does not, but can be combusted to provide process energy in a biochemical plant or used as feedstock to a thermochemical process.²⁵³

To review, a significant part of the reason it is more difficult and more costly to produce ethanol from cellulosic feedstocks, such as corn stover, has to do with the differences in the molecular structures of simple starch and those of cellulosic plant matter. That is, as a plant grows, glucose monomers are added to the polysaccharide chains of the plant cell walls through condensation reactions. In general, condensation is a chemical process by which two molecules are joined together to make a larger, more complex molecule, and a molecule of water is a byproduct of the reaction. In the formation of polysaccharides, an enzyme catalyzes the reaction wherein the -OH group on carbon #1 of one monomer, or glucose residue, reacts with the -OH on carbon #4 or #6 of another residue. An H-OH (H₂O or water) molecule is removed leaving an -O- that links the monomers together to form the polysaccharide chain. Again, depending on the direction of the -OH group at carbon 1, it may be called an alpha (as in starch) or a beta (as in cellulose) linkage.²⁵⁴

Hydrolysis is the reverse reaction. The -H from an H-OH (water) molecule is added to one monomer and the remaining -OH is added to its pair, e.g., to the next monomer on the chain, to regenerate separate glucose monomers. During starch hydrolysis, water and water borne hydrolyzing enzymes can easily penetrate the randomly formed polymers (the tiny granular particles or bundles) in order to break the bonds to release glucose monomers. However, the cellulosic or glucan polymers formed in tightly packed, dense, rigid microfibrils are especially resistant to water and hydrolyzing enzymes. Xylan, the main constituent of hemicellulose, is more easily hydrolyzed than cellulose, but not easily fermented. Cellulose is not easily hydrolyzed, but readily ferments. These are two of the major problems that must be satisfactorily resolved before cellulosic ethanol can become a competitive fuel.

Biochemical conversion processes typically use dilute acid with enzymes or concentrated acid to convert cellulosic biomass to sugar for fermentation to ethanol. Concentrated acid hydrolysis is fairly well developed and is being pursued to commercialization in certain niche situations. For example, concentrated acid hydrolysis is suitable for feedstocks such as municipal solid wastes which have largely heterogeneous mixtures.²⁵⁵ Concentrated acid hydrolysis is typically much faster than enzymatic approaches, albeit at the cost of reduced sugar yields due to undesirable side reactions.²⁵⁶ Enzymatic hydrolysis is mostly suitable for homogeneous mixtures because specific enzymes are needed to convert a given type of feedstock. During the period covered by this proposed rule, the cost to enzymatically hydrolyze cellulose is expected to decline significantly as these technologies continue to improve.²⁵⁷

In general, steps of the biochemical process include: feedstock pretreatment, hydrolysis, saccharification and fermentation, ethanol dehydration, and lignin recovery. Refer to Figure 1.4-

6 for an illustration of the enzymatic biochemical production process. We used NREL's study as a guide to describe, somewhat generically, how such a process might work.²⁵⁸

Figure 1.4-6.
Cellulosic Ethanol Biochemical Production Process (Enzymatic)

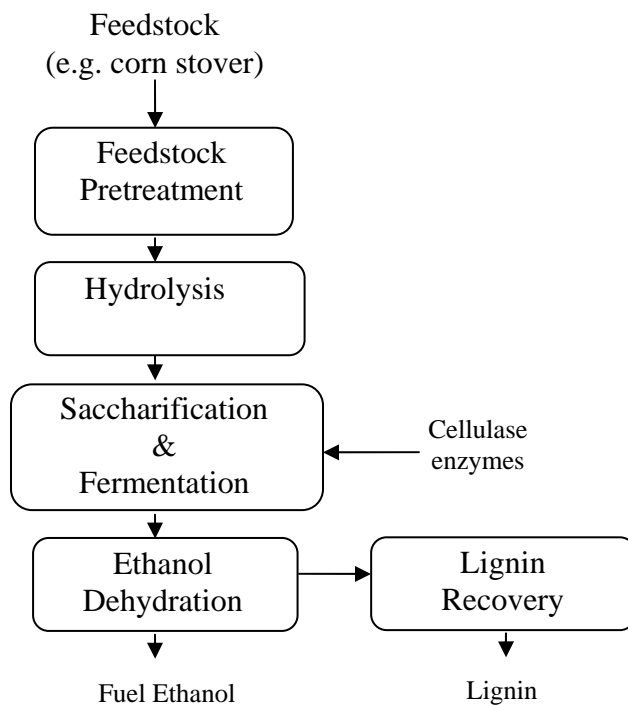

Stage 1 – Feedstock Pretreatment

Lignocellulosic biomass, such as the corn stover we're currently discussing, must undergo at least some pretreatment prior to hydrolysis. During the early years of cellulosic ethanol production (e.g., 2010 to 2015), we anticipate that this stage will likely occur within the facility. In the out years covered by this rule (2022) we believe that this stage will likely be moved outside the plant gate (e.g., upstream of the ethanol plant) to reduce transportation costs that are typically high due to the low density of this type of biomass. The biomass is pretreated with either a physical or chemical pretreatment method to help the polysaccharides become more accessible to hydrolysis. Studies have shown a direct correlation between the removal of lignin and hemicellulose and the digestibility of cellulose.²⁵⁹

Physical pretreatment nearly always includes size reduction by some type of grinding, shredding, or chopping. For example, in order to biochemically process wood chips, e.g., poplar trees or willows, the chips must be reduced in size to 1-mm or less in order to increase the surface area for contact with acid, enzymes, etc. Breaking up a 5-in tree stem into 1-mm pieces

would consume a large amount of energy. On the other hand, corn stover chips for a biochemical process can range up to a maximum size of 1.5 inches.²⁶⁰

Chemicals are also used for pretreatment. The most common chemical pretreatment methods for cellulosic feedstocks are dilute acid, hot water, alkaline, organic solvent, ammonia, sulfur dioxide, carbon dioxide, or other chemicals to make the biomass more digestible by the enzymes.^{261,262} These chemicals cause the biomass to react quite differently.²⁶³ For example, instead of hydrolyzing the hemicellulose (as in acidic pretreatments), an alkaline approach tends to leave the hemicellulose and cellulose intact. Enzymes are therefore required to digest both hemicellulose and cellulose at the same time when a basic pretreatment is used.

Different pretreatment approaches also affect the amounts of degradation products (e.g. furfurals, acetates) that occur from the decomposition of hemicellulose and lignin. This is important since these degradation products can inhibit microorganisms in the fermentation step. A well known pretreatment method that does not degrade biomass sugars or produce fermentation inhibitors is ammonia fiber expansion (AFEX). During AFEX, liquid ammonia is added to the cellulosic material followed by a rapid pressure release.

Each type of feedstock, whether softwoods, corn stover or bagasse, requires a particular combination of pretreatment methods to optimize the yields of that feedstock, minimize the degradation of the substrate, and maximize the sugar yield. Pretreatment of cellulosic biomass in a cost-effective manner is a major challenge of cellulose-ethanol technology research and development.²⁶⁴

Stage 2 – Pretreatment and Hydrolyzate Conditioning

NREL refers to this stage as a combination of pretreatment and hydrolysis. In their process flow diagram, the washed and sized-reduced feed is directly heated with steam and mixed with dilute sulfuric acid. The process converts, primarily, the hemicellulose polysaccharides xylan, mannann, arabinan and galactan, to produce the mixed sugars and further helps prepare the cellulose for hydrolysis. A small amount of glucan in the hemicellulose and in the cellulose is converted into glucose. The runoff from the acid hydrolysis reactor is fed to a blowdown tank that subsequently feeds a filter press. The filter press produces two main streams, a filter cake and a liquid filtrate, also called hydrolyzate. The filter cake carries the unhydrolyzed portions of the feed (e.g., glucans) among other insolubles, while the liquid carries that part of the feed that was hydrolyzed, mainly the xyloses.

The liquid portion is neutralized to remove gypsum and other contaminants that would be toxic to downstream enzymes. The cake is washed, mixed back with the detoxified liquid hydrolyzate, and fed to the saccharification reactors to hydrolyze the glucan polysaccharides.

Stage 3 – Saccharification and Co-Fermentation

We should point out that this is not ‘Simultaneous Saccharification and Fermentation’ (SSF). Saccharification, in the process we’re discussing, takes place primarily in several reactors along with other intermediate treatments such as filtering and detoxifying. Using a cellulase

enzyme cocktail, saccharification of the cellulose to glucose occurs first at an elevated temperature to take advantage of increased enzyme activity, which reduces the quantity of required enzyme as well as the reaction time.

The cellulase enzymes used to convert cellulose to sugars can be obtained in two ways. The first option is for a plant to produce it on-site. The second option requires the plant to purchase the enzymes from off-site enzyme manufacturers. Due to a joint research effort by DOE, Genencor International, and Novozymes Biotech, the cost for production of cellulase enzymes has been drastically reduced. Such research and development in areas of enzyme production have reduced the cost of cellulolytic enzymes by a factor of 10 to 30, down to 20 to 30 cents per gallon of ethanol produced.^{265,266,267} It is estimated, however, that enzyme costs will have to be further reduced to a level comparable to those used to produce ethanol from corn grain at a cost of 3 to 4 cents per gallon of ethanol. The current challenge is to develop the correct enzyme “cocktails” to reflect differences in the physical and chemical characteristics of all the various types of cellulosic materials. It may be easier, therefore, to process single feedstocks (more homogeneous) rather than multiple feedstocks, in which variations are more likely.

Following cellulose saccharification, both the glucose and xylose sugars are co-fermented. Although xylan, the hemicellulose polysaccharide, is more easily hydrolyzed than glucan (cellulose polysaccharides), the xylose sugar is more difficult to ferment than is the glucose sugar. Different microbes as well as different residence times and process conditions may be required for each.

Because xylan can make up as much as 25% of plant matter it is imperative that as much of it as possible be fermented; the economic viability of biochemically produced ethanol depends heavily on it. This continues to be high on the list of problems researchers are working on, but good progress has been made toward fermenting a higher percentage of xylose during the past few years.²⁶⁸

Stage 3A – Consolidated Bioprocessing e.g., Simultaneous Saccharification and Fermentation (SSF)

During the past few years, researchers have been looking for ways to combine saccharification and fermentation into a single step through the use of enzyme/microbe cocktails. If successful, we expect there could be significant capital cost savings in that fewer reactors and other support equipment and piping would be necessary. Also, it may be possible to reduce processing times if hydrolysis reactions can take place simultaneously, rather than sequentially. Such strategies are known as consolidated bioprocessing (CBP). CBP, however, is currently hampered by the relative inability of yeast to process recombinant cellulases (enzymes that help convert cellulose to sugars), and the relative lag in the development of molecular biological methods to manipulate organisms that secrete cellulases naturally.²⁶⁹

Stage 4 – Ethanol Dehydration

NREL's process model indicates that the fermentation reactor runoff stream, now called 'beer,' runs down the beer column feed surge tank. The beer column feed consists of about 83% water and only 5.5% ethanol; the balance of the mixture is very complex, but consists mostly of lignin. The beer column removes the dissolved CO₂ overhead and produces a water/ethanol bottom stream that is fed to a rectification column. According to NREL's model, the rectification column bottoms would be mostly water with about 0.05% ethanol that's recycled back to the process. The rectification column overhead that consists of about 92.5% ethanol and 7.5% water, is fed to a molecular sieve that produces a 99.5 wt.% ethanol product stream with about 0.5 wt.% water. Gasoline, a denaturant, is added to produce a 95 % to 98 % ethanol fuel.

Stage 5 – Lignin Recovery

Following the saccharification and fermentation of the xylan and glucan to ethanol, the lignin is gradually concentrated with other solids into a moist cake-like product that is about 48% insoluble solids. About 80% of the 48% insoluble solids is essentially lignin microbial cells, and other unconverted biomass remnants, (e.g., cellulose, xylose, glucan, xylan, other oligomers, etc.) from the process. This material can be either combusted to provide process heat for the biochemical operation, for a co-located starch ethanol plant, or as we discuss in the following section, could be used as feedstock for a thermochemical unit.

1.4.3.1.2 Thermochemical Conversion

Thermochemical conversion involves biomass being broken down into intermediates using heat and upgraded to fuels using a combination of heat and pressure in the presence of catalysts.²⁷⁰ Thermochemical processes include pyrolysis (absence of oxygen), gasification (partial oxidation in the presence of a gasifying agent, usually air, oxygen, and/or steam), and combustion (complete oxidation). The former two conversion processes, pyrolysis and gasification, can be used to convert biomass into energy carriers for transportation use. It is important to note that these processing steps are also applicable to other feedstocks (e.g., coal or natural gas); the only difference is that a renewable feedstock is used (i.e. biomass) to produce cellulosic biofuel. A thermochemical unit can also complement a biochemical processing plant to enhance the economics of an integrated biorefinery by converting lignin-rich, non-fermentable material left over from high-starch or cellulosic feedstocks conversion.²⁷¹ We discuss the gasification and pyrolysis processes below.

Gasification

Compared to corn ethanol or biochemical cellulosic ethanol plants, the use of biomass gasification may allow for greater flexibility to utilize different biomass feedstocks at a specific plant. Mixed biomass feedstocks may be used, based on availability of long-term suppliers, seasonal availability, harvest cycle, and costs. Agricultural residue, energy crops, forest residue, and municipal solid waste have been discussed as potential feedstocks. Geographic location, availability of biomass, the existence of biomass suppliers, and costs would all likely influence

the mix of biomass feedstocks utilized. The general steps of the gasification thermochemical process include: feedstock handling, gasification, gas cleanup and conditioning, fuel synthesis, and separation. Refer to Figure 1.4-7 for a schematic of the thermochemical cellulosic ethanol production process through gasification.

Figure 1.4-7. Cellulosic Ethanol Thermochemical Gasification Process

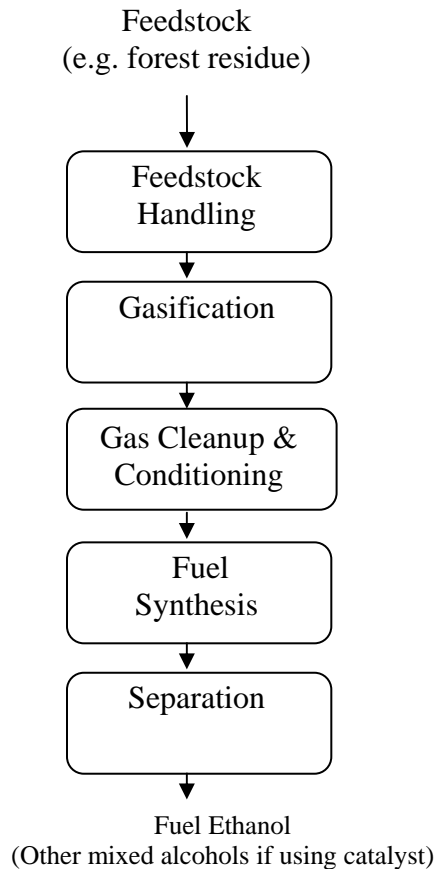

Stage 1 – Feedstock Handling

The particle size requirement for a thermochemical process is around 10-mm to 100-mm in diameter.²⁷² Once the feed is ground to the proper size, flue gases from the char combustor and tar reformer catalyst regenerator dry the feed from around 30% to 40% moisture to the level required by the gasifier.

Stage 2 – Gasification

There are two general classes of gasifiers. First, partial oxidation (POx) gasifiers (directly-heated gasifiers) use the exothermic reaction between oxygen and organics to provide the heat necessary to devolatilize biomass and to convert residual carbon-rich chars. In POx gasifiers, the heat to drive the process is generated internally within the gasifier. A disadvantage

of POx gasifiers is that oxygen production is expensive and typically requires large plant sizes to improve economics.

The second general class, called indirect gasification, uses steam gasifiers to accomplish gasification through heat transfer from a hot solid or through a heat transfer surface. Either the byproduct char and/or a portion of the product gas can be combusted with air (external to the gasifier itself) to provide the energy required for gasification. Although steam gasifiers have the advantage of not requiring oxygen, most operate at low pressure and therefore require product gas compression for downstream purification and synthesis unit operations.^{273,274}

There are different subcategories of gasifiers which are either directly or indirectly heated. One subcategory is termed a bubbling fluidized bed gasifier and it employs a bubbling fluidized bed of inert material and the reactant (biomass) is also bubbled through the fluidized bed. A second variant is the circulating fluidized bed gasifier which is similar to the bubbling fluidized bed reactor except that a high feedstock and air flow rate circulates the fluidized bed out of and back into the reactor. For the fluidized bed, the bed material may either be inert alumina or sand which helps the heat transfer. There are also fixed bed reactors which either feed the reacting gas (oxygen or air) upward or downward through a fixed bed of the reactant (biomass). Because of the tar formed when using biomass as a feedstock, a second reactor is sometimes added which solely targets converting the tar to syn-gas. If the biomass feedstock is ground to a sufficiently small particle size, or liquefied, the biomass is considered to be “entrained” in the reactor, and the reactor is defined as an entrained flow reactor.

Indirect gasification using an entrained flow gasifier is described for this example. The gasification process begins as the biomass is fed to the reactor containing a heat transfer media, such as sand, and is partially reacted with air (or oxygen) which is introduced to the bottom of the reactor. The air serves as the carrier-gas and as the oxidant for partially oxidizing the biomass to syn-gas, carbon monoxide and hydrogen. In addition to the syngas produced, char and coke are also formed. The heat for the endothermic gasification reactions is supplied by circulating heat transfer media (e.g. sythetic sand) between the gasifier and the char combustor. The heat generated by the combustion of the char and coke heats the heat transfer media to over 1800°F. The syngas is separated from the sand and ash and sent to gas cleanup.

Stage 3 – Gas Cleanup & Conditioning

Once the biomass is gasified and converted to syngas, the syngas must be cleaned and conditioned. This raw syngas has a low to medium energy content depending on the gasifying agent and consists mainly of CO, H₂, CO₂, H₂O, N₂, and hydrocarbons. The minor components, tars, sulfur, nitrogen oxides, alkali metals, and particulates have the potential to negatively affect the syngas conversion steps. Therefore, unwanted impurities are removed in a gas cleanup step and the gas composition is further modified during gas conditioning. Gas conditioning steps include sulfur polishing to remove trace levels of H₂S and water-gas shift to adjust the final H₂/CO ratio for optimized fuel synthesis.

Stage 4 – Fuel Synthesis

After cleanup and conditioning, the “clean” syngas is comprised of essentially CO and H₂. The syngas is then converted into a liquid fuel by either a catalytic process or through the use of a microorganism. The fuel producer has the choice of producing diesel fuel or alcohols from syngas by optimizing the type of catalyst used and the H₂/CO ratio. Diesel fuel has historically been the primary focus of such processes, as it produces a high quality distillate product, however, with the 45 cent tax subsidy currently available for ethanol production, it may be economically advantageous for fuel producers to convert syngas to ethanol instead of to diesel fuel. Production of cellulosic diesel is discussed in further detail in the following Section 1.4.3.2.

Conceptual designs and techno-economic models have been developed for ethanol production via mixed alcohol synthesis using catalytic processes. The proposed mixed alcohol process produces a mixture of ethanol along with higher normal alcohols (e.g., n-propanol, n-butanol, and n-pentanol). The by-product higher normal alcohols have value as commodity chemicals and fuel additives. Typically the mixed alcohol products described in literature are often high in methanol, but contain a wide distribution of several different alcohols. A concept proposed in literature is to completely recycle this methanol in order to increase the production of ethanol and higher alcohols which are generally more valuable. This concept was modeled by NREL for the thermochemical production of ethanol for the year 2012. Total mixed alcohol yield was 94.1 gallons per dry ton, in which 85% of the total alcohol product was ethanol. This was made possible through the addition of an almost complete recycle of methanol within the process.²⁷⁵

In contrast to the catalytic processing of syngas to produce fuels, the fermentation process requires a special microorganism (*Clostridium ljungdahlii*) that will convert the syngas to ethanol.²⁷⁶ This combined syngas and fermentation process has the benefit of having a significantly faster processing time, on the order of minutes, as compared to the typical biochemical process on the order of days.²⁷⁷

Stage 5 – Alcohol Separation

The liquid rundown from the low-pressure separator is dehydrated in vapor-phase molecular sieves, producing the dehydrated mixed alcohol feed into a methanol/ethanol overhead stream and a mixed, higher molecular weight alcohol bottom stream. The overhead stream is further separated into a methanol stream and an ethanol stream.

Heat & Power

A carefully integrated conventional steam cycle produces process heat and electricity (excess electricity is exported). Pre-heaters, steam generators, and super-heaters generate steam that drives turbines on compressors and electrical generators. The heat balance around a thermochemical unit or thermochemical/biochemical combined unit must be carefully designed and tuned in order to avoid unnecessary heat losses.²⁷⁸

Pyrolysis

Pyrolysis oils, or bio-oils, are produced by condensing the decomposed biomass instead of introducing a gasifying agent.²⁷⁹ The decomposition occurs at lower temperatures than gasification processes, and produces liquid oil instead of a synthesis gas. The reaction can occur both with or without the use of catalysts. The oil produced varies in oxygen content or viscosity according to the feedstock used. The oil must have particulates and ash removed in filtration to create a homogenous product and is further upgraded to hydrocarbon fuels via hydrotreating and hydrocracking processing, which reduces its total oxygen content. Some believe that pyrolysis could have a significant economic advantage over other cellulosic ethanol approaches since very little has been done in terms of optimizing the process, and as such, there are still many possibilities yet to be explored.²⁸⁰

1.4.3.2 Cellulosic Diesel

Technology

Another example of a thermochemical process is a cellulosic diesel fuel technology which is also termed biomass-to-liquids (BTL). The BTL process produces a syngas from biomass and then the syngas is fed to a Fischer-Tropsch (FT) reactor to primarily produce diesel fuel.

The BTL method removes contaminants from the gasification stream prior to the reactions that form the liquid compounds. The resulting liquid fuel is essentially contaminant-free and is very similar to petroleum-based diesel fuel – in fact, its cetane number is higher than petroleum-based diesel fuel making it somewhat better in quality. Thus it can be easily blended with or used interchangeably with petroleum-based diesel fuel.

BTL plants, like thermochemical ethanol plants, are capital intensive plants with many subunits associated with them. The first couple of steps of BTL plants, including biomass processing and gasification, are similar to the thermochemical cellulosic ethanol plants described above. However, once the syngas is produced, it is then cooled producing high pressure steam, and is scrubbed to remove particulate matter. Impurities such as mercury, arsenic and trace metals are removed by a sulfur impregnated carbon reactor. The syngas is further treated in either a Selexol or Rectisol unit to remove hydrogen sulfide and concentrated carbon dioxide (CO₂). The CO₂ can be captured and sold to a bottling company, used for enhanced the oil recovery from oil wells, or even sequestered in the ground for additional life cycle benefits. The syngas is sent to a water shift reactor to which causes a shift to more hydrogen and less carbon monoxide, which is necessary to establish an optimal mix of hydrogen and carbon for the downstream Fischer-Tropsch (FT) reactor.

The cleaned and water-shifted syngas is sent to the FT reactor where the carbon monoxide and hydrogen are reacted over a FT catalyst. The FT catalyst is either iron-based or cobalt-based. The cobalt catalyst is more expensive, although it does not require a recycle, while the less expensive iron catalyst does require a recycle. The FT reactor creates a syncrude, which is variety of hydrocarbons that boil over a wide distillation range (a mix of heavy and light

hydrocarbons). The syncrude from the FT reactor is sent to a distillation column where it is separated into various components based on their vapor pressure, mainly liquid petroleum gas (LPG), naphtha, distillate and wax fractions. The heavier compounds are hydrocracked to maximize the production of diesel fuel. The distillate boiling compounds have high cetane and thus are of high quality for blending into diesel fuel. Conversely, the naphtha material is very low in octane thus, it would either have to be upgraded, or blended down with high octane blendstocks (i.e., ethanol), or be upgraded to a higher octane blendstock to have much value for use in gasoline. The naphtha could also be sold as feedstock for the petrochemical market for manufacturing chemical products such as ethylene and benzene.

The unreacted carbon monoxide and hydrogen and any gaseous hydrocarbon material are burned to produce electricity in a turbine. The waste heat from the gas turbine along with the steam created to cool the syn-gas, may be sent to steam turbines to produce additional electricity. Most of the electricity would be used within the BTL plant, however, some could be sold to raise additional revenues, particularly in the summer when electricity demand and prices are high.

Industry Characterization

No commercial BTL plants currently exist in the U.S., however, there are several BTL pilot plants. Choren is currently building a 1 million ton per year commercial Plant in Freiberg/Saxony Germany that is expected to start up in 2011 or 2012. Initially, the plant will use biomass from nearby forests, the wood-processing industry and straw from farmland.

Although coal-to-liquids (CTL) plants use coal as a feedstock, the process is essentially the same, therefore, CTL pilot and full scale plants help to demonstrate the BTL plant technology. Examples of CTL pilot projects include a 10-15 barrel per day (BPD) operation in Colorado (Rentech) and a 30 BPD plant in New Jersey (Headwaters Inc.). Internationally, commercial sized CTL plants are currently in operation in South Africa (Sasol) and have been in operation for a number of decades. These plants produce approximately 2.4 billion gallons per year (or 160,000 barrels per day) of fuel products. These liquid fuel products can include finished Fischer-Tropsch diesel, Fischer-Tropsch naphtha (a gasoline blendstock), methanol, and dimethyl ether, among others. Worldwide, additional CTL plants are being considered or constructed in China, Indonesia, India, Australia, and Malaysia.

An inventory of current domestic CTL plants under consideration (including those without CCS, with CCS, and/or biomass co-feed) involves fifteen projects ranging in size from smaller projects (1,800 BPD) to large commercial plants up to 80,000 BPD. Most plants being considered are in the conceptual stage or are in the project feasibility stage.^V Two plants are currently in the design phase (a 13,000 BPD and a 5,000 BPD plant) while one plant is in the construction phase (a 1,800 BPD plant).^W Based on discussions with plant developers, three of the plant sites under consideration are currently assessing the use of both biomass co-firing and

^V DOE (2007), "Clean Coal Today: A Newsletter about Innovative Technologies for Coal Utilization," Office of Fossil Energy, U.S. Department of Energy, DOE/FE-0509, Issue No. 72, Summer 2007, Table 1, p. 6.

^W The plants currently listed under design status are located near Medicine Bow, WY (DKRW Advanced Fuels, 13,000 BPD) and near Gilberton, PA (WMPI, 5,000 BPD). The current plant under construction is in East Dubuque, IL (Rentech, 1,800 BPD).

carbon capture to reduce GHG emissions. The plant furthest in developing coal and biomass to liquids (CBTL) with carbon capture (with CO₂ intended for reuse in enhanced oil recovery applications) would be located in Wellsville, OH (a 50,000 BPD plant, Beard Energy).

1.4.3.3 Developing Technologies

The following sections describe specific companies and their cellulosic biofuel technologies which the companies have developed or are developing. This summary is not meant to be an unabridged list of cellulosic biofuel technologies, but rather a description of some of the more prominent or interesting cellulosic biofuel technologies. These technologies are variants of the biochemical or thermochemical platforms described above in Section 1.4.3.1.1 and 1.4.3.1.2. The process technology summaries provided below are those stated by the respective companies. EPA has not confirmed the statements made concerning these technologies, nor have we confirmed the process conditions and the process flow steps necessary for any of these companies. As some of these technologies have slightly different process designs from the general descriptions found in Section 1.4.3.1 and Section 1.4.3.2 and may warrant additional consideration in the final rule, we found it important to discuss their differences below.

Amyris Biotechnologies

A new second generation process from Amyris Biotechnologies has a fermentation process that uses custom designed yeast cells to make renewable fuels that are substitutes for petroleum gasoline and petroleum diesel fuel. The technology is modular in design and can be collocated with existing ethanol plants.

Amyris's yeast cells are the key drivers of their conversion process. The process uses the same feedstocks that are currently used to make corn ethanol, which could be sugar cane or corn. At this time, no public information is available to derive production cost estimates for the Amyris process. Amyris has a 100 gallon per week pilot plant operating in Emeryville, CA, and is constructing a commercial demonstration plant in Brazil in 2010 to showcase their technology.

The produced diesel fuel and is compatible with the existing petroleum distribution system and provides better storage and cold flow properties than biodiesel.

Bell Bio-Energy

A biochemical biofuel technology has been developed which uses genetically engineered bacteria to convert cellulosic feedstocks to synthetic hydrocarbon fuels. Depending on the types of bacteria used, this process can produce specific hydrocarbon types which can either be methane or other light hydrocarbons, gasoline, diesel or jet fuel type hydrocarbon compounds. For example, if a bacterium is chosen to produce gasoline, the bacteria may only produce octane, the eight carbon hydrocarbon molecule that boils within the distillation temperature range of gasoline.

After the inventors of this process completed their development work, they discussed their technology with the Department of Defense which became interested in this technology for providing fuels to their land and air based vehicles. The military agreed to partially fund the establishment of pilot plants at different military bases. The bases are: Fort Benning and Fort Stewart in Georgia, Fort Bragg in North Carolina, Fort AP Hill in Virginia, Fort Drum in New York and Fort Lewis in Washington, and at a facility in San Pedro, California. The first of these pilot plants began operating at Fort Stewart, GA in late 2008 and the total expected production capacity for these pilot plants is 0.04 million gallons per year. The intent is to next build a large commercial demonstration plant of at least 150 million gallons per year with a startup date in 2011.

The technology works by first grinding the cellulosic feedstock into a smaller size and then immersing the ground cellulose with bacteria into water. The bacteria begin to digest the cellulose after only several hours, but require 30 days to fully digest the cellulose. The produced fuel is constantly removed from the reaction vessel, and some organic material is also produced which can be marketed as potting soil. The process produces over 84 gallons of renewable product per ton of feedstock and the simplicity of the process results in low capital costs per volume produced. The process is believed to be cost competitive with petroleum fuels when crude oil is priced at or above \$30 per barrel assuming that the cellulosic feedstocks cost \$40 per dry ton.

BlueFire Ethanol

BlueFire Ethanol has a commercial acid hydrolysis technology process that converts cellulosic materials into ethanol. The technology can make ethanol from urban trash, rice and wheat straws, wood waste and other agricultural residues. Acid hydrolysis is the main reaction mechanism to convert cellulosic and hemicellulosic material into simple sugars such as hexose and pentose or "C6 and C5" sugars. Fermentation of these sugars with microbes converts these sugars into ethanol. This process for converting cellulosic and hemicellulosic material into ethanol via acid hydrolysis and fermentation has been around for many decades; though it has not been economically competitive as the cost was not competitive with transport fuel made from petroleum. BlueFire's process is claimed to offer several improvements to existing acid hydrolysis technology, giving higher ethanol yields and lower production costs.

Bluefire uses a proprietary concentrated acid hydrolysis system and several other process improvements to make ethanol production more economically attractive than older acid hydrolysis methods. Some of Bluefire's stated improvements include a more efficient acid recovery system; higher sugar purities and concentrations; use of more efficient microbes to ferment C6 and C5 sugars into ethanol; the processes ability to use biomass feedstock's containing silica. The Bluefire process consists of the following main components; feedstock preparation; decrystallization/hydrolysis reaction; filtration of solids and liquids; separation of the acid and sugars; fermentation of the sugars and product separation. For product separation, ethanol effluent is separated using distillation and then dehydrated with molecular sieve technology.

Bluefire has successfully operated a pilot plant for five years near their headquarters in Southern California. BlueFire is in the process of building its first commercial facility which will be located in Lancaster California. The plant could start up as early as 2010 and will produce up to 3.2 million gallons of cellulosic ethanol per year, using feedstock derived from cellulosic feedstocks from municipal solid waste (MSW) Blue Fire is planning to start up another cellulosic ethanol plant which they call their Mecca plant also using MSW as feedstock, and which will produce about 17 million gallons per year. No start up date has been announced for their Mecca plant.

Cello-Energy

The Cello-Energy process is a catalytic depolymerization technology. At moderate pressure and temperature, the Cello-Energy process catalytically removes the oxygen and minerals from the hydrocarbons that comprise cellulose. This results in a mixture of short chain (3, 6 and 9 carbon) hydrocarbon compounds. These short chain hydrocarbon compounds are polymerized to form compounds that boil in the diesel boiling range, though the process can also be adjusted to produce gasoline or jet fuel. The resulting diesel fuel meets the ASTM standards, is in the range of 50 to 55 cetane and typically contains 3 ppm of sulfur. The resulting diesel fuel has been tested in Caterpillar engines to demonstrate the viability of the fuel.

The Cello-Energy process is reported to convert 94% of the hydrocarbon material to diesel fuel, although a very small amount of heavier hydrocarbons is also produced. The Cello Energy Process could be totally self-sufficient by routing 12% of the product to run generators to produce the electricity that it needs. The only energy input is electricity - no natural gas nor water is used in the process.. The Cello process is on the order of 82 % efficient at converting the feedstock energy content into the energy content of the product, which is very high compared to most of today's biochemical and thermochemical processes which are on the order of 50 % efficient, or less.

Because of the simplicity of the process, the capital costs are very low. A 50 million gallon per year plant only incurs a total cost of \$45 million. This is typical of the capital costs incurred when refiners expand their refineries, a very low cost for a grassroots plant. Because of its high efficiency in converting feedstocks into liquid fuel, the production and operating costs are estimated to be very low. By using some waste feedstocks today, production costs are reported to be less than \$0.50 per gallon. However, even with feedstock costs in the \$70 to \$80 per ton range, which is the cost we used in our cost analysis, total costs would remain less than \$1.00 per gallon of diesel fuel.

Cello-Energy was founded 16 years ago and after the chemistry was worked out, they built their first pilot plant in 1998. They next converted their pilot plant in 2004 to a larger continuously-operating pilot plant that produced 4 million gallons per year of diesel fuel. In December 2008, Cello started up a 20 million gallon per year commercial demonstration plant. Cello energy already has chosen locations to construct and start up three 50 million gallons per year plants by the end of 2010. This includes a facility in conjunction with the State of Georgia Energy Innovation Center, and two additional plants in Alabama. Cello is already making plans to construct and start-up ten more plants the year after. Cello explained that they will use

prefabrication techniques so that these plants can readily be constructed, shipped and installed anywhere in the U.S.

Choren

Choren has a technology called Carbo-V, which is a Fischer-Tropsch process that can be used to make diesel fuel. The process can process a wide variety biomass and recycled material materials as feedstocks. The process converts agriculture biomass, forestry biomass, biogenic waste and recycling substances into a synthesis gas which can be further converted to a diesel fuel using a Fischer-Tropsch reactor. The Carbo-V process can also be configured without the Fischer-Tropsch hydrocracking technology, so as to produce electricity, heat and power, methanol, and other chemical feedstocks.

The principal aspect of the Carbo-V Process is a three-stage gasification process consisting of low temperature gasification, high temperature gasification and endothermic entrained bed gasification. In the first stage, biomass is partially oxidized with air or oxygen at temperatures between 400 and 500 °C. This breaks down the feedstock into a gas containing tar and solid carbon. In the second stage, the tar is oxidized at temperature higher than the ash's melting point, converting the tar into a synthesis gas. In the third stage, solid carbon is mechanically pulverized and blown into the hot gasification stream. The fluidized carbon endothermically reacts with the gasification stream and is converted into a synthesis gas. In the next Fischer-Tropsch stage of the process, the synthesis gas (CO and H₂) reacts with the aid of a catalyst to form hydrocarbons. The resulting hydrocarbons produced from the three stages can then be sent to a hydrocracking process to primarily produce diesel fuel.

Choren will be building building a commercial Plant in Freiberg/ Saxony Germany that is expected to be operational in 2011 or 2012. Initially, the plant will use biomass from nearby forests, the wood-processing industry and straw from farmland.

Coskata

The Coskata process is a gasification-based technology which produces ethanol from biomass and other forms of carbon through a biofermentation route. A wide variety of feedstocks can be used, municipal waste, agriculture waste and other carbonaceous containing material. Since this process uses combustion and biofermentation, it is not easily classifiable as either a biochemical or thermochemical production method. This process requires that the biomass or carbonaceous material be processed to a small particle size and then it is injected into a gasifier.

The gasifier combusts any dry carbonaceous feed stocks into syngas, comprised primarily of carbon monoxide and hydrogen. The syngas produced is fermented in a reactor by micro-organisms, which convert the carbon monoxide and hydrogen directly into ethanol. The micro-organisms are low cost and can process a wide range of carbon monoxide and hydrogen molar ratios in the syngas, providing feedstock processing flexibility. No other enzymes are required by this process for producing ethanol, providing significant cost savings over current cellulosic and corn based fermentation production methods. The Coskata process is conducted at low

pressures, which offers savings on capital and energy costs. Additional energy savings can be realized by employing membrane technology to separate ethanol from the reactor decant liquid. This technology uses gravity and filtration to recover ethanol, resulting in significant savings on distillation capital and energy costs used in cellulosic and corn based production methods. Initial ethanol production cost estimates are lower than the biochemical and thermochemical cellulosic technologies described in Section 1.4.3.1.1 and 1.4.3.1.2.

For woody biomass, Coskata estimates that each ton of this feedstock would generate about 100 gallons of ethanol and small amounts of ash which would be burned to supply energy needs for the process. Corn stover is expected to yield similar ethanol yields as woody biomass feed stocks, though details about yields from the various feed supply stocks are not yet public.

Coskata has a bench scale pilot plant in Warrenville, IL, and projects that its larger 40,000 gallon per year pilot plant will be operational later on in 2009. Coskata is targeting to design and build a 50 million gallons per year commercial demonstration plant will be operational in 2011

Dynamotive Energy Systems

Dynamotive Energy Systems Corporation has announced a pyrolysis technology that uses medium temperatures and oxygen free reactions to convert dry waste biomass and energy crops into fuels that can be used in power/heat generation and transportation vehicles. Additionally, the process can make feedstock's that can be used to produce chemicals. The process is flexible on the types of biomass feedstock's that can be processed. The fuel produced from the Dynamotive process is called "BioOil" and contains up to 25% water, though the water is intimately mixed and does not easily separate into another phase with time. Since the bio oil contains significant amounts of water, it is not directly useable as fuel in conventional vehicles and would have to be converted via another catalytic conversion processing step. The additional catalytic step envisioned for this would combust the material into a synthesis gas which would then be converted into diesel fuel or bio-methanol via a catalytic reaction (the BTL process). The diesel fuel produced is expected to be compatible with existing petroleum diesel fuels.

Three products are produced by the Dynamotive process, bio oil (60-75% by weight), char (15-20% wt.) and non-condensable gases (10-20% wt.). The char produced is similar to coke and can be used as fuel by other industries while the gases yielded from the process can be used to supply about 75% of the energy requirements of the pyrolysis process. The pyrolysis process operates at a reactor temperatures of about 400-500 degrees Celsius.

The process has two small demonstration plants, one operating and another at the end of its construction phase. These plants are being run to produce bio oil for use in the power sector, though Dynamotive has not announced plans for building a facility to make transportation fuels. The operating demonstration plant is located in West Lorne Ontario, Canada. This plant started operation in early 2005 and operates with a capacity of 130 tons per day of waste sawdust. The other demonstration plant is being built with a stated capacity of 200 tons per day. This plant will be located in Guelph, Ontario, Canada and will process 66,000 dry tons of biomass a year.

This process uses waste construction and demolition wood from the private sector and will use about 3,000 tons of recycled wood.

POET

POET has over twenty years of producing conventional ethanol in 23 plants in seven states with production capability of one billion gallons of ethanol annually. POET has expanded their production capability to include cellulosic ethanol technology. POET's cellulosic technology will make ethanol from plant materials like corn stalks, switch grass, wood chips and refuse. In February 2007, POET was selected by DOE for an award totaling \$80 million for federal funding for a commercial cellulosic ethanol plant, which will be located in Emmetsburg, Iowa. As such, POET will be one of the first to build a cellulosic plant on a commercial scale. POET's commercial demonstration plant is projected to produce 25 million gallons per year and start up in 2011. It will make cellulosic ethanol from plant materials such as corn cobs and perhaps other cellulosic feedstocks.

Range Fuels

Range Fuels produces cellulosic ethanol via a two step thermochemical process, similar to that discussed above for the cellulosic ethanol process via the thermochemical pathway. Their technology converts biomass to syngas followed by catalytic conversion of the syngas to alcohols. Range claims that their technology produces more ethanol than other cellulosic technologies based on yields per energy input. This is a two step process which can use many forms of non food biomass, such as agriculture waste, wood, and corn stocks. Additionally, the technology can process feed stocks with variable water content.

In the Range process, biomass feedstock are converted by heat, pressure and steam into syngas, which is then scrubbed and cleaned before entering into the second stage. The second stage uses catalyst to convert the syngas into mixed alcohols, which are then separated and purified into alcohol fuels using distillation equipment. Overall, the Range process is simple as no enzymes or living organisms are used for the main conversion reactions.

Range has operated a pilot plant for over 7 years using over 20 different nonfood feedstocks. Range broke ground building its first commercial plant late in late 2008 and is expected to be operational in 2010. This plant will be located in Soperton, Georgia and is partially funded from proceeds of a DOE grant. The plant will use wood, grasses, and corn stover as feedstocks. Although the initial plant is designed to produce 10 million gallons of ethanol per year, the plant is expected to be expanded to produce up to 60 million gallons per year of ethanol.

Virent Bioreforming

Another new process unveiled by Virent called "Bioforming Process" functions similarly as the gasoline reforming process used in the refining industry. While refinery-based reforming raises natural gasoline's octane value and produces organic chemicals, benzene, xylene and toluene as a byproduct, Bioforming reforms biomass-derived sugars into hydrocarbons for

blending into gasoline and diesel fuel. The process however, operates at much lower temperatures and pressures than reforming used by the refining industry. The Bioforming process is being developed through a partnership with Shell, Cargill, Honda and the University of Wisconsin. Virent currently has 16 pilot plants in operation. At this stage, though, the data is limited. It appears that Bioforming is a promising technology, as production costs estimates are low in comparison to most other renewable and biomass production processes while the products are compatible with traditional petroleum stocks.

Biomass feedstocks for the Bioforming process are sugar feeds, such a corn syrup, sucrose, glycerol, sorbitol, xylose, glucose, cellulose and hemi cellulose. These are primarily converted into gasoline and diesel fuel, though other hydrocarbons such as jet fuel, LPG, benzene, toluene, xylene, hydrogen, natural gas can also be produced. Water is also produced, as the reforming process removes oxygen from the sugar feeds. The resulting properties and energy content of gasoline and diesel produced though are physically comparable to those yielded from refining industry, probably allowing movement in existing petroleum distribution systems, saving on shipping costs. Additionally, variable operating costs are low because no distillation equipment is needed to separate the produced gasoline, diesel and other hydrocarbons, as these separate naturally from the aqueous solutions generated in the reforming process. The net energy costs are also low due to low operating pressures and temperatures.

1.4.4 Biodiesel & Renewable Diesel Production

Biodiesel

Plant oils and animal fats consist primarily of triglycerides, a type of a molecule consisting of a group of three hydrocarbon chains (saturated or olefinic) linked to a three-carbon backbone via carboxylic acid esters (see Figure 1.4-8). Biodiesel is made by removing the chains from the triglyceride molecules and adding methanol to their ends to form methyl esters. Glycerin is formed as a by-product from the three-carbon backbones that remain. For relatively pure triglycerides, such as virgin plant oils, the primary reaction is catalyzed by an alkaline pH and takes place in a stirred vessel at mild temperature and pressure conditions.

Figure 1.4-8. Overview of biodiesel conversion process

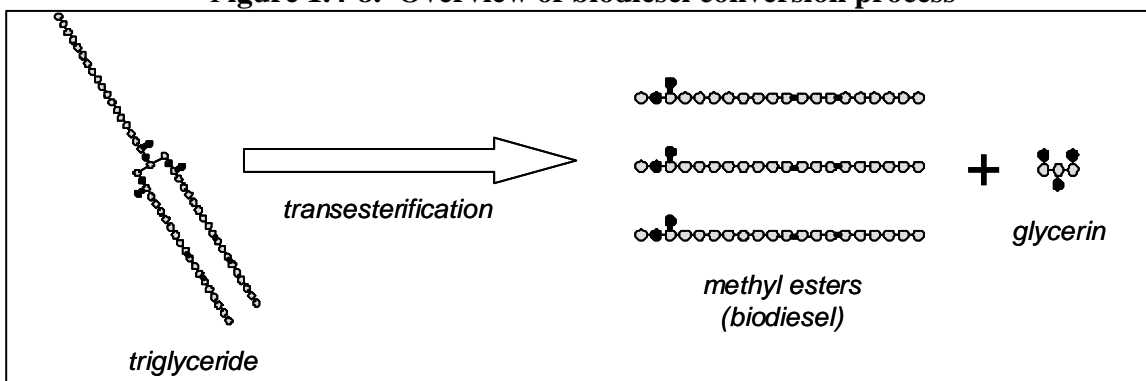

In the case of feedstocks containing more than a few percent free fatty acids (FFAs), such as rendered fats and waste greases, addition of base will result in the formation of soap, an undesirable process contaminant when present above trace levels. To avoid this, these feedstocks first undergo an acid pre-treatment step to esterify the FFAs before proceeding to the base-catalyzed triglyceride transesterification reaction. Feedstocks with small amounts of FFAs may be converted in a basic environment if the soaps can be removed from the fuel product.

Once the chemical conversions are complete, the mixture is neutralized, washed, and co-products and unreacted alcohol are recovered. At that point the biodiesel is subjected to quality control testing and then released for sale. Figure 1.4-9 shows a process flow diagram for a typical biodiesel production process that uses virgin plant oil as feedstock; processes using waste fats or greases would include an acid esterification step upstream of the transesterification reactor shown here. Plants that also produce other oleochemicals often have distillation equipment at the end of the process capable of purifying the methyl esters to a high degree or separating them by molecular weight. These plants may use this equipment to produce a very high purity biodiesel product. We estimate that less than 10% of current biodiesel production is distilled.²⁸¹

Figure 1.4-9. Schematic of typical biodiesel production from virgin plant oil

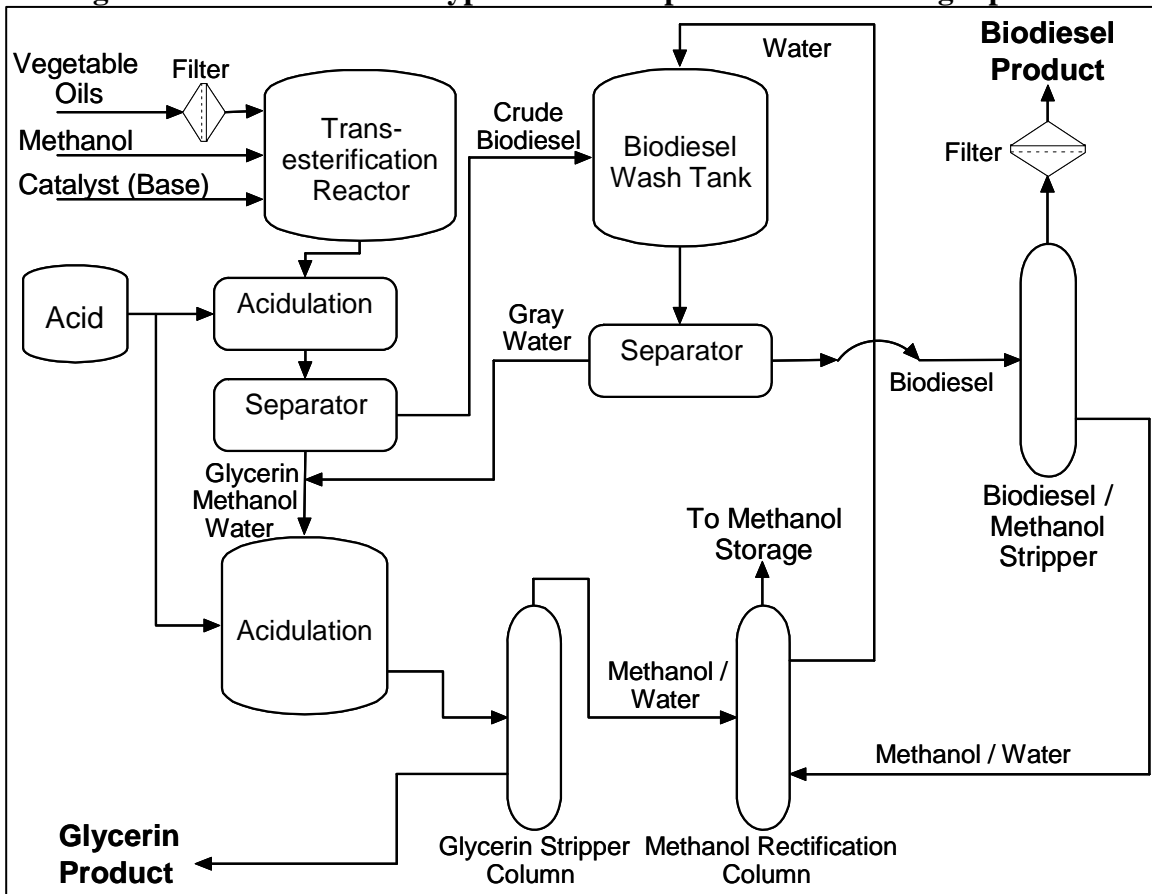

Some differences exist between large and small plants that are worth mentioning given the very wide range of plant capacities existing in this industry. Larger plants (greater than 10 million gallons per year) are more likely to employ continuous flow processes, which afford certain efficiencies of scale and steady-state operation. On the other hand, small plants (less than one million gallons per year) are most likely to produce fuel batch-by-batch, which may give them more flexibility to change feedstock types or slow output on short notice. Smaller plants are less likely to be able to afford an on-site laboratory or quality control specialist, which may cause them hardship as fuel quality standards tighten and/or are more stringently enforced. Third-party labs exist for this purpose, but they pose challenges such as significant per-test costs and multi-day turnaround times that require holding of product batches until results are received.

The biodiesel production process is relatively simple and economical, and there is sufficient existing U.S. capacity to produce all the biodiesel required to comply with the biomass-based diesel standard in this rulemaking. With U.S. 2008 biodiesel production estimated to be 650 million gallons, most made as described above, the process is viewed as demonstrated and reliable. Thus, we do not expect large changes in the process technology used to make biodiesel going into the future. That said, it is worth noting some potential changes as existing plants strive to comply with changing fuel quality standards, or as new plants are occasionally built to take advantage of specific market niches.

One such change may be an increase in distillation of biodiesel. EPA requires biodiesel to meet the ASTM D-6751 specification for B100 in order to be legally blended into diesel fuel for use in vehicles. Earlier this year, ASTM amended this specification to require a cold filter plugging test, which effectively mandates very low levels of FFAs, sterol glucosides, and partially-converted triglycerides in the finished biodiesel. There are a variety of process parameters a biodiesel producer can adjust to reduce the levels of these compounds in the finished fuel, but one very effective way to ensure a high purity product is through distillation. At this time it is unclear to what extent distillation will be relied upon for compliance with the amended biodiesel specification. An increase in distillation would increase per-gallon energy inputs to the process significantly, which will make the biodiesel more costly and result in higher GHG emissions.

Another potential change is a shift to use of heterogeneous (i.e., solid phase) catalysts for transesterification rather than the sodium or potassium methylate liquids used in most plants now. This is expected to reduce the neutralizing/washing/separating steps required downstream of the reactor, potentially resulting in a higher purity product and decreasing process energy use to some extent.

Some industry forecasts suggest animal fats and waste greases will make up an increasing share of biodiesel feedstocks due to their lower costs and lower upstream GHG impacts. Because most fats and greases contain significant levels of FFAs, this shift will cause more plants to use acid pre-treatment, increasing process complexity and per-gallon energy use.

Renewable Diesel

The renewable diesel production process converts vegetable oils and animal fats into diesel fuel using thermal depolymerization, which is similar to hydrotreating used in petroleum refining to remove sulfur. The process uses hydrogen and catalyst to remove oxygen from the triglyceride molecules in the feedstocks oils via a decarboxylation and hydro-oxygenation reaction, yielding some light petroleum products and water as byproducts. The reactions also saturate the olefin bonds in the feedstock oils, converting them to paraffins. All of these reactions consume significant amounts of hydrogen. The extent of these reactions depends on the process conditions, as some of the carbon backbone of the oils can be cracked to naphtha and lighter products with higher severity. For our analysis though, we assume no such cracking and predict high selectivity to diesel-range material with a small amount of propane and water as by-products. Figure 1.4-10 shows a flow diagram of the primary steps of renewable diesel production.

Figure 1.4-10. Process flow diagram of primary steps in renewable diesel production

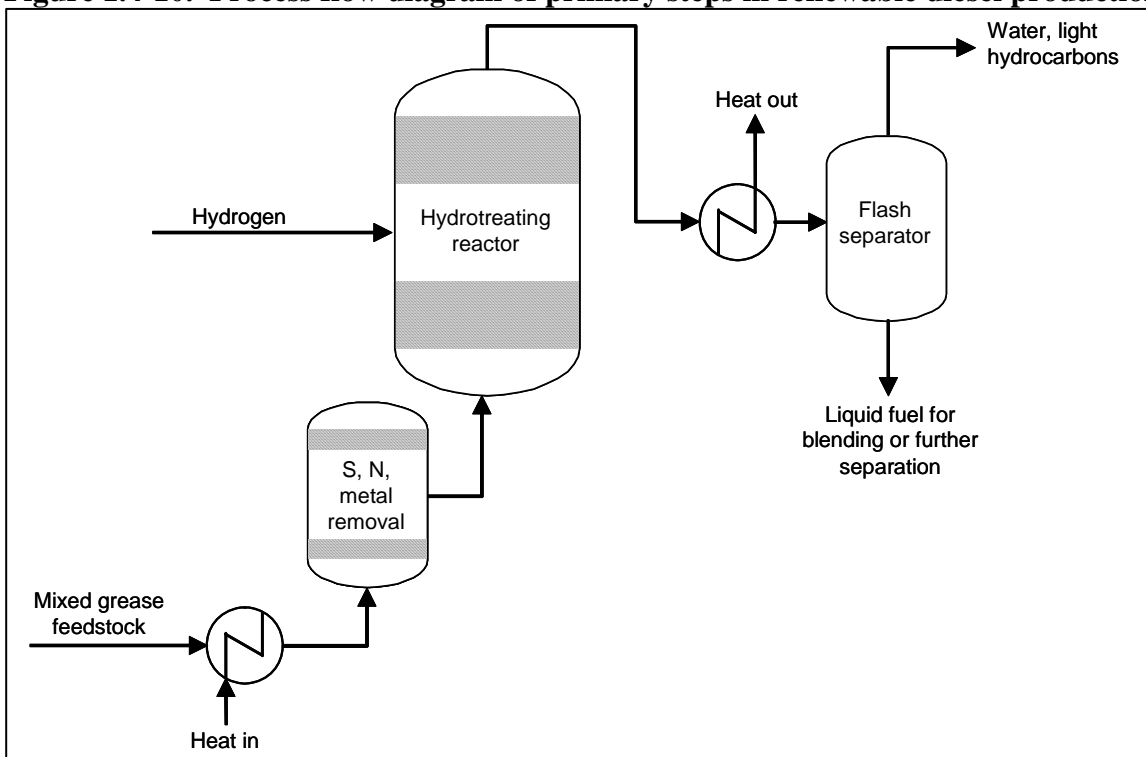

Renewable diesel will be produced either at a stand-alone facility or within the boundaries of an existing petroleum refinery. For the stand-alone facility, feedstock is brought in and finished fuel is transported out to market. This type of facility may be co-located with a rendering facility to minimize feedstock transportation and storage costs. For production within the boundaries of a refinery, the feed material may either be processed in a segregated unit (new or revamped), or co-processed with petroleum in an existing unit. In any case, the feedstock will require pre-treatment in a unit that removes contaminants such as sulfur, nitrogen, and other compounds that may poison hydrotreating catalysts.

Since December, 2007, ConocoPhillips has been producing a small amount (300-500 bbl/day) of renewable diesel at their Borger, Texas, refinery from beef tallow generated by Tyson Foods, Inc. in Amarillo, Texas.²⁸² In 2007, Dynamic Fuels, LLC., was formed by Syntroleum Corp. and Tyson Foods, Inc., to produce liquid renewable fuels. This fall Dynamic Fuels has announced ground-breaking for a 75 million gallon per year plant (5,000 bbl/day) in Geismar, Louisiana, that will use Tyson meat processing fats as feedstock to Syntroleum's Bio-Synfining process. Start-up is scheduled for 2010, with the primary product being high-quality diesel fuel that will be fungible within the existing petroleum supply system.²⁸³ This facility plans to utilize supplies of hydrogen available in the industrial park where it will be located, as well as rail and shipping infrastructure already in place nearby.²⁸⁴

Syntroleum Corp was founded in 1984 and holds a number of patents in gas-to-liquids and biomass-to-liquids conversion processes. One of these technologies they call Synfining, a process for upgrading Fischer-Tropsch paraffins to compounds with properties more favorable

for diesel fuel. They have further adapted this process to use a variety of fats and oils as feedstocks, calling it Bio-Synfining. It is this process that will be used in the Geismar facility.

Looking internationally, the Finnish company Neste Oil began operating a 3,200 bbl/day process in Finland in 2007 to convert vegetable oils into renewable diesel. This company has plans to construct similar facilities in Singapore and the Netherlands by 2010, and eventually plans to bring on-line plants that will convert biomass to liquid fuels using gasification.²⁸⁵

Since thermochemical production of hydrocarbon fuels from fats and biomass is a relatively new endeavor to conduct on a commercial scale, we expect continued innovation and fine-tuning of the technology as these processes evolve from their roots in Fischer-Tropsch and petroleum hydrotreating processes. (This discussion ties in with cellulosic diesel in section 1.4.3.2.)

1.5 Biofuel Industry Characterization & Projected Growth

In this section we will discuss the current state of the biofuel industry and how production might grow in the future under the proposed RFS2 program. The bulk of the discussion will focus on ethanol production, but we will also provide insight on biodiesel, renewable diesel, and the evolving cellulosic diesel industry. We will start by discussing current corn ethanol production and how the industry might continue to expand under the RFS2 program as well as employ more advanced processing technologies. From there we will discuss the availability of imported ethanol from Brazil and Caribbean Basin Initiative (CBI) countries to help meet the Advanced Biofuel Standard. Following this discussion, we will characterize the present state of the cellulosic biofuel industry and talk about the likelihood of near-term commercialization based on industry plans and technological breakthroughs aided by state and federal grants, tax incentives, and loan guarantee programs. And furthermore, why we believe the industry is on track for meeting the 2010 Cellulosic Biofuel Standard set by EISA. We will end the discussion by forecasting where potential cellulosic biofuel plants could be located in the U.S. based on feedstock availability. This information, along with projected corn ethanol plant locations and imported ethanol locations, will be used as an input into the distribution analysis (discussed later in Section 1.6) and the emissions and air quality modeling (discussed in Chapter 3). Finally, we will conclude our industry characterization by discussing the present state of the biomass-based diesel industry and how we expect biodiesel production to grow in the future and renewable diesel production to emerge. For a more in-depth discussion of corn ethanol, imported ethanol, cellulosic ethanol/diesel, biodiesel, and renewable diesel processing technologies, refer to Section 1.4.

1.5.1 Corn Ethanol

The majority of domestic biofuel production currently comes from plants processing corn and other similarly-processed grains in the Midwest. However, there are a handful of plants located outside the Corn Belt and a few plants processing simple sugars from food or beverage waste. In this subsection, we will talk about the present state of the corn ethanol industry and how we expect things might change in the future under the proposed RFS2 program. At the end

of this section (Section 1.5.1.5) we will summarize an earlier May 2008 corn ethanol industry assessment that was used to project future corn/starch ethanol plant locations for various impact analyses associated with this proposed rule.

1.5.1.1 Historic/Current Production

The United States is currently the largest ethanol producer in the world. In 2008, the U.S. produced almost 9 billion gallons of fuel ethanol for domestic consumption, the majority of which came from domestically-grown corn.²⁸⁶ Although the U.S. ethanol industry has been in existence since the 1970s, it has rapidly expanded over the past few years due to the phase-out of methyl tertiary butyl ether (MTBE)^X, elevated crude oil prices, state mandates and tax incentives, the introduction of the Federal Volume Ethanol Excise Tax Credit (VEETC)^Y, and the implementation of the existing RFS1 program^Z. As shown in Figure 1.5-1, U.S. ethanol production has grown exponentially over the past decade.

^X For more information on how the phase-out of MTBE helped spur ethanol production/consumption, refer to Section 1.7.1.1.

^Y On October 22, 2004, President Bush signed into law H.R. 4520, the American Jobs Creation Act of 2004 (JOBS Bill), which created the Volumetric Ethanol Excise Tax Credit (VEETC). The \$0.51/gal VEETC for ethanol blender replaced the former fuel excise tax exemption, blender's credit, and pure ethanol fuel credit. However, the recently-enacted Farm Bill has modified the alcohol credit so that corn ethanol gets a reduced credit of \$0.45/gal. The 2008 Farm Bill also gives cellulosic biofuel a credit of \$1.01/gal. Both credits appear to be valid through the end of 2012.

^Z On May 1, 2007, EPA published a final rule (72 FR 23900) implementing the Renewable Fuel Standard (RFS) required by the Energy Policy Act of 2005. The RFS requires that 4.0 billion gallons of renewable fuel be blended into gasoline/diesel by 2006, growing to 7.5 billion gallons by 2012.

Figure 1.5-1.
Historical Growth in U.S. Corn/Starch Ethanol Production²⁸⁷

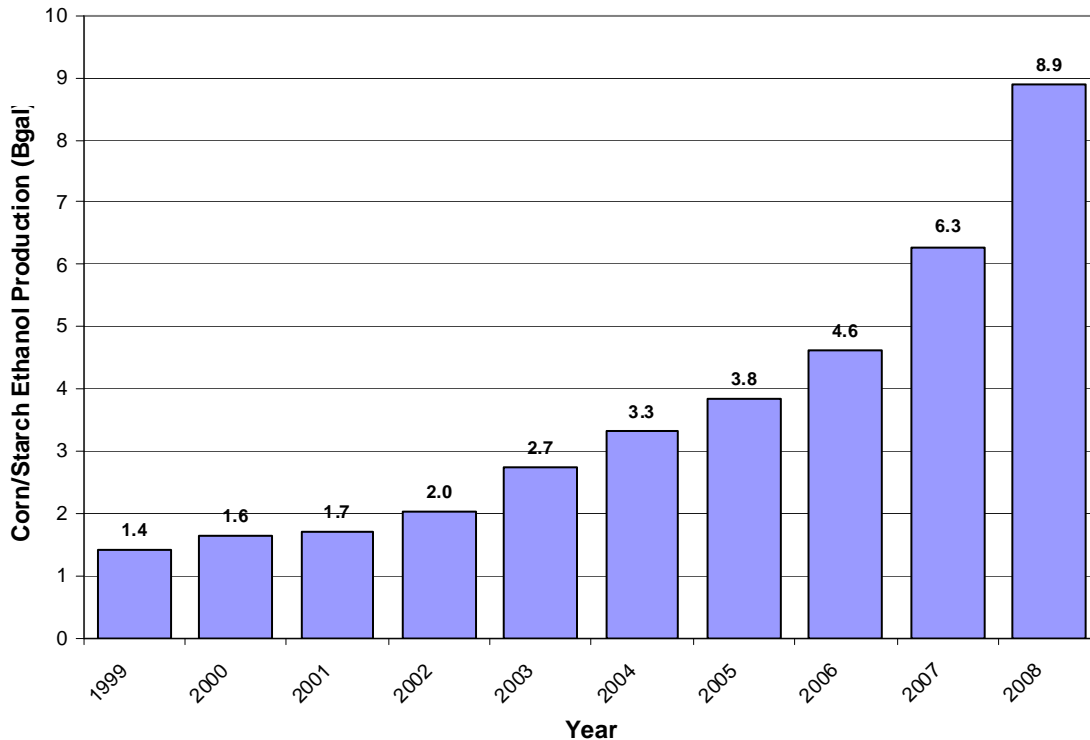

As of April 2009, there were 169 fuel ethanol plants operating in the U.S. with a combined estimated production capacity of 10.5 billion gallons per year.^{AA288289} This does not include a number of ethanol plants that are currently idled.^{BB} The majority of today's ethanol (over 91% by volume) is produced exclusively from corn. Another 11% comes from a blend of corn and/or similarly processed grains (milo, wheat, or barley) and less than half a percent is produced from cheese whey, waste beverages, and sugars/starches combined. A summary of U.S. ethanol production by feedstock is presented in Table 1.5-1.

^{AA} Our April 2009 corn/starch ethanol industry characterization was based on a variety of data sources including: Renewable Fuels Association (RFA) Ethanol Biorefinery Locations (updated March 31, 2009); Ethanol Producer Magazine (EPM) Current plant list (last modified on April 7, 2009), and ethanol producer websites. The baseline does not include ethanol plants whose primary business is industrial or food-grade ethanol production nor does it include plants that might be located in the Virgin Islands or U.S. territories. Where applicable, current ethanol plant production levels have been used in lieu of nameplate capacities to estimate plant production. The April 2009 information presented in this section reflects our most recent knowledge of the corn/starch ethanol industry. However, for various NPRM impact analyses, an earlier May 2008 industry assessment was used. For more on this assessment, refer to Section 1.5.1.5.

^{BB} In addition to idled plants, the assessment does not include idled production capacity at facilities that are currently operating at 50% or less than their nameplate capacity.

**Table 1.5-1.
Current Corn/Starch Ethanol Production Capacity by Feedstock**

Plant Feedstock (Primary Listed First)	Capacity MGY	% of Capacity	No. of Plants	% of Plants
Corn ^a	9,605	91.2%	144	85.2%
Corn, Milo ^b	717	6.8%	14	8.3%
Corn, Wheat	130	1.2%	1	0.6%
Milo	3	0.0%	1	0.6%
Wheat, Milo	50	0.5%	1	0.6%
Cheese Whey	5	0.0%	1	0.6%
Waste Beverages ^c	19	0.2%	5	3.0%
Waste Sugars & Starches ^d	7	0.1%	2	1.2%
Total	10,535	100%	169	100%
^a Includes one facility processing seed corn, two facilities also operating pilot-level cellulosic ethanol plants, and four facilities with plans to build pilot-level cellulosic ethanol plants or incorporate biomass feedstocks in the future. ^b Includes one facility processing a small amount of molasses in addition to corn and milo. ^c Includes two facilities processing brewery waste. ^d Includes one facility processing potato waste that intends to add corn in the future.				

As shown in Table 1.5-1, of the 169 operating plants, 161 plants processing corn and/or other similarly processed grains. Of these facilities, 150 utilize dry-milling technologies and the remaining 11 plants rely on wet-milling processes. Dry mill ethanol plants grind the entire kernel and generally produce only one primary co-product: distillers grains with solubles (DGS). The co-product is sold wet (WDGS) or dried (DDGS) to the agricultural market as animal feed. However, there are a growing number of dry mill ethanol plants pursuing front-end corn fractionation or back-end corn oil extraction to produce fuel-grade corn oil for the biodiesel industry. There are also additional plants pursuing cold starch fermentation and other energy-saving processing technologies. For more on the dry-milling and wet-milling processes as well as emerging advanced technologies, refer to Section 1.4.1.

In contrast to traditional dry mill plants, wet mill facilities separate the kernel prior to processing into its component parts (germ, fiber, protein, and starch) and produce other co-products (usually gluten feed, gluten meal, and food-grade corn oil) in addition to DGS. Wet mill plants are generally more costly to build but are larger in size on average. As such, 11.5% of the current grain ethanol production comes from the 11 previously-mentioned wet mill facilities listed in Table 1.5-2.

**Table 1.5-2.
Existing Wet Mill Corn Ethanol Plants**

Ethanol Plant/Company	Location	Capacity MGY	% of Tot Capacity
Archer Daniels Midland ^a	Cedar Rapids, IA	250	2.4%
Archer Daniels Midland ^a	Clinton, IA	190	1.8%
Archer Daniels Midland ^a	Columbus, NE	95	0.9%
Archer Daniels Midland ^a	Decatur, IL	290	2.8%
Archer Daniels Midland ^a	Marshall, MN	40	0.4%
Aventine Renewable Energy	Pekin, IL	100	0.9%
Cargill, Inc.	Eddyville, IA	35	0.3%
Cargill, Inc.	Blair, NE	85	0.8%
Grain Processing Corp	Muscatine, IA	20	0.2%
Penford Products	Cedar Rapids, IA	45	0.4%
Tate & Lyle	Loudon, TN	66	0.6%
Total		1,216	11.5%

^aEstimated plant capacities.

The remaining eight ethanol plants process cheese whey, waste beverages or sugars/starches and operate differently than their grain-based counterparts. These small production facilities do not require milling and operate a simpler enzymatic fermentation process. A summary of today's average ethanol plant sizes is found in Table 1.5-3 below.

**Table 1.5-3.
Average Corn/Starch Plant Sizes**

Processing Technology	Capacity MGY	% of Capacity	No. of Plants	% of Plants	Avg. Size MGY
Dry Milling ^a	9,289	88.2%	150	88.8%	61.9
Wet Milling	1,216	11.5%	11	6.5%	110.5
Other ^a	30	0.3%	8	4.7%	3.8
Total	10,535	100.0%	169	100.0%	62.3

^aIncludes four facilities that plan on incorporating cellulosic feedstocks at their existing corn ethanol plants in the future. If plans come to fruition, these plants will need additional front end technology to supplement their existing dry mill processes.

^bFacilities that do not process traditional grain-based crops and thus do not require milling. This category includes plants processing cheese whey, waste beverages or sugars & starches.

Ethanol production is a relatively resource-intensive process that requires the use of water, electricity, and steam.^{CC} Steam needed to heat the process is generally produced on-site or by other dedicated boilers. The ethanol industry relies primarily on natural gas. Of today's

^{CC} For more on plant energy requirements, refer to Section 1.5.1.3.

169 ethanol production facilities, 142 burn natural gas^{DD} (exclusively), three burn a combination of natural gas and biomass, one recently started burning a combination of natural gas, landfill syngas and wood, and two burn a combination of natural gas and syrup from the process. In addition, 20 plants burn coal as their primary fuel and one burns a combination of coal and biomass. Our research suggests that 25 plants currently utilize cogeneration or combined heat and power (CHP) technology, although others may exist. CHP is a mechanism for improving plant energy efficiency by using a single fuel to generate both power and thermal energy. For more on this technology, refer to Section 1.4.1.3. A summary of the energy sources and CHP technology utilized by today's ethanol plants is found in Table 1.5-4.

**Table 1.5-4.
Current Corn/Starch Ethanol Production Capacity by Energy Source**

Plant Energy Source (Primary Listed First)	Capacity MGY	% of Capacity	No. of Plants	% of Plants	CHP Tech.
Coal ^a	1,868	17.7%	20	11.8%	9
Coal, Biomass	50	0.5%	1	0.6%	0
Natural Gas ^b	8,294	78.7%	142	84.0%	15
Natural Gas, Biomass ^c	113	1.1%	3	1.8%	1
Natural Gas, Landfill Biogas, Wood	110	1.0%	1	0.6%	0
Natural Gas, Syrup	101	1.0%	2	1.2%	0
Total	10,535	100.0%	169	100.0%	25
^a Includes four plants that are permitted to burn biomass, tires, petroleum coke, and wood waste in addition to coal and one facility that intends to transition to biomass in the future. ^b Includes one facility that intends to switch to biomass, one facility that intends to burn thin stillage biogas, and two facilities that might switch to coal in the future. ^c Includes one facility processing bran in addition to natural gas.					

Since the majority of ethanol is made from corn, it is no surprise that most of the plants are located in the Midwest near the Corn Belt. Of today's 169 ethanol production facilities, 151 are located in the 15 states comprising PADD 2. For a map of the Petroleum Administration for Defense Districts or PADDs, refer to Figure 1.5-2.

^{DD} Facilities were assumed to burn natural gas if the plant boiler fuel was unspecified or unavailable on the public domain.

**Figure 1.5-2.
Petroleum Administration for Defense Districts**

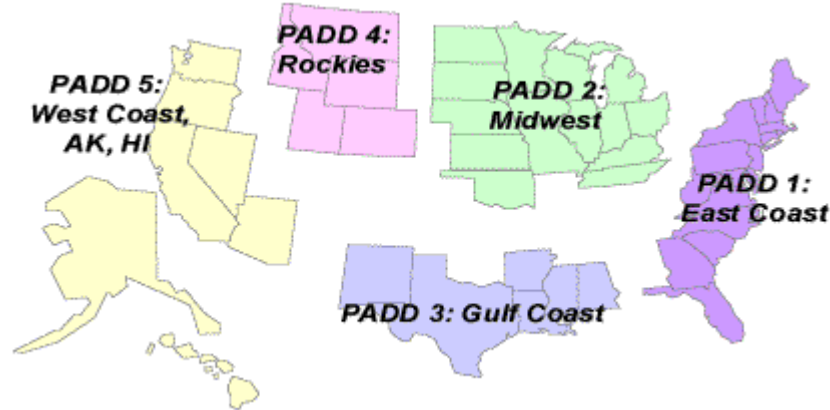

As a region, PADD 2 accounts for 94% (or almost 10 billion gallons) of today's estimated ethanol production capacity, as shown in Table 1.5-5.

**Table 1.5-5.
Current Corn/Starch Ethanol Production Capacity by PADD**

PADD	Capacity MGY	% of Capacity	No. of Plants	% of Plants
PADD 1	150	1.4%	3	1.8%
PADD 2	9,900	94.0%	151	89.3%
PADD 3	194	1.8%	3	1.8%
PADD 4	160	1.5%	7	4.1%
PADD 5	131	1.2%	5	3.0%
Total	10,535	100.0%	169	100.0%

Leading the Midwest in ethanol production are Iowa, Nebraska, Illinois, Nebraska, Minnesota, and South Dakota. Together, these five states' 98 ethanol plants account for two-thirds (or just over 7 billion gallons) of the nation's ethanol production capacity. However, although the majority of ethanol production comes from PADD 2, there are a growing number of plants situated outside the traditional Corn Belt. Our April 2009 industry assessment indicates that Arizona, California, Colorado, Georgia, Idaho, Kentucky, Mississippi, New York, Oklahoma, Oregon, Texas and Wyoming all have one or more operational ethanol plants. Some of these facilities ship in feedstocks (namely corn) from the Midwest, others rely on locally grown/produced feedstocks, while others rely on a combination of the two. A summary of ethanol production capacity by state is presented in Table 1.5-6.

**Table 1.5-6.
Current Corn/Starch Ethanol Production Capacity by State**

State	Capacity MGY	% of Capacity	No. of Plants	% of Plants
Iowa	3,011	28.6%	37	21.9%
Illinois	1,142	10.8%	11	6.5%
Nebraska	1,091	10.4%	19	11.2%
Minnesota	951	9.0%	18	10.7%
South Dakota	836	7.9%	13	7.7%
Indiana	714	6.8%	9	5.3%
Wisconsin	529	5.0%	9	5.3%
Kansas	439	4.2%	11	6.5%
Ohio	320	3.0%	5	3.0%
Missouri	261	2.5%	6	3.6%
Michigan	215	2.0%	4	2.4%
Tennessee	176	1.7%	2	1.2%
North Dakota	175	1.7%	4	2.4%
Colorado	146	1.4%	5	3.0%
Texas	140	1.3%	2	1.2%
Georgia	100	1.0%	2	1.2%
Mississippi	54	0.5%	1	0.6%
New York	50	0.5%	1	0.6%
Arizona	50	0.5%	1	0.6%
California	41	0.4%	3	1.8%
Kentucky	40	0.4%	2	1.2%
Oregon	40	0.4%	1	0.6%
Wyoming	9	0.1%	1	0.6%
Idaho	5	0.0%	1	0.6%
Oklahoma	2	0.0%	1	0.6%
Total	10,535	100.0%	169	100.0%

The U.S. ethanol industry is currently comprised of a mixture of company-owned plants and locally-owned farmer cooperatives (co-ops). The majority of today's ethanol production facilities are company-owned and, on average, these plants are larger in size than farmer-owned co-ops. Accordingly, company-owned plants account for almost 80% of today's ethanol production capacity.²⁹⁰ Furthermore, 30% of the total domestic product comes from 38 plants owned by just three different companies – POET Biorefining, Archer Daniels Midland (ADM), and Valero Renewables (refer to Figure 1.5-3 below). Valero recently entered into the renewable fuels business by acquiring five corn ethanol plants and one construction site from bankrupted VeraSun Energy Corporation. Valero has since purchased two more VeraSun plants, but at the time of our April 2009 assessment these plants had not been brought back online yet.

**Figure 1.5-3.
Current Corn/Starch Ethanol Production Capacity by Company**

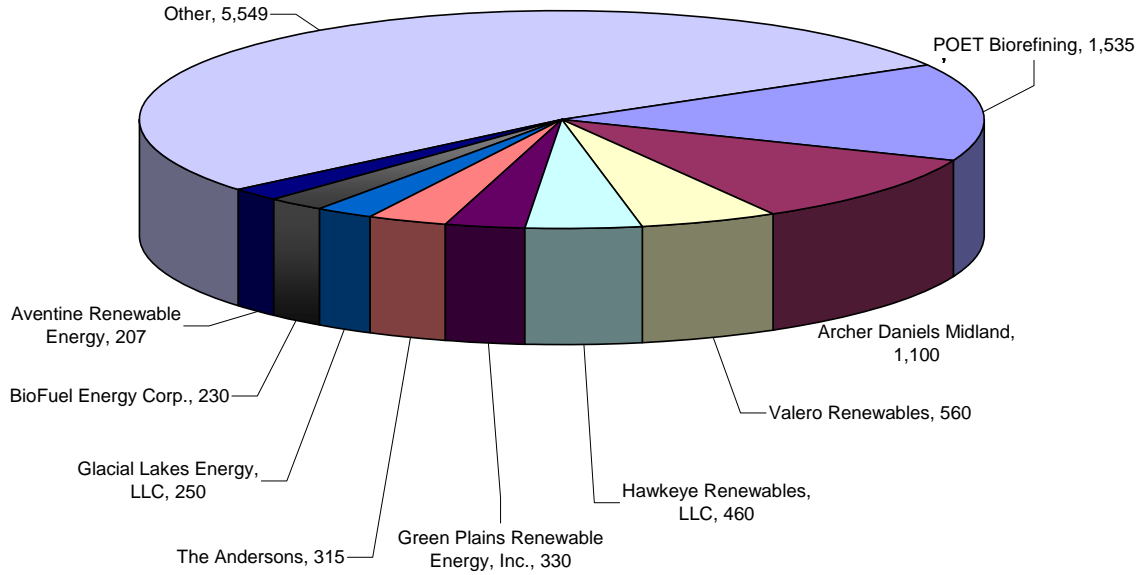

1.5.1.2 Forecasted Production Under RFS2

As highlighted above, 10.5 billion gallons of corn/starch ethanol plant capacity was online as of April 2009. So even if no additional capacity was added, U.S. ethanol production would grow from 2008 to 2009, provided facilities continue to operate at or above today’s production levels. And despite today’s temporary unfavorable market conditions (i.e., low ethanol market values), we expect the ethanol industry will continue to expand in the future under RFS2. Although there is not a set corn ethanol standard, EISA allows for 15 billion gallons of the 36-billion gallon renewable fuel standard to be met by conventional biofuels. And we expect that corn and other sugar or starch-based ethanol will fulfill this requirement. Furthermore, we project that all new corn/starch ethanol plant capacity brought online under RFS2 would either meet the conventional biofuel GHG threshold requirement^{EE} or meet the grandfathering requirement (for more information, refer to Section 1.5.1.4).

In addition to the 169 corn/starch ethanol plants that are currently online today, 36 plants are presently idled. Some of these constructed facilities (namely smaller ethanol plants) have been idled for quite some time, whereas other plants have just recently been put into “hot idle” mode. A number of ethanol producers (e.g., VeraSun) are idling operations, putting projects on hold, selling off plants, and even filing for Chapter 11 bankruptcy. In addition, we are aware of

^{EE} The lifecycle assessment values which assume a 2% discount rate over a 100-year timeframe.

two facilities that are currently operating at 50% or less than their nameplate capacity. As crude oil and gasoline prices rise again in the future, corn ethanol production will become more viable again and we expect that these plants will resume operations. At the time of our April 2009 ethanol industry assessment, there were also 19 new ethanol plants under construction in the U.S, and two plant expansion projects underway.^{FF} While many of these projects are also on hold due to current economic conditions, we expect these facilities will eventually come online under the RFS2 program. A summary of the projected industry growth is found in Table 1.5-7.

**Table 1.5-7.
Potential Corn/Starch Ethanol Industry Expansion Under RFS2**

	Growth in Ethanol Production				
	Plants Currently Online	Idled Plants / Capacity ^a	New Construction Projects	Expansion Projects	Total
Plant Capacity (MGY)	10,535	2,471	1,955	80	15,042
Total No. of Plants	169	36	19	2	226

^aIncludes the idled plant capacity of the two facilities that are currently operating at 50% or less than nameplate capacity.

While theoretically it only takes 12-18 months to build an ethanol plant^{GG}, the rate at which new plant capacity comes online will be dictated by market conditions, which will in part be influenced by the RFS2 requirements. As mentioned above, today’s proposed program will create a growing demand for corn ethanol reaching 15 billion gallons by 2015. However, it is possible that market conditions could drive demand even higher. Whether the nation will overcomply with the corn ethanol standard is uncertain and will be determined by feedstock availability/pricing, crude oil pricing, and the relative ethanol/gasoline price relationship. To measure the impacts of the proposed RFS2 program, we assumed that corn ethanol production would not exceed 15 billion gallons. We also assumed that all growth would come from new plants or plant expansion projects (in addition to idled plants being brought back online).^{HH} However, it is possible that some of the required growth could come from minor process improvements (e.g., debottlenecking) at existing facilities.

Once all the aforementioned projects are complete, we project that there will be 226 corn/starch ethanol plants operating in the U.S. with a combined production capacity of around 15 billion gallons per year. Much like today’s ethanol industry, the overwhelming majority of new plant capacity (93% by volume) is expected to come from corn-fed plants. Another 7% is

^{FF} Based on Renewable Fuels Association (RFA), Ethanol Biorefinery Locations – Under Construction/Expansions (updated April 4, 2008); Ethanol Producer Magazine (EPM), Under Construction plant list (last modified on April 14, 2008), ethanol producer websites, and follow-up correspondence with ethanol producers. It is worth noting that for our industry assessment, “under construction” implies that more than just a ground breaking ceremony has taken place. To determine whether a facility “commenced construction” by December 19, 2007 and thus will be grandfathered under the proposed RFS2, we will rely on the Expanded registration Process (refer to Section III.C of the Preamble).

^{GG} For more information on our estimated plant build rates, refer to Section 1.2.5.

^{HH} For our NPRM impact analysis, we relied on an earlier May 2008 industry assessment. For more information, refer to Section 1.5.1.5.

forecasted to come from plants processing a blend of corn and/or other grains, and a very small increase is projected to come from idled cheese whey and waste beverage plants coming back online. A summary of the forecasted ethanol production by feedstock under the RFS2 program is found in Table 1.5-8.

**Table 1.5-8.
Projected RFS2 Ethanol Production Capacity by Feedstock**

Plant Feedstock (Primary Listed First)	Additional Production		Total RFS2 Estimate	
	Capacity MGY	No. of Plants	Capacity MGY	No. of Plants
Corn ^a	4,197	49	13,802	193
Corn, Milo ^b	185	3	902	17
Corn, Wheat	8	1	138	2
Corn, Wheat, Milo	110	2	110	2
Milo	0	0	3	1
Wheat, Milo	0	0	50	1
Cheese Whey	3	1	8	2
Waste Beverages ^c	4	1	23	6
Waste Sugars & Starches ^d	0	0	7	2
Total	4,507	57	15,042	226
^a Includes one facility processing seed corn, another facility processing small amounts of whey, two facilities also operating pilot-level cellulosic ethanol plants, and four facilities with plans to build pilot-level cellulosic ethanol plants or incorporate biomass feedstocks in the future. ^b Includes one facility processing a small amount of molasses in addition to corn and milo. ^c Includes two facilities processing brewery waste. ^d Includes one facility processing potato waste that intends to add corn in the future.				

Based on current industry plans, the majority of additional corn/grain ethanol production capacity (almost 84% by volume) is predicted to come from new or expanded plants burning natural gas.^{II} Additionally, we are forecasting one new plant and a reopening of another plant relying on manure biogas. We are also predicting expansions at three coal-fired plants.^{JJ} Of the 55 new ethanol plants, our research indicates that five would utilize cogeneration, bringing the total number of CHP facilities to 30. A summary of the forecasted near-term ethanol plant energy sources is found in Table 1.5-9.

^{II} Facilities were assumed to burn natural gas if the plant boiler fuel was unspecified or unavailable on the public domain.

^{JJ} Two of the three coal-fired plant expansions appear as new plants in Table 1.5-8. This is because two of the expansion projects consist of adding dry milling plant capacity to an existing wet mill plant. However, our interpretation is that these facilities will rely on the same (potentially expanded) coal-fired boilers for process steam. Since all the aforementioned coal-fired ethanol production facilities appear to have commenced construction prior to December 19, 2007, we project that the ethanol produced at these facilities will be grandfathered under the proposed RFS2 rule. For more on our grandfathered volume estimate, refer to Section 1.5.1.4.

**Table 1.5-9.
Projected Near-Term Corn/Starch Ethanol Production Capacity by Energy Source**

Plant Energy Source (Primary Listed First)	Additional Production		Total RFS2 Estimate		
	Capacity MGY	No. of Plants	Capacity MGY	No. of Plants	CHP Tech.
Coal ^a	610	2	2,478	22	11
Coal, Biomass	0	0	50	1	0
Manure Biogas	134	2	134	2	0
Natural Gas ^b	3,763	53	12,056	195	18
Natural Gas, Biomass ^c	0	0	113	3	1
Natural Gas, Landfill Biogas, Wood	0	0	110	1	0
Natural Gas, Syrup	0	0	101	2	0
Total	4,507	57	15,042	226	30
^a Includes six plants that are permitted to burn biomass, tires, petroleum coke, and wood waste in addition to coal and one facility that intends to transition to biomass in the future.					
^b Includes one facility that intends to switch to biomass, one facility that intends to burn thin stillage biogas, and six facilities that might switch to coal in the future.					
^c Includes one facility processing bran in addition to natural gas.					

The information in Table 1.5-9 is based on short-term industry production plans at the time of our April 2009 plant assessment. However, we anticipate even more growth in advanced ethanol production technologies in the future under the proposed RFS2 program. We project that fuel prices will drive a large number of corn ethanol plants to transition from conventional boiler fuels to advanced biomass-based feedstocks. We also believe that fossil fuel/electricity prices will drive a number of ethanol producers to pursue CHP technology. For more on our projected 2022 utilization of these technologies under the RFS2 program, refer to Section 1.5.1.3.

Under the proposed RFS2 program, the majority of new ethanol production is expected to originate from PADD 2, close to where the corn is grown. However, there are a growing number of “destination” ethanol plants being built outside the Midwest in response to state production subsidies, E10/E85 retail pump incentives, and state mandates. A summary of the forecasted ethanol production by PADD under the RFS2 program can be found in Table 1.5-10.

**Table 1.5-10.
Projected RFS2 Corn/Starch Ethanol Production Capacity by PADD**

PADD	New Plants/Exp.		Total 2022 Est.	
	Capacity MGY	No. of Plants	Capacity MGY	No. of Plants
PADD 1	214	2	264	4
PADD 2	5,002	47	13,620	187
PADD 3	215	2	385	5
PADD 4	70	2	230	9
PADD 5	328	5	499	11
Total	5,829	58	14,998	216

Based on current production plans, we project that Iowa, Nebraska, and Illinois will continue to dominate ethanol production with a collective production capacity of about 7.4 billion gallons. Indiana and Minnesota are projected to be the fourth and fifth largest producers displacing South Dakota (today's fifth largest producer according to Table 1.5-6). Ethanol production is expected to grow in other Midwest states and there are also a growing number of plants that are being built outside the Corn Belt. After the proposed RFS2 program is fully implemented, we estimate that more than half of the United States will have corn/starch ethanol production as shown below in Table 1.5-11.

**Table 1.5-11.
Projected RFS2 Corn/Starch Ethanol Production Capacity by State**

State	Additional Production		Total RFS2 Estimate	
	Capacity MGY	No. of Plants	Capacity MGY	No. of Plants
Iowa	833	8	3,844	45
Nebraska	827	9	1,918	28
Illinois	538	7	1,680	18
Indiana	506	5	1,220	14
Minnesota	188	4	1,139	22
South Dakota	172	2	1,008	15
Wisconsin	27	1	556	10
Ohio	224	3	544	8
Kansas	80	2	519	13
Texas	210	2	350	4
North Dakota	171	2	346	6
Michigan	50	1	265	5
Missouri	0	0	261	6
Tennessee	60	0	236	2
California	195	4	236	7
New York	114	1	164	2
Oregon	113	1	153	2
Colorado	0	0	146	5
Georgia	0	0	100	2
North Carolina	60	1	60	1
Idaho	50	1	55	2
Washington	55	1	55	1
Mississippi	0	0	54	1
Arizona	0	0	50	1
Kentucky	0	0	40	2
New Mexico	30	1	30	1
Wyoming	0	0	9	1
Florida	4	1	4	1
Oklahoma	0	0	2	1
Total	4,507	57	15,042	226

The majority of future ethanol plants are expected to be company-owned. Of the 57 plants we are expecting to be built or brought back online under the proposed RFS2 program, 51 are expected to be owned by corporations. The leading ethanol producers will likely continue to be Archer Daniels Midland and POET Biorefining, each with over 1.5 billion gallons of annual corn ethanol production capacity. Valero Renewables, who recently purchased eight ethanol plants (including a development site) from VeraSun Energy is expected to be the third largest

ethanol producer with almost 900 million gallons of production capacity. How the rest of the company rankings fall out will be largely dependent on who purchases the remaining eight VeraSun ethanol plants (currently owned by banks and holding companies) totaling 750 million gallons of annual capacity. A summary of the projected ethanol plant ownership under the RFS2 program is found in Figure 1.5-4.

**Figure 1.5-4.
Forecasted Corn/Starch Ethanol Production Capacity by Company**

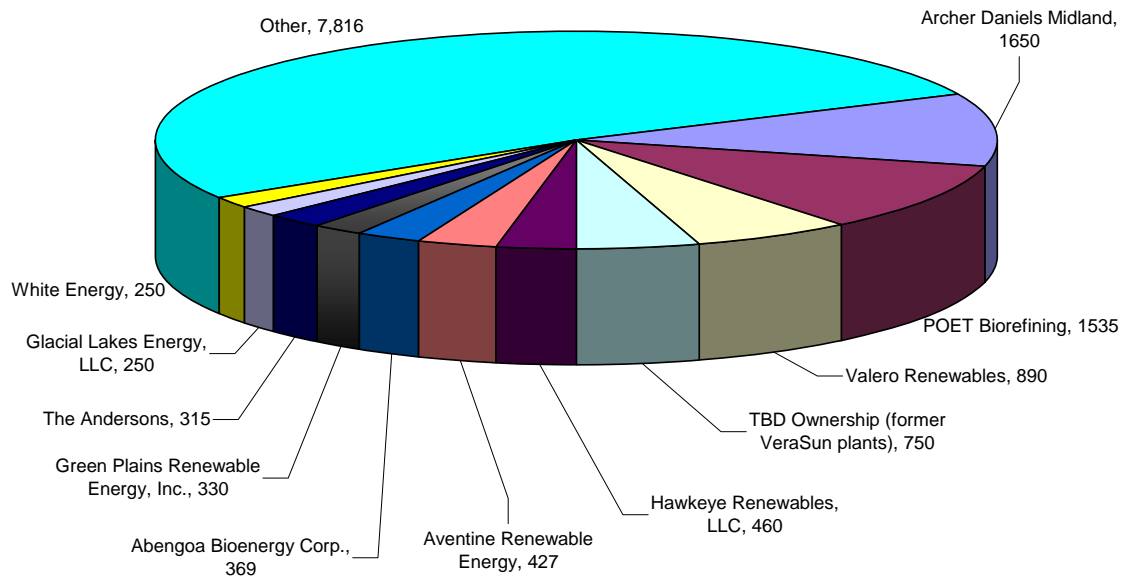

1.5.1.3 Forecasted Growth in Advanced Processing Technologies

While we can get a good idea of what the ethanol industry will look like in the near term by looking at currently existing ethanol plants and those under construction, further analysis is needed to forecast what the ethanol industry will look like in 2022. Significant changes in the primary fuel source and overall energy efficiency of ethanol production plants are likely to occur. The high price of natural gas has many ethanol plants considering alternative fuel sources. Greater biofuel availability and potential low life cycle green house gas emissions incentives may further encourage ethanol producers to transition from fossil fuels to biomass based fuels. As ethanol plants become more efficient and require less energy, their ability to use biofuels increases. Two of the biggest drawbacks to using biofuels currently are handling and storage costs. Due to the lower density of biofuels, as compared to coal, a larger area is required to store biomass with an equivalent heating value of coal. Handling costs are also increased as a larger volume of fuel must be moved. These negative impacts would be less significant in an ethanol plant using less energy. Lower overall energy use would also allow waste products and

locally produced biofuels to make up a larger portion of the total fuel supply, reducing the purchase and transportation costs of the biofuels. It is likely that plants currently using natural gas would transition to using biogas and those using coal would transition to using solid biomass due to their ability to make these transitions without investing in new boiler equipment. The same factors, cost and lower life cycle green house gas emissions, are expected to increase the number of ethanol producers using combined heat and power (CHP) technology. Projections for the primary feedstock and use of CHP technology from 2020 to 2030 are summarized in Table 1.5-12 below.

Table 1.5-12.^{KK}
Projected Primary Fuel Sources and CHP Usage

	2020	2022	2025	2030
Natural Gas Boiler	54%	49%	42%	31%
Natural Gas CHP	11%	12%	13%	15%
Coal Boiler	0%	0%	0%	0%
Coal CHP	4%	4%	4%	4%
Biomass Boiler	10%	11%	12%	15%
Biomass CHP	9%	10%	12%	15%
Biogas Boiler	12%	14%	16%	20%

The energy efficiency of ethanol plants are also expected to change significantly. New technologies are expected to both increase the efficiency of units currently used in ethanol production, as well as provide energy saving alternatives to conventional production practices. Increasing energy efficiency is a priority in many ethanol plants as it can dramatically increase profitability by reducing energy costs, the second highest cost of ethanol production behind raw materials. Several groups are currently working on technologies that could impact the ethanol industry. The Department of Energy's (DOE) Super Boiler program is expected to produce boilers with an efficiency of 94% by 2020. The National Electrical Manufacturers Association's (NEMA) premium efficiency motors are expected to be adopted more widely in the coming years. Electricity generation efficiency is also expected to increase, both on site at plants with CHP technology, and at central power plants supplying electricity to ethanol plants through the national grid. The projected energy savings from the energy efficiency improvements to units used in conventional ethanol plants in 2022 relative to 2007 is 32.1%. The projected energy savings from 2015 to 2030 are summarized in Table 1.5-13 below.

^{KK} Data based on "An Analysis of the Projected Energy Use of Future Dry Mill Corn Ethanol Plants (2010-2030)"; Steffen Mueller, University of Illinois at Chicago Energy Resource Center, October 10, 2007, Available online at: <http://www.chpcentermw.org/pdfs/2007CornEethanolEnergySys.pdf>

Table 1.5-13.^{LL}
Projected Energy Savings from Conventional Production Equipment

	2007	2015	2020	2022	2025	2030
Boiler, Efficiency	82.0%	86.0%	90.0%	91.6%	94.0%	94.0%
Energy Savings Relative to 2007	-	1.2%	8.9%	10.5%	12.8%	12.8%
Motor, Efficiency	90.0%	92.0%	93.0%	93.8%	95.0%	95.0%
Energy Savings Relative to 2007	-	2.2%	3.2%	4.0%	5.3%	5.3%
10 MW Industrial Turbine, Efficiency	31.0%	33.0%	34.0%	34.0%	34.0%	34.0%
Energy Savings Relative to 2007	-	6.1%	8.8%	8.8%	8.8%	8.8%
Central Power Plant, Efficiency	30.5%	32.5%	33.5%	33.5%	33.5%	33.5%
Energy Savings Relative to 2007	-	6.1%	8.8%	8.8%	8.8%	8.8%
Total Energy Savings Relative to 2007	-	15.6%	29.7%	32.1%	35.7%	35.7%

The same factors that drive ethanol producers to increase the energy efficiency of their equipment may also move them to consider energy saving changes to the ethanol production process. Several process changes, including raw starch hydrolysis, corn fractionation, corn oil extraction, and membrane separation, are likely to be adopted to varying degrees. The degree to which they are adopted will depend on many factors, including technology availability, capital cost of implementation, energy cost savings, and co-product revenue generation. A description of each of these technologies, including the challenges and benefits of their implementation, can be found in Section 1.4.1.3. The projected impact of the implementation of these technologies on ethanol production energy usage is to decrease the thermal energy usage by 12% and to increase the electrical energy usage by 3.8%. These numbers are based on a plant that is drying 100% of its distillers grains and solubles (DGS). Plants that dry less than 100% of their DGS would be likely to realize smaller benefits from these technologies. The projected penetration of these technologies, and the associated energy use impact, is summarized in Table 1.5-14 below.

^{LL} Data based on “An Analysis of the Projected Energy Use of Future Dry Mill Corn Ethanol Plants (2010-2030)”; Steffen Mueller, University of Illinois at Chicago Energy Resource Center, October 10, 2007,

Table 1.5-14.^{MM}
Projected Energy Savings from Process Changes

Percent of all Plants Adopting Process				
Process Improvement	2020	2022	2025	2030
Raw Starch Hydrolysis	20%	22%	25%	30%
Corn Fractionation	18%	20%	24%	30%
Corn Oil Extraction	20%	22%	25%	30%
Membrane Separation	3%	5%	5%	5%
Energy Reduction from Base Process (Thermal)				
Raw Starch Hydrolysis	16%	16%	17%	17%
Corn Fractionation	31%	31%	31%	32%
Corn Oil Extraction	4%	4%	5%	5%
Membrane Separation	29%	29%	29%	29%
Weighted Average Savings (Thermal)	10.45%	12.05%	14.39%	17.65%
Energy Reduction from Base Process (Electrical)				
Raw Starch Hydrolysis	0%	0%	0%	0%
Corn Fractionation	-9%	-9%	-8%	-8%
Corn Oil Extraction	-9%	-9%	-8%	-8%
Membrane Separation	0%	0%	0%	0%
Weighted Average Savings (Electrical)	-3.42%	-3.78%	-3.92%	-4.80%

The combined effect of the energy efficiency improvements and the production process changes are expected to reduce the energy required to produce a gallon of ethanol significantly. We project a thermal energy use reduction of 42.1% and an electrical energy use reduction of 25.8% by 2022. Based on the USDA’s 2007 estimated energy requirements of 38,717 BTU thermal energy/gallon ethanol and 3,242 BTU electrical energy/gallon ethanol for a dry mill ethanol plant fueled by natural gas drying 100% of its DDGS, we project that a similar plant in 2022 would have energy requirements of 22,435 BTU thermal energy/gallon ethanol and 2,406 BTU electrical energy/gallon ethanol.

As these technologies are incorporated into more ethanol plants, or make progress towards commercial viability we are able to make better estimates as to their impacts on energy usage and expected penetration in the ethanol industry. Additionally, recent energy price fluctuations and decreasing ethanol profit margins have likely impacted ethanol producers’ ability and willingness to invest in new technology. For the final rule our projections of the technology penetration and its impact on energy use will be reevaluated and revised as necessary. The cost impacts of these technologies will also be analyzed.

1.5.1.4 Projected Grandfathered Corn Ethanol Volume

As explained in the Section III.B.3 of the Preamble, renewable fuel produced from new facilities which commenced construction after December 19, 2007 must achieve at least a 20% reduction in lifecycle greenhouse gas emissions compared to baseline lifecycle greenhouse gas

^{MM} Data based on “An Analysis of the Projected Energy Use of Future Dry Mill Corn Ethanol Plants (2010-2030)”; Steffen Mueller, University of Illinois at Chicago Energy Resource Center, October 10, 2007, with the exception of Membrane Separation data based on conversation with Leland Vane, EPA

emissions in order to generate RINs under the proposed RFS2 program.^{NN} However, facilities that commenced construction before December 19, 2007 are exempt or “grandfathered” from the 20% GHG reduction requirement. In addition, facilities that commenced construction in 2008 or 2009 are grandfathered if they burn natural gas, biomass, or any combination thereof.

The ethanol plants (and corresponding production volumes) that are grandfathered under the RFS2 rule will be determined based on information received during the expanded registration process (refer to Section III.C of the Preamble). However, for the NPRM we thought it would be a useful exercise to estimate the volume of corn ethanol that might be grandfathered under this rule.

To do so, we stated with our assessment of ethanol plants that were operational, idled, under construction, or expanding at the time of our April 2009 assessment (refer to Table 1.5-7). This amounts to around 15 billion gallons or the entire conventional biofuel standard. As such, for this exercise we assumed that these corn ethanol plants would be representative of those in production in the future under the RFS2 program. As shown in Table 1.5-9, 12.5 billion gallons are expected to come from 203 plants burning natural gas, biomass, or a combination thereof and the remaining 2.5 billion gallons are expected to come from 23 plants burning coal as their primary fuel.

As illustrated in Figure 1.5-5 below, the 203 natural gas and/or biomass-fired plants would be grandfathered or “deemed complaint” under the proposed grandfathering provisions due to the fact that they commenced construction by 2008/2009 (refer to proposed regulation §80.1403). In addition, the 23 coal-fired plants would be grandfathered because it appears they were all either online or commenced construction prior to December 19, 2007 as summarized in Table 1.5-15.

^{NN} In accordance with Section 211(o)(2)(A)(i) of the Clean Air Act as amended by EISA.

**Figure 1.5-5.
Estimate of Grandfathered Volume of Corn Ethanol Under RFS2**

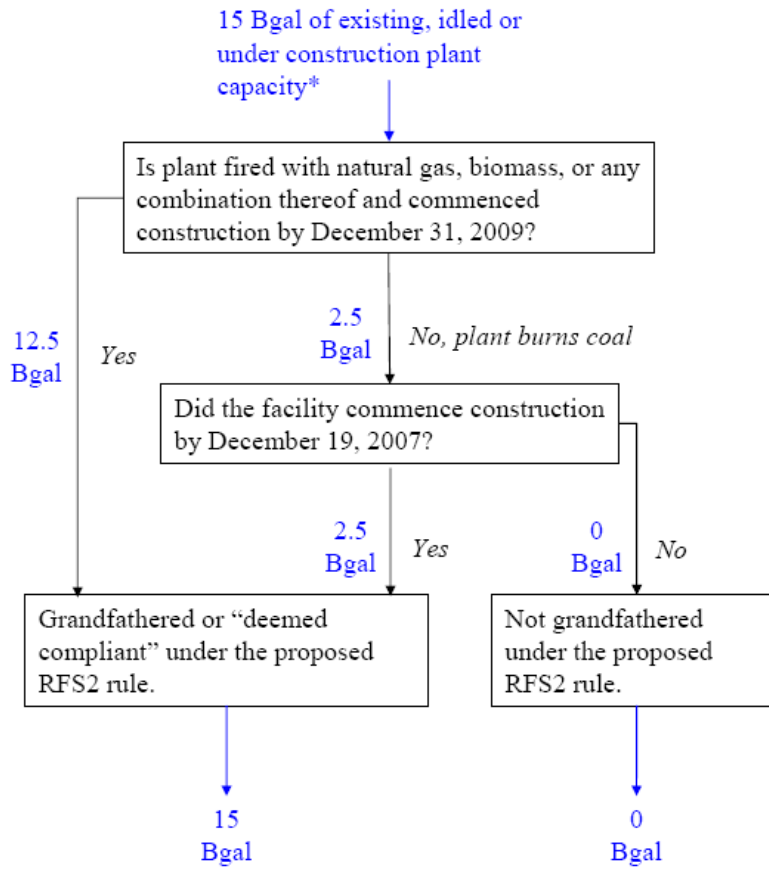

Conclusion: Based on our understanding of the corn/starch ethanol industry, all 15 Bgal of corn ethanol that is produced under the proposed RFS2 program will likely be grandfathered.

**Based on our April 2009 assessment of the corn/starch ethanol industry*

**Table 1.5-15.
Projected Coal-Fired Ethanol Plants**

Plant/Company Name	City	Operational		Under Construction	
		Capacity MGY	Est. Prod	Capacity MGY	Est. Prod
Ag Processing Inc. (AGP)	Hastings, NE	52	1992		
Archer Daniels Midland (ADM)	Cedar Rapids, IA	250	N/A ^a		
Archer Daniels Midland (ADM)	Cedar Rapids, IA			275	TBD ^b
Archer Daniels Midland (ADM)	Clinton, IA	190	N/A ^a		
Archer Daniels Midland (ADM)	Columbus, NE	95	1994		
Archer Daniels Midland (ADM)	Columbus, NE			275	TBD ^b
Archer Daniels Midland (ADM)	Decatur, IL	290	N/A ^a		
Archer Daniels Midland (ADM)	Marshall, MN	40	1988		
Archer Daniels Midland (ADM)	Peoria, IL	210	N/A ^a		
Archer Daniels Midland (ADM)	Walhalla, ND	25	N/A ^a		
Aventine Renewable Energy, Inc.	Pekin, IL	100	1981		
Blue Flint Ethanol LLC	Underwood, ND	50	Feb-07		
Cargill Inc.	Eddyville, IA	35	Sep-92		
Cargill, Inc.	Blair, NE	85	Apr-94		
Chief Ethanol Fuels Inc.	Hastings, NE	62	1985		
Corn LP ^c	Goldfield, IA	50	Dec-05		
Grain Processing Corp	Muscatine, IA	20	May-00		
Heron Lake BioEnergy, LLC	Heron Lake, MN	50	Oct-07		
Lincolnway Energy LLC	Nevada, IA	50	May-06		
Red Trail Energy, LLC	Richardton, ND	50	Jan-07		
Riverland Biofuels	Canton, IL	38	Oct-08 ^d		
Southwest Iowa Renewable Energy (SIRE)	Council Bluffs, IA	110	Feb-08 ^e		
Tate & Lyle ^f	Loudon, TN	66	N/A	60	TBD

^aIt is unclear exactly when these five ADM ethanol plants came online. However, based on permitting information, it appears they commenced construction prior to December 17, 2007.

^bIt appears these dry-mill ADM expansion projects are currently on hold at the moment. However, based on permitting information and an August 28, 2007 e-mail construction update, it appears these expansion projects began prior to December 17, 2007.

^cThis Corn LP plant burns biomass in addition to coal.

^dThis plant was originally proposed in 2001 as Central Illinois Energy. Local farmers provided start-up capital but due to lack of additional financing, ground wasn't broken on the plant until October 2006. The project went over budget and Central Illinois Energy was forced to file for bankruptcy in December 2007. Riverland Biofuels took over the project, completed construction of the plant, and started producing ethanol in October 2008. Based on the information provided, it appears this plant commenced construction prior to December 17, 2007.

^eA "groundbreaking" ceremony was held on November 11, 2006, a final permit was issued on April 19, 2007, construction was well

^fIt is unclear exactly when this Tate & Lyle ethanol plant came online and when the expansion project began. However, since both p

1.5.1.5 May 2008 Assessment of the Corn Ethanol Industry

The information presented above in Sections 1.5.1.1 and 1.5.1.2 (as well as 1.5.1.4) represents our most current assessment of the corn/starch ethanol industry. However, we relied on an earlier May 2008 industry assessment to reflect existing corn ethanol production and project future growth under the proposed RFS2 program. This was the best information available at the time our distribution, cost, emission and air quality analyses were conducted. This was before the economic recession forced many companies to idle plants, file for Chapter 11 bankruptcy and/or to sell off ethanol plants/projects. As a result, the starting ethanol

production is slightly different from the information presented in Section 1.5.1.1. However, since we assume that many of the idled plants/projects would come back online in the future; the final RFS2 projections are not that different from the information presented in Section 1.5.1.2. A summary of the relevant May 2008 industry information used to support various NPRM analyses is presented below.

Previously Existing Corn/Starch Ethanol Production

At the time of our May 2008 corn ethanol plant assessment, there were 158 fuel ethanol plants operating in the U.S. with a combined production capacity of 9.2 billion gallons per year.^{OO291292} The majority of ethanol (nearly 89% by volume) was produced exclusively from corn. Another 11% came from a blend of corn and/or similarly processed grains (milo, wheat, or barley) and less than half a percent was produced from cheese whey, waste beverages, and sugars/starches combined. A summary of the feedstocks utilized by the U.S. ethanol industry as of May 2008 is found in Table 1.5-16.

^{OO} Our May 2008 corn/starch ethanol industry characterization was based on a variety of data sources including: Renewable Fuels Association (RFA) Ethanol Biorefinery Locations (updated April 2, 2008); Ethanol Producer Magazine (EPM) Current plant list (last modified on April 14, 2008), and ethanol producer websites. The baseline does not include ethanol plants whose primary business is industrial or food-grade ethanol production. Where applicable, ethanol plant production levels were used in lieu of nameplate capacities to estimate plant production. The baseline does not include U.S. plants that were idled as of May 2008 or plants that might be located in the Virgin Islands or U.S. territories.

**Table 1.5-16.
May 2008 Corn/Starch Ethanol Production Capacity by Feedstock**

Plant Feedstock (Primary Listed First)	Capacity MGY	% of Capacity	No. of Plants	% of Plants
Corn ^a	8,141	88.8%	131	82.9%
Corn, Milo ^b	704	7.7%	14	8.9%
Corn, Wheat	130	1.4%	1	0.6%
Corn, Wheat, Milo	115	1.3%	2	1.3%
Milo	3	0.0%	1	0.6%
Wheat, Milo	50	0.5%	1	0.6%
Cheese Whey	8	0.1%	2	1.3%
Waste Beverages ^c	13	0.1%	4	2.5%
Waste Sugars & Starches ^d	7	0.1%	2	1.3%
Total	9,169	100%	158	100%
^a Includes one facility processing seed corn, one facility also operating a pilot-level cellulosic ethanol plant, and six facilities with plans to build pilot-level cellulosic ethanol plants or incorporate biomass feedstocks in the future. ^b Includes one facility processing small amounts of molasses in addition to corn and milo. ^c Includes two facilities processing brewery waste. ^d Includes one facility processing potato waste that intends to add corn in the future.				

The corn ethanol industry relies primarily on natural gas. At the time of our May 2008 plant assessment, 134 of the 158 corn/starch ethanol plants burned natural gas (exclusively).^{PP} In addition, three burned a combination of natural gas and biomass, one burned a combination of natural gas, landfill syngas and wood, while one burned a combination of natural gas and syrup from the process. In addition, 18 plants burned coal as their primary fuel and one burned a combination of coal and biomass. Our research suggested that 24 plants utilized cogeneration or combined heat and power (CHP) technology at the time of our assessment. A summary of the energy sources and CHP technology utilized by the U.S. ethanol industry as of May 2008 is found in Table 1.5-17.

^{PP} Facilities were assumed to burn natural gas if the plant boiler fuel was unspecified or unavailable on the public domain.

**Table 1.5-17.
May 2008 Corn/Starch Ethanol Production Capacity by Energy Source**

Plant Energy Source (Primary Listed First)	Capacity MGY	% of Capacity	No. of Plants	% of Plants	CHP Tech.
Coal ^a	1,720	18.8%	18	11.4%	8
Coal, Biomass	50	0.5%	1	0.6%	0
Natural Gas ^b	7,141	77.9%	134	84.8%	15
Natural Gas, Biomass ^c	113	1.2%	3	1.9%	1
Natural Gas, Landfill Syngas, Wood	100	1.1%	1	0.6%	0
Natural Gas, Syrup	46	0.5%	1	0.6%	0
Total	9,169	100.0%	158	100.0%	24

^aIncludes four plants that are permitted to burn biomass, tires, petroleum coke, and wood waste in addition to coal and one facility that intends to transition to biomass in the future.

^bIncludes one facility that intends to burn thin stillage biogas, five facilities that intend to transition to coal, and one facility that intends to switch to biomass in the future.

^cIncludes one facility processing bran in addition to natural gas.

Besides a few plants located outside of the Corn Belt, the majority of ethanol is produced in PADD close to where the corn is grown. At the time of our May 2008 ethanol industry characterization, PADD 2 accounted for 94% (or 8.6 billion gallons) of the estimated ethanol production capacity as shown in Table 1.5-18 below.

**Table 1.5-18.
May 2008 Corn/Starch Ethanol Production Capacity by PADD**

PADD	Capacity MGY	% of Capacity	No. of Plants	% of Plants
PADD 1	50	0.5%	2	1.3%
PADD 2	8,619	94.0%	140	88.6%
PADD 3	170	1.9%	3	1.9%
PADD 4	160	1.7%	7	4.4%
PADD 5	171	1.9%	6	3.8%
Total	9,169	100.0%	158	100.0%

Leading the Midwest in ethanol production were Iowa, Nebraska, Illinois, South Dakota and Minnesota. Together, these five states' 93 ethanol plants accounted for 67 percent of the nation's ethanol production capacity in May 2008. For a map of the ethanol plant locations and a summary of ethanol production capacity by state, refer to Figure 1.5-6 and Table 1.5-19 below.

Figure 1.5-6.
May 2008 Corn/Starch Ethanol Plant Locations

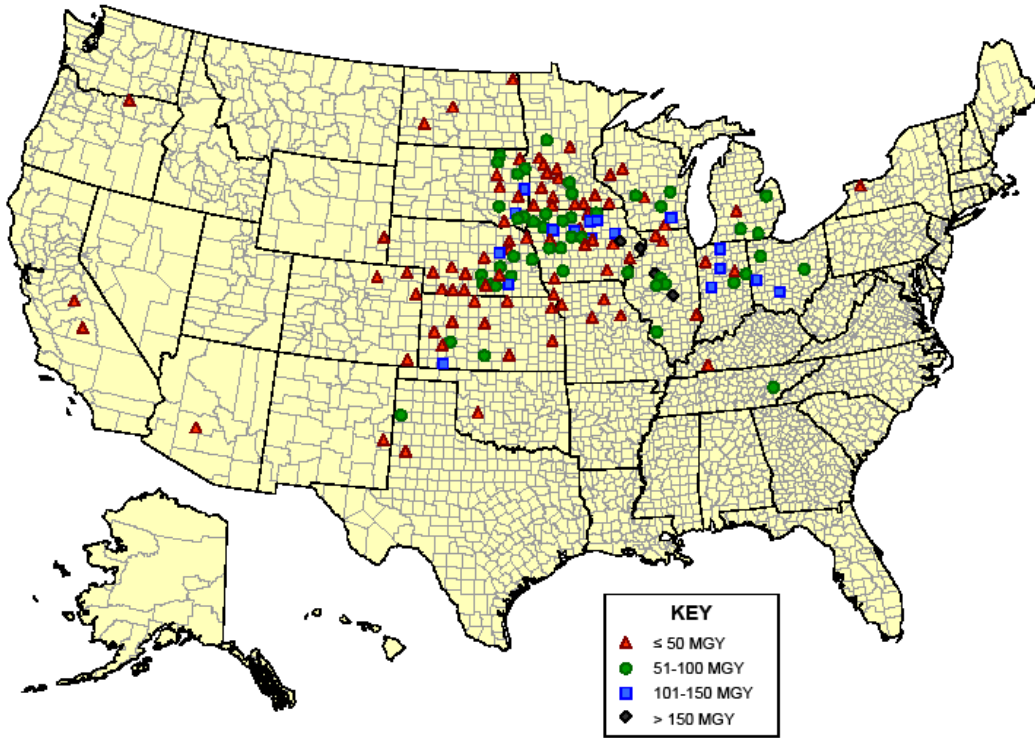

Table 1.5-19.
May 2008 Corn/Starch Ethanol Production Capacity by State

State	Capacity MGY	% of Capacity	No. of Plants	% of Plants
Iowa	2,282	24.9%	30	19.0%
Nebraska	1,278	13.9%	22	13.9%
Illinois	941	10.3%	9	5.7%
South Dakota	892	9.7%	14	8.9%
Minnesota	749	8.2%	18	11.4%
Indiana	540	5.9%	7	4.4%
Wisconsin	479	5.2%	8	5.1%
Kansas	464	5.1%	12	7.6%
Ohio	345	3.8%	4	2.5%
Michigan	214	2.3%	4	2.5%
Missouri	202	2.2%	5	3.2%
Colorado	146	1.6%	5	3.2%
Texas	140	1.5%	2	1.3%
North Dakota	125	1.4%	3	1.9%
California	81	0.9%	4	2.5%
Tennessee	66	0.7%	1	0.6%
New York	50	0.5%	1	0.6%
Arizona	50	0.5%	1	0.6%
Kentucky	40	0.4%	2	1.3%
Oregon	40	0.4%	1	0.6%
New Mexico	30	0.3%	1	0.6%
Wyoming	9	0.1%	1	0.6%
Idaho	5	0.1%	1	0.6%
Oklahoma	2	0.0%	1	0.6%
Georgia	0	0.0%	1	0.6%
Total	9,169	100.0%	158	100.0%

Preliminary Forecasted Growth in Corn/Starch Ethanol Production Under RFS2

According to our industry assessment, there were 59 ethanol plants under construction or expanding as of May 2008 with a combined production capacity of 5.2 billion gallons per year.^{QQ} These projects were at various phases of construction from conducting land stabilization work, to constructing tanks and installing ancillary equipment, to completing start-up activities. Unfavorable market conditions have recently driven a number of producers to delay construction or scrap plans altogether. However, we believe that implementation of the RFS2 program will help revitalize ethanol production. As such, we assumed that all this capacity would eventually come online as well as a number of other projects that were at advanced stages of planning at the time of our May 2008 industry assessment.

Once all the aforementioned projects are complete, we projected that there would be 216 corn/starch ethanol plants operating in the U.S. with a combined production capacity of about 15 billion gallons per year. Much like today's ethanol production facilities, the overwhelming majority of new plant capacity (95% by volume) was expected to come from corn-fed plants. The remainder was forecasted to come from plants processing a blend of corn and milo. A summary of the forecasted ethanol production by feedstock under the RFS2 program based on our May 2008 plant assessment is found in Table 1.5-20.

^{QQ} Based on Renewable Fuels Association (RFA), Ethanol Biorefinery Locations – Under Construction/Expansions (updated April 4, 2008); Ethanol Producer Magazine (EPM), Under Construction plant list (last modified on April 14, 2008), ethanol producer websites, and follow-up correspondence with ethanol producers.

**Table 1.5-20.
May 2008 Projected RFS2 Ethanol Production Capacity by Feedstock**

Plant Feedstock (Primary Listed First)	New Plants/Exp.		Total RFS2 Est.	
	Capacity MGY	No. of Plants	Capacity MGY	No. of Plants
Corn ^a	5,526	54	13,666	185
Corn, Milo ^b	303	4	1,007	18
Corn, Wheat	0	0	130	1
Corn, Wheat, Milo	0	0	115	2
Milo	0	0	3	1
Wheat, Milo	0	0	50	1
Cheese Whey	0	0	8	2
Waste Beverages ^c	0	0	13	4
Waste Sugars & Starches ^d	0	0	7	2
Total	5,829	58	14,998	216

^aIncludes one facility processing seed corn, one facility also operating a pilot-level cellulosic ethanol plant, and six facilities with plans to build pilot-level cellulosic ethanol plants or incorporate biomass feedstocks in the future.
^bIncludes one facility processing small amounts of molasses in addition to corn and milo.
^cIncludes two facilities processing brewery waste.
^dIncludes one facility processing potato waste that intends to add corn in the future.

Based on May 2008 industry plans, the majority of new corn/grain ethanol production capacity (82% by volume) was predicted to come from new or expanded plants burning natural gas. Additionally, we forecasted one new plant burning a combination of natural gas and syrup (from the process) and an expansion at an existing facility burning natural gas and biomass. Our predictions also suggest two new coal-fired ethanol plants and three expansions at existing coal-fired plants.^{RR} Finally, we projected three new plants burning alternative fuels – one relying on manure biogas, one burning biomass, and one burning a combination of biomass and thin stillage from the process.^{SS} Our research indicated that nine of the 58 new plants would utilize cogeneration, bringing the total number of CHP facilities to 33. A summary of the forecasted ethanol plant energy sources in 2022 under the RFS2 program is found in Table 1.5-21.

^{RR} Two of the three coal-fired plant expansions appear as new plants in Table 1.5-21. This is because two of the expansion projects consist of adding dry milling plant capacity to an existing wet mill plant. However, our interpretation is that these facilities will rely on the same (potentially expanded) coal-fired boilers for process steam. Since all the aforementioned coal-fired ethanol production facilities appear to have commenced construction prior to December 19, 2007, we project that the ethanol produced at these facilities will be grandfathered under the proposed RFS2 rule. For more on our grandfathered volume estimate, refer to Section 1.5.1.4.

^{SS} Thin stillage is a process liquid with 5–10 percent solids taken out of the distillers grains via centrifuge. However, construction on this alternatively fuel ethanol plant near Heyburn, ID was recently terminated. Accordingly, this plant was not included in our April 2009 RFS2 projections.

**Table 1.5-21.
Projected Near-Term Corn/Starch Ethanol Production Capacity by Energy Source
(Based on May 2008 Ethanol Industry Characterization)**

Plant Energy Source (Primary Listed First)	New Plants/Exp.		Total RFS2 Est.		
	Capacity MGY	No. of Plants	Capacity MGY	No. of Plants	CHP Tech.
Biomass	88	1	88	1	0
Coal ^a	740	4	2,460	22	12
Coal, Biomass	0	0	50	1	0
Manure Biogas	115	1	115	1	0
Natural Gas ^b	4,776	50	11,917	184	19
Natural Gas, Biomass ^c	40	0	153	3	1
Natural Gas, Landfill Biogas, Wood	0	0	100	1	0
Natural Gas, Syrup	50	1	96	2	0
Thin Stillage Biogas, Biomass	20	1	20	1	1
Total	5,829	58	14,998	216	33
^a Includes four existing plants and two under construction facilities that are permitted to burn biomass, tires, petroleum coke, and wood waste in addition to coal. Also includes one facility that intends to transition to biomass in the future. ^b Includes one facility that intends to burn thin stillage biogas, six facilities that intend to transition to coal, and one facility that intends to switch to biomass in the future. ^c Includes one facility processing bran in addition to natural gas.					

The information presented in Table 1.5-21 is based on near-term production plans at the time of our May 2008 industry assessment. As mentioned in Section 1.5.1.2, we anticipate additional growth in advanced ethanol production technologies in the future under the proposed RFS2 program. For more on our projected 2022 utilization of these technologies under the RFS2 program, refer to Section 1.5.1.3.

Based on our May 2008 assessment, 85% of new ethanol production capacity under RFS2 is expected to originate from PADD 2. For a summary of this and other forecasted PADD-level production projections, refer to Table 1.5-22.

Table 1.5-22.
May 2008 Projected RFS2 Corn/Starch Ethanol Production Capacity by PADD

PADD	New Plants/Exp.		Total RFS2 Est.	
	Capacity MGY	No. of Plants	Capacity MGY	No. of Plants
PADD 1	214	2	264	4
PADD 2	5,002	47	13,620	187
PADD 3	215	2	385	5
PADD 4	70	2	230	9
PADD 5	328	5	499	11
Total	5,829	58	14,998	216

Our May 2008 assessment suggested that Iowa, Nebraska, and Illinois would continue to dominate ethanol production under RFS2 with a collective annual production capacity of about 7.5 billion gallons. Minnesota and Indiana were projected to be the fourth and fifth largest ethanol producers. A map of the forecasted corn ethanol plant locations based on our May 2008 assessment is provided in Figure 1.5-7 and a summary of the ethanol production capacity by state is presented in Table 1.5-23.

Figure 1.5-7.
May 2008 Projected RFS2 Corn/Starch Ethanol Plant Locations

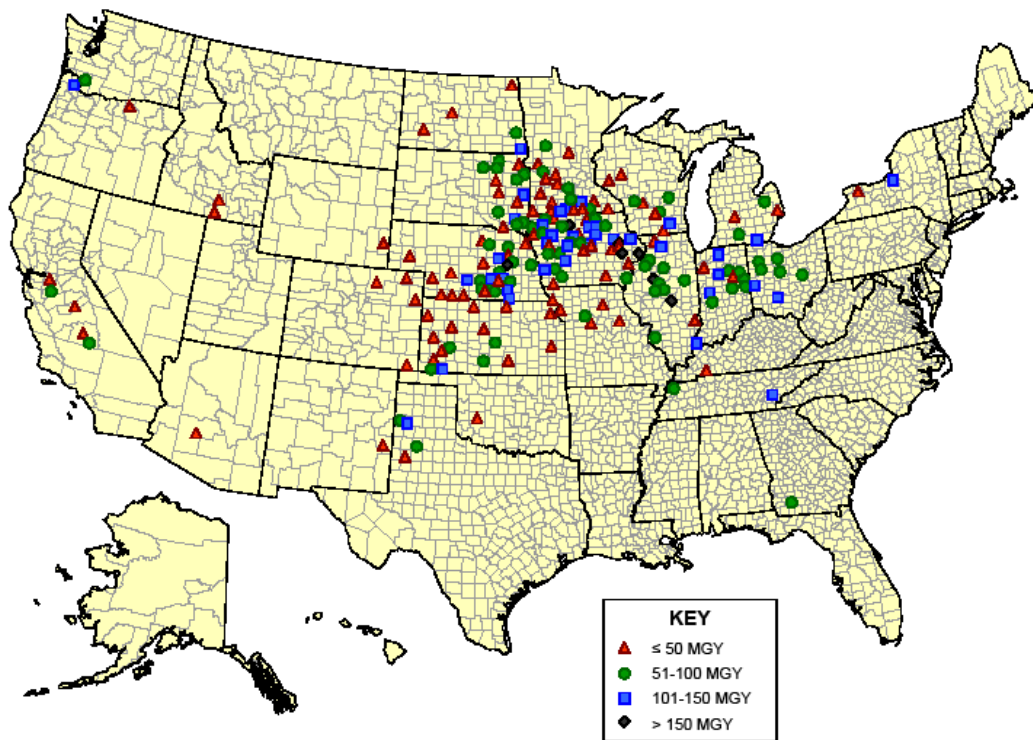

**Table 1.5-23.
May 2008 Projected RFS2 Corn/Starch Ethanol Production Capacity by State**

State	New Plants/Exp.		Total RFS2 Est.	
	Capacity MGY	No. of Plants	Capacity MGY	No. of Plants
Iowa	1,573	13	3,854	43
Nebraska	959	7	2,237	29
Illinois	465	4	1,406	13
Minnesota	440	4	1,189	22
Indiana	470	5	1,010	12
South Dakota	100	1	992	15
Kansas	203	4	667	16
Wisconsin	70	1	549	9
Ohio	185	3	530	7
Texas	215	2	355	4
North Dakota	210	2	335	5
Michigan	107	1	321	5
Missouri	60	1	262	6
California	160	3	241	7
Tennessee	160	1	226	2
New York	114	1	164	2
Oregon	113	1	153	2
Colorado	0	0	146	5
Georgia	100	1	100	2
Idaho	70	2	75	3
Washington	55	1	55	1
Arizona	0	0	50	1
Kentucky	0	0	40	2
New Mexico	0	0	30	1
Wyoming	0	0	9	1
Oklahoma	0	0	2	1
Total	5,829	58	14,998	216

1.5.2 Imported Ethanol

1.5.2.1 Historic/Current Imports and Exports

In order to assess the potential for U.S. imported ethanol, we examined the chief countries that are currently producing or consuming relatively large volumes of ethanol. In particular, we chose to focus on Brazil, the European Union (EU), Japan, India, and China to determine whether each country will likely be an importer or exporter of ethanol in the future. The following sections first describe the ethanol demands of each of these countries due to enacted or proposed mandates and goals as well as their ability to supply those demands with

domestically produced ethanol. We conclude the analysis by examining the most likely pathways for imported ethanol, namely through the Caribbean Basin Initiative (CBI) and directly from Brazil.

1.5.2.1.1 Brazil

Much of the potential of imported ethanol will depend on the ability for Brazil to supply ethanol to the United States and other countries. This is because Brazil has been a top producer and is the top exporter of ethanol in the world. In fact, many countries are interested in Brazilian produced sugarcane ethanol because it is currently the least costly method for producing ethanol. No other nation is seen as being able to supply any reasonably large amount of ethanol, and as such, it is important to devote much of the import potential discussion to Brazil.

Brazil has been steadily increasing its exports of ethanol, with total exports escalating from under 700 million gallons in 2005 to over 1200 million gallons in 2008. As seen in Figure 1.5-8, Brazil exports ethanol to many different countries around the globe. Prior to 2006, the majority of Brazilian ethanol exports flowed to the EU and Caribbean due to favorable economics. In 2006, the majority of Brazilian ethanol exports (52%) went to the U.S. as a result of the withdrawal of MTBE from the U.S. fuel pool and an increased price of ethanol. As countries create their own biofuels mandates and goals, they will also be looking to other countries such as Brazil to supply large amounts of biofuels. Countries may essentially be “competing” against one another for Brazilian ethanol in the future to meet their mandates and goals.

Figure 1.5-8. Brazil Ethanol Exports (Includes all types of ethanol).^{293,294,295}

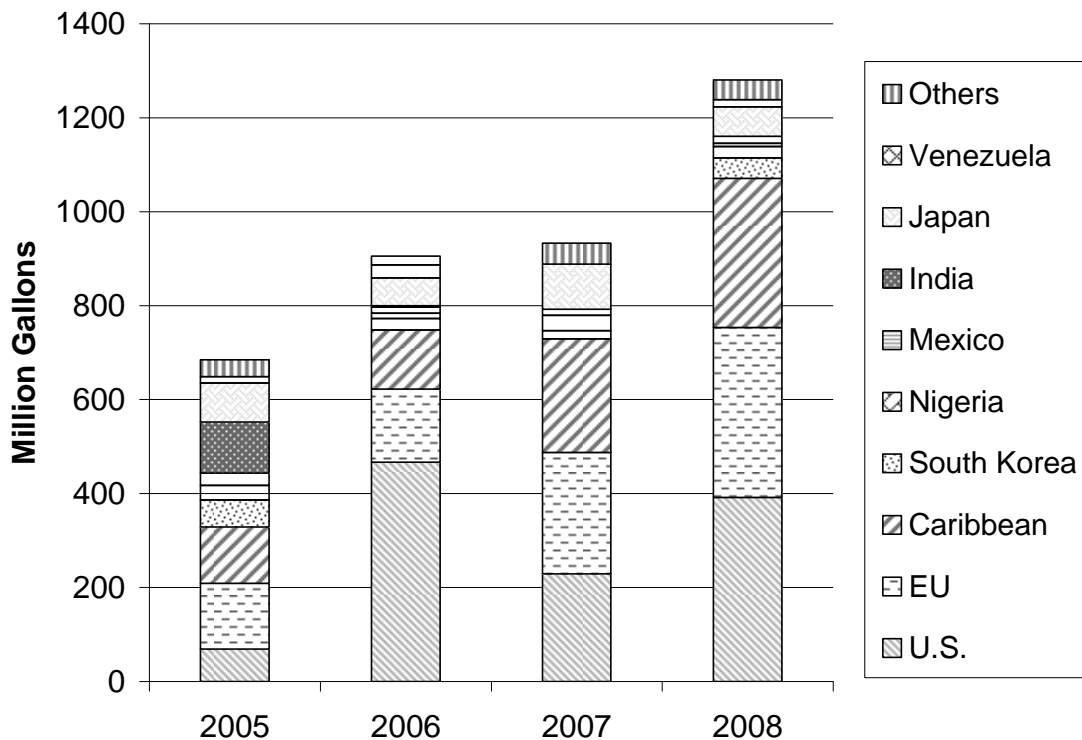

Brazil currently produces both hydrous and anhydrous ethanol. Hydrous ethanol has 96% ethanol and 4% water in its composition, whereas anhydrous ethanol is made up of 99.5% ethanol and 0.5% water.²⁹⁶ In 2006, total ethanol consumption made up 17.2% (9.9% hydrous and 7.3% anhydrous) of the vehicle fuel pool with the rest being: 27.2% Gasoline A (pure gasoline before blending with ethanol), 3.2% vehicular natural gas (VNG), 3.3% B2 (diesel blended with 2% biodiesel), and 48.9% Diesel.²⁹⁷ Of light duty vehicles only, ethanol accounts for 36.1% of the total fuel pool in Brazil.

While hydrous ethanol is used directly in Otto-cycle motors (100%), anhydrous ethanol is mixed with pure gasoline at 20-25% by volume. Production of anhydrous ethanol to be mixed with gasoline has fallen since the 2005/2006 harvest, on account of the smaller share of cars running exclusively on gasoline. This was especially due to the success of flex vehicles with Brazilian customers.²⁹⁸ In fact, sales of flex-fuel vehicles (FFVs) in Brazil, those that can use any mixture of gasoline and ethanol from 0 to 100%, have grown dramatically, with domestic FFV sales representing 91% of vehicles sold in 2008.²⁹⁹ Hydrous ethanol production, on the other hand, has grown almost constantly in recent years. However, in the 2008/2009 crop year, growth in hydrous ethanol was much larger, with hydrous ethanol accounting for 65% of ethanol production in Brazil. Figure 1.5-9 shows the historical production of hydrous and anhydrous ethanol in Brazil.

Figure 1.5-9.
Historical Ethanol Production of Hydrous and Anhydrous Ethanol in Brazil.³⁰⁰

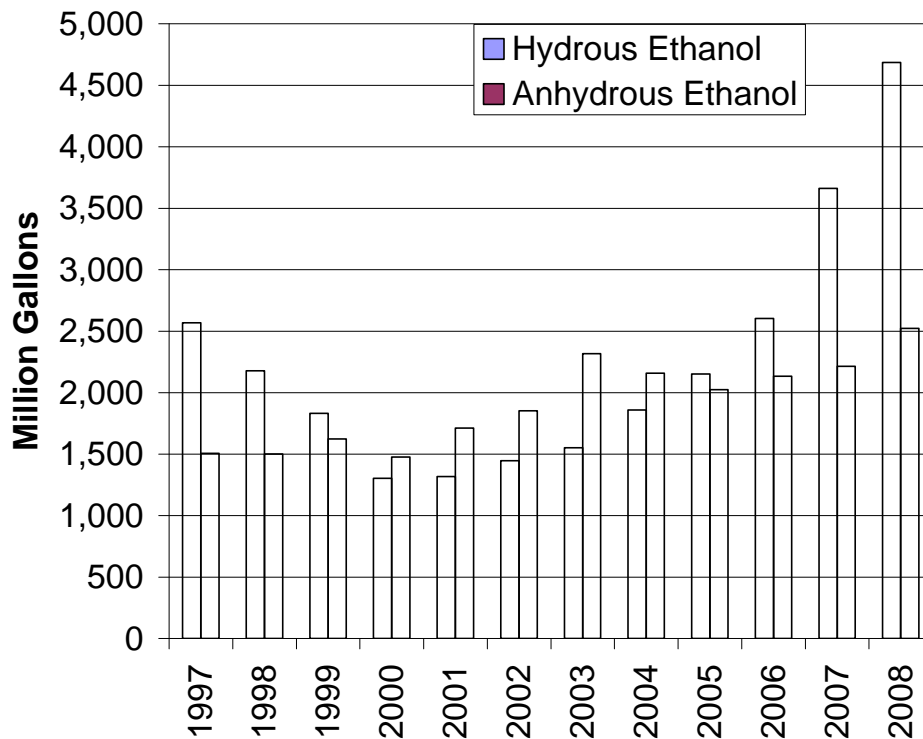

In contrast to Brazil, ethanol consumed in the U.S. must first be converted to anhydrous ethanol before its use in conventional or FFV vehicles. This differs from Brazil because Brazilian FFVs can use hydrous ethanol, or E100 (100% ethanol), whereas U.S. FFVs can only use up to E85 (85% ethanol and 15% gasoline by volume). As a result, if hydrous ethanol is exported from Brazil, it must be dehydrated somewhere else before it is used in the U.S. This is the case for the majority of ethanol exported from Brazil to the Caribbean, where it is dehydrated and often re-exported to the U.S. for consumption.

In terms of future ethanol production, however, there has been much speculation about Brazil’s ability to increase production. Sugarcane analyst Datagro recently stated that Brazil’s ethanol fuel production would have to grow by approximately 800 million gallons a year through 2025 to keep up with demand at home and abroad.³⁰¹ Estimates of future ethanol production in Brazil range greatly. See Figure 1.5-10. Brazil’s government has adopted plans to meet global demand by tripling production by 2020.³⁰² This would mean a total capacity of approximately 12.7 billion gallons, to be achieved through a combination of efficiency gains, greenfield projects, and infrastructure expansions. Estimates for the investment required tend to range from \$2 billion to \$4 billion a year. Other estimates indicate that based on current projects the required investment in capacity expansion is \$3-4 billion annually.³⁰³ If global demand were to increase much more than Brazil is planning, then capacity would need to expand even further and thus greater investment dollars would be required.

Figure 1.5-10. Estimated Brazilian Ethanol Production Volumes³⁰⁴

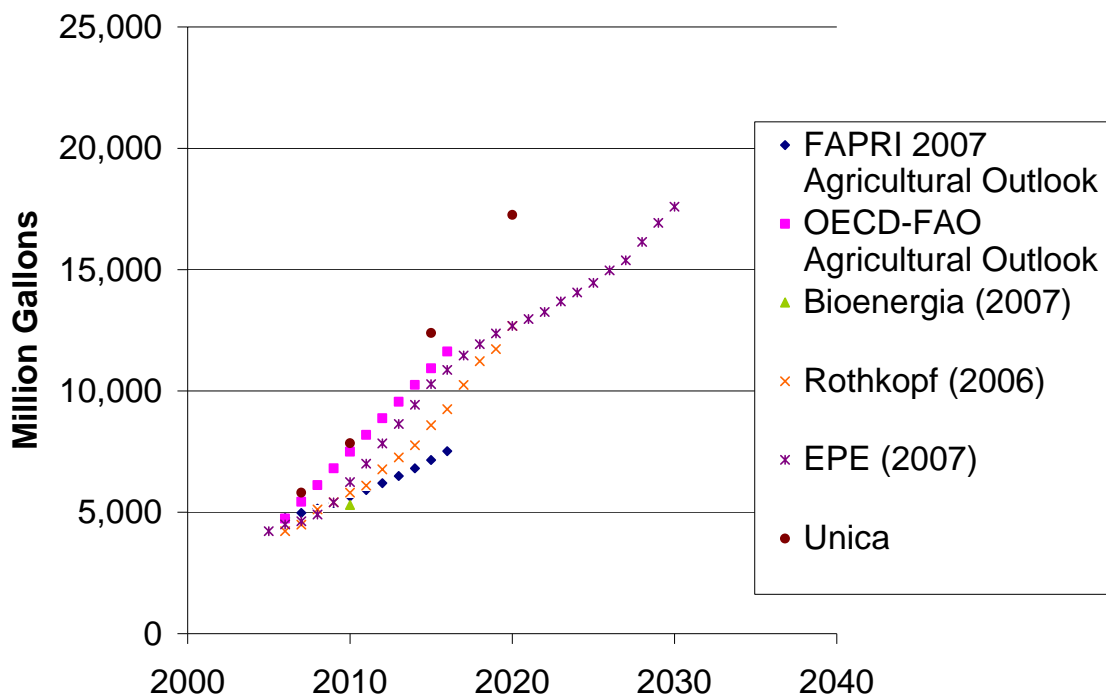

To meet the growing demand, the Brazilian sugar and ethanol industry is already rapidly expanding and numerous mills have been planned. This includes over 90 new plants (354 existing plants in 2007/2008) that will be set up in the next five years, allowing the expansion of processing from 383 to 560 million tonnes of sugarcane by 2010/2011.^{305,306} Brazil's state-owned development bank BNDES said the country is set to invest \$13.1 billion between 2007 and 2011 in 89 of these new sugar and ethanol mills.³⁰⁷ Some estimate even more, where investments in sugarcane processing factories are expected to top \$23 billion over the next four years.³⁰⁸ Recent investments also include a project by Odebrecht, a Brazilian engineering company that will invest \$2.6 billion dollars over the next decade to build 12-15 plants with a combined capacity to crush at least 30-40 Mt/year of sugarcane and produce ~ 400 million gallons per year of ethanol.³⁰⁹ Even U.S. ethanol producer ADM is preparing to enter the sugarcane business in Brazil. A recent quote by ADM's senior vice president of strategy, Steve Mills, said that sugar cane ethanol is now "a key component" of ADM's short-term strategy and, "We're devoting a lot of time and energy to this area. We're not talking about something 10 years down the road. It's on the front burner."³¹⁰ To put these estimates of production capacity expansion into perspective, 383 million tonnes of sugar cane yielded 26.2 million tonnes of raw sugar and approximately 4.2 billion gallons of ethanol in 2005. If we assume the same split between sugar and ethanol then by 2010 we could expect an additional ~2 billion gallons of ethanol produced from Brazil each year from now until 2010/2011.

In addition to expanding sugarcane production and ethanol production plant capacity, Brazil will need to improve its current ethanol distribution infrastructure. Brazil's transport system is predominantly road-based.³¹¹ Railroad infrastructure and use of a waterway system is lacking, as well as very low availability of multi-mode terminals. Logistics currently represent 22% of the export expenses and is one of the areas where costs need to be reduced in order for Brazilian ethanol to become more competitive abroad.³¹²

One way of dealing with this lack of infrastructure is to invest in enlarging the pipeline network. Petrobras, Brazil's largest petroleum refiner is planning to build a pipeline to transport ethanol destined for export from the states of Sao Paulo, Minas Gerais, Mato Grosso, Mato Grosso do Sul, Goias, and Parana. The pipeline is anticipated to go online in October 2010, with \$232 million invested in the project. By 2012 Petrobras will spend more than \$1.6 billion to improve logistics infrastructure to transport Brazilian production. By 2011, Petrobras has the goal of exporting 920 million gallons per year.³¹³ Recent updates indicate a perhaps more optimistic timeframe for completion, stating that Petrobras will complete the first of two ethanol pipelines in 2009.³¹⁴ One of the pipelines will run from Goias state in Brazil's center-west to Petrobras's Paulinia refinery in Sao Paulo State. The project is called PMCC Projetos de Transporte de Alcool. The line is expected to have the capacity to ship 3.2 million gallons of ethanol annually.³¹⁵

Other competitors include the joint venture from Cosan, Copersucar, and Crystalsev which will make initial investments of \$11.5 million apiece to install an ethanol-only pipeline between the oil refinery in Paulinia, to an ethanol offloading terminal on the state's coast. In addition, at least three major private equity groups (Infinity, Clean Energy Brazil, and Brenco) plan to invest \$1 billion in a 683 mile long ethanol pipeline expected to be completed by 2011 with a capacity to deliver 1.1 million gallons of ethanol a year. In total, it is estimated that Brazil

will need to invest \$1 billion each year for the next 15 years in infrastructure to keep pace with capacity expansion and export demand.³¹⁶

Another area that requires investment is in R&D and education. Currently, Brazil produces only 0.08 engineers for every 1000 people, compared to 0.2 in the US, 0.33 in the EU, and 0.8 in Korea.³¹⁷ In addition, there are deficiencies in basic education in Brazil's north and northeast regions. Since certain types of education require a long lead time (e.g. scientific training) Brazil will need to continue to invest in training and professional development for the sector's labor pool to meet the growing demand in the biofuels industry.

Before ethanol can be exported to other countries, Brazil's own domestic fuel consumption should be met. Brazil currently has an ethanol mandate of 25% (as of July 1, 2007).³¹⁸ The Brazilian ethanol to gasoline mix is set by the Brazilian government, which has the flexibility to adjust the ethanol mandate of 20-25% by volume ethanol to gas ratio. Ethanol currently represents nearly 30% of the light vehicle fuel market in Brazil.³¹⁹ Approximately 80% of new vehicles sold in Brazil in 2006 were flex fuel (1.6 million vehicles). The current increase in domestic consumption of ethanol in Brazil is partially due to the success of the flex-fueled vehicle.

At some point in the future, Brazil's light vehicle fleet will likely become saturated with FFVs in preference to gasoline. As such, the rate in domestic demand for ethanol is expected to begin to slow.³²⁰ Thus, as domestic demand begins to level off, some experts believe that there is a significant possibility that exports will become more relevant in market share terms. Figure 1.5-11 shows various estimates for future Brazilian ethanol domestic consumption.

Figure 1.5-11. Estimated Brazilian Ethanol Consumption Volumes³²¹

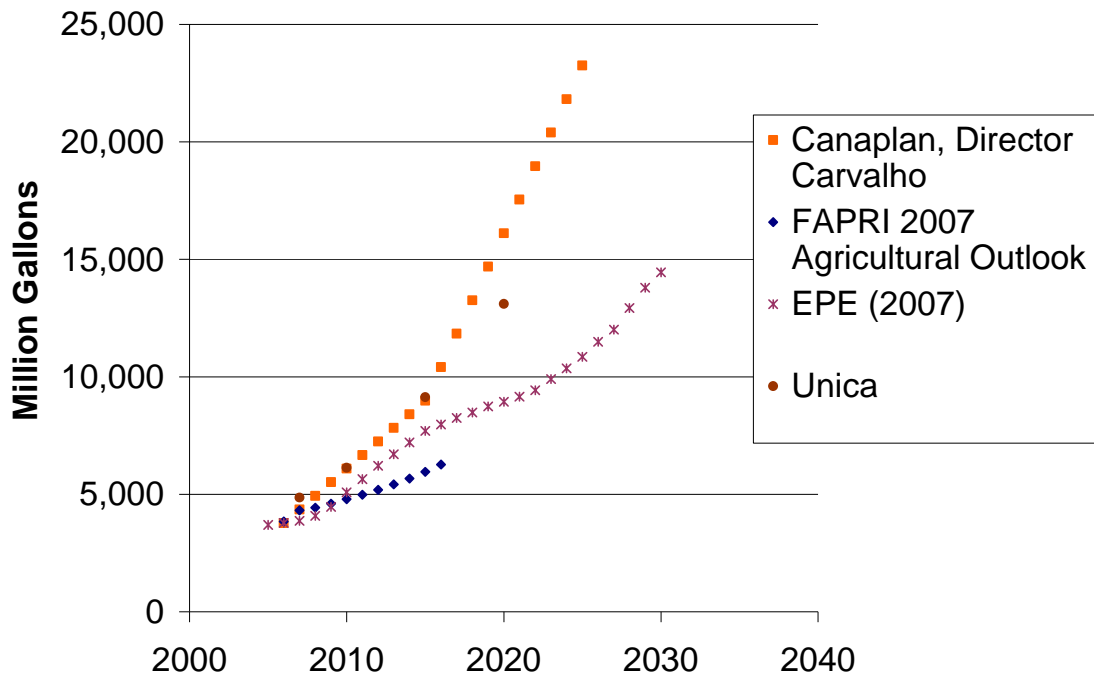

After domestic consumption is met, the rest of the ethanol can be available for exports to other countries. Potential worldwide exports basically equal the total production minus the total consumption. Given the available data, only three sources estimated both production and consumption for some of the years during 2010-2022. As such, these values were used to compute reasonable export volumes for Brazil as seen in Figure 1.5-12. Estimates from EPE and Unica indicate that as much as 3.8-4.2 billion gallons could be exported by Brazil in the 2020/2022 timeframe. Longer timeframe estimates from sugarcane analyst Datagro project international ethanol sales to grow to 6.6 billion gallons by 2025.³²²

Figure 1.5-12. Estimated Brazilian Export Volumes

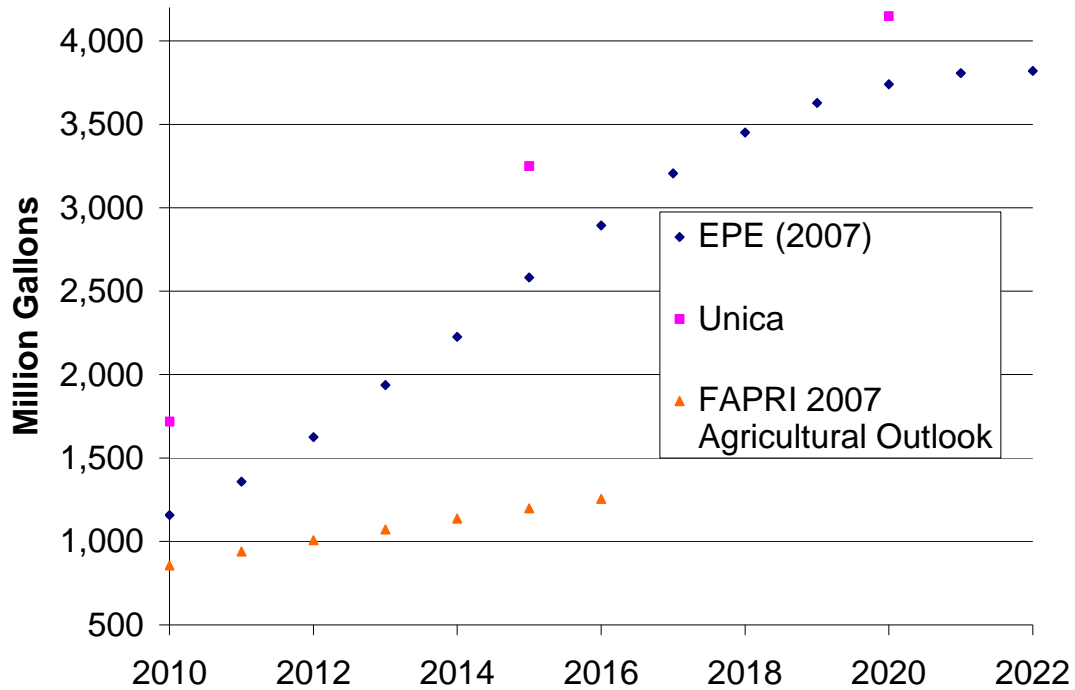

1.5.2.1.2 The European Union (EU)

Although the EU market has largely focused on biodiesel, ethanol has increasingly become important. Fuel ethanol demands are increasing due to the introduction of mandatory blending targets. In 2001 an EU Directive established that by 2005 biofuels should cover 2% of the total fuel consumption (energy basis), while the target for 2010 was set at 5.75%. However, in recent years the average biofuel contribution has been much less (i.e. 0.5%, 0.6% and 1% in 2003, 2004, and 2005, respectively).³²³

The EU is currently considering a binding target requiring 10% biofuel use for transport by 2020, although the target has recently come under criticism due to concerns over deforestation and food security problems.³²⁴ The International Energy Outlook (IEO) 2007 forecasts OECD European countries will consume 159 billion gasoline gallons equivalent (gge) of transport fuel in 2010, growing to 167 gge by 2030.³²⁵ Assuming a split of nearly 70% fuel volume consumed as diesel and 30% consumed as gasoline (current use), a 10% by energy requirement would require roughly 7.3 billion gallons of ethanol in 2022.^{TT,326} However, this may be a slight overestimate of gasoline use since the overall gasoline consumption in the EU is declining as a result of the increasing popularity of more economic diesel-powered cars. Other sources indicate smaller gasoline consumption volumes are possible by the 2020/2022 timeframe which when translated equals 5.2-5.4 billion gallons of ethanol assuming a 10% energy requirement.^{327,328}

^{TT} Assuming energy contents 115,000 Btu/gal for gasoline and 77,930 Btu/gal for denatured ethanol and 164 gge in 2022

However, many believe that even 10% is unrealistic and are calling for a lower percentage for biofuels. Most recently, the EU Energy Committee has passed draft legislation that if approved is expected to forbid the 27 EU countries from importing ethanol produced with excessive use of natural resources such as water or stimulates forest devastation.³²⁹ As a result, Brazilian stakeholders are monitoring such potential modifications in EU biofuels policy as it will affect the potential demand for ethanol from the EU.

Fuel ethanol production in the EU has been much lower than this, with less than 1 billion gallons produced historically (457 million gallons in 2007).³³⁰ Germany, Spain, France, Poland, and Sweden represent almost 90% of the production in 2007. According to the “World Biofuels: FAPRI 2007 Agricultural Outlook”, ethanol production in the EU is expected to grow to 1.5 billion gallons by 2016. Taking this into account, the EU would need to import approximately 4-6 billion gallons of ethanol in order to meet the 10% volume requirement if only traditional crops are used. It should be noted, however, that the EU production estimates in the FAPRI Agricultural Outlook does not reflect the EC directive volume requirement since the targets were announced after the report was issued. This could spur greater production in the EU and reduce the amount needed from ethanol exporters such as Brazil.

As of March 1, 2009, the installed capacity of the EU ethanol industry is 1.4 billion gallons, while a further 1 billion gallons are under construction and another 3 billion gallons has been announced.^{331,332} Totaling these capacity estimates, the EU would have 5 billion gallons ethanol capacity. While not all the announced projects in the EU will be completed, this gives an estimate of how fast and large ethanol production in the EU could grow. If we assumed that EU could produce this volume by 2022, as much as 2 billion gallons would need to be imported from other countries assuming a 7.3 billion gallon demand due to the 10% mandate. It appears likely from the above analysis that the EU will continue to be a net importer of biofuels under most future scenarios.

Due to constraints in ethanol production from current available technologies and feedstocks, the EU is continuing its development of second generation biofuels based on cellulosic materials. The majority of attention has been in Sweden, and to a lesser extent, the UK, Spain, and Netherlands. If ethanol from cellulose proves feasible and commercial-scale production is realized in the future, additional ethanol supplies from such feedstocks may help lessen the amount needed from imports.

1.5.2.1.3 Japan

Until recently, Japan did not produce much ethanol and imported the majority of their consumption.³³³ Now the government is showing signs of encouraging biofuels production by promoting (not mandating) a 3% blend of ethanol in gasoline. At the very least, a non-mandatory 3% blend will create a demand of 106-132 million gallons of ethanol.³³⁴ This is similar to Japan’s Agency for Natural Resources and Energy target to replace 132.1 million gallons of transportation fuel by 2010, using ethanol and biodiesel.³³⁵

With the passage of legislation calling for a 3% ethanol mandate in gasoline blend, Brazilian ethanol companies are hopeful that trade will increase substantially with Japan (this

may even reach over 1.5 billion gallons annually if a 10% ethanol blend was implemented nationwide in Japan, approximately 500 million gallons with E3 blends).³³⁶ While in the future use of greater than E3 blends in Japan may be unlikely, the Japanese government has mandated that all gasoline powered vehicles run on E-10 blends by 2030 and will also enact legislation to require all new vehicles to be E-10 compatible by 2012.^{337,338}

The prospect for large domestic production of ethanol in Japan appears to be quite small due to limitations on feedstock. The Agriculture Ministry states that Japan has enough feedstock to produce 26.4 million gallons per year, however, the Ministry of Environment (MOE) expects Japan to meet only 10% of the 132.1 million gallon target (or 13.2 million gallons) with domestic ethanol production.³³⁹ The Ministry of Agriculture and Fisheries (MAFF), on the other hand, predicts that Japan could reasonably expect to supply approximately 95 million gallons. Even with these higher domestic production estimates, Japan would still be a net importer of fuel ethanol if the biofuels target is met. The potential estimated demand for imported ethanol ranges from 37 million gallons to 1572 million gallons depending on the type of mandate assumed and the differences in the estimates of domestic ethanol production.

Table 1.5-24 details new plants that are under construction. The total capacity is much lower than the 132.1 million gallons of ethanol goal and further supports the argument that Japan will likely be heavily dependent on imports.

Table 1.5-24. Upcoming/Recent Plants in Japan³⁴⁰

Plant	Capacity	Feedstock	Year
3 from Agriculture Ministry	~4 million gallons/year	Local crops: rice, low-quality wheat, sugarbeet, sugarcane	
Hokkaido Prefectural Union of Agricultural Cooperatives	3.96 million gallons/year; start producing 3961 gal/year	Sugar beets that aren't targeted for domestic sugar and substandard wheat unusable for food	2007- construction 2009- production
Nippon Steel Plant	104.89 gallons daily (38,285 gallons/year)	Food waste from: supermarkets, restaurants, schools, hospitals. (10 tons annually)	April 2007- operational
Mitsui Engineering & Shipbuilding Co.		Agricultural wastes: felled oil palm trunks, empty fruit bunches, fibrous fruit wastes, kernel shells	2010: trial operations if ag. waste is successful

Up until now, Japan has seen Brazil as the only possible reliable supplier of ethanol. In early 2005, Japan and Brazil signed an agreement for a bilateral biofuels program to export Brazilian ethanol and biodiesel to Japan. Japan's investment will be used to install new ethanol facilities, increase acreage of sugarcane production, and modernize the infrastructure necessary for the transportation of ethanol.

One such partnership is between Brazilian oil company (Petrobras) and trading house Mitsui & Co., with financial support from Japan Bank for International Cooperation are in the

process of analyzing 40 projects evaluated at \$8 billion for building 40 new processing plants which produce alcohol and sugar from sugar cane. According to Paulo Roberto Costa, head of Petrobras' supply division, "Our target is to produce ethanol to be exported *only* to Japan." Within two to three months (perhaps at the end of 2007) Petrobras will sign a pioneer contract to produce a total of 1 billion liters (264 million gallons) of alcohol annually at five processing plants in the states of Mato Grosso, Goias, and Minas Gerais. Each of the five processing plants will produce approximately 50 million gallons per year within the next 2 ½ years, and the whole production will be exported to Japan. In order to help convince Japan that Petrobras has adequate ethanol supplies it has noted that their processing facilities will not be able to produce sugar, only alcohol.³⁴¹ With this amount (264 million gallons) slated for Japan only, other countries will have to either develop their own contracts with Brazil to ensure a stable supply or risk receiving the leftover supply.

Petrobras also recently bought a 90 percent stake in Exxon Mobil's Okinawa oil refinery that may serve as a staging point for Brazilian ethanol exports to Japan and the rest of Asia. This may help mitigate one of the main problems for Petrobras and other major exporters, a lack of offloading infrastructure.³⁴²

Another challenge is the distribution of ethanol in Japan. As ethanol in blends of E5 or higher have shown to be corrosive to aluminum and rubber car parts, Japan is looking into using ETBE blends of 7% and even 20-25% instead of ethanol.³⁴³ The Petroleum Association of Japan has announced that gasoline containing ETBE blends of 7% will be available for general public consumption by 2010. As ETBE is produced using ethanol as a feedstock, this could create a domestic ethanol demand of 90-100 million gallons.³⁴⁴

1.5.2.1.4 India

India has the potential to increase its ethanol production due to its long agricultural tradition. Unfortunately it is still in the very young stages of raising its biofuel industry, which leaves some analysts doubting this program's stability.³⁴⁵

Currently, India imports more than 70% of its energy needs. In addition to not being able to sustain its own current energy demands, the UN is predicting that India will become the most populated country by 2030 (surpassing China), and it will be consuming about a third of the world's energy by 2050.

The amount of ethanol blended into gasoline in India has fluctuated in recent years. In October 2004, ethanol blending in gasoline for example, had to be halted because of a lower sugar output due to a drought, which increased prices. However, production started back up in late 2005 when a fuller sugarcane molasses crop became available. Then in September 2006 the government announced the second phase of the EBP program that mandates 5% blending ethanol with gasoline in 20 states and eight union territories. The mandate was effective starting in November 2006 and would have required about 145 million gallons to be used. However, the program only started with 10 states and was not implemented in other states due to high state taxes, excise duties and levies.

A recent USDA Attaché report estimated that only 66 million gallons of ethanol will be blended with gasoline in 2006/07, compared with the original target of 145 million gallons. The government plans to extend the ethanol blend ratio to 10% in a third stage once the program is extended to all target states. Some local sources report plans to introduce E-10 mandates in several cane-producing states such as Tamil Nadu, Andhra Pradesh, and Maharashtra.³⁴⁶ The original plan on a minimum of 10% blend of ethanol by October 2008, however, was put on hold because of the sharp fall in crude oil prices and because of technical concerns raised by the Society of Indian Automobile Manufacturers. The main concern is from vehicles with older engines that may not be able to use a 10% blend without engine modifications (e.g. two-wheelers). Regardless, the government announced as part of its new biofuels policy to raise the blending level to 20% of total fuel usage by 2017 (includes biodiesel).³⁴⁷

India has about 300 distillers with a production capacity of about 845 million gallons. Due to the government's ethanol policy, over 110 distilleries have modified their plants to include an ethanol production line, with a total production capacity of 343 million gallons per year, enough to meet the estimated demand for E-5. For an E-10 mandate, however, the current ethanol production capacity would need to be enhanced.

As of May 2006, India's largest sugar and ethanol manufacturing company (Bajaj Hindusthan) is trying to acquire ethanol production plants in other countries with large sugarcane outputs (i.e. Brazil—but no concrete plans have been made). This way, the company can increase its production from 30.86 million gallons to 77.15 million gallons. Yet after several months of courting mill owners in Brazil, the company has not been able to come to any concrete agreements.³⁴⁸

Some oil companies are instead pushing for imports of ethanol. However, as of today, there is still an import duty of 198.96% on the cif value for denatured and 59.08% for undenatured ethanol.³⁴⁹ The c.i.f. (cost, insurance, and freight) value represents the landed value of the merchandise at the first port of arrival in a given country. In comparison to the U.S. which has a tariff of 54 cents per gallon (with 45 cents per gallon offset by the ethanol subsidy) and a smaller ad valorem tax of 2.5% for denatured ethanol, import duties in India are much higher.

The analysis of India's biofuels developments appears to indicate that it will be self-sustaining if E5 is mandated (as noted by the sugar industry). However, as India strives to meet its E10 goal, it may need to rely on imports from other countries. As noted above, India's own domestic production may grow from its current production of 66 million gallons of ethanol, with production capacity expanding to 343 million gallons per year. At E5 and E10 mandates, approximately 145 million gallons and 290 million gallons per year of ethanol, respectively, is required. Therefore, depending on the amount of ethanol that India chooses to mandate, India could either be an importer of 230 million gallons of ethanol or be able to meet its goals with domestically produced ethanol.

1.5.2.1.5 China

In 2007, China was the world's fourth largest fuel ethanol producer, producing 486 million gallons.³⁵⁰ Approximately 80% of fuel ethanol currently made in China is from corn.³⁵¹ Less than 20 percent of China's corn crop is used for the industrial sector, and only 44.5 percent of that is put towards fuel ethanol.³⁵²

China began mandating fuel ethanol blended into gasoline since June 2002.³⁵³ In 2004, the Chinese government introduced an ethanol mandate of 10% ethanol blended in gasoline (E10) in several provinces (Heilongjiang, Jilin, Liaoning, Henan, and Anhui). This mandate was further expanded to 27 cities in the provinces of Shandong, Jiangsu, Hebei, and Hubei in 2006. To keep up with fuel demand, a National Plan calls for fuel ethanol to rise from approximately 330 million gallons of ethanol per year to 660 million gallons by 2010 and 3.3 billion gallons by 2020.^{UU,354}

However, there have been recent concerns in China about the security of their food supply and the inflationary impact of biofuels which use grains as feedstock. With a population of 1.3 billion people, corn growers have to meet the demand for food (which might increase about 0.22 million tons) while also providing feedstock for fuel. In addition, they supply livestock feed for which demand is estimated to rise to roughly 100 million metric tons for 2007.³⁵⁵

In response to these food and feed demands for corn according to the National Development and Reform Commission (NDRC), China has stopped approvals for industrial corn processing for three years (until 2010) and has suspended approved projects which have not yet started construction.³⁵⁶ Over the next three years, corn consumption by the deep-processing sector (i.e. transformation of corn into industrial products like ethanol) will be restricted to 26 percent of China's total corn consumption.

The National Development and Reform Commission (NDRC) stated in their 11th Five Year Plan (2006-2010) that the production of approximately 2 billion gallons of grain-based ethanol will not threaten the country's grain security. Currently, there are four fuel ethanol plants operating in the country which have a production capacity of approximately 300 million gallons (since 2005): Jilin Fuel Alcohol Company Ltd, Anhui Fengyuan Petrochemical Ltd, Henan Tianguan Group and the Heilongjiang Huarun Jinyu Ltd (China Resources).^{357,358} These plants were established after 2000 to address a surplus of grains in China at the time. Plans for ethanol plant expansions could reach up to approximately 550 million gallons of ethanol by 2007. These companies, as well as announced expansions are listed in the following Table 1.5-25.

^{UU} Assuming a conversion of 1 million tonnes of ethanol equals 330 million gallons.

Table 1.5-25. Current and Future Fuel Ethanol Production in China³⁵⁹

Province	Company Name	Feedstock	2005 Production (Gal)	2007 Production (Gal)
Heilongjiang	China Resources Alcohol Co.	Corn	33,423,025	33,423,025
Jilin	Jilin Fuel Ethanol Co.	Corn	100,269,074	200,538,149
Henan	Henan Tian Guan Fuel-Ethanol Co.	Wheat	66,846,050	66,846,050
Anhui	Anhui BBKA Biochemical Co.	Corn	106,953,679	106,953,679
Guangxi	China Resources Alcohol Co.	Cassava	0	36,765,327
Hebei	China Resources Alcohol Co.	Sweet potato, corn, etc.	0	76,872,957
Hubei	Tian Guan Fuel-Ethanol Co.	Grains	0	33,423,025
Total			307,491,828	554,822,211

As seen in the above table, several distilleries have been looking into alternative feedstocks.³⁶⁰ Examples of alternative feedstocks include sorghum, wheat, cassava, and sweet potato. These crops, however, are grown in much smaller quantities as compared to corn, and if China ethanol production expands from cassava, for example, China will have to rely on imported cassava.³⁶¹ China may soon become a major importer of ethanol, especially if the E10 blend is extended across the country. With a nationwide E10 blend in 2020, biofuels demand would be approximately 7.6 billion gallons of ethanol.³⁶² Even if the National Plan which calls for China's domestic fuel ethanol production to reach 3.3 billion gallons by 2020 is met, a nationwide E10 blend would result in a supply shortfall of about 4.3 billion gallons of ethanol.³⁶³ Another study, the "World Biofuels: FAPRI 2007 Agricultural Outlook" also indicates that China would be a net importer of ethanol in the future (out to 2016), where domestic production only reaches approximately 1 billion gallons. In addition, if only food crops are assumed to be used to produce ethanol, China is estimated to only produce 0.6 billion gallons.³⁶⁴ Assuming a possible E10 mandate nationwide and the projections for domestically produced ethanol, China would need to import approximately 4.3-7.0 billion gallons of ethanol per year.

1.5.2.1.6 Other Countries

Although Brazil is the largest exporter of ethanol, there may still be other countries that could provide additional ethanol to the U.S. In fact, trace amounts of ethanol entered the U.S. market from Argentina, Canada, Netherlands, and Pakistan in 2006.³⁶⁵ The North American Free Trade Agreement (NAFTA) is similar to the Caribbean Basin Initiative (CBI) in that it welcomes tariff-free ethanol imports from Canada and Mexico.

In addition, there may also be other countries that are beginning biofuels programs and could demand smaller volumes of ethanol in the future. We provide a list of the potential mandates and goals for other countries below in Table 1.5-26. This list is not meant to be all-inclusive, but rather to give idea of the biofuel outlook in other countries.

Table 1.5-26
Potential Mandates and Goals for Various Countries^{366,367,368,369,370,371}

Argentina	Argentine President Nestor Kirchner signed a law in February 2007 implementing tax breaks and fuel-content mandates for biofuels. The Biofuels Act includes tax breaks for companies investing in the biofuels sector and mandates 5% ethanol in gasoline by 2010. The Secretary for Agriculture estimates that the country would need 200 million liters per year of ethanol (528,000 gallons) to satisfy the E5 requirements.
Australia	The Australian government has set a biofuels target of 93 Mgal by 2010 according to the 'Biofuels for Cleaner Transport' 2001 election policy. This target was never mandated in legislative form. <u>Queensland</u> - In early August 2006 a mandate for a minimum of 5% ethanol from December 21, 2010. <u>New South Wales (NSW)</u> - Beginning in September 2007, fuel supplied to wholesalers in New South Wales will be required to contain 2% ethanol. Proponents of ethanol in the region want to increase the mandate to 4% in 2009 and 10% in 2010. <u>Australian Capital Territory (ACT)</u> - The ACT does not plan to mandate ethanol. Generally this territory follows the policies of NSW because most of their fuel supplies are sourced from NSW. <u>Victoria</u> - Biofuels target of 5% of fuel market by 2010 (106 Mgal), this includes biodiesel. <u>South Australia</u> - No plans to mandate or set a target for biofuels use. <u>Northern Territory</u> - No plans to mandate or set a target for biofuels known. <u>Western Australia</u> - No plans to mandate or set a target for biofuels known. <u>Tasmania</u> - The alternative fuels policy is currently based on CNG use. No plans to mandate or set a target for biofuels known.
Canada	On June 26, 2008, the Canadian Senate passed Bill C-33, which will require the use of 5% renewable content in gasoline by 2010. Canada's Government General Michaelle Jean signed the bill after it was passed in the senate, making it official. <u>Saskatchewan</u> - Enacted in October 2006 a 7.5% ethanol mandate in gasoline (approximately 131 Mgal) <u>Ontario</u> - Enacted in January 2007 a 5% ethanol mandate in gasoline <u>British Columbia</u> - Bill C-16 to pass soon, 5% ethanol by 2010 to support federal plan <u>Alberta</u> - Has not set its own standard as it prefers a national approach <u>Manitoba</u> - As of Jan. 1, 2008, 8.5% in gasoline (approximately 130 Mgal) <u>Quebec</u> - 5% ethanol in gasoline by 2012, expects source to be met with cellulosic ethanol production <u>Nova Scotia</u> - No goals for biofuels <u>New Brunswick</u> - No goals for biofuels <u>Newfoundland Labrador, P.I.E.</u> - Interest on the East Coast, but nothing as of May 2008 <u>North West Territories, Yukon, Nunavut</u> - No goals for biofuels
Columbia	In September 2001, the Colombian Government issued Law 693, which made it mandatory to use 10% ethanol blends in gasoline in cities with populations larger than 500,000 inhabitants by the year 2008. The law went into effect in September 2005. Ethanol production, however, could not cover the entire country's demand, and thus the government established a phase-in period throughout the country for mandatory ethanol use.
Mexico	There is currently no specific bio-fuels promotion program operation in Mexico. On April 26, 2007, the Mexican congress approved the Law for Promotion and Development of Biofuels (LPBD). The law, though lacking in any actual mandates, sets the state for further legislative actions on biofuels development and use.

1.5.2.1.7 Summary of Potential Import/Export Demands

For the main countries we have analyzed from above, there appears to be a large potential demand from the EU, Japan, India, and China for imported ethanol. See Table 1.5-27 for a summary of potential import demand by 2020/2022. Total import potential demand from all these countries would range from approximately 5-15 billion gallons. If these countries decide to meet their mandated ethanol blends or enact new mandates, this could greatly increase the amount that each country would demand from other countries, primarily from Brazil. As shown in Section 1.5.2.1.1, Brazil is only expected to export 3.8-4.2 billion gallons by 2022. This is significantly below the volume we estimated that could be potentially demanded by other

countries in the future. Therefore, it is likely that unless Brazil increases production much more than its government projects, the EU, Japan, India, and China will not be able to meet their stated goals. This also indicates that the U.S. will likely compete with other foreign countries for exports from Brazil. This analysis, however, only considers non-cellulosic biofuel potential. If cellulosic biofuel production develops in these countries, it is entirely possible that the biofuel demands could be lower due to greater supplies.

**Table 1.5-27. Potential Import Demand:
EU, Japan, India, and China by 2020/2022 (billion gallons).^{vv}**

Country	EU	Japan	India	China	Total
Potential Domestic Production (non-cellulosic)	1.5-5.0	0-0.1	0.1-0.3	0.6-3.3	
Potential Domestic Consumption					
Petrobras Contract	n/a	0.3	n/a	n/a	
E3	n/a	0.5	n/a	n/a	
E5	n/a	n/a	0.1	n/a	
E10 (or 10% by energy for EU)	5.2-7.3	1.6	0.3	7.6	
7% ETBE	n/a	0.1	n/a	n/a	
Potential Import Demand	0.2-5.8	0.1-1.6	0-0.2	4.3-7.0	4.6-14.6

1.5.2.1.8 Potential for U.S. Ethanol Exports

Ethanol exports in the U.S. have averaged only approximately 100 million gallons per year since 2000, mostly to Canada, Mexico, and the E.U. See Figure 1.5-13. There is a trend over the past five years of exporting larger quantities to fewer countries, with declining volumes to Asia and increasing volumes to the E.U. and India. Based on this historical data, it does not seem likely that volume of ethanol exports will change drastically in the future.

^{vv} Ranges are calculated assuming the potential values for production and consumption

Figure 1.5-13.
U.S. Ethanol Exports (includes hydrous, dehydrated, and denatured volumes).³⁷²

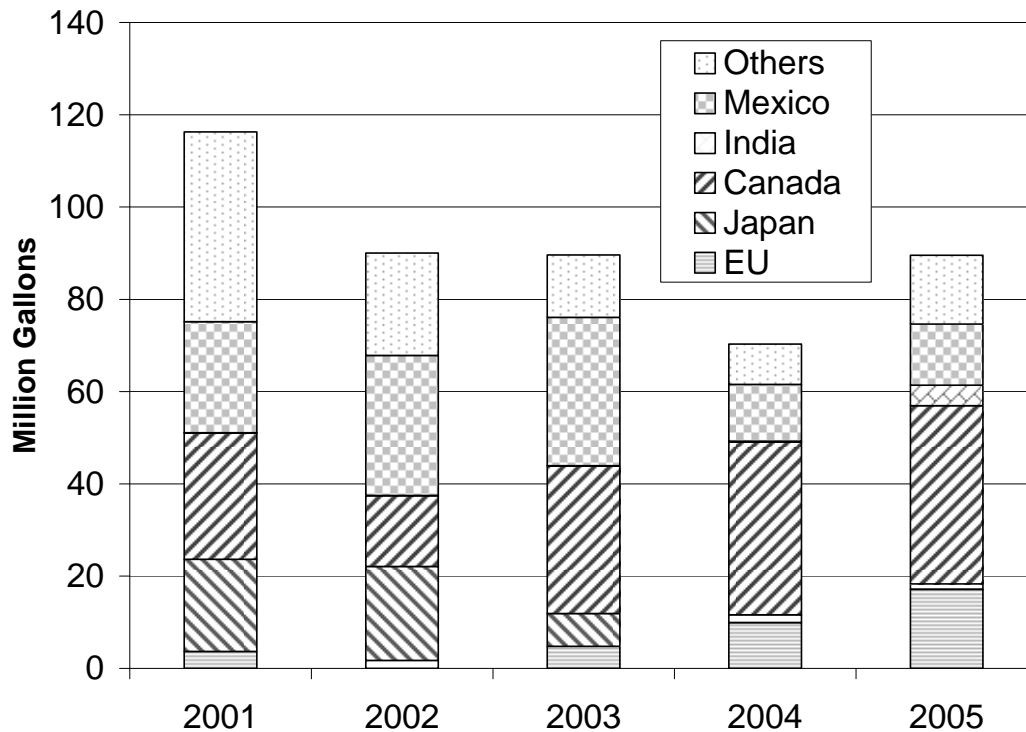

1.5.2.2 Projected Growth Under RFS2

As long as imported ethanol is cost-competitive with gasoline, there will continue to be a demand for it. As our analysis from above shows, Brazil is the only country that will likely be able to provide a significant volume of ethanol to the U.S. Accordingly, Brazil will ship ethanol to countries via the most cost-effective way.

The pathway Brazil chooses to ship ethanol will likely depend on the tariffs and taxes put in place by other nations. Specifically, the U.S. places a 54 cent tariff on all imported ethanol (as well as a 2.5 percent ad valorem tax for un-denatured ethanol and a 1.9 percent tax for denatured ethanol). A key reason for establishing a tariff was to offset a tax incentive for ethanol-blended gasoline, which is set at 45 cents per gallon of pure ethanol.^{ww} This analysis assumes that both the tax subsidy and the tariff will continue in the future.

The tariff can be avoided by first shipping ethanol to countries under the Caribbean Basin Initiative (CBI) and then to the U.S. Historically, the majority of CBI ethanol to the U.S. comes from dehydrating ethanol from Brazil. Legislation and agreements since the 1980s have waived or significantly reduced the tariff on imports from Canada, Mexico, and those nations covered under the CBI. There are currently nineteen countries that can benefit from the CBI program. These countries are: Antigua and Barbuda, Aruba, Bahamas, Barbados, Belize, British Virgin

^{ww} Prior to the 2008 Farm Bill, the tax incentive was set at 54 cents per gallon

Islands, Costa Rica, Dominica, Grenada, Guyana, Haiti, Jamaica, Montserrat, Netherlands Antilles, Panama, St. Kitts and Nevis, St. Lucia, St. Vincent and the Grenadines, and Trinidad and Tobago.³⁷³

Under the Caribbean Basin Economic Recovery Act (CBERA), which created the CBI, countries in Central America and the Caribbean have had duty-free access to the United States since 1989 for ethanol produced from regional feedstocks. Although most analysts believe there is sufficient land available for sugar cane production in some CBI nations, there has been insufficient economic potential to spur sugar cane planting for ethanol production.³⁷⁴ Ethanol derived from non-regional feedstocks has been limited to 7 percent of total U.S. ethanol consumption (based on figures from the previous year). There are also country-specific allocations for El Salvador (5.2 million gallons in first year (2006) and an annual increase of 1.3 million gallons per year, not to exceed 10% of CBI quota) and Costa Rica (31 million gallons annually) established by the U.S. Free Trade Agreement with Central America and the Dominican Republic (CAFTA-DR).³⁷⁵ Thus far, Costa Rica, El Salvador, Jamaica, Trinidad and Tobago, and the U.S. Virgin Islands (since 2007) are the only countries that have ever exported ethanol to the U.S. under the CBI quota.

Historically, the CBI nations have had little ethanol production capacity of their own but have supplemented it by importing hydrous Brazilian ethanol where it is further dehydrated before being re-exported to the U.S. duty-free. CBI countries have also relied on surplus wine alcohol from France, Italy, Spain and other Mediterranean countries in the past.³⁷⁶ According to the United States International Trade Commission, the majority of fuel ethanol imports to the United States came through CBI countries between 1996 and 2003. Although CBI ethanol imports to the U.S. in 2006 totaled over 170 million gallons, imports to the U.S. from Brazil totaled 3 times that amount, or approximately 430 million gallons. This data indicates that in 2006 it was economical to import significant quantities of ethanol directly from other nations due to the withdrawal of MTBE and high oil prices. However, it is not clear on how much of this volume the tariff was paid, as there have been other means for importers to avoid the tariff.

In the past, companies have also imported ethanol from Brazil through a duty drawback.³⁷⁷ The drawback is a loophole in the tax rules which allowed companies to import ethanol and then receive a rebate on taxes paid on the ethanol when jet fuel is sold for export within three years. The drawback considered ethanol and jet fuel as similar commodities (finished petroleum derivatives).^{378,379} Most recently, however, Senate Representative Charles Grassley from Iowa included a provision into the 2008 Farm bill that ended such refunds. The provision states that “any duty paid under subheading 9901.00.50 of the Harmonized Tariff Schedule of the United States on imports of ethyl alcohol or a mixture of ethyl alcohol may not be refunded if the exported article upon which a drawback claim is based does not contain ethyl alcohol or a mixture of ethyl alcohol.”³⁸⁰ The provision became effective on or after October 1, 2008 and companies have until October 1, 2010 to apply for a duty drawback on prior transactions. With the loophole closed, it is anticipated that there may be less ethanol directly exported from Brazil in the future.³⁸¹

CBI countries have not yet exceeded the tariff rate quotas (TRQs) for ethanol imports. The TRQ has been limited to 7 percent of total U.S. ethanol consumption (based on figures from

the previous year). The fill rate, or percent of the TRQ used, has ranged from 22-77% between 1990 and 2008. See Figure 1.5-14. Thus, there is still considerable room for growth in CBI imported ethanol.

Figure 1.5-14. U.S. Fuel Ethanol CBERA TRQ, 1990-2009

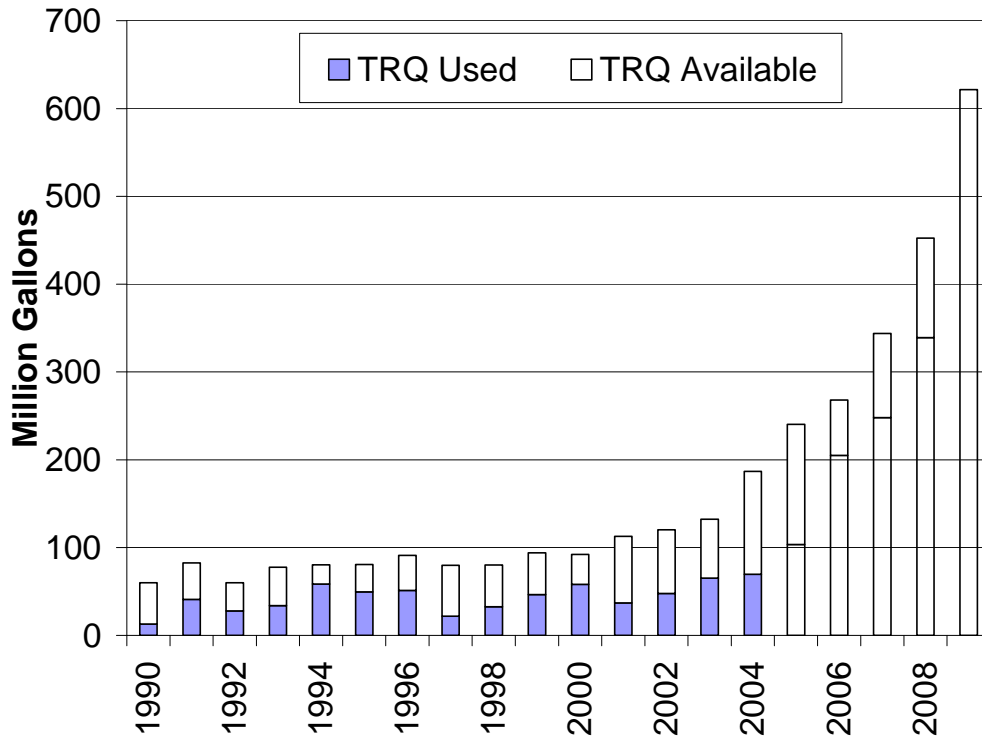

*TRQ Used data for 2009 is not yet available.

In October 2003, the California Energy Commission (CEC) reported four active CBI ethanol dehydration plants, two in Jamaica, one in Costa Rica, and one in El Salvador. At the time, CEC concluded that reprocessing capacity was the limiting factor on CBI imports, with a total of 90 million gallons per year.³⁸² Since then, several companies have expanded plants or announced new plants as described below:

- Jamaica*- In 2005, Petrojam Ethanol Limited (PEL), upgraded and expanded their ethanol dehydration plant in Jamaica to a capacity of 40 million US gallons. Currently, the production of anhydrous (fuel grade) ethanol at the plant is based on a marketing agreement with the Brazilian company, Coimex Trading, where the feedstock - hydrous ethanol is supplied from Brazil.^{383,384} Jamaica Broilers Group (JBG) launched fuel ethanol production at its 60 million gallon dehydration plant this year. The first shipment of 5.5 million gallons of ethanol, which arrived in June 2007, will be converted to anhydrous ethanol for export to the U.S. JBG has a deal with Bauche Energy for the supply of 50 million gallons of hydrous ethanol out of Brazil for the first year of operation.³⁸⁵ Jamaica Ethanol Processing Ltd, which is ED & F Man's subsidiary on the island, has a small plant that dehydrates ethanol from Brazil at a capacity of 55 million gallons.

- *Costa Rica*- LAICA (cane co-op) has a plant currently dehydrating ethanol at 38 million gallons.³⁸⁶
- *El Salvador and Panama*- In 2004, it was reported that Cargill and Chevron Texaco had announced plans to construct new dehydration plants in El Salvador and Panama. These plants could produce 60 million gallons per year and between 50 and 100 million gallons per year, respectively.³⁸⁷ Plants currently in operation include Gasohol de El Salvador (Liza/Vitol) at 100 million gallons per year and ARFS (CASA/Cargill/Crystalsev) at 60 million gallons per year.³⁸⁸
- *Trinidad*- EthylChem Inc. has reported plans to build an ethanol dehydration operation at the Petrotrin Refinery in Point-a-Pierre, a southern port city in Trinidad. The plant will dehydrate ethanol at a capacity of 100 million gallons per year and is expected to be complete between March and April of 2007.³⁸⁹ The cost to build the plant is estimated at \$20 million.³⁹⁰ It is probable, however, that not all the ethanol would be exclusively for U.S. consumption. According to Ron White, the executive director of Ethylchem, "While EthylChem intends to export the fuel to the United States the company is examining the possibility of shipping the product to other markets in the world".³⁹¹ Another company, Angostura Ltd., started processing ethanol in 2005.³⁹² The plant has an overall capacity of 100 million gallons per year, with 50 million gallons per year in the first phase.³⁹³
- *Others*- An idled ethanol plant in Haiti has attracted some investors and there are also projects in the works in Guyana, the Dominican Republic and Aruba. The U.S. Virgin Islands has one plant dehydrating ethanol at 100 million gallons per year capacity (Geonet).³⁹⁴ A new ethanol dehydration plant is proposed to be built at the Bulk Terminal Facility near Spring Garden Highway in Barbados, with construction expected to commence by the end of 2008.³⁹⁵ There is a proposal to build a US\$36 million ethanol plant near Bridgetown, Barbados. The plant is expected to produce about 132 million gallons by refining ethanol imported from Brazil.³⁹⁶

In total, current fuel ethanol plant capacity for dehydration in the Caribbean is 500 million gallons per year. Plans to expand total approximately 200 million gallons.³⁹⁷ This means that there could be 700 million gallons per year of fuel ethanol capacity in the next few years.

Some stakeholders, however, have expressed concern that the CBI countries are not as stable for investment. Both Brazilian ethanol and European wine alcohol are susceptible to factors including availability, price fluctuations, trade regulations, currency movements and freight rates. Availability of European surplus wine alcohol has diminished since the World Trade Organization (WTO) placed limitations on export subsidies and has found new markets in Spain and Sweden.³⁹⁸ CBI countries also need to compete for Brazilian ethanol. For example, Angostura's ethanol subsidiary, Trinidad Bulk Traders Ltd., wasn't profitable in 2006 because it could not get enough fuel from Brazil.³⁹⁹

There are other prohibitive factors to CBI ethanol production that exist. For instance, many of the CBI countries have no oil, natural gas or coal. Permitting is often a huge challenge and fresh water is typically scarce.⁴⁰⁰

In addition, increasing significantly beyond the 7% limit may be challenging. Few Caribbean countries are in any position to produce ethanol from domestic feedstocks such as sugar cane. Currently, all three plants exist in Central America (CATSA in Costa Rica, Pantleon Group in Guatemala, and Pellas Group in Nicaragua). Capacity for each plant is approximately 10 million gallons per year. The majority of this domestic fuel ethanol is shipped to the EU for fuel use rather than US due to higher opportunity prices and similar tariff free treatment.⁴⁰¹ In addition, the governments of Trinidad, St. Kitts and Barbados have already decided the sugar sectors of their islands are not worth further investment. Rum distillers such as Trinidad’s Angostura and Jamaica’s Appleton Ltd. have also had to import molasses from Fiji for their spirits.⁴⁰² Thus, it may take years before Caribbean countries are able to domestically produce large volumes of ethanol. As noted above, however, as dehydration capacity gets close to the US CBI quota, processors will need to consider blending indigenous ethanol.

As a result of the economic benefit of shipping ethanol through CBI nations, we anticipate that the majority of the TRQ will be met in the future. If we assume that 90 percent of the TRQ is met and that total domestic ethanol (corn and cellulosic ethanol) consumed in the prior year was 28.5 Bgal, then approximately 1.8 Bgal of ethanol could enter the U.S. through CBI countries.^{XX} Brazilian ethanol exports not entering the CBI will compete on the open market with the rest of the world demanding some portion of direct Brazilian ethanol. We calculated the amount of direct Brazilian ethanol exported in 2022 to the U.S. as the total imported ethanol required to meet the Act subtracted by imported ethanol from CBI countries (e.g. 3.14 Bgal of imported ethanol is required to meet EISA in 2022, while 1.8 Bgal can enter CBI due to the TRQ limit, thus leaving 1.34 Bgal needed directly from Brazil). The total imported ethanol required by the Act was projected for each year based on the required volumes needed to meet the advanced biofuel standard after accounting for the volumes from cellulosic biofuel, biodiesel, and renewable diesel. See Table 1.5-28.

Table 1.5-28.
Projected Contribution of Ethanol from CBI Countries and
Direct Brazilian exports in 2022 (billion gallons)

Ethanol From CBI Countries	Ethanol Directly From Brazil	Total Imported Ethanol
1.80	1.34	3.14

The amount of Brazilian ethanol available for direct shipment to the U.S. will be dependent on the biofuels mandates and goals set by other foreign countries (i.e., the EU, Japan, India, and China). Our estimates show that there could be a potential demand for imported ethanol of 4.6-14.6 billion gallons by 2020/2022 from these countries as noted in Section 1.5.2.1.7. This is due to the fact that some countries are unable to produce large volumes of ethanol because of e.g. land constraints or low production capacity. Therefore, unless Brazil increases production much more than its government projects there may be a limited supply for imported ethanol to satisfy all foreign country mandates and goals.

^{XX} Total Domestic Ethanol is based on the amount needed to meet EISA (i.e. for 2021: 15 Bgal Corn Ethanol, 13.5 Bgal Cellulosic Ethanol; for 2022: 15 Bgal Corn Ethanol, 16 Bgal Cellulosic Ethanol).

1.5.2.2.1 Origin of Projected Imports

A summary of our projections of the breakdown of ethanol imports that would come directly from the Brazil versus that which would come through the CBI countries is contained in Table 1.5-19. To estimate the future breakdown of ethanol imports from CBI countries by country of origin, we evaluated historical ethanol import data from the International Trade Commission (ITC) and trends regarding potential growth in such imports. Table 1.5-29 contains 2005-2007 data from the ITC on ethanol imports from CBI countries.⁴⁰³ Table 1.5-30 contains January – March 2008 data from the ITC on ethanol imports from CBI countries.⁴⁰⁴

Table 1.5-29. Ethanol Imports from CBI Countries 2005-2007

	2005		2006		2007	
	% of CBI imports	Volume (Million Gallons)	% of CBI imports	Volume (Million Gallons)	% of CBI imports	Volume (Million Gallons)
Costa Rica	32%	33.4	22%	35.9	17%	39.3
El Salvador	23%	23.7	23%	38.5	32%	73.3
Jamaica	35%	36.3	40%	66.8	33%	75.2
Trinidad and Tobago	10%	10	15%	24.8	19%	42.7

Source: International Trade Commission

Table 1.5-30. Ethanol Imports from CBI Countries, January through March 2008

	January		February		March	
	% of CBI imports	Volume (Million Gallons)	% of CBI imports	Volume (Million Gallons)	% of CBI imports	Volume (Million Gallons)
Costa Rica	26%	5.4	27%	5.4	0	0
El Salvador	13%	2.6	0	0	23%	4.6
Jamaica	19%	4.0	32%	6.4	39%	7.9
Trinidad and Tobago	20%	4.1	21%	4.2	29%	6
Virgin Islands	22%	4.6	21%	4.2	9%	1.9

Source: International Trade Commission

Based on our review of the January through March 2008 data, we assumed that ethanol exports from the Virgin Islands would continue to grow to equal those of Trinidad and Tobago in 2022. By accommodating this assumption into our review of 2005 through 2007 historical ethanol import data, we arrived at our projections regarding the future breakdown of ethanol imports from CBI countries which is contained in Table 1.5-31.

**Table 1.5-31.
Projected Future Breakdown of
Ethanol Imports from CBI Countries**

	% of Total Ethanol Imports from CBI Countries
Costa Rica	20%
El Salvador	20%
Jamaica	30%
Trinidad and Tobago	15%
Virgin Islands	15%

1.5.2.2.2 Destination of Projected Imports

For our distribution and air quality analyses, we had to make a determination as to where the projected imported ethanol would likely enter the United States. As mentioned above, we started by looking at historical ethanol import data and made assumptions as to which countries would likely contribute to the CBI ethanol volumes in Table 1.5-19, and to what extent (see Table 1.5-22).

From there, we looked at 2006-2007 import data and estimated the general destination of Brazilian ethanol and the five contributing CBI countries' domestic imports.⁴⁰⁵ Based on these countries' geographic locations and import histories, we estimated that in 2022 82% of the ethanol would be imported to the East and Gulf Coasts and the remaining 18% would go to the West Coast and Hawaii. The destination of imports from Brazil and the CBI countries in 2022 is detailed in Table 1.5-32.

**Table 1.5-32.
2022 Projected Destination of Ethanol Imports from Brazil
and CBI Countries Based on 2006-2007 Import Data**

Origin	Destination of Ethanol Imports (% of imported volume)		
	West Coast	Hawaii	East & Gulf Coasts
Costa Rica	83%	35%	47%
El Salvador	18%	9%	88%
Jamaica	3%	0%	17%
Trinidad & Tobago	0%	32%	68%
Virgin Islands	3%	9%	88%
Brazil (direct)	7%	0%	93%
Total	11%	7%	82%

Source: Energy Information Administration historical gasoline and ethanol import data:
http://www.eia.doe.gov/oil_gas/petroleum/data_publications/company_level_imports/cli_historical.html

To estimate the 2022 ethanol import locations on a finer level, we looked at coastal ports that had received ethanol or finished gasoline imports in 2006. We chose to include ports which imported finished gasoline (in addition to ethanol) because we believe finished gasoline will be one of the first petroleum products to be replaced under the proposed RFS2 rule. And

presumably, these ports cities already have existing gasoline storage tanks that could be retrofitted to accommodate fuel ethanol. All together, we arrived at 28 potential ports in 16 coastal states that could receive ethanol imports in 2022 (refer to Figure 1.5-14 below).^{YY}

To determine how much ethanol would arrive at each port location, we started by examining each receiving state's imported ethanol consumption potential. To do this, we considered each state's maximum ethanol consumption potential (based on projected gasoline energy demand) and deducted the projected 2022 corn and cellulosic ethanol production (detailed in Sections 1.5.1.2 and 1.5.3.4, respectively). While we are not concluding that each state would necessarily consume all the ethanol it produces, we believe this serves as an appropriate assumption in determining each port state's relative imported ethanol consumption potential. Once we determined the amount of imported ethanol that each state would receive in 2022 under RFS2, for states with multiple ethanol ports, we allocated the ethanol among port locations based on each port county's relative energy demand - using projected 2022 vehicle miles traveled (VMT) from EPA's MOVES model 2022 VMT. A summary of the projected ethanol imports volumes by port location is found in Figure 1.5-15.

^{YY} We are considering adding Hampton Roads, VA and Baltimore, MD to the list of future ethanol import locations and may adjust our analysis for the final rule accordingly.

Figure 1.5-15.
Projected RFS2 Ethanol Import Locations and Volumes (Million Gallons)^{ZZ}

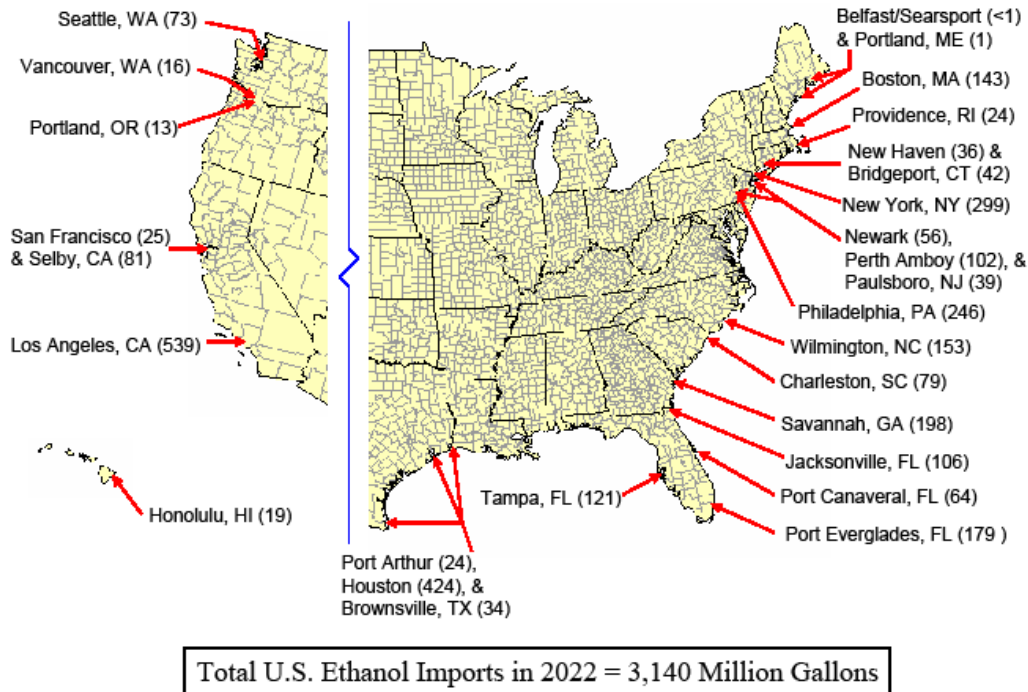

1.5.3 Cellulosic Biofuel

In this subsection, we will discuss the state of the evolving cellulosic biofuel industry. The bulk of this discussion focuses on the cellulosic ethanol industry since it is the cellulosic biofuel we assumed for our RFS2 volume and impact analyses. However, as discussed in Section 1.2.1 (and throughout this package) cellulosic diesel could also count towards meeting the 16 billion gallon cellulosic biofuel standard. We are becoming aware of more and more companies pursuing plans to produce diesel through Fischer-Tropsch gasification of biomass as well as thermal, thermochemical, and biological depolymerization of biomass to produce synthetic diesel fuel. We plan on doing a more robust assessment of these companies and technologies for the final rulemaking. In the meantime, a discussion of the cellulosic diesel production plans we are aware of is provided in Section 1.5.3.3. For more on the cellulosic biofuel conversion technologies mentioned in this section, refer to Section 1.4.3. Finally, we end this section with a discussion of how the nation is on track for meeting the 2010 cellulosic biofuel standard and where more commercial-level plants might be located in 2022 based on feedstock availability.

^{ZZ} We are considering adding Hampton Roads, VA and Baltimore, MD to the list of future ethanol import locations and may adjust our analysis for the final rule accordingly.

1.5.3.1 Cellulosic Ethanol Production/Plans

Presently, all commercial-level ethanol produced in the U.S. comes from plants processing corn and other grains or starches. However, cellulosic feedstocks have the potential to greatly expand domestic ethanol production, both volumetrically and geographically. Before the fuel can be economically produced at commercial levels in today's marketplace, technical and logistical barriers must be overcome. In addition to today's RFS2 program which sets aggressive goals for all ethanol production, the Department of Energy (DOE) and other federal and state agencies are helping to spur industry growth.

The cellulosic ethanol industry is essentially in its infancy. No commercial-scale plants are currently operating in the U.S. However, numerous state and federal agencies, national laboratories, universities, and private companies are working towards making cellulosic ethanol commercially viable. These organizations are pursuing second-generation conversion technologies and experimenting with a variety of feedstocks. Some researchers are focusing on processing corn residues, e.g., corn stover, cobs, and/or fiber. Some are focusing on other agricultural residues such as sugarcane bagasse, rice, and wheat straw. Others are looking at waste products such as forestry residues, citrus residues, pulp or paper mill waste, municipal solid waste (MSW), and construction and demolition (C&D) debris. Dedicated energy crops including switchgrass and poplar trees are also being investigated.

The majority of the groups pursuing cellulosic ethanol production are currently conducting laboratory research or experimenting with pilot- or demonstration-level production. Based on an April 2009 assessment of information available on the public domain, there are presently 25 small cellulosic ethanol plants operating in the United States.^{AAA} Most of these facilities operate intermittently and produce insignificant volumes of ethanol. A list of these facilities and their locations, feedstocks, ethanol production capacities (if applicable/available), estimated operation dates, and technologies is provided in Table 1.5-33. The date listed in the table indicates when the facility first began operations.

^{AAA} Our April 2009 cellulosic ethanol industry assessment was based on researching DOE- and USDA-supported projects, plants referenced in HART's Ethanol & Biodiesel News (through the April 14, 2009 issue), plants included on the Cellulosic Ethanol Site (<http://www.theceseite.com/>), and plants referenced on other biofuel industry websites.

**Table 1.5-33.
Operational Pilot- and Demonstration-Scale Cellulosic Ethanol Plants**

Company or Organization Name	Location	Feedstocks	Prod Cap (MGY)	Est. Op. Date	Conv. Tech.^a
Abengoa Bioenergy Corporation ^b	York, NE	Wheat straw, corn stover, energy crops	0.02	Sep-07	Bio
AE Biofuels ^b	Butte, MT	Switchgrass, small-grain straw, corn stover	N/A	Aug-08	Bio
Arkenol Technology Center	Orange, CA	Biomass	N/A	1994	Bio
Auburn University / Masada Resources Group ^c	Auburn, AL	Wood	N/A	1995	Bio
Bioengineering Resources, Inc. (BRI)	Fayetteville, AK	MSW, wood waste, coal	0.04	1998	Therm
BPI & Universal Entech	Phoenix, AZ	Paper waste (sorted MSW)	0.01	2004	Bio
Chemrec & Weyerhaeuser	New Bern, NC	Paper mill waste	N/A	1996	Therm
ClearFuels Technology / Hawaii Natural Energy Institute	Kauai, HI	Sugarcane bagasse	N/A	2004	Therm
Cornell University's Biofuels Research Laboratory (BRL)	Ithaca, NY	Perennial grasses, woody biomass	N/A	Jan-09	Bio
Coskata	Warrenville, IL	Reformed natural gas, biomass	N/A	Mar-08	Therm
DOE National Renewable Energy Laboratory (NREL)	Golden, CO	Corn stover, other biomass	N/A	2001	Both
Gulf Coast Energy	Livingston, AL	Wood waste (sorted MSW)	0.20	Dec-08	Therm
Mascoma Corporation	Rome, NY	Wood chips	0.20	Feb-09	Bio
Novozymes	Franklinton, NC	Corn stover	N/A	N/A	Bio
Pan Gen Global (formerly Colusa Biomass)	Colusa County, CA	Rice straw & hulls	N/A	1995	Bio
Pearson Technologies Inc. (PTI)	Aberdeen, MS	Wood residues, rice straw	N/A	2001	Therm
POET Research Center ^b	Scotland, SD	Corn cobs & fiber	N/A	N/A	Bio
POET Project Bell ^b	Scotland, SD	Corn cobs & fiber	0.02	Jan-09	Bio
PureVision Technology, Inc.	Fort Lupton, CO	Corn stover, wood, sugarcane bagasse	N/A	2003	Bio
PureVision Technology, Inc.	Fort Lupton, CO	Corn stover, wood, sugarcane bagasse	N/A	2009	Bio
Range Fuels	Broomfield, CO	Wood waste	N/A	Mar-09	Therm
USDA Citrus & Subtropical Products Laboratory	Winter Haven, FL	Citrus residues	N/A	1990	Bio
Verenium	Jennings, LA	Sugarcane bagasse	0.05	2006	Bio
Verenium	Jennings, LA	Sugarcane bagasse, wood, energycane	1.50	Feb-09	Bio
Western Biomass Energy, LLC. (WBE)	Upton, WY	Wood waste (softwood)	1.50	2007	Bio

Total Existing Production Capacity >3.5 MGY

^aBio = biochemical cellulosic ethanol technology, Therm = thermochemical cellulosic ethanol technology, Both = investigating both technologies.

^bCellulosic pilot plant is collocated with a corn ethanol plant.

^cIn December of 2007, Masada donated the Tennessee Valley Authority's biomass pilot plant facilities and equipment in Muscle Shoals, AL to Auburn University in Auburn, AL.

As shown in Table 1.5-33, today's cellulosic ethanol plants are run by a combination of academic, government, and private organizations. Some of the privately-owned companies are existing corn ethanol producers, but the majority are start-up companies entering the ethanol industry for the first time. Verenium Corp. received a \$10 million grant from DOE to help build their demonstration-level plant in Jennings, LA that just recently came online.

To date, the majority of cellulosic ethanol research has focused on biochemical pre-treatment technologies, i.e., the use of acids and/or enzymes to break down cellulosic materials into fermentable sugars. However, there are a growing number of companies investigating thermochemical conversion which involves gasification of biomass into a synthesis gas or pyrolysis of biomass into a bio-crude oil for processing. Cellulosic diesel, a diesel fuel replacement discussed more in Section 1.5.3.3, can also be made from thermochemical conversion processes. Many companies are also researching the potential of co-firing biomass to produce plant energy in addition to biofuels. For more on the biofuel processing technologies, refer to Section 1.4.3

In addition to the 25 existing facilities, three additional cellulosic ethanol plants are currently under construction in the United States. Like the existing plants, two are pilot-level facilities that are still working towards proving their conversion technologies. However, Range Fuels, a company that received \$76 million from DOE and an \$80 loan guarantee from USDA funding to build one of the first commercial-scale cellulosic ethanol plants in the U.S., is currently building a 40 million gallon per year plant in Soperton, GA.^{BBB} At this time, the company is just working on the initial 10 million gallon per year phase). A summary of the cellulosic ethanol plants currently under construction in the U.S., is presented in Table 1.5-34.

As shown in Tables 1.5-33 and 1.5-34, unlike corn ethanol production, which is primarily located in the Midwest near the Corn Belt, cellulosic ethanol production is spread throughout the country. The geographic distribution of plants is due to the wide variety and availability of cellulosic feedstocks. Corn stover is found primarily in the Midwest, while the Pacific Northwest, the Northeast, and the Southeast all have forestry residues. Some southern states have access to sugarcane bagasse and citrus waste while MSW and C&D debris are available in highly populated areas throughout the country. For more information on cellulosic feedstock availability, refer to Section 1.1.2.

^{BBB} Range Fuels' ultimate goal is to expand the Soperton, GA facility to produce 100 million gallons of cellulosic ethanol per year.

**Table 1.5-34.
Small-Scale Cellulosic Ethanol Plants Currently Under Construction**

Company/Plant Name	Location	Feedstocks	Prod Cap (MGY)	Est. Op. Date	Conv. Tech.^a
Coskata	Madison, PA	MSW, natural gas, woodchips, bagasse, switchgrass	0.04	Jul-09	Therm
DuPont Dansico Cellulosic Ethanol (DDCE)	Vonore, TN	Corn cobs then switchgrass	0.25	Dec-09	Bio
Range Fuels	Soperton, GA	Wood waste, switchgrass	10.00	Dec-09	Therm
Total Under Construction Production Capacity >10 MGY					
^a Bio = biochemical cellulosic ethanol technology, Therm = thermochemical cellulosic ethanol technology.					

This page intentionally left blank.

Increased public interest, government support, technological advancement, and the recently-enacted EISA have helped spur many plans for new cellulosic biofuel plants. Although more and more plants are being announced, most are limited in size and contingent upon technology breakthroughs and efficiency improvements at the pilot and demonstration level. Additionally, because cellulosic biofuel production has not yet been proven on a commercial level, financing of these projects has primarily been through venture capital and similar funding mechanisms, as opposed to conventional bank loans.

Consequently, recently-announced Federal grant and loan guarantee programs may serve as a significant asset to the cellulosic biofuel industry in this area. In February 2007, DOE announced that it would invest up to \$385 million in six commercial-scale ethanol projects over the next four years.⁴⁰⁶ Since the announcement, two of the companies have forfeited their funding. Iogen has decided to locate its first commercial-scale plant in Canada and Alico has discontinued plans to build an ethanol plant all together. The four remaining “pioneer” plants (including Range Fuels) hold promise and could very well be some of the first plants to demonstrate the commercial-scale viability of cellulosic biofuel production. However, there is still more to be learned at the pilot level. Although technologies needed to convert cellulosic feedstocks into ethanol (and diesel) are becoming more and more understood, there are still a number of efficiency improvements that need to occur before cellulosic biofuel production can compete in today’s marketplace.

In May 2007, DOE announced that it would provide up to \$200 million to help fund small-scale cellulosic biorefineries experimenting with novel processing technologies that could later be expanded to commercial production facilities.⁴⁰⁷ Four recipients were announced in January 2008 and three more were announced in April 2008.^{408,409} Three months later, DOE announced that it would provide \$40 million more to help fund two additional small-scale plants.⁴¹⁰ Of the nine total small-scale plants, seven were pursuing cellulosic ethanol production (including Verenium Corp.) and two were planning on producing cellulosic diesel. However, Lignol Innovations, recently suspended plans to build a 2.5 million gallon per year ethanol plant in Grand Junction, CO due to market uncertainty.

The Department of Energy has also introduced a loan guarantee program to help reduce risk and spur investment in projects that employ new, clean energy technologies. In October 2007, DOE issued final regulations and invited 16 project sponsors who submitted pre-applications to submit full applications for loan guarantees.⁴¹¹ Of those who were invited to participate, five were pursuing cellulosic biofuel production. However, only three of the companies appear to still be eligible.^{CCC} Of the three remaining companies, two are pursuing cellulosic ethanol production (and are also DOE grant recipients) and one is pursuing cellulosic diesel production. The U.S. Department of Agriculture is also providing an \$80 million loan guarantee to Range Fuels to help support commercialization of cellulosic ethanol. For a list of the cellulosic biofuel projects receiving DOE grants and/or loan guarantees that are still on the table, refer to Table 1.5-35. For more information on the cellulosic diesel companies listed in this table, and other privately funded plants and proposed projects, refer to Section 1.5.3.2.

^{CCC} Iogen and Alico have also forfeited potential loan guarantees from DOE.

**Table 1.5-35.
Cellulosic Biofuel Plants Receiving DOE or USDA Support^{DDD}**

Company/Plant Name	Location	Feedstocks	Prod Cap (MGY)	Est. Op. Date ^a	Conv. Tech. ^b	DOE Funding	Fed. Loan Guarantee
Cellulosic Ethanol							
Abengoa Bioenergy Corp. ^c	Hugoton, KS	Corn stover, wheat straw, milo stubble, switchgrass	11.4	2012	Bio	\$76MM	DOE
BlueFire Mecca, LLC.	El Sobrante, CA	Woodchips, grass cuttings, and other yard waste	17.0	TBD	Bio	\$40MM	
Ecofin / Alltech	Springfield, KY	Corn cobs	1.3	2010	Bio	\$30MM	
ICM Inc. ^c	St. Joseph, MO	Corn fiber/stover, sorghum, switchgrass	1.5	2010	Bio	\$30MM	
Mascoma Corporation	Kinross, MI ^d	Wood fiber	40.0	2012	Bio	\$26MM	DOE USDA
Pacific Ethanol ^c	Boardman, OR	Wheat straw, wood chips, corn stover	2.7	TBD	Bio	\$24MM	
POET Project Liberty ^c	Emmetsburg, IA	Corn cobs & fiber	25.0	2011	Bio	\$80MM	
Range Fuels ^e	Soperton, GA	Wood waste, switchgrass	40.0	2011	Therm	\$76MM	
RSE Pulp & Chemical	Old Town, ME	Woody biomass	2.2	2010	Bio	\$30MM	
Verenium Corp.	Jennings, LA	Sugarcane bagasse, wood, energycane	1.5	Online	Bio	\$10MM ^f	
Cellulosic Diesel							
Choren U.S.A.	TBD (Southeast U.S.)	Ag residues, forestry biomass, biogenic waste	TBD	TBD	FT		DOE
Flambeau River Biofuels	Park Falls, WI	Forestry residues	6.0	2010	FT	\$30MM	
New Page Corporation ^g	Wisconsin Rapids, WI	Woody biomass, mill residues	5.5	2012	FT	\$30MM	
^a Based on current production plans. In many cases, these estimated production dates are further out than the originally-announced construction timeline. ^b Bio = biochemical cellulosic ethanol technology, Therm = thermochemical cellulosic ethanol technology, FT = Fischer-Tropsch biomass-to-liquids diesel technology. ^c Cellulosic ethanol plant will be collocated with a corn ethanol plant. ^d Mascoma was originally issued a DOE grant to help build a demonstration-level plant in Vonore, TN. However, that location has since been rescinded and Mascoma plans to use the DOE funding towards their planned commercial-level plant in Kinross, MI. This project, a joint venture between Mascoma and JM Longyear, is also known as Frontier Renewable Resources. ^e The first 10 MGY phase is currently under construction. ^f Estimated DOE funding. ^g Project formerly owned by Stora Enso.							

^{DDD} Based on information provided on DOE plant fact sheets and 7/14/08 DOE Small-Scale Biorefinery Project Overview (http://www.doe.gov/media/Small_Scale_Biorefineries_Matrix.pdf.) supplemented with information provided on company websites.

In addition to the aforementioned companies receiving DOE funding, numerous privately-funded companies have announced plans to build cellulosic ethanol plants in the U.S. These projects vary in scope and status. The facilities range in size from pilot and demonstration-level plants (similar to those currently operational or under construction), to small commercial plants (similar to the four commercial-scale plants receiving DOE funding), to large commercial plants (similar in size to an average corn ethanol plant). These facilities are at various states of planning from conducting feasibility studies, to securing funding/financing, to acquiring construction permits, to securing E&C contractors. Some of the projects (“planned” plants) are further along in the planning stage while others are in the very early stages of planning (“proposed” plants). There are also several companies with even less definitive cellulosic biofuel production plans. We will continue to track these companies and plan on providing more information on these projects in the final rulemaking. All in all, while it is uncertain which (if any) of these production plans will come to fruition, we believe the success of such projects will be greatly improved by the impending success of the DOE-supported projects. A summary of the “planned” and “proposed” cellulosic ethanol plants that we are aware of based on our April 2009 industry assessment is provided in Tables 1.5-36 and 1.5-37 below.

**Table 1.5-36.
Planned Cellulosic Ethanol Plants/Capacity**

Company/Plant Name	Location	Feedstocks	Prod Cap (MGY)	Est. Op. Date	Conv. Tech.^a
Abengoa Bioenergy Corporation	Hugoton, KS ^b	Corn stover, wheat straw, milo stubble, switchg	11.4	Early 2012	Bio
BlueFire Ethanol, Inc.	Lancaster, CA	Woodchips, grass cuttings, and other yard wast	3.9	TBD	Bio
BlueFire Mecca, LLC.	El Sobrante, CA	Woodchips, grass cuttings, and other yard wast	17.0	TBD	Bio
ClearFuels Technology ^c	Kauai, HI	Sugarcane bagasse, cane trash, wood waste	1.5	End of 2010	Therm
Coskata	TBD (Southeast U.S.)	Woody biomass	50.0	2012	Therm
Ecofin / Alltech	Springfield, KY	Corn cobs	1.3	2010	Bio
Fulcrum Bioenergy ^d	Storey County, NV	Post-recycled organic waste from MSW	10.5	2010	Therm
ICM Inc.	St. Joseph, MO ^b	Corn fiber/stover, sorghum, switchgrass	1.5	2010	Bio
Mascoma Corporation ^e	Kinross, MI	Wood fiber	40.0	2012	Bio
Pacific Ethanol	Boardman , OR ^b	Wheat straw, wood chips, corn stover	2.7	Early 2011	Bio
POET Project Liberty	Emmetsburg, IA ^b	Corn cobs & fiber	25.0	End of 2011	Bio
Range Fuels	Soperton, GA	Wood waste, switchgrass	30.0	2011	Therm
RSE Pulp & Chemical	Old Town, ME	Woody biomass	2.2	2010	Bio
Southeast Renewable Fuels LLC	Clewiston, FL	Sweet sorghum, bagasse	20.0	End of 2010	Unkn
Verenium / BP	Lake Okeechobee, FL	Energycane, high-biomass sorghum	36.0	2011	Bio
ZeaChem	Boardman, OR	Wood chips, saw dust, logging debris	1.5	2010	Both
Total Planned Plant Capacity			255 MGY		
^a Bio = biochemical cellulosic ethanol technology, Therm = thermochemical cellulosic ethanol technology, Both = investigating both technologies, Unkn = unknown pretreatment technology. ^b Cellulosic ethanol plant will be collocated with a corn ethanol plant. ^c Located at the Gay & Robinson sugar mill. ^d Project also known as known as Sierra Biofuels. ^e This project, a joint venture between Mascoma and JM Longyear, is also known as Frontier Renewable Resources. ^f The first 10 MGY phase is currently under construction in Soperton, GA. Once this second 30 MGY phase is added, the plant will be capable of producing 40 MGY of cellulosic ethanol.					

Table 1.5-37. Proposed Cellulosic Ethanol Plants/Capacity

Company/Plant Name	Location	Feedstocks	Prod Cap (MGY)	Conv. Tech.^a
AEE Distilleries	New Milford, CT	Forest residues, sawdust and yard wastes	24.0	Unkn
Agresti Biofuels	Pike County, KY	MSW	20.0	Bio
Central Minnesota Ethanol Co-op (CMEC)	Little Falls, MN ^b	Woodchips	10.0	Bio
Chemrec & NewPage Corp	Escanaba, MI	Paper mill waste	13.0	Therm
Citrus Energy	Clewiston, FL	Citrus residues	4.0	Bio
Coskata	TBD (Southeast U.S.)	Woody biomass	50.0 ^c	Therm
Energem	Pontotoc, MS	MSW	20.0	Unkn
Florida Crystals Corp.	Okeelanta, FL	Sugarcane bagasse, yard waste	1.5	Bio
Genahol	Lake County, IN	MSW	35.0	Therm
Gulf Coast Energy	Livingston, AL	Wood waste	35.0	Therm
Gulf Coast Energy	Mossy Head, FL	Wood waste	35.0	Therm
Gulf Coast Energy	Cleveland, TN	Wood waste	35.0	Therm
New Age Energy / Liquefaction	Moses Lake, WA ^b	Wheat straw, corn stover, sorghum	40.0	Bio
Orion Ethanol / Dimmitt Ethanol	Dimmitt, TX ^b	Corn Stover	10.0	Unkn
Pan Gen Global (formerly Colusa Biomass)	Colusa County, CA	Rice straw & hulls	12.5	Bio
Pencor Masada OxyNol	Middletown, NY	MSW	9.0	Bio
Range Fuels	Soperton, GA	Wood waste, switchgrass	60.0 ^c	Therm
Raven Biofuels	TBD (MS)	Wood waste	20.0	Bio
Raven Biofuels	TBD (WA)	Wood waste	20.0	Bio
Raven Biofuels	TBD (ID)	Corn cobs	20.0	Bio
Raven Biofuels	TBD (PA)	Wood waste	20.0	Bio
Southeast Renewable Fuels LLC	Clewiston, FL	Sweet sorghum, bagasse	80.0 ^c	Unkn

Total Proposed Plant Capacity 384 MGY

^aBio = biochemical cellulosic ethanol technology, Therm = thermochemical cellulosic ethanol technology, Unkn = cellulosic conversion technology is unknown.

^bCellulosic ethanol plant will be collocated with a corn ethanol plant.

^cPlanned expansion project. Production capacity is in addition to the volumes listed in Tables 1.5-34 and 1.5-36.

1.5.3.2 Federal/State Production Incentives

In addition to helping fund a series of small-scale cellulosic biofuel plants, the Department of Energy, along with the U.S. Department of Agriculture (USDA), is helping to fund critical research to help make cellulosic ethanol production more commercially viable. In March 2007, DOE awarded \$23 million in grants to four companies and one university to develop more efficient microbes for ethanol refining.⁴¹² In June 2007, DOE and USDA awarded \$8.3 million to 10 universities, laboratories, and research centers to conduct genomics research on woody plant tissue for bioenergy.⁴¹³ Later that same month, DOE announced its plan to spend \$375 million to build three bioenergy research centers dedicated to accelerating research and development of cellulosic ethanol and other biofuels. The centers, which will each focus on different feedstocks and biological research challenges, will be located in Oak Ridge, TN, Madison, WI, and Berkeley, CA.⁴¹⁴ In December 2007, DOE awarded \$7.7 million to one company, one university, and two research centers to demonstrate the thermochemical conversion process of turning grasses, stover, and other cellulosic materials into biofuel.⁴¹⁵ In February 2008, DOE awarded another \$33.8 million to three companies and one research center to support the development of commercially-viable enzymes to support cellulose hydrolysis, a critical step in the biochemical breakdown of cellulosic feedstocks.⁴¹⁶ Finally, in March 2008, DOE and USDA awarded \$18 million to 18 universities and research institutes to conduct research and development of biomass-based products, biofuels, bioenergy, and related processes.⁴¹⁷ Since 2007, DOE has announced more than \$1 billion and since 2006, USDA has invested almost \$600 million for the research, development, and demonstration of new biofuel technology.

Numerous states are offering grants and tax incentives to help encourage biofuel production. The majority of efforts are centered on expanding ethanol production, and more recently, cellulosic ethanol production. According to a July 2008 assessment of DOE's Energy Efficiency and Renewable Energy (EERE) website, 33 states currently offer some form of ethanol production incentive.⁴¹⁸ The incentives range from support for ethanol producers to support for research and development companies to support for feedstock suppliers. As shown in Table 1.5-38, 30 states offer ethanol producers support, 19 states offer R&D companies support, and four states offer feedstock suppliers support.

**Table 1.5-38.
State Ethanol Production Incentives**

State	Ethanol Production		R&D		Feedstocks	
	Grant	Tax Credit	Grant	Tax Credit	Grant	Tax Credit
Arkansas	X				X	
California	X		X			
Colorado			X			
Connecticut			X			
Florida	X	X	X	X		
Georgia		X				
Hawaii		X		X	X	
Illinois	X			X		
Indiana		X	X			
Iowa	X	X	X			
Kansas	X	X				
Kentucky		X	X			
Maine		X				
Maryland		X		X		
Michigan				X		
Minnesota		X				
Mississippi		X				
Missouri		X				
Montana		X		X		
New Mexico		X				X
New York		X	X			
North Carolina	X	X		X		
North Dakota	X	X			X	
Oklahoma		X				
Oregon	X	X		X		
Pennsylvania	X		X			
South Carolina		X		X		
South Dakota		X				
Texas	X					
Vermont		X		X		
Virginia	X					
Washington	X	X	X			
Wyoming		X				

The grant and tax credit programs offered to ethanol producers are similar for most of the states that have them. The grants provide funds to help companies cover expenses associated with opening a production facility. These expenses can include land acquisition, site permitting, and plant construction. They typically require the grant amount to be matched by the producers' own funding. The tax credits are given to facilities after they start production and are based on the number of gallons of ethanol produced at each facility. The incentives offered to R&D companies have similar stipulations as the production incentives. However, the grants are less likely to require the organization doing the research to provide matching funds. States that offer tax breaks to biofuel R&D companies tend to either give tax credits based on the company's

research expenses, or give property tax breaks to the lab facilities. Feedstock support is generally in the form of grants given to feedstock processing and/or grain handling facilities or tax credits issued to feedstock producers and distributors.

Out of the 33 states offering ethanol production incentives (shown in Table 1.5-29), only Kansas, Maryland, and South Carolina offer specific incentives towards cellulosic ethanol production or research. Kansas offers revenue bonds through the Kansas Development Finance Authority to help fund construction or expansion of a cellulosic ethanol plant. Additionally, these newly-built or expanded facilities are exempt from state property tax for 10 years. Maryland offers a credit towards state income tax for 10 percent of cellulosic ethanol research and development expenses. They also have a \$0.20 per gallon production credit for cellulosic ethanol. South Carolina gives a \$0.30 per gallon production credit to cellulosic ethanol producers that meet certain requirements.

In addition to the production incentives described above, a group of states in the Midwest have joined together to pursue ethanol and other biofuel production and usage goals as part of the Midwest Energy Security and Climate Stewardship Platform.⁴¹⁹ As of June 2008, Indiana, Iowa, Kansas, Michigan, Minnesota, North Dakota, Ohio, South Dakota, and Wisconsin had all committed to these goals which emphasize energy independence through the growth of cellulosic ethanol production and availability of E85. The Platform goals are to produce cellulosic ethanol on a commercial level by 2012 and to have E85 offered at one-third of refueling stations by 2025. They also want to reduce the energy intensity of ethanol production and supply 50% of their transportation fuel needs by regionally produced biofuels by 2025.

Finally, the passage of the Food, Conservation, and Energy Act of 2008 (also known as the “2008 Farm Bill”) is also projected to spur cellulosic ethanol production and use.⁴²⁰ The 2008 Farm Bill modifies the existing \$0.51 per gallon alcohol blender credit to give preference to ethanol and other biofuels produced from cellulosic feedstocks. Starting in 2009, corn ethanol will receive a reduced tax credit of \$0.45/gal while cellulosic biofuel will earn a credit of \$1.01/gal.^{EEE} The 2008 Farm Bill also has provisions that enable USDA to assist with the commercialization of second-generation biofuels. Section 9003 authorizes loan guarantees for the development, construction and retrofitting of commercial scale biorefineries. Section 9004 provides payments to biorefineries to replace fossil fuels with renewable biomass. Section 9005 provides payments to producers to support and ensure production of advanced biofuels. And finally, Section 9008 provides competitive grants, contracts and financial assistance to enable eligible entities to carry out research, development, and demonstration of biofuels and biomass-based products.

1.5.3.3 Cellulosic Diesel Production/Plans

There has been an emphasis towards ethanol as a renewable fuel which seems to have focused the research and development priorities, as well as the government incentives, towards ethanol as a cellulosic biofuel. This focus is obvious by the number of U.S. companies developing cellulosic ethanol technologies compared to those developing cellulosic diesel fuel

^{EEE} Refer to Part II, Subparts A and B (Sections 15321 and 15331).

technologies. Ethanol does have a regulatory advantage in that it is already registered to be used in gasoline. Cellulosic diesel fuel, however, must be registered by EPA to be used as a blendstock in highway diesel fuel, or used as its own fuel.

Several issues associated with the future use of ethanol may cause entrepreneurial companies to focus more of their research and development efforts towards other cellulosic biofuels such as cellulosic diesel fuel. Recently, the greater worldwide demand for diesel fuel has increased diesel fuel prices relative to those of gasoline. This price difference is likely to continue. Worldwide diesel fuel demand is expected to continue to increase faster than gasoline demand. This is true for the U.S. as well because the expected increase in vehicle efficiency will cause gasoline demand by the light-duty fleet of vehicles here in the U.S. to diminish relative to that of heavy-duty diesel vehicles. Furthermore, the more aggressive pursuit of corn and cellulosic ethanol technologies will tend to further expand the gasoline pool even as gasoline demand falls. Looking towards the future, distributing and blending in more ethanol as E85 is challenging in that it would likely require that ethanol be priced substantially lower than gasoline. The potential for a mid-ethanol blend waiver, allowing the blending and use of higher ethanol blends like E15, could alleviate some of the challenges for using substantial volumes of cellulosic ethanol. However, reaching RFS2 volumes will ultimately require another solution.

Despite the past emphasis towards ethanol, Congress has recognized that cellulosic diesel fuel be provided the same opportunity as cellulosic ethanol. The very significant \$1.01 federal subsidy for developing technologies for converting cellulosic feedstocks into fuels also applies to cellulosic diesel fuel. Additionally, DOE and USDA have provided some grant money or loan guarantees to cellulosic diesel fuel technologies as summarized above in Table 1.5-35.

In Table 1.5-39 we provide a list of the two companies which are commercially producing cellulosic diesel fuel, or conducting development work on cellulosic diesel fuel technologies through pilot plant operations. Despite the focus of most government research and support for ethanol, the company which appears to be the furthest along among all the cellulosic biofuel companies is Cello Energy which has started up a 20 million gallon per year demonstration diesel fuel production plant, the only commercial scale cellulosic biofuel plant in the U.S. In addition, Bell Bio-Energy is aggressively developing its diesel fuel technology through the eventual establishment of 7 pilot plants in different Army bases across the country.

**Table 1.5-39.
Current Cellulosic Diesel Plants**

Company/Plant Name	Location	Feedstocks	Prod Cap (MGY)	Est Op Date	Conv Tech
Cello Energy	Bay Minette, AL	Wood Chips, Hay	20	2008	Cat Depoly
Bell BioEnergy	Fort Stewart, GA	Wood Chips	0.01	2008	Biochm

As mentioned above, Bell Bio-Energy is committed to constructing 7 pilot plants in 7 different Army bases across the country. Also, Bell Bio-Energy is projecting that they will be able to construct and start up a 150 million gallon per year cellulosic diesel plant sometime in 2011. There are several other companies planning on building cellulosic diesel fuel plants in the U.S. Flambeau River Biofuels, Beard Energy and New Page/Chemrec are all biomass to liquids technologies which primarily produce diesel fuel through the thermochemical/Fischer Tropsch route. The earliest of these is Flambeau River Biofuels which is planning on starting up their plant in 2010. The Beard Energy plant is primarily a clean coal plant which will cofire biomass with the coal.

**Table 1.5-40.
Under Construction & Planned Cellulosic Diesel Plants**

Company/Plant Name	Location	Feedstocks	Prod Cap (MGY)	Est Op Date	Conv Tech
Cello Energy	TBD (AL)	Forest Residue and Hay	50	2010	Catalytic Depoly
Cello Energy	TBD (AL)	Forest Residue and Hay	50	2010	Catalytic Depoly
Cello Energy	TBD (GA)	Forest Residue and Hay	50	2010	Catalytic Depoly
Bell Bio-Energy	Fort Lewis, WA	Cellulose	0.01	2009	Bio
Bell Bio-Energy	Fort Drum, NY	Cellulose	0.01	2009	Bio
Bell Bio-Energy	Fort AP Hill, VA	Cellulose	0.01	2009	Bio
Bell Bio-Energy	Fort Bragg, NC	Cellulose	0.01	2009	Bio
Bell Bio-Energy	Fort Benning, GA	Cellulose	0.01	2009	Bio
Bell Bio-Energy	San Pedro, CA	Cellulose	0.01	2009	Bio
Bell Bio-Energy	?	Cellulose	150	2011	Bio
Flambeau River Biofuels	Park Falls, WI	Forest Residue	6.00	2010	Therm-FT
Beard Energy	Wellsville, OH	Forest and Ag Residue; cofired with coal	17	2013	Therm-FT
New Page/Chemrec	Rapids, WI	Forest Residue	5.50	2012	Therm-FT

For a number of technologies summarized in Table 1.5-41, there are no immediate plans for producing cellulosic hydrocarbon biofuels in the U.S., however, they are strong candidates for eventual production in the U.S. Choren has a pilot plant in Germany and is planning to

construct a demonstration plant in Germany in 2011 or 2012. They did receive a commitment for a loan from DOE for building a plant in the U.S., so they have already have a commitment for at least some funding for a plant in the U.S. Also, Choren has developed a presence here in the U.S. UOP/ENI is building a pyrolysis plant in Italy in 2010. Since announcing that plant, UOP has formed a partnership with Ensyn which has been using pyrolysis to make a variety of food additives and other chemicals in Canada and here in the U.S. for many years. The pyrolysis technology being developed by UOP tends to produce more naphtha than diesel fuel. Logos Technologies received almost \$20 million as a grant from the Department of Defense to develop aviation fuels from cellulose. Logos is pooling the expertise and experience of 12 organizations, half of them are universities and the other half are private companies, to derive low cost and highly productive technologies which could include the thermochemical and biochemical pathways. Swift Fuels has developed a technology for producing a high octane aviation gasoline from cellulose which would avoid the use of lead as an additive. The next several companies have developed technologies for converting sugar/starches to various hydrocarbon fuels. Virent is a U.S. based company which is reforming sugars to produce hydrocarbon based fuels. Amyris, Gevo and LS9 are all companies which are developing biochemical technologies for converting sugars/starch to hydrocarbons. For these companies to make the step to using cellulosic feedstocks, they would either have to develop the technology of converting the cellulose to sugars, or partner with other companies which have already mastered that step.

**Table 1.5-41.
Propective Cellulosic Hydrocarbon Technologies in the U.S.**

Company/Plant Name	Feedstocks	Conv Tech
Choren	Wood Chips and Ag residue	Therm-FT
UOP/ENI and Ensyn	Cellulose	Pyrolysis
Logos Technologies	Cellulose	Various
Swift Fuels	Cellulose	Biochem
Virent	Sugars/Cellulose	Reforming
Amyris	Sugars	Biochem
Gevo/Cargil and Bye Energy	Sugars	Biochem
LS9	Sugars	Biochem

1.5.3.4 Meeting the Proposed 2010 Cellulosic Biofuel Standard

As described in Section III.E.b of the Preamble, not only does this notice of proposed rulemaking (NPRM) lay out the proposed biofuel standards through 2022, it sets the biofuel standards applicable in 2010. In accordance with EISA and the regulations set forth in this NPRM, the nation is required to blend 100 million gallons of cellulosic biofuel into U.S. transportation fuels by 2010. We believe our nation’s vehicles and distribution infrastructure are more than capable of accommodating this volume of cellulosic biofuel. Accordingly, we have focused our feasibility assessment on production feasibility.

Building off our April 2009 cellulosic biofuel industry characterizations presented above in Sections 1.5.3.1 and 1.5.3.3, we considered existing, under construction, and planned near-term plants with the potential to produce cellulosic ethanol or cellulosic diesel fuel in 2010. All

together, we came up with 24 pilot- or demonstration-level plants and 7 commercial-level plants that we believe would allow us to meet the 100 million gallon cellulosic biofuel standard in 2010. For plants scheduled to come on part way through the year, we assumed only a percentage of the total production capacity would count towards meeting the RFS2 standard. Still, we estimated that just over 100 million gallons of cellulosic biofuel could be produced and applied towards meeting the RFS2 standard in 2010. And since the majority (about 72%) of the volume is projected to come from cellulosic diesel fuel, the ethanol-equivalent compliance volume would be closed to 145 million gallons. For a summary of the plants that we believe could enable our nation to meet the 100 million gallon cellulosic biofuel standard in 2010, refer to Table 1.5-42.

**Table 1.5-42.
Projected Cellulosic Biofuel Production Capacity in 2010**

Company or Organization Name	Location	Prod Cap (MGY)	Est. Op. Date	Est. 2010 Million Gallons	Est 2010 ETOH-Equiv. Million Gallons
Cellulosic Ethanol					
BPI & Universal Entech	Phoenix, AZ	0.01	Online	0.01	0.01
POET Project Bell	Scotland, SD	0.02	Online	0.02	0.02
Abengoa Bioenergy Corporation	York, NE	0.02	Online	0.02	0.02
Bioengineering Resources, Inc. (BRI)	Fayetteville, AK	0.04	Online	0.04	0.04
Verenium	Jennings, LA	0.05	Online	0.05	0.05
Gulf Coast Energy	Livingston, AL	0.20	Online	0.20	0.20
Mascoma Corporation	Rome, NY	0.20	Online	0.20	0.20
Verenium	Jennings, LA	1.50	Online	1.50	1.50
Western Biomass Energy, LLC. (WBE)	Upton, WY	1.50	Online	1.50	1.50
Coskata	Madison, PA	0.04	Jul-09	0.04	0.04
DuPont Dansico Cellulosic Ethanol (DDCE)	Vonore, TN	0.25	Dec-09	0.25	0.25
Range Fuels	Soperton, GA	10.00	Dec-09	10.00	10.00
Ecofin / Alltech	Springfield, KY	1.30	2010	0.65	0.65
Fulcrum Bioenergy	Storey County, NV	10.50	2010	5.25	5.25
ICM Inc.	St. Joseph, MO	1.50	2010	0.75	0.75
RSE Pulp & Chemical	Old Town, ME	2.20	2010	1.10	1.10
ZeaChem	Boardman, OR	1.50	2010	0.75	0.75
ClearFuels Technology	Kauai, HI	1.50	End of 2010	0.38	0.38
Southeast Renewable Fuels LLC	Clewiston, FL	20.00	End of 2010	5.00	5.00
Cellulosic Diesel					
Cello Energy	Bay Minette, AL	20.00	Online	20.00	32.00
Bell Bio-Energy	Fort Stewart, GA	0.01	2008	0.01	0.01
Bell Bio-Energy	Fort Lewis, WA	0.01	2009	0.01	0.01
Bell Bio-Energy	Fort Drum, NY	0.01	2009	0.01	0.01
Bell Bio-Energy	Fort AP Hill, VA	0.01	2009	0.01	0.01
Bell Bio-Energy	Fort Bragg, NC	0.01	2009	0.01	0.01
Bell Bio-Energy	Fort Benning, GA	0.01	2009	0.01	0.01
Bell Bio-Energy	San Pedro, CA	0.01	2009	0.01	0.01
Cello Energy	TBD (AL)	50.00	2010	16.67	26.67
Cello Energy	TBD (AL)	50.00	2010	16.67	26.67
Cello Energy	TBD (GA)	50.00	2010	16.67	26.67
Flambeau River Biofuels	Park Falls, WI	6.00	2010	3.00	4.80
Total 2010 Production Forecast				100.74	144.57

It is possible that some of the plants highlighted below may experience construction delays and not come online as soon as currently projected. It is also possible that a portion of the biofuel produced at these facilities may not meet the cellulosic biofuel definition based on the feedstocks and/or the fuel's GHG reduction potential (refer to §80.1401). However, on the contrary, it is possible that other cellulosic biofuel plants could come online in this timeframe - especially if construction were to begin soon. Leading corn ethanol producers Archer Daniels

Midland and POET Biorefining are both pursuing cellulosic ethanol production. ADM is currently investigating cellulosic ethanol production through a cooperative research agreement with Purdue University. The ADM-Purdue project is focused on commercializing the use of highly-efficient yeast to convert cellulosic materials into ethanol through fermentation.⁴²¹ In addition, ADM is also collaborating with Deere & Company and Monsanto Company on research that explores economically-sustainable methods for the harvest, storage and transport of corn stover for the production of animal feed, process energy, and/or cellulosic biofuel.⁴²² Depending on discoveries made during the research, it is possible that ADM could begin processing small amounts of corn stover and producing an appreciable volume of cellulosic biofuel at some of its existing U.S. ethanol plants in this timeframe. In addition, POET recently opened a 20,000 gallon-per-year demonstration-level cellulosic ethanol plant at its Scotland, SD research center (shown above in Table 1.5-39). It has plans to bring a 25 million-gallon-per-year plant online in Emmetsburg, IA in 2011. However, POET recently announced that it plans to produce cellulosic ethanol at six more of its existing corn ethanol plants in Iowa in the future.⁴²³ Depending on how aggressive they are with pursuing these cellulosic ethanol production plans, POET could further contribute to meeting the 2010 cellulosic biofuel standard. In addition, a number of companies are currently building or operating demonstration-level cellulosic biofuel plants overseas. It is possible that these companies could export their production or decide to build a commercial plant in the United States in response to the proposed RFS2 standards. Finally, there could also be a number of start-up companies that we are unaware of that could contribute to meeting the 2010 cellulosic biofuel standard.

1.5.3.5 Projected Cellulosic Feedstocks and Facilities Under RFS2

As noted in Section 1.5.3.1, cellulosic ethanol production capacity needs to expand greatly in order to meet the cellulosic biofuel mandate of 16 billion gallons by 2022. While current production plans provide an initial idea of the types of feedstocks and potential plant locations that are being considered by biofuel producers, future production will be highly dependent on acquiring relatively cost-effective feedstocks in sufficient quantities.

A wide variety of feedstocks can be used for cellulosic ethanol production, including: agricultural residues, forestry biomass, municipal solid waste, construction and demolition waste, and energy crops. These feedstocks are much more difficult to convert into ethanol than traditional starch/corn crops or at least require new and different processes because of the more complex structure of cellulosic material.

At least initially, the focus will be on feedstocks that are readily available, already produced or collected for other reasons, and even waste biomass which currently incurs a disposal fee. Consequently, initial volumes of cellulosic biofuels may benefit from low-cost feedstocks. However, to reach 16 Bgal will likely require reliance on more expensive feedstock sources purposely grown and or harvested for conversion into cellulosic biofuel.

To determine the likely cellulosic feedstocks for production of 16 billion gallons cellulosic biofuel by 2022, we analyzed the data and results from various sources. Sources include agricultural modeling from the Forestry Agriculture Sector Optimization Model (FASOM) to establish the most economical agriculture residues and energy crops (see Section

5.1 for more details on the FASOM), consultation with USDA-Forestry Sector experts for forestry biomass supply curves, and feedstock assessment estimates for urban waste.^{FFF}

An important assumption in our analysis projecting which feedstocks will be used for producing cellulosic ethanol is that an excess of feedstock would have to be available for producing the biofuel. Banks are anticipated to require excess feedstock supply as a safety factor to ensure that the plant will have adequate feedstock available for the plant, despite any feedstock emergency, such as a fire, drought, infestation of pests etc. For our analysis we assumed that twice the feedstock of MSW, C&D waste, and forest residue would have to be available to justify the building of a cellulosic ethanol plant. For corn stover, we assumed 50 percent more feedstock than necessary. We used a lower safety factor for corn stover because it could be possible to remove a larger percentage of the corn stover in any year (usually only 50 percent or less of corn stover is assumed to be sustainably removed in any one year).^{GGG}

Another assumption that we made is that if multiple feedstocks are available in an area, each would be used as feedstocks for a prospective cellulosic ethanol plant. For example, a particular area might comprise a small or medium sized city, some forest and some agricultural land. We would include the MSW and C&D wastes available from the city along with the corn stover and forest residue for projecting the feedstock that would be processed by the particular cellulosic ethanol plant.

Previously, Section 1.1 described the total potential availability of various cellulosic feedstocks. Due to EISA, a substantial amount of the available feedstocks will need to be used for biofuels production. This section discusses the estimated amounts from each feedstock type needed to meet the EISA requirement of 16 Bgal of cellulosic biofuel by 2022 and also explains our projections for the locations of potential cellulosic biofuel facilities based on feedstock availability.

Urban Waste

Cellulosic feedstocks available at the lowest cost to the ethanol producer will likely be chosen first. This suggests that urban waste which is already being gathered today and which incurs a fee for its disposal may be among the first to be used. Urban wood wastes are used in a variety of ways. Most commonly, wastes are ground into mulch, dumped into land-fills, or incinerated with other municipal solid waste (MSW) or construction and demolition (C&D) debris. Urban wood wastes include a variety of wood resources such as wood-based municipal solid waste (MSW) and wood debris from construction and demolition.

Urban waste (MSW wood, paper, and C&D debris) was estimated to be located near large population centers. We estimated a total of 42 million dry tons of MSW (paper, wood, and

^{FFF} It is important to note that our plant siting analysis for cellulosic ethanol facilities used the most current version of outputs from FASOM at the time, which was from April 2008. Since then, FASOM has been updated to reflect better assumptions. Therefore, the version used for the NPRM in Section 5.1 is slightly different than the one we used here. We do not believe that the differences between the two versions are enough to have a major impact on the plant siting analysis.

^{GGG} The FASOM results do not take into consideration these feedstock safety margins. Safety margins were used, however, for the plant siting analysis described in this section.

yard trimmings) and C&D wood waste could be available nationwide for producing biofuels after factoring in the various assumptions on percent landfilled, percent moisture, percent contaminated, etc. as described in Section 1.1.2.3 on feedstock availability. We further assumed that approximately 25 million dry tons (of the total 42 billion dry tons) would be used, however, since many areas of the U.S. (e.g. much of the Rocky Mountain states) would not have a cellulosic facility in close enough proximity.

We arrived at the 25 million dry tons with the following analyses. First, using the MSW and C&D wood waste estimates by state we calculated the tons of MSW and C&D wood waste material generated per person per state. We used the estimate of MSW and C&D wood waste material generated per person per state (i.e. tons/person) along with data on the population sizes of the largest cities within the state to allocate the total waste material in a state to specific cities.

Much of the materials are already being collected and may be available to a potential ethanol producer at negligible costs. For instance, some additional sorting or size reduction may increase costs, however, tipping fees (fees for materials that are discarded at landfills) can also be avoided which would decrease the potential cost the feedstock. Chapter 4 of this DRIA further discusses feedstock costs. Assuming that the majority of this waste is of negligible cost to a potential ethanol producer, we calculated a minimum size for a cellulosic plant dedicated to MSW and C&D wood waste for various locations in the U.S. Sizes ranged from 9-60 million gallons per year.

First we did not consider those cities, while small, may still be able to justify a cellulosic ethanol plant because some other source of biomass is also available that combined with the MSW and C&D wood waste can supply the cellulosic ethanol plant with sufficient feedstock. However, where non-MSW and C&D wood waste feedstocks are not available, we needed to estimate what the minimum plant size would be that would be competitive with other cellulosic ethanol plants.

We conducted this analysis early on before NREL provided us with the cost information for a biochemical cellulosic ethanol plant. Instead we used a representation made by NREL in 2007 for of a thermochemical ethanol plant. Using that cellulosic plant model we estimated the production cost for a 100 million gallon per year thermochemical plant which processed a cellulosic feedstock. We conducted this analysis in different parts of the country using different capital cost factors that account for how capital costs vary in different parts of the country. The different regions were Petroleum Administration for Defense Districts (PADDs) for which we have plant installation costs. In each part of the country, we estimated the cost of the ethanol produced processing the cellulosic feedstock assuming that the feedstock cost about \$70 per dry ton. Next, we set the feedstock costs to zero cost in our cost spreadsheet and determined at what plant size, when scaling the capital costs as the plant size became smaller, the resulting cellulosic production costs matched those of the non-MSW and C&D wood waste plants. See Table 1.5-43.

**Table 1.5-43
Breakeven Plant Size for MSW and C&D Wood Waste Cellulosic Ethanol Plants**

	PADD 1	PADD 2	PADD 3	PADD 4	PADD 5	CA
Ethanol Production Cost (c/gal)	1.33	1.24	1.10	1.29	1.19	1.57
Breakeven Plant Size (million gals/yr)	28	19	9	23	15	60

We then identified the cities that had large enough MSW and C&D wood waste to justify a dedicated cellulosic facility. By dedicated cellulosic facility, we mean that only MSW and C&D wood waste is used as a feedstock, as opposed to a facility that has multiple mixed feedstocks. Nineteen facilities were identified to meet such criteria, as shown in Table 1.5-44. The total contribution from dedicated cellulosic MSW and C&D wood waste is approximately 640 million gallons.

**Table 1.5-44.
Projected Dedicated Cellulosic MSW and C&D
Wood Waste Facilities by Location and Size for 2022**

	State	County	City	PADD	Size of Facility (Mgal)
1	Alabama	Jefferson	Birmingham	3	11
2	Arizona	Maricopa	Phoenix	5	20
3	California	Los Angeles	Los Angeles	5	56
4	California	Riverside	Riverside	5	24
5	California	San Francisco	San Francisco	5	17
6	Colorado	Adams	Denver	4	28
7	Florida	Miami	Fort Lauderdale	1	31
8	Georgia	Cobb	Atlanta	1	43
9	Illinois	Cook	Chicago	2	79
10	Michigan	Oakland	Detroit	2	33
11	Nevada	Clark	Las Vegas	5	17
12	New York	New York City	New York	1	72
13	Oregon	Clackamas	Portland	4	15
14	Pennsylvania	Philadelphia	Philadelphia	1	42
15	Texas	Dallas	Dallas	3	52
16	Texas	Fort Bend	Houston	3	49
17	Texas	Bexar	San Antonio	3	16
18	Texas	Travis	Austin	3	14
19	Washington	King	Seattle	5	17

We did assume that in areas with other cellulosic feedstocks (forest and agricultural residue), that the MSW would be used even if the MSW could not justify the installation of a plant on its own. MSW used in mixed feedstock plants is shown in Table 1.5-36. Therefore, we have estimated that urban waste could help contribute to the production of approximately 2.2

billion gallons of ethanol.^{HHH} Subsequent to initiating our analysis, however, we realized that the the renewable biomass definition in the statute may preclude the use of most MSW. See Section III.B.1 of the Preamble for a discussion of renewable biomass. When the definition of renewable biomass is finalized, it could preclude the use of waste paper and C&D waste for use in producing cellulosic biofuel for use toward the RFS2 standard. If this is the case, our FRM analysis will be adjusted to reflect this.

Agricultural and Forestry Residues

The next category of feedstocks chosen will likely be those that are readily produced but have not yet been commercially collected. This includes both agricultural and forestry residues.

Agricultural residues are expected to play an important role early on in the development of the cellulosic ethanol industry due to the fact that they are already being grown. Agricultural crop residues are biomass that remains in the field after the harvest of agricultural crops. The most common residue types include corn stover (the stalks, leaves, and/or cobs), straw from wheat, rice, barley, or oats, and bagasse from sugarcane. The eight leading U.S. crops produce more than 500 million tons of residues each year, although only a fraction can be used for fuel and or energy production due to sustainability and conservation constraints.⁴²⁴ Crop residues can be found all over the United States, but are primarily concentrated in the Midwest since corn stover accounts for half of all available agricultural residues.

Agricultural residues play an important role in maintaining and improving soil tilth, protecting the soil surface from water and wind erosion, and helping to maintain nutrient levels. Thus, collection and removal of agricultural residues must take into account concerns about the potential for increased erosion, reduced crop productivity, depletion of soil carbon and nutrients, and water pollution. Sustainable removal rates for agricultural residues have been estimated in various studies, many showing tremendous variability due to local differences in soil and erosion conditions, soil type, landscape (slope), tillage practices, crop rotation managements, and the use of cover crops. These are described in more detail in Section 1.1. One of the most recent studies by top experts in the field showed that under current rotation and tillage practices, ~30% of stover (about 59 million metric tonnes) produced in the US could be collected, taking into consideration erosion, soil moisture concerns, and nutrient replacement costs. The same study showed that if farmers chose to convert to no-till corn management and total stover production did not change, then ~50% of stover (100 million metric tonnes) could be collected without causing erosion to exceed the tolerable soil loss.⁴²⁵ This study, however, did not consider possible soil carbon loss which other studies indicate may be a greater constraint to environmentally sustainable feedstock harvest than that needed to control water and wind erosion.⁴²⁶ Experts agree that additional studies are needed to further evaluate how soil carbon and other factors affect sustainable removal rates. Despite unclear guidelines for sustainable removal rates due to the uncertainties explained above, our agricultural modeling analysis assumes that 0% of stover is removable for conventional tilled lands, 35% of stover is removable for conservation tilled lands, and 50% is removable for no-till lands. In general, these removal guidelines are appropriate only for the Midwest, where the majority of corn is currently grown.

^{HHH} Assuming approximately 90 gal/dry ton ethanol conversion yield

As already noted, removal rates will vary within regions due to local differences. Given the current understanding of sustainable removal rates, we believe that such assumptions are reasonably justified. We invite comment on these assumptions. Based on our research we also note that residue maintenance requirements for the amount of biomass that must remain on the land to ensure soil quality is another approach for modeling sustainable residue collection quantities, therefore we also invite comment on this approach. This approach would likely be more accurate for all landscapes as site specific conditions such as soil type, topography, etc. could be taken into account. This would prevent site specific soil erosion and soil quality concerns that would inevitably exist when using average values for residue removal rates across all soils and landscapes. At the time of our analyses we had limited data on which to accurately apply this approach and therefore assumed the removal guidelines based on tillage practices. Refer to the Section 1.1 of this DRIA for more discussion on sustainable removal rates.

Our agricultural modeling (FASOM) suggests that corn stover will make up the majority of agricultural residues used by 2022 to meet the EISA cellulosic biofuel standard (approximately 83 million dry tons used to produce 7.8 billion gallons of cellulosic ethanol).^{III} Smaller contributions are expected to come from bagasse, which is a by-product from the production of sugarcane, (1.2 bgal ethanol) and sweet sorghum pulp (0.1 bgal ethanol). At the time of this proposal, FASOM was able to model agricultural residues but not forestry biomass as potential feedstocks. As a result, we relied on USDA-Forest Service (FS) for information on the forestry sector.

Using the assumptions from FASOM on residue and ethanol yields, we determined if it is possible to site potential cellulosic plants based on the acres currently harvested. We identified that there are enough harvested acres to produce 7.8 Bgal of ethanol from corn stover by 2022 without having to rely on new lands. Therefore, the siting of many of the cellulosic facilities will likely be located where corn is typically grown today. See Table 1.5-45 for a summary of the states producing corn stover, and their projected volume contribution to meeting the EISA cellulosic requirement by 2022.

^{III} Assuming 94 gal/dry ton ethanol conversion yield for corn stover in 2022

**Table 1.5-45.
Projected Ethanol Produced to Meet EISA in 2022 from Corn Stover^{JJJ}**

State	Total Harvested Acres (in 2022)	Total Residue Yield (tons/acre)	Total Residue Available (Million tons)	Sustainably Removable Residue Yield (tons/acre)	Sustainably Removable Residue Available (Million tons)	Residue Used (Million tons)
Total	71,784,020	n/a	380	n/a	122	82
Illinois	12,994,100	5.43	71	1.62	21	15
Indiana	6,209,463	5.58	35	2.09	13	10
Iowa	14,482,313	5.47	79	1.59	23	17
Kansas	3,026,615	5.33	16	1.65	5	3
Kentucky	1,473,023	5.08	7	2.04	3	1
Michigan	2,238,321	4.30	10	1.79	4	3
Minnesota	7,509,658	5.37	40	1.60	12	8
Missouri	2,732,875	4.73	13	2.93	8	5
Nebraska	10,135,162	5.88	60	1.28	13	9
Ohio	3,712,612	4.91	18	1.89	7	5
South Dakota	4,268,425	4.01	17	1.41	6	4
Wisconsin	3,001,454	4.74	14	2.33	7	5

^{JJJ} Corn stover is given in dry tons/acre and assumes an ethanol yield of 94 gal/dry ton; Sustainably removable residue yields assumes only the fraction that can be removed after accounting for sustainable removal rates based on tillage practices. This table gives approximate averages by state based on our agricultural modeling, actual yields will vary greatly depending on specific soil type, slope, etc. Also, the values above are calculated using the FASOM data outputs from April 2008 and thus are slightly different from those found in Section 5.1 of this DRIA which use more updated runs.

Sugarcane, on the other hand, is grown mainly in Florida, Louisiana, and Texas, although plans are underway to also grow sugarcane in California as well. See Section 1.1.1.2 of this DRIA for more discussion on sugarcane ethanol produced in the U.S. If all the sugarcane acres harvested today in the U.S. were used to produce ethanol from the bagasse, using the assumptions from FASOM on residue and ethanol yields, only approximately 700 million gallons could be produced, see Table 1.5-46. FASOM, however, predicts that the production of 1.2 billion gallons of ethanol could be economically feasible from sugarcane bagasse. This means that between now and 2022, more sugarcane may be grown, allowing for more availability of bagasse in the future.

**Table 1.5-46.
Projected Ethanol Produced to Meet EISA in 2022 from Sugarcane Bagasse**

State	Total Bagasse			Ethanol Produced (Million gallons)
	Total Harvested Acres (in 2007)	Yield (tons/acre)	Residue Used (Million tons)	
Total	810,800	n/a	10	707
Florida	382,000	14.71	6	389
Louisiana	389,600	10.25	4	277
Texas	39,200	15.23	1	41

Using FASOM, we analyzed the types of land likely to be supplanted by additional sugarcane acres in 2022 in the states of Florida, Louisiana, and Texas. In Florida, sugarcane crops appear to replace mainly corn, soy, and hay acres. In Louisiana, sugarcane crops appear to have replaced mainly corn, soy, wheat, sorghum, and hay acres. In Texas, sugarcane crops appear to have replaced mainly soy and sorghum crops. For these three states we gathered available data on corn, soy, wheat, and sorghum acres currently harvested by county (data on hay acres were unavailable and appeared to show small changes compared to corn and soy).⁴²⁷ We then identified the top counties (in terms of acres available) in close proximity to each other that could potentially be converted from corn to sugarcane crops, soy to sugarcane, wheat to sugarcane, etc in order to produce enough ethanol for half a billion gallons.

Sweet sorghum pulp is predicted to be used to produce approximately 0.1 billion gallons of ethanol. According to the National Agriculture and Statistics Service (NASS) of the Department of Agriculture, there is not current available data on sweet sorghum acres grown in the United States. Therefore, we used FASOM to predict the types of crops that sweet sorghum is mainly replacing, which is corn and soybeans. Similar to the analysis done for sugarcane, we identified the top counties (in terms of acres available) in close proximity to each other that could potentially be converted from corn to sweet sorghum crops and soy to sweet sorghum crops in order to produce enough ethanol for 0.1 billion gallons.

The U.S. has vast amounts of forest resources that could potentially provide feedstock for the production of cellulosic biofuel. One of the major sources of woody biomass could come from logging residues. The U.S. timber industry harvests over 235 million dry tons annually and produces large volumes of non-merchantable wood and residues during the process.⁴²⁸ Logging

residues are produced in conventional harvest operations, forest management activities, and clearing operations. In 2004, these operations generated approximately 67 million dry tons/year of forest residues that were left uncollected at harvest sites.⁴²⁹ Other feedstocks include those from other removal residues, thinnings from timberland, and primary mill residues.

Harvesting of forestry residue and other woody material can be conducted throughout the year. Thus, unlike agricultural residue which must be moved to secondary storage, forest material could be “stored on the stump.” Avoiding the need for secondary storage and the transportation costs for moving the feedstock there potentially provides a significant cost advantage for forest residue over agricultural residue. This could allow forest residue to be transported from further distances away from the cellulosic plant compared to agricultural residue at the same feedstock price. Section 1.1.2.2 further details some of challenges with using forestry biomass as a feedstock.

EISA does not allow forestry material from national forests and virgin forests that could be used to produce biofuels to count towards the renewable fuels requirement under EISA. Therefore, we required forestry residue estimates that excluded such material. Most recently, the USDA-FS provided forestry biomass supply curves for various sources (i.e., logging residues, other removal residues, thinnings from timberland, etc.). This information suggested that a total of 76 million dry tons of forest material could be available for producing biofuels (excluding forest biomass material contained in national forests as required under the Act). See Section 1.1.2.2 for more information on forest residue feedstock availability. However, much of the forest material is in small pockets of forest which because of its regional low density, could not help to justify the establishment of a cellulosic ethanol plant. After conducting our availability analysis, we estimated that approximately 44 million dry tons of forest material could be used, which would make up approximately one fourth, or 3.8 billion gallons, of the 16 billion gallons of cellulosic biofuel required to meet EISA.

Dedicated Energy Crops

While urban waste, agricultural residues, and forest residues will likely be the first feedstocks used in the production of cellulosic biofuel, there may be limitations to their use due to land availability, sustainable removal rates, etc. Energy crops which are not yet grown commercially but have the potential for high yields and a series of environmental benefits could help provide additional feedstocks in the future. Dedicated energy crops are plant species grown specifically as renewable fuel feedstocks. Various perennial plants have been researched as potential dedicated feedstocks. These include switchgrass, mixed prairie grasses, hybrid poplar, miscanthus, and willow trees.

In addition to estimating the extent that agricultural residues might contribute to cellulosic ethanol production, FASOM also estimated the contribution that energy crops might provide.^{KKK} FASOM covers all cropland and pastureland in production in the 48 conterminous United States, however it does not contain all categories of grassland and rangeland captured in USDA’s Major Land Use data sets. Therefore, it is possible there is land appropriate for

^{KKK} Assuming 16 Bgal cellulosic biofuel total, 2.2 Bgal from Urban Waste, and 3.8 Bgal from Forestry Biomass; 10 Bgal of cellulosic biofuel for ag residues and/or energy crops would be needed.

growing dedicated energy crops that is not currently modeled in FASOM. Furthermore, we constrained FASOM to be consistent with the 2008 Farm Bill and assumed 32 million acres would stay in CRP.^{LLL} These constraints on land availability may have contributed to the model choosing a substantial amount of agricultural residues mostly as corn stover and a relatively small portion of energy crops as being economically viable feedstocks. The use of other models, such as USDA's Regional Environment and Agriculture Programming (REAP) model and University of Tennessee's POLYSYS model, have shown that the use of energy crops in order to meet EISA may be more significant than our current FASOM modeling results.^{MMM} As such, we plan to revisit these land availability assumptions in order to arrive at a more consistent basis for the FRM.

Given the constraints outlined above, FASOM projects that 0.9 billion gallons of cellulosic ethanol from switchgrass is economically feasible by 2022. The majority of switchgrass is projected to likely be grown in Oklahoma, where the majority of acres are replacing wheat and hay. A smaller portion is expected to come from West Virginia and New Hampshire where hay is mainly replaced. Similar to the analysis done for sugarcane and sweet sorghum, we identified the top counties (in terms of acres available) in close proximity to each other that could potentially be converted from wheat to switchgrass or hay to switchgrass in order to produce enough ethanol for 0.9 billion gallons.

Summary of Cellulosic Feedstocks for 2022

Table 1.5-47 summarizes our internal estimate of cellulosic feedstocks and their corresponding volume contribution to 16 billion gallons cellulosic biofuel by 2022 for the purposes of our impacts assessment.

^{LLL} Beside the economic incentive of a farmer payment to keep land in CRP, local environmental interests may also fight to maintain CRP land for wildlife preservation. Also, we did not know what portion of the CRP is wetlands which likely could not support harvesting equipment.

^{MMM} Biomass Research and Development Initiative (BR&DI), "Increasing Feedstock Production for Biofuels: Economic Drivers, Environmental Implications, and the Role of Research," <http://www.brdisolutions.com>, December 2008.

**Table 1.5-47.
Cellulosic Feedstocks Assumed to Meet EISA in 2022**

Feedstock	Volume (Bgal)
Agricultural Residues	9.1
Corn Stover	7.8
Bagasse ^{NNN}	1.2
Sweet Sorghum Pulp	0.1
Forestry Biomass	3.8
Urban Waste	2.2
Dedicated Energy Crops (Switchgrass)	0.9
Total	16.0

Cellulosic Plant Siting

Future cellulosic biofuel plant siting was based on the types of feedstocks that would be most economical as shown in Table 1.5-35, above. As cellulosic biofuel refineries will likely be located close to biomass resources in order to take advantage of lower transportation costs, we've assessed the potential areas in the U.S. that grow the various feedstocks chosen. To do this, we used data on harvested acres by county for crops that are currently grown today, such as corn stover and sugarcane (for bagasse).⁴³⁰ In some cases, crops are not currently grown, but have the potential to replace other crops or pastureland (e.g. dedicated energy crops). We used the output from our economic modeling (FASOM) to help us determine which types of land are likely to be replaced by newly grown crops. For forestry biomass, USDA-Forestry service provided supply curve data by county showing the available tons produced. Urban waste (MSW wood, paper, and C&D debris) was estimated to be located near large population centers.

Our analyses also take into account the locations of planned cellulosic facilities as well as any corn facilities or pulp and paper mills when we project where cellulosic plants are located into the future. While not all planned cellulosic facilities will likely come to fruition, it was important to look at the locations of these facilities as their locations are likely to be chosen for good reasons (i.e. close to resources, infrastructure in place, etc.). We analyzed current corn facilities and pulp and paper mill sites as well since they are likely to be close to their respective feedstocks (i.e. corn stover and wood residues) and could have many synergies with cellulosic biofuel production, such as shared steam and electricity production. However, this does not mean that we have chosen to place cellulosic facilities at all the locations where there are current corn facilities and pulp and paper mills. The locations are only used to help select areas that could be preferential towards building a cellulosic facility

Using feedstock availability data by county/city, we located potential cellulosic sites across the U.S. that could justify the construction of a cellulosic plant facility. Table 1.5-48 shows the volume of cellulosic facilities by feedstock by state projected for 2022. The total

^{NNN} Bagasse is a byproduct of sugarcane crushing and not technically an agricultural residue. Sweet sorghum pulp is also a byproduct of sweet sorghum processing. We have included it under this heading for simplification due to sugarcane being an agricultural feedstock.

volumes given in Table 1.5-35 match the total volumes given in Table 1.5-36 within a couple hundred million gallons. As these differences are relatively small, we believe the cellulosic facilities sited are a good estimate of potential locations.

Table 1.5-48.
Projected Cellulosic Ethanol Volumes by State (million gallons in 2022)

State	Total Volume	Ag Volume	Energy Crop Volume	Urban Waste Volume	Forestry Volume
Alabama	532	0	0	140	392
Arkansas	298	0	0	0	298
California	450	0	0	221	229
Colorado	28	0	0	28	0
Florida	421	390	0	31	0
Georgia	437	0	0	67	370
Illinois	1,525	1,270	0	198	58
Indiana	1,109	948	0	101	60
Iowa	1,697	1,635	0	32	30
Kansas	310	250	0	29	32
Kentucky	70	70	0	0	0
Louisiana	1,001	590	0	103	308
Maine	191	0	0	2	189
Michigan	505	283	0	171	51
Minnesota	876	750	0	50	76
Mississippi	214	0	0	22	192
Missouri	654	504	0	78	72
Montana	92	0	0	9	83
Nebraska	956	851	0	31	75
Nevada	17	0	0	17	0
New Hampshire	171	0	35	29	107
New York	72	0	0	72	0
North Carolina	315	0	0	98	217
Ohio	598	410	0	156	32
Oklahoma	793	0	777	0	16
Oregon	244	0	0	44	200
Pennsylvania	42	0	0	42	0
South Carolina	213	0	0	57	156
South Dakota	434	350	0	6	78
Tennessee	97	0	0	19	78
Texas	576	300	0	131	145
Virginia	197	0	0	95	102
Washington	175	0	0	17	158
West Virginia	149	0	101	0	48
Wisconsin	581	432	0	43	106
Total Volume	16,039	9,034	913	2,139	3,955

Each of the cellulosic plants was chosen to produce approximately 100 million gallons per year of ethanol. In some cases we had to resort to lower volumes due to limited resources in

a given area. In other cases, we used greater than 100 million gallons per year because relatively close materials were available that would otherwise go unused. In addition, we limited biomass transport distances to be approximately 100 miles each way or less (radius from proposed facility), as large transport distances are economically prohibitive. We found that the majority of corn stover cellulosic facilities required smaller transport distances than the assumed 100 mile limit due to relatively close proximity to available feedstocks. Forest residues, on the other hand, typically required greater distances as collectable material appeared to be sparser. The following Table 1.5-49 lists the 180 cellulosic ethanol facilities that we project could be used to produce 16 Bgal of cellulosic biofuel by 2022. See Figure 1.5-16 for a visual representation of the locations of these facilities.

**Table 1.5-49.
Projected Cellulosic Facilities
(million gallons in 2022)**

County	State	Total Volume (million gallons/yr)
Escambia	Alabama	112
Greene	Alabama	108
Morgan	Alabama	96
Russell	Alabama	101
Talledega	Alabama	115
Cleveland	Arkansas	99
Howard	Arkansas	97
Woodruff	Arkansas	102
Butte	California	94
Orange	California	133
San Joaquin	California	120
Siskiyou	California	102
Adams	Colorado	28
Broward	Florida	31
Hendry	Florida	90
Palm Beach	Florida	100
Palm Beach	Florida	100
Palm Beach	Florida	100
Glynn	Georgia	108
Grady	Georgia	130
Richmond	Georgia	101
Treutlen	Georgia	98
Bureau	Illinois	130
Carroll	Illinois	77
Champaign	Illinois	89
Coles	Illinois	77
De Witt	Illinois	100
Du Page	Illinois	128
Grundy	Illinois	77
Iroquois	Illinois	80
Knox	Illinois	89
Menard	Illinois	99
Montgomery	Illinois	78

Morgan	Illinois	67
Ogle	Illinois	95
Richland	Illinois	81
Shelby	Illinois	68
Tazewell	Illinois	107
Washington	Illinois	85
Benton	Indiana	92
Clinton	Indiana	80
Daviess	Indiana	93
De Kalb	Indiana	91
Fulton	Indiana	74
Jasper	Indiana	82
Jennings	Indiana	94
Madison	Indiana	78
Morgan	Indiana	100
Parke	Indiana	92
Union	Indiana	82
Vanderburgh	Indiana	74
Wells	Indiana	77
Benton	Iowa	69
Buchanan	Iowa	83
Buena Vista	Iowa	84
Cerro Gordo	Iowa	79
Chickasaw	Iowa	82
Des Moines	Iowa	87
Dubuque	Iowa	70
Franklin	Iowa	80
Grundy	Iowa	83
Guthrie	Iowa	85
Ida	Iowa	88
Mahaska	Iowa	80
Muscatine	Iowa	83
O Brien	Iowa	80
Page	Iowa	81
Palo Alto	Iowa	75
Pottawattamie	Iowa	84
Sioux	Iowa	72
Story	Iowa	89
Union	Iowa	76
Webster	Iowa	86
Logan	Kansas	75
Nemaha	Kansas	78
Sedgwick	Kansas	71
Stevens	Kansas	87
Webster	Kentucky	70
Bienville	Louisiana	115
E. Baton Rouge	Louisiana	106
E. Carroll	Louisiana	103
Jeff Davis	Louisiana	87
Allen	Louisiana	50

Avoyelles	Louisiana	100
Iberville	Louisiana	90
La Fourche	Louisiana	50
Lafayette	Louisiana	100
Pt. Coupe	Louisiana	100
St Landry	Louisiana	100
Penobscot	Maine	100
Piscataquis	Maine	91
Calhoun	Michigan	109
Ionia	Michigan	117
Tuscola	Michigan	105
Van Buren	Michigan	89
Wayne	Michigan	85
Chippewa	Minnesota	92
Dakota	Minnesota	114
Dodge	Minnesota	86
Faribault	Minnesota	88
Lyon	Minnesota	84
Martin	Minnesota	95
Rock	Minnesota	73
Sibley	Minnesota	102
Stearns	Minnesota	68
Stevens	Minnesota	76
Forrest	Mississippi	107
Grenada	Mississippi	107
Audrain	Missouri	86
Chariton	Missouri	74
Clark	Missouri	89
Gentry	Missouri	95
New Madrid	Missouri	84
Ray	Missouri	100
St. Louis	Missouri	125
Sanders	Montana	92
Boone	Nebraska	98
Custer	Nebraska	84
Harlan	Nebraska	78
Hitchcock	Nebraska	83
Holt	Nebraska	91
Lancaster	Nebraska	74
Lincoln	Nebraska	81
Nuckolls	Nebraska	76
Saunders	Nebraska	100
Wayne	Nebraska	96
York	Nebraska	94
Clark	Nevada	17
Carroll	New Hampshire	136
Carroll	New Hampshire	35
West Chester	New York	72
Cumberland	North Carolina	110
Forsyth	North Carolina	104

Martin	North Carolina	102
Auglaize	Ohio	80
Clinton	Ohio	100
Franklin	Ohio	77
Logan	Ohio	75
Portage	Ohio	98
Richland	Ohio	83
Wood	Ohio	85
Craig	Oklahoma	130
Grady	Oklahoma	108
Hughes	Oklahoma	91
Kingfisher	Oklahoma	110
Lincoln	Oklahoma	120
Muskogee	Oklahoma	118
Osage	Oklahoma	116
Lane	Oregon	126
Yamhill	Oregon	118
Montgomery	Pennsylvania	42
Berkeley	South Carolina	105
Spartanburg	South Carolina	108
Day	South Dakota	85
Edmunds	South Dakota	80
Kingsbury	South Dakota	98
Lake	South Dakota	83
Turner	South Dakota	89
Monroe	Tennessee	97
Angelina	Texas	114
Bexar	Texas	16
Cameron	Texas	100
Dallas	Texas	52
Harris	Texas	80
Hidalgo	Texas	100
Travis	Texas	14
Willacy	Texas	100
Halifax	Virginia	98
Prince George	Virginia	99
Chelan	Washington	78
Thurston	Washington	97
Harrison	West Virginia	149
Calumet	Wisconsin	91
Dane	Wisconsin	76
Dunn	Wisconsin	63
Eau Claire	Wisconsin	65
Grant	Wisconsin	68
Jefferson	Wisconsin	94
Marquette	Wisconsin	65
Wood	Wisconsin	59
Total		16039

Figure 1.5-16. Projected Cellulosic Facilities

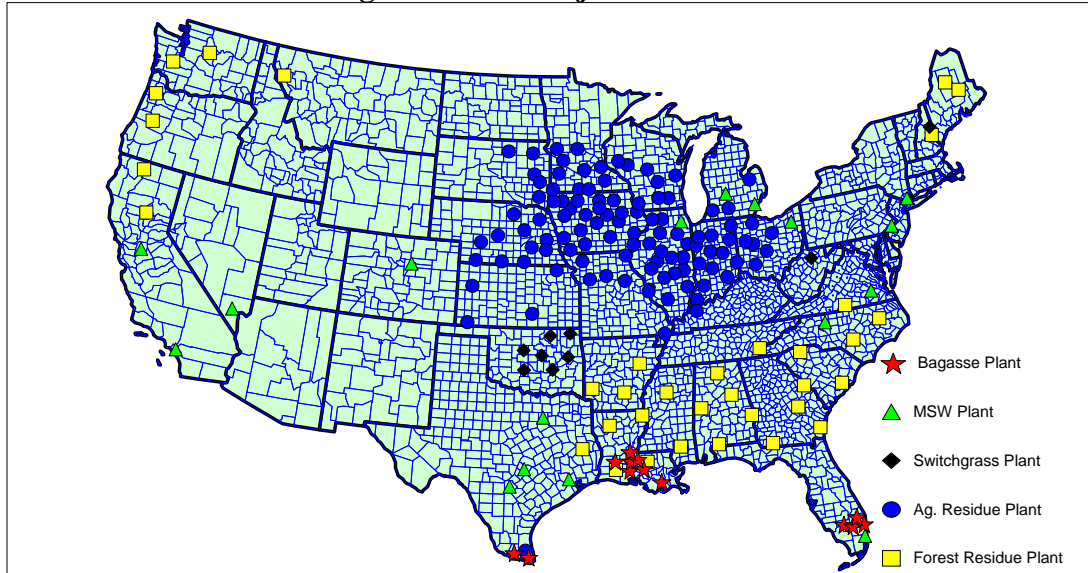

It is important to note, however, that there are many more factors other than feedstock availability to consider when eventually siting a plant. We have not taken into account, for example, water constraints, availability of permits, and sufficient personnel for specific locations. As many of the corn stover facilities are projected to be located close to corn starch facilities, there is the potential for competition for clean water supplies. Therefore, as more and more facilities draw on limited resources, it may become apparent that various locations are infeasible. Nevertheless, our plant siting analysis provides a reasonable approximation for analysis purposes since it is not intended to predict precisely where actual plants will be located. Other work is currently being done that will help address some of these issues, but at the time of this proposal, was not yet available.⁴³¹

As we are projecting the location of cellulosic plants in 2022, it is important to keep in mind the various uncertainties in the analysis. For example, future analyses could determine better recommendations for sustainable removal rates. In the case where lower removal rates are recommended, agricultural residues may be more limited and could promote more growth in dedicated energy crops. Given the information we have to date, we believe our projected locations for cellulosic facilities represent a reasonable forecast for estimating the impacts of this rule.

1.5.4 Biodiesel & Renewable Diesel

Biodiesel

The biodiesel industry differs significantly in profile from the ethanol industry, in that it is comprised of plants with a wide variety of sizes, ranging from less than one million gallons to more than 50 million gallons per year production capacity, using feedstock ranging from virgin soy oil to recycled cooking grease and rendered fats. The industry capacity has expanded

rapidly, going from a sparse network of small businesses selling locally to one with large companies selling internationally in less than a decade. Approximately 176 plants reported being on-line for production in 2008, with a mean size of 13 million gallons per year and a median size of just 5 million gallons per year. Figure 1.5-17 below shows historical aggregate capacity, sales volumes, and apparent capacity utilization rates.

Figure 1.5-17. Recent biodiesel industry capacity and production trends.

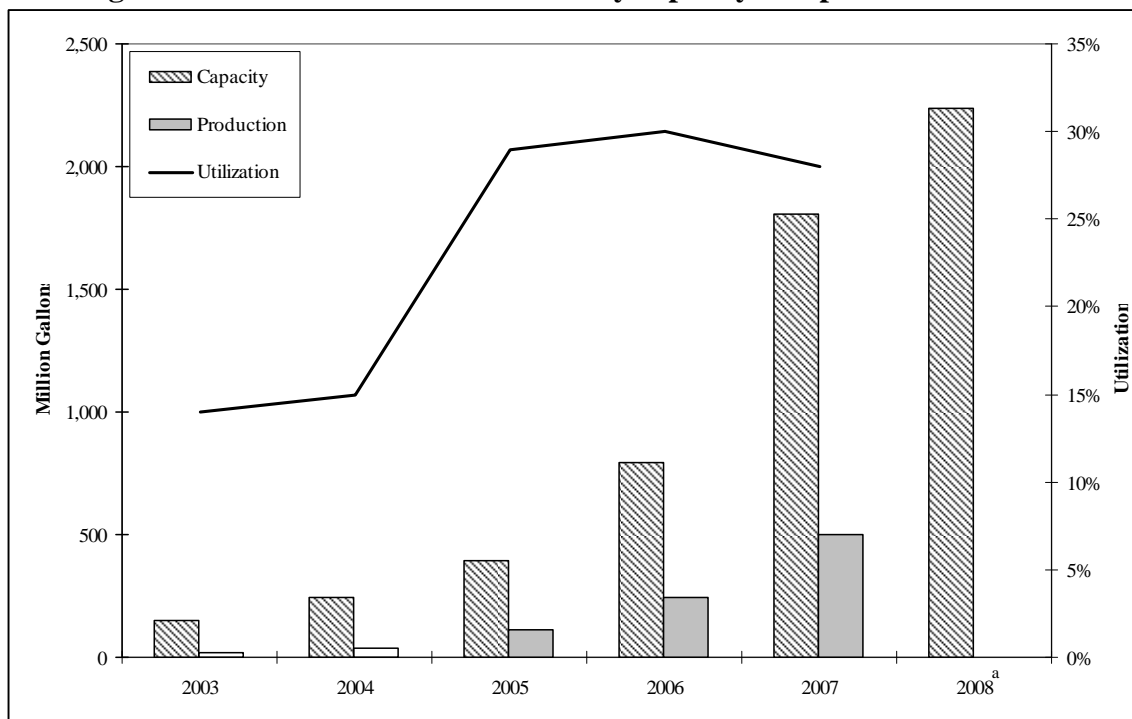

^a 2008 capacity figure is as of January; annual production figures were not available for 2008 at the time of this writing.

The average utilization capacity has stayed around 30% for the past few years due to continued expansion of on-line capacity despite apparently adequate existing capacity. We can speculate that this is primarily because of the relatively low capital cost (typically 5-10% of operating cost) of these plants, which enables them to operate only part of the year or at reduced capacity, depending on feedstock prices or other market conditions. Besides fuel, some of these plants also produce non-fuel oleochemicals for use in detergents, lubricants or other products, providing additional sources of revenue for part of the industry.

In order to conduct our emissions and distribution analyses, we needed to have an industry characterization at the time of the fully phased-in program, the year 2022. This was not a simple task because of the unusual nature of the biodiesel industry. We generally assumed that the demand for biodiesel would stabilize at approximately the level of the standard, which seemed reasonable given the relatively high cost for biodiesel feedstocks as well as the uncertain status of the current tax incentives. We estimated how many plants would continue to produce biodiesel and where they might be located based on three factors: state incentives for production and sales, BQ-9000 certification, and capabilities for handling multiple feedstock types. Plants

with more of these advantages were expected to be more likely to survive over those that had fewer. We projected that a number of very small plants processing waste greases/fats would continue to operate based on local market niches regardless of these criteria. In an effort to be realistic in this forecast, other practical considerations were made, such as avoiding siting several plants in the same state (except in the Midwest).

We project that between now and 2022 plants will continue to compete and consolidate to make fewer plants of larger size. During this period most plants will have added the pre-treatment and feedstock segregation capacity to process any mix of feedstock types available in their area. By the out-years of this analysis, we expect production capacity use factors to reach 80-90% in nearly all fuel plants. Multi-product plants will retain the capacity to produce biodiesel, but it is not expected to be their primary product due to higher margins for more specialized products like surfactants, lubricants, or renewable oleochemical feedstocks for re-sale. The map in Figure 1.5-18 represents what the industry might look like by 2022. Table 1.5-50 summarizes key parameters of the industry as it is currently and in the 2022 forecast.

Figure 1.5-18. Biodiesel industry forecast for 2022

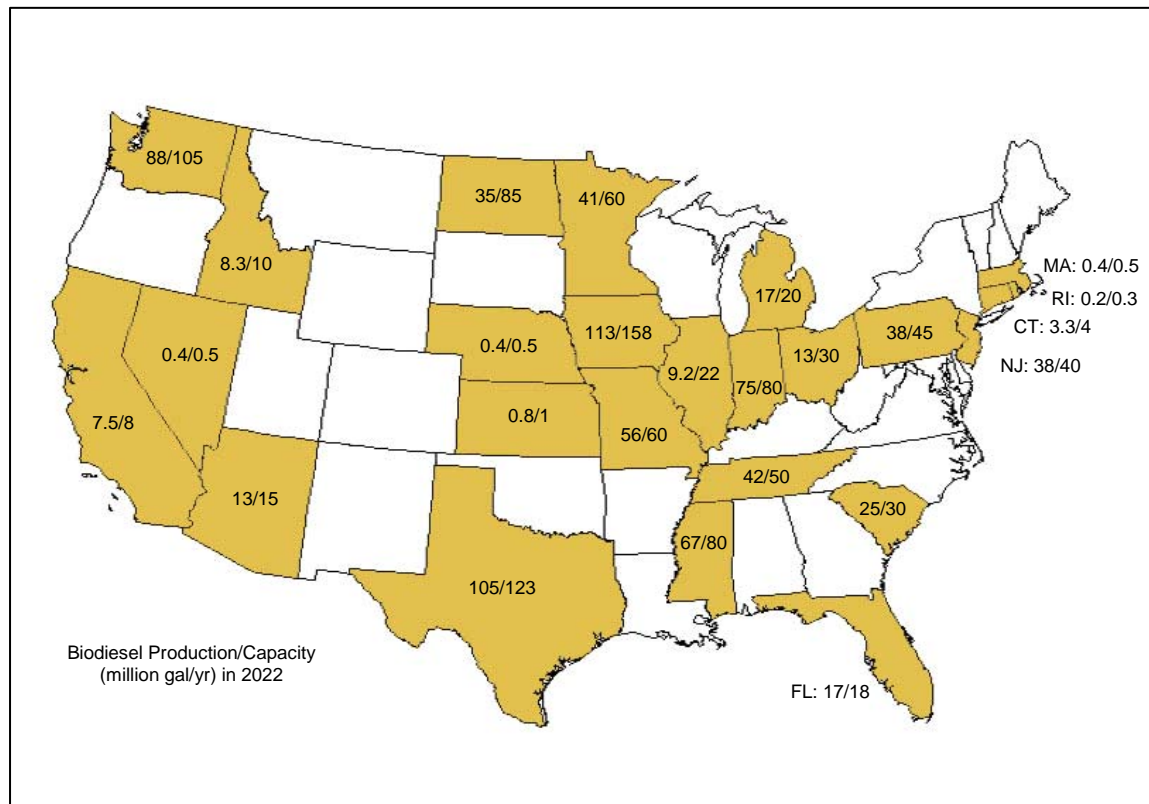

Table 1.5-50. Summary of current biodiesel industry and forecast.⁴³²

	2008	2022
Total production capacity on-line (million gal/yr)	2,610	1,050
Number of operating plants	176	35
Median plant size (million gal/yr)	5	30
Total biodiesel production (million gal)	700	810
Average capacity factor	0.27	0.77

Renewable Diesel

Since December, 2007, ConocoPhillips has been producing a small amount (300-500 bbl/day) of renewable diesel at their Borger, Texas, refinery from beef tallow generated by Tyson Foods, Inc. in Amarillo, Texas.⁴³³ In 2007, Dynamic Fuels, LLC., was formed by Syntroleum Corp. and Tyson Foods, Inc., to produce liquid renewable fuels. This fall Dynamic Fuels has announced ground-breaking for a 75 million gallon per year plant (5,000 bbl/day) in Geismar, Louisiana, that will use Tyson meat processing fats as feedstock to Syntroleum's Bio-Synfining process. Start-up is scheduled for 2010, with the primary product being high-quality diesel fuel that will be fungible within the existing petroleum supply system.⁴³⁴

The earlier years of our industry projection are based primarily on feasibility and construction announcements by Dynamic Fuels, LLC, while the later years are based on the available supply of rendered fats and greases as feedstocks, assuming the continued expansion of fuel conversion facilities to utilize them. We project a mix of stand-alone and refinery co-located facilities. Stand-alone facilities receive feedstocks, process them, and ship out finished products, and are generally self-sufficient in terms of material and energy. Conversion facilities that are located within the boundaries of existing petroleum refineries can take advantage of utilities such as steam and hydrogen already available on-site, as well as hydrocarbon blendstocks, and tankage and pipeline, rail, and port terminals. Material that is processed at existing refineries can either be co-processed in the same equipment trains with petroleum, or processed separately and blended just before leaving the facility.

The Geismar, Louisiana, facility plans to utilize supplies of hydrogen available in the industrial park where it will be located, as well as rail and shipping infrastructure already in place nearby.⁴³⁵ However, it is not co-located with existing petroleum production, and therefore would be considered a stand-alone facility in our analyses.

Based on public material released by Syntroleum earlier this year, it appears that a second plant of 150 million gallons per year capacity is also under consideration for construction, but location, timeline, and feedstock source are not known at this time.⁴³⁶ Table 1.5-51 shows the industry forecast used in our analyses of renewable diesel production in 2022. The Geismar, Louisiana, facility comprises part of the 125 million gallons per year in 2022 of new facility fuel shown in the table below, while the facility expansion values represent production we expect to come on-line at existing refineries in the future.

Table 1.5-51. Projected renewable diesel volumes (million gallons in 2022)

	Expansion at existing refinery	New stand-alone facility
Co-processed with petroleum	188	-
Not co-processed with petroleum	63	125

1.6 Biofuel Distribution

1.6.1 Biofuel Distribution Overview

The discussion in this section pertains to the distribution of biofuels within the U.S. Significant volumes of ethanol would be imported into the U.S. to meet the volume of ethanol that we project would be used to Satisfy the RFS2 standards. The importation of ethanol into the U.S. under the RFS2 standards is discussed in Section 1.5.2 of this DRIA.

The modes of distributing renewable fuels to the end user vary depending on constraints arising from their physical/chemical nature and their point of origination. Some fuels are compatible with the existing fuel distribution system, while others currently require segregation from other fuels up to the point where they are blended with petroleum based fuels. The location of renewable fuel production plants is also often dictated by the need to be close to the source of the feedstocks used rather than to fuel demand centers or to take advantage of the existing pipeline distribution system for petroleum products.^{OOO} Once blended with petroleum-based fuels, some biofuels (such as E10, B2, and B5) can be handled in the conventional fuel distribution downstream of the terminal (including retail) and used in conventional vehicles.^{PPP} However, E85 must be used in flex-fuel vehicles and dispensed from retail equipment that has been manufactured to tolerate the high ethanol concentration. Hence, the distribution of renewable fuels raises unique concerns and in many instances requires the addition of new transportation, storage, blending, and retail equipment.

Significant challenges must be faced in reconfiguring the distribution system to accommodate the large volumes of ethanol and to a lesser extent biodiesel that we project would be used to meet the proposed standards. While some uncertainties remain, there is no barrier that appears insurmountable. The response of the transportation system to date to the recent unprecedented increase in ethanol use is encouraging. A recent U.S. Department of Agriculture (USDA) report concluded that logistical concerns have not hampered ethanol production growth to date, but that concerns may arise about the adequacy of transportation infrastructure as the growth in ethanol production continues.⁴³⁷

Considerations related to the distribution of ethanol, biodiesel, and renewable diesel are discussed in the following sections as well as the changes to each segment in the distribution system that would be needed to support the volumes of these biofuels that we project would be

^{OOO} A discussion of the projected locations of ethanol production facilities can be found in chapter 1.5 of this DRIA.
^{PPP} E10 is a mixture of 10% ethanol and 90% gasoline. B2 is a mixture of 2% biodiesel and 98% petroleum-based diesel. B5 is a mixture of 5% biodiesel and 95% petroleum-based diesel.

used to satisfy the RFS2 standards. The costs associated with making the necessary changes to the fuel distribution infrastructure are discussed in Section 4.2 of this DRIA.

Considerable efforts are underway by individual companies in the fuel distribution system, consortiums of such companies, industry associations, independent study groups, and inter-agency governmental organizations to evaluate what steps might be necessary to facilitate the necessary upgrades to the distribution system to support compliance with the RFS2 standards.^{QQQ} EPA will continue to participate in or monitor these efforts as appropriate to keep abreast of potential problems in the biofuel distribution system which might interfere with the use of the volumes of biofuels that we project will be needed to comply with the RFS2 standards.

To the extent that biofuels other than ethanol and biodiesel are produced in response to the RFS2 standards, the need for added segregation during distribution might be lessened. For example, we expect renewable diesel fuel could be handled like a petroleum-based diesel blend stock in the distribution system. Distillate fuel produced from cellulosic feedstocks could also likely be treated as a petroleum-based diesel fuel blendstock or finished diesel fuel in the distribution system. Likewise, bio-gasoline or bio-butanol could likely be treated as petroleum-based gasoline blendstocks.^{RRR} The ability to treat such bio-based blendstocks in that same fashion as petroleum-based fuel blendstocks might enhance the possibility for transport by pipeline. However, the location of the production plants for such biofuels relative to petroleum pipeline origination points would continue to be an issue limiting the usefulness of existing pipelines.^{SSS}

1.6.1.1 Overview of Ethanol Distribution

Denatured ethanol is shipped from production and import facilities to petroleum terminals where it is blended with gasoline. Pipelines are the preferred method of shipping large volumes of petroleum products over long distances because of the relative low cost and reliability. However, ethanol is not commonly shipped by pipeline currently because it can cause stress corrosion cracking in pipeline walls and its affinity for water and solvency can result in product contamination concerns. The location of ethanol production and demand centers also would tend to limit the extent to which existing petroleum pipelines could be used to ship ethanol. Shipping ethanol in pipelines that carry distillate fuels as well as gasoline also presents unique difficulties in coping with the volumes of a distillate-ethanol mixture which would typically result.^{TTT} It is not possible to re-process this mixture in the way that diesel-gasoline

^{QQQ} For example: 1) The “Biomass Research and Development Board”, an inter-governmental group, has formed a group that is focused on evaluating biofuels distribution infrastructure issues. 2) The National Commission on Energy Policy, an independent organization, has formed a Biofuels Infrastructure Task Force composed of industry experts to evaluate what steps need to be taken to support the distribution of the volumes of biofuels mandated under the Energy Information and security Act (EISA) on which the RFS2 standards are based. 3) The Association of Oil Pipelines is conducting research to evaluate what steps a necessary to allow the distribution of ethanol blends by pipeline.

^{RRR} Biogasoline might also potentially be treated as finished fuel.

^{SSS} The projected location of biofuel plants would not be affected by the choice of whether they are designed to produce ethanol, distillate fuel, bio-gasoline, or butanol. Proximity to the feedstock would continue to be the predominate consideration.

^{TTT} Different grades of gasoline and diesel fuel are typically shipped in multi-product pipelines in batches that abut each other. To the extent possible, products are sequenced in a way to allow the interface mixture between batches

mixtures resulting from pipeline shipment are currently handled.^{UUU} Substantial testing and analysis is currently underway to resolve these concerns so that ethanol may be shipped by pipeline either in a batch mode or blended with petroleum-based fuel.⁴³⁸ By the time of the publication of this proposal, results of these evaluations may be available regarding what actions are necessary by multi-product pipelines to overcome safety and product contamination concerns associated with shipping 10% ethanol blends. A short gasoline pipeline in Florida also started shipping commercial batches of denatured ethanol in December of 2008.⁴³⁹ Thus, there is the potential that existing petroleum pipelines in some areas of the county may play a role in the shipment of ethanol from the points of production/importation to petroleum terminals.

However, the location of ethanol plants in relation to existing pipeline origination points will continue to limit the role that can be played by pipelines in the shipment of ethanol.^{VVV} Current corn/starch ethanol production facilities are primarily located in the Midwest far from the origination points of most existing product pipelines and the primary gasoline demand centers.^{WWW} This is also projected to primarily be the case for future corn/starch ethanol plants.^{XXX} While the projected future cellulosic ethanol plants are expected to be somewhat more dispersed throughout the country, we project that most will be located in the Midwest.^{YYY} Some imported ethanol could be brought into ports near the origination points of product pipelines in the gulf coast and the Northeast. Nevertheless, the majority of ethanol will continue to be produced at locations distant from the origination points of product pipelines and gasoline demand centers. The gathering of ethanol from production facilities located in the Midwest and shipment by barge down the Mississippi for introduction to pipelines in the gulf coast is under consideration. However, the additional handling steps to bring the ethanol to the pipeline origin points in this manner would diminish the potential benefit of shipment by existing petroleum pipelines compared to direct shipment by rail.

Evaluations are also currently underway regarding the feasibility of constructing a new dedicated ethanol pipeline from the Midwest to the East coast.⁴⁴⁰ Under such an approach, ethanol would be gathered from a number of Midwest production facilities to provide sufficient volume to justify pipeline operation. To the extent that ethanol production would be further concentrated in the Midwest due to the citing cellulosic ethanol plants there, this would tend to help justify the cost of installing a dedicated ethanol pipeline. There are substantial issues that would need to be addressed before construction on such a pipeline could proceed, including those associated with securing new right of ways and establishing sufficient surety regarding the return on the several billion dollar investment.

to be cut into one of the adjoining products. In cases where diesel fuel abuts gasoline in the pipeline, the resulting mixture must typically be reprocessed into its component parts by distillation for resale as gasoline and diesel fuel.

^{UUU} We believe that it may not currently be possible to separate ethanol from a gasoline/diesel mixture sufficiently by distillation. Hence, a significant amount of ethanol may remain in the gasoline and diesel fractions separated by distillation. Gasoline-ethanol mixtures can be blended into finished gasoline provided the applicable maximum allowed ethanol concentration is not exceeded. However, diesel-ethanol mixtures can not be used as motor fuel.

^{VVV} Some small petroleum product refineries are currently limited in their ability to ship products by pipeline because their relatively low volumes are not sufficient to justify connection to the pipeline distribution system.

^{WWW} The location of current corn/starch ethanol production facilities is discussed in Section 1.5.1.1 of this DRIA.

^{XXX} The projected growth in corn/starch ethanol plants under the proposed RFS2 standards is discussed in Section 1.5.1.2 of this DRIA.

^{YYY} The projected location of cellulosic ethanol plants is discussed in Section 1.5.3 of this DRIA.

Due to the uncertainties regarding the degree to which pipelines will be able to participate in the transportation of ethanol, we assumed that ethanol will continue to be transported by rail, barge, and truck to the terminal where it would be blended into gasoline. There is substantial room for the distribution by these modes to be further optimized primarily through the increased shipment by unit train and installation of additional hub delivery terminals that can accept large volumes of ethanol for further distribution to satellite terminals. To the extent that pipelines do eventually play a role in the distribution of ethanol, this could tend to reduce distribution costs and improve reliability in supply.

The United States Department of Agriculture estimated that in 2005, approximately 60% of ethanol was transported by rail, 30% was transported by tank truck, and 10% was transported by barge.⁴⁴¹ When practicable, shipment by unit train is the preferred method of rail shipment rather than shipping on a manifest rail car basis.^{zzz} Manifest rail car shipment refers to the shipment of ethanol in rail tank cars that are incorporated into trains which are composed of a variety of other commodities. The use of unit trains, sometimes referred to as a virtual pipeline, substantially reduces shipping costs and improves reliability compared to manifest rail car shipment. Unit trains are composed entirely of 70-100 ethanol tank cars, and are dedicated to shuttle back and forth to large hub terminals.^{AAAA} Unit train receipt facilities can either be located at petroleum terminals (when there is sufficient room available) or at rail terminals. When unit train facilities are located at rail facilities, ethanol is further shipped to petroleum terminals by tank truck or barge.

Unit trains can be composed at a single ethanol production plant or if a group of plants are not large enough to support such service individually, can be formed at a central facility which gathers ethanol from a number of producers. The Manly Terminal in Iowa, the first such ethanol gathering facility, accepts ethanol from a number of nearby ethanol production facilities for shipment by unit train. Regional (Class 2) railroad companies are an important link bringing ethanol to gathering facilities for assembly into unit trains for long-distance shipment by larger (Class 1) railroads.

Ethanol is sometimes carried by multiple modes before finally arriving at the terminal where it is blended into gasoline. The practice of pumping ethanol directly from rail cars to tank trucks for further delivery to petroleum terminals at rail terminals is an important means of bringing ethanol into developing markets.^{BBBB} This practice delays the need to install substantial ethanol handling and storage facilities at rail receipt facilities. However, we believe that it may not be a viable long term solution due to the logistical demands associated with ensuring the safe transfer of ethanol directly from rail cars to tank trucks. We anticipate that once the ethanol distribution system is fully developed all ethanol shipped to rail terminals will be delivered into storage tanks prior to further distribution to petroleum terminals. Similarly, the practice of sequential delivery of gasoline and ethanol into a tank truck at the terminal so that mixing to the finished fuel specification takes place within the tank truck during delivery is an important

^{AAAA} Hub ethanol receipt terminals can be located at large petroleum terminals or at rail terminals.

^{BBBB} This practice is sometimes referred to as transloading.

means of bringing ethanol to developing markets.^{CCCC} This practice allows the blending of ethanol in markets prior to the installation of in-line ethanol blending equipment at petroleum terminals. In-line blending refers to the practice of delivering a pre-blended ethanol/gasoline mixture into the tank truck. Due to the improved efficiency of delivery and greater assurance of achieving the target blend ratio and a properly mixed final blend that accompanies in-line blending, we anticipate that all terminals will eventually install in-line blending equipment.^{DDDD}

As is the case for conventional gasoline, delivery of ethanol blends to retailers and fleets operators is accomplished by tank truck. Typically no changes are needed to dispense E10 at retail and fleet facilities. However, some retail facilities in parts of the country that have not used E10 in the past are projected to need to prepare their systems for E10 service primarily by removing water from their storage tanks. E10 can be used in conventional engines. E85 requires specially certified retail dispensing hardware and can only be used in flexible fuel vehicles.^{EEEE}

1.6.1.2 Overview of Biodiesel Distribution

Biodiesel is currently transported from production plants to petroleum terminals by tank truck, manifest rail car, and by barge where it is blended with petroleum-based diesel fuel. Unblended biodiesel must be transported and stored in insulated/heated containers in colder climates to prevent gelling. Insulated/heated containers are not needed for biodiesel that has been blended with petroleum-based diesel fuel in low concentrations (i.e. B2, B5, B20). Biodiesel plants are not as dependent on being located close to feedstock sources as are corn and cellulosic ethanol plants.^{FFFF} This has allowed some biodiesel plants to be located adjacent to petroleum terminals. Biodiesel production facilities are more geographically dispersed than ethanol facilities and the production volumes also tend to be smaller than ethanol facilities.^{GGGG} These characteristics in combination with the smaller volumes of biodiesel that we project will be used under the RFS2 standards compared to ethanol allow relatively more biodiesel to be used within trucking distance of the production facility. However, we project that there will continue to be a strong and growing demand for biodiesel as a blending component in heating oil which could not be satisfied alone by local sources of production. It is likely that State biodiesel mandates will also need to be satisfied in part by out-of-State production. Fleets are also likely to continue to be a substantial biodiesel user, and these will not always be located close to biodiesel producers. Thus, we are assuming that a substantial fraction of biodiesel will continue to be shipped long distances to market. Downstream of the petroleum terminal, B2 and B5 can be distributed in the same manner as petroleum diesel and used in conventional diesel engines.

^{CCCC} This practice is sometimes referred to as splash blending. The term splash blending can also refer to blending ethanol with a gasoline blendstock that is not formulated in anticipation of the addition of ethanol. Matched blending refers to the practice of blending ethanol with a specially formulated gasoline blendstock that in itself can not typically be sold as finished gasoline.

^{DDDD} Most terminals are likely to install in-line ethanol blending equipment by 2013 as the use of E10 becomes virtually nationwide. The growth in ethanol consumption under the proposed RFS2 standards is discussed in Section 1.7.1.2 of this DRIA.

^{EEEE} A discussion of Underwriters Laboratories certification requirements for E85 dispensing equipment can be found at <http://ulstandardsinfontet.ul.com/outscope/outscope.asp?fn=0087a.html>

^{FFFF} Biodiesel feedstocks are typically preprocessed to oil prior to shipment to biodiesel production facilities. This can substantially reduce the volume of feedstocks shipped to biodiesel plants relative to ethanol plants.

^{GGGG} Section 1.5.4 of this DRIA contains a discussion of our projections regarding the location of biodiesel production facilities.

Concerns remain regarding the shipment of biodiesel by pipeline (either by batch mode or in blends with diesel fuel) related to the potential contamination of other products (particularly jet fuel), the solvency of biodiesel, and compatibility with pipeline gaskets and seals. The smaller anticipated volumes of biodiesel and the more dispersed and smaller production facilities relative to ethanol also make biodiesel a less attractive candidate for shipment by pipeline. Due to the uncertainties regarding the suitability of transporting biodiesel by pipeline, we assumed that biodiesel which needs to be transported over long distance will continue to be carried by rail car and to a lesser extent by barge. Due to the relatively small plant size and dispersion of biodiesel plants, we anticipate the volumes of biodiesel that can be gathered at a single location will continue to be insufficient to justify shipment by unit train. To the extent that pipelines do eventually play a role in the distribution of biodiesel, this could tend to reduce distribution costs and improve reliability in supply.

1.6.1.3 Overview of Renewable Diesel Distribution

We believe that renewable diesel fuel will be confirmed to be sufficiently similar to petroleum-based diesel fuel blendstocks with respect to distribution system compatibility. Hence, renewable diesel fuel could be treated in the same manner as any petroleum-based diesel fuel blendstock with respect to transport in the existing petroleum distribution system. Approximately two-thirds of renewable diesel fuel is projected to be produced at petroleum refineries.^{HHHH} The transport of such renewable diesel fuel would not differ from petroleum-based diesel fuel since it would be blended to produce a finished diesel fuel before leaving the refinery. The other one-third of renewable diesel fuel is projected to be produced at stand-alone facilities located more closely to sources of feedstocks. We anticipate that such renewable diesel fuel would be shipped by tank trucks to nearby petroleum terminals where it would be blended directly into diesel fuel storage tanks. Because of its high cetane, we anticipate that all renewable diesel fuel would likely be blended with petroleum based diesel fuel prior to use. Downstream of the terminal, renewable/petroleum diesel fuel mixtures would be distributed the same as petroleum diesel.

1.6.2 Shipment of Ethanol to Petroleum Terminals

There is considerable uncertainty regarding how ethanol would be shipped to petroleum terminals once the market matures under the RFS2 standards. Our evaluation for this NPRM is based on an assessment of current trends in ethanol distribution and engineering judgment regarding how these trends are likely to develop over time. As discussed below, there is a lack of data on existing biofuels distribution facilities and capabilities as well as uncertainties regarding how the distribution system would respond to increased biofuels volumes. Hence, we were compelled to make certain assumptions based on a review of available literature and discussions with industry. A study was recently completed for EPA by Oakridge National Laboratories (ORNL) which modeled the transportation of ethanol from production/import facilities to petroleum terminals.⁴⁴² The ORNL model optimizes freight flows over the rail, marine, and road distribution net while addressing the use of multiple shipping modes. We plan

^{HHHH} A discussion of the projected location of renewable diesel fuel production facilities is contained in Section 1.5.4 of this DRIA. Renewable diesel fuel produced at petroleum refineries would either be co-processed with crude oil or processed in separate units located at the refinery for blending with other diesel blendstocks at the refinery.

to use the results of the ORNL study to adjust our projections regarding how ethanol would be shipped to petroleum terminals for the final rule, particularly with respect to how much ethanol can be shipped directly by tank truck from production facilities and the relative roles of unit train, manifest rail, and barge in the distribution chain.

USDA estimated that approximately 30% of direct ethanol deliveries from production facilities to petroleum terminals in 2005 were accomplished by tank truck.⁴⁴³ As the total volume of ethanol used increases and ethanol is shipped to more markets that are distant from production centers (e.g. in the Southeast), we expect that shipments by rail would increase and direct tank truck shipments to petroleum terminals to decrease to 20%. We believe that for transportation distances of less than 200 miles all shipments of ethanol to petroleum terminals would be by tank truck. Transportation by tank truck for a distance over 200 miles typically requires an overnight layover which significantly increases costs. Thus, we anticipate that only a limited volume of ethanol would be transported by tank truck for a distance of between 200 and 300 miles and essentially none over 300 miles once the market matures.

The amount of ethanol that can be shipped directly by truck from production plants/import centers to petroleum terminals is a function of the relative location of production plants/import centers to petroleum terminals, the ethanol production/import capacity of production/import facilities, and the potential ethanol demand at each terminal. Ethanol demand at a given terminal is governed by ethanol cost considerations relative to gasoline, State ethanol use incentives, the penetration of E85 into the market, and the total gasoline motor vehicle demand served the terminal. As an input to the ORNL study, we provided our estimates of the location of ethanol production plants and imports centers as well as our estimate of how much ethanol would be used on a State-by-State basis.^{III} ORNL allocated ethanol usage to terminals located within a given State on a population weighted basis given the terminals service areas. Thus, we anticipate that the ORNL study will provide an enhanced estimate of the volume of ethanol that could be shipped to petroleum terminals by tank truck.

Where shipping distances are greater than 300 miles, we assumed that unit train would be the preferred means of transport where ethanol volumes are sufficiently large. We estimated that shipment by manifest rail car would continue to be an important means of bringing ethanol to a subset of petroleum terminals that could not support the receipt of unit trains or otherwise receive ethanol from hub terminals that are equipped for unit train receipt.^{IIII} We assumed that 10% of ethanol production/imports would be shipped to petroleum terminals by manifest rail car. We also assumed that shipment by barge would continue to be a significant means of moving ethanol from certain hub terminals in the Northeast that receive ethanol via unit train to other Northeast terminals. We anticipate that the analysis of the relative merits of the various modes for long distance transportation of ethanol inherent in the ORNL modeling work will provide additional basis for us to adjust our estimates of the relative extent to which the different modes would be utilized.

^{III} A discussion of our estimates of where ethanol would be used under the RFS2 standards is contained in Section 1.7 of this DRIA. A discussion of our estimates of where ethanol would be produced / imported in response to the RFS2 standards is contained in Section 1.5 of this DRIA.

^{IIII} Manifest rail car shipment refers to the practice of shipping several ethanol rail cars in a train that is composed of rail cars carrying various products.

The extent to which multiple shipping links are needed to bring ethanol to petroleum terminal depends on two principal factors. The first is whether the ethanol production facility is configured to support shipment by unit train. The Manly unit train gathering facility was constructed to serve a number of ethanol production plants that were either too small to support unit train service themselves or otherwise chose not to install a unit train shipping facility. Our analysis indicates that the vast majority of new ethanol production plants will have a production capacity of at least 70 million gallons per year (MGY).^{KKKK} The current industry rule of thumb is that ethanol production plants need to have a production capacity of approximately 80 million MGY to support the installation of a unit train loading facility. This appears to be based on the assumption of an ~2 week cycle time for unit train rail cars which we believe is widely accepted for ethanol shipments by unit train, and the use of a 100 car unit train.^{LLLL} A 70 MGY ethanol plant could only support the shipment of a 100 car unit train every 17 days, resulting in a 20% less efficient use of rail cars compared to a 2 week cycle. Rail car lease costs are estimated at \$750 per month per car and thus can constitute a significant fraction to total ethanol freight costs.

Ethanol unit trains range between a minimum of 70 to a maximum of 100 rail cars. By reducing the number of cars in a unit train to 90, a 70 MGY ethanol could support a two week rail car cycle time. Thus, we believe that a 70 MGY ethanol plant should be able to support the installation of a unit train shipping facility. It is also likely that the level of ethanol demand at some downstream ethanol unit train receipt facilities would be better suited to the receipt of smaller sized unit train than 100 rail cars. We anticipate that all ethanol production facilities of sufficient scale to support unit train service other than those currently served by the Manly facility will choose to install such service due to the associated market advantages. We assume that the new production plants that are too small to support installation of unit train service would primarily serve local markets by tank truck and ship the remainder of their production to terminal by manifest rail car. Based on the above discussion, we are assuming that no additional unit train rail gathering facilities would be needed. Hence, we are projecting that no additional manifest rail car shipments to form unit trains would be needed as a result of the RFS2 standards.

The second factor influencing the need for secondary shipments of ethanol is the extent to which ethanol will be shipped to hub terminals via unit train for further distribution to satellite terminals and the degree to which such hub terminals are located at petroleum terminals as opposed to being located at rail terminals. A significant challenge facing terminals and one that is currently limiting the volume of ethanol that can be used is the ability to receive ethanol by rail. Only a small fraction of petroleum terminals currently have rail receipt capability and a number likely have space constraints (particularly those in the Northeast) or are located too far from the rail net to allow installation of such capability.

There is significant uncertainty regarding the extent to which additional rail receipt facilities can be accommodated at petroleum terminals. This is true regarding the installation of manifest rail receipt capability as well as unit train receipt capability. Comprehensive data on the current rail receipt capability at petroleum terminals or on logistical considerations regarding the addition of such capability does not exist. For the purpose of our analysis, we are assuming

^{KKKK} A discussion of the projected locations of ethanol production facilities can be found in chapter 1.5 of this DRIA.

^{LLLL} Rail car cycle time for shipment of ethanol by manifest rail car is typically one month.

that 50% of new ethanol unit train facilities would be located at petroleum terminals and 50% would be located at rail terminals. The ORNL study estimated that all new ethanol rail receipt capability would be installed at existing rail terminals given the limited ability to install such capability at petroleum terminals. We intend to review our estimates regarding the location of the additional ethanol rail receipt facilities for the final rule in light of the ORNL study.

Ethanol not blended at hub petroleum terminals or shipped to rail terminals would need to be further shipped to smaller “satellite” petroleum terminals. We assume that 20% of the ethanol received by unit train at a petroleum terminal would be blended into gasoline at that terminal. The remaining 80% would be further shipped to satellite petroleum terminals. We are assuming that 90% of such secondary shipments would be done by tank truck and 10% by barge. We also assumed the ethanol shipped by unit train to rail terminals would be shipped to petroleum terminals by the same means. At one ethanol unit train hub facility at a rail terminal, there are plans to ship ethanol by a short pipeline to a nearby petroleum terminal. We anticipate that this practice will expand as the industry matures. However, due to a lack of information on the extent to which short pipelines could feasibly play such a role, and to provide a conservatively high estimate of ethanol distribution costs, we assumed that all secondary shipments from rail terminals would be by tank truck and barge. We anticipate that the results from the ORNL modeling work will provide the means for us to modify our estimates of the extent to which secondary shipments of ethanol will need to be made from unit train receipt facilities at petroleum terminals and the breakdown of the transportation modes that would be used for secondary shipments from all ethanol unit train receipt facilities (including those at rail terminals).

Our estimate of how ethanol would be shipped to petroleum terminals in 2022 is summarized in Table 1.6-1. A discussion of ethanol freight costs can be found in Section 4.2 of this DRIA.

Table 1.6-1. Estimated 2022 Ethanol Shipping Volumes by Link/Mode of Shipment

Shipping Link / Shipment Mode	Million Gallons of Ethanol Shipped Annually in 2022	
	Total Volume	Change from Reference Case ^b
From production facilities by manifest rail car and tank truck to unit train gathering facility	1,000	0
From production/import facility to petroleum terminal by tank truck	6,830 (20% production/import vol.) ^a	4,190
From production or unit train gathering facility to petroleum terminal by unit train	11,950 (35% production/import vol.) ^a	7,340
From production/import facility to petroleum terminal by manifest rail car	3,410 (10% production/import vol.) ^a	2,100
From production or unit train gathering facility to <u>rail</u> terminal by unit train	11,950 (35% production/import vol.) ^a	7,340
From petroleum terminals that receive ethanol by unit train by barge to satellite petroleum terminals	960	590
From petroleum terminals that receive ethanol by unit train by tank truck to satellite petroleum terminals	8,600	5,280
From rail terminals that receive ethanol by unit train or port facilities that receive imported ethanol by barge to satellite petroleum terminals	1,190	730
From rail terminals that receive ethanol by unit train by tank truck to satellite petroleum terminals	10,750	6,600

^a 34.14 BGY of ethanol would be produced/imported by 2022 to satisfy the RFS2 standards.

^b Total – the AEO 2007 based 2022 reference case absent the RFS2 standards. Our ethanol consumption projections under RFS2 standards are discussed in Section 1.7.1 of this DRIA.

1.6.3 Shipment of Biodiesel to Petroleum Terminals

We projected the volumes of biodiesel that would be used on a State-by-State basis to meet anticipated State biodeisel mandates/incentives and the estimated demand for biodiesel as a blending component in heating oil.^{MMMM} Using the estimated locations of biodiesel production

^{MMMM} A discussion of our estimates regarding the location of biodiesel production facilities and centers of biodiesel demand is contained in Section 1.5.4 of this DRIA.

facilities and their volumes, we evaluated the most efficient means of meeting this projected demand while minimizing shipping distances (and cost). The remaining biodiesel production volume that was not taken up meeting this demand was assumed to be used in the same State it was produced to the extent that the State’s diesel fuel did not already contain 5% biodiesel. We believe that this should provide a somewhat conservatively high estimate of biodiesel distribution costs since biodiesel might be used in excess of 5% even absent a State mandate. If the State was already saturated with 5% biodiesel, the remaining volume was assumed to be shipped out of State within a 1,000 mile shipping distance. A 1,000 mile shipping distance was selected to ensure that all biodiesel not used to satisfy a State mandate or for bio-heat could find a market. It is likely that some fraction would not need to travel quite as far. Therefore, this assumption is also likely to result in a conservatively high estimate of biodiesel freight costs. It was assumed that biodiesel production volumes will continue to be insufficiently concentrated to justify shipment by unit train. Where distances are beyond 300 miles, shipment by manifest rail was assumed to be the preferred option other than in cases on the East coast where there were apparent barge routes from production to demand centers. In no case was it assumed that biodiesel would need to be shipped by multiple modes prior to delivery at the petroleum terminal where it is blended with petroleum-based distillate fuel.

Table 1.6-2 contains our estimate of how biodiesel would be shipped to petroleum terminals in 2022. Additional discussion on our estimate of how biodiesel used to comply with the RFS2 standards would be transported to petroleum terminals can be found in Section 4.2 of this DRIA on biodiesel freight costs.

**Table 1.6-2.
Estimated 2022 Biodiesel Shipping Volumes by Link/Mode of Shipment**

Shipping Link / Shipment Mode	Million Gallons of Biodiesel Shipped Annually in 2022	
	Total Volume	Change from Reference Case ^b
From production facility to petroleum terminal by tank truck	696 (86% of total production volume) ^a	369
From production facility to petroleum terminal by manifest rail car	109 (13% of total production volume) ^a	5
From production facility to petroleum terminal by barge	5 (1% of total production volume) ^a	3

^a 810 MGY of biodiesel would be produced in 2022 to satisfy the RFS2

^b Total – the AEO 2007 based 2022 reference case absent the RFS2 standards. Our ethanol consumption projections under RFS2 standards are discussed in Section 1.7.2 of this DRIA.

1.6.4 Shipment of Renewable Diesel to Petroleum Terminals

We project that the distribution of the 2/3 of renewable diesel fuel (251 MGY in 2022, or potentially earlier) produced to petroleum terminals would be transparent with respect the impact

on the distribution system.^{NNNN} We assume that the remaining 125 MGY would be shipped to nearby terminals or petroleum refineries (within a 200 mile radius) by tank truck to be blended with petroleum-based diesel fuel.

1.6.5 Changes in Freight Tonnage Movements Due to RFS2

In order to evaluate the magnitude of the challenge to the distribution system up to the point of receipt at the terminal, we compared the growth in freight tonnage for all commodities from the AEO 2007 reference case to the growth in freight tonnage under the RFS2 standards in which ethanol increases, as does the feedstock (corn) and co-products (distillers grains). We did not include a consideration of the transportation of cellulosic feedstocks in this analysis. The distribution of cellulosic feedstocks is discussed in Section 1.3.3 of this DRIA. For purposes of this analysis, we focused on only the ethanol portion of the renewable fuel goals for ease of calculation and because ethanol represents the vast majority of the total fuel. The resulting calculations serve as an indicator of changes in freight tonnages associated with increases in renewable fuels. We calculated the freight tonnage for the total of all modes of transport as well as the individual cases of rail, truck, and barge.

In calculating the AEO 2007 reference case percent growth rate in total freight tonnage, we used data compiled by the Federal Highway Administration to calculate the tonnages associated with these commodities. We then calculated the growth in freight tonnage for 2022 under the RFS2 standards and compared the difference with the AEO 2007 reference case. The comparisons indicate that across all transport modes, the incremental increase in freight tonnage of ethanol and accompanying feedstocks and co-products associated with the increased ethanol volume under the RFS2 standards are small. The percent increase for total freight across all modes (rail, barge, truck, and pipeline) by 2022 is 0.9 percent. Because pipelines currently do not carry ethanol, and the increase in volume of ethanol displaces a corresponding volume of gasoline, pipelines showed a decrease in tonnage carried. The displaced gasoline also resulted in some decrease in tonnage in other modes that slightly reduced the overall increases in tonnage reflected in the totals.

To further evaluate the magnitude of the increase in freight tonnage under the RFS2 standards, we calculated the portion of the total freight tonnage from the rail, barge, and truck modes made up of ethanol-related freight for both the AEO 2007 based 2022 reference case and control cases. The freight associated with ethanol constitutes only a very small portion of the total freight tonnage for all commodities. Specifically, ethanol freight represents approximately 0.5 and 2.5% of total freight for the AEO 2007 based 2022 reference case and RFS2 standards case, respectively. For the rail mode only, the freight associated with ethanol represents approximately 3.2% of the total for the RFS2 case. The results of this analysis, suggest that it should be feasible for the distribution infrastructure upstream of the terminal to accommodate the additional freight associated with this RFS2 standards especially given the lead time available. Specific issues related to transportation by rail, barge, and tank truck are discussed in the

^{NNNN} A discussion of the projected location of renewable diesel fuel production facilities is contained in Section 1.5.4 of this DRIA. Renewable diesel fuel produced at petroleum refineries would either be co-processed with crude oil or processed in separate units located at the refinery for blending with other diesel blendstocks at the refinery.

following sections. Our estimate of the percent changes in total freight tonnage by mode for 2022 required to satisfy the RFS2 standards is contained in Table 1.6-3.

**Table 1.6-3.
Estimate of Percent Changes in Total Freight Tonnage by Mode for 2022**

	Reference Case	RFS2 case	% change^a
Total freight tonnage for all commodities (thousands of tons)	25,161,284	25,673,207	1.99%
Portion of total freight tonnage made up of ethanol-related freight (thousands of tons)	135,018	643,418	
Percent ethanol related freight to total freight	0.54%	2.51%	
Total freight tonnages for specific transport modes (thousands of tons)			
	Reference Case	RFS2 case	% change^a
Truck	16,521,816	16,884,804	2.15%
Rail	2,552,227	2,636,173	3.18%
Water	714,483	734,292	2.70%
Pipeline	5,372,758	5,417,937	0.83%

^aTotal – the AEO 2007 based 2022 reference case absent the RFS2 standards. Our ethanol consumption projections under RFS2 standards are discussed in Section 1.7.1 of this DRIA.

We intend to incorporate the results of the recently completed study by Oak Ridge National Laboratories (ORNL) on the potential constraints in ethanol distribution into the analysis for the final rule. The ORNL study concluded that the increase in ethanol transport would have minimal impacts on the overall transportation system. However, the ORNL study did identify localized areas where significant upgrades to the rail distribution system would likely be needed.

1.6.6 Rail Transportation System Accommodations

Many improvements to the freight rail system will be required in the next 15 years to keep pace with the large increase in the overall freight demand. Much of the projected increase in rail freight demand is associated with the expected rapid growth of inter-modal rail transport. Most of the needed upgrades to the freight rail system are not specific to the transport of renewable fuels and would be needed irrespective of today’s proposed rule. The modifications required to satisfy the increase in demand include upgrading tracks to allow the use of heavier trains at faster speeds, the modernization of train braking systems to allow for increased traffic on rail lines, the installation of rail sidings to facilitate train staging and passage through bottlenecks.

Some industry groups⁰⁰⁰⁰ and governmental agencies in discussions with EPA, and in testimony provided for the Surface Transportation Board (STB) expressed concerns about the ability of the rail system to keep pace with large increase in demand even under the AEO 2007 reference case (27% by 2022). For example, the electric power industry has had difficulty keeping sufficient stores of coal in inventory at power plants due to rail transport difficulties and has expressed concerns that this situation will be exacerbated if rail congestion worsens. One of the more sensitive bottleneck areas with respect to the movement of ethanol from the Midwest to the East coast is Chicago. The City of Chicago commissioned its own analysis of rail capacity and congestion, which found that the lack of rail capacity is “no longer limited to a few choke points, hubs, and heavily utilized corridors.” Instead, the report finds, the lack of rail capacity is “nationwide, affecting almost all the nation’s critically important trade gateways, rail hubs, and intercity freight corridors.” This is due, in part, to the lack of critical linkages between the 27 major rail yards located in the Chicago-land area.

To help improve east-west rail connections through the city, federal, state, and local officials announced an agreement in 2006 to invest \$330 million over three-years in city-wide rail infrastructure designed to improve the flow of rail traffic through the area. The State of Illinois, the City of Chicago, and seven Class I rail carriers, as well as Amtrak and Metra, the area's transit system, also committed \$1.5 billion in improvements. Chicago is the largest rail hub in the country with more than 1,200 trains passing through it daily carrying 75% of the nation's freight valued at \$350 billion; 37,500 rail freight cars pass through the city every day projected to increase to 67,000 by 2020. Chicago is the only city where all six Class I railroads converge and exchange freight. The plan calls for the creation of five rail corridors to aid in alleviating the bottleneck.

Significant private and public resources are focused on making the modifications to the rail system to cope with the increase in demand. Rail carriers report that they typically invest 16 to 18 billion dollars a year in infrastructure improvements.⁴⁴⁴ Substantial government loans are also available to small rail companies to help make needed improvements by way of the Railroad Rehabilitation and Improvement Finance (RRIF) Program^{PPPP}, administered by Federal Railroad Administration (FRA), as well as Section 45G Railroad Track Maintenance Credits, offered by the Internal Revenue Service (IRS).

The RRIF program offers loans to railroads for a variety of capital purposes including track and equipment rehabilitation at “cost of money” for 25 year terms. Typically, short line railroads cannot secure this kind of funding in the private markets. Under this program, FRA is

⁰⁰⁰⁰ Industry groups include the Alliance of Automobile Manufacturers, American Chemistry Council, and the National Industrial Transportation League; governmental agencies include the Federal Railroad Administration (FRA), the General Accountability Office (GAO), and the American Association of State Highway Transportation and Officials (AASHTO). Testimony for the STB public hearings includes Ex Parte No. 671, *Rail Capacity and Infrastructure Requirements* and Ex Parte No. 672, *Rail Transportation and Resources Critical to the Nation’s Energy Supply*.

^{PPPP} The RRIF program was established by the Transportation Equity Act for the 21st Century (TEA-21) and amended by the Safe Accountable, Flexible and Efficient Transportation Equity Act: a Legacy for Users (SAFETEA-LU). RRIF funding may be used to: acquire, improve, or rehabilitate intermodal or rail equipment or facilities, including track, components of track, bridges, yards, buildings and shops; refinance outstanding debt incurred for the purposes listed above; and develop or establish new intermodal or railroad facilities.

authorized to provide direct loans and loan guarantees up to \$35.0 billion. Up to \$7.0 billion is reserved for projects benefiting freight railroads other than Class I carriers. However, the program has lent less than \$650 million to non-passenger rail carriers since 2002, according to the FRA/RRIF website.

The American Association of State Highway Transportation Officials (AASHTO) estimates that between \$175 billion and \$195 billion must be invested over a 20-year period to upgrade the rail system to handle the anticipated growth in freight demand, according to the report's base-case scenario.⁴⁴⁵ The report suggests that railroads should be able to provide up to \$142 billion from revenue and borrowing, but that the remainder would have to come from other sources including, but not limited to, loans, tax credits, sale of assets, and other forms of public-sector participation. Given the reported historical investment in rail infrastructure, it may be reasonable to assume that rail carriers would be able to manage the \$7.1 billion in annual investment from rail carriers that AASHTO projects would be needed to keep pace with the projected increase in freight demand.

The Association of American Railroads (AAR) estimates⁴⁴⁶ that meeting the increase in demand for rail freight transportation will require an investment in infrastructure of \$148 billion (in 2007 dollars) over the next 28 years and that Class I railroads' share is projected to be \$135 billion, with \$13 billion projected for short line and regional freight railroads.

In testimony before the STB, Class I railroads committed to working with all parties in the ethanol logistical chains to provide safe, cost-effective, and reliable ethanol transportation services as well as to resolve past freight rail capacity difficulties. Presumably, this commitment extends to the projected three-percent increase in overall freight tonnage envisioned herein.

However, the Government Accounting Office (GAO) found that it is not possible to independently confirm statements made by Class I rail carriers regarding future investment plans.^{QQQQ} In addition, questions persist regarding allocation of these investments, with the Alliance of Automobile Manufacturers, American Chemistry Council, National Industrial Transportation League, and others expressing concern that their infrastructural needs may be neglected by the Class I railroads in favor of more lucrative intermodal traffic. Moreover, the GAO has raised questions regarding the competitive nature and extent of Class I freight rail transport. This raises some concern that providing sufficient resources to facilitate the transport of increasing volumes of ethanol and biodiesel might not be a first priority for rail carriers. In response to GAO concerns, the Surface Transportation Board (STB) agreed to undertake a rigorous analysis of competition in the freight railroad industry.^{RRRR}

^{QQQQ} The railroads interviewed by GAO were generally unwilling to discuss their future investment plans with the GAO. Therefore, GAO was unable to comment on how Class I freight rail companies are likely to choose among their competing investment priorities for the future, including those of the rail infrastructure, GAO testimony Before the Subcommittee on Surface Transportation and Merchant Marine, Senate Committee on Commerce, Science, and Transportation, U.S. Senate, *Freight Railroads Preliminary Observations on Rates, Competition, and Capacity Issues*, Statement of Jayetta Z. Hecker, Director, Physical Infrastructure Issues, GAO, GAO-06-898T Washington, D.C.: June, 21, 2006).

^{RRRR} GAO, *Freight Railroads: Industry Health Has Improved, but Concerns about Competition and Capacity Should Be Addressed*, GAO-07-94 (Washington, D.C.: Oct. 6, 2006); GAO, *Freight Railroads: Updated Information on Rates and Other Industry Trends*, GAO-07-291R Freight Railroads (Washington, D.C.: Aug. 15,

Given the broad importance to the U.S. economy of meeting the anticipated increase in freight rail demand, and the substantial resources that seem likely to be focused on this cause, we believe that overall freight rail capacity would not be a limiting factor to the successful implementation of the biofuel requirements under the RFS2 standards. Evidence from the recent ramp up of ethanol use has also shown that rail carriers are enthusiastically pursuing the shipment of ethanol, although there is some indication that the Class I freight rail industry will expect ethanol to primarily be shipped by unit train from facilities that assemble unit trains which are developed and paid for by the ethanol industry.

Class 2 railroads have been particularly active in gathering sufficient numbers of ethanol cars to allow Class 1 railroads to ship ethanol by unit train. Based on this recent experience, we believe that ethanol will be able to compete successfully with other commodities in securing its share of freight rail service.

While many changes to the overall freight rail system are expected to occur irrespective of today's proposed rule, a number of ethanol-specific modifications will be needed. For instance, a number of additional rail terminals are likely to be configured for receipt of unit trains of ethanol for further distribution by tank truck or other means to petroleum terminals. Each ethanol rail car holds approximately 29,500 gallons.^{SSSS} Thus, each 100 car unit train would deliver 2,950,000 gallons of ethanol. We believe that it would be reasonable for an ethanol unit train facility to accept a unit train approximately every 3 days. Thus, we assumed that each unit train facility could handle 120 unit trains per year which translates to 354 million gallons per year for each unit train facility. Based on the volumes we projected to be transported by unit train in Table 1.6-1 of this DRIA, this translates to a total of 68 unit train receipt facilities for all ethanol used by 2022 and 42 such facilities to handle the volume attributed to the RFS2 standards alone (relative to the AEO 2007 based 2022 reference case). As discussed in Section 1.6.2 of this DRIA, we are assuming that half of the unit train receipt facilities needed to cope with the additional volumes of ethanol projected to be used to comply with the RFS2 standards would be constructed at petroleum terminals (i.e. 21) and half would be constructed at rail terminals.

As discussed in Section 1.6.2 of this DRIA, the recently completed ORNL study estimated that all new ethanol rail receipt capability would be installed at existing rail terminals given the limited ability to install such capability at petroleum terminals. We intend to review our estimates regarding the location of the additional ethanol rail receipt facilities for the final rule in light of the ORNL study.

The placement of ethanol receipt facilities at rail terminals would be particularly useful in situations where petroleum terminals would find it difficult or impossible to install their own ethanol rail receipt capability. If the projected number of ethanol rail receipt facilities can not be accommodated at petroleum terminals then additional ethanol unit train receipt facilities would

2007). STB's final report, entitled *Report to the U.S. STB on Competition and Related Issues in the U.S. Freight Railroad Industry*, is expected to be completed November, 1, 2008.

^{SSSS} Ethanol cars have a nominal capacity of 30,000 gallons.

be needed at rail terminals.^{TTTT} We do not have information on the extent to which there is available space at rail terminals to accommodate ethanol receipt facilities. However, the majority of the required space would be needed to locate the train itself, the facilities for which would already be in place at rail terminals. We expect the other space requirements for truck loading and storage tanks would be relatively modest and could be accommodated at a sufficient number of rail terminals to meet the projected need. The need for long-term demand to be established prior the construction of such facilities would likely mean that the needed facilities would at best come on line in a just-in-time basis. We anticipate that ethanol storage will typically be installed at rail terminal ethanol receipt hubs over the long run. However, the ability to rely on transloading while ethanol storage facilities at rail terminal ethanol receipt hub facilities are constructed would help to ease the introduction of downstream rail receipt capability.

We anticipate that rail terminals would only install the minimum amount of ethanol storage capacity in order to maintain steady deliveries by unit train. This is based on the assumption that petroleum terminals would be the ones to maintain an inventory buffer to ensure a steady supply of ethanol to blend with gasoline.^{UUUU} Under this model, rail terminals would empty their ethanol storage by shipment to petroleum terminals as soon as possible. Therefore, we believe that it not appropriate to apply the formula we used to estimate the ethanol storage tank requirements at petroleum terminals which is based on the premise of always having ethanol on hand even the face of temporary upsets in delivery. Each delivery of an ethanol unit train contains 2.95 million gallons. To ensure that a rail terminal is always ready to unload an ethanol unit train, we believe that it would be sufficient to size the ethanol storage capacity at 6 times unit train capacity (17.7 million gallons). This should allow for a reasonable amount of irregularity in both the receipt of ethanol by unit train into rail terminals and the delivery of ethanol from rail terminal storage to petroleum terminals. For all of the projected 21 rail terminal ethanol unit train receipt facilities, this totals 371.7 million gallons or 8.85 million barrels of ethanol storage. All of the ethanol storage at rail terminals would need to be new construction, since we do not believe there would be existing tankage at rail terminals that could be converted to ethanol service.

A substantial number of additional rail cars would be needed to transport the volumes of ethanol and to a lesser extent biodiesel that are projected to be used in response to the RFS2 standards. Our estimate of the number of rail cars needed is based on the an assumed cycle time of 2 weeks for shipment by unit train and one month for shipment by manifest rail car which we believe is conservatively high given current industry experience.^{VVVV} Biodiesel rail cars are typically somewhat smaller than those used for ethanol. We assumed a deliverable volume of 25,600 gallons for biodiesel rail cars and 29,000 for ethanol rail cars. We estimated the number of rail cars that would be needed to transport ethanol and biodiesel using the projected volumes of ethanol and biodiesel that we expect would be shipped by unit train and manifest rail (see

^{TTTT} As discussed in Section 1.6.6 of this DRIA, we estimate that 148 additional manifest rail receipt facilities would be constructed at petroleum terminals to handle the volumes of ethanol that we project would be shipped by manifest rail.

^{UUUU} A discussion of the projected demand for ethanol storage is contained in Section 1.6.6 of this DRIA.

^{VVVV} Rail car cycle time refers to the time needed to complete one delivery and return to the origin including the time to prepare for the next shipment.

Tables 1.6-1 and 1.6-2) and the assumed rail car volumes and cycle times. As discussed in Section 1.6.1.3, we project that renewable diesel fuel would not need to be transported by rail. Our estimate of the number of rail cars to transport the volume of renewable fuels projected to be used by 2022 to satisfy the RFS2 standards is contained in Table 1.6-4.

**Table 1.6-4.
Estimated Number of Rail Cars Needed by 2022 for Shipment of Ethanol and Biodiesel**

	Number of Rail Cars Needed to Transport Ethanol	
	Total Volume	Volume Attributed to RFS2 Standards ^a
Ethanol Rail Cars	43,398	26,644
Biodiesel Rail Cars	665	353
Ethanol & Biodiesel Rail Cars	44,063	26,997

^a Total – the AEO 2007 based 2022 reference case absent the RFS2 standards

Our analysis of ethanol and biodiesel rail car production capacity indicates that access to these cars should not represent a serious impediment to meeting the requirements under the RFS2 standards. Ethanol tank car production has increased approximately 30% per year since 2003, with over 21,000 tank cars expected to be produced in 2007. To accommodate the increased demand for ethanol tank cars, rail car producers converted existing boxcar production facilities to tank production facilities and brought on additional work shifts to adjust to rapidly changing to market conditions.

1.6.7 Marine Transportation System Accommodations

The American Waterway’s Association has expressed concerns about the need to upgrade the inland waterway system in order to keep pace with the anticipated increase in overall freight demand. The majority of these concerns have been focused on the need to upgrade the river lock system on the Mississippi river to accommodate longer barge tows and on dredging inland waterways to allow for movement of fully loaded vessels. We do not anticipate that a substantial fraction of renewable/alternative fuels will be transported via these arteries. Thus, we do not believe that the ability to ship ethanol/biodiesel by inland marine will represent a serious barrier to the implementation of implementation of the requirements under RFS2 standards. Substantial quantities of the corn ethanol co-product dried distiller grains (DDG) is expected to be exported from the Midwest via the Mississippi river as the US demand for DDG becomes saturated. We anticipate that the volume of exported DDG would take the place of corn that would be shifted from export to domestic use in the production of ethanol. Thus, we do not expect the increase in DDG exports to result in a substantial increase in river freight traffic.

A number of new barges would be needed to transport the volumes of ethanol and to a lesser extent biodiesel that are projected to be used in response to the RFS2 standards. We assumed the use of tank barges with a carrying capacity of 10,000 barrels (42,000 gallons). We understand that the tank barge industry is trending towards the use of tank barges with a carrying capacity of 30,000 barrels. Thus, our assumed use of 10,000 barrel barges may overstate the number of barges that would be needed. We assumed a 2 week barge cycle time, which we

understand to be typical given the markets where we expect most barge shipments would occur.^{wwww}

We estimated the number of barges that would be needed to transport ethanol and biodiesel using the projected volumes of ethanol and biodiesel that we expect would be shipped by barge (see Tables 1.6-1 and 1.6-2), and the assumed barge volume and cycle time. As discussed in Section 1.6.1.3, we project that renewable diesel fuel would not need to be transported by barge. Our estimate of the number of barges to transport the volume of renewable fuels projected to be used by 2022 to satisfy the RFS2 standards is contained in Table 1.6-5.

**Table 1.6-5.
Estimated Number of Barges Needed by 2022 for Shipment of Ethanol and Biodiesel**

	Number of Barges Needed to Transport Ethanol and Biodiesel	
	Total Volume	Volume Attributed to RFS2 Standards ^a
Ethanol Barges	213	131
Biodiesel Barges	20	11
Ethanol & Biodiesel Barges	233	142

^a Total – the AEO 2007 based 2022 reference case absent the RFS2 standards

The U.S. tank barge fleet currently numbers 3,600.⁴⁴⁷ In 2004, over 500 barges of all types were added to the U.S. barge fleet. Given the gradual ramp up in demand for shipment of biofuels by barge over time, we believe that the addition to the fleet of the 142 barges estimated to be needed to transport biofuels can be accommodated by the industry.

As discussed in Section 1.5.2.2 of this DRIA, we project that imports of ethanol will ramp up significantly to 3.14 BGY by 2022.^{xxxx} To estimate which ports would receive ethanol imports we gave priority to ports that have a history of receiving ethanol imports from Brazil and Caribbean Basin Initiative Countries^{yyyy} according to company-level historical fuel import data from the Energy Information Administration (EIA).⁴⁴⁸ Additional ports were selected from those that have a history of receiving finished gasoline imports. Ports were selected in States that could not satisfy their internal ethanol demand from in-State production and from those ports that were closest to large demand centers. We estimate that a total of 28 ports would receive imported ethanol by 2022 (see Figure 1.6-1).^{zzzz} We estimate that the 12 ports which did not

^{wwww} We believe most barge shipments of biofuels would originate and terminate in the Northeast. Cycle time refers to the time needed to complete one delivery and return to the origin including the time to prepare for the next shipment.

^{xxxx} See chapter 1.5.2 of this DRIA for a discussion of our projection of ethanol imports.

^{yyyy} Caribbean Basin Initiative countries receive special exemptions from U.S. ethanol import tariffs (See Section 1.5 of this DRIA regarding the source of ethanol imports and for additional discussion regarding how we estimated where ethanol imports would enter the U.S..

^{zzzz} Paulsboro/Gloucester NJ were treated as separate ports for purposes of our capital cost analysis but were treated as a single port for the purposes of our ethanol freight costs analysis due to their close proximity. The same is true for Belfast and Searsport ME.

receive ethanol in the past would need to install/modify ethanol receipt facilities including piping, pumps, vapor handling systems, and ethanol storage tanks while ports that had received ethanol in the past would primarily need to install additional ethanol storage tanks. We believe that all of these ports also serve as petroleum terminals. Hence, the need for additional ethanol storage as well as outgoing ethanol shipping facilities would be covered within the context of our estimation of the upgrades needed to petroleum terminal facilities.

Figure 1.6-1. Projected Ethanol Import Locations and Volumes (MGY) in 2022

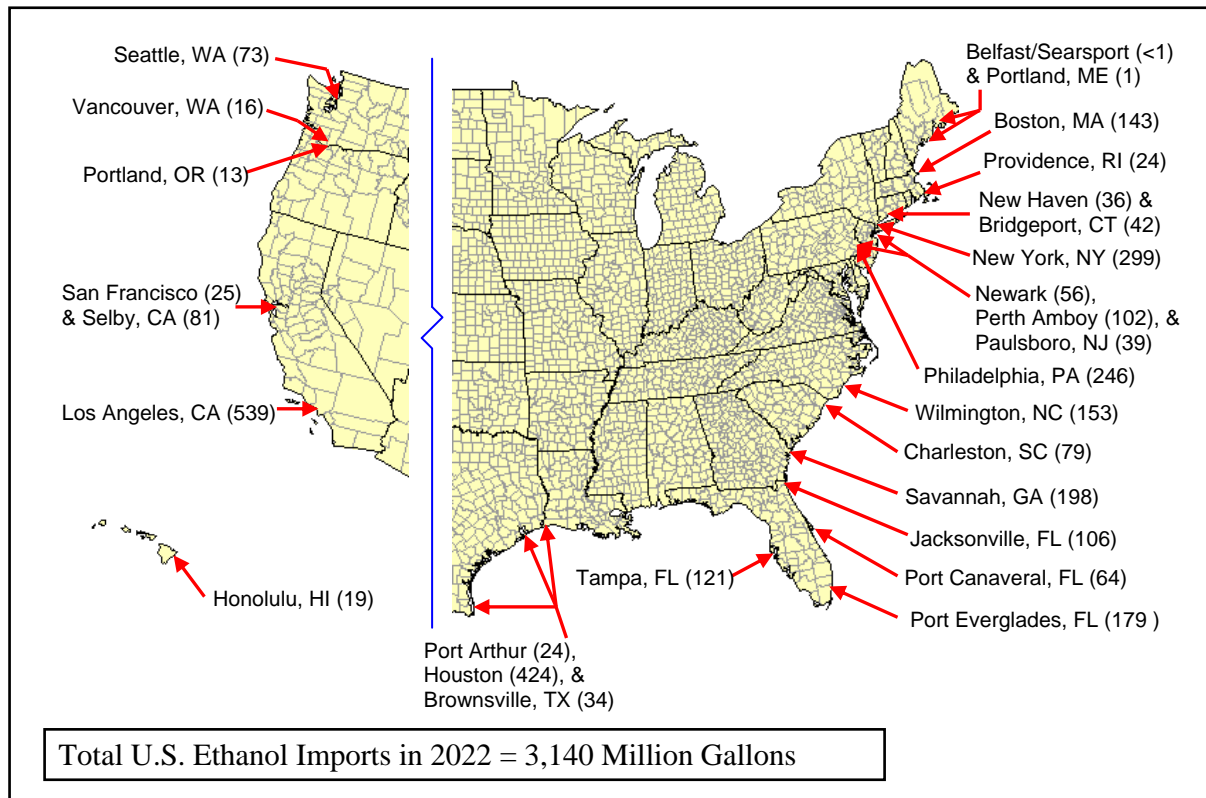

Note: We are considering adding Hampton Roads VA, and Baltimore MD to the list of future ethanol import locations and may adjust our analysis for the final rule accordingly. This figure is the same as figure 1.5-13 and is repeated here for reference purposes.

1.6.8 Accommodations to the to the Road Transportation System

We estimated the number of tank trucks that would be needed to transport ethanol, biodiesel, and renewable diesel fuel using the projected volumes of ethanol and biodiesel that we expect would be shipped by tank truck (see Table 1.6-1, Table 1.6-2, and Section 1.6.4 of this DRIA), and the assumed tank truck volume and cycle times. In all cases, we assumed a tank truck capacity of 8,000 gallons. Larger tank trucks are permitted in some areas, so this assumption will tend to overestimate of the number of tank trucks needed. We assumed 312 truck shipping days per year and two 8 hour shifts. For shipments of ethanol from production/import facilities to petroleum terminals we assumed 3.75 shipments per day (4 hours for round trip). For secondary ethanol shipments from hub to satellite terminals, we assumed 6

shipments per day (2.5 hours per round trip). For shipments of biodiesel and renewable diesel fuel from production facilities to terminals, we assumed 6 shipments per day. We believe that the shorter shipping distance for tank truck transport from biodiesel production facilities is justified based on the greater dispersion of such facilities relative to ethanol facilities and the fact that some would be located at petroleum terminals.

Tables 1.6-6 and 1.6-7 contain our estimates of the number of new tractor trailer tank trucks and truck drivers that would be needed by 2022 to transport the additional volumes of ethanol, biodiesel, and renewable diesel fuel that are projected to be used in response to the proposed RFS2 standards. Our estimate of the number of truck drivers that would be needed is based on the assumption that each tank truck would be operated for two shifts with one driver for each shift.

**Table 1.6-6.
Estimated Number of Tank Trucks Needed by 2022
to Transport Ethanol, Biodiesel, and Renewable Diesel Fuel**

	Number of Tank Trucks Needed for the Transport of Ethanol, Biodiesel, and Renewable Diesel Fuel	
	Total Volume	Volume Attributed to RFS2 Standards ^a
Ethanol	2,022	1,241
Biodiesel	74	39
Renewable Diesel	8	8
All Biofuels	2,106	1,288

^a Total – the AEO 2007 based 2022 reference case absent the RFS2 standards

**Table 1.6-7.
Estimated Number of Tank Truck Drivers needed by 2022
to Transport Ethanol, Biodiesel, and Renewable Diesel Fuel**

	Number of Tank Truck Drivers Needed to Transport Ethanol, Biodiesel, and Renewable Diesel Fuel	
	Total Volume	Volume Attributed to RFS2 Standards ^a
Ethanol	4,044	2,483
Biodiesel	148	78
Renewable Diesel	16	16
All Biofuels	4,208	2,577

^a Total – the AEO 2007 based 2022 reference case absent the RFS2 standards

According to a 2005 study commissioned by the American Trucking Association (ATA), the motor carrier industry will face a shortage of qualified professional long-haul truck drivers by 2014.⁴⁴⁹ In the study, ATA found that the long-haul, heavy-duty truck transportation industry in the United States is currently experiencing a national shortage of 20,000 truck drivers and, if the

current trend continues, that shortage of long-haul truck drivers could increase to 111,000 by 2014. ATA projected the need for additional 54,000 drivers each year. The trucking industry is active in a number of efforts to attract and retrain a sufficient number of new truck drivers including ATA's National Truck Driver Recruiting Campaign and Driver Tuition Finance Program.

As discussed above, we estimate that the growth in the transportation of biofuels by truck through 2022 due to the RFS2 standards would result in the need for a total of approximately 2,600 additional trucks drivers. Given the relatively small number of new truck drivers needed to transport the volumes of biofuels projected to be used to comply with the RFS2 standards through 2022 compared to the total expected increase in demand for drivers over the same time period (>750,000), we do not expect that the implementation of the RFS2 standards would substantially exacerbate the potential for an overall shortage of truck drivers. However, specially-certified drivers are required to transport biofuels because these fuels are classified as hazardous liquids. Thus, there may be a heightened level of concern about the ability to secure a sufficient number of such specially-certified drivers to transport biofuels. The trucking industry is involved in efforts to streamline the certification of drivers for hazardous liquids transport. We do not anticipate that the need for special hazardous liquids certification for biofuels truck drivers would substantially interfere with the ability to transport the projected volumes of biofuels by tank truck. We project that tank truck deliveries of biofuels would typically be accomplished within an 8 hour shift allowing the driver to return home each evening.^{AAAAA} The ATA sponsored study indicated that there was particular difficulty in attracting and retaining drivers for long haul routes that keep the driver away from home overnight. Thus, driving a tank truck (with typical 8 hour shift) may be relatively more attractive compared to a long haul truck driving position.

Truck transport of biofuel feedstocks to production plants and finished biofuels and co-products from these plants naturally is concentrated on routes to and from these production plants. This may raise concerns about the potential impact on road congestion and road maintenance in areas in the proximity of these facilities. We do not expect that such potential concerns would represent a barrier to the implementation of the RFS2 standards. The potential impact on local road infrastructure and the ability of the road net to be upgraded to handle the increased traffic load is an inherent part in the placement of new biofuel production facilities. Consequently, we expect that any issues or concerns would be dealt with at the local level. The transport of biofuel feedstocks is discussed in Section 1.3.3 of this DRIA.

1.6.9 Petroleum Terminal Accommodations

Terminals will need to install additional storage capacity to accommodate the volume of ethanol/biodiesel that we anticipate will be used in response to the RFS2 standards. By 2022, an additional 20.96 BGY of ethanol would be used as a result of the RFS2 standards.^{BBBBB} We

^{AAAAA} A small fraction of biofuels deliveries may require a sleep-over on the road of the driver due to limitations on the amount of time a driver can spend behind the wheel in a day.

^{BBBBB} A total of 34.14 BGY of ethanol would be used by 2022 under the RFS2 standards. 13.18 BGY is projected to have been used in the absence of the RFS2 standards under the AEO 2007 based 2022 reference case. See

estimate that it would be necessary to maintain an inventory level of 15% of annual ethanol consumption at the terminal level in order to provide a sufficient downstream buffer to ensure consistent supply. We chose a working inventory level of 15% rather than the 10% that is typical for petroleum-based fuels to compensate for the potential increase in temporary disruptions in ethanol delivery compared to petroleum-based fuels. We believe that this is appropriate due to the reliance on rail, barge, and truck for the transport of biofuels as opposed to use of pipelines for the shipment of petroleum-based fuels. Accommodating a 15% working inventory equates to 3.14 BG or 74.9 million barrels of additional ethanol storage at terminals due to the RFS2 standard. We further estimate that an additional 30% of ethanol storage (22.4 million barrels) would be needed as working space to accommodate ethanol deliveries.^{CCCCC} Thus we project that a total of 97.3 million barrels of additional ethanol storage would be needed at petroleum terminals due to the RFS2 standards.^{DDDDD}

Overall demand for the gasoline motor vehicle fuel is expected to remain relatively constant through 2022.^{EEEE} Thus, much of the demand for new ethanol storage could be accommodated by modifying storage tanks that had previously been used for the gasoline that would be displaced by ethanol. Due to the lower energy density of ethanol relative to gasoline (67%), we project that only 67% of the demand for new ethanol storage (65.2 million barrels) could be accommodated by modifying existing gasoline tanks for ethanol service. Therefore, we project that 32.1 million barrels of new ethanol storage tanks would be need to be constructed at petroleum terminals.

By 2022, an additional 430 MGY of biodiesel would be used as a result of the RFS2 standards.^{FFFF} We used the same terminal tankage sizing factors used above for ethanol to estimate the volume of new biodiesel storage volume that would be needed at petroleum terminals. This results in an estimated need for an additional 77.4 million gallons or 1.84 million barrels of new biodiesel storage space at petroleum terminals as a result of the RFS2 standards. Our projections of the growth in diesel fuel demand indicate that there would not be the opportunity to switch tanks currently in petroleum-based diesel fuel service to biodiesel service. Thus, all of the demand for new biodiesel storage would need to be satisfied through the construction of new tanks. Biodiesel storage tanks would need to be insulated/heated in colder climes.

Concerns have been raised by terminal operators in the Eastern U.S. about the ability of some terminals to install the needed storage capacity due to space constraints and difficulties in securing permits.⁴⁵⁰ We acknowledge that it may not be possible for some terminals that have

Section 1.5 of this DRIA for a discussion of projected ethanol volumes that would be used under the RFS2 standards and under the reference cases.

^{CCCC} Petroleum terminals typically allow an additional 30 percent of storage capacity (in relation to the amount provided for working inventory) to accommodate the receipt of petroleum products.

^{DDDD} We also project that 8.8 million barrels of new ethanol storage would be needed at rail terminals that act as ethanol unit train receipt facilities as discussed in Section 1.6.4 of this DRIA.

^{EEEE} Our projections of the motor fuel demand can be found in chapter 1.2 of this DRIA.

^{FFFF} A total of 810MGY of biodiesel would be used by 2022 under the RFS2 standards. 380 MGY is projected to have been used in the absence of the RFS2 standards under the AEO 2007 based 2022 reference case. See Section 1.5 of this DRIA for a discussion of projected biodiesel volumes that would be used under the RFS2 standards and under the reference cases.

become surrounded by urban growth over time to install additional storage tanks within the boundaries of their existing facilities. However, we believe that there are ways to manage this situation. The areas served by existing terminals often overlap. In such cases, one terminal might be space constrained while another serving the same area may be able to install the additional capacity to meet the increase in demand. Terminals with limited ethanol storage (or no access to rail/barge ethanol shipments) could receive truck shipments of ethanol from terminals with more substantial ethanol storage (and rail/barge receipt) capacity. The trend towards locating ethanol receipt and storage capability at rail terminals located near petroleum terminals is likely to be an important factor in reducing the need for large volume ethanol receipt and storage facilities at some petroleum terminals. In cases where it is impossible for existing terminals to sufficiently expand their storage capacity due to a lack of adjacent available land or difficulties in securing the necessary permits or to make arrangements to sufficiently reduce the need for such additional storage, new satellite storage or new separate terminal facilities may be needed for additional ethanol storage. However, we believe that there will be few (if any) such situations.

As discussed below, we project that all terminals that distribute gasoline would install ethanol blending capability in response to the RFS2 standards. However, we estimate that only 44% of terminals that distribute diesel would install biodiesel blending/storage capability under the RFS2 standards. Therefore, in the case of biodiesel, those terminals that would experience that most difficulty in installing new storage capacity could forgo bringing biodiesel into their terminal

Another question is whether the storage tank construction industry would be able to keep pace with the increased demand for new tanks that would result from today's proposal. The storage tank construction industry recently experienced a sharp increase in demand after years of relatively slack demand for new tankage. Much of this increase in demand was due to the unprecedented increase in the use of ethanol. Storage tank construction companies had been increasing their capabilities which had been pared back during lean times. Given the projected gradual increase in the need for biofuel storage tanks, it seems reasonable to conclude that the storage tank construction industry would be able to keep pace with the projected demand.

Petroleum terminals would need to install additional equipment to blend ethanol with gasoline as well as making other miscellaneous upgrades to piping, pumps, seals, and vapor recovery systems to ensure ethanol compatibility. There are currently 1,063 petroleum terminals that carry gasoline.⁴⁵¹ We project that 899 of these terminals (85% of the total) would install E10 blending equipment absent the implementation of today's proposed requirements in order to support the consumption of 13.18 BGY of ethanol by 2022 under the reference case. This is based on 85% of the gasoline needing to be blended with ethanol in order to consume 13.18 BGY of ethanol considering the projected use levels of E10 versus E85 and total motor vehicle fuel consumption in 2022.^{GGGGG} We project that essentially all gasoline would be either E10 or E85 by 2022 under the RFS2 standards. Thus, we estimate that all terminals would need to have ethanol blending capability to support the use of the volume of ethanol we project would be used under the RFS2 standards. Based on our projection that 899 terminals would install ethanol

^{GGGGG} A discussion of the volumes of biofuels we estimate would be used absent the RFS2 standards is located in chapter 1.2 of this DRIA.

blending capability absent the RFS2 standards, we estimate that 164 terminals would need to install ethanol blending equipment as a result of the proposed requirements.

We estimate that E85 would need to be reasonably available in 70% of the nation in order to support the use of the projected volume of E85 needed to comply with the proposed standards.^{HHHHH} To provide a conservatively high estimate, we are projecting that 90% of all gasoline terminals (931) would need to install E85 blending capability by 2022. The remaining terminals (132 out of a total of 1,063) would only have E10 blending capability in 2022. We estimate that the terminals which would have installed E10 blending capability absent the proposed standards would upgrade their E10 blending facilities to accommodate E85 as well as E10. This is based on the assumption that those terminals that were the first to blend E10 would also be the first to begin blending E85. Input from terminal operators indicates that the modification of E10 blending equipment to handle E85 primarily involves an upgrade to the blending equipment software.^{IIIII} We estimate that the vapor recovery systems at all terminals that had not received ethanol before would need to be upgraded to handle ethanol-blended gasoline.

We considered the following in estimating the number of terminals that would store/blend biodiesel in response to the RFS2 standards. We estimate that 853 terminals handle diesel fuel.⁴⁵² We estimate that approximately 62.5 billion gallons of diesel fuel would be used in 2022.^{JJJJJ} Thus, the average diesel throughput per terminal would be approximately 73.2 MGY. We estimate that on a national average basis biodiesel would represent approximately 2.9% of the diesel fuel pool. For the purposes of our calculation of the number of terminals that would carry biodiesel, we assumed that 2.9% of the diesel fuel they dispense would be biodiesel. This is likely to result in a conservatively high number of terminals that would need to carry biodiesel, since those terminals that do carry biodiesel would be expected to blend at higher than the national average concentration. Assuming that 2.9% of a terminal's diesel fuel throughput would be biodiesel, we arrive at an estimate that 377 terminals would need to blend biodiesel to support the projected use of 810 MGY of biodiesel by 2022 under the RFS2 standards. We estimate that 200 terminals would need to store/blend biodiesel in order to support the use of volume of biodiesel that we estimate would be used as a result of the RFS2 standards relative to the AEO 2007 380 MGY 2022 baseline.

New equipment will be needed at terminals to facilitate the receipt of ethanol by truck, manifest rail car, and by unit train. As discussed in Section 1.6.3 of this DRIA, we estimated that half of the ethanol unit train receipt facilities (21) needed as a result of the RFS2 standards would be placed at petroleum terminals and half would be placed at rail terminals for the purpose of this analysis.^{KKKKK} In estimating the number of additional manifest rail car receipt facilities

^{HHHHH} A discussion of our E85 use projections is contained in chapter 1.7 of this DRIA.

^{IIIII} Additional ethanol storage and modifications to terminal piping would also be needed to supply additional quantity of ethanol needed to blend E85.

^{JJJJJ} A discussion of our estimate of biodiesel use in relation to the use of petroleum-based diesel is contained in Section 1.5.4 of this DRIA.

^{KKKKK} We intend to review our estimate of the number of ethanol rail receipt facilities in light of the recent ORNL report which assumed that all such new rail receipt capability would be placed at rail terminals due to the difficulties in accommodating such facilities at petroleum terminals. This applies to manifest rail as well as unit train receipt facilities.

that would be needed at petroleum terminals, we assumed 5 deliveries per month of 8 cars at each facility. This would result in the delivery of 1,180,000 gallons of ethanol per month which we believe to be reasonable, giving the anticipated motor vehicle gasoline throughput at terminals we expect would receive ethanol shipments by manifest rail car. Based on the ethanol volumes we projected to be transported by manifest rail car in Table 1.6-1 of this DRIA, this translates to a total of 241 manifest rail car receipt facilities for all ethanol used by 2022 and 148 such facilities to handle the volume attributed to the RFS2 standards alone (relative to the AEO 2007 based 2022 reference case). Lacking any specific data on the number of terminals that currently have rail receipt capability, we estimate that 50% of the terminals that install ethanol rail receipt capability would have already had an active rail connection and that 50% would need to install a short spur to connect to a nearby rail line.

As discussed in Section 1.6.3 of this DRIA, we expect that to the extent that the projected number of ethanol rail receipt facilities could not be cited at petroleum terminals that they would be cited at rail terminals. Petroleum terminals within trucking distance of each other are also likely to cooperate so that only one would need to install rail receipt capability. Given the timeframe during which the projected volumes of ethanol ramp up, we believe that these means can be utilized to ensure that a sufficient number of terminals have access to ethanol shipped by rail although some will need to rely on secondary shipment by truck from large ethanol hub receipt facilities.

We project that those terminals that would receive domestic shipments of ethanol by barge would have already installed the necessary barge offloading equipment. Terminals that also serve as points of entry for imported ethanol which did not previously receive shipments of ethanol would need to install facilities to accept marine shipments of ethanol. We estimate that there would be a total of 29 terminals that receive imported ethanol by 2022 and that 12 of these terminals would not have received ethanol shipments previously.^{LLLLL} We do not project the need for additional facilities at terminals to accept receipts of biodiesel and renewable diesel fuel. We expect that the facilities projected to be installed for ethanol could be used for biodiesel and renewable diesel fuel. In the case of biodiesel, new heated/insulated transfer piping would be needed from the receipt facility to the storage tank.

The Independent Fuel Terminals Operators Association (IFTOA) stated that terminals are concerned that the market would not be able to adapt in time to ensure that the necessary distribution infrastructure accommodations are in place to support compliance with the timetable for the implementation of the RFS2 standards.⁴⁵³ Based on this concern, in a presentation at the 2008 SAE government-industry conference IFTOA suggested that EPA should consider reducing and or slowing the pace of the implementation of the RFS2 standards in order to allow the market sufficient time to adjust.⁴⁵⁴ We do not believe that there is sufficient reason at this time to conclude that the distribution system could not adapt sufficiently within the time frame established by statute for the implementation of the RFS2 standards. We will continue to monitor the progress made to by the distribution system to make the necessary changes. To the extent that the fuel distribution industry experiences difficulty in installing the needed storage tanks and blending equipment, the continuation of the interim practices of transloading and splash blending would help to bridge the gap.

^{LLLLL} See Section 6.1.5 of this DRIA for a discussion of ethanol import locations.

The RFG and anti-dumping regulations currently require certified gasoline to be blended with denatured ethanol to produce E 85. The gasoline must meet all applicable RFG and anti-dumping standards for the time and place where it is sold. We understand that some parties may be blending butanes and or pentanes into gasoline before it is blended with denatured ethanol in order to meet ASTM minimum volatility specifications for E85 that were set to ensure proper driveability, particularly in the winter.^{MMMMM} If terminal operators add blendstocks to finished gasoline for use in manufacturing E85, the terminal operator would need to register as a refiner with EPA and meet all applicable standards for refiners.

Testing has shown that much of in-use E85 does not meet minimum ASTM volatility specifications.^{NNNNN} However, it is unclear if noncompliance with these specifications has resulted in a commensurate adverse impact on driveability. This has prompted a re-evaluation of the fuel volatility requirements for in-use E85 vehicles and whether the ASTM E85 volatility specifications might be relaxed or the minimum amount of ethanol in E85 adjusted downwards to facilitate compliance with the current volatility requirements.^{OOOOO} For the purpose of our analysis, we are assuming that certified gasoline currently on hand at terminals can be used to make up the non-ethanol portion of E85.^{PPPPP}

We will continue to evaluate the extent that special blendstocks would be used to manufacture E85 at terminals particularly in light of the outcome of the ASTM process and adjust our estimates for the final rule as appropriate. Input from industry indicates that it is not common for gasoline terminals to have butane/pentane storage capability. This input further indicates that the space requirements for citing a pressurized butane storage vessel make installation of butane storage at some terminals impractical. If special gasoline blendstocks not typically found at terminals are needed for the manufacture of E85, there could be substantial additional costs and logistical challenges associated with shipping these blendstocks to terminals.

1.6.10 Additional E85 Retail Facilities

As discussed in Section 1.7.1.2 of this DRIA, we estimate that end-users would need to have reasonable access to E85 in 70% of the nation by 2022 given our projections regarding the population of flexible fuel vehicles (FFVs) and E85 refueling frequencies.^{QQQQQ} We define reasonable access as one in four gasoline retail facilities offering E85 in fashion consistent with the way they currently offer gasoline. We selected one in four based on a review of the number of facilities that have been postulated to be needed to support the introduction of alternative fuels vehicles such as hydrogen and natural gas vehicles, the number of facilities that currently offer

^{MMMMM} “Specification for Fuel Ethanol (Ed75-Ed85) for Spark-Ignition Engines”, American Society for Testing and Materials standard ASTM D5798.

^{NNNNN} Coordinating Research Council (CRC) report No. E-79-2, Summary of the Study of E85 Fuel in the USA Winter 2006-2007, May 2007. <http://www.crcao.org/reports/recentstudies2007/E-79-2/E-79-2%20E85%20Summary%20Report%202007.pdf>

^{OOOOO} CRC Cold Start and Warm-up E85 Driveability Program, <http://www.crcao.com/about/Annual%20Report/2007%20Annual%20Report/Perform/CM-133.htm>

^{PPPPP} This is different from the approach taken in the refinery modeling which assumed that special blendstocks would be used to blend E85. A discussion of the refinery modeling can be found in Section 4 of this DRIA.

^{QQQQQ} Chapter 1.7 of this DRIA contains a discussion of our projections regarding the prevalence of flexible fuel vehicles in the vehicle fleet and the relative volumes of E85 versus E10 that would be used in these vehicles.

diesel fuel, and industry estimates regarding the number of E85 facilities that would be needed. One in five to one in three retail facilities has been discussed as a reasonable rule of thumb regarding the number of retail facilities needed to support the widespread introduction of alternative fuel vehicles.

We estimate that approximately one in three fuel retail facilities (32%) offered diesel fuel in 1999 based on our review of fuel retailer survey data.⁴⁵⁵ The National Association of Convenience Stores (NACS) reported that in 2006, 36.6% of the respondents to their survey offered diesel fuel.⁴⁵⁶ We believe that given that NACS members typically do not include truck stop operators (who all offer diesel fuel) that that it is most likely that the number of diesel fuel retailers has increased since 1999. Since fuel retailers make most of their money from in-store sales as opposed to fuel sales, it seems likely that more retailers recognized an opportunity to attract additional customers by offering diesel fuel since 1999. In any event, the number of diesel fuel refueling facilities available in 1999 or 2006 has not hindered the use of diesel fuel vehicles. Unlike diesel fuel vehicles that can refuel only on diesel fuel, flex fuel vehicles can refuel on gasoline as well as E85. We project that flex-fuel vehicles would only refuel on E85 70% of the time in order to meet the ethanol consumption goals necessary to support the RFS2 standards.^{RRRRR} Thus, we believe that the percentage of total fuel retail facilities that sell diesel fuel (32% based on our 1999 estimate) serves as an upper bound regarding the number of E85 retail facilities that would be needed.

At the same many time fleet operators were divesting of their in-house fueling facilities because of new environmental regulations, most retailers were installing equipment to blend mid-grade gasoline at the pump rather than store a separate mid-grade gasoline. This allowed for a significant number of retailers to begin offering diesel fuel at relatively low capital cost by converting storage tanks that had been dedicated to mid-grade gasoline storage to diesel fuel service. A number of retail facilities (40% of the total that installed diesel fuel tanks had low annual diesel throughput volumes of less than 60,000 gallons per year in 2000.⁴⁵⁷ Only 5% of total diesel retail sales are estimated to be sold at these low-volume retailers. Given that the installation of some diesel retail facilities was not strictly driven on the expectation or realization of substantial throughput, it seems reasonable to assume that some fraction of low-volume retailers may not be absolutely necessary to ensure adequate diesel availability. Therefore, somewhat less than 32% of retail facilities might actually be needed to ensure adequate diesel fuel availability. We believe that this comparison to the number of diesel fuel retail facilities available supports our estimate that one in four retail facilities would be sufficient to provide reasonable access to E85.

By multiplying the one-in-four reasonable access assumption by the assumed 70% of the retail market that would need to have reasonable access to E85, and the total number of retail facilities, we arrived at our estimate that there would need to be a total of 28,750 E85 retail locations to facilitate the consumption of the amount of ethanol that we project would be used by 2022 in response to the requirements under the RFS2 standards. The National Ethanol Vehicle Coalition (NEVC) estimates there are currently 1,767 E85 refueling facilities.⁴⁵⁸ However, the NEVC estimate includes E85 refueling facilities that are not open to the general public.⁴⁵⁹ “NEAR85” estimates that there are currently 1,247 E85 retail facilities. The Near85 estimate

^{RRRRR} A discussion of E85 refueling rates is contained in Section 1.7.1.2.4 of this DRIA.

includes only retail facilities. Based on these data, we are assuming that there are approximately 1,300 E85 retail facilities currently in service for the purposes of our E85 retail facility cost analysis. By growing the number of E85 retail facilities by the same proportion as the growth in our projections for the growth in ethanol use under the AEO 2007 based 2022 reference case, we estimate that 4,500 E85 refueling facilities would be in place by 2022 absent the RFS2 standards. Thus, we estimate that today's rule would result in the need for an additional 24,250 retail E85 facilities by 2022.

We project that a number of E85 facilities would install multiple E85 pump stands. We based our estimate on the number of facilities that would install multiple E85 pump stands on an evaluation of how the anticipated E85 use levels translate to daily throughput per delivery nozzle. We estimate that by 2022 approximately 27.1 BGY of E85 would be used under the RFS2 standards.^{SSSSS} We are assuming that all existing E85 refueling facilities and those that would be constructed absent the RFS2 standards have one pump stand each. There are two delivery nozzles (i.e. refueling positions) per each pump stand. Assuming that 40% of new E85 retail facilities constructed due to the RFS2 standards install 2 pump stands (4 nozzles) and the remainder install a single pump stand results in a total of 76,900 E85 fueling positions (nozzles) by 2022. We assumed an average E85 refueling volume of 15 gallons. This translates to an annual E85 throughput per refueling position of 353,000 gallons or one refueling event every 22 minutes. We believe this may be a reasonable, albeit optimistic, assumption regarding the future use rates of E85 refueling equipment. To evaluate the validity of this assessment, we reviewed historical data regarding the use rates for refueling equipment for other fuels.

The National Association of Convenience Stores (NACS) reports throughput per refueling position.⁴⁶⁰ For all types of fuel dispensed, NACS reports that from 2001 through 2006, the annual throughput varied from approximately 142,000 to 164,000 gallons per refueling position. These data include reports on the sales of all fuels including premium, mid-grade, and regular gasoline, diesel fuel and other fuels. The most appropriate comparison would be made to throughput from refueling positions that dispense only regular gasoline since the use of E85 would primarily displace regular gasoline sales. However, this is not possible given that most gasoline is dispensed from blender pumps that can dispense any gasoline grade. Hence, we chose to make the comparison to throughput over dispensers that offer all gasoline grades, which may tend to underestimate the potential utilization rate of dispenser that dispenses only regular grade gasoline.

NACS reports that there is an average of 8.6 refueling positions at the retail facilities that responded to their survey. NACS reports that 36.6% of stores sold diesel fuel and 15.1% sold "other" fuels (i.e. not diesel, regular, mid-grade, or premium gasoline).^{TTTTT} To estimate how many refueling positions are dedicated to diesel fuel and "other" fuels, we assumed that retailers offer diesel fuel from one pump with two nozzles, and other fuels from one pump with one nozzle. By multiplying the percentage of retailers that offer diesel fuel/other fuel by the assumed refueling positions for these fuels where they are present, we arrived at an estimate of 0.9 refueling positions per facility on average dedicated to diesel fuel and other fuel. This translates to an average of 7.7 refueling positions per facility that dispenses gasoline. NACS

^{SSSSS} A discussion of our E85 use projections is contained in Section 1.7.1.2 of this DRIA.

^{TTTTT} In many cases, we expect that the "other" fuel is kerosene.

reports that 92.7% of fuel volumes sold by respondents to their survey is gasoline (of all grades). By dividing 92.7% of the total average throughput for all fuels per facility reported by NACS by 7.7 refueling positions, we arrived at an estimate of annual gasoline throughput per nozzle of 177,000 gallons for 2003.^{UUUUU} The estimated E85 throughput per nozzle under the assumption that 40% of new facilities would install four E85 refueling positions is nearly twice this figure.

We anticipate that most new E85 refueling facilities would be installed at larger fuel retailers because these would be most forward looking with respect to attracting new customers, would be most likely to have the needed space, and be would have the best access to capital. A higher throughput could be expected at larger fuel retailers compared to that across all retail facilities reflected in the NACS survey. Thus, we believe that the projected level of E85 refueling position throughput of 353,000 gallons per year may be attainable, albeit ambitious. We performed a sensitivity analysis to evaluate the effect on E85 refueling position throughput if additional E85 pumps were installed.

If each of the 28,750 E85 refueling facilities that we estimate would be needed by 2022 installed 2 E85 pumps/4 nozzles, the annual E85 throughput per nozzle would be 236,000 gallons. If each installed 3 E85 pumps/6 nozzles the annual E85 throughput per nozzle would be 157,000 which is consistent with current gasoline pump utilization rates. We anticipate that some of the additional E85 pumps would take the place of existing gasoline pumps as E10 use is displaced by E85 use. It is also possible that pumps could be configured to dispense E10 as well as E85.

We assumed that one new 8,000 gallon E85 underground storage tank would be installed at each E85 refueling facility. Based on our estimate of 28,750 E85 refueling facilities and the use of 27.125 BGY of E85 by 2022, annual E85 throughput per facility would be approximately 943,000 gallons. This translates to one 7,000 gallon E85 delivery by tank truck every 2.7 days.^{VVVVV} We believe that this is a reasonable fuel delivery rate, particularly in light of our projection that new E85 facilities would likely be installed at the larger fuel retail facilities. We believe that a number of larger retailers have multiple gasoline storage tanks. Although not necessary to support E85 retail facility throughput, as E85 throughput ramps up and gasoline throughput decreases, some facilities may choose to retrofit one of their gasoline storage tanks to E85. However, we understand that it may be difficult or impossible to confirm the compatibility of some existing underground storage tanks and other tank-related hardware. In fact, several states (e.g. California) will not allow existing underground storage tanks to be upgraded to store ethanol blends greater than 10% due to compatibility concerns.

Approximately 1,960 new E85 facilities would need to be added each year from 2009 through 2022 in order to satisfy this goal of 28,750 facilities by 2022. The addition of 1,960 new E85 retail facilities a year is very ambitious given that there are currently only 1,300 E85 retail facilities in service. Nevertheless, we believe the addition of these numbers of new E85 facilities may be possible for the industries that manufacture and install E85 retail equipment. Underwriters Laboratories recently finalized its certification requirements for E85 retail

^{UUUUU} The year 2003 had the highest average throughput per refueling position over the years 2001- 2006.

^{VVVVV} A 7,000 delivery volume was assumed to provide adequate reserve at the retail facility to ensure consistent availability.

equipment.⁴⁶¹ Equipment manufactures are currently evaluating the changes that will be needed to meet these requirements. However, we anticipate the needed changes will not substantially increase the difficulty in the manufacture of such equipment compared to equipment which is specifically manufactured for dispensing E85 today.

Petroleum retailers expressed concerns about their ability to bear the cost of installing new E85 refueling equipment because of the difficulty of obtaining the necessary capital and to achieve adequate capital recovery. We estimated the costs under both our primary scenario where only 40% of E85 retailers install 2 pumps and under the sensitivity case where all E85 retail facilities are assumed to have 3 E85 pumps.^{wwwww} A full discussion of our estimated of E85 facility costs is contained in Section 4.2 of this DRIA. We assumed all new pump stands under both scenarios. This will tend to provide a conservatively high estimate of costs since we expect that some E10 dispensers would be replaced by E85 dispensers under the 3 pump per facility sensitivity case. Under the 3-pump sensitivity case, we also included the cost of retrofitting an existing gasoline storage tank to provide additional E85 storage capacity at 50% of new E85 facilities. Under our primary case where we assume that 40% of new facilities install 2 E85 pumps and the remainder would have one pump, we estimate that the cost of installing E85 refueling equipment will average \$122,000 per facility which equates to \$3 billion by 2022. These costs include the installation of an underground storage tank, piping, dispensers, leak detection, and other ancillary equipment that is compatible with E85.^{xxxxx} Under the sensitivity case, where all E85 facilities are assumed to have 3 E85 pumps, we estimate the cost for facilities that did not offer E85 before would be approximately \$166,000 per facility. For those facilities that already offered E85, the cost of installing 2 additional pump stands is estimated at \$46,000 per facility. The total cost of E85 refueling facilities under the 3-pump sensitivity case is estimated at 4.2 billion by 2022.

Today's proposal does not contain a requirement for retailers to carry E85. We understand that retailers will only install E85 facilities if it is economically advantageous for them to do so and that they will price their E85 and E10 in a manner to recover these costs. As discussed earlier we expect that larger fuel retailers would be most likely to install new E85 refueling facilities. While the \$3 billion total cost for E85 refueling facilities is a substantial sum under our primary E85 facility scenario, it equates to just 1.2 cents per gallon of E85 throughput. Under the 3-pump sensitivity case, the total E85 facility cost of \$4.2 billion equates to 1.7 cents per gallons of E85 throughput.^{yyyyy} Therefore, we do not believe that the cost of installing E85 refueling equipment will be unmanageable to retailers given the very large projected consumer demand for E85. Government incentives are also available to help defer the cost of installing E85 retail equipment and expansions of these incentives are under consideration.^{zzzzz}

^{wwwww} Section 4.2 of this DRIA contains a discussion of estimated E85 retail facility costs.

^{xxxxx} 40 CFR 280.32 states that underground storage tank systems must be made of or lined with materials that are compatible with the substance stored in the system.

^{yyyyy} Our estimates of the cost of the E85 retail facilities that would be needed to support the use of the volume of ethanol that we project would be used under the RFS2 standards is contained in Section 4.2 of this DRIA.

^{zzzzz} See Section 1.7.1.2.3 of this DRIA for a discussion of government incentives to install E85 retail refueling equipment.

Petroleum retailers also expressed concern regarding their ability to discount the price of E85 sufficiently to persuade flexible fuel vehicle owners to choose E85 given the lower energy density of ethanol. This issue is discussed in Section 1.7.1.2.5 of this DRIA.

1.6.11 Potential Impact on the Fuel Distribution System if a Waiver is Granted for Mid-Level Ethanol Blends and Ancillary Issues that would need to be Resolved to Facilitate the Introduction of Mid-Level Ethanol Blends

As discussed in Section 1.7.1.3.1 of this DRIA, there is interest in evaluating the suitability of midlevel ethanol blends (e.g. E15) for use in non-flex fuel vehicles to facilitate the consumption of the large volumes of ethanol that would be needed to satisfy the RFS2 standards. While a waiver may legalize the use of mid-level ethanol blends under the CAA, there are a number of other actions that would have to occur to bring mid-level blends to retail. The time needed to take these actions could delay the penetration of mid-level ethanol blends into the market. The CAA only provides a 1 pound RVP waiver for ethanol blends of 10 volume percent or less. Lacking such an RVP waiver, a special low-RVP gasoline blendstock would be needed at terminals to all the formulation of mid-level ethanol blends that are complaint with EPA RVP requirements. Providing such a separate gasoline blendstock could present significant logistical challenges and costs to the fuel distribution system.^{AAAAAA} In addition, a number of changes would be needed to EPA regulations including those pertaining to reformulated and conventional gasoline, and deposit control additives to accommodate and mid-level ethanol blends. Such changes would need to be made through the notice and comment process similar to today's action. Independent of EPA's regulations, most states require that fuel comply with the applicable ASTM International (formally known as the American Standards for Testing and Materials) specification. The development of an ASTM International specification for mid-level ethanol blends through an industry consensus process is currently being initiated.

There are a number of requirements regarding the fire and leak protection safety of retail fuel dispensing and storage equipment. EPA's Office of Underground Storage Tanks (OUST) requires that UST systems must be compatible with the fuel stored in the system. These requirements pertain to all components of the system including the storage tank, connecting piping, pumps, seals and leak detection equipment. The Occupational Safety and Health Administration (OSHA) requires that retail fuel handling equipment be listed with an independent standards body such as Underwriters Laboratories (UL). No independent standards body has listed fuel handling equipment for mid-level ethanol blends. Furthermore, UL has stated that it would not expand listings for in-use fuel retail equipment originally listed for E10 blends to cover greater than E10 blends.^{BBBBBB}

^{AAAAAA} It may be possible for refiners to formulate a gasoline blendstock that would be suitable for manufacturing mid-level ethanol blends and E10 at the terminal. While this would avoid the logistical problems associated with maintaining separate blendstocks, there could be significant additional refining costs.

^{BBBBBB} UL stated that they have data which indicates that the use of fuel dispensers certified for up to E10 blends to dispense blends up to a maximum ethanol content of 15 volume percent would not result in critical safety concerns (<http://www.ul.com/newsroom/newsrel/nr021909.html>). Based on this, UL stated that it would support authorities having jurisdiction who decide to permit legacy equipment originally certified for up to E10 blends to be used to dispense up to 15 volume percent ethanol. The UL announcement did address the compatibility of underground storage tank systems with greater than E10 blends.

States typically adopt fire safety codes from either the National Fire Protection Association (NFPA) or the International Code Council (ICC). These organizations currently do not have provisions that would allow the mid-level ethanol blends to be stored/dispensed from existing equipment at retail. Local safety officials (e.g. fire marshals) referred to as “Authorities Having Jurisdiction” (AHJ’s) often require a UL certification for fuel retail storage/dispensing equipment although some will accept other substantiation of equipment safety such as a manufacture certification. Fuel retailers must also satisfy the requirements of the insurance company that they are insured through which may be more stringent than the legal requirements.

The Department of Energy and EPA are currently working with industry to evaluate what changes may be necessary to underground storage tank systems, fuel dispensers, and refueling vapor recovery equipment at fuel retail facilities to handle a mid-level ethanol blend. If existing equipment proves tolerant to a mid-level ethanol blend, this could substantially facilitate its introduction at retail. If the data supports the suitability of legacy retail equipment to store/dispense a mid-level blend, then the process of seeking acceptance by the standard bodies discussed above could commence. The normal processes used by these standards bodies can be lengthy. For example, the NFPA has a 3 year cycle for evaluating changes to its codes with proposals for the current cycle due this June.^{CCCCC} Thus, apart from the need to technically evaluate the suitability of legacy retail equipment to handle a mid-level ethanol blend, the need to secure recognition from standards bodies could delay the introduction of a mid-level ethanol blend at retail should a waiver be granted by EPA.

If some components of the above ground existing retail hardware are found to be incompatible with a mid-level ethanol blend, it may be possible for them to be replaced through normal attrition. For example the “hanging hardware” which includes the nozzle and hose from the dispenser is typically replaced every 3 to 5 years. It is also possible that only minor changes might be needed to equipment that has a longer service life which might be accomplished without too much difficulty/cost. However, if extensive new equipment is needed and particularly if this involves the breaking of concrete, we believe that it is unlikely that fuel retailer would opt to install equipment specifically for a mid-level ethanol blend given the projected future need for retail equipment capable of handling E85.^{DDDDDD} The deployment of mid-level ethanol blends would still not get us all the way to meeting the RFS2 volumes requirements. Once the nation hit the mid-level blend wall, refiners and marketers would still need to invest another \$2-3 billion in E85 infrastructure (depending on the scenario) or find other non-ethanol alternatives to meet the RFS2 volume requirements.^{EEEEEE}

Fuel retail operators are concerned about the potential liability from the misfueling of vehicles/equipment that might not be covered if a partial waiver is granted for mid-level ethanol blends. We anticipated that additional fuel pump labeling requirements would be needed. It is

^{CCCCC} It is unclear whether sufficient material could be assembled by industry in time for the consideration of dispensing E15 from legacy retail equipment be entered into the currently NFPA 3 year cycle.

^{DDDDDD} As discussed previously, significant penetration of E85 is projected to be needed to facilitate the use of the volumes of ethanol we project would be needed to satisfy the requirements of the EISA.

^{EEEEEE} For more information on retail and ethanol consumption impacts of mid-level ethanol blend assessment, refer to Sections 1.6.11 and 1.7.1.3 of the DRIA, respectively.

unclear what other measures might be needed to adequately prevent misfueling if a partial waiver is granted.

Finally, auto manufactures would need to extend the warranty coverage for vehicles covered under a waiver in order to give consumers adequate confidence to use mid-level ethanol blends. Owner manuals for non-FFV vehicles in the existing fleet are written to void vehicle warranties if the vehicle is operated on ethanol levels greater than 10%.

Given our assumption that no ethanol would be transported by pipeline, we expect that there would be no impact on the ethanol distribution system through the terminal level. If shipment of ethanol by pipeline does become practicable, there would obviously be implications regarding which ethanol blend ratio would be most desirable to ship. At the terminal level, the amount of ethanol blended into gasoline as it is delivered into tanks would be adjusted to the desired mid-level blend ratio. We expect that only minimal changes to the software for the blending equipment would be needed to accommodate the delivery of mid-level blends up to the point of delivery to retail facilities.

1.7 Biofuel Consumption Feasibility

1.7.1 Ethanol Consumption

1.7.1.1 Historical/Current Ethanol Consumption

Ethanol and ethanol-gasoline blends have a long history as automotive fuels. However, cheap gasoline/blendstocks kept ethanol from making a significant presence in the transportation sector until the end of the 20th century when environmental regulations and tax incentives helped to stimulate growth.

In 1978, the U.S. passed the Energy Tax Act which provided an excise tax exemption for ethanol blended into gasoline that would later be modified through subsequent regulations.^{FFFFF} In the 1980s, EPA initiated a phase-out of leaded gasoline which created some interest in ethanol as a gasoline oxygenate. Upon passage of the 1990 CAA amendments, states implemented winter oxygenated fuel (“oxyfuel”) programs to monitor carbon monoxide emissions. EPA also established the reformulated gasoline (RFG) program to help reduce emissions of smog-forming and toxic pollutants. Both the oxyfuel and RFG programs called for oxygenated gasoline. However, petroleum-derived ethers, namely methyl tertiary butyl ether (MTBE), dominated oxygenate use until drinking water contamination concerns prompted a switch to ethanol. Additional support came in 2004 with the passage of the Volumetric Ethanol Excise Tax Credit (VEETC). The VEETC provided domestic ethanol blenders with a \$0.51/gal tax credit, replacing the patchwork of existing subsidies.^{GGGGG} The phase-out of MTBE and the

^{FFFFF} Gasohol, a fuel containing at least 10 percent biomass-derived ethanol, received a partial exemption from the federal gasoline excise tax. This exemption was implemented in 1979 and a blender’s tax credit and a pure alcohol fuel credit were added to the mix in 1980.

^{GGGGG} The recently enacted Food, Conservation, and Energy Act of 2008 (“2008 Farm Bill”) replaces the \$0.51/gal ethanol blender credit with a \$0.45/gal corn ethanol blender credit and also introduces a \$1.01/gal cellulosic biofuel

introduction of the VEETC along with state mandates and tax incentives created a growing demand for ethanol that surpassed the traditional oxyfuel and RFG markets. By the end of 2004, not only was ethanol the lead oxygenate, it was found to be blended into a growing number of states' conventional gasoline. According to our RFS1 baseline oxygenate assessment, in 2004, ethanol was found to be blended into 15 states' conventional gasoline, 10 states' winter oxyfuel, and 15 states' RFG as shown in Table 1.7-1.⁴⁶²

producer credit. Both credits are effective January 1, 2009. The 2008 Farm Bill is discussed in more detail in later parts of this subsection.

**Table 1.7-1.
2004 U.S. Ethanol Usage by State (Million Gallons)**

State	CG	Oxy	RFG	Total
California	0.0	0.0	853.0	853.0
Illinois	110.8	0.0	310.7	421.5
New York	0.0	0.0	301.2	301.2
Minnesota	268.4	0.0	0.0	268.4
Ohio	191.6	0.0	0.0	191.6
New Jersey	0.0	0.0	187.6	187.6
Connecticut	0.0	0.0	152.2	152.2
Indiana	105.3	0.0	42.7	148.0
Missouri	42.9	0.0	79.1	122.0
Iowa	116.7	0.0	0.0	116.7
Wisconsin	47.3	0.0	61.3	108.6
Arizona	0.0	13.5	74.8	88.3
Colorado	0.0	80.2	0.0	80.2
Michigan	76.9	0.0	0.0	76.9
Kentucky	0.0	0.0	49.9	49.9
Hawaii	45.2	0.0	0.0	45.2
Kansas	40.8	0.0	0.0	40.8
Texas	0.0	13.1	26.3	39.5
Nebraska	37.2	0.0	0.0	37.2
Alabama	31.4	0.0	0.0	31.4
Oregon	0.0	30.8	0.0	30.8
South Dakota	23.9	0.0	0.0	23.9
Nevada	0.0	23.1	0.0	23.1
Massachusetts	0.0	0.0	18.4	18.4
Washington	0.0	17.9	0.0	17.9
North Dakota	10.5	0.0	0.0	10.5
New Mexico	0.0	8.0	0.0	8.0
Alaska	0.0	3.4	0.0	3.4
Utah	0.0	1.9	0.0	1.9
Montana	0.0	1.1	0.0	1.1
Rhode Island	0.0	0.0	0.3	0.3
Maryland	0.0	0.0	0.3	0.3
Florida	0.1	0.0	0.0	0.1
Virginia ^a	0.0	0.0	0.0	0.0
Total	1,149.0	193.0	2,158.0	3,500.0

^aApproximately 3,200 gallons of ethanol use according to FHWA.

In the years that followed, rising crude oil prices and other favorable market conditions continued to drive ethanol usage. In May 2007, EPA promulgated a Renewable Fuel Standard (“RFS1”) in response to the Energy Policy Act of 2005.⁴⁶³ The RFS1 program set a floor for renewable fuel use reaching 7.5 billion gallons by 2012, the majority of which was ethanol. The country is currently on track for exceeding the RFS1 requirements and meeting the introductory years of today’s proposed RFS2 program. For a summary of the growth in U.S. ethanol usage over the past decade, refer to Table 1.7-2.

**Table 1.7-2.
U.S. Ethanol Consumption (Including Imports)**

Year	Total Ethanol Use ^a	
	Trillion BTU	Bgal
1999	120	1.4
2000	138	1.6
2001	144	1.7
2002	171	2.0
2003	233	2.8
2004	292	3.5
2005	334	4.0
2006	451	5.3
2007	566	6.7
2008	792	9.4

^aEIA Monthly Energy Review March 2009
(Table 10.2)

According to EIA’s March 2009 Monthly Energy Review, the U.S. consumed approximately 9.4 billion gallons of ethanol in the transportation sector in 2008.⁴⁶⁴ If ethanol consumption continues to grow (as it did from 2005-2008), the nation should be on track for meeting the 2009 volume requirements set forth by EISA (10.3 billion gallons of ethanol, based on our volume interpretations explained in Section 1.2). For a graphical representation of monthly ethanol usage over the past few years, refer to Figure 1.7-1.

**Figure 1.7-1.
2005-2008 Monthly Ethanol Consumption (Including Imports)⁴⁶⁵**

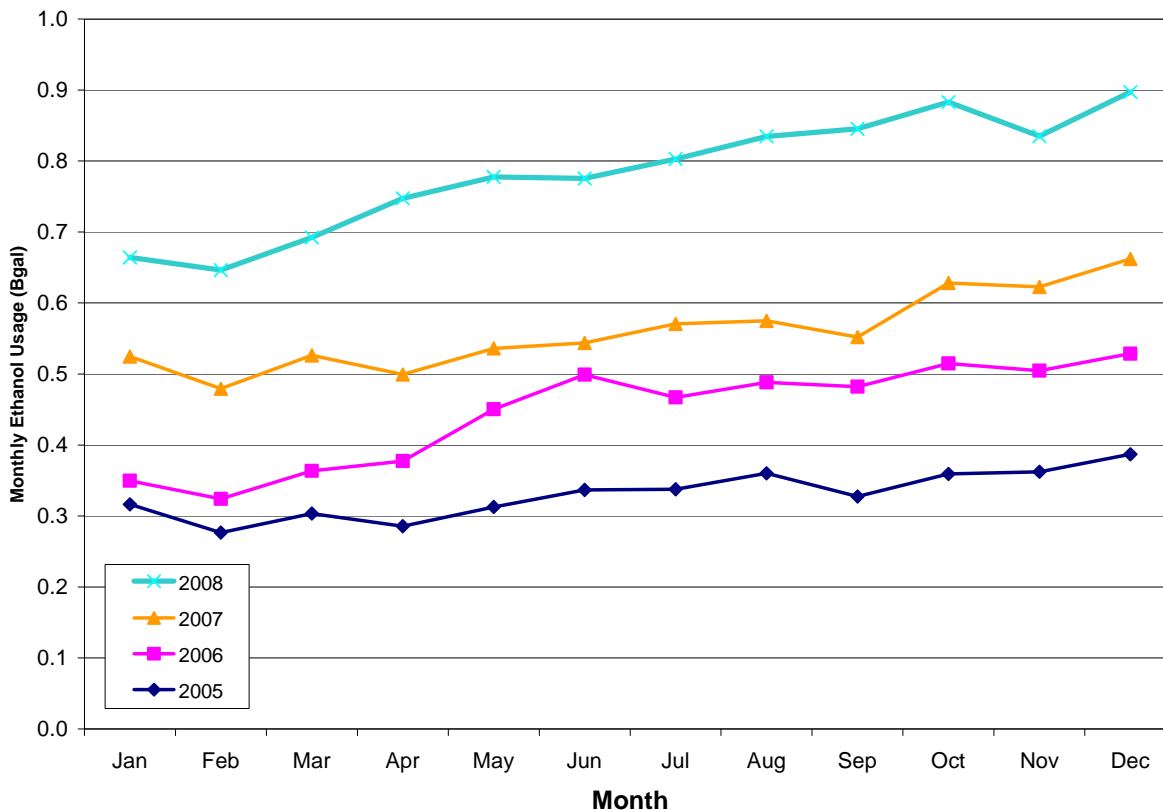

Not only is ethanol usage projected to grow in future years under the proposed RFS2 program, it is expected to come from more diversified sources. The Food, Conservation, and Energy Act of 2008 (also known as the “2008 Farm Bill”) is expected to spur cellulosic ethanol production and use.⁴⁶⁶ The recently-enacted Farm Bill modifies the existing \$0.51 per gallon alcohol blender credit to give preference to ethanol and other biofuels produced from cellulosic feedstocks. As of January 1, 2009, corn ethanol receives a reduced credit of \$0.45/gal and cellulosic biofuel earns a credit of \$1.01/gal.^{HHHHHH}

Through the years, there have also been several policy initiatives to increase the number of flexible fuel vehicles (FFVs) capable of consuming up to 85 volume percent ethanol blends (E85). The Alternative Motor Vehicle Fuels Act of 1988 provided automakers with Corporate Average Fuel Economy (CAFE) credits for producing alternative-fuel vehicles, including FFVs as well as CNG and propane vehicles. Furthermore, the Energy Policy Act of 1992 required government fleets to begin purchasing alternative-fuel vehicles, and the majority of fleets chose FFVs.⁴⁶⁷ As a result of these two policy measures, there are over 7 million FFVs on the road today.⁴⁶⁸ These vehicles increase our nation’s ethanol consumption potential beyond what is capable with conventional vehicles. However, most FFVs are currently refueling on conventional gasoline (E0 or E10) due to limited E85 availability and the fact that E85 is

^{HHHHHH} Refer to Part II, Subparts A and B, Sections 15321 and 15331.

typically priced 20-30 cents per gallon higher than gasoline on an energy equivalent basis. As such, we are not currently tapping into the full ethanol consumption potential of our FFV fleet. However, we expect refueling patterns to change in the future under the proposed RFS2 program.

1.7.1.2 Increased Ethanol Use under RFS2

To meet the RFS2 standards, ethanol consumption will need to be much higher than both today's levels and those projected to occur absent RFS2. The Energy Information Administration (EIA) projected that under business-as-usual conditions, ethanol usage would grow to just over 13 billion gallons by 2022.⁴⁶⁹ This represents significant growth from today's usage; however, this volume of ethanol is capable of being consumed by today's vehicle fleet albeit with some fuel infrastructure improvements.ⁱⁱⁱⁱⁱⁱ Although EIA projected a small percentage of ethanol to be blended as E85 in 2022, 13 billion gallons of ethanol could also be consumed by displacing about 90% of our country's forecasted gasoline energy demand with E10. The maximum amount of ethanol our country is capable of consuming as E10 compared to the projected RFS2 ethanol volumes is shown below in Figure 1.7-2.

ⁱⁱⁱⁱⁱⁱ For more on distribution accommodations, refer to Section 1.6.

**Figure 1.7-2.^{JJJJJ}
Max E10 Ethanol Consumption Compared to RFS2 Requirements**

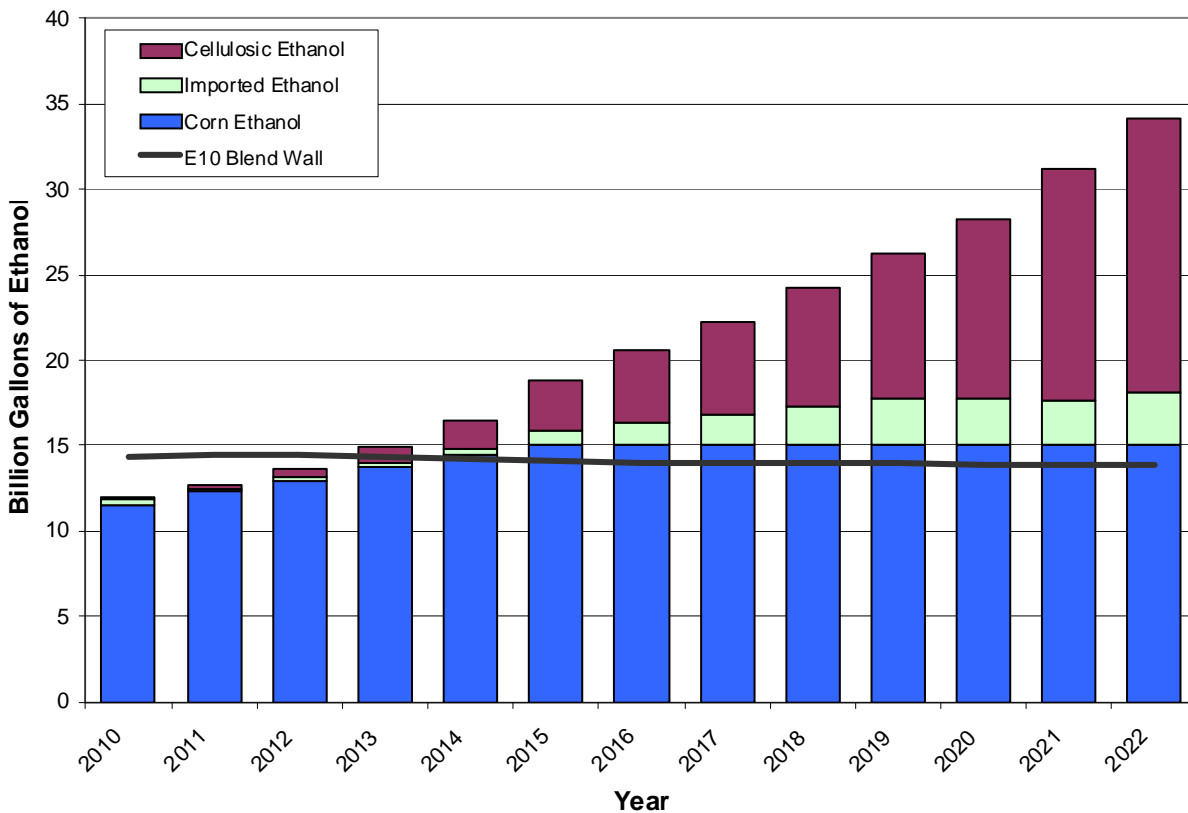

As shown in Figure 1.7-2, under the proposed RFS2 program, we are projected to hit the E10 “blend wall” of about 14-15 billion gallons by 2013. This volume corresponds to 100% E10 nationwide. However, if gasoline demand falls, or if E10 cannot get distributed nationwide, the nation could hit the blend wall sooner. Regardless, to get beyond the blend wall and consume more than 14-15 billion gallons of ethanol, we are going to need to see significant increases in the number FFVs on the road, the number of E85 retailers, and the FFV E85 refueling frequency. In the subsections that follow, we will highlight the variables that impact our nation’s ethanol consumption potential and, more specifically, what measures the market may need to take in order to consume 34 billion gallons of ethanol by 2022 (assuming the cellulosic biofuel standard and the majority of the advanced biofuel standard are met with ethanol).

As explained in Section 1.2, our primary RFS2 analysis focuses on ethanol as the main biofuel in the future. In addition, from an ethanol consumption standpoint, we have focused on an E10/E85 world. While E0 is capable of co-existing with E10 and E85 for a while, we assumed that E10 would replace E0 as expeditiously as possible and that all subsequent ethanol growth would come from E85. Furthermore, for our primary analysis, we assumed that no ethanol consumption would come from the mid-level ethanol blends (i.e., E15 or E20) as they are not currently approved for use in non-FFVs. However, based on public interest and a recent

^{JJJJJ} Based on AEO 2009 gasoline energy projections and the assumption that the cellulosic biofuel standard and the majority of the advanced biofuel standard would be met with ethanol.

waiver application submitted by Growth Energy, we will discuss the potential volume implications of mid-level ethanol blends in the subsections that follow.

We acknowledge that, if approved, mid-level ethanol blends could help the nation meet the proposed RFS2 volume requirements. First, non-FFVs could consume more ethanol per gallon of “gasoline”. This could result in greater ethanol consumption nationwide. In addition, mid-level blends could allow refiners to continue to price ethanol relative to gasoline (as it currently is for E10). For these reasons, it is possible that mid-level ethanol blends could help the nation get beyond the E10 blend wall. However, as explained in Section 1.6,11 there are numerous actions that would need to be taken to bring mid-level ethanol blends to market. In addition, mid-level ethanol blends alone (even if made available nationwide) are not capable of fulfilling the RFS2 requirements in later years. As explained in Section 1.7.1.3, we would essentially hit another blend wall 1-6 years later depending on the intermediate blend (i.e., E15 vs. E20), how quickly it could be brought to market, and how widely mid-level ethanol blends were distributed. Nevertheless, this time could be very valuable when it comes to expanding E85/FFV infrastructure and/or commercializing other non-ethanol cellulosic biofuels.

In summary, our primary analysis focuses on an E10/E85 world because mid-level ethanol blends are not currently approved for use in conventional gasoline vehicles and nonroad equipment.^{KKKKKK} As a sensitivity analysis, we have analyzed what might need to be done to bring mid-level ethanol blends to market (should a sub-sim waiver be granted) and the extent to which such blends could help our nation get beyond the E10 blend wall meet the RFS2 ethanol standards.

1.7.1.2.1 Projected Gasoline Energy Demand

The maximum amount of ethanol our country is capable of consuming in any given year is a function of the total gasoline energy demanded by the transportation sector. Our nation’s gasoline energy demand is dependent on the number of gasoline-powered vehicles on the road, their average fuel economy, vehicle miles traveled (VMT), and driving patterns. For analysis purposes, we relied on the gasoline energy projections reported by EIA in AEO 2008.^{LLLLLL} Unlike AEO 2007, AEO 2008 takes the fuel economy improvements set by EISA into consideration and also assumes a slight dieselization of the vehicle fleet. The result is a 15% reduction in the projected 2022 gasoline energy demand from AEO 2007 to AEO 2008.^{470,471} As shown in Figure 1.7-3, EIA basically has gasoline energy demand (petroleum-based gasoline plus ethanol) flattening out, and even slightly decreasing, as we move into the future and implement the EISA vehicle standards. The recently-published AEO 2009 shows a similar trend, but with a slightly lower overall energy demand.

^{KKKKKK} For more on the potential approval pathways for mid-level ethanol blends, refer to Section V.D.3.b of the Preamble.

^{LLLLLL} For subsequent blend wall discussions/graphs, we relied on the most recent AEO 2009 projections. However for our detailed ethanol consumption analysis presented in this section, we relied on AEO 2008. We adjusted the gasoline energy demand reported in AEO Table 2 to reflect lower heating values for ethanol. In AEO 2007, EIA used a higher heating value of 83,333 BTU/gal for ethanol and in AEO 2008, EIA used a higher heating value of 84,262 for ethanol. Our analyses were based on applying a lower heating value of 77,930 BTU/gal to represent denatured fuel-grade ethanol.

**Figure 1.7-3.
Forecasted Gasoline Energy Demand**

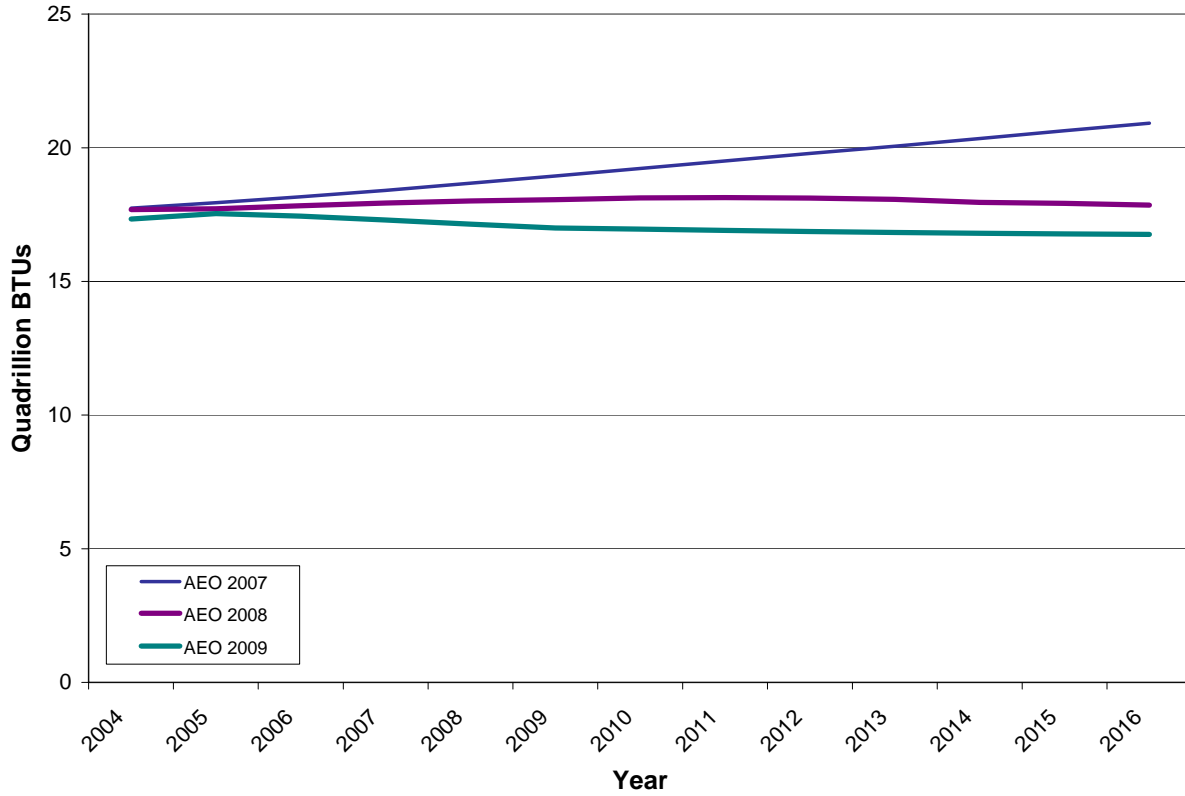

1.7.1.2.2 Projected Growth in Flexible Fuel Vehicles

According to DOE’s Department of Energy Efficiency and Renewable Energy, there are currently over 7 million FFVs on the road today capable of consuming E85.^{MMMMMM} And that number is growing steadily. Automakers are incorporating more and more FFVs into their light-duty production plans. While the FFV system (i.e., fuel tank, sensor, delivery system, etc.) used to be an option on some vehicles, most FFV producers are moving in the direction of converting entire product lines over to E85-capable systems. Still, the number of FFVs that will be manufactured and purchased in future years is uncertain. To reflect this uncertainty, we have analyzed multiple FFV production scenarios.^{NNNNNN} However, for our primary ethanol usage and cost analyses we have focused on the “Optimistic FFV Production Scenario” (described in more detail below). The other FFV production scenarios we considered are presented at the end of this subsection.

In response to the President Bush’s “20-in-10” plan of reducing American gasoline usage by 20% in 10 years, domestic automakers responded with aggressive FFV production goals.

^{MMMMMM} DOE Energy Efficiency and Renewable Energy August 2008 estimate (worksheet available at www.eere.energy.gov/afdc/data/index.html)

^{NNNNNN} We also analyzed multiple E85 access scenarios. For more information, refer to Section 1.7.1.2.3.

General Motors, Ford and Chrysler (referred to hereafter as “The Detroit 3”) announced plans to produce 50% FFVs by 2012.⁴⁷² Assuming that The Detroit 3 continue to maintain 50% marketshare and that total vehicle sales remain around 16 million per year, at least 4 million FFVs will be produced by the 2012 model year. Based on 2008 offerings, we assumed that approximately 80% of The Detroit 3’s FFV commitment would be met by light-duty trucks and the remaining 20% would be cars.^{473,000000} For analysis purposes, we also assumed that all the FFVs in existence today were produced by The Detroit 3 (and therefore share the same aforementioned FFV car/truck ratio) and that production would ramp up linearly beginning in 2008 to reach the 2012 commitment.^{PPPPPP}

Although non-domestic automakers have not made any official FFV production commitments, Nissan, Mercedes, Izuzu, and Mazda all included at least one flexible fuel vehicle in their 2008 model year offerings.⁴⁷⁴ And we anticipate that additional FFVs (or FFV options) will be added in the future. Ultimately, we predict that non-domestic FFV production could be as high as 25%, or about 2 million FFVs per year. While we are not forecasting an official FFV production commitment from the non-domestic automakers, we believe that this represents an aggressive, yet reasonable FFV production estimate for analysis purposes. Furthermore, based on current offerings, we assumed that the majority of non-domestic FFVs would be trucks, i.e., 100%. With respect to timing, we expect that the non-domestic automakers would ramp up FFV production later than The Detroit 3. For analysis purposes, we assumed that non-domestic automakers would ramp up FFV production beginning in 2013, and like The Detroit 3, it would take about five years for them to reach their FFV production goals (or in this case, the assumed 25% production level). For a summary of the year-by-year FFV production assumptions we made under the Optimistic FFV Production Scenario, refer to Table 1.7-3.

⁰⁰⁰⁰⁰⁰ Several of the FFV production assumptions may need to be revised for the FRM in light of recent events.

^{PPPPPP} As a simplifying assumption, we assumed that all FFVs in today’s fleet were produced by The Detroit 3 beginning in 2002.

**Table 1.7-3.
Optimistic FFV Production Scenario – FFV Production Assumptions**

Year	GM, Chrysler & Ford			Non-Domestic Automakers		
	Tot FFVs	FFV-Cars	FFV-Trucks	Tot FFVs	FFV-Cars	FFV-Trucks
2002	1,000,000	200,000	800,000	0	0	0
2003	1,000,000	200,000	800,000	0	0	0
2004	1,000,000	200,000	800,000	0	0	0
2005	1,000,000	200,000	800,000	0	0	0
2006	1,000,000	200,000	800,000	0	0	0
2007	1,000,000	200,000	800,000	0	0	0
2008	1,600,000	320,000	1,280,000	80,000	0	80,000
2009	2,200,000	440,000	1,760,000	160,000	0	160,000
2010	2,800,000	560,000	2,240,000	240,000	0	240,000
2011	3,400,000	680,000	2,720,000	320,000	0	320,000
2012	4,000,000	800,000	3,200,000	400,000	0	400,000
2013	4,000,000	800,000	3,200,000	720,000	0	720,000
2014	4,000,000	800,000	3,200,000	1,040,000	0	1,040,000
2015	4,000,000	800,000	3,200,000	1,360,000	0	1,360,000
2016	4,000,000	800,000	3,200,000	1,680,000	0	1,680,000
2017	4,000,000	800,000	3,200,000	2,000,000	0	2,000,000
2018	4,000,000	800,000	3,200,000	2,000,000	0	2,000,000
2019	4,000,000	800,000	3,200,000	2,000,000	0	2,000,000
2020	4,000,000	800,000	3,200,000	2,000,000	0	2,000,000
2021	4,000,000	800,000	3,200,000	2,000,000	0	2,000,000
2022	4,000,000	800,000	3,200,000	2,000,000	0	2,000,000

Based on these FFV production assumptions and forecasted vehicle phase-out, VMT, and fuel economy estimates provided by EPA’s MOVES Model, we calculate that the maximum percentage of fuel (gasoline/ethanol mix) that could feasibly be consumed by FFVs in 2022 would be about 30%.^{QQQQQ} The resulting gasoline energy consumption by vehicle type under the Optimistic FFV Production Scenario is shown below in Figure 1.7-4. For all analyses, we assumed that the percentage of gasoline energy consumed by nonroad, heavy-duty gasoline vehicles (HDGVs), and motorcycles would be about 8% based on historical information provided by DOE.⁴⁷⁵

^{QQQQQ} For more on the EPA MOVES Model, refer to Chapter 3 of this DRIA.

**Figure 1.7-4.
Optimistic FFV Production Scenario - Gasoline Consumption by Vehicle Type**

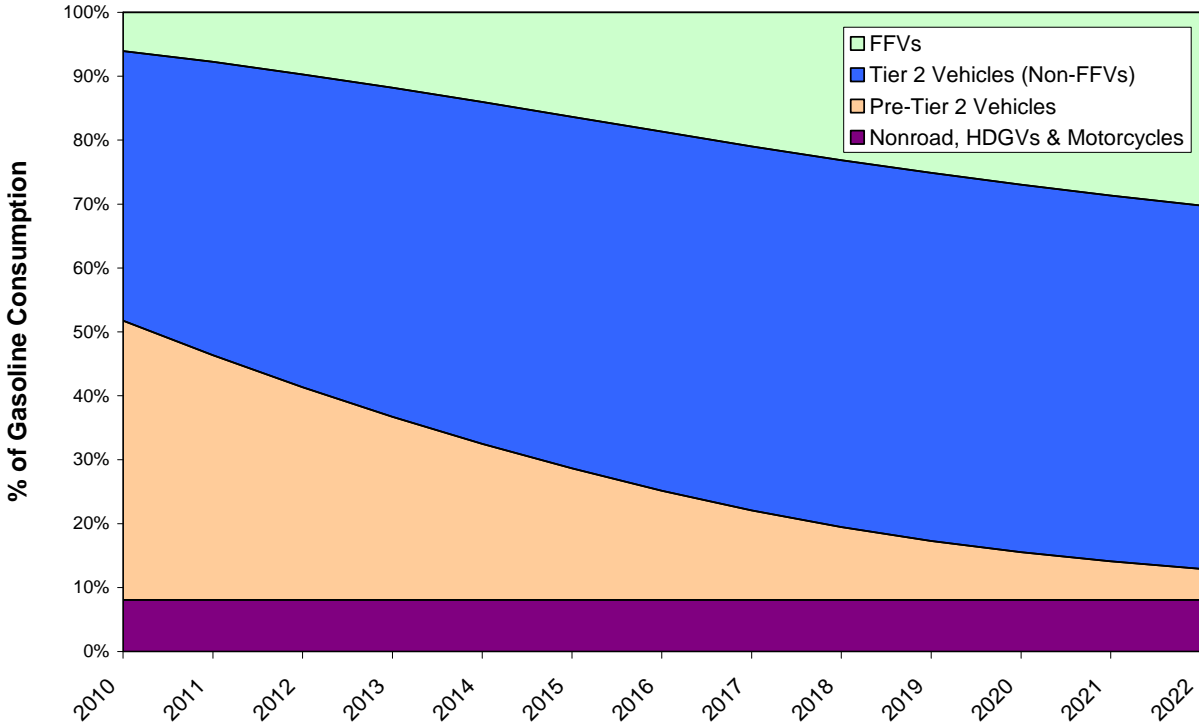

As mentioned above, the number of FFVs that will be produced in the future under the RFS2 rule is relatively unknown. However, to bracket the uncertainty, we have analyzed a less optimistic FFV production scenario as well as what FFV production might look like under a congressional mandate. Although EPA does not have the authority to require automakers to produce FFVs, there are a number of bills in Congress that are set out to do just that, e.g., The Open Fuel Standard Act of 2008.^{RRRRRR}

For the less optimistic production scenario (referred to hereafter as the “Committed FFV Production Scenario”), we considered what production might look like if only The Detroit 3 followed through with their 50% by 2012 FFV commitment. Under this scenario, we assumed the same Detroit 3 FFV production assumptions as in the Optimistic FFV Production scenario. However, we assumed that the non-domestic automakers would only produce the FFVs they are currently forecasting in their existing production plans. Based on 2008 MY offerings, we assumed that the non-domestic automakers would produce approximately 5% FFVs by 2012.⁴⁷⁶ For analysis purposes, we assumed that production would creep up beginning in 2008, and like the Optimistic FFV Production Scenario, and all non-domestic FFVs would be light-duty trucks.

^{RRRRRR} Refer to Senate Bill 3303 and House Rule 6559 discussed in more detail below.

For a summary of the year-by-year vehicle production assumptions we made under the Committed FFV Production Scenario, refer to Table 1.7-4.

**Table 1.7-4.
Committed FFV Production Scenario – FFV Production Assumptions**

Year	GM, Chrysler & Ford			Non-Domestic Automakers		
	Tot FFVs	FFV-Cars	FFV-Trucks	Tot FFVs	FFV-Cars	FFV-Trucks
2002	1,000,000	200,000	800,000	0	0	0
2003	1,000,000	200,000	800,000	0	0	0
2004	1,000,000	200,000	800,000	0	0	0
2005	1,000,000	200,000	800,000	0	0	0
2006	1,000,000	200,000	800,000	0	0	0
2007	1,000,000	200,000	800,000	0	0	0
2008	1,600,000	320,000	1,280,000	80,000	0	80,000
2009	2,200,000	440,000	1,760,000	160,000	0	160,000
2010	2,800,000	560,000	2,240,000	240,000	0	240,000
2011	3,400,000	680,000	2,720,000	320,000	0	320,000
2012	4,000,000	800,000	3,200,000	400,000	0	400,000
2013	4,000,000	800,000	3,200,000	400,000	0	400,000
2014	4,000,000	800,000	3,200,000	400,000	0	400,000
2015	4,000,000	800,000	3,200,000	400,000	0	400,000
2016	4,000,000	800,000	3,200,000	400,000	0	400,000
2017	4,000,000	800,000	3,200,000	400,000	0	400,000
2018	4,000,000	800,000	3,200,000	400,000	0	400,000
2019	4,000,000	800,000	3,200,000	400,000	0	400,000
2020	4,000,000	800,000	3,200,000	400,000	0	400,000
2021	4,000,000	800,000	3,200,000	400,000	0	400,000
2022	4,000,000	800,000	3,200,000	400,000	0	400,000

As expected, having fewer FFVs in the fleet translates to this group of vehicles having a lower gasoline/ethanol consumption potential. Based on the less optimistic FFV production assumptions (summarized above in Table 1.7-4) and forecasted vehicle phase-out, VMT, and fuel economy estimates provided by EPA’s MOVES Model, we calculate that the maximum percentage of fuel (gasoline/ethanol mix) that could feasibly be consumed by FFVs in 2022 would be about 24%. The resulting gasoline energy consumption by vehicle type under the Committed FFV Production Scenario is shown below in Figure 1.7-5.

**Figure 1.7-5.
Committed FFV Production Scenario - Gasoline Consumption by Vehicle Type**

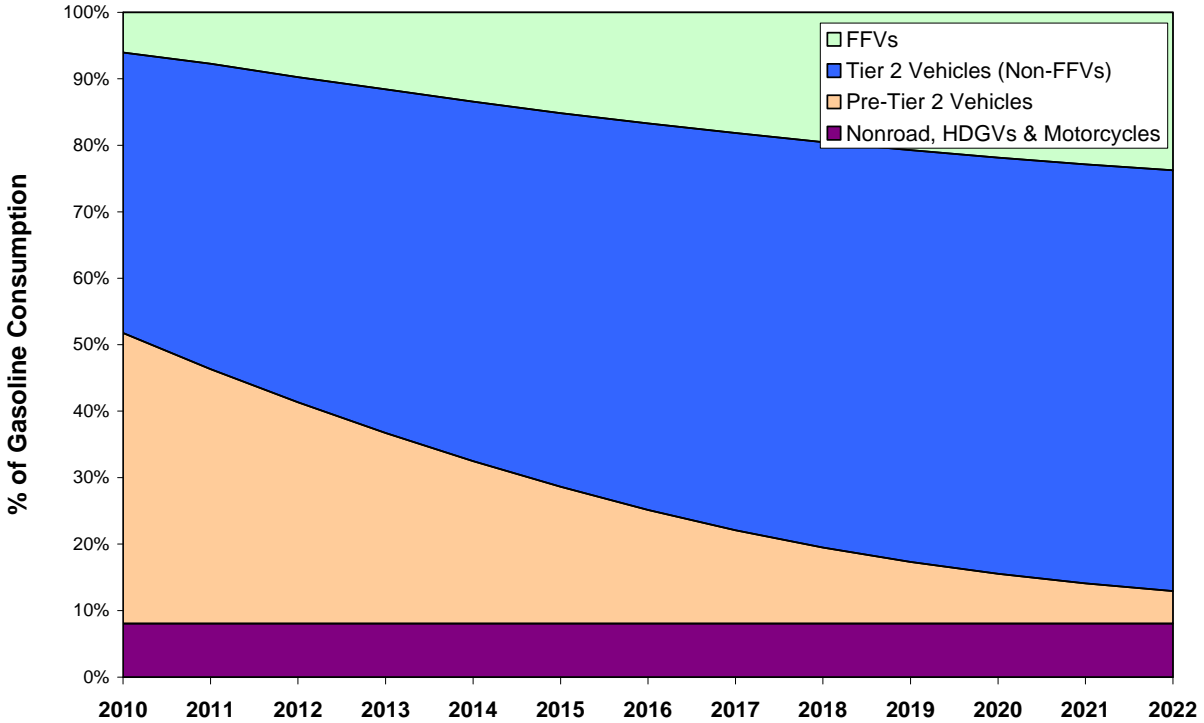

For our third and final FFV production scenario, we considered what FFV production might look like under some sort of Congressional mandate. At the time of our analysis, we were unaware of any formal legislation being considered by Congress. However, since that time there have been multiple bills introduced by Congress. On July 22, 2008 Senator Sam Brownback (R-KS) on behalf of himself and Senators Susan Collins (R-ME), Joseph Lieberman (I-CT), Ken Salazar (D-CO), and John Thune (R-SD) introduced the Open Fuel Standard Act of 2008, a bill that calls for 50% of the U.S. vehicle fleet to be FFVs capable of using high blends of ethanol or methanol (in addition to gasoline) by 2012. This number would grow to 80% by 2015.⁴⁷⁷ A similar FFV bill was introduced by Eliot Engel (D-NY) in the House on July 22, 2008.⁴⁷⁸

However, because our analysis was conducted before these bills were introduced, we had to come up with our own set of assumptions with respect to the number of FFVs and the implementation timeline under a theoretical mandate. Under our “Mandated FFV Production Scenario,” we considered the possibility that Congress could require all light-duty vehicles to be equipped with E85-capable fuel systems in the future. While we realize this is more aggressive than the mandates currently being considered by Congress, we believe this is a good upper bound for our ethanol usage analysis. Furthermore, we believe that such a mandate is feasible based on the lead-time required to engineer and implement the necessary vehicle fuel system changes.

Under our Mandated FFV Production Scenario, we assumed that the first phase of the FFV mandate could require all automakers to meet the production goals set by The Detroit 3 – 50% FFVs by 2012. From there, we assumed the mandated percentage could grow to 100% FFVs by 2015. This implementation timeline is consistent with Senate Bill 3303 and House Rule 6559 – the mandates currently being considered by Congress. For a summary of the year-by-year vehicle production assumptions we made under the Mandated FFV Production Scenario, refer to Table 1.7-5.

**Table 1.7-5.
Mandated FFV Production Scenario – FFV Production Assumptions**

Year	GM, Chrysler & Ford			Non-Domestic Automakers		
	Tot FFVs	FFV-Cars	FFV-Trucks	Tot FFVs	FFV-Cars	FFV-Trucks
2002	1,000,000	200,000	800,000	0	0	0
2003	1,000,000	200,000	800,000	0	0	0
2004	1,000,000	200,000	800,000	0	0	0
2005	1,000,000	200,000	800,000	0	0	0
2006	1,000,000	200,000	800,000	0	0	0
2007	1,000,000	200,000	800,000	0	0	0
2008	1,600,000	560,000	1,040,000	800,000	520,000	280,000
2009	2,200,000	770,000	1,430,000	1,600,000	1,040,000	560,000
2010	2,800,000	980,000	1,820,000	2,400,000	1,560,000	840,000
2011	3,400,000	1,190,000	2,210,000	3,200,000	2,080,000	1,120,000
2012	4,000,000	1,400,000	2,600,000	4,000,000	2,600,000	1,400,000
2013	5,333,333	1,866,667	3,466,667	5,333,333	3,466,667	1,866,667
2014	6,666,667	2,333,333	4,333,333	6,666,667	4,333,333	2,333,333
2015	8,000,000	2,800,000	5,200,000	8,000,000	5,200,000	2,800,000
2016	8,000,000	2,800,000	5,200,000	8,000,000	5,200,000	2,800,000
2017	8,000,000	2,800,000	5,200,000	8,000,000	5,200,000	2,800,000
2018	8,000,000	2,800,000	5,200,000	8,000,000	5,200,000	2,800,000
2019	8,000,000	2,800,000	5,200,000	8,000,000	5,200,000	2,800,000
2020	8,000,000	2,800,000	5,200,000	8,000,000	5,200,000	2,800,000
2021	8,000,000	2,800,000	5,200,000	8,000,000	5,200,000	2,800,000
2022	8,000,000	2,800,000	5,200,000	8,000,000	5,200,000	2,800,000

As expected, having more FFVs in the fleet results in these vehicles having a higher gasoline/ethanol consumption potential. Based on the mandated FFV production assumptions (summarized above in Table 1.7-5) and forecasted vehicle phase-out, VMT, and fuel economy estimates provided by EPA’s MOVES Model, we calculate that the maximum percentage of fuel (gasoline/ethanol mix) that could feasibly be consumed by FFVs in 2022 would be approximately 68%. The resulting gasoline energy consumption by vehicle type under the Mandated FFV Production Scenario is shown below in Figure 1.7-6.

**Figure 1.7-6.
Mandated FFV Production Scenario - Gasoline Consumption by Vehicle Type**

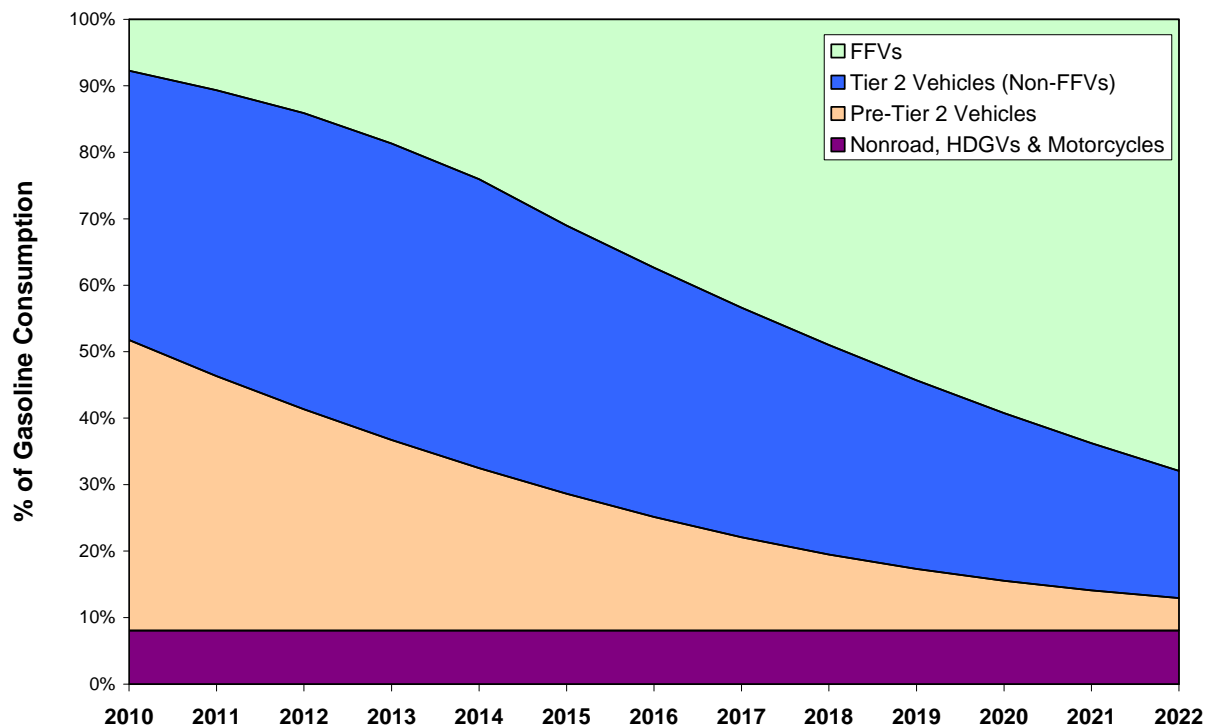

For analysis purposes, we assumed that all FFVs would be distributed homogeneously throughout the nation in future years. However, the reality is, FFVs may be more concentrated in certain areas of the country based on variation in regional product demand (and corresponding FFV offerings) and state-level FFV incentives. We plan to revisit this for the final rule and also consider the theoretical cost and refueling frequency impacts of co-locating FFVs with E85 stations. In the meantime, we acknowledge that there are a number of states offering incentives to get consumers to purchase alternative fuel vehicles (AFVs). The AFV incentives range from purchasing rebates to discounted registration fees and even free parking in certain metropolitan areas. According to a July 2008 assessment of DOE's Energy Efficiency and Renewable Energy (EERE) website, 13 states currently offer some form of AFV incentive.⁴⁷⁹ A summary of these states is provided in Table 1.7-6 below. There are also a number of federal vehicle fleets (e.g., the U.S. Postal Service) and state government fleets (e.g., police departments) that require the purchase AFVs.

**Table 1.7-6.
Alternative Fuel Vehicle Incentives**

Region	States
PADD 1	GA, NC, SC, VT
PADD 2	IL, IN, KS, NE
PADD 3	LA, NM
PADD 4	MT
PADD 5	CA, OR

1.7.1.2.3 Projected Growth in E85 Access

According to the National Ethanol Vehicle Coalition (NEVC), there are currently over 1,900 retailers offering E85 in 45 states plus the District of Columbia.⁴⁸⁰ While this represents significant industry growth, it still only translates to about 1% of U.S. retail stations nationwide carrying the fuel.^{SSSSSS,481} As a result, most FFV owners clearly do not have reasonable access to E85. For our FFV/E85 analysis, we have defined “reasonable access” as one-in-four pumps offering E85 in a given area.^{TTTTTT} Accordingly, just over 4% of the nation currently has reasonable access to E85, up from 3% in 2007 (based on a mid-year NEVC E85 pump estimate).^{UUUUUU,482}

There are a number of states promoting E85 usage by offering FFV/E85 awareness programs and/or retail pump incentives. There are also a growing number of states offering infrastructure grants to help expand E85 availability. According to a July 2008 assessment of DOE’s Energy Efficiency and Renewable Energy (EERE) website, 26 states currently offer some form infrastructure grant for facilities that bring biofuels, including E85 to market.⁴⁸³ A summary of these state programs is provided in Table 1.7-7 below.

^{SSSSSS} Based on the assumption that there were 1,733 E85 stations (number reported by NEVC on August 25, 2008) and 164,292 total gas stations (number reported by National Petroleum News in October 2007).

^{TTTTTT} For a more detailed discussion on how we derived our one-in-four reasonable access assumption, refer to Section 1.6. For the distribution cost implications as well as the cost impacts of assuming reasonable access is greater than one-in-four pumps, refer to Section 4.2.

^{UUUUUU} Computed as percent of stations with E85 (1,733/164,292 as of Aug 25, 2008 or 1251/164292 as of July 2007) divided by 25 % (one-in-four stations).

**Table 1.7-7.
States Offering E85 Infrastructure Support**

Region	States
PADD 1	FL, ME, NY, NC, PA, SC
PADD 2	IL, IN, IA, KS, KY, MI, MN, NE, ND, OH, OK, SD, TN
PADD 3	AR, NM
PADD 4	CO, ID
PADD 5	CA, OR, WA

In addition, nine Midwest states have adopted a progressive Energy Security and Climate Stewardship Platform.⁴⁸⁴ As of June 2008, Indiana, Iowa, Kansas, Michigan, Minnesota, North Dakota, Ohio, South Dakota, and Wisconsin had all committed to program which emphasizes energy independence through the growth of E85 availability (as well as cellulosic ethanol production). The platform includes a Regional Biofuels Promotion Plan with a goal of making E85 available at one third of all stations by 2025. In addition, on July 31, 2008, Congresswoman Stephanie Herseth Sandlin (D-SD) and John Shimkus (R-IL) introduced a legislative proposal that would increase the existing federal income tax credit from \$30,000 or 30% of the total cost of improvements to \$100,000 or 50% of the total cost of needed alternative fuel equipment and dispensing improvements.⁴⁸⁵ This legislation was recently reintroduced on March 26, 2009. While not signed into law, such a tax credit could provide a significant retail incentive to expand E85 infrastructure.

Given the growing number of state infrastructure incentives and the proposed Federal alternative fuel infrastructure subsidy, it is clear that E85 infrastructure will continue to expand in the future under the RFS2 program. However, the extent to which nationwide E85 access will grow is difficult to predict, let alone quantify. To represent practical yet aggressive station growth, we considered the possibility that 70% of the nation could have reasonable access to E85 by 2022. This is roughly equivalent to all urban areas in the United States offering reasonable (one-in-four-station) access to E85. For this analysis, we have defined “urban” areas as:

- The top 150 metropolitan statistical areas according to the U.S. Census Bureau and/or counties with the highest 150 VMT projections according the EPA MOVES model.
- Federal RFG areas
- Winter oxy-fuel areas
- Summertime low-RVP areas
- Other relatively populated cities in the Midwest. Cities with populations greater than 100,000 people in states with a projected ethanol surplus in 2022. [For more information on ethanol production, refer to Sections 1.5.1 through 1.5.3 of the DRIA.]

For an illustration of the urban areas representing about 70% of the nation’s VMT, refer to Figure 1.7-7.

**Figure 1.7-7.
A Look at 70% E85 Access - Concentrating Pumps in Urban Areas**

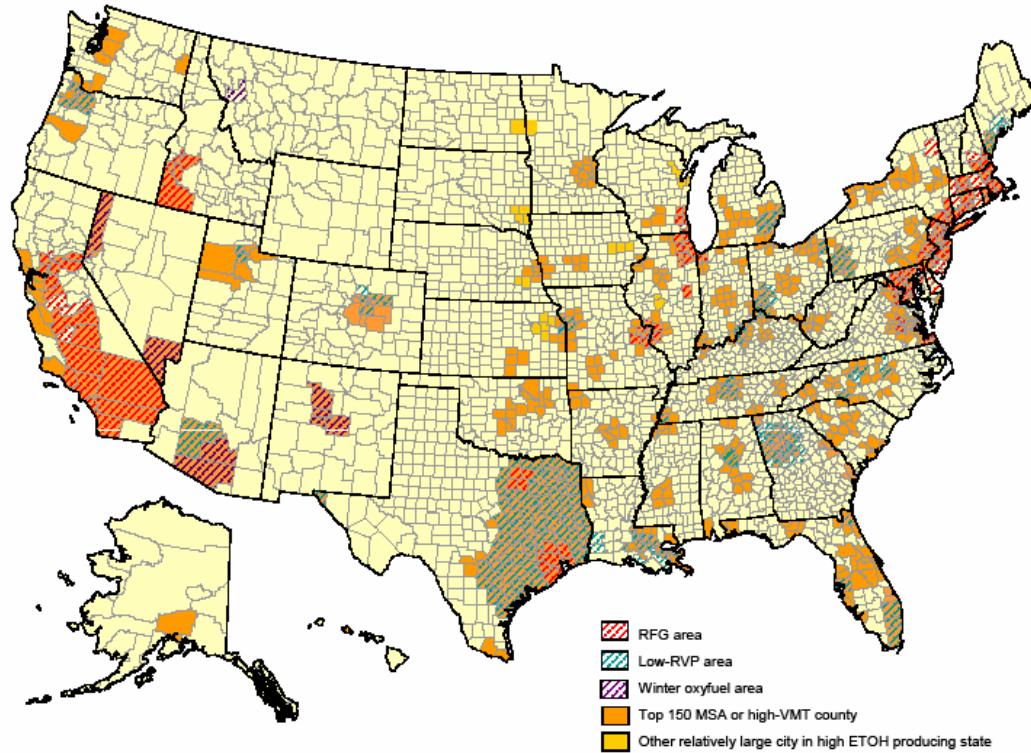

We are not concluding that E85 would only be offered in urban areas in the future. In fact, most E85 stations are currently located in the Midwest. However, we believe that this would be one possible way to provide 70% of the population with reasonable access to E85. From a fuel price standpoint, it makes sense that E85 might be offered in areas of the country with relatively high gasoline prices (e.g., RFG and low-RVP areas). Additionally, from an infrastructure cost standpoint, it makes sense that E85 might be offered in more populated metropolitan areas with high gasoline throughput.^{vvvvvv} For more on retail distribution costs, refer to Section 4.2 of this DRIA.

^{vvvvvv} We acknowledge that land costs, spatial limitations, and air quality/regulations could potentially restrict E85 growth in densely populated metropolitan areas. However, for analysis purposes, we assumed that it would be possible for one-in-four stations to offer E85 to provide FFV owners with reasonable access to the fuel.

Accordingly, for our primary analysis, we assumed that the percentage of the country with reasonable access to E85 could grow to 70% by 2022. This translates to about 29,000 retailers offering E85, or about 1:6 stations nationwide.^{wwwwwww} According to our distribution assessment, we believe it's possible to bring this many stations to market by 2022. And furthermore, our analysis indicates that 29,000 stations are capable of dispensing 29 billion gallons of E85 – the volume required to meet the RFS2 standard in 2022 in an E10/E85 world. For more information on E85 retail accommodations and fuel volumes required under RFS2, refer to Sections 1.6.10 and 1.7.1.4, respectively.

If we assume that reasonable E85 access grows to 70% by 2022, we can iteratively compute the corresponding nationwide E0 and E10 access assuming that a.) each fuel retailer only carries one type of conventional gasoline (E0 or E10) and b.) the nation does not exceed the RFS2 ethanol volume requirements presented in Section 1.2. Under the most aggressive FFV production scenario, we estimate that E0 could theoretically remain in existence until 2016 as shown below in Figure 1.7-8. However, we anticipate that E10 will likely replace E0 sooner based on current market trends.

**Figure 1.7-8.
Assumed Phase-Out of E0 and Phase-In of E10 & E85**

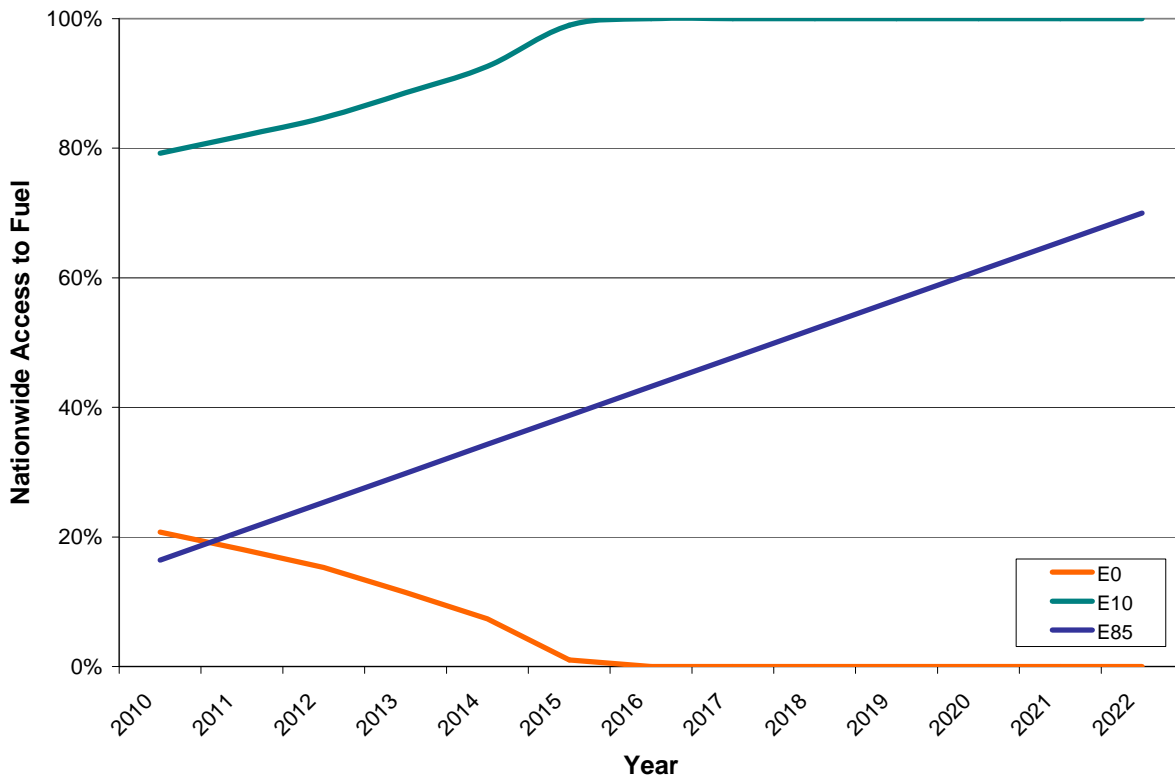

^{wwwwwww} Computed as the number of U.S. gas stations (164,292) times the percent of stations with reasonable access to E85 by 2022 (70%) times the definition of reasonable access (1-in-4 stations or 25%)

As an upper bound, we considered the possibility that reasonable one-in-four E85 access could theoretically grow to 100% by 2022. While we do not believe this is very likely (after all, diesel fuel - a required fuel for compression engines is only offered at about one-third of stations nationwide), this is a meaningful sensitivity analysis because it corresponds to the maximum E85 retail costs under the RFS2 program (for more on E85 infrastructure costs, refer to Section 4.2 of the DRIA). For both E85 access scenarios, we assumed a linear phase-in from today's estimated 4% access level as shown in Figure 1.7-9.

Figure 1.7-9.
Estimated Growth in E85 Access under RFS2

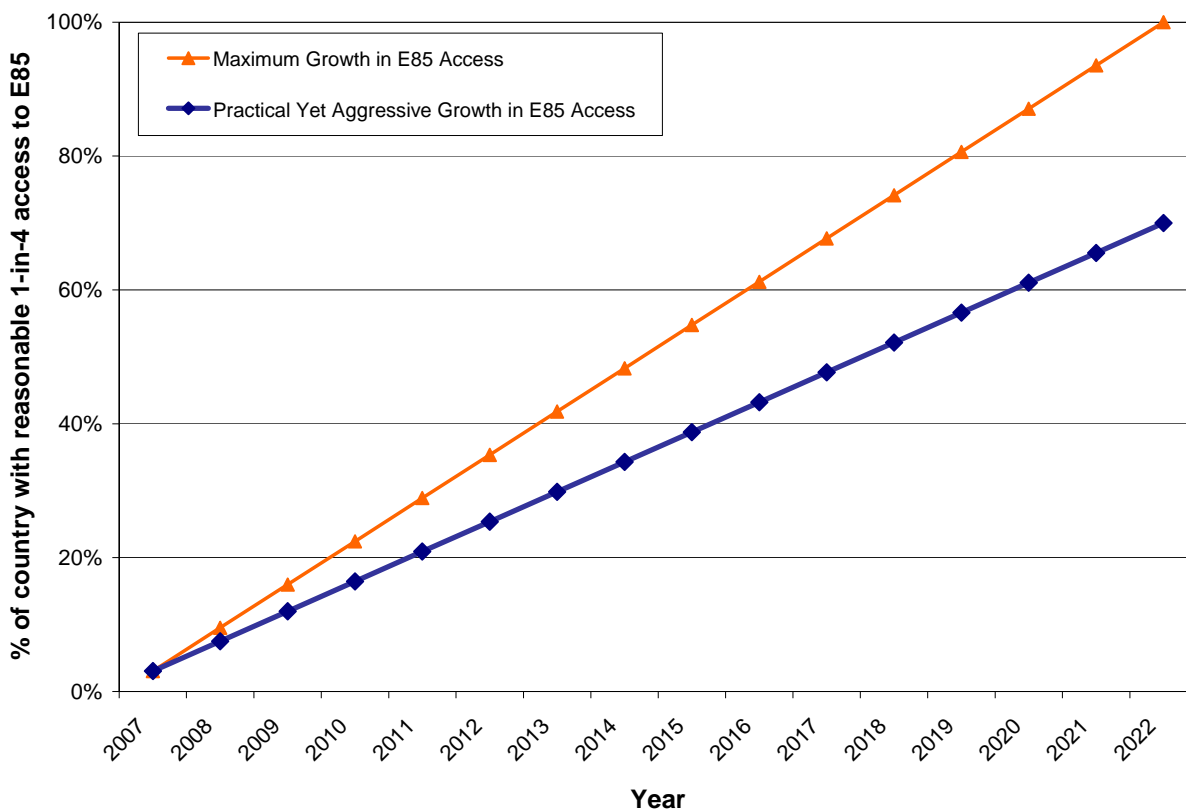

1.7.1.2.4 Required Increase in E85 Refueling Rates

As mentioned above, there were approximately 7 million FFVs on the road in 2008. If all FFVs refueled on E85 100% of the time, this would translate to about 6.5 billion gallons of E85 use. This estimate is based on the assumption that FFV owners travel approximately 12,000 miles per year and get about 18 miles per gallon during actual in-use driving conditions.^{XXXXXX} This estimate also assumes that it takes about 1.3 gallons of E85 for an FFV to travel the same distance as a gallon of gasoline due to the difference in energy density of the fuels.^{YYYYYY}

^{XXXXXX} Based on the assumption that 20% of FFVs are cars (27 MPG) and 80% are trucks (20.7 MPG) and the assumption that all vehicles/FFVs achieve about 80% of the rated fuel economy under real driving conditions.

^{YYYYYY} Based on our assumption that denatured ethanol has an average lower heating value of 77,930 BTU/gal and conventional gasoline (E0) has average lower heating value of 115,000 BTU/gal. And based on EIA's AEO 2008

Although we computed the theoretical E85 usage potential to be around 6.5 billion gallons in 2007, actual E85 usage was only reported to be around 12 million gallons in 2008.^{ZZZZZ} This means that, on average, FFV owners were only tapping into about 0.2% of their vehicles' E85/ethanol usage potential last year. Assuming that only 4% of the nation had reasonable one-in-four access to E85 in 2008 (as discussed above in Section 1.7.1.2.3), this equates to an estimated 5% E85 refueling frequency for those FFVs that had reasonable access.

There are several reasons for today's low E85 refueling frequency in areas of the country with reasonable access to the fuel. For starters, many FFV owners may not know they are driving a vehicle that is capable of handling E85. As mentioned above, more and more automakers are starting to produce FFVs by engine/product line, e.g., all 2008 Chevy Impalas are FFVs.^{AAAAAAA486} Consequently, consumers (especially brand loyal consumers) may inadvertently buy a flexible fuel vehicle without making a conscious decision to do so. And without effective consumer awareness programs in place, these FFV owners may never think to refuel on E85. In addition, FFV owners with reasonable access to E85 and knowledge of their vehicle's E85 capabilities may still not choose to refuel on E85. They may feel inconvenienced by the increased E85 refueling requirements. Based on its lower energy density, FFV owners will need to stop to refuel 21% more often when filling up on E85 over E10 (and likewise, 24% more often when refueling on E85 over conventional gasoline).^{BBBBBBB} In addition, some FFV owners may be deterred from refueling on E85 out of fear of reduced vehicle performance or just plain unfamiliarity with the new motor vehicle fuel. However, as we move into the future, we believe the biggest determinant will be price – whether E85 is priced competitively with gasoline based on its reduced energy density and the fact that you need to stop more often, drive a little further to find an E85 station, and depending on the retail configuration, wait in longer lines to fill up on E85.

To comply with the proposed RFS2 program and consume 34 billion gallons of ethanol by 2022, not only would we need more FFVs and more E85 retailers, we would need to see a significant increase in the current FFV E85 refueling frequency. Under the Optimistic FFV Production Scenario (assuming practical growth in E85 access), our analysis suggests that FFV owners with reasonable one-in-four access to E85 would need to fill up on it 74% of the time in 2022 - a significant increase from today's estimated 11% refueling frequency. As shown below in Figure 1.7-10, with fewer FFVs in the fleet, the E85 refueling frequency would need to be even higher. Similarly, with more FFVs in the fleet, the E85 refueling frequency could be lower and still meet the proposed RFS2 requirements. However, even with an FFV mandate, our analysis suggests that we would need to see an increase from today's FFV E85 refueling frequency. As expected, if the E85 access were to grow beyond 70% to 100% by 2022 (refer to dashed lines in Figure 1.7-10) the required refueling rates would be lower. However, based on

report, E85 was assumed to contain 74 vol% ethanol and 26 vol% gasoline on average. Our analysis ignores the potential that there could be a thermal efficiency improvement when vehicles burn ethanol.

^{ZZZZZ} EIA Annual Energy Outlook 2008, Table 17.

^{AAAAAAA} Refers to all mass produced 3.5 and 3.9L Chevy Impalas. However, it is our understanding that consumers may still place special orders for non-FFVs.

^{BBBBBBB} Based on our assumption that denatured ethanol has an average lower heating value of 77,930 BTU/gal and conventional gasoline (E0) has average lower heating value of 115,000 BTU/gal. For analysis purposes, E10 was assumed to contain 10 vol% ethanol and 90 vol% gasoline. Based on EIA's AEO 2008 report, E85 was assumed to contain 74 vol% ethanol and 26 vol% gasoline on average.

the cost to bring E85 to market, it is unlikely that retailers would invest in more E85 stations than what is necessary to meet the RFS2 program. For more information on E85 infrastructure costs, refer to Section 4.2 of this DRIA.

Figure 1.7-10. ^{CCCCCCC}
FFV E85 Refueling Rates Needed to Meet the RFS2 Requirements

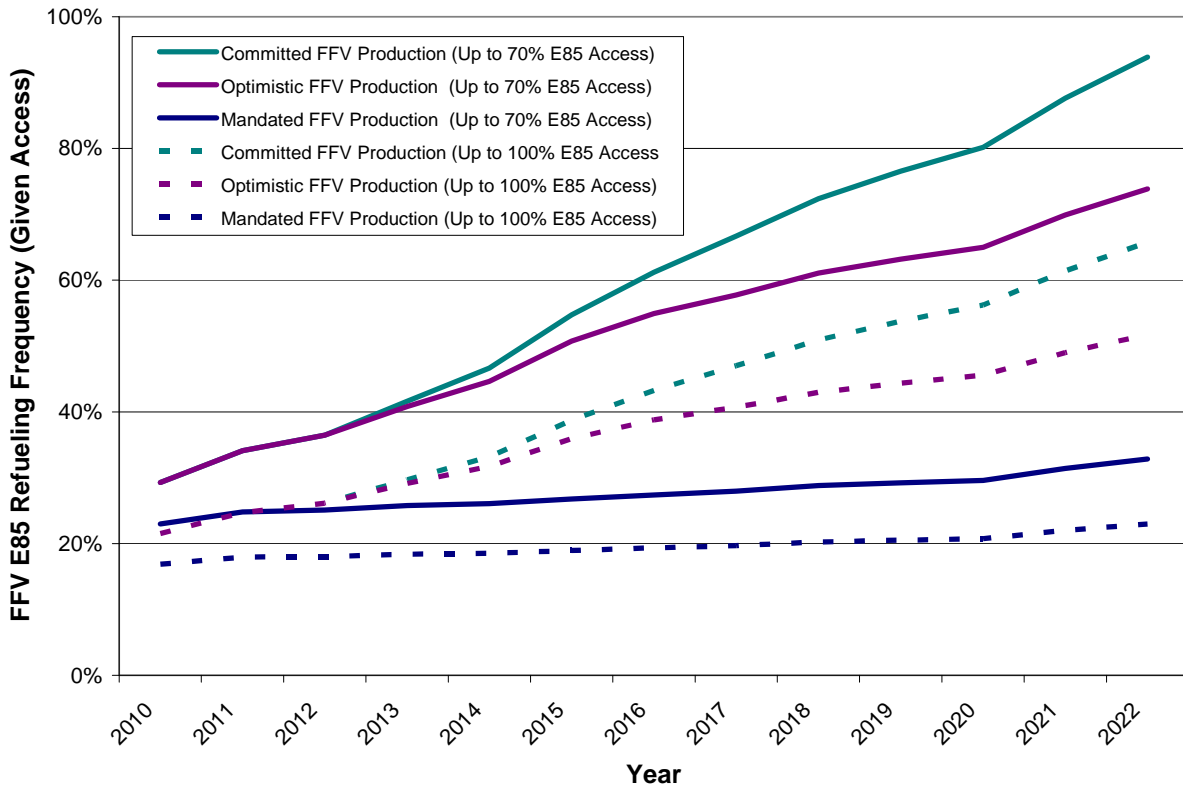

As shown in Figure 1.7-10, all analyzed FFV production and E85 access scenarios would require an increase from today’s 5% E85 refueling frequency. In order for this to be possible, we believe there will need to be an improvement in the current E85/gasoline price relationship.

1.7.1.2.5 Market Pricing of E85 Versus Gasoline

According to an online fuel price survey, E85 is currently priced almost 30 cents per gallon higher than conventional gasoline on an energy-equivalent basis.⁴⁸⁷ To increase our nation’s E85 refueling frequency to the levels described above, E85 needs to be priced competitively with (if not lower than) conventional gasoline based on its reduced energy content, increased time spent at the pump, and its limited availability. To quantify the required price differential, we started by examining 2006 gasoline price data. According to EIA’s 2006 Petroleum Marketing Annual, gasoline was priced at \$2.12 per gallon (average of all grades) at retail before taxes.⁴⁸⁸ Applying the American Petroleum Institute’s estimated gasoline tax of

^{CCCCCCC} Based on AEO 2008 projected gasoline energy demand.

45.5 cents per gallon (average state plus federal taxes), this put retail gasoline around \$2.58 per gallon in 2006.⁴⁸⁹ This is slightly higher than today's gasoline prices, but a reasonable indicator of what prices could look like in the future based on AEO 2008 forecasted crude oil prices (refer to Table 1.7-8).

**Table 1.7-8.
EIA Forecasted Imported Crude Oil Prices**

Year	Projected Crude Oil Price (\$/bbl)	Change Relative to 2006 Price (%)
2006	66.02	
2007	67.05	1.6%
2008	83.59	26.6%
2009	76.96	16.6%
2010	74.03	12.1%
2011	71.20	7.9%
2012	68.38	3.6%
2013	65.61	-0.6%
2014	62.72	-5.0%
2015	59.85	-9.3%
2016	56.96	-13.7%
2017	57.11	-13.5%
2018	57.99	-12.2%
2019	58.91	-10.8%
2020	59.70	-9.6%
2021	60.56	-8.3%
2022	61.47	-6.9%

Source: AEO 2008, Table 12. Imported Low-Sulfur Light Crude Oil Price.

In order for E85 to be priced competitively with conventional gasoline (assumed to be E10 by 2022), first it would need to be priced lower based on its reduced energy density.^{DDDDDD} As shown below, E85 is 79 percent as energy dense as E10.

$$\frac{E85EnergyDensity}{E10EnergyDensity} = \frac{0.74 * 77,930BTU / gal + 0.26 * 115,000BTU / gal}{0.10 * 77,930BTU / gal + 0.90 * 115,000BTU / gal} = 0.79$$

Accordingly, E85 should be priced at least 21% lower at retail to compensate. This means that E85 would need to be priced at least 54 cents less than \$2.58 per gallon gasoline. However, we also need to take the value of FFV owners' time into consideration because they could be spending 21% more time at the pump if they are refueling exclusively on E85. In the U.S., a person's time is currently valued at around \$30 per hour. This value of time (VOT) estimate was

^{DDDDDD} Denatured ethanol was assumed to have a lower heating value of 77,930 BTU/gal and conventional gasoline (E0) was assumed to have an average lower heating value of 115,000 BTU/gal. E10 was assumed to contain 10 vol% denatured ethanol and 90 vol% gasoline and E85 was assumed to contain 74 vol% denatured ethanol and 26 vol% gasoline on average (based on EIA's AEO 2008 report).

based on an average of values identified in a review of economics literature and is consistent with 2005 Brownstone and Small VOT estimates.⁴⁹⁰ Assuming it takes about six minutes for a 15-gallon refill, E85 needs to be priced an additional \$0.04 per gallon less than E10.

Finally, we accounted for the fact that, as an alternative fuel, it is unlikely that E85 will ever be available nationwide. As mentioned above in Section 1.7.1.2.3, we project that E85 will only be available at one-in-four stations in 70% of the country by 2022 (under our primary, practical maximum scenario). And unlike diesel fuel, FFV owners are not required to fill up on it. So in order to get consumers to want to refuel on E85 over gasoline, there needs to be an additional price incentive at the pump according to a 1997 Oakridge National Lab report.^{EEEEEE,491} As shown below in Figure 1.7-11, if an alternative fuel is only available at 25% of stations and you want people to refuel on it about 74% of the time (refer to Section 1.7.1.2.4), it needs to be given a 21 cent per gallon price advantage (1997\$). Inflating the 1997 David Greene estimate to 2006 dollars, E85 would need to be priced an additional 26 cents per gallon lower than E10. For a breakdown of the required E85 price advantage by program year (after the E10 blend wall), refer to Table 1.7-9.

Figure 1.7-11.
Required Price Incentive for Alternative Fuels with Limited Availability

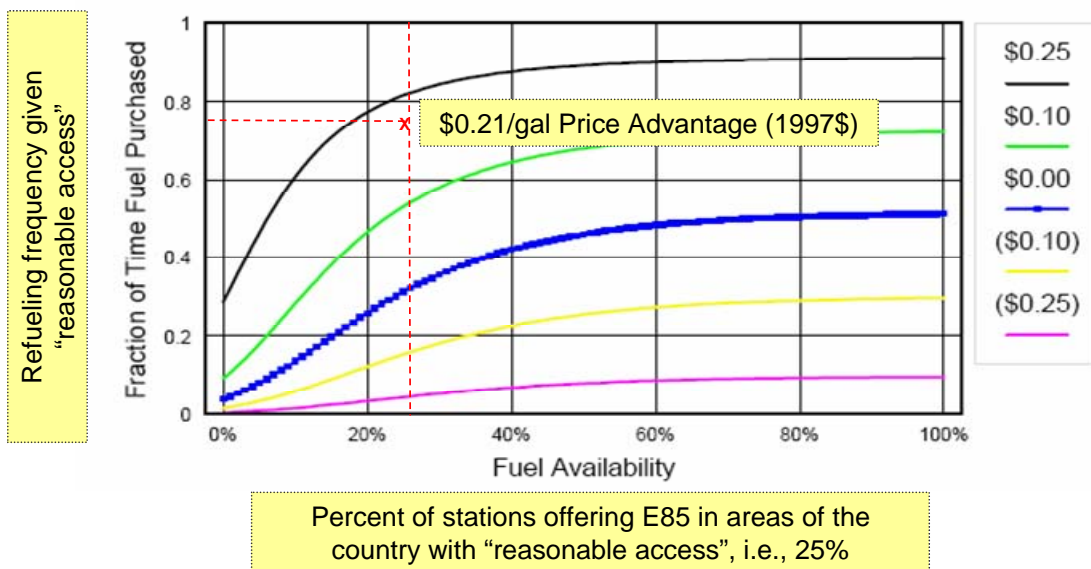

^{EEEEEE} Although the 1997 David Greene study was based on asking consumers about a hypothetical fuel that “works just as well as gasoline”, we assumed that Figure 6 from the report (pictured above) could also be used to determine the retail price incentive given to E85 to account for its limited availability. As explained in the preceding text, this was in addition to the incentives assigned to E85 to account for its reduced energy density and additional time spent at the pump.

**Table 1.7-9.
E85 Limited Availability Price Advantage by Program Year**

Year	Required E85 Refueling Freq	Required Price Advantage	
		1997\$	2006\$*
2013	41%	\$0.05	\$0.06
2014	45%	\$0.06	\$0.08
2015	51%	\$0.09	\$0.11
2016	55%	\$0.11	\$0.14
2017	58%	\$0.13	\$0.16
2018	61%	\$0.14	\$0.18
2019	63%	\$0.15	\$0.19
2020	65%	\$0.17	\$0.21
2021	70%	\$0.19	\$0.24
2022	74%	\$0.21	\$0.26

*Computed using U.S. Department of Labor Inflation Calculator
http://www.bls.gov/data/inflation_calculator.htm

To conclude, our price analysis suggests that E85 would need to be priced around \$1.74 per gallon at retail, or about a third lower than \$2.58/gal gasoline in order for consumers to refuel on it 74% of the time in 2022. As expected, higher crude oil prices could make E85 look slightly more attractive. However, there would still need to be a strong E85 price incentive at the pump in order for consumers to want to choose it. Similarly, there would need to be a marked price advantage at the terminal level in order for refiners to want to blend E85 (given transportation costs, taxes, and marketing/other costs at retail). The ethanol and respective corn break-even prices for varying crude oil prices are shown below. Figure 1.7-12 shows the projected break-even prices in 2013 (at the E10 blend wall) while Figure 1.7-13 shows the projected break-even prices in 2022. As shown below, the more ethanol that needs to be blended as E85 under RFS2, the less valuable it is to refiners.

Figure 1.7-12.
2013 Ethanol & Corn Break-Even Prices for Selling Ethanol as E85

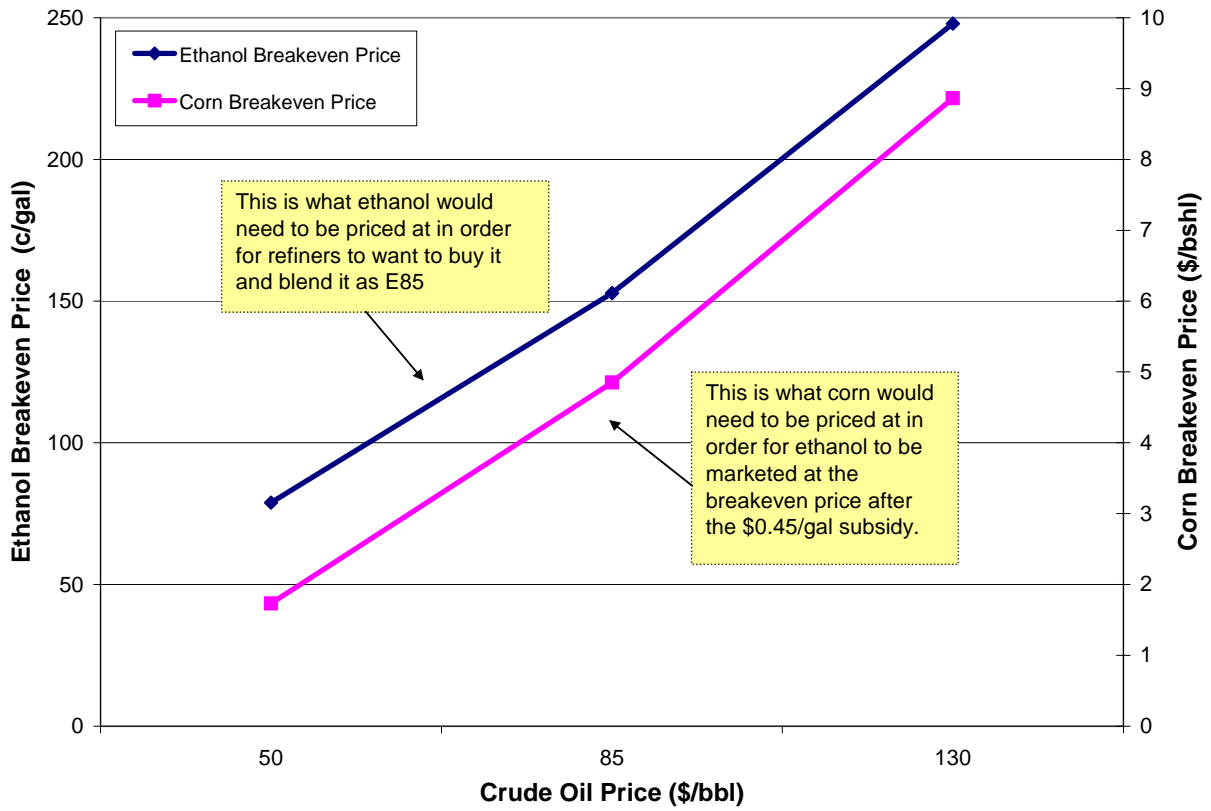

**Figure 1.7-13.
2022 Ethanol & Corn Break-Even Prices for Selling Ethanol as E85**

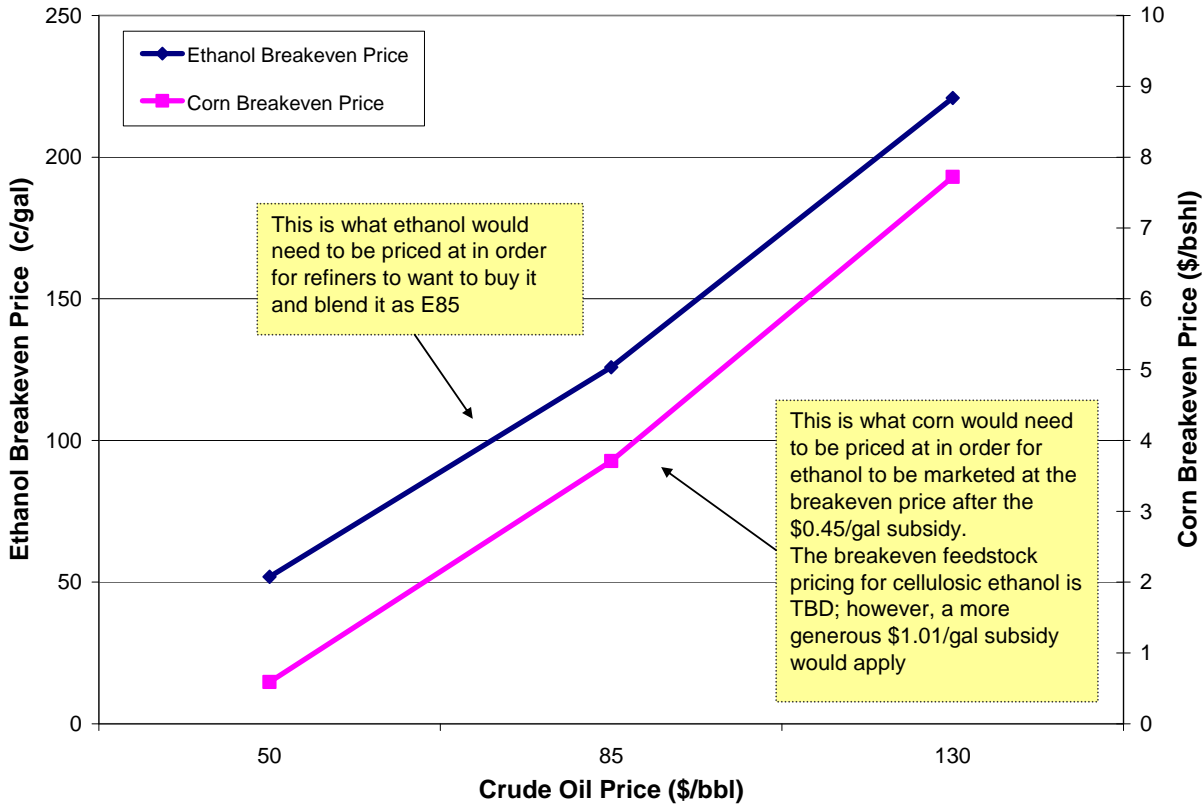

It is worth noting that these are the theoretical ethanol and corn breakeven prices based on what consumers should theoretically be willing to pay for E85 at retail. However, it is possible that the average consumer might be willing to pay more for E85. According to earlier discussions with petroleum retailers, E85 has to be priced at least 20% lower than gasoline today in order for consumers to refuel on it.⁴⁹² This is smaller than the 33% price differential we computed above. However, as mentioned earlier in Section 1.7.1.2.4, we expect also expect consumers motivations for filling up on E85 to shift more towards price in the future when large volumes of ethanol need to be consumed under RFS2. For more information on gasoline/ethanol costs, refer to Section 4.4.

We are aware of the challenges and coordinated efforts that would be required on the part of automakers, gasoline retailers, and FFV owners to get beyond the E10 blend wall. We also acknowledge that achievement of the proposed RFS2 standards is not necessarily limited to actions taken by regulated parties. However, automakers have already begun investing in FFVs and there are more and more E85-capable vehicles being announced each year. Furthermore, more than half of U.S. gasoline retail outlets are “branded” stations that are either owned by or affiliated with refining companies.⁴⁹³ As such, many retailers will have a vested interest in bringing E85 to market and pricing the fuel so that it is attractive to consumers. Although the potential compliance strategies outlined in this DRIA are aggressive, we believe they are feasible

if the right market incentives are put in place. In addition, we have also considered how mid-level ethanol blends might help the nation breach the blend wall.

1.7.1.3 The Impact of Mid-Level Ethanol Blends (E15/E20)

For our primary ethanol usage analysis, we considered that there would only be two fuels in the future, E10 and E85. And as demonstrated above, we show that it is feasible to consume 34 billion gallons of ethanol by 2022 given growth in FFV production and E85 availability and projected improvements in the current E10/E85 price relationship.

However, as explained in Section V.D.3.b of the Preamble, several organizations and government entities are interested in pursuing mid-level ethanol blends for use in the increasing the concentration of ethanol beyond the current 10% limit in the commercial gasoline pool. On March 6, 2009, Growth Energy and 54 ethanol manufacturers submitted an application for a waiver of the prohibition of the introduction into commerce of certain fuels and fuel additives set forth in section 211(f) of the Act. This application seeks a waiver for ethanol-gasoline blends of up to 15% by volume ethanol. The statute directs the Administrator of EPA to grant or deny this application within 270 days of receipt by EPA, in this instance December 1, 2009. EPA recently issued a federal register notice announcing receipt of the Growth Energy waiver application and soliciting comment on all aspects of it. Refer to 74 FR 18228 (April 21, 2009).

Although EPA has not yet made a waiver determination, as a sensitivity analysis, we considered the implications that adding E15 or E20 to the marketplace could have on ethanol usage and supporting fuel infrastructure should such blends be permitted. For each case, we assumed that E10 would need to continue to remain in existence to meet the demand of legacy vehicle and non-road engine owners. We assumed that Tier 2 vehicles could handle up to 20 percent ethanol blends (i.e., E15 or E20) and flex fuel vehicles could handle up to E85 (if available) as shown in Table 1.7-10.

**Table 1.7-10.
Mid-Level Ethanol Blends Vehicle/Engine Assumptions**

Gasoline Vehicle/Engine Classification	Maximum ETOH Threshold
Nonroad, HDGVs & Motorcycles	Up to 10%
Pre-Tier 2 "Legacy" Vehicles	Up to 10%
Tier 2 Vehicles	Up to 20%*
Flex Fuel Vehicles (FFVs)	Up to 85%
^a Contingent upon vehicle test program and waiver approval	

Although Tier 2 and flex-fuel vehicles would not be reliant on E10 in a mid-level ethanol blends world, we believe that maintaining E10 (for all vehicles/engines) would be beneficial in providing consumer choice. Experience in past fuel programs suggests that many consumers will not be comfortable refueling on higher ethanol blends and will blame any problems that may occur on the new fuel (regardless of the actual cause of the vehicle problems) causing a backlash

against the new fuel requirements. Therefore, we believe that the marketplace will continue to allow consumers the choice between mid-level ethanol blends and conventional gasoline (E10) even if a waiver were to be granted for all vehicles and engines.

For our optimistic mid-level ethanol blends scenario, we assumed that mid-level ethanol blends (E15 or E20) could be made available nationwide by 2013 (or the time the nation hits the E10 blend wall) by utilizing existing retail storage tanks. We realize that this is a fairly aggressive phase-in plan given all the actions that would need to be taken to bring mid-level ethanol blends to market. As such, we have also considered a more gradual 10-year phase in (discussed in more detail below). For each scenario, we assumed that E10 would be marketed as premium-grade gasoline, the mid-level ethanol blend (E15 or E20) would serve as regular and, like today, midgrade would be blended from the two fuels as shown in Figure 1.7-14.

**Figure 1.7-14.
Potential Mid-Level Ethanol Blends Retail Configuration**

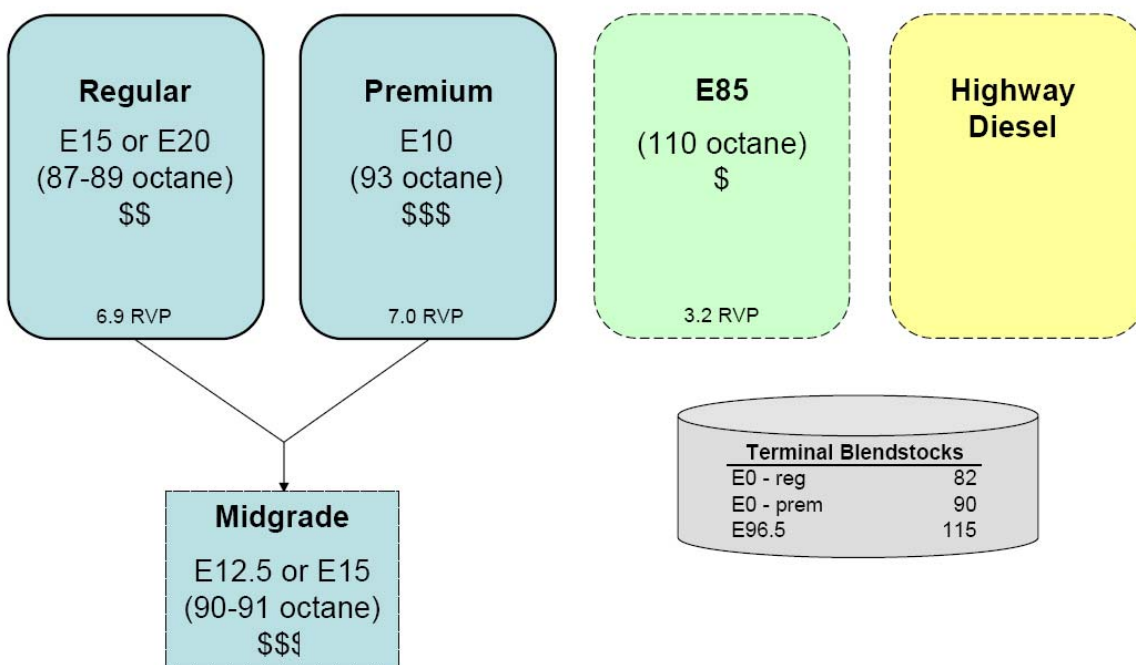

We considered multiple retail tank configurations, but decided the fuel configuration in Figure 1.7-14 would be the most likely for several reasons. For starters, marketing E15 or E20 as regular grade gasoline would allow retailers to continue to maintain the existing gasoline price relationship, i.e., regular is the cheapest followed by midgrade then premium. While we acknowledge that this is not the gasoline price relationship in all areas of the country (e.g., in certain Midwest cities, midgrade is priced lower than regular), we believe it represents the predominant retail trend. Marketing the mid-level ethanol blend as regular would also result in the highest possible ethanol throughput since, as shown below in Table 1.7-11, regular gasoline accounts for 85% of gasoline sales. Finally, we believe this configuration is advantageous because it allows premium gasoline to continue to be the universal fuel for all gasoline vehicles

and engines. The downside to this approach is that if mid-level ethanol blends were only approved for flex-fuel, Tier 2 or newer vehicles then legacy vehicles and small engines would be forced to refuel on premium gasoline. Nonetheless, the aforementioned retail configuration is consistent with how SIGMA/NACS believed mid-level ethanol blends would be brought to market (pending approval) during our discussions with them.⁴⁹⁴ We seek comment on this approach and alternate ways that mid-level ethanol blends could be brought to market without investing in new tanks or displacing diesel fuel.

For each mid-level ethanol blend scenario, we assumed that consumers filling up on conventional gasoline would choose fuel grade based on 2006 purchasing trends. A summary of historical gasoline purchasing data as well as our ethanol content assumptions for each fuel grade is found below in Table 1.7-11.⁴⁹⁵

**Table 1.7-11.
Mid-level Ethanol Blends Vehicle/Engine Assumptions**

Grade of Gasoline	% of CG Sales*	Ethanol Content (vol%)	
		In E15 Case	In E20 Case
Regular	85%	15%	20%
Midgrade	6%	13%	15%
Premium	9%	10%	10%

*Source: EIA Petroleum Marketing Annual 2006

Based on the vehicle capability assumptions outlined in Table 1.7-10, AEO 2009 gasoline energy projections, and the above refueling assumptions, we conclude that absent E85, mid-level ethanol blends could help increase ethanol usage to over 19 billion gallons (with E15) and 25 billion gallons (with E20).

As shown below in Figures 1.7-15 and 1.7-16, under an optimistic phase-in scenario where mid-level ethanol blends were made available nationwide by 2013, E15 could postpone the blend wall by up to three years to 2016 and adding E20 could postpone it another three years to 2019. However, if mid-level ethanol blends were phased in more gradually over ten years (refer to Table 1.7-12) as might occur if retailers must invest to replace existing equipment to distribute mid-level blends, E15 might only postpone the blend wall by one year to 2014. It appears E20 would continue to extend the blend wall to 2019. In both cases, we assumed that mid-level ethanol blends would eventually replace regular gasoline and be available nationwide. However if E15 and E20 only became niche fuels (like E85 is today), their ability to postpone the blend wall would be significantly reduced.

Figure 1.7-15.
Max ETOH Consumption under 2013 Mid-Level Ethanol Blends Phase-In Scenario

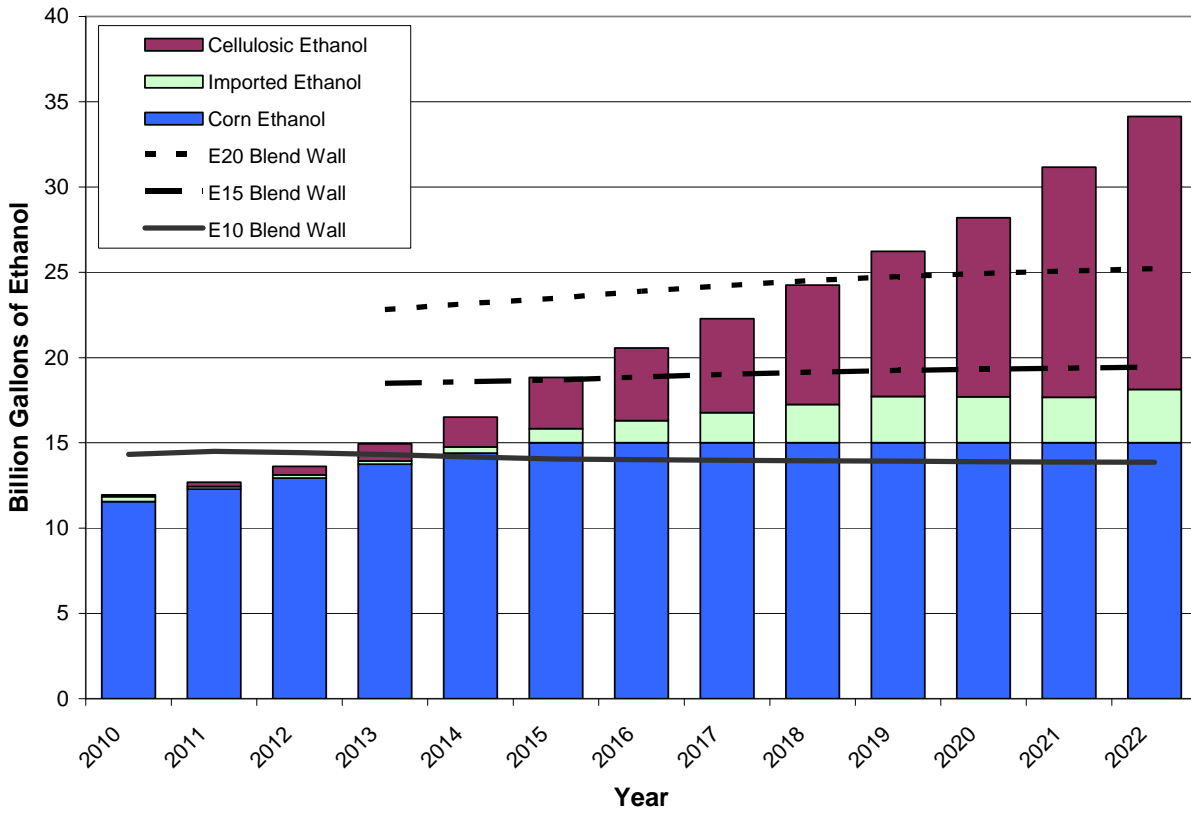

**Figure 1.7-16
Max ETOH Consumption Under Gradual Mid-Level Ethanol Blends Phase-In Scenario**

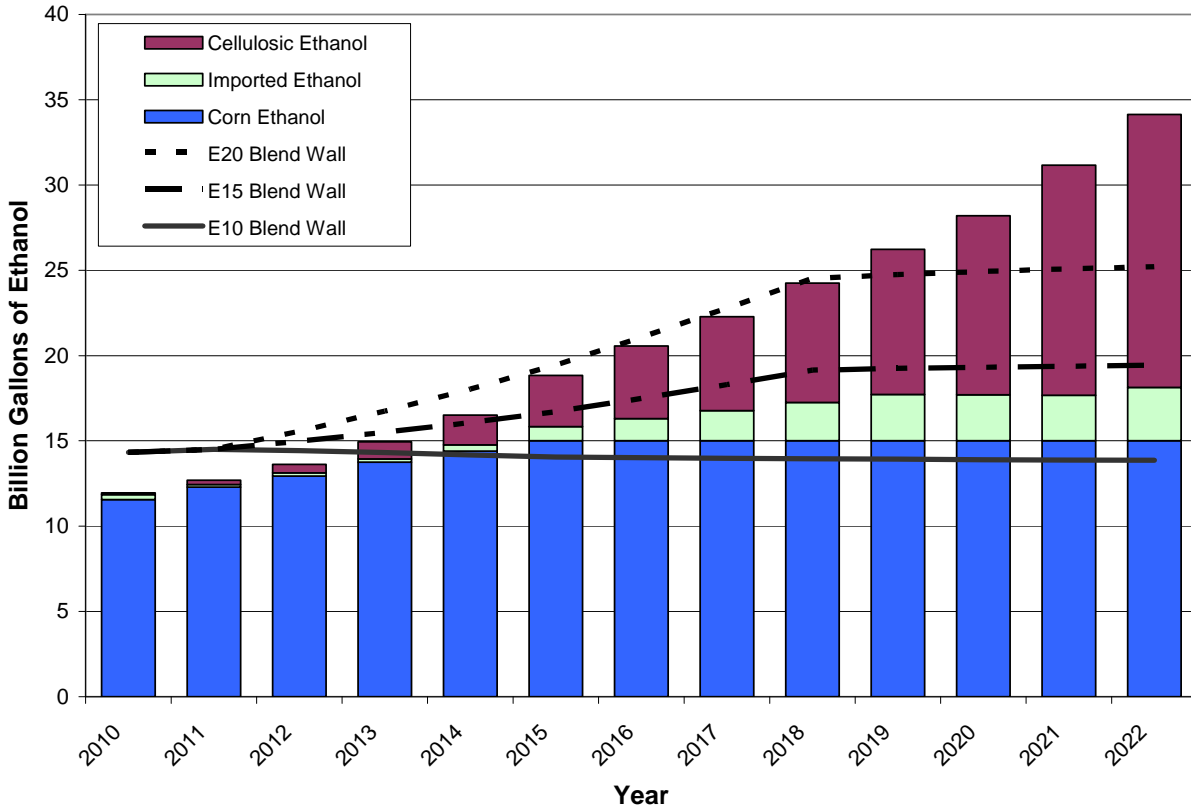
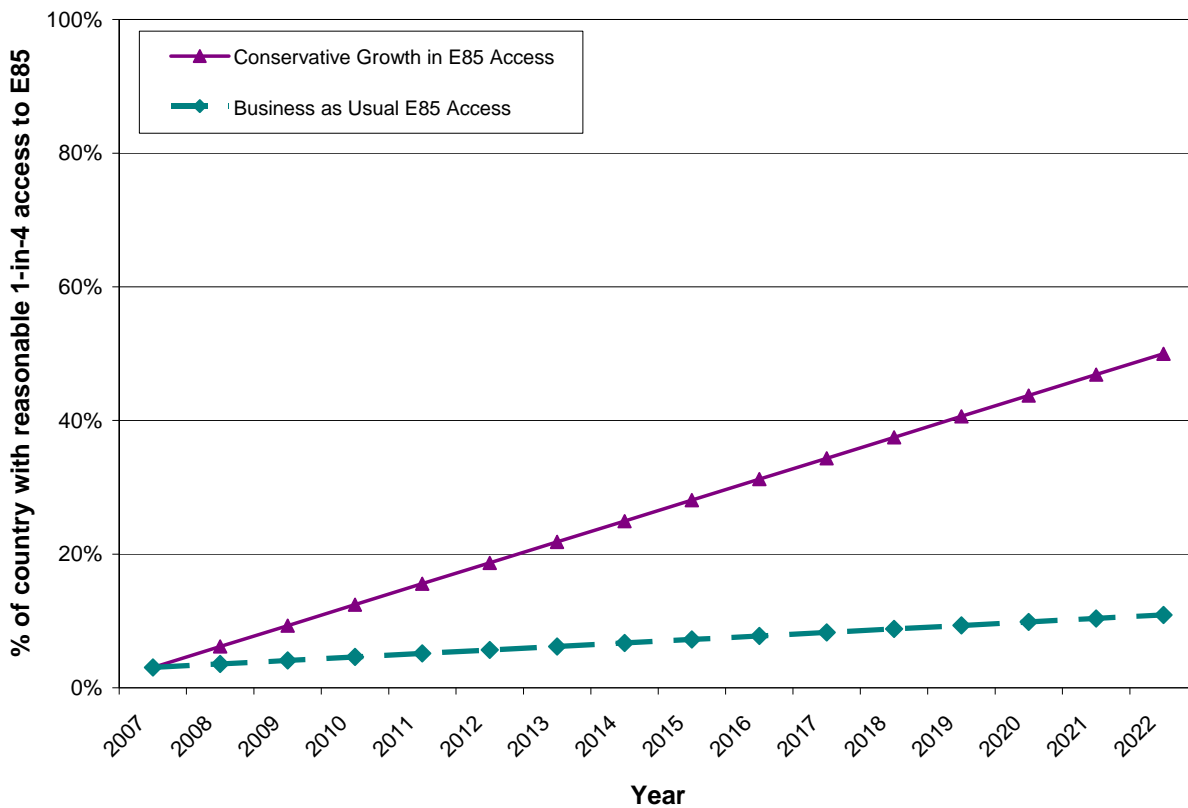

**Table 1.7-12
Access to Mid-Level Ethanol Blends Under Gradual Phase-In**

Year	% of Retailers Carrying E15 or E20
2009	0%
2010	0%
2011	0%
2012	14%
2013	29%
2014	43%
2015	57%
2016	72%
2017	86%
2018	100%

As demonstrated above, without E85, mid-level ethanol blends will fall short of meeting the 34 billion gallon ethanol standard. It is possible that other non-ethanol biofuels could come online and help the nation meet the RFS2 standard without more ethanol. However, for analysis purposes, we considered how the nation might meet RFS2 with a combination of mid-level ethanol blends and E85. For this part of the sensitivity analysis, we maintained our assumption that mid-level ethanol blends could be available nationwide by 2013. However, we also assumed that retailers would invest in E85 infrastructure in parallel. But we do not expect that retailers would invest as much in E85 infrastructure as in the primary E10/E85 scenario (refer to Figure 1.7-9). For analysis purposes, we assumed that reasonable 1-in-4 access to E85 might only grow to 50% by 2022. Our logic behind this assumption is that gasoline retailers who have already made a capital investment to bring mid-level ethanol blends to market would not turn around and invest more than what was necessary in E85 infrastructure. The more conservative 50% E85 access growth curve we assumed compared to our business as usual growth estimate (discussed more in Section 1.6) is shown below in Figure 1.7-17. For more on the retail impacts of bringing mid-level ethanol blends to market, refer to Section 1.6.11.

Figure 1.7-17.
Projected Growth in E85 Access in a Mid-Level Ethanol Blends World



It is worth noting, that this graph assumes a gradual, linear phase in of E85 infrastructure reaching 50% by 2022. In reality, retailers might wait until after the E15 or E20 blend wall to really invest in E85 infrastructure. The result would be negligible E85 station growth until the 2014-2019 timeframe (depending on the mid-level ethanol blend and phase-in scenario) and then

steep growth in E85 infrastructure. While this would arguably provide retailers with the most lead-time to postpone their E85 investments, it could result in unrealistic E85 station growth. As a result, for analysis purposes, we analyzed the gradual phase-in on E85 infrastructure shown above in Figure 1.7-17

In the hypothetical mid-level ethanol blends and E85 world, we assumed that automakers would only produce the “committed” number of FFVs detailed in Table 1.7-4. To re-summarize, this involves The Detroit 3 following through with their 50% FFV commitment and no significant growth in non-domestic FFV production (beyond what was forecasted in 2009 MY offerings). To meet the RFS2 requirements with mid-level ethanol blends and this less-aggressive E85/FFV scenario, would require the following FFV E85 refueling rates.

Figure 1.7-18.
FFV E85 Refueling Rates Needed to Meet the RFS2 Requirements

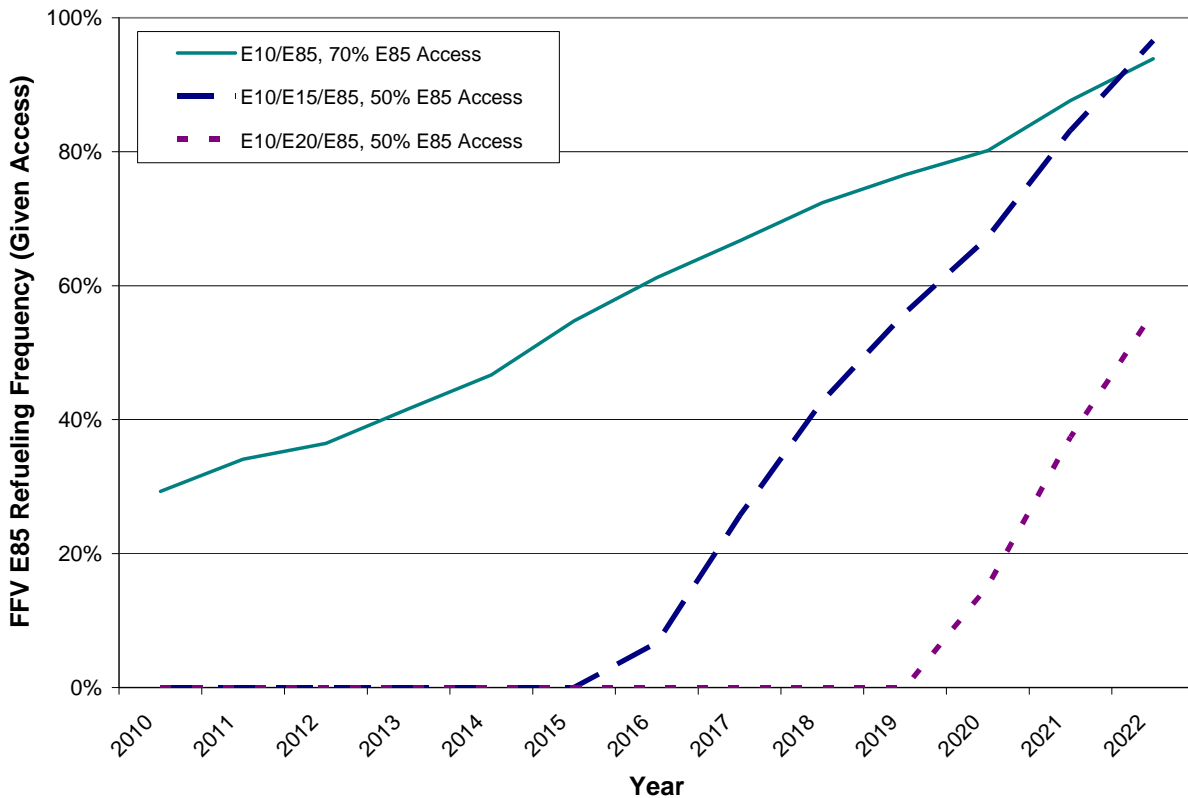

As shown above in Figure 1.7-18, in an E10/E15/E85 world (with committed FFV production and E85 access reaching 50% by 2022), the required FFV E85 refueling rate would be just as high in 2022 as that in the E10/E85 world (with optimistic FFV production and E85 access reaching 70% by 2022). This scenario would essentially demand the same changes to the E10/E85 price relationship as described in Section 1.7.1.2.5 but could result in higher capital costs (depending on the retail cost assumptions). For this reason, E20 might make more sense than E15 if they were to both require the same retail upgrades. For more on retail

accommodations and costs of mid-level ethanol blends, refer to Sections 1.6.11 and 4.2 of this DRIA.

1.7.1.4 Impacts on 2022 Fuel Volumes

As explained in Section 1.7.1.2.1, fixing gasoline energy demand according to AEO 2008 essentially dictates how much ethanol can be consumed as conventional gasoline. As a result, making different assumptions regarding the ethanol content of conventional gasoline (i.e., E10, E15, or E20), impacts the nation's ethanol usage potential and the timing of the respective blend walls under the proposed RFS2 program (refer to Figures 1.7-15 and 1.7-16). Adding in E85/FFVs to meet the RFS2 volume requirements shifts ethanol usage out of conventional gasoline and into E85. As shown below in Tables 1.7-13 and 1.7-14, although holding total gasoline energy demand and the ethanol volume constant under RFS2 fixes the overall fuel volumes in 2022, it changes the distribution of ethanol.

This page intentionally left blank.

Table 1.7-13.
Comparison of Total Fuel Volumes Under Various Scenarios

Fuel Scenario		Projected 2022 Fuel Volumes					
		E10	E12.5	E15	E20	E85	Total
Blend Wall	E10 Nationwide (No E15, E20 or E85)	147.61	0.00	0.00	0.00	0.00	147.61
Blend Wall	E10 & E15 Nationwide (No E85) ^a	31.27	7.39	110.85	0.00	0.00	149.51
Blend Wall	E10 & E20 Nationwide (No E85) ^b	31.27	0.00	7.45	112.76	0.00	151.49
RFS2 Control Case	E10/E85 Scenario (No E15 or E20)	124.55	0.00	0.00	0.00	29.30	153.85
RFS2 Control Case	Combination E10/E15/E85 Scenario ^a	29.67	6.41	96.24	0.00	21.54	153.85
RFS2 Control Case	Combination E10/E20/E85 Scenario ^b	30.34	0.00	6.88	104.14	12.50	153.85

^aAssumes E12.5 (midgrade) is blended from E10 (premium) and E15 (regular).
^bAssumes E15 (midgrade) is blended from E10 (premium) and E20 (regular).

Table 1.7-14.
Comparison of Ethanol Volumes Under Various Scenarios

Fuel Scenario		Projected 2022 Ethanol Usage					
		E10	E12.5	E15	E20	E85	Total
Blend Wall	E10 Nationwide (No E15, E20 or E85)	14.76	0.00	0.00	0.00	0.00	14.76
Blend Wall	E10 & E15 Nationwide (No E85)	3.13	0.92	16.63	0.00	0.00	20.68
Blend Wall	E10 & E20 Nationwide (No E85)	3.13	0.00	1.12	22.55	0.00	26.80
RFS2 Control Case	E10/E85 Scenario (No E15 or E20)	12.45	0.00	0.00	0.00	21.69	34.14
RFS2 Control Case	Combination E10/E15/E85 Scenario	2.97	0.80	14.44	0.00	15.94	34.14
RFS2 Control Case	Combination E10/E20/E85 Scenario	3.03	0.00	1.03	20.83	9.25	34.14

^aAssumes E12.5 (midgrade) is blended from E10 (premium) and E15 (regular).
^bAssumes E15 (midgrade) is blended from E10 (premium) and E20 (regular).

This page intentionally left blank.

1.7.1.5 Projected Ethanol Consumption by County in 2022

To understand the impacts of increased ethanol use on emissions and air quality (to be modeled under the final rule), we estimated where the ethanol might be used under the RFS2 program. We started by assuming that E10 would be available nationwide in 2022 (no E0), and for this county-level analysis, we focused on our primary E85/FFV scenario. We assumed practical, yet aggressive growth in E85 access (one-in-four station access reaching 70% by 2022). With respect to FFVs, we assumed optimistic production (outlined in Table 1.7-4) and made the simplifying assumption that all FFVs would be distributed homogeneously.^{FFFFFF} As explained in Section 1.7.1.2, this determined the manner in which E85 would be consumed (i.e., the number of FFVs required, the number of E85 stations, and the average FFV E85 refueling frequency). However, it does not tell us where E85 would be consumed.

To estimate where E85 might be consumed under the proposed RFS2 program in 2022, we conducted a cost effectiveness study. For each area of the county, we began by looking at gasoline delivered prices. We started with state-level gasoline prices (excluding taxes) provided by EIA's Petroleum Marketing Annual 2006.⁴⁹⁶ We relied on Table 31 for average gasoline prices, looked to Table 34 for RFG prices and back-calculated CG prices by applying the respective gasoline fuel volumes provided in Table 48. For states requiring 7 or 7.8-lb gasoline in the summertime, we applied PADD-average low-RVP gasoline production costs derived from the Mobile Source Air Toxics (MSAT) rule⁴⁹⁷ to come up with the respective low-RVP and 9-lb conventional gasoline prices in these states. From there, we added in the corresponding gasoline taxes (state plus federal) according to the American Petroleum Institute (API).⁴⁹⁸ This gave us the average retail cost of gasoline by state and fuel type.

Next we converted the gasoline prices into competitive retail E85 prices by adjusting for the reduced energy density of E85, the increased refueling time, and E85's presumed limited availability in 2022. For a more detailed assessment, refer to Section 1.7.1.2.5. From there, we deducted fuel taxes (assumed to be the same as gasoline), backed out marketing costs and retail profits (assumed to be \$0.10 per gallon) and subtracted the terminal-to-retail transportation costs (assumed to be \$0.03) to arrive at the estimated retail value of E85, and ultimately, the retail value of ethanol.^{GGGGGG} Once we computed the retail value of ethanol, we compared it to the estimated ethanol delivered price (based on transportation costs presented in Section 4.2) to come up with the respective E85 profit margin.

To conclude, we assigned E85 to the areas of the county with the highest E85 profit margins, or in some cases, the least negative E85 profit margins until we arrived at approximately 34 billion gallons of ethanol in 2022. For a graphical representation of the areas of the country we assumed would receive/consume E85, refer to Figure 1.7-19.

^{FFFFFF} We plan on looking into purchasing FFV registration data or relying on the DOE FFV study required under EISA for the final rule.

^{GGGGGG} For analysis purposes we assumed that E85 was taxed at the same rate as gasoline. We acknowledge that a number of states currently have reduced excise taxes or excise tax exemptions for E85. However, the extent of the tax breaks is somewhat unknown and the potential that these tax breaks will exist in the future is uncertain. We plan on revisiting state-level E85 excise tax exemptions for the Final Rule. For more on marketing and transportation costs, refer to Section 4.4 of the DRIA.

Figure 1.7-19.
Projected E85 Usage in 2022 Under RFS2

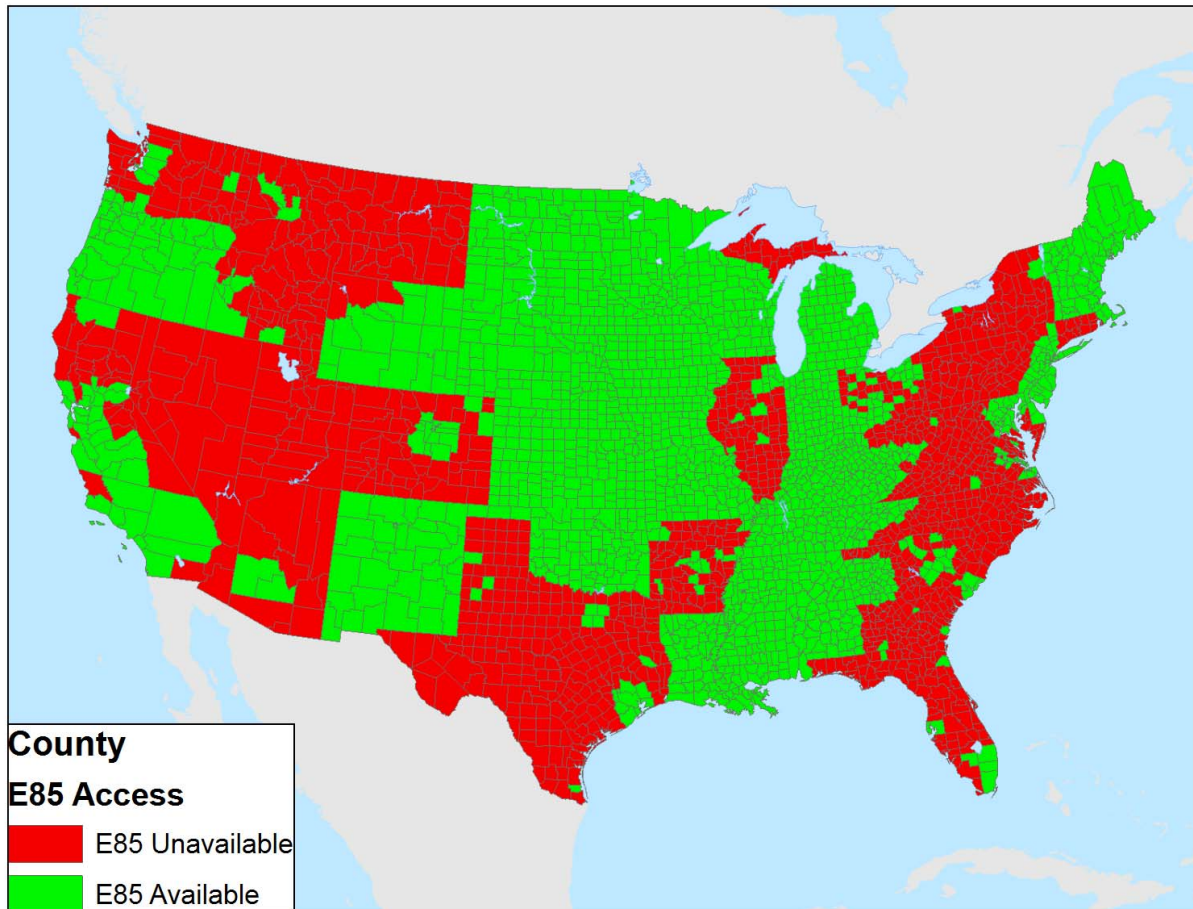

1.7.2 Biodiesel & Renewable Diesel Consumption

Biodiesel, like ethanol, is generally blended at the end of the distribution chain, just before delivery to retail outlets. Because of its chemical properties, it is not currently considered fungible with diesel fuel, and thus its blend level in fuels offered for sale is typically deliberate and explicit. Renewable diesel, on the other hand, is a fuel or hydrocarbon blendstock which can be blended into fungible fuel at any point in the distribution system, such that the blend level at the final point of use is not typically of concern and, in fact, would probably be difficult to determine. Because of its nature, and the relatively small volumes we are projecting (less than 0.5 billion gallons per year), we have not analyzed distribution or use impacts for renewable diesel. The remainder of this section addresses biodiesel use.

Vehicle and engine manufacturers recognize biodiesel as a lubricity improver at low levels, something that is useful with ultra-low sulfur diesel fuel now phasing in across the country. Therefore, most state that their products are compatible with blends up to 5%, and a few suggest blends up to 20% can be used without problems. Therefore, our analysis assumes blends up to 5% can find widespread use.

In order to conduct our distribution and emissions analyses, we needed to forecast approximate volumes of biodiesel to be used in each state. We considered transportation diesel fuel and home heating oil as the primary uses for biodiesel. For transportation fuel estimates, we assumed that biodiesel would be preferentially used in states that have blend mandates or significant per-gallon incentives. Table 1.7-14 shows the states with such mandates and incentives on record as of summer 2008, as well as the associated potential biodiesel volumes based on 2005 diesel fuel use.⁴⁹⁹ State-level forecasts were not available for transportation fuel use, thus the reliance on historical data for this estimate.

Table 1.7-14.
State biodiesel incentives as of summer 2008 and potential volumes based on 2005 data.⁵⁰⁰

State	Incentive or mandate	Diesel fuel use (million gal/yr)	2% biodiesel (million gal/yr)	5% biodiesel (million gal/yr)
IL	per-gallon tax incentive(s) for B11+, state fleet requirement	1,660	33.2	
KS	per-gallon tax incentive(s) for B2+	816	16.3	
LA	B2 mandate with some conditions	1,734	34.7	
MA	B2 mandate, increasing to B15 with some conditions	491		24.5
MI	per-gallon tax incentive(s) for B5+	1,071		53.5
MN	B2 mandate; state fleet requirement	999	20.0	
NC	per-gallon tax incentive(s), B2 school bus requirement	1,234	24.7	
ND	per-gallon tax incentive(s)	358	7.2	
NE	per-gallon tax incentive(s)	547	10.9	
NM	B5 mandate with some conditions	475		23.7
OH	per-gallon tax incentive(s)	1,556	31.1	
OR	B2 mandate, increasing to B5 with some conditions	738		36.9
SC	per-gallon tax incentive(s)	764	15.3	
SD	per-gallon tax incentive(s)	263	5.3	
TX	per-gallon tax incentive(s)	5,339	106.8	
WA	B2 mandate, increasing to B5 with some conditions	1,230	24.6	
			Total biodiesel	468.7

Table 1.7-15 shows home heating oil use in 2005. We estimate potential biodiesel use in heating oil at 89 million gallons per year based on a 2% blend in all heating oil north of the Washington, DC, area (i.e., PADD 1A and 1B). This area was chosen because it is where the majority of heating oil is used, and should have adequate biodiesel access from New Jersey, Pennsylvania, and Connecticut in our forecasted production scenarios (see Section 1.5.4). To the extent that heating oil use declines over time, the blend levels may increase in some areas or in the shoulder seasons, such that the total biodiesel volume used in this market would not decline drastically.

**Table 1.7-15.
Potential biodiesel use in heating oil based on 2005 data.⁵⁰¹**

Area	Heating oil (million gal/yr)	2% biodiesel (million gal/yr)	Volume Used (million gal/yr)
U.S.	5,565,489	111.3	
PADD 1	4,759,198	95.2	
PADD 1A	1,923,405	38.5	38.5
CT	545,910	10.9	
ME	308,464	6.2	
MA	674,324	13.5	
NH	175,484	3.5	
RI	136,618	2.7	
VT	82,604	1.7	
PADD 1B	2,529,106	50.6	50.6
DE	33,221	0.7	
DC	12,832	0.3	
MD	149,919	3.0	
NJ	322,088	6.4	
NY	1,282,899	25.7	
PA	728,147	14.6	
PADD 1C	306,687	6.1	
FL	3,608	0.1	
GA	1,520	0.0	
NC	81,528	1.6	
SC	8,810	0.2	
VA	197,255	3.9	
WV	13,966	0.3	
Total used for biodiesel in heating oil			89.1

Combining these volumes gives 558 million gallons per year potential biodiesel consumption, leaving approximately 250 million gallons to be sold in blends above the projected levels shown here, or in states not included here. Further use and distribution of biodiesel is discussed in more detail in Section 4.2.2.2.

Chapter 2: Lifecycle GHG Analysis

2.1 Lifecycle Introduction and Summary

As part of proposed revisions to the National Renewable Fuel Standard program (commonly known as the RFS program), EPA is estimating lifecycle greenhouse gas (GHG) emissions from increased renewable fuels use. The Energy Independence and Security Act of 2007 (EISA) establishes new renewable fuel categories and eligibility requirements, including setting the first-ever mandatory lifecycle GHG reduction thresholds for renewable fuel categories, as compared to those of average petroleum fuels used in 2005 (base year established by EISA). This chapter describes the methodology developed by EPA to determine the lifecycle GHG emissions of renewable fuels as required by EISA. This methodology was utilized to determine which renewable fuels qualify for the four different GHG reduction thresholds specified in EISA. The overall GHG benefits of the RFS program, which are based on the same methodology presented here, are also provided.

The GHG provisions in EISA are notable for the GHG thresholds mandated for each category of renewable fuel and also the mandated lifecycle approach to those thresholds. Renewable fuel must achieve a 20% reduction in lifecycle greenhouse gas emissions compared to the average for gasoline or diesel sold or distributed as transportation fuel in 2005. Similarly, biomass-based diesel and advanced biofuels must achieve a 50% reduction, and cellulosic biofuels a 60% reduction. To EPA's knowledge, the GHG reduction thresholds in EISA are the first lifecycle GHG performance requirements included in federal law. While these thresholds do not directly constitute a greenhouse gas control program for renewable fuels, in combination with the volume mandates, they are designed to ensure significant GHG emission reductions from the use of renewable fuels and to encourage the use of GHG-reducing renewable fuels.

The definition of lifecycle greenhouse gas emissions established by Congress states that:

The term 'lifecycle greenhouse gas emissions' means the aggregate quantity of greenhouse gas emissions (including direct emissions and significant indirect emissions such as significant emissions from land use changes), as determined by the Administrator, related to the full fuel lifecycle, including all stages of fuel and feedstock production and distribution, from feedstock generation or extraction through the distribution and delivery and use of the finished fuel to the ultimate consumer, where the mass values for all greenhouse gases are adjusted to account for their relative global warming potential.⁵⁰²

This definition requires the Agency to look broadly at lifecycle analyses and to develop a methodology that accounts for all of the important factors that may significantly influence this assessment, including the secondary or indirect impacts of expanded biofuels use. EPA's analysis suggests that the assessment of lifecycle GHG emissions for biofuels is significantly affected by the secondary agricultural sector GHG impacts from increased biofuel feedstock production (e.g., changes in livestock emissions due to changes in agricultural commodity prices) and the international impact of land use change from increased biofuel feedstock

production. Thus, these factors must be appropriately incorporated into EPA’s lifecycle methodology to properly assess the full lifecycle GHG performance of biofuels in accordance with the EISA definition of lifecycle GHG emissions. As discussed below, there are many other potential impacts (e.g., hypoxia in the Gulf of Mexico) that do not have a meaningful impact on the lifecycle GHG analysis and therefore fall outside the scope of this analysis.

Currently, no single model captures all of the interactions associated with estimating lifecycle GHG emissions for renewable fuels, taking into account the "significant indirect emissions" required by EISA. EPA’s approach has been to use the best tools available for each specific component of the lifecycle to create a comprehensive estimate of GHG emissions (See Figure 2.1-1). As required by EISA, the broad system boundaries of our analysis encompass all significant secondary agricultural sector GHG impacts, not just impacts from land use change.

Figure 2.1-1. System Boundaries and Models and Data Sources Used

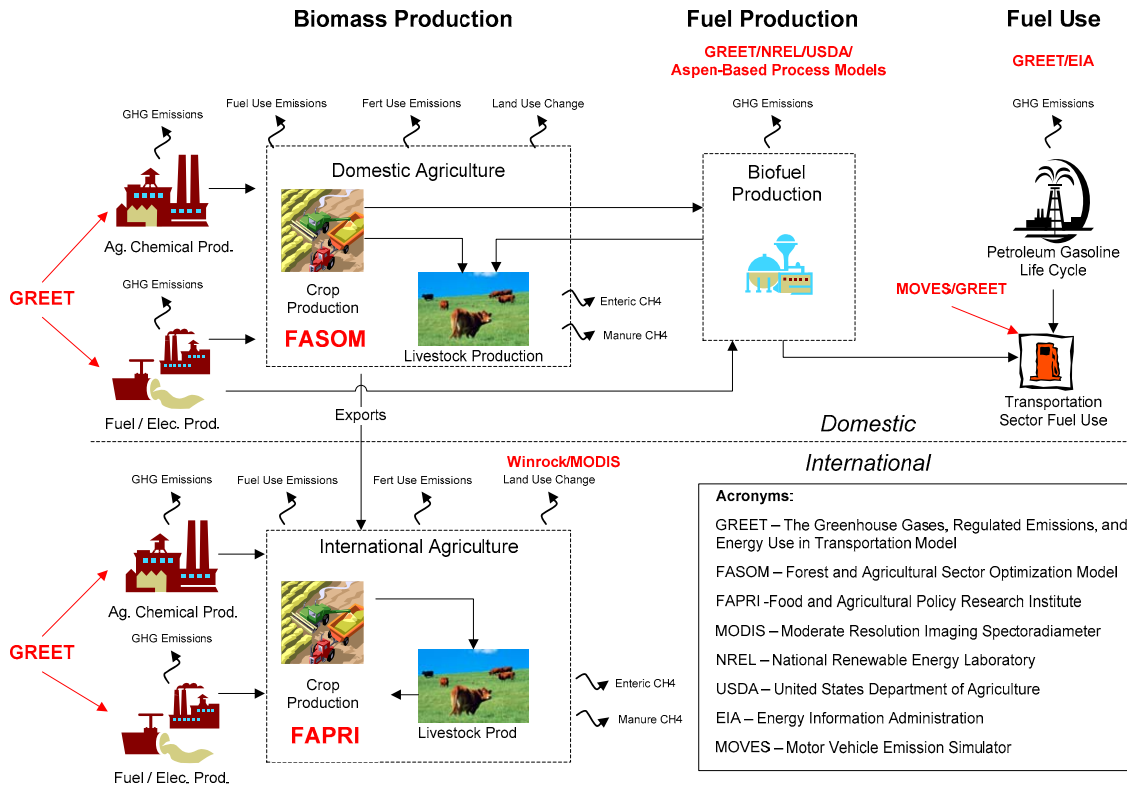

To quantify the lifecycle GHG emissions associated with the increase in renewable fuels mandated by EISA, we compared the differences in total GHG emissions between two future scenarios. The first assumed a “business as usual” volume, or reference case, of a particular renewable fuel based on what would likely be in the fuel pool from now until 2022 without EISA. The reference case includes technological advances, such as crop yield improvements, that are likely to occur irrespective of EISA. The second scenario assumed higher volumes of renewable fuels as mandated by EISA. Rather than focus on the impacts associated with a specific gallon of fuel and tracking inputs and outputs across different lifecycle stages, we

determined the overall aggregate impacts across sections of the economy in response to a given volume change in the amount of biofuel produced.^{HHHHHHH} Table 2.1-1 provides an overview of the volumes of renewable fuels modeled for this analysis. More details about the fuel volumes modeled, including sensitivity analysis volume runs, are provided in Section 2.6 of this Chapter.

Table 2.1-1. Renewable Fuel Volumes Modeled

Fuel	Volume (Billions of Gallons)		
	Reference Case	Control Case	Net Change
Corn Ethanol	12.4	15	2.6
Corn Stover Ethanol	0	7.6	7.6
Biodiesel	0.4	0.7	0.3
Sugarcane Ethanol	0.6	3.1	2.5
Switchgrass Ethanol	0	3.2	3.2

2.1.1 Results

EPA’s results suggest that biofuel induced land use change can produce significant near-term emissions, but that biofuels have GHG emissions benefits by displacing the use of petroleum-based fuels in subsequent years that can “payback” earlier land conversion GHG releases. Therefore, choosing an appropriate time horizon for analysis is essential when comparing biofuels with petroleum-based fuels. Whether or not to discount future emissions is also critical because it determines the relative importance of near-term versus longer-term emissions. The type of land (e.g., forest or grassland) that is converted to cropland as a result of biofuel production is another factor that strongly influences overall lifecycle GHG reduction estimates.

Figures 2.1-2 and 2.1-3 show how EPA’s lifecycle GHG emission estimates vary by lifecycle stage for each biofuel analyzed. We calculated a net present value of emissions because it provides a common metric for direct comparison of lifecycle emissions from biofuels and petroleum fuels. Figure 2.1-2 includes results using a 100-year time horizon and a 2% discount rate. The results in Figure 2.1-2 use a 30-year time horizon and a 0% discount rate. Our primary estimates include GHG emissions from forest, shrub, savanna and grassland clearing (proportionally estimated based on MODIS satellite data) resulting from biofuel production.^{IIIIII} The tables also show how total net lifecycle GHG emissions estimates would vary if we assumed that all new cropland would come from forest, or all from grasslands. The choice of time horizon, discount rate, and land use change estimates are discussed in detail in the preamble to the proposed rule.

^{HHHHHHH} We then normalize those impacts for each gallon of fuel (or Btu) by dividing total impacts over the given volume change. Net lifecycle GHG emissions are reported as grams of carbon dioxide equivalent per million Btu (gCO₂eq/mmBtu).

^{IIIIII} Per acre land use change emissions factors were estimated by Winrock International Inc., following 2006 Intergovernmental Panel on Climate Change guidelines

Our results indicate that emissions produced during the fuel production stage can vary significantly for corn ethanol depending on the type of facility used to convert corn into ethanol. A typical dry mill corn ethanol production facility fired with natural gas produces 32,579 grams of carbon-dioxide equivalent emissions per million British Thermal Units (gCO₂-eq./mmBtu) of ethanol produced per year. For corn ethanol, emissions at the fuel production stage can range from 60,209 gCO₂-eq./mmBtu for a coal-fired dry mill in the higher emitting case; to 9,688 gCO₂eq/mmBtu for a biomass-fired dry mill in the lower emitting case. Clearly, the choice of fuel production technology can be used as a measure to reduce the climate impact of corn ethanol production.

Conversion of cellulosic feedstocks (e.g., corn stover or switchgrass) to ethanol creates a net sequestration of carbon during the fuel production stage. Ethanol is fermented with the cellulosic portion of the biomass, while process energy is generated through the unfermentable portion (mainly lignin) of incoming biomass. Based on NREL estimates, the process is assumed to generate more than 8,000 Btu of excess electricity per gallon of ethanol produced. Biomass-fired electricity generation reduces GHG emissions by offsetting other forms of electricity production.

**Figure 2.1-2. Lifecycle GHG Results
Using 100-Year Net Present Value with 2% Discount Rate**

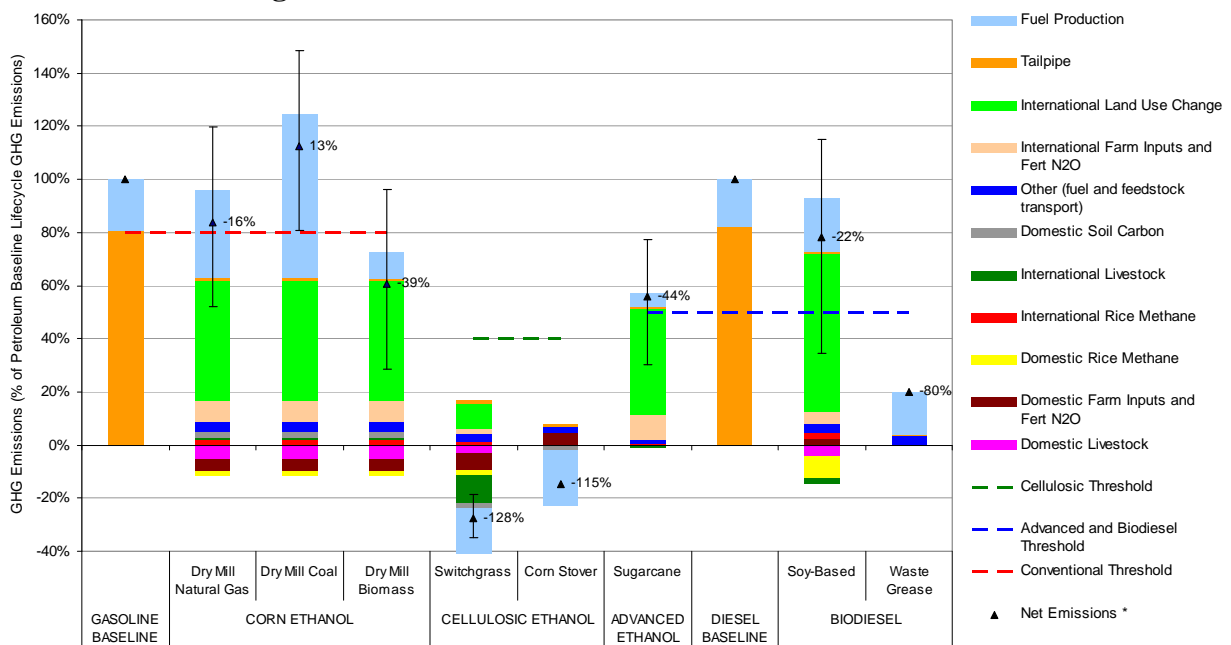

*Range shows net emissions if we assume all land conversion from forest (upper bound) or all from grassland (lower bound).

**Figure 2.1-3. Lifecycle GHG Results
Using 30-Year Net Present Value with 0% Discount Rate**

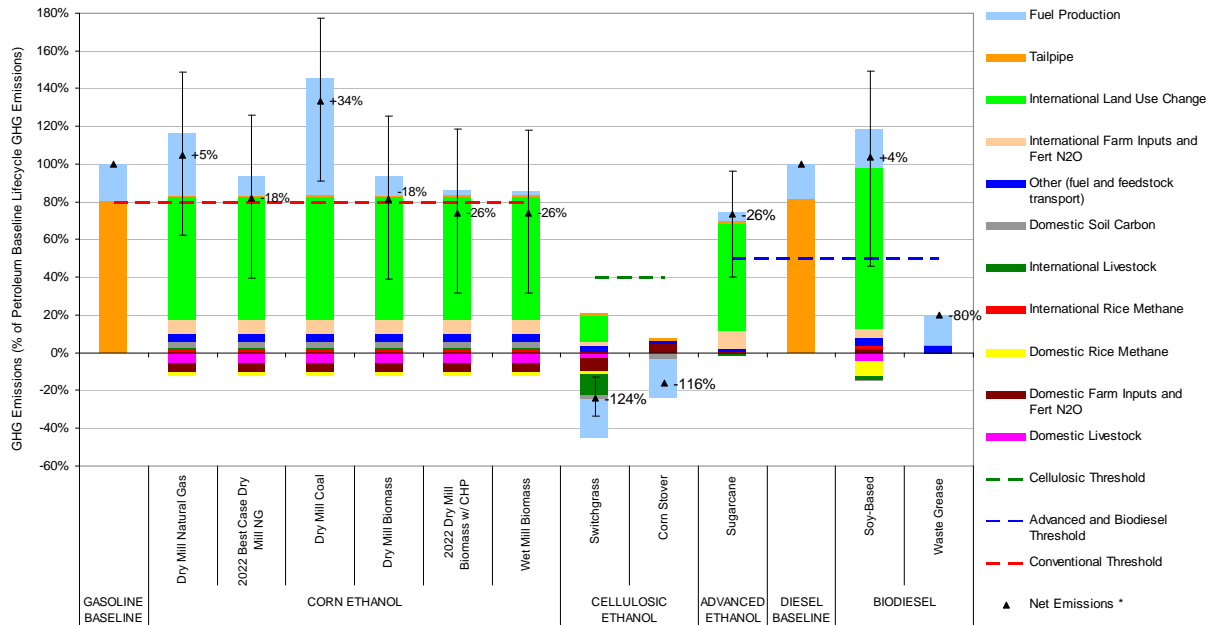

* Range shows net emissions if we assume all land conversion from forest (upper bound) or all from grassland (lower bound).

Figures 2.1-2 and 2.1-3 also include indirect emissions impacts that result from fuel production or use, such as changes in livestock inventories, or shifts in acreage between different types of crops. For example, the FASOM model projects that increasing the production of soy-based biodiesel will reduce domestic livestock and rice production, which reduces methane emissions from those sectors. To compensate for this decrease in domestic rice and livestock production, the FAPRI models project that foreign countries will expand their rice and livestock production. There are similar indirect effects on farming practices, which impact soil carbon emissions and emissions from agricultural energy use.

The benefit of using renewable fuels that displace petroleum fuel consumption is seen primarily at the end use, or tailpipe, stage of the fuel lifecycle. Combustion CO₂ emissions for ethanol, biomass-based diesel, petroleum diesel and gasoline were based on the carbon content of the fuel. However, over the full lifecycle of the fuel, the CO₂ emitted from biomass-based fuels combustion does not increase atmospheric CO₂ concentrations, assuming the biogenic carbon emitted is offset by the uptake of CO₂ resulting from the growth of new biomass. As a result, CO₂ emissions from biomass-based fuels combustion are not included in their lifecycle emissions results. Unlike CO₂ emissions, the combustion of biomass-based fuels does result in net additions of methane and N₂O to the atmosphere. Therefore, combustion methane and N₂O emissions are included in the lifecycle GHG emissions results for biomass-based fuels. Net carbon fluxes from changes in biogenic carbon reservoirs in wooded or crop lands are accounted for separately in the land use change analysis as outlined in the agricultural sector modeling above.

2.1.2 Greenhouse Gas Emissions from Land Use Changes

We estimated GHG emissions associated with land use changes that occur domestically and internationally as a result of increasing renewable fuels demand in the U.S. Key questions we addressed included the area of land converted to crop production, where those acreage changes would occur, the types of land converted to crop production, and the GHG emissions associated with different types of land conversion. In general, we found that land use change impacts are larger when food crops (such as corn or soybeans) are used as biofuel feedstocks than when non-food crops (such as corn stover or switchgrass) are converted to biofuel. EPA recognizes that estimating the international impacts of land use change can introduce additional uncertainty to the lifecycle GHG emissions estimates, and we present a range of results.

We used the FAPRI model to estimate international crop expansion, and the FASOM model to estimate domestic crop expansion. The results are summarized in Figure 2.1-4. Overall, soy-based biodiesel induces the most crop expansion per gallon of production. One reason for this is that soybeans are a relatively low-yield crop compared to corn and sugarcane in terms of how many gallons of biofuel can be produced per acre of crop production. Crop expansion caused by corn ethanol production is also offset to some degree by the production of distillers grains (DGs), a major co-product of dry mill ethanol production that is also used as animal feed.

**Figure 2.1-4. Regional Crop Expansion by Renewable Fuel, 2022
(acres per thousand ethanol equivalent gallons of biofuel production)**

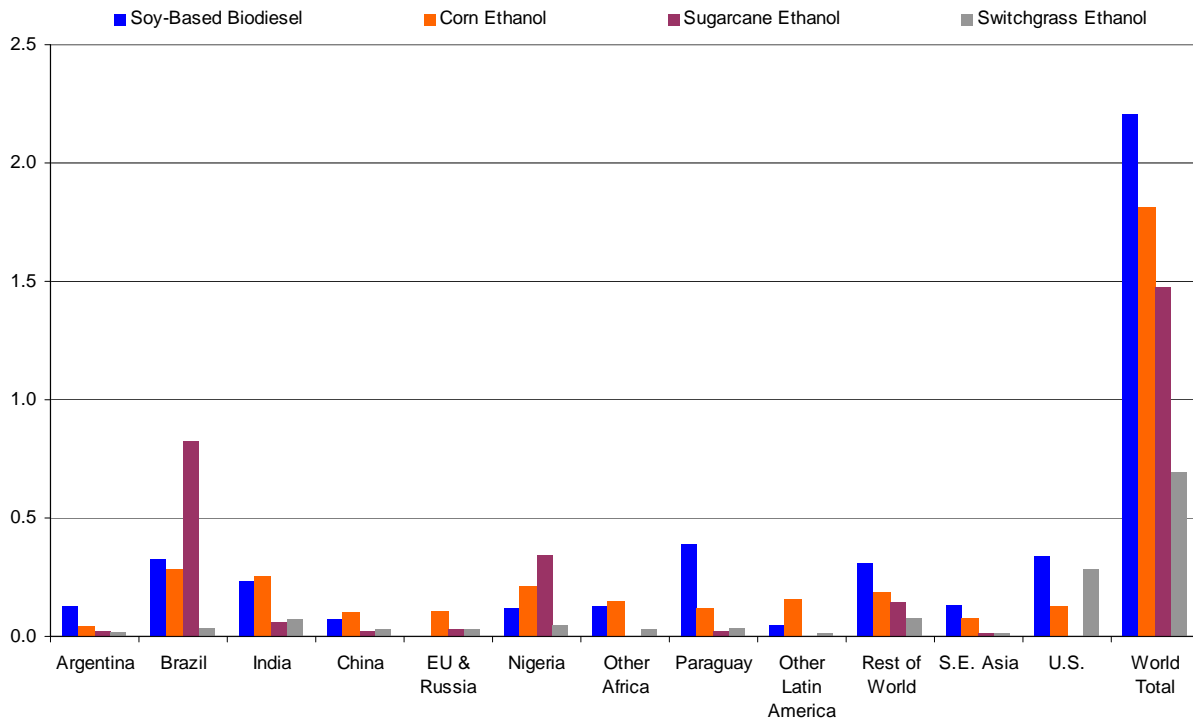

The percentage of each land type converted to cropland was estimated according to MODIS satellite-based data (See Table 2.1-2).^{JJJJJJ} We extrapolated the recent land use trends, as determined with the satellite data, into the future to estimate the most likely places for crop expansion on a sub-regional basis, and the types of land that would most likely be converted to crop production. For the proposed rule, land use trends and emissions factors were estimated for ten countries including Argentina, Brazil, China, India, Indonesia, Malaysia, Mexico, Philippines, EU and South Africa.^{KKKKKK}

Table 2.1-2. Types of Land Converted to Cropland by Country, 2001-2004

Country	Forest	Grassland	Savanna	Shrub
Argentina	8%	40%	45%	8%
Brazil	4%	18%	74%	4%
China	17%	38%	23%	21%
E.U.	27%	16%	36%	21%
India	7%	7%	33%	53%
Indonesia	34%	5%	58%	4%
Malaysia	74%	3%	19%	3%
Nigeria	4%	56%	36%	4%
Philippines	49%	5%	44%	3%
South Africa	10%	22%	53%	15%

To estimate the GHG impacts of projected land use changes, emissions factors were calculated by Winrock following 2006 Intergovernmental Panel on Climate Change (IPCC) Agriculture, Forest and Other Land Use (AFOLU) guidelines.⁵⁰³ Emissions factors were based on the initial changes in above and below ground biomass carbon stocks as well as changes in soil carbon stocks, non-CO₂ emissions from clearing with fire, and forgone forest sequestration. In general, for the countries analyzed, emission factors for all land use types were highest in the South East Asian countries of Malaysia, Indonesia and Philippines and lowest in Argentina and Nigeria.

The GHG emissions associated with converting land into crop production accumulate over time, with the largest releases occurring in the first few years due to clearing with fire and biomass decay. After land is converted to crop production, moderate amounts of soil carbon would continue to be released for approximately 20 years. Furthermore, when forest is cleared there would be foregone sequestration for approximately 80 years associated with the fact that the forest would have continued to grow had it not been cleared. Section 2.6.5 provides details about our estimates of GHG emissions from land use changes.

2.1.3 Treatment of Future Greenhouse Gas Emissions

When comparing the lifecycle GHG emissions associated with biofuels to those associated with gasoline or diesel emissions, it is critical to consider the timing of GHG releases from the lifecycle of each fuel type. With gasoline, a majority of the GHG emissions associated with extraction, conversion, and combustion are likely to be released over a short period of time

^{JJJJJJ} The 17 MODIS imagery land cover classes were reclassified using the International Geosphere Biosphere Programme land cover dataset into five general classes: cropland, forest, grassland, savanna and shrubland.
^{KKKKKK} We are in the process of acquiring data for more countries to be used for the final rule.

(i.e., annually) as crude oil is converted into gasoline or diesel fuel which quickly pass to market. In contrast, the land use change GHG emissions associated with the use of a typical biofuel (e.g., corn-based ethanol) may occur over a longer period of time. While biomass feedstocks grown each year on new cropland can be converted to biofuels that offer an annual GHG benefit relative to the petroleum product they replace, these benefits may be small compared to the upfront GHG emissions from land clearing. Depending on the specific biofuel in question, it can take many years for the benefits of the biofuel to “payback” the initial GHG releases resulting from land use change.

As shown in Figure 2.1-5, the payback period for corn ethanol produced in a natural gas-fired dry mill is approximately 33 years; soy-based biodiesel has a payback period of about 32 years; sugarcane ethanol’s payback period is approximately 18 years; and it takes about 3 years for switchgrass ethanol use to offset initial land clearing emissions. Corn stover and waste grease biodiesel are not shown in Figure 2.1-5, because both biofuels produce GHG reductions in the first year. In our analysis, the annual gasoline and diesel baseline emissions do not vary over time; instead, their lifecycle impacts are replicated every year to match the lifecycle emissions from average 2005 petroleum fuel. The cumulative net emissions for corn ethanol and soy-based biodiesel cross after approximately 27 years, because soy-based biodiesel has larger initial land use change emissions but lower subsequent annual emissions from the non-land use impacts of the lifecycle.

EISA requires EPA to determine which biofuel production pathways reduce GHG emissions by the required threshold amounts relative to the 2005 petroleum baseline. A payback period alone cannot answer that question. Since the payback period is not sufficient for our analysis, we must account for the variable time profiles of lifecycle GHG emissions and provide a common metric that allows for a direct comparison of lifecycle emissions from biofuels and petroleum fuels. When considering the time profile of GHG emissions, two assumptions that have a significant impact on the determination of whether a biofuel meets the emissions reduction threshold are: 1) the time horizon of emissions considered in the analysis and 2) the discount rate applied to future emissions.

The importance of the time horizon for analysis is clearly illustrated by the payback periods of various biofuels. If we select a time horizon that is shorter than the payback period for a given biofuel, then we will determine that the biofuel in question increases GHG emissions. On the other hand, if we choose a very long time horizon, all of the biofuels we analyzed will eventually reach the GHG reduction thresholds specified by EISA.

Figure 2.1-5. Annual Lifecycle GHG Emissions Over Time and Payback Periods

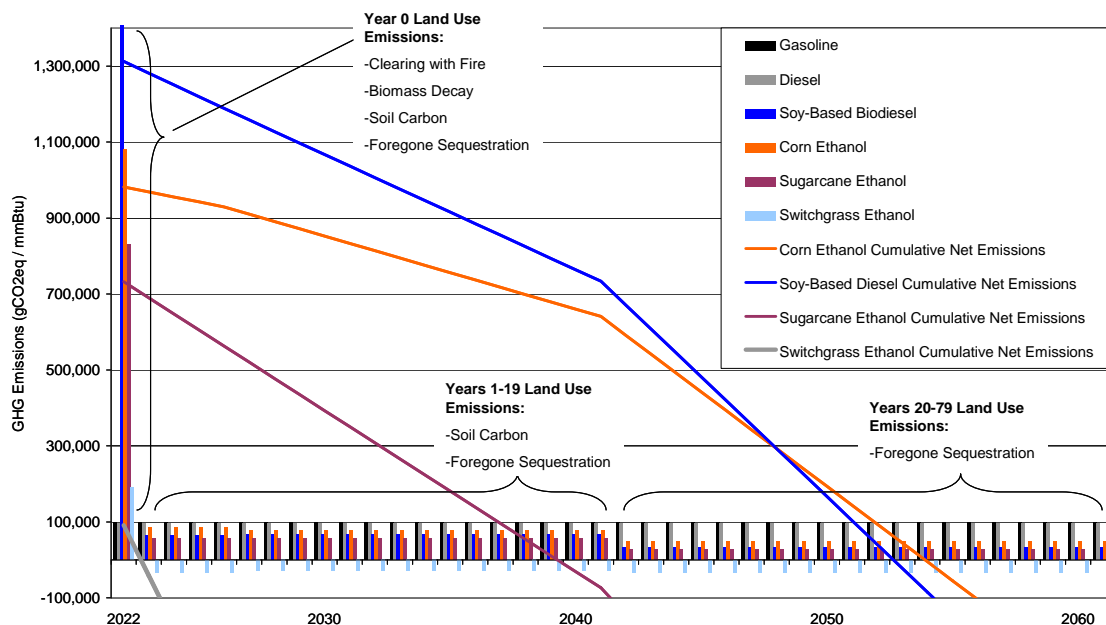

In the proposed rule we highlight results for time horizons of 100 years and 30 years, and discuss the merits of both approaches. With lifecycle GHG emissions projected to occur many years into the future, the choice of whether and by how much to discount future emissions is also important.

In our highlighted results, we used a 2% discount rate when analyzing GHG emissions over a 100-year time horizon (See Figure 2.1-2), and we apply a 0% discount rate to estimate the GHG emissions reductions associated with biofuel production over a 30-year time horizon (See Figure 2.1-3).^{LLLLLLL} The choice of discount rate is discussed in detail in the preamble to the proposed rule.

While EPA believes the methodology presented here represents a robust and scientifically credible approach, we recognize that some calculations of GHG emissions are relatively straight-forward, while others are not. The direct, domestic emissions from biofuel production are relatively well known. The indirect, international emissions are the component of our analysis with the highest level of uncertainty. Despite uncertainties associated with international land use change, we would expect at least some international land use response as demand for crop land increases as a result of this rule. Although there are uncertainties associated with these estimates, it would be far less scientifically credible to ignore the effects of land use changes altogether than it is to use the best approach available to assess these known emissions sources.

Since lifecycle analysis is a new part of the RFS program, in addition to the formal comment period on the proposed rule, EPA is making multiple efforts to solicit public and expert feedback on our proposed approach. We are organizing a public workshop focused specifically on lifecycle analysis, and we plan to conduct formal external peer-reviews of key components of

^{LLLLLLL} Note that with a 0% discount rate over 30 years, emissions after year 30 are effectively discounted 100%.

our analysis, such as the international land use change assessment. Even after the final rule is issued, we recognize that the status of the science and availability of data will continue to evolve. Therefore, we plan to establish formal update procedures that include further peer review of the life cycle analysis framework and methodology.

2.1.4 Overall Climate Benefits, Temperature and Sea-Level Impacts

Our analysis of the overall GHG emission impacts of this proposed rulemaking was performed in parallel with the lifecycle analysis performed to develop the individual fuel thresholds described in previous sections. Consistent with the fuel volume feasibility analysis and criteria pollutant emissions evaluation, our analysis of the GHG impacts of this proposed rulemaking was conducted by comparing the difference between a 2022 reference case and a 2022 control case with volumes of renewable fuels meeting the RFS2 mandate. Based on the volume scenarios considered, with 36 billion gallons of biofuel in 2022, the one-time land use change impact results in 448 million metric tons of CO₂-eq. emissions. For this analysis we convert the NPV results for the 100 year 2% discount rate into an annualized stream such that the NPV of the annualized emissions will equal the NPV of the emission stream over 100 years with a 2% discount rate. This results in an annualized emission reduction of 160 million metric tons of CO₂-eq. emissions. Using a 30 year time horizon and 0% discount rate the annualized emission reduction is 150 million metric tons CO₂-eq emissions. EPA also estimated the temperature and sea-level impacts of RFS2, which are explained below in Section 2.10. We also calculated the monetized GHG benefits of the RFS2 program, which are explained in DRIA Chapter 5.

2.1.5 Chapter Overview

What follows in this Chapter is a detailed discussion of each component of EPA's lifecycle analysis. Section 2.2 provides background about lifecycle analysis in general, and EPA's current approach. Section 2.3 lays out the goals and scope of our analysis. Section 2.4 explains EPA's estimate of petroleum baseline lifecycle GHG emissions which renewable fuels are compared with. Section 2.5 discusses potential indirect impacts in the energy sector that may be caused by biofuel production. Section 2.6 provides a detailed explanation of EPA's estimates of direct and indirect agricultural sector impacts. Starting at Section 2.6.5, details are provided about EPA's estimate of emissions from land use change. Emissions produced during the conversion of renewable biomass to transportation fuel are discussed in Section 2.6.7. Section 2.7 explains our estimates of tailpipe emissions. Fuel-specific lifecycle GHG results are presented in Section 2.8, including a range of selective sensitivity analyses. Section 2.9 includes estimates of the overall climate benefits from EISA's revisions of the RFS program. Finally, Section 2.10 translates GHG emissions mitigation from the revised RFS program into global temperature and sea-level change projections.

2.2 Background for Estimating Fuel Lifecycle Greenhouse Gas Emissions

2.2.1 Lifecycle Analysis for the Original RFS Program

Lifecycle modeling, often referred to as fuel cycle or well-to-wheel analysis, assesses the net impacts of a fuel throughout each stage of its production and use including production / extraction of the feedstock, feedstock transportation, fuel production, fuel transportation and distribution, and tailpipe emissions. Use of a lifecycle approach to analyze different transportation fuels requires modeling and evaluation of many different input factors. The starting point for EPA's lifecycle work was the analysis conducted as part of the Renewable Fuel Standard rulemaking in response to the Energy Policy Act of 2005 (RFS1). For the RFS1 rule, we estimated GHG benefits based on lifecycle GHG modeling of the different renewable fuels mandated as part of the rule. EPA's approach for the RFS1 was to rely heavily on the "Greenhouse Gases, Regulated Emissions, and Energy Use in Transportation" (GREET) model, developed by the Department of Energy's Argonne National Laboratory (ANL).

However, it has become increasingly apparent that this type of first order lifecycle modeling has notable shortcomings, especially when evaluating the implications of biofuel policies.^{MMMMMMMM} Recently, lifecycle assessments have been divided into two major methodological categories: attributional and consequential.⁵⁰⁴

Attributional lifecycle assessment focuses on describing the environmentally relevant physical flows to and from a lifecycle and its subsystems.⁵⁰⁵ Attributional analyses are based on the direct suppliers of the necessary inputs to production, and co-products are handled by allocation. This means that the environmental impacts from biofuels production are simply split between the fuel and its co-products, using average data to determine the allocation shares.⁵⁰⁶ Therefore, an attributional lifecycle analysis of corn ethanol would account for the direct impacts of increased corn production, such as fertilizer and pesticide use, but it would ignore the indirect/marginal impacts of shifting crop patterns, such as decreased soybean production, that would also result. Attributional analysis also requires a choice about the basis for allocation among co-products (e.g., mass, energy content, market value, displacement), which can lead to significantly different results.

Consequential lifecycle assessment captures indirect/marginal impacts that are not explicitly included in attributional analyses. Consequential analyses account for activities within and outside the lifecycle that are affected by an incremental change within the lifecycle of the product under investigation. In other words, consequential lifecycle analyses study the consequences of changes in production or consumption from a market-based perspective, utilizing economic modeling to identify the ultimate impacts of a decision, such as a policy or a single project.⁵⁰⁷ This often implies the use of marginal data, and co-product allocation is typically avoided through system expansion. In other words, consequential analyses include alternative uses of constrained production factors, and marginal supply and demand on affected markets.⁵⁰⁸ Some researchers have concluded that the consequential approach provides more complete and accurate, but less precise results, while the attributional approach provides more precise results but with inherent blind spots that lead to less accurate results.⁵⁰⁹

^{MMMMMMMM}See also, Conceptual and Methodological Issues in Lifecycle Analysis of Transportation Fuels, Mark A. Delucchi, Institute of Transportation Studies, University of California, Davis, 2004, UCD-ITS-RR-04-45 for a description of issues with traditional lifecycle analysis used to model GHG impacts of biofuels and biofuel policies.

In fact, the main criticism EPA received in reaction to our previous RFS1 lifecycle analysis, which resembled a traditional attributional lifecycle analysis, was that we did not include important secondary, indirect, or consequential impacts of biofuel use, specifically:

- Biomass production focused on the feedstock used (e.g., corn) and did not capture other secondary market driven agricultural sector impacts, such as changes in other crop patterns and livestock production as a response to changing prices in biofuel feedstocks.
- Production of co-products from ethanol production required some type of allocation, either splitting emissions of fuel production between fuel and co-products or examining the use of co-products in other markets. For example in the case of corn ethanol, the co-product of ethanol production is a feed product that is assumed to replace the use of corn and soybean meal. Therefore, the emissions of producing an equivalent amount of these products are subtracted from the lifecycle assessment. This required modeling of the co-product economic market that is typically done outside of the lifecycle modeling.
- To the extent that they are included, land use impacts are typically confined to direct impacts, e.g., land converted to produce corn directly used for ethanol production. This does not capture effects of land use converted to produce crops that are indirectly impacted by increased biofuel production. One specific example of this is increased corn ethanol production in the U.S. could lead to decreased crop exports resulting in increased crop production and land use impacts internationally. Another example is corn acre increase resulting in less rice production acres and lower CH₄ emissions.
- The attributional modeling approach is not necessarily linked to a specific policy case, but is rather a general representation of biofuel production. Consideration of specific policies and interaction between different fuel volumes could have very distinct impacts especially in the agricultural sector.
- The replacement of petroleum fuel was represented by an average gallon of fuel. However, we recognize that an additional gallon of renewable fuel replaces the marginal gallon of petroleum fuel. To the extent that the marginal gallon of renewable fuel is from feedstocks grown on highly productive land and displaces petroleum fuel derived from oil sands or other types of crude oil that are associated with higher than average GHG emissions, replacing these fuels could have a larger GHG benefit. Conversely to the extent the marginal gallon of renewable fuel is from feedstocks grown on marginal land and displaces imported gasoline produced from light crude, replacing these fuels would have a smaller GHG benefit.
- The attributional modeling approach assumes that one Btu of renewable energy produced displaces one Btu of petroleum energy. In reality, the production of renewable fuels is expected to lower world energy prices (as discussed in Chapter

5.2), which in turn could lead to a marginal increase in world energy consumption and less than a one-for-one Btu replacement.

A key aspect of the issues described above is that the attributional lifecycle approach typically does not include economic modeling and the significant indirect impacts from price changes in the analysis. Therefore, to address some of these issues, we have updated our lifecycle methodology to include the use of economic models to perform a consequential type of lifecycle analysis.

The consequential approach of incorporating economic models into a lifecycle assessment is not a new concept. Most notably the Economic Input-Output Lifecycle Assessment (EIO-LCA) method has been employed in the past. The EIO-LCA method estimates the materials and energy resources required for, and the environmental emissions resulting from, activities in the overall economy. The EIO-LCA method was theorized and developed by economist Wassily Leontief in the 1970s based on his earlier input-output work from the 1930s for which he received the Nobel Prize in Economics. Researchers at the Green Design Institute of Carnegie Mellon University operationalized this method in the mid-1990s, once sufficient computing power was widely available to perform the large-scale matrix manipulations required in real-time. This work relies on static input-output tables of the U.S. economy to determine the full economy wide impacts of producing a product or service.

Mark Delucchi at the Institute of Transportation Studies of the University of California Davis has developed the Lifecycle Emissions Model (LEM) that looks at transportation fuels. He has also highlighted the need to look at market impacts when considering biofuel production and specifically to consider land use changes.⁵¹⁰ There have also been several studies examining the consequential or economic based life cycle assessment including several focusing on the agricultural sector.

Several studies and analyses conducted since the completion of the RFS1 rulemaking have also contributed to our understanding of the lifecycle environmental impacts of biofuel production. These studies, and others, have highlighted the potential impacts of biofuel production on the agricultural sector and specifically identified land use change impacts as an important consideration when determining GHG impacts of biofuels.^{511,512} In the meantime, the dramatic increase in U.S. production of biofuels has heightened the concern about the impacts biofuels might have on land use and has increased the importance of considering these and other indirect impacts in lifecycle analysis.

In order to improve our lifecycle modeling for this proposed rulemaking, EPA held a series of discussions with interested stakeholders during July and early August 2007 and again in early 2008. Stakeholder outreach included discussions with academics and other researchers, the California Air Resources Board (CARB), the U.S. Departments of Agriculture and Energy, and the following stakeholders who provided comments on RFS lifecycle analysis:

- American Petroleum Institute
- National Petroleum Refiners Association
- Renewable Fuels Association

- National Biodiesel Board
- DuPont
- Union of Concerned Scientists
- Natural Resources Defense Council
- Environmental Defense

Through dozens of meetings with this wide range of experts and stakeholders, EPA has shared and sought input on this methodology. We also have relied on the expertise of the U.S. Department of Agriculture (USDA) and the Department of Energy (DOE) to help inform many of the key assumptions and modeling inputs for this analysis and have gained their support for their use. Dialogue with the State of California and the European Union on their parallel, ongoing efforts in GHG lifecycle analysis has also helped inform EPA's methodology. While there is no consensus, the input we received through these interactions is reflected in the approach described here.

2.2.2 Updates for this Proposed Rulemaking

Based on discussions with these numerous stakeholders and review of literature, we have developed an approach for this proposed rulemaking that enhances the RFS1 modeling by including additional information and models to address concerns with our existing work by significantly strengthening and expanding our coverage of agricultural sector impacts.

Currently, no single model can capture all of the complex interactions associated with estimating lifecycle GHG emissions for biofuels, taking into account the "significant indirect emissions such as significant emissions from land use change" required by EISA. For example, some lifecycle analysis tools typically used in the past focus on process modeling—the energy and resultant emissions associated with the direct production of a fuel at a petroleum refinery or biofuel production facility. But this is only one component in the production of the fuel. Clearly in the case of biofuels, impacts from and on the agricultural sector are important, because this sector produces feedstock for biofuel production. Commercial agricultural operations make many of their decisions based on an economic assessment of profit maximization. Assessment of the interactions throughout the agricultural sector requires an analysis of the commodity markets using economic models. However, existing economy wide general equilibrium economic models are not detailed enough, on their own, to capture the specific agricultural sector interactions critical to our analysis (e.g., changes in acres by crop type) and would not provide the types of outputs needed for a thorough GHG analysis. As a result, EPA has used a set of tools that are best suited for each specific component of the analysis to create a more comprehensive estimate of GHG emissions. Where no direct links between the different models exist, specific components and outputs of each are used and combined to provide an analytical framework and the composite lifecycle assessment results.

To quantify the emissions factors associated with different steps of the production and use of various fuels (e.g., extraction of petroleum products, transport of feedstocks), we used the spreadsheet analysis tool developed by Argonne National Laboratories, the Greenhouse gases, Regulated Emissions, and Energy use in Transportation (GREET) model. This analysis tool includes the GHG emissions associated with the production and combustion of fossil fuels

(diesel fuel, gasoline, natural gas, coal, etc.). These fossil fuels are used both in the production of biofuels, (e.g., diesel fuel used in farm tractors and natural gas used at ethanol plants) and could also be displaced by renewable fuel use in the transportation sector. GREET also estimates the GHG emissions associated with electricity production required for biofuel and petroleum fuel production. For the agricultural sector, we also relied upon GREET to provide GHG emissions associated with the production and transport of agricultural inputs such as fertilizer, herbicides, pesticides, etc. While GREET provides direct GHG emissions estimates associated with the extraction-through-combustion phases of fuel use, it does not capture some of the secondary impacts associated with the fuel, such as changes in the composition of feed used for animal production which would be expected due to changes in cost. EPA addresses these secondary impacts through other models described later in this section. GREET has been under development for several years and has undergone extensive peer review through multiple updates. Of the available sources of information on lifecycle GHG emissions of fossil energy consumed, we believe that GREET offers the most comprehensive treatment of emissions from the covered sources.

For some steps in the production of biofuels, we use more detailed models to capture some of the dynamic market interactions that result from various policies. Here, we briefly describe the different models incorporated into our analysis to provide specific details for various lifecycle components.

To estimate the changes in the domestic agricultural sector (e.g., changes in crop acres resulting from increased demand for biofuel feedstock or changes in the number of livestock due to higher corn prices) and their associated emissions, we used the Forestry and Agricultural Sector Optimization Model (FASOM), developed by Texas A&M University and others. FASOM is a partial equilibrium economic model of the U.S. forest and agricultural sectors. EPA selected the FASOM model for this analysis for several reasons. FASOM is a comprehensive forestry and agricultural sector model that tracks over 2,000 production possibilities for field crops, livestock, and biofuels for private lands in the contiguous United States. It accounts for changes in CO₂, methane, and N₂O from most agricultural activities and tracks carbon sequestration and carbon losses over time. Another advantage of FASOM is that it captures the impacts of all crop production, not just biofuel feedstock. Thus, as compared to some earlier assessments of lifecycle emission, using FASOM allows us to determine secondary agricultural sector impacts, such as crop shifting and reduced demand due to higher prices. It also captures changes in the livestock market (e.g., smaller herd sizes that result from higher feed costs) and U.S. export changes. FASOM also has been used by EPA to consider U.S. forest and agricultural sector GHG mitigation options.⁵¹³

To estimate the impacts of biofuels feedstock production on international agricultural and livestock production, we used the integrated Food and Agricultural Policy and Research Institute (FAPRI) international models, developed by Iowa State University and the University of Missouri. These models capture the biological, technical, and economic relationships among key variables within a particular commodity and across commodities. FAPRI is a worldwide agricultural sector economic model that was run by the Center for Agricultural and Rural Development (CARD) at Iowa State University on behalf of EPA. The FAPRI models have been previously employed to examine the impacts of World Trade Organization proposals, changes in the European Union's Common Agricultural Policy, analyze farm bill proposals since

1984, and evaluate the impact of biofuel development in the United States. In addition, the FAPRI models have been used by the USDA Office of Chief Economist, Congress, and the World Bank to examine agricultural impacts from government policy changes, market developments, and land use shifts.

Although FASOM predicts land use and export changes in the U.S. due to greater demand for domestic biofuel feedstock, it does not assess how international agricultural production might respond to these changes in commodity prices and U.S. exports. The FAPRI model does predict how much crop land will change in other countries but does not predict what type of land such as forest or pasture will be affected. We used data analyses provided by Winrock International to estimate what land types will be converted into crop land in each country and the GHG emissions associated with the land conversions. Winrock has used 2001-2004 satellite data to analyze recent land use changes around the world that have resulted from the social, economic, and political forces that drive land use. Winrock has then combined the recent land use change patterns with various estimates of carbon stocks associated with different types of land at the state level. This international land use assessment is an important consideration in our lifecycle GHG assessment and is explained in more detail later in this chapter.

To test the robustness of the FASOM, FAPRI and Winrock results, we are also evaluating the Global Trade Analysis Project (GTAP) model, a multi-region, multi-sector, computable general equilibrium model that estimates changes in world agricultural production. Maintained through Purdue University, GTAP projects international land use change based on the economics of land conversion, rather than using the historical data approach applied by FAPRI/Winrock. GTAP is designed to project changes in international land use as a result of the change in U.S. biofuel policies, based on the relative land use values of cropland, forest, and pastureland. The GTAP design has the advantage of explicitly modeling the competition between different land types due to a change in policy. As further discussed in Section 2.6.5.3.3, GTAP has several disadvantages, some of which prevented its use for the proposal. We hope to correct several of these shortcomings between the proposed and final rule; therefore we continue to evaluate the use of the GTAP model as part of the final rule.

The assessments provided in this proposal use the values provided by the Intergovernmental Panel on Climate Change (IPCC) to estimate the impacts of N₂O emissions from fertilizer application. However, due to concern that this may underestimate N₂O emissions from fertilizer application⁵¹⁴, we are working with the CENTURY and DAYCENT models, developed by Colorado State University to update our assessments. The DAYCENT model simulates plant-soil systems and is capable of simulating detailed daily soil water and temperature dynamics and trace gas fluxes (CH₄, N₂O, NO_x and N₂). The CENTURY model is a generalized plant-soil ecosystem model that simulates plant production, soil carbon dynamics, soil nutrient dynamics, and soil water and temperature. We anticipate the results of this new modeling work will be reflected in our assessments for the final rule. More description of this ongoing work is included in the Section 2.6.2.2.

To estimate the GHG emissions associated with renewable fuel production, we used detailed ASPEN-based process models developed by USDA and DOE's National Renewable

Energy Laboratory (NREL). While GREET contains estimates for renewable fuel production, these estimates are based on existing technology. We expect biofuel production technology to improve over time, and we projected improvements in process technology over time based on available information. These projections are discussed in DRIA Chapter 4. We then utilized the ASPEN-based process models to assess the impacts of these improvements. We also cross-checked the ASPEN-based process model predictions by comparing them to a number of industry sources and other modeling efforts that estimate potential improvements in ethanol production over time, including the Biofuel Energy Systems Simulator (BESS) model. BESS is a software tool developed by the University of Nebraska that calculates the energy efficiency, greenhouse gas (GHG) emissions, and natural resource requirements of corn-to-ethanol biofuel production systems. We used the GREET model to estimate the GHG emissions associated with current technology as used by petroleum refineries, because we do not expect significant changes in petroleum refinery technology.

We used the EPA-developed Motor Vehicle Emission Simulator (MOVES) to estimate vehicle tailpipe GHG emissions. The MOVES modeling system estimates emissions for on-road and nonroad sources, covers a broad range of pollutants, and allows multiple scale analysis, from fine-scale analysis to national inventory estimation.

Finally, for the FRM we intend to use the Energy Information Administration's National Energy Modeling System (NEMS) to estimate the secondary impacts on the energy market associated with increased renewable fuel production. NEMS is a modeling system that simulates the behavior of energy markets and their interactions with the U.S. economy by explicitly representing the economic decision-making involved in the production, conversion, and consumption of energy products. NEMS should model the secondary impacts that greater renewable fuel use may have on the prices and quantities of other sources of energy, and the greenhouse gas emissions associated with these changes in the energy sector. It was not possible to complete this analysis in time for the NPRM.

While EPA is using the most state-of-the-art tools available today for each of the lifecycle components considered, we understand the concern that using multiple models necessitates integrating these models and, where possible, applying a common set of assumptions. As discussed later in this chapter, this is particularly important for the two agricultural sector models, FASOM and FAPRI, which are being used in combination to describe the agricultural sector impacts domestically and internationally. As described in more detail in the DRIA Chapter 5, we have worked with the FAPRI and FASOM models to align several key assumptions. As a result, the projected agricultural impacts described in Section 2.6 are relatively consistent across both models. One outstanding issue is the differences between the modeling results associated with increased soybean based biodiesel production. We intend to further refine the soybean biodiesel scenarios for the final rule.

Figure 2.2-1 graphically shows the different models used and what parts of the lifecycle they are used to represent.

Figure 2.2-1. System Boundaries and Models Used

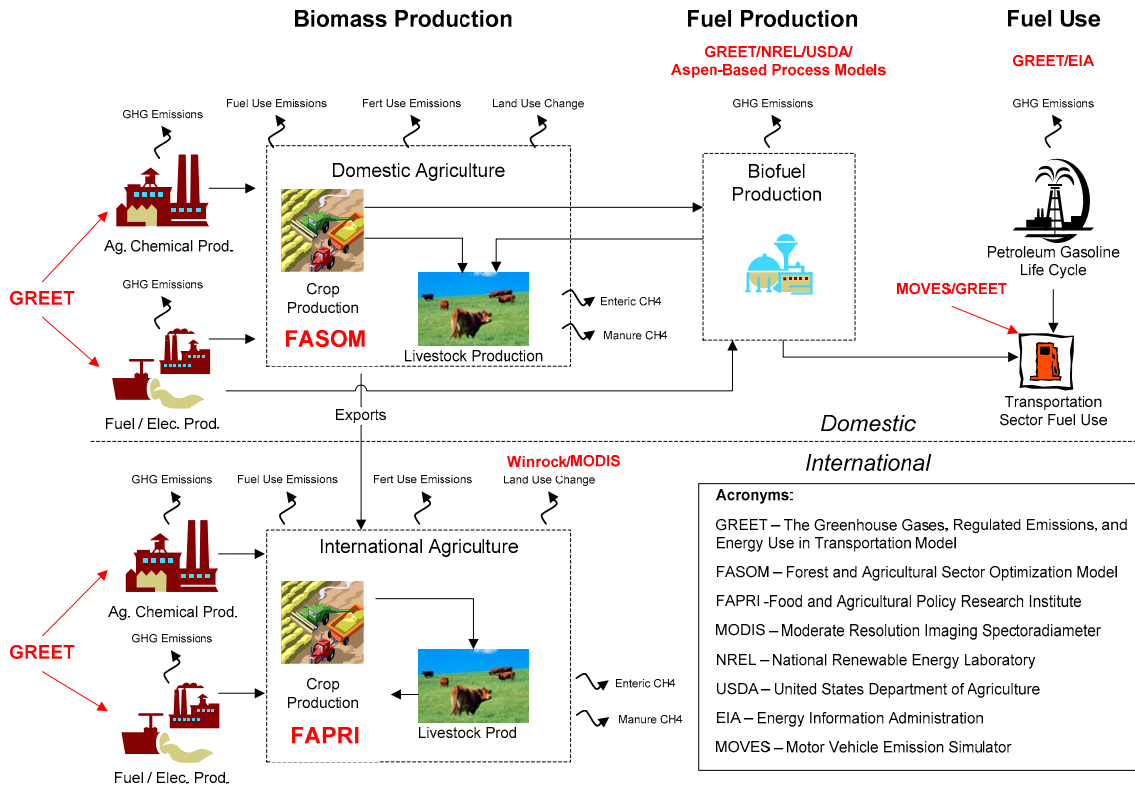

2.3 Goal and Scope of This Analysis

Lifecycle analysis is used in several ways for this proposed rulemaking. Fuel-specific GHG reductions are used to develop threshold determinations for specific fuels. Lifecycle analysis is also used to determine the overall impact of the rulemaking on GHG emissions worldwide.

The analysis conducted to assess the fuel-specific GHG performance relative to the thresholds in the standards is described in Sections 2.3 through 2.8. The analysis conducted to determine the overall GHG emission impact of the rulemaking is provided in Section 2.9.

2.3.1 Goal

The proposed rulemaking involves determining lifecycle GHG impacts of specific fuels and fuel pathways for comparison with thresholds as defined in the legislation. Obligated parties will be required to use mandated quantities of renewable fuels, but only fuels that meet the GHG thresholds can qualify under the program. The lifecycle GHG reductions represent the GHG differences between renewable fuels relative to the petroleum-based gasoline and diesel that they displace. The lifecycle methodology described here is used to determine the GHG displacement

values for different renewable fuels to be compared to the thresholds. Therefore this analysis will provide:

- Amount of GHG emissions (in grams, lb., tons, etc.) per amount of fuel produced (per btu) for both conventional petroleum based fuels and renewable fuels.
- Results are combined to quantify the emission change per btu of renewable fuel compared to that for the conventional fuel replaced.

2.3.2 Scope

2.3.2.1 Scenario Analysis

To quantify the lifecycle GHG emissions associated with the increase in renewable fuel mandated by EISA, we needed to compare the impacts of renewable fuels with EISA to a reference case without EISA. Since it is not practical or workable to conduct such an analysis and come up with factors for every year, to carry out this analysis we chose to look at the final year of the RFS2 standards when they are fully phased in. For our reference case we assumed a “business as usual” volume of a particular renewable fuel based on what would likely be in the fuel pool in 2022 without EISA as predicted by the Energy Information Agency’s Annual Energy Outlook (AEO) for 2007 (which took into account the economic and policy factors in existence in 2007 before EISA). For our control case we assumed the higher volumes of renewable fuels as mandated by EISA for 2022. For each individual biofuel, we analyzed the incremental impact of increasing the volume of that fuel to the total mix of biofuels needed to meet the EISA requirements while holding volumes of other fuels constant. Any changes between now and 2022 in factors such as crop yields, energy costs, or production plant efficiencies, both domestically and internationally, are reflected in both scenarios. Rather than focus on the impacts associated with a specific gallon of fuel and tracking inputs and outputs across different lifecycle stages, we determined the overall aggregate impacts across sections of the economy in response to a given volume change in the amount of biofuel produced. We then normalize those impacts to a gallon of fuel by dividing total impacts over the given volume change. In the case of overall rule impacts, we analyze the change in reference vs. control case volumes for all fuels together and take the absolute GHG results (e.g., do not normalize the overall rule impacts).

We did not calculate the emission impacts for each gallon of fuel based upon its unique production characteristics which could vary widely across the nation (e.g., a gallon of ethanol produced using corn grown in Iowa may have different direct lifecycle emissions impacts than a gallon of ethanol produced at an identical facility in Nebraska using corn grown in Nebraska due to regional differences in agricultural practices. However, on a lifecycle basis, considering the indirect impacts in the context of the entire corn market they are not different). Rather, we determined the overall aggregate impacts across sections of the economy in response to a given volume change in the amount of biofuel produced. In the case of agricultural impacts, we assessed the impact on the entire U.S. agricultural system that would result from expanded demand for biofuel feedstock. We then normalized those impacts to a gallon of fuel by dividing total impacts over the renewable fuel volume change between our business as usual case and the EISA volumes. Similarly, we estimated the typical emissions impact of a type of biofuel production facility (e.g., a plant that uses the dry mill process to turn corn starch into ethanol).

The emissions assessment from a typical facility was then ascribed to all biofuel produced across facilities using that same basic technology.

There are several important implications associated with this methodology. First, this analysis focuses on the average impact of an increase in fuel produced using a technology pathway and does not distinguish the emission performance between biofuel production plants using the same basic production technology and type of feedstock. Thus it does not account for relatively small differences in facility design or operation which may affect the lifecycle GHG performance at that facility.

Second, the results presented here are based on the GHG impacts of the volumes analyzed. For corn ethanol the impact represents the change in GHG emissions when national corn ethanol production increases from 12.4 to 15 Bgal which are the estimated volumes in corn ethanol production that would occur in 2022 without and then with EISA mandates in place. The GHG impact is then normalized to a per gallon or Btu basis in relation to gasoline. These values are used to represent every gallon of corn ethanol produced throughout the program. The per gallon impact based on different volume changes could be different than the incremental impact studied. For example, modeling a change from 0 to 15 Bgal would allow an assessment of the average GHG impact for all 15 Bgal of corn ethanol. As discussed in Section 2.8, we examine this issue through a sensitivity analysis where we consider a change in corn ethanol volumes from 8.7 to 12.4 Bgal and plan to provide a broader set of assessments for the final rule. We described corn ethanol here, but the other renewable fuels were assessed in the same manner.

Third, by focusing on 2022, this analysis does not track how biofuel GHG emission performance may change over time between now and 2022. While our estimates are based on the GHG emissions for each biofuel for a specific volume change in 2022, we recognize that an alternative approach would be to create incremental GHG emission curves for different volumes and different years. Section 2.8 provides a sensitivity analysis of the year of analysis, which includes corn ethanol lifecycle GHG results for 2012 and 2017. As discussed above, we believe modeling the results in 2022 provides a representative assessment of the GHG impact of the additional biofuel mandated by EISA.

Finally, several of the lifecycle emission impacts for one fuel are interrelated with those of another fuel, in particular the land-use changes. For our analysis of the overall GHG impacts of the program (discussed in section 2.9), we modeled all of the fuel changes simultaneously to determine the land-use impact. However, from that analysis it is not possible to differentiate the contribution of the land-use change to one fuel vs. another. As a result, for this analysis we had to model the impacts of just one fuel change at a time. In doing this we have held the other fuel volumes constant at their mandated levels in order to best approximate the impacts a single fuel change would have in the context of the full RFS2 standard volumes.

We used the same approach to determine the lifecycle GHG emissions for corn ethanol, cellulosic ethanol, biodiesel produced from soybean (and other vegetable) oils, and biodiesel produced using waste oils as feedstock. For waste oils, we note that no land use changes are included in the FASOM assessment, because any land use impacts are attributed to the original

purpose of the feedstock (e.g., the use of the vegetable oil for cooking or the production of animals for their meat), rather than the biofuel produced from the recovered waste material.

FASOM does not model feedstocks for fuels produced outside the U.S. We addressed imported ethanol by analyzing the difference in total GHG emissions based on two 2022 scenarios using only the results from FAPRI modeling runs: (1) the business as usual reference case volume of 0.6 Bgal and (2) an RFS2 projected volume of 3.1 Bgal of imported sugarcane ethanol.

Current models present some challenges in estimating GHG lifecycle emissions for cellulosic biofuels. The version of FASOM we used for this proposal did not include the forestry module, and therefore, we did not model forest products or forest waste as a renewable fuel feedstock. FASOM does have a module for the forest sector that EPA used in the past to assess forest impacts of changes in U.S. policies. The forestry module works much like the agricultural sector module in assessing likely outcomes; however, the data populating the forestry module is currently being updated to reflect the most recent information, and was not available in time to use in analyses for this proposal. EPA anticipates that the FASOM forestry module will be available for the final rule and intends to use it in the final rule assessments. We also note that inclusion of the forestry module will potentially allow the FASOM model to use some currently forested lands for crop production or pasture. To the extent this occurs, our assessment of the lifecycle impacts of farm crop changes may also be impacted. In addition, FAPRI does not include switchgrass or similar energy crops, and can only use corn stover or other food crop residues as feedstock in predicting cellulosic biofuel impacts. To overcome this limitation, we assumed that increased domestic switchgrass production would result in a decrease in U.S. crop exports, because switchgrass competes with other crops for acreage. We allowed the FAPRI model to draw on additional CRP acres to represent increased demand for acreage for energy crops.

For biofuels made from wastes and byproducts (e.g., MSW, rendered fats and waste oils and corn stover feedstock), we assumed no land use changes, because these biofuel feedstocks do not compete for domestic crop acreage. For corn stover, we analyzed only the change in domestic GHG emission resulting from an increase in fertilizer replacement application rates to compensate for the removal of stover from the land.

Table 2.3-1 shows the different fuel scenarios considered under the different models used.

Table 2.3-1. Fuel Volume Scenarios Considered in This Analysis

Fuel	Model	Volume (Billions of Gallons)		
		Low Volume	High Volume	Net Change
Corn Ethanol	FASOM & FAPRI	12.4	15	2.6
		8.7	12.4	3.7
Switchgrass Ethanol	FASOM	1.1	5.7	4.6
	FAPRI	0	3.2	3.2
Biodiesel	FASOM & FAPRI	0.4	0.7	0.3
Corn Stover Ethanol	FASOM	0	7.6	7.6
Sugarcane Ethanol	FAPRI	0.6	3.1	2.5

2.3.2.2 System Boundaries

It is important to establish clear system boundaries in this analysis. By determining a common set of system boundaries, different fuel types can then be validly compared. As described in the previous section, we have assessed the direct and indirect GHG impacts in each stage of the full fuel lifecycle for biofuels and petroleum fuels. Figure 2.3-1 provides a simplified diagram describing the system studied.

Figure 2.3-1. Simplified Lifecycle System Diagram

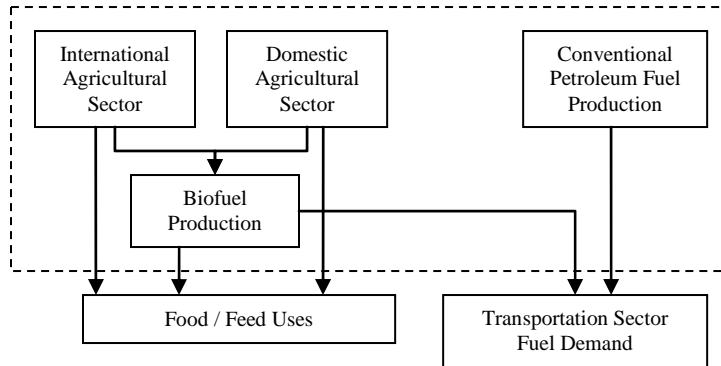

The different fuel use volume scenarios will be compared on delivering the same functions, in this case providing for both the agricultural sector market and transportation fuels market. Within the overall system shown in Figure 2.3-1, the unit process listed in Table 2.3-2 will be considered.

Table 2.3-2. Unit Processes Considered

Biofuel	Petroleum-Based Fuel
Feedstock Agriculture	Crude Oil Extraction
Feedstock Transport	Crude Oil Transport
Feedstock Processing & Biofuel Production	Refining
Biofuel Transport and Distribution	Fuel Transport and Distribution
Biofuel Tailpipe Emissions	Fuel Tailpipe Emissions

In setting system boundaries for this analysis, we use a consistent approach across all fuels to determine what is included in the system boundaries considered. In this way renewable, alternative and petroleum based fuels are all compared based on the same system boundaries. In general this type of analysis could be expanded to cover many different sectors of the economy, with diminishing impact on the overall results. Therefore, we rely on internationally accepted lifecycle assessment standards, developed by the International Organization for Standardization (ISO), when setting the system boundaries of this analysis. Based on the ISO standards we consider environmental significance as a cut off criteria for what to include in our system boundaries.

Included in each unit process shown in Table 2.3-2 are the emissions and energy use associated with that operation as well as upstream components that feed into it. For example, the feedstock agriculture stage includes emissions from fuel used in tractors as well as from producing and transporting the fertilizer used in the field. Electricity production emissions are included in almost all of the stages shown. For direct impacts, this results in system boundaries that include operation-related activities, but not infrastructure-related activities. As such, while we do include the emissions associated with the operation of farm equipment and trucks used for feedstock / fuel transportation we do not include the emissions associated with the production of the equipment or vehicles. Furthermore, we include the emissions from the operations of biofuel production plants and petroleum refineries but we do not include emissions from producing the material used to construct the facilities.

This decision was based on analysis done for the RFS1 rulemaking which found that including farm equipment production energy use and emissions increases ethanol lifecycle energy use and GHG emissions and decreases the percent reduction in GHG emissions from corn ethanol in comparison to gasoline by approximately 1 percent. Furthermore, to be consistent in the modeling, if system boundaries are expanded to include production of farming equipment they should also be expanded to include producing other material inputs to both the ethanol and petroleum lifecycles. For example, this expansion of system boundaries would include the energy use and emissions associated with producing concrete and steel used in the petroleum refinery. The net effect of this would be a slight increase in both the ethanol and petroleum fuel lifecycle results and a smaller or negligible effect on the comparison of the two.

In determining what indirect impacts to include in the system boundaries of this analysis we again focus on those sources that will have the biggest effect on overall results. Therefore, for the analysis used in this proposed rulemaking we have included significant direct and indirect

domestic and international agricultural sector impacts. We also plan to consider indirect effects in energy markets due to increased use of biofuels in the transportation sector, and changes in fossil fuel markets due to increased fuel (primarily natural gas) used in the ethanol production sector. EPA is still developing the modeling approach to capture these energy sector indirect effects and some preliminary analysis is presented in Section 2.5.

In comparing renewable and alternative fuels to the petroleum fuel that they replace we have made the assumption that the amount of conventional fuel no longer consumed – that is, displaced – as a result of the use of the replacement renewable or alternative fuel is equal on an energy basis. This assumes that vehicle energy efficiency will not be affected by the presence of renewable fuels (i.e., efficiency of combusting one Btu of ethanol is equal to the efficiency of combusting one Btu of gasoline). Therefore, for every Btu of ethanol produced there is a corresponding decrease of a Btu of gasoline use, and associated quantity of crude oil is not extracted or processed to make this gasoline. Some studies have shown that because of the increased octane content of ethanol (and specifically E85) vehicle efficiency may actually be slightly improved with use of E85 vs. gasoline. This would imply that a Btu of ethanol would actually displace slightly more than a Btu of gasoline because of improved engine efficiency. However, these studies are not conclusive enough for us to include in our analysis at this point. This is something we will be considering for the final rule and may add as a sensitivity case.

This type of modeling also does not allow for behavioral changes that could occur, what we call the “secondary oil market” impacts. For example, a worldwide reduction in oil prices could result from the increased use of renewable fuels (as discussed in Chapter 5.2). To the extent world fuel prices are decreased, demand and consumption would tend to increase; this impact is labeled the “international oil takeback effect.” The result could be less than a Btu of gasoline displaced for each gallon of ethanol produced. We have not yet conducted the modeling to quantify the magnitude of this effect or factored it into our lifecycle analysis. However, we are looking at options to consider this impact in the final rule analysis, as discussed in Section 2.5.

2.3.2.3 Environmental Flows Considered

The lifecycle analysis discussed here evaluates the impacts of increased renewable fuel use on greenhouse gas emissions. EISA specifies a definition of greenhouse gases to include in the analysis:

The term ‘greenhouse gas’ means carbon dioxide, hydrofluorocarbons, methane, nitrous oxide, perfluorocarbons, sulfur hexafluoride. The Administrator may include any other anthropogenically emitted gas that is determined by the Administrator, after notice and comment, to contribute to global warming.

EISA also specifies that the mass values for all greenhouse gases are adjusted to account for their relative global warming potential.

The relative global warming contribution of emissions of various greenhouse gases is dependant on their radiative forcing, atmospheric lifetime, and other considerations. For

example, on a mass basis, the radiative forcing of CH₄ is much higher than that of CO₂, but its effective atmospheric residence time is much lower. The relative warming impacts of various greenhouse gases, taking into account factors such as atmospheric lifetime and direct warming effects, are reported on a ‘CO₂-equivalent’ basis as global warming potentials (GWPs). The GWPs used in this analysis were developed by the UN Intergovernmental Panel on Climate Change (IPCC) as listed in their Second Assessment Report, and are shown in Table 2.3-3. Second assessment report values are used to be consistent with current standards for international reporting of GHG emissions.

**Table 2.3-3.
100 Year Global Warming Potentials for Greenhouse Gases**

Greenhouse Gas	GWP
CO ₂	1
CH ₄	21
N ₂ O	310

Greenhouse gases are measured in terms of CO₂-equivalent emissions, which result from multiplying the GWP for each of the three pollutants shown in the above table by the mass of emissions for each pollutant. The sum of impacts for CH₄, N₂O, and CO₂, yields the total effective GHG impact. Other GHGs like HFCs, PFCs and SF₆ are not released in significant amounts over the lifecycle of renewable or petroleum fuels, and are therefore not tracked in this analysis. Other non-GHG climate impacts like albedo (light reflectance), land surface roughness, hydrologic and energy flux, and loss of forest aerosols, while potentially an important aspect of climate impacts associated with land use change, are currently outside the scope of this analysis.

Other environmental flows besides GHG emissions are also considered in our analysis for this rulemaking. Criteria and toxic air pollutants are modeled and results are described in Chapter 3 of the DRIA. Water use and impacts are also considered and are described in Chapter 6 of the DRIA.

2.3.2.4 Data Quality

Lifecycle analysis is a data intensive process and the results are affected by data quality. Data quality may be defined by specific characteristics that describe both quantitative and qualitative aspects of data, as well as the methods used to collect and integrate those data into the analysis. The quality of data used can be characterized by how well the geographic, technical and temporal aspects of the data match the goals and scope of the analysis in question.

The quality of the data used in this analysis was classified based on its geographic, technical and temporal relevance to the goals of the study as follows:

Geographic coverage – this analysis was conducted without any regard to the geographic attributes of where emissions or energy use occurs. The benefits of this proposed rule represent global reductions in GHG emissions and energy use, not just those occurring in the U.S. For example, the savings associated with reducing overseas

crude oil extraction and refining are included here, as are the international emissions associated with producing imported ethanol. Data for agricultural sector impacts include both U.S. and international defaults. Agricultural commodity production in other countries was based on data specific to those areas (e.g., fertilizer production in other countries). Land use change was specifically modeled in different countries, impacts of land use change were based on factors representing sub-country level land characteristics, and for areas where data was not available averages were used.

Technology coverage – this analysis models industries that do not exist yet – cellulosic ethanol and renewable diesel for example. Therefore assumptions based on existing information and modeling were made to represent these industries rather than relying on existing facility data. Even for industries that currently exist there is expected to be a range of technology development over time. For this analysis we have made our best projections for what the industry may look like by 2022. There is expected to be considerable variation in the technologies used, for example combined heat and power and corn oil fractionation in a dry mill ethanol plant. To account for this we have looked at different fuel technology pathways as shown in Section 2.6.7.

Temporal coverage – this analysis considered impacts in 2022. Therefore we modeled future data; we projected ethanol production in 2022 based on process models – consistent with cost analysis used in this proposed rulemaking. For example, this assumed that future plants will be more energy efficient than current plants. Agricultural sector models also represented 2022 values including improvements in yields and cropping patterns.

2.3.2.5 Uncertainty Analysis

While EPA believes the methodology presented here represents a robust and scientifically credible approach, we recognize that some calculations of GHG emissions are relatively straight-forward, while others are not. The direct, domestic emissions are relatively well known. These estimates are based on well-established process models that can relatively accurately capture emissions impacts. For example, the energy and GHG emissions used by a natural gas-fired ethanol plant to produce one gallon of ethanol can be calculated through direct observations, though this will vary somewhat between individual facilities. The indirect domestic emissions are also fairly well understood, however these results are sensitive to a number of key assumptions (e.g., current and future corn yields, energy prices, etc.). We address uncertainty in this area by testing the impact of changing these assumptions on our results. Finally, the indirect, international emissions are the component of our analysis with the highest level of uncertainty. For example, identifying what type of land is converted internationally and the emissions associated with this land conversion are critical issues that have a large impact on the GHG emissions estimates. We address this uncertainty by using sensitivity analyses to test the robustness of the results based on different assumptions. We also identify areas of additional work that will be completed prior to the final rulemaking. For example, while we utilized an approach using comprehensive agricultural sector models and recent satellite data to determine the GHG emissions resulting from international land use impacts, we are also considering an alternative methodology (the analyses using GTAP) that estimates changes in land use based on

the relative land use values of cropland, forest, and pastureland. Additionally, we are considering country-specific information which may allow us to better predict specific trends in land use such as the degree to which marginal or abandoned pasture land will need to be replaced if used instead for crop production.

Despite the uncertainty associated with international land use change, we would expect at least some international land use change to occur as demand for crop land increases as a result of this rule. Furthermore, the conversion of crop land will lead to GHG emission from land conversion that must be accounted for in the calculation of lifecycle GHG emissions. We believe that uncertainty in the effects and extent of land use changes is not a reason for not accounting for land use change emissions. Although there are uncertainties associated with these estimates, it would be far less scientifically credible to ignore the effects of land use change altogether than it is to use the best approach available to assess these known emissions.

There are several ways of specifically dealing with uncertainty in this analysis. One approach would be to perform statistical analysis, applying distribution curves to each input and running Monte Carlo analysis to determine a range of results. While this may be the most intellectually pleasing approach in theory, there are several significant barriers to this approach. Most significantly, it is difficult to determine scientifically-defensible probability distribution functions for all (or even the most significant) input variables. Applying functions that are not well understood may serve to misstate uncertainty. Furthermore, an analysis that treats all variables independently would not capture the fact that there are links between inputs with potentially conflicting impacts on results (e.g., higher fertilizer use linked to higher crop yields). To do this correctly, we need to determine the covariance matrix of all variables, or risk further obscuring the degree of true uncertainty in the analysis.

Another approach to examining these uncertainties is to identify variables with the greatest impact on the overall results and apply sensitivity analysis. This is the approach we have taken, for example, looking at a range of ethanol plant types, as well as ranges of land use change factors. In this way we bound the results with high and low cases. The challenge in a complicated analysis with so many variables, of course, is to ensure that we have identified the most significant factors influencing GHG emissions, and that our choices of low and high cases accurately encompass the range of possible outcomes. We note that further research on key variables will allow for a more robust assessment of these impacts in the future.

2.4 Baseline Gasoline and Diesel Fuel

2.4.1 Modeling Approach

EISA specified the baseline petroleum gasoline and diesel fuel that renewable fuels would be compared to for assessing their performance in comparison to the thresholds.

The term 'baseline lifecycle greenhouse gas emissions' means the average lifecycle greenhouse gas emissions, as determined by the Administrator, after notice and

opportunity for comment, for gasoline or diesel (whichever is being replaced by the renewable fuel) sold or distributed as transportation fuel in 2005.

To estimate the lifecycle GHG emissions associated with baseline petroleum-based gasoline and diesel fuel, we based our analysis on the GREET model. Lifecycle energy use and associated emissions for petroleum-based fuels in GREET are calculated based on energy efficiency metrics for the different processes involved in petroleum-based fuels production. The energy efficiency metric is a measure of how many Btus of input energy are needed to make a Btu of output product. GREET has assumptions on energy efficiency for different finished petroleum products as well as for different types of crude oil.

GREET also has assumptions on the mix of energy sources used to provide the energy input which determine GHG emissions. The GHG emissions associated with petroleum fuels are based on the emissions from producing and combusting the input energy sources (with non-combustion sources included where applicable).

The following sections describe the GREET assumptions for different petroleum-based fuels production processes and final products.

2.4.2 Crude Oil Extraction

GREET has assumptions for different types of crude oil extraction, conventional crude and oil sands crude.^{NNNNNNN} The values for conventional crude oil are assumed to represent average crude oil extraction, including domestic and foreign production, and onshore, offshore and enhanced oil recovery processes. Oil sands recovery was used in this analysis to represent Canadian oil sands recovery. The assumptions for each type of crude oil extraction are shown here.

Conventional crude oil extraction is assumed to have an energy efficiency metric of 98%. This means that every one mmBtu of crude oil produced requires 1,020,408 Btu of energy input. One mmBtu of that input is crude oil feedstock (from the ground) that ends up in the final product and therefore only 20,408 Btu of additional process energy is required. Table 2.4-1 shows the breakout of the energy sources used to provide the additional process energy.

^{NNNNNNN} Oil sands crude is also commonly referred to as tar sands.

Table 2.4-1. Conventional Crude Oil Production

Process Fuel	Share of Input Energy (%)	Energy use (Btu/mmBtu of fuel throughput)
Crude oil	1.0%	204
Residual oil	1.0%	204
Diesel fuel	15.0%	3,057
Gasoline	2.0%	408
Natural gas	61.9%	12,635
Electricity	19.0%	3,872
Feed loss	0.1%	28
<i>Total:</i>	<i>100%</i>	<i>20,408</i>

The GHG emissions from conventional crude oil extraction are calculated by multiplying the Btus of the different types of energy inputs by emissions factors for combustion of those fuel sources. The emission factors for the different fuel types are from GREET based primarily on assumed carbon contents of the different process fuels. The emissions from producing electricity are also taken from GREET and represent average U.S. grid electricity production emissions. In addition to process energy GHG emissions, GREET also assumes there are also GHG emissions from associated flaring of natural gas at the oil well, assuming 16,800 Btu of natural gas is flared per mmBtu of crude oil produced. The GHG emissions from flared natural gas are again based on emissions factors for natural gas combustion. GREET also accounts for fugitive methane emissions from crude oil extraction and processing, assuming that 13.15 g of fugitive methane is released per mmBtu of crude oil produced.

Similar to the assumptions for conventional crude oil extraction, GREET has assumptions about oil sands crude oil extraction. Oil sands can be either mined or recovered in situ - meaning in place, GREET has assumptions for both processes. The oil sands recovery processes include both extraction (surface or in situ) and separation systems to remove bitumen from sand and water.

Surface mining of oil sands involves open-pit mining techniques. About two metric tons of oil sands must be dug up, moved and processed to produce one barrel of oil. In situ recovery is used for bitumen deposits buried too deeply for mining to be practical. Cyclic steam stimulation (CSS) and steam-assisted gravity drainage (SAGD) are in situ recovery methods, which include thermal injection through vertical or horizontal wells. The following Tables show the energy efficiency metric and assumed energy sources used in oil sands extraction. GHG emissions from the oil sands extraction process are based on applying emission factors to the different energy inputs.

Table 2.4-2. Oil Sands Recovery: Bitumen Extraction – Surface Mining

Energy Efficiency 94.8%		
Process Fuel	Share of Input Energy (%)	Energy use (Btu/mmBtu of fuel throughput)
Diesel fuel	0.6%	329
Natural gas	82.3%	45,132
Electricity	17.1%	9,377
Feed loss	0.03%	14
<i>Total:</i>	<i>100%</i>	<i>54,852</i>

Table 2.4-3. Oil Sands Recovery: Bitumen Extraction – In-Situ Production

Energy Efficiency 84.3%		
Process Fuel	Share of Input Energy (%)	Energy use (Btu/mmBtu of fuel throughput)
Natural gas	97.2%	181,011
Electricity	2.8%	5,214
Feed loss	0.01%	14
<i>Total:</i>	<i>100%</i>	<i>186,239</i>

Once oil sands are extracted through either the surface mining or in situ process they are further processed for transportation. The energy efficiency metric and assumed energy input sources for the bitumen upgrading are shown in Table 2.4-4.

Table 2.4-4. Oil Sands Recovery: Bitumen Upgrading

Energy Efficiency 98.6%		
Process Fuel	Share of Input Energy (%)	Energy use (Btu/mmBtu of fuel throughput)
Natural gas	97.1%	13,787
Electricity	2.8%	397
Feed loss	0.1%	14
<i>Total:</i>	<i>100%</i>	<i>14,198</i>

In addition to the GHG emissions from the process energy used in the upgrading process, GREET also assumes hydrogen is needed as an input to the upgrading process. GHG emissions from hydrogen production, based on GREET defaults, are included in the emissions of bitumen upgrading. GREET assumes 84,187 Btu of hydrogen is used per mmBtu of oil sand crude produced through surface mining, and 32,364 Btu of hydrogen is used per mmBtu of oil sand crude produced through the in situ process.

Emission factors from GREET were used for bitumen extracted in-situ, bitumen extracted by surface mining, and light crude oil extraction. Emission factors from McCann (1999) were used to calculate GHG emissions from heavy oil and Venezuela extra heavy oil by considering the incremental extraction and processing emissions relative to the average of the light crudes analyzed by McCann.⁵¹⁵ Instead of using McCann GHG values directly we used these results to

determine a scaling factor for the heavy crudes compared to the conventional crude types. We then applied this scaling factor to the GREET conventional crude emissions to represent emissions from heavy crude production. The results of the crude oil production differentiation are shown below in Table 2.4-5.

**Table 2.4-5.
Scaling factors Used to Calculate Heavy Crude Extraction GHG Emissions**

Crude Production Emissions (gCO ₂ -eq. / mmBtu LHV of fuel produced)						
	Canadian Light	Brent North Sea	Saudi Light	Average "conventional"	Heavy Oil	Venezuela Extra Heavy Oil
Production Emissions	6,617	5,081	7,746	6,482	6,962	15,524
Scaling Factor					1.07	2.40

The importation of heavy crude oil and extra heavy crude oil in the U.S. comprises a relatively small but growing fraction of current total crude oil imports. Heavy crude oils are generally of higher density and higher viscosities compared to lighter crude oils and similarly, are not as readily extracted from reserves. The American Petroleum Institute’s “API Gravity” is commonly used to delineate light, medium, heavy and extra heavy crude oils. Although definitions can vary slightly, the U.S. Geological Survey (USGS) categorizes light crude oil as having an API gravity of at least 22° and viscosity less than 100 centipoise (cP).⁵¹⁶ Heavy oil, by contrast, is defined as an “asphaltic, dense, and viscous oil” with an upper API limit of 22° and viscosity between 100 – 10,000 cP. Heavy oil with an API less than 10° is defined as extra-heavy oil. Natural bitumen –also referred to in the literature as oil sand, tar sand, oil-impregnated sand, asphaltic sand, rock asphalt, bituminous rock, and bitumen-bearing rock– have a similar API range as extra-heavy oils but have viscosities greater than 10,000 cP.

To determine the mix of crudes used in 2005 to produce the gasoline and diesel baseline required by EISA, EPA analyzed the types of crude oils used in the U.S. by examining crude oil import data from the Energy Information Administration for 2005, which is based on reporting by refineries.⁵¹⁷ The amount of crude imports reported by refineries with API less than or equal to 22° – heavy oil – was approximately 2.9 million barrels per day (mmbd) in 2005 out of the 15.2 mmbd refinery net input in the U.S. estimated by EIA. Figure 2.4-1 below displays the break-down of U.S. heavy crude imports by country.

Figure 2.4-1. U.S. Imports of Heavy Crude Oil in 2005 (API of 22° or less)

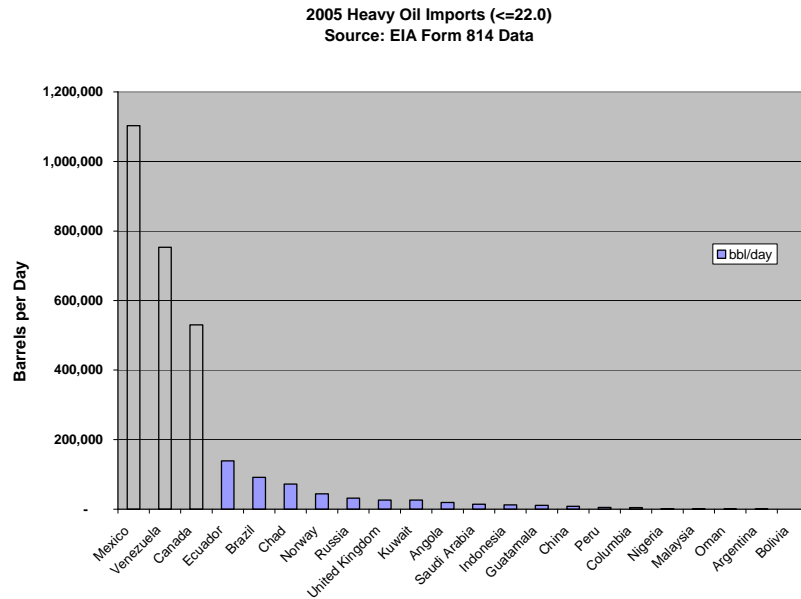

Note that this is an underestimate of the actual heavy crude oil, extra heavy crude oil, or bitumen used by U.S. refineries since a fraction of these crudes are upgraded at the country of origin and/or diluted with diluents (gas condensate, natural gas liquids or light crude) and transported to the U.S. These upgraded crude oils would then appear as imports with an API greater than 22° (i.e. light or medium crude oil). EPA has identified that crude oil from Venezuela and Canada would likely have the most upgrading of extra heavy crude oil or bitumen to synthetic crude, or syncrude, due to the nature of the reserves and current information regarding the crude oil types extracted. The International Energy Agency estimates that in 2005, Venezuela produced approximately 565,000 bpd of syncrude from its extra heavy oil reserves in the Orinoco oil belt.⁵¹⁸ An analysis of the production output from the four members of the Orinoco Belt Strategic Association shows that roughly three-fourths of the upgraded syncrude has an API greater than 22°.⁵¹⁹ Thus, out of the 3 mmbd of crude oil produced in Venezuela, approximately 19% was syncrude (i.e. 14% with API greater than 22° and 5% with API less than 22%). Applying these splits to the U.S. import data would result in roughly 145,000 bpd of syncrude from extra heavy oil, 715,000 heavy oil, and 684,000 light (or conventional) crude oils. This split would still likely underestimate the extra heavy oil/syncrude used by the U.S. since Venezuela tends to ship a greater fraction of its heavier crude oils to U.S. refineries that are specifically configured to handle heavier crude oils.

Estimates on the types of crude oil imported from Canada were also adjusted based on available information. Canadian production information for 2005 was obtained from statistical information from the Canadian Association of Petroleum Producers.⁵²⁰ Production of crude oil in Canada totaled 2.35 mmbd in 2005, with 35% of the volume comprised of light crude oil, 22% heavy crude oil, 23% from bitumen or synthetic crude obtained via surface mining, and 19% from bitumen produced from in-situ methods. Surface mining comprised over half of the Canadian bitumen extraction, but use of in-situ techniques is now growing at a faster rate due to the lower availability of surface bitumen and improvements in in-situ techniques.

Domestic production of heavy oil was not included in the EIA import data analyzed by the EPA.⁵²¹ To account for this, various estimates were used from different sources. In 2005, we estimate that roughly 475,000 bpd of heavy oil was produced in the U.S. with the vast majority produced in California.

A fraction weighted estimate of the crude oil types used in the U.S., calculated based on the data sources and calculations described above, was used in our estimation of the 2005 gasoline and diesel baseline. Note that this does not include crude-type breakdowns for finished products imported into the U.S. from overseas (e.g. Europe) or exported and consumed overseas, which may change the fractions slightly. Out of the 15.3 mmbd of crude oil reported to be used in the U.S. in 2005⁵²², approximately 5% was composed of bitumen-based syncrude (mainly from Canada), 1% was extra heavy crude oil based syncrude (mainly from Venezuela), and 23% was heavy crude oil, as shown in Figure 2.4-2.

Figure 2.4-2. Percent of U.S. Crude Oil by Source

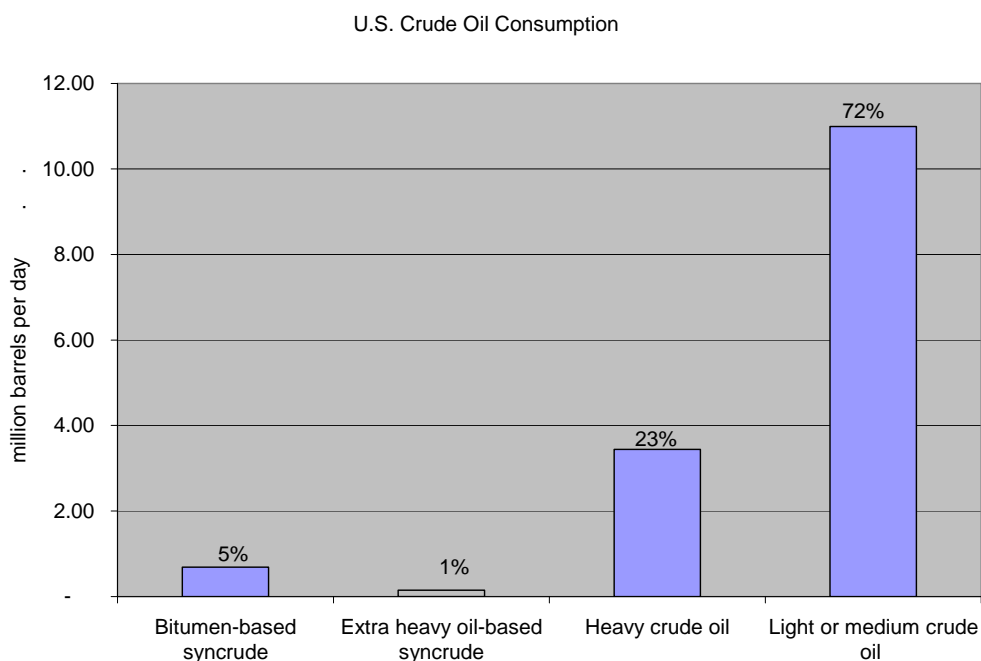

The emission factors for the 2005 baseline were adjusted based on the above weighting for the different types of crude oil.

2.4.3 Crude Transport

Transport of crude oil to the U.S. was based on GREET defaults, which are shown in the Figure 2.4-3. The figure indicates the percent of the different types of crude oil used (Canada and Mexico are assumed to include the Canadian oil sands imports) and associated modes of transportation and miles traveled for each mode. The GHG emissions are based on emission factors for each type of vehicle including capacity, fuel economy, and type of fuel used.

Figure 2.4-3. Crude Oil Transportation Assumptions

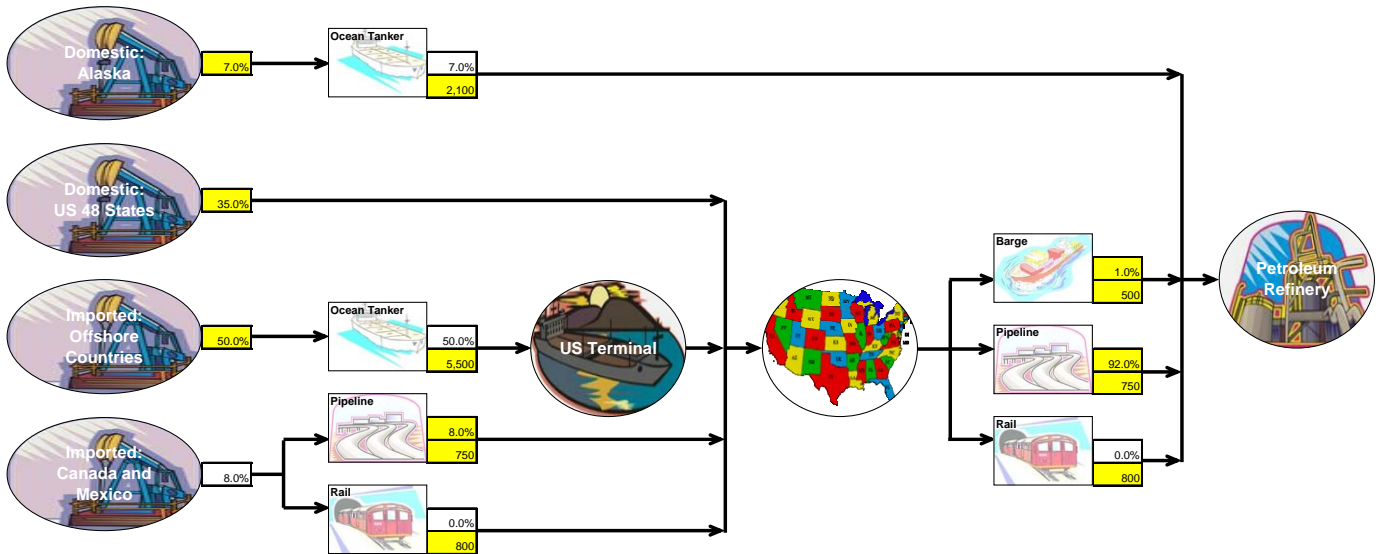

2.4.4 Refining

The GHG emissions associated with petroleum refining can also be calculated based on the energy efficiency of the refinery and the type of process energy fuel sources used. However, the refinery is producing a number of different petroleum-based products including different transportation fuels. Therefore, the total energy use and emissions from the refinery needs to be allocated to the different products.

The basis for the overall refinery energy efficiency in GREET are numerous linear programming model runs representing energy use in a typical refinery. Different refinery configurations with different slates of products produced will have different energy efficiencies. For calculating baseline GHG emissions associated with gasoline and diesel fuel we are assuming an average U.S. refinery, so defaults in GREET are reasonable for our analysis.

Allocation of the total refinery energy use and emissions to the different products can be done in a number of ways. Total energy use and emissions can be allocated based on the energy, mass, or economic value of the different output products. Alternately, energy use and emissions can be based on first breaking out total refinery energy use to the different refinery sub-processes (e.g., distillation, cracking, alkylation, isomeration, desulfurization), and then allocating energy from each sub process to the different products, for example 100% of alkylation used for gasoline. This type of sub process allocation would require a level of detail that was beyond the scope of this analysis. Therefore, we used the GREET default allocation which in general allocated 60–65% of total refining process fuel use to gasoline production, 18–22% to diesel production, and the remaining 13–22% to other petroleum products.

The refinery modeling runs and the allocation to different products results in the energy efficiency values for different types of gasoline and diesel fuel shown in Table 2.4-6.

Table 2.4-6. Refinery Energy Efficiency

Transportation Fuel Type	Energy Efficiency
Conventional Gasoline	87.7%
Reformulated Gasoline Feedstock	87.2%
Low Sulfur Diesel Fuel	89.3%

The following table shows the process fuel breakout and energy use for each transportation fuel.

Table 2.4-7. Refinery Energy Use

Process Fuel	Share of Input Energy (%)	Energy use (Btu/mmBtu of fuel throughput)		
		Conventional Gasoline	RFG Feedstock	Low Sulfur Diesel Fuel
Residual oil	3.0%	4,208	4,404	3,595
Natural gas	30.0%	42,075	44,037	35,946
Coal	13.0%	18,233	19,083	15,577
Electricity	4.0%	5,610	5,872	4,793
Refinery still gas	50.0%	70,125	73,395	59,910
<i>Total:</i>	<i>100%</i>	<i>140,251</i>	<i>146,789</i>	<i>119,821</i>

The GHG emissions from refining are calculated by multiplying the Btus of the different types of energy inputs by emissions factors for combustion of those fuel sources. The emission factors for the different fuel types are from GREET based primarily on assumed carbon contents of the different process fuels. The emissions from producing electricity are also taken from GREET and represent average U.S. grid electricity production emissions. In addition to process energy GHG emissions, GREET also assumes there are also non-combustion GHG emissions associated with petroleum refining. These emissions are also allocated to the different fuels based on the same energy efficiency ratios used to allocate energy use. The non-combustion CO₂ emissions amount to 1,172 g CO₂ per mmBtu of conventional gasoline, 1,214 g CO₂ per mmBtu of RFG blendstock, and 1,088 g CO₂ per mmBtu of low sulfur diesel fuel.

To represent baseline gasoline we considered the types of gasoline used in 2005. Based on EIA data on sales of gasoline to end users in 2005, 57.4% was conventional gasoline, 28.4% was reformulated gasoline and 14.2% was Californian reformulated gasoline. The California reformulated gasoline is represented in GREET as reformulated with slightly different assumptions about crude transport distances. We also considered imported finished product vs. domestically produced gasoline. According to EIA data, in 2005 6.0% of conventional gasoline used was imported and 7.7% of reformulated gasoline was imported. Imported gasoline was modeled the same as domestic for refinery emissions, except conventional crude was used to represent crude oil production impacts, instead of a domestic mix. To represent baseline diesel fuel use we used a similar analysis and assumed 100% low-sulfur diesel fuel and 8.0% imported finished product.

2.4.5 Fuel Transport

Transport of the finished petroleum product was also included in the baseline values for gasoline and diesel fuel. Transport included carriage from refinery to bulk terminal and from

bulk terminal to retail location. Transport of imported finished product was also included and was assumed to be transported by ocean tanker 2,600 miles to the U.S. Once in the U.S. both domestic and imports were assumed to be transported by the modes and distances shown in Tables 2.4-8 and 2.4-9.

Table 2.4-8. Gasoline Transport Assumptions

Refinery to Bulk Terminal			Bulk Terminal to Refueling Station	
Mode	Percent	Distance	Percent	Distance
Ocean Tanker	17	1,500	0	N/A
Barge	4	520	0	N/A
Pipeline	72	400	0	N/A
Rail	7	800	0	N/A
Truck	0	N/A	100	30

Table 2.4-9. Diesel Fuel Transport Assumptions

Refinery to Bulk Terminal			Bulk Terminal to Refueling Station	
Mode	Percent	Distance	Percent	Distance
Ocean Tanker	12	1,500	0	N/A
Barge	6	520	0	N/A
Pipeline	72	400	0	N/A
Rail	7	800	0	N/A
Truck	0	N/A	100	30

The GHG emissions from transport of gasoline and diesel fuel were based on GREET default emission factors for each type of vehicle including capacity, fuel economy, and type of fuel used.

2.4.5 Petroleum Fuel 2005 Baseline Well-To-Tank GHG Emissions

The results of each of the lifecycle stages for the petroleum fuels were combined to generate a well-to-tank lifecycle GHG value for 2005 gasoline and diesel fuel as shown in Table 2.4-10. Tailpipe combustion emissions for the two fuels are described in Section 2.7. When the tailpipe emissions are included, the well-to-wheel results for baseline gasoline and diesel fuel are 98,395 and 96,843 gCO₂eq/mmBtu respectively.

**Table 2.4-10.
Petroleum Fuel Baseline Well-To-Tank GHG Emissions
(g/mmBtu of fuel)**

	CH ₄	N ₂ O	CO ₂	CO ₂ -eq.
Diesel Fuel	106	0.25	15,074	17,381
Gasoline	107	0.27	16,762	19,102

In December 2008, the U.S. Department of Energy's National Energy Technology Laboratory (NETL) released a report that estimates the average lifecycle GHG emissions from

petroleum-based fuels sold or distributed in 2005.^{OOOOOOO} The estimates in the report are based on a slightly different methodology than EPA's analysis of lifecycle GHG emissions for the petroleum baseline. The NETL report is available on the docket for this rulemaking.

2.5 Secondary Energy Sector Impacts Modeling

2.5.1 Indirect Energy Sector Impacts from Renewable Fuel Consumption

We have started an analysis using an EPA version of the Energy Information Agency's National Energy Modeling System (NEMS-EPA)^{PPPPPPP} to estimate indirect impacts on energy use associated with increased renewable fuel consumption. NEMS is a modeling system that simulates the behavior of energy markets and their interactions with the U.S. economy by explicitly representing the economic decision-making involved in the production, conversion, and consumption of energy products. NEMS can represent the secondary impacts that greater renewable fuel use may have on the prices and quantities of other sources of energy, and the GHG emissions associated with these changes in the energy sector. For example, the use of natural gas at corn ethanol production plants could increase the price of natural gas, and thus encourage the use of other energy sources in other sectors of the economy. Due to time constraints, we did not include indirect energy sector impacts in the lifecycle GHG results for the proposed rule. Below we explain the preliminary results, and outline our plans to refine this analysis for the final rule.

We successfully used NEMS-EPA to simulate the RFS2 fuel volumes for this rulemaking, and the projections from that effort were used in our energy security results, and other analyses for the proposed rule. However, we had difficulties isolating volume changes for specific renewable fuel types. When we attempted to model the fuel-specific volume scenarios that were used for FASOM and FAPRI analysis of the agricultural sector (See Section 2.3.2 for a description of the FASOM and FAPRI fuel-specific scenarios), we had trouble designing model runs that held the other fuel volumes constant. For example, when we tried to use NEMS-EPA to model an increase in corn ethanol consumption from 12.4 to 15 billion gallons, the volumes of cellulosic ethanol consumption also changed. We could not use model results with variable cellulosic ethanol production to estimate the secondary energy sector impacts of corn ethanol, because the modeled cellulosic ethanol plants export electricity to the grid, which has significant energy sector impacts that could not be assigned to corn ethanol.

To effectively model a scenario where only corn ethanol consumption increased, we departed from the volume scenarios that were used for the other analyses in this rule. Table 2.5-1 shows renewable fuel volumes for two NEMS-EPA scenarios (Lower Corn Ethanol and Control Case) that successfully varied corn ethanol consumption and held cellulosic ethanol consumption constant.

^{OOOOOOO} DOE/NETL. 2008. Development of Baseline Data and Analysis of Life Cycle Greenhouse Gas Emissions of Petroleum-Based Fuels. DOE/NETL-2009/1346

^{PPPPPPP} This version is called NEMS-EPA to make it clear that EPA, rather than EIA, conducted this analysis.

Several assumptions were modified in order to create the differences in corn ethanol while keeping the other biofuels (such as cellulosic ethanol and biodiesel) unchanged between the cases. In addition, a larger difference in corn ethanol than that of the Reference to EISA cases was desired so that the change was more significant relative to the convergence tolerance of the model.

In the Lower Corn Ethanol Case, the RFS credit was reduced for non-advanced biofuels (i.e. corn ethanol) and the cost of new corn ethanol plants was increased in order to reduce projected corn ethanol production. The Control Case includes a higher RFS requirement for total biofuels to give credit to corn ethanol above 15 billion gallons as well as a reduction in the cost of new corn ethanol plants. Both cases also include modifications to the cost of soy-based biodiesel as a device that keeps the biodiesel production only at the minimum EISA-mandated level in both cases. We modified the RFS requirements such that the cellulosic requirement would be met and be binding in both cases, and reduced the advanced biofuels requirements to equal that of cellulosic. Both changes were made to minimize the change in other biofuels between the two cases. The cases also eliminate biomass-to-liquids (which was included in EIA’s Annual Energy Outlook but not included in any of the EPA cases).

**Table 2.5-1. Fuel Volumes for NEMS Corn Ethanol Scenario
(Billions of Gallons Consumed Per Year)**

	2017			2022		
	Lower Corn Ethanol Case	Control Case	Difference	Lower Corn Ethanol Case	Control Case	Difference
Corn Ethanol	10.5	15.2	4.8	4.1	15.6	11.5
Cellulosic Ethanol	3.0	3.0	0.0	12.5	12.5	0.0
Imported Ethanol	1.5	2.2	0.7	1.2	3.0	1.8
Exported Ethanol	1.0	0.7	-0.3	1.2	0.5	-0.7
Biodiesel	1.0	1.0	0.0	1.0	1.0	0.0
Total Biofuels	16.9	22.0	5.1	20.0	32.5	12.6

We computed the difference in energy consumption between the Control Case and the Low Corn Ethanol Case shown in Table 2.5-1. New ethanol plants built after 2015 were modeled to use natural gas and electricity but not coal as energy sources. To isolate the indirect energy sector impacts not included in the rest of our lifecycle analysis, we excluded changes in energy use for biofuel refining, agriculture, petroleum refining, and gasoline and diesel use for transportation. In other words, we used the NEMS-EPA analysis to project how an increase in corn ethanol production would affect energy consumption in the residential, commercial, and non-refining industrial sectors. Table 2.5-2 shows how energy consumption in these sectors changed between the Control Case and the Lower Corn Ethanol case.

Table 2.5-2. Projected Indirect Impacts from Corn Ethanol Production on Energy Use by Energy Source in the Residential, Commercial, and Non-Refining Industrial Sectors (Quadrillion Btu)

	2017			2022		
	Lower Corn Ethanol Case	Control Case	Difference	Lower Corn Ethanol Case	Control Case	Difference
Liquid Fuels	14.585	14.587	0.002	14.653	14.683	0.030
Liquified Petroleum Gases	2.489	2.489	0.000	2.397	2.396	-0.001
E85	0.000	0.000	0.000	0.000	0.000	0.000
Motor Gasoline	0.423	0.423	0.000	0.422	0.421	0.000
Jet Fuel	3.955	3.955	0.000	4.283	4.283	0.000
Kerosene	0.124	0.124	0.000	0.125	0.125	0.000
Distillate Fuel Oil	2.582	2.582	-0.001	2.541	2.540	-0.001
Residual Fuel Oil	1.567	1.568	0.001	1.569	1.574	0.006
Petrochemical Feedstocks	1.433	1.433	0.000	1.357	1.357	0.000
Liquid Hydrogen	0.000	0.000	0.000	0.002	0.002	0.000
Other Petroleum	2.010	2.012	0.002	1.958	1.984	0.026
Natural Gas	23.270	23.274	0.003	22.867	22.813	-0.054
Coal	24.641	24.642	0.001	26.410	26.501	0.092
Nuclear Power	8.487	8.484	-0.003	9.194	9.158	-0.036
Hydropower	2.985	2.983	-0.001	3.009	3.007	-0.003
Traditional Biomass	2.569	2.569	0.000	2.786	2.786	-0.001
Other Renewable Energy	1.786	1.785	-0.001	2.023	2.023	0.000
Other	0.180	0.180	0.000	0.175	0.175	0.000
Total	78.503	78.504	0.001	81.119	81.146	0.027

We applied emissions factors to estimate the GHG impacts of the energy consumption changes shown in Table 2.5-2. We estimated the GHG impacts in terms of GHG emissions impacts per Btu of additional corn ethanol consumption. The results in Table 2.5-2 imply an increase in GHG emissions of 1,356 g/mmBtu in 2017, and an increase in GHG emissions of 9,290 g/mmBtu in 2022. A large part of these GHG results can be attributed to the increase in coal consumption and the decrease in nuclear energy consumption projected by NEMS-EPA in the Control Case relative to the Lower Corn Ethanol Case. If we hold nuclear energy consumption constant (i.e. assume that Control Case nuclear power consumption equals nuclear power consumption in the Lower Corn Ethanol Case), the GHG impacts become an increase of 437 g/mmBtu in 2017 and an increase of 5,117 g/mmBtu in 2022.

We did not include the results of this NEMS-EPA analysis in our lifecycle GHG estimates for the proposed rule. For the final rule we intend to continue exploring the use of NEMS-EPA to estimate the indirect energy sector impacts of renewable fuel consumption. To use the NEMS-EPA model for this purpose, we would like to gain a better understanding of why the energy sector impacts vary between years. We may also explore other models and data sources that could be utilize for this part of the lifecycle analysis.

2.5.2 Indirect Impacts on Petroleum Consumption for Transportation

EPA recognizes that with the increase in demand for biofuels from the RFS2 program there could be secondary impacts on oil markets. For example, an increase in the use of biofuels could result in lower U.S. demand for imported oil. Lower U.S. imported oil demand could cause the world oil price to modestly decline, and result in an increase in oil consumption outside of the U.S. (referred to here as the “international oil takeback effect”). In addition, with the greater use of biofuels in the U.S., we estimate that the cost of transportation fuels in the U.S. would

increase. This increase in the costs of U.S. transportation fuels would likely lower the domestic demand for oil beyond the direct substitution of biofuels for gasoline and diesel. The response of U.S. oil demand to price is referred to here as the “rebound effect.” From an overall standpoint, total global oil demand is the result of the two combined effects, decreases in U.S. oil demand (from the “rebound effect”) and increases in oil demand outside of the U.S. (from the “international oil takeback effect”). These effects work in opposite directions to influence the overall change in global oil demand. Besides providing a complete picture of oil market impacts of the RFS2 program, this issue could also be important because secondary impacts on oil demand from the RFS2 program, assuming that they can be reliably determined, could be factored into the lifecycle GHG emissions estimates.

Estimates of the “international oil takeback effect” and, to a lesser extent, the “rebound effect” are difficult to quantify. Take the case of the “international oil takeback effect.” While a decline in the world oil price is likely to increase world oil consumption, oil consumption patterns vary significantly across different regions of the world (i.e., Southeast Asia, South America). As a result, each region may have a different demand response to a change in the international price of crude oil. For example, in Europe, the price of crude oil comprises a much smaller portion of the overall fuel prices seen by consumers than in the U.S., since Europeans pay significantly more fuel tax than their U.S. counterparts. A decline in the price of crude oil is likely to have a smaller impact on prices at the pump and therefore a lesser impact on demand. In many other countries, particularly developing countries such as China and India, oil is used more widely in industrial and electricity generation applications, although the energy picture in China and India is evolving rapidly. In addition, many countries around the world subsidize their oil consumption, and oil markets are influenced by monopolistic control of prices, both on the supply and demand sides. It is, therefore, not clear how oil consumption would change due to changes in the market price of oil with the current pattern of subsidies. The factors listed above illustrate the difficulty in trying to estimate the overall impact of a reduction in world oil price on oil consumption outside of the U.S.

Even for the U.S., there is some controversy about the impact of a change in the price of oil on domestic U.S. oil consumption. Since approximately 70 percent of the U.S. oil use is concentrated in the U.S. transportation sector, most discussion of the so called “rebound effect” revolves around the impact of a change in driving in response to a change in the price of transportation fuels. Many factors influence the magnitude of the U.S. rebound effect, including how fuel cost increases are passed through to prices at the pump for consumers, the composition of adult drivers, the level of urbanization, income levels, and the amount of congestion.

In any case, the Agency recognizes that both the “international oil takeback effect” and the “rebound effect” are important to estimate and we are examining methodologies for quantifying them for the final rule. For example, the most straightforward approach would be to utilize an elasticity estimate of global oil demand with respect to the international oil price and use this estimate to calculate the “international oil takeback effect.” However, a global estimate would not capture regional or country specific demand responses, which as indicated above could be very different. Alternatively, as another approach for estimating the “international oil takeback effect,” EPA is asking ORNL to explore an approach based upon a review of the international energy economics literature to see if a set of bottom-up estimates of oil demand

elasticities by world regions (i.e., Southeast Asia and South America) and oil-using sectors (i.e., transportation and non-transportation) can be developed and used to address this issue. If the bottom-up estimates can be developed or a global demand elasticity can be agreed upon, they will help inform the development by ORNL of an integrated petroleum/biofuels market tool to examine fuel market issues associated with the RFS2 program.

2.6 Biofuels Analysis

2.6.1 Modeling Approach

As mentioned in Section 2.2, to address some of the issues with our RFS1 lifecycle modeling for biofuels we have updated our methodology to include the use of agricultural sector economic models. Our methodology involves the use of the FASOM model to determine domestic agriculture sector-wide impacts of increased biofuel production, and the FAPRI model to determine international changes in crop production and total crop. Agricultural sector GHG emissions are estimated by FASOM, and FAPRI results were converted to GHG emissions based on GREET defaults and IPCC emission factors. Biofuel process energy use and associated GHG emissions were based on process models for the different pathways considered. Feedstock and co-product transportation GHG emissions were based on GREET defaults.

The agricultural sector models were used to determine the impacts associated with biofuels production by comparing two similar scenarios in both models. Both agricultural sector models were run with two similar volumes of the specific fuel in question, while other fuel volumes were held constant to isolate the fuel-specific impacts. Table 2.6-1 shows the 2022 fuel volumes modeled in FASOM in order to isolate the incremental impacts of each type of renewable fuel. Section 2.3 includes more discussion of the fuel volume scenarios.

Table 2.6-1. 2022 Fuel Volumes Modeled with FASOM (Billions of Gallons)

	Control Case	Biodiesel Only Case	Corn Ethanol Only Case	Corn Stover Ethanol Only Case	Switchgrass Ethanol Only Case
Biodiesel	0.6	0.2	0.6	0.6	0.6
Corn Ethanol	15.0	15.0	12.4	15.0	15.0
Corn Stover Ethanol	7.6	7.6	7.6	0.0	7.6
Switchgrass	1.1	1.1	1.1	1.1	5.7
Bagasse Ethanol	1.4	1.4	1.4	1.4	1.4

The total impacts from changes in biofuel production were calculated by taking the difference in total GHG emissions from the two scenarios considered. Per gallon (or mmBtu) impacts were calculated by dividing the total GHG emission changes by the increase in volume of fuel represented in the scenarios. Therefore, the results presented in this proposed rulemaking represent the per mmBtu “average marginal” impact of the change in fuel volumes considered. In other words, the GHG impacts were estimated for a marginal increase in fuel production, and the average impact of a marginal gallon was calculated.

2.6.2 Domestic Agriculture

GHG emissions from the domestic agricultural sector were estimated with the FASOM model, a partial equilibrium economic model of the U.S. forest and agricultural sectors. As discussed in Section 2.3, FASOM accounts for changes in GHG emissions from most agricultural activities, including the total amount of fertilizer, chemicals, gasoline, diesel and electricity used on farms for the entire domestic agricultural sector. It also captures changes in the soil management, livestock production and U.S. agricultural exports. More detail on the FASOM model can be found in Chapter 5 of the DRIA.

Figure 2.6-1 shows the total harvested crop acres in the different fuel volume cases. The projected changes in total harvested acres are modest, partly because we only modeled the incremental difference in renewable fuel volumes between the cases.

Figure 2.6-1. FASOM Projected Domestic Harvested Acres, 2022

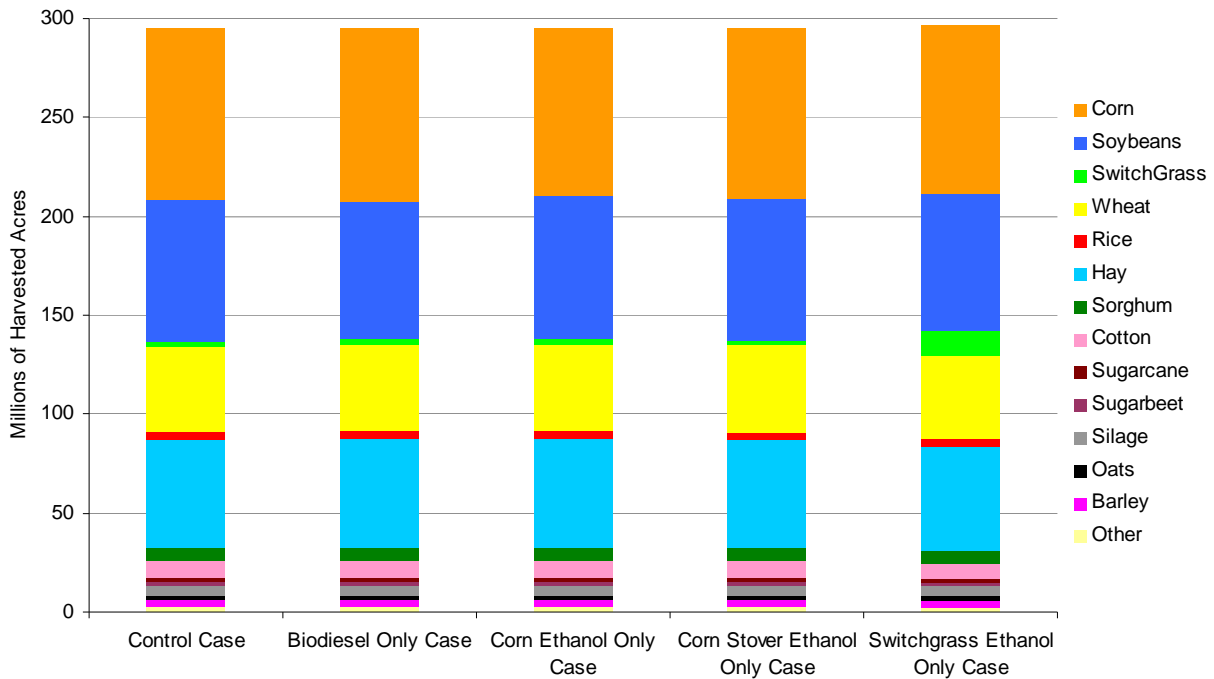

Figure 2.6-2 includes the projected changes in harvested crop acres by field crop for the fuel volume cases considered (acreage changes are normalized per thousand gallons of renewable fuel production). In the corn ethanol scenario, corn acreage increased; area planted with soybeans, hay, sorghum and rice decreased; and harvested acres of other crops were practically unchanged. It is not surprising that soybean acreage decreased the most when corn ethanol production increased, because corn and soybeans are often in direct competition for fertile land. As discussed more below, the small decrease in rice acres had a relatively large impact on GHG emissions estimates, because domestic rice production requires more energy than other crops and is a source of methane emissions.

Soy-based biodiesel production induced a large increase in harvested soybean acres, largely due to the low yield of soy-based biodiesel in terms of gallons produced per acre. Cotton

was the only other crop that increased along with biodiesel production. The competition between corn and soybeans was evident again, as corn acreage saw the steepest decline. Wheat, hay, sorghum, oats and rice also declined when biodiesel volumes increased.

Production of ethanol from corn residue had a very small effect on the acreage of other crops. This was expected because corn stover production does not displace other crop production, as corn stover is a residual product of corn cultivation. FASOM did project minor amounts of crop shifting in the corn stover scenario, because using corn stover for ethanol can increase the profitability of corn production in certain regions, with subsequent impacts. The effects of corn stover harvesting on agricultural inputs, such as the need to use more fertilizer after stover removal, are discussed below.

In the scenario where switchgrass ethanol production increased, switchgrass was the only field crop to gain acreage. As Figure 2.6-2 shows, new switchgrass plantings displaced a wide variety of other crops. As discussed more in DRIA Chapter 5, the FASOM runs for the proposed rule project that switchgrass will primarily be grown in Oklahoma, Texas, Virginia and West Virginia.

Figure 2.6-2.
Normalized Changes in Domestic Cropland by Crop, 2022
(acres per thousand gallons of renewable fuel)

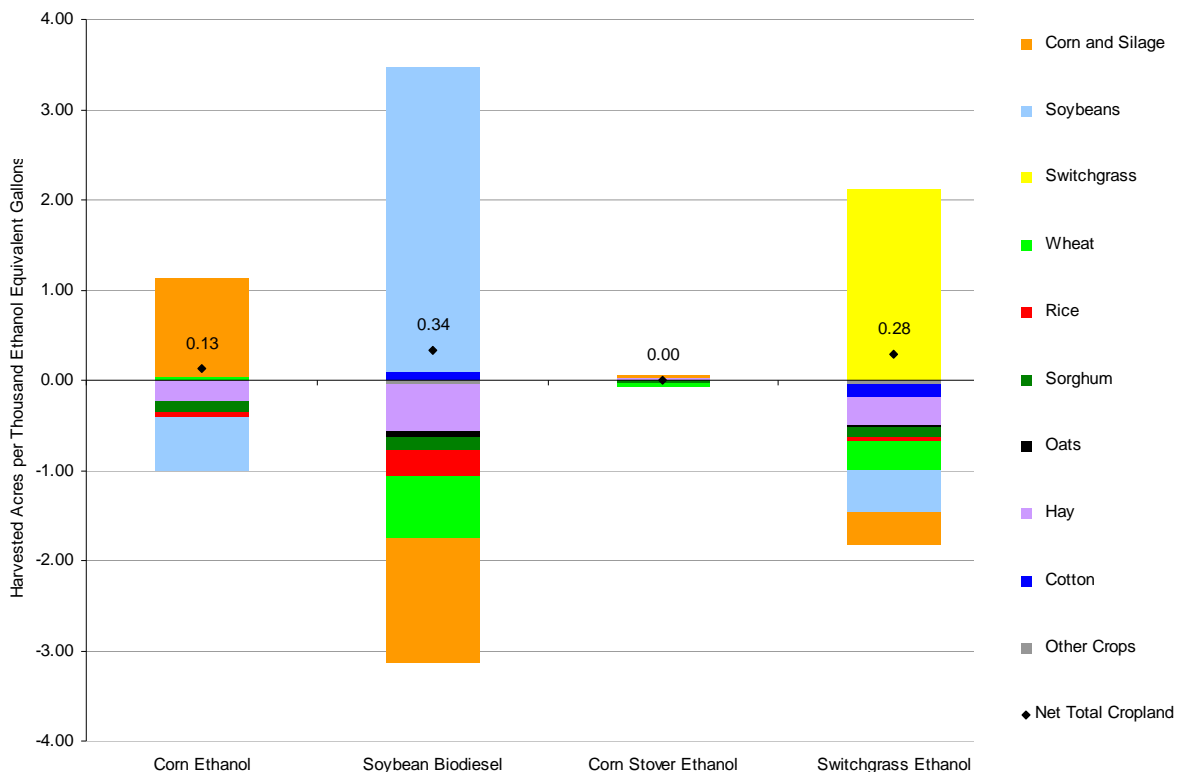

2.6.2.1 Domestic Crop Inputs

FASOM utilizes data about crop inputs to build crop budgets for field crops across 11 market regions and 63 sub-regions. FASOM crop budgets include data on yields, fertilizer, chemicals, and energy use needed to grow crops in each of the different regions. The crop budgets are based on USDA historic data and are also projected into the future. The crop budgets represent an average for each region, and do not specifically calculate input or yield changes that could result from the use of marginal croplands or altered crop rotation patterns (e.g., continuous corn production).^{QQQQQQ} Table 2.6-2 defines the 11 market regions in FASOM. DRIA Chapter 5 includes a detailed discussion of the FASOM crop budgets, including assumptions about crop yields and yield growth rates. Below we provide a summary of some of the key FASOM assumptions that were used to estimate domestic agricultural GHG emissions.

Table 2.6-2. Definitions of 11 Market Regions in FASOM

Key	Market Region	Production Region (States/Subregions)
NE	Northeast	Connecticut, Delaware, Maine, Maryland, Massachusetts, New Hampshire, New Jersey, New York, Pennsylvania, Rhode Island, Vermont, West Virginia
LS	Lake States	Michigan, Minnesota, Wisconsin
CB	Corn Belt	All regions in Illinois, Indiana, Iowa, Missouri, Ohio (IllinoisN, IllinoisS, IndianaN, IndianaS, IowaW, IowaCent, IowaNE, IowaS, OhioNW, OhioS, OhioNE)
GP	Great Plains	Kansas, Nebraska, North Dakota, South Dakota
SE	Southeast	Virginia, North Carolina, South Carolina, Georgia, Florida
SC	South Central	Alabama, Arkansas, Kentucky, Louisiana, Mississippi, Tennessee, Eastern Texas
SW	Southwest (agriculture only)	Oklahoma, All of Texas but the Eastern Part (Texas High Plains, Texas Rolling Plains, Texas Central Blacklands, Texas Edwards Plateau, Texas Coastal Bend, Texas South, Texas Trans Pecos)
RM	Rocky Mountains	Arizona, Colorado, Idaho, Montana, Nevada, New Mexico, Utah, Wyoming
PSW	Pacific Southwest	All regions in California (CaliforniaN, CaliforniaS)
PNWE	Pacific Northwest— East side (agriculture only)	Oregon and Washington, east of the Cascade mountain range
PNWW	Pacific Northwest— West side (forestry only)	Oregon and Washington, west of the Cascade mountain range

^{QQQQQQ} FASOM does not explicitly model the selection of alternative crop rotations. Because the model operates in 5-year time steps, it has not generally been applied to shorter-term decisions such as changes in rotation patterns. Rather, the model data implicitly reflect average conditions for crop production (e.g., yields, input use, etc.) associated with historical rotation patterns on a regional level.

The crop budgets included in the FASOM model include data on input use that varies by crop, management practices, and region (See DRIA Chapter 5 for a full listing). There is often considerable regional variation in the inputs used per acre, which suggests that total input use (and the associated GHG emissions and other environmental impacts) will be affected as biofuel production causes crop shifting and alters crop management practices. For example, nitrogen fertilizer use is an important factor for lifecycle GHG analysis because of GHG emissions from fertilizer production and use. Figure 2.6-3 includes FASOM assumptions about average nitrogen fertilizer use by crop in 2022 for non-irrigated production without residue harvesting. Regions that have a zero nitrogen fertilizer use rate are not included in the averages. Figure 2.6-3 illustrates the relative fertilizer intensity of major crops. The figure indicates that corn, hay and silage are relatively fertilizer-intense crops; whereas soybeans require less than 10 pounds of nitrogen per acre (soybeans naturally fix nitrogen in the soil as they grow).

Figure 2.6-3.
FASOM Average Nitrogen Fertilizer Use by Crop, 2022
Non-Irrigated, No Residue Harvesting
(lbs per acre)

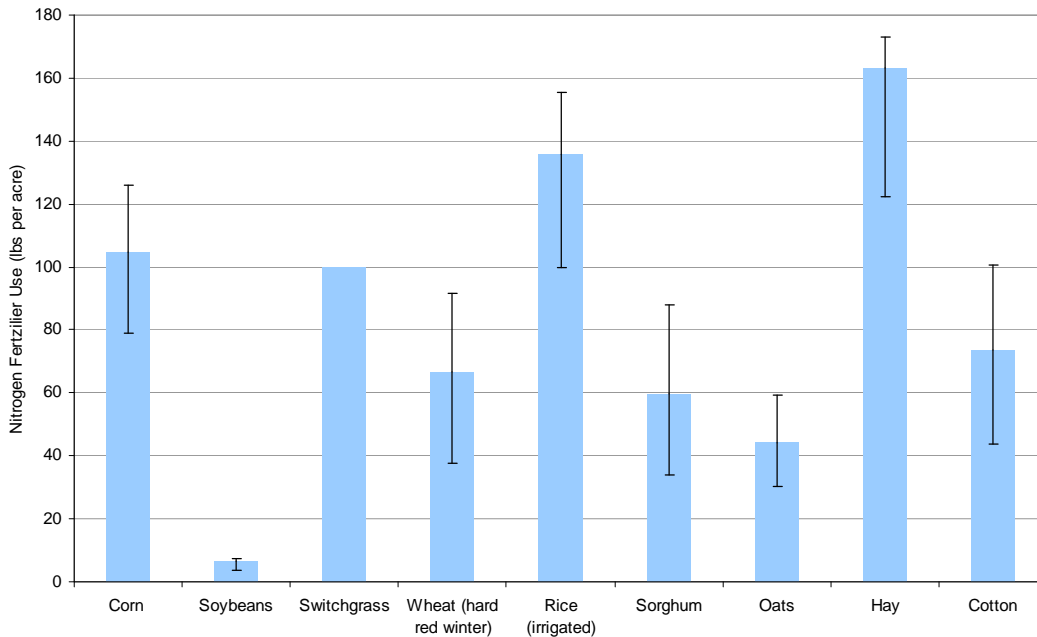

Note: The range indicates the regions with the highest and lowest average nitrogen fertilizer use rates.

Figure 2.6-4 shows the change in nitrogen fertilizer use by crop per thousand gallons of biofuel production. In the corn ethanol scenario, the net increase in fertilizer use is moderated by the decrease in hay and rice acres, which use more fertilizer per acre than corn production in most regions. Fertilizer use drops in the soy-based biodiesel scenario because soybeans, which require scarce fertilizer use, replace crops that require many times more fertilizer per acre. Fertilizer use increases in the corn stover ethanol scenario, because additional fertilizer is required to compensate for nitrogen lost when stover is removed for ethanol production (discussed in more detail in DRIA Chapter 5).

Figure 2.6-4.
Normalized Changes in Domestic Nitrogen Fertilizer Use, 2022
(lbs per thousand ethanol equivalent gallons of biofuel)

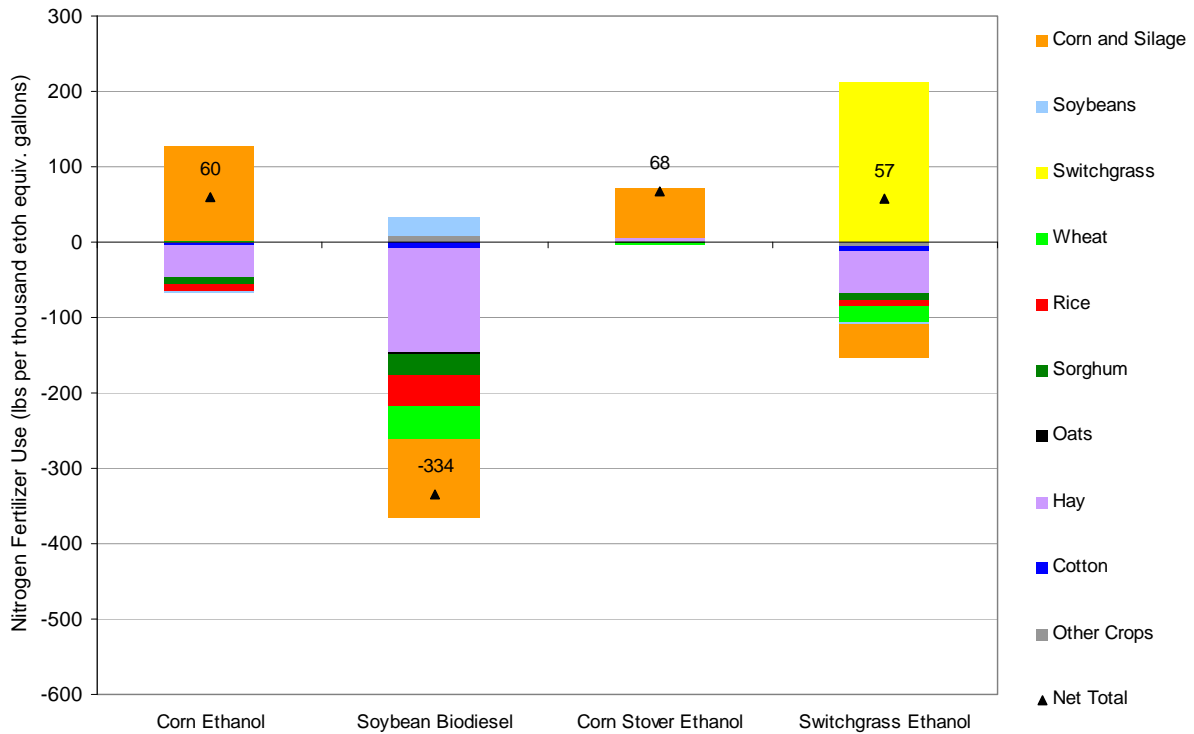

Mechanized agriculture requires many forms of energy including diesel, gasoline, natural gas and electricity. The FASOM crop budgets include detailed energy use information by crop and region (See DRIA Chapter 5 for a full listing). Figure 2.6-5 includes FASOM assumptions for average diesel use by crop in 2022, for non-irrigated production without residue harvesting.

**Figure 2.6-5.
FASOM Average Diesel Use by Crop, 2022
Non-Irrigated, No Residue Harvesting
(gallons per acre)**

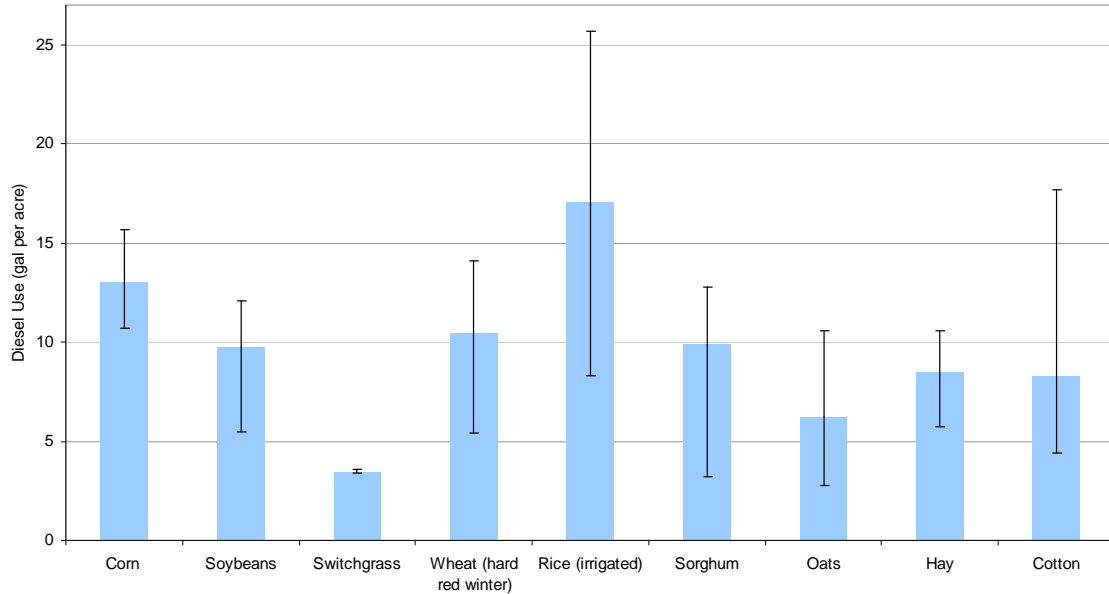

Note: The range indicates the regions with the highest and lowest average diesel use rates.

Figure 2.6-6 shows the change in domestic diesel use per thousand gallons of biofuel production. Comparing the relative diesel intensity of the crops shown in Figure 2.6-5 and the crop shifting patterns illustrated in 2.6-2, helps to explain the overall changes in diesel use in Figure 2.6-5. Diesel use increases in the corn ethanol and soy-based biodiesel scenarios as domestic crop acreage increases. Diesel use actually declines in the corn stover scenario, in part because corn farmers shift towards conservation tillage practices. Overall diesel use declines in switchgrass scenario, because switchgrass requires less diesel than the crops it displaces.

Figure 2.6-6.
Normalized Changes in Domestic Agricultural Diesel Use, 2022
(gallons of diesel per thousand ethanol equivalent gallons of biofuel)

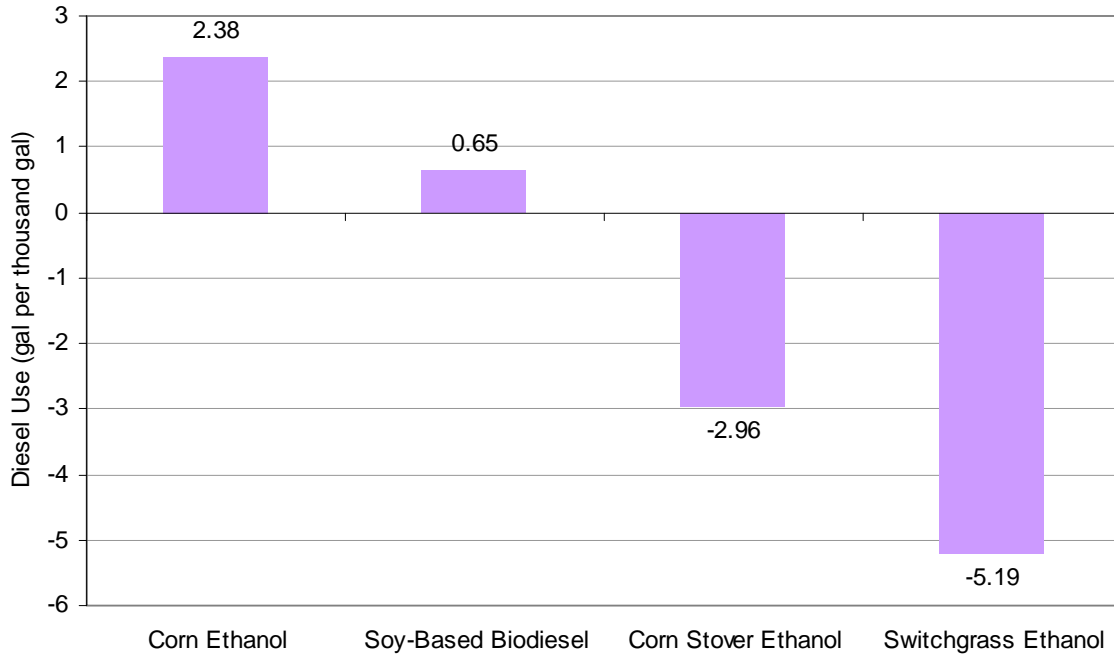
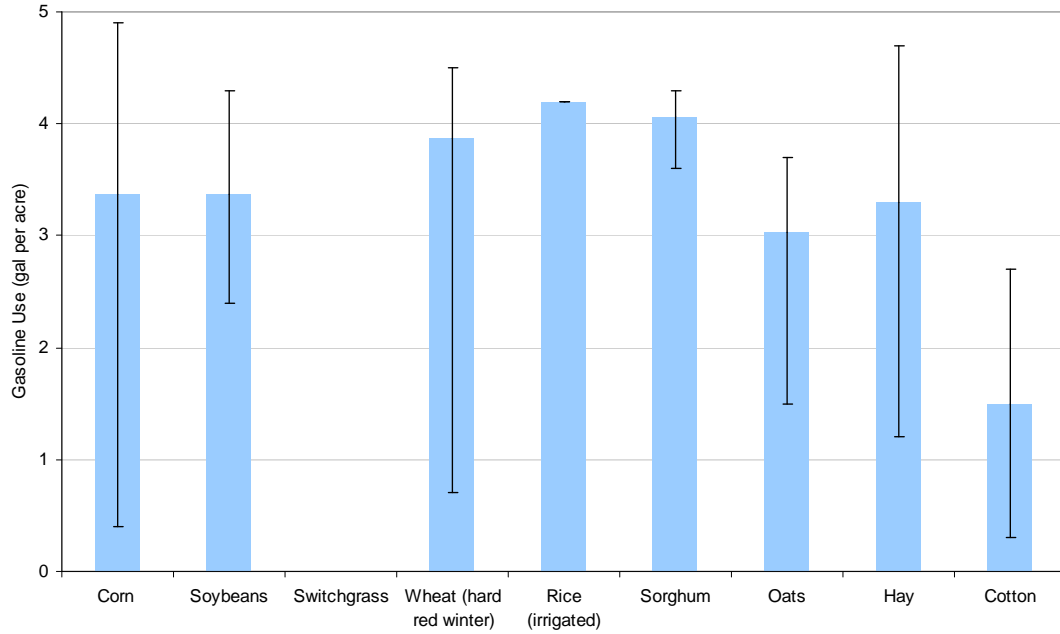

Figure 2.6-7 includes FASOM assumptions for average gasoline use by crop in 2022, for non-irrigated production without residue harvesting. The FASOM crop budgets do not include gasoline use for switchgrass production. Figure 2.6-8 shows the change in domestic gasoline use per thousand gallons of biofuel production.

**Figure 2.6-7.
 FASOM Average Gasoline Use by Crop, 2022
 Non-Irrigated, No Residue Harvesting
 (gallons per acre)**



Note: The range indicates the regions with the highest and lowest average gasoline use rates.

**Figure 2.6-8.
Normalized Changes in Domestic Agricultural Gasoline Use, 2022
(gallons per thousand ethanol equivalent gallons of biofuel)**

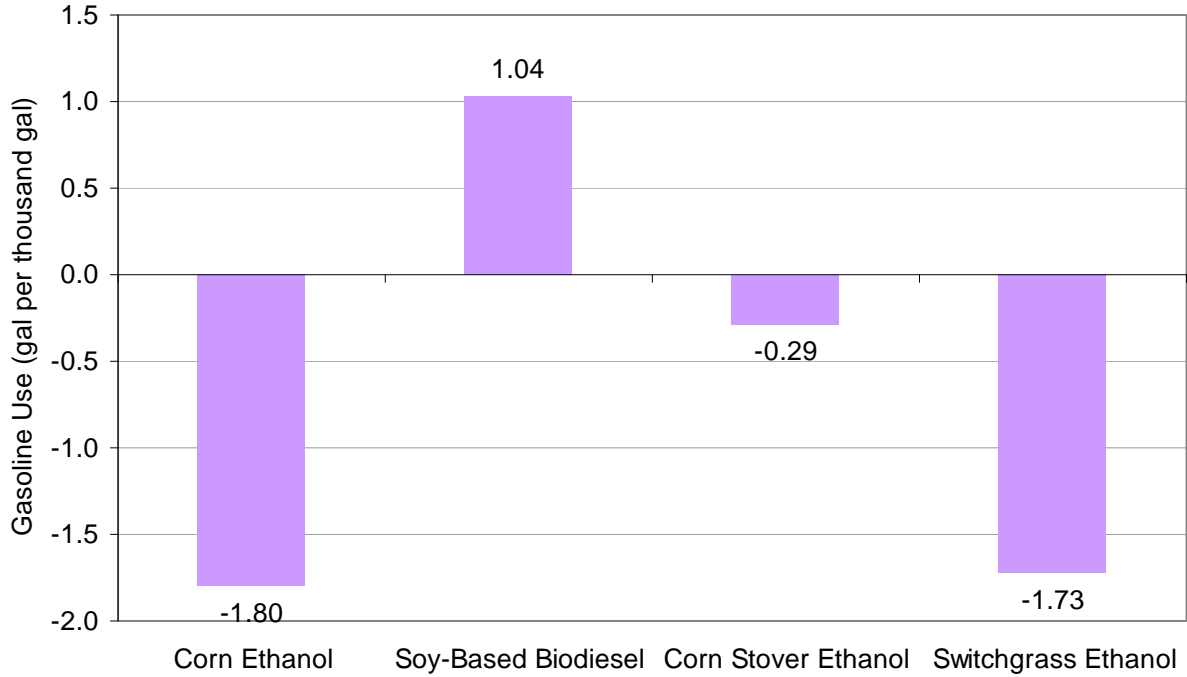

FASOM crop budgets include electricity and natural gas use for irrigation water pumping. Rice and sugarbeets are the only crops assumed to use natural gas for water pumping (See Table 2.6-3). Therefore, overall natural gas use in each scenario is dependent on changes in these crops. For the rest of the irrigated crops that have private energy use for water pumping, electricity is the assumed energy source, with the largest electricity consumption in the Great Plains region (See Figure 2.6-10).

**Table 2.6-3.
Natural Gas Usage by Crop, Irrigation Status and Region, 2022
(1000 cu ft/acre)**

Crop	CB	GP	LS	NE	PNWE	PSW	RM	SC	SE	SW
Irrigated										
Rice	23.3	NA	NA	NA	NA	0.0	NA	20.1	NA	0.0
Sugarbeet	26.1	9.7	26.1	NA	3.8	0.0	0.0	NA	NA	0.0

Figure 2.6-9.
Normalized Change in Domestic Agricultural Natural Gas Use, 2022
(thousand cubic feet per thousand ethanol equivalent gallons)

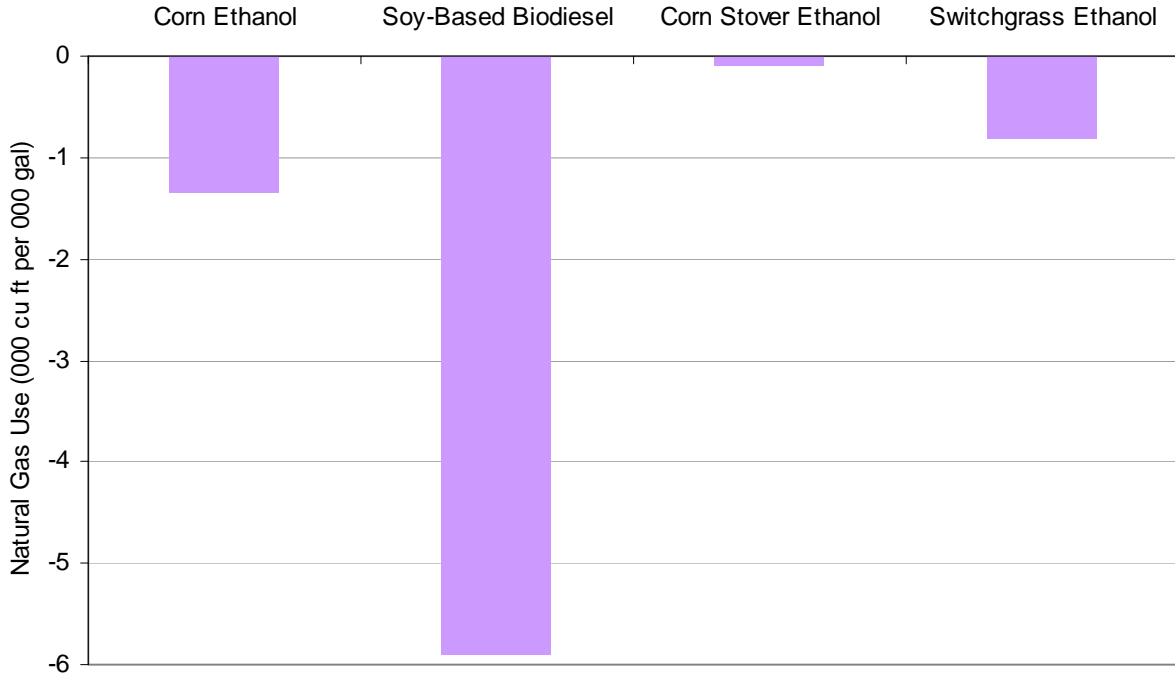
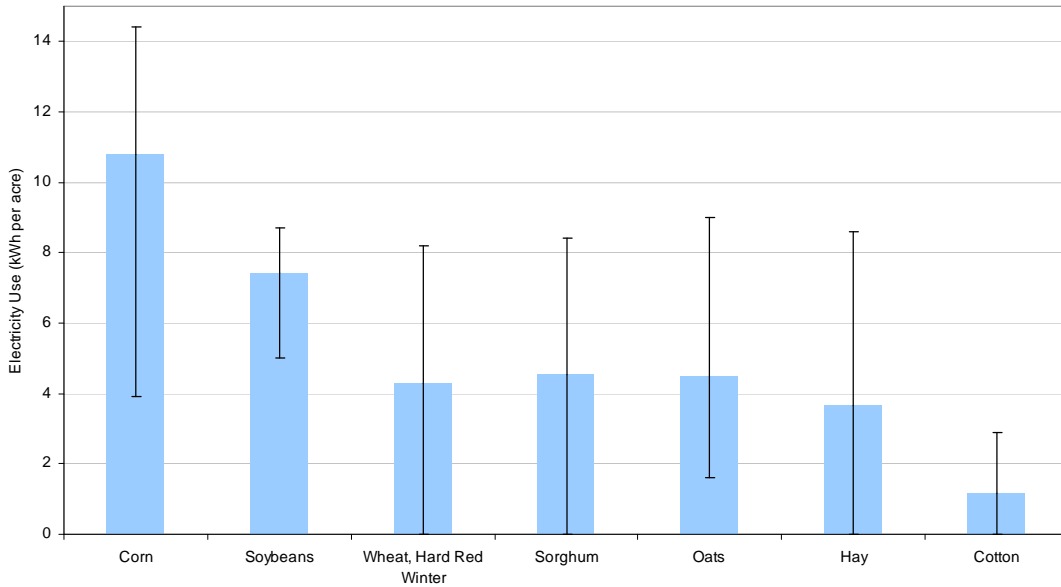
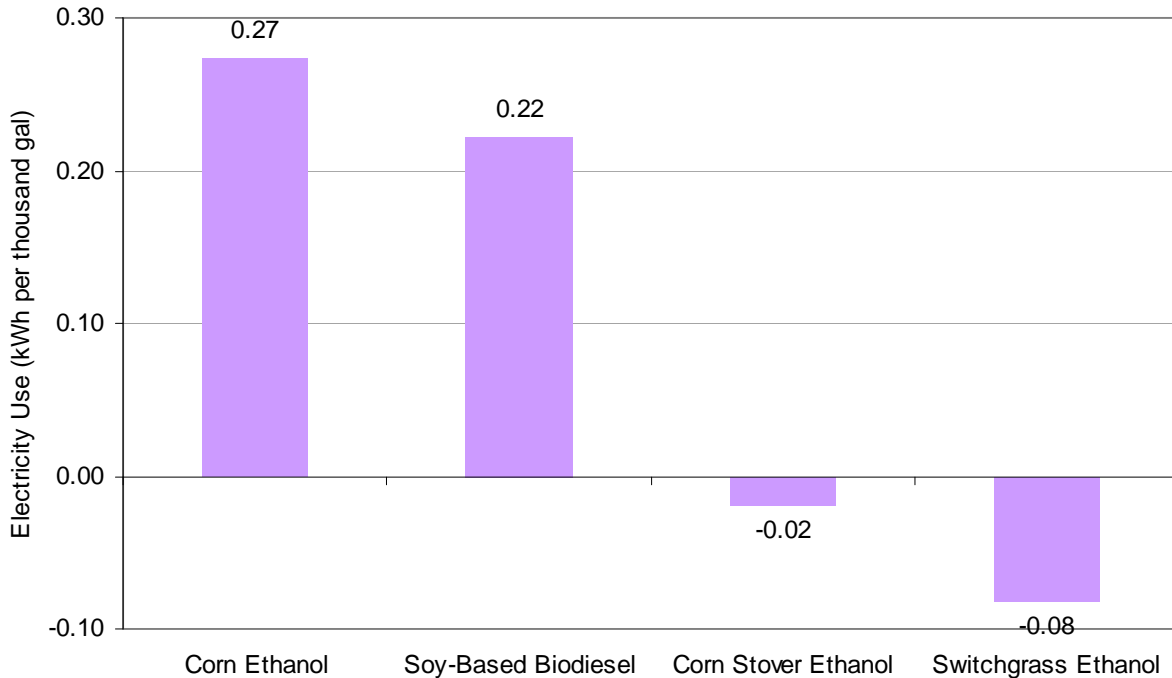

Figure 2.6-10.
FASOM Electricity Use by Crop, 2022
Irrigated, No Residue Harvesting
(kWh per acre)



Note: The range indicates the regions with the highest and lowest average gasoline use rates.

Figure 2.6-11.
Normalized Change in Domestic Agricultural Electricity, 2022
(kilowatt-hours per thousand ethanol equivalent gallons)



Based on input data for each individual crop and the associated costs of production and projected prices, the model predicts how the total U.S. agricultural sector will change with increased feedstocks used for biofuel production. The results for total agricultural sector inputs of the different fuel scenarios considered are shown in Table 2.6-4 through Table 2.6-7.

Table 2.6-4.
Change in Domestic Agricultural Inputs from Corn Ethanol Production, 2022

	Units	Corn Ethanol Only Case	Control Case	Difference	Percent Change
Total N use	Tons	13,579,165	13,656,663	77,497	0.57%
Total P2O5 use	Tons	3,133,112	3,169,185	36,073	1.15%
Total K2O use	Tons	4,071,676	4,099,299	27,624	0.68%
Total Lime Use	Tons	11,010	11,017	6	0.06%
Herbicide Use	Tons	208,026	210,343	2,317	1.11%
Pesticide Use	Tons	41,232	41,168	-64	-0.15%
Total Diesel Fuel use	gal	2,741,271,104	2,747,445,994	6,174,890	0.23%
Total Gasoline use	gal	365,527,816	360,839,070	-4,688,746	-1.28%
Total Electricity Use	kWh	203,558,361	204,268,096	709,735	0.35%
Total Natural Gas Use	Btu	6.9E+13	6.5E+13	-3.6E+12	-5.22%

**Table 2.6-5.
Change in Domestic Agricultural Inputs from Soybean Biodiesel Production, 2022**

	Units	Soy-Based Biodiesel Only Case	Control Case	Difference	Percent Change
Total N use	Tons	13,754,243	13,656,663	-97,581	-0.71%
Total P2O5 use	Tons	3,173,639	3,169,185	-4,454	-0.14%
Total K2O use	Tons	4,116,977	4,099,299	-17,678	-0.43%
Total Lime Use	Tons	11,056	11,017	-39	-0.35%
Herbicide Use	Tons	210,670	210,343	-328	-0.16%
Pesticide Use	Tons	41,551	41,168	-383	-0.92%
Total Diesel Fuel use	gal	2,747,066,027	2,747,445,994	379,967	0.01%
Total Gasoline use	gal	360,233,446	360,839,070	605,625	0.17%
Total Electricity Use	kWh	204,138,103	204,268,096	129,994	0.06%
Total Natural Gas Use	Btu	6.9E+13	6.5E+13	-3.5E+12	-5.15%

**Table 2.6-6.
Change in Domestic Agricultural Inputs from Corn Stover Ethanol Production, 2022**

	Units	Corn Stover Only Ethanol Case	Control Case	Difference	Percent Change
Total N use	Tons	13,398,157	13,656,663	258,506	1.93%
Total P2O5 use	Tons	3,040,127	3,169,185	129,057	4.25%
Total K2O use	Tons	3,461,168	4,099,299	638,131	18.44%
Total Lime Use	Tons	11,150	11,017	-134	-1.20%
Herbicide Use	Tons	209,968	210,343	375	0.18%
Pesticide Use	Tons	41,266	41,168	-97	-0.24%
Total Diesel Fuel use	gal	2,769,975,459	2,747,445,994	-22,529,464	-0.81%
Total Gasoline use	gal	363,019,719	360,839,070	-2,180,649	-0.60%
Total Electricity Use	kWh	204,417,097	204,268,096	-149,000	-0.07%
Total Natural Gas Use	Btu	6.6E+13	6.5E+13	-7.2E+11	-1.09%

**Table 2.6-7.
Change in Domestic Agricultural Inputs from Switchgrass Ethanol Production, 2022**

	Calc Units	Control Case	Switchgrass Ethanol Only Case	Difference	Difference as a % of Low Volume Case
Total N use	Tons	13,656,663	13,789,870	133,207	0.98%
Total P2O5 use	Tons	3,169,185	3,282,355	113,170	3.57%
Total K2O use	Tons	4,099,299	4,167,733	68,434	1.67%
Total Lime Use	Tons	11,017	10,525	-491	-4.46%
Herbicide Use	Tons	210,343	205,014	-5,329	-2.53%
Pesticide Use	Tons	41,168	39,478	-1,690	-4.11%
Total Diesel Fuel use	gal	2,747,445,994	2,723,351,266	-24,094,728	-0.88%
Total Gasoline use	gal	360,839,070	352,830,473	-8,008,597	-2.22%
Total Electricity Use	kWh	204,268,096	203,888,367	-379,729	-0.19%
Total Natural Gas Use	Btu	6.5E+13	6.1E+13	-3.9E+12	-5.96%

The amounts shown in Tables 2.6-4 through 2.6-7 were combined with GREET defaults for GHG emissions from production of fertilizer and chemicals to calculate GHG emissions changes. Fuel use emissions included both the upstream emissions associated with production of the fuel as well as combustion emissions, also from GREET. Emissions from electricity production represented average U.S. grid electricity production.

In addition to the GHG emissions associated with fertilizer and chemical production, and fuel production and use, there are several other non-fossil fuel combustion related GHG sources of emissions from the agricultural sector that would be impacted by the increased use of corn for ethanol and associated changes to the agricultural sector. FASOM provides directly the GHG emissions from these additional sources.

2.6.2.2 Domestic Nitrous Oxide Emissions

An important GHG impact from the agricultural sector is releases of nitrous oxide (N_2O) emissions. N_2O can be released from a number of different N-input sources including inorganic fertilizer, nitrogen fixing crops (e.g., soybeans), crop residues, and manure management. N_2O can be released either directly or indirectly through N leaching offsite. Figure 2.6-11 highlights some of the major sources of agricultural N_2O emissions.

Figure 2.6-11. Agricultural Sources of N_2O Emissions

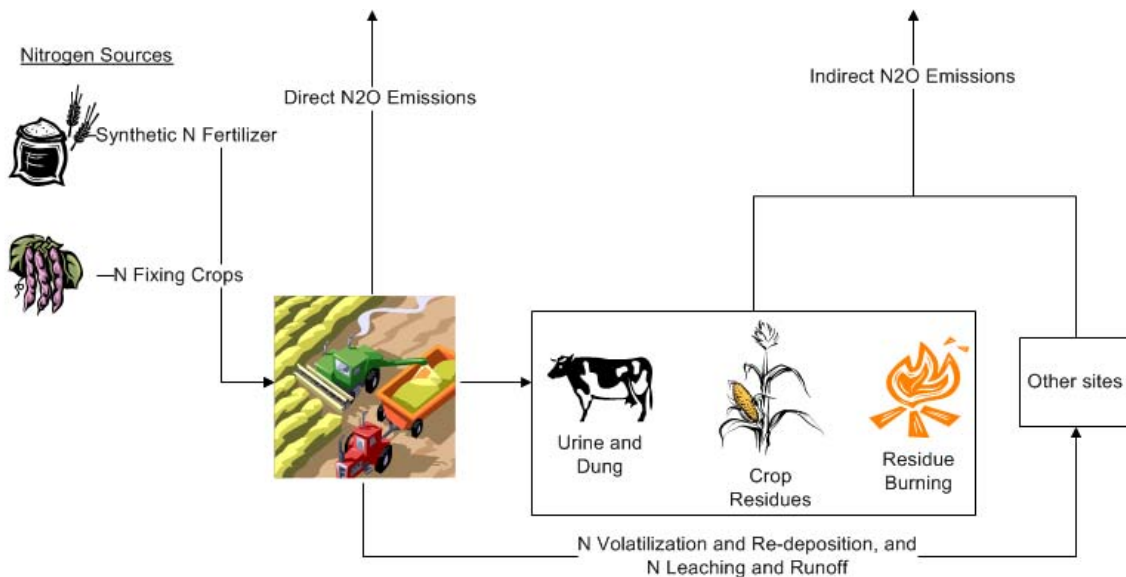

This issue has become increasingly important in the context of biofuels production based on a recent paper by Paul Crutzen et al.⁵²³ The paper examines a top-down method for calculating N_2O emissions and compares that to the standard IPCC bottom-up approach. The conclusion is that it is not appropriate to just consider the direct N_2O releases but that all sources of N_2O are important. The paper recognizes that top-down estimates are not necessarily inconsistent with IPCC's bottom-up range when all direct and indirect agricultural sources are considered, highlighting the importance of "indirect" N_2O emissions.

Therefore, for our modeling we capture all sources of N₂O emissions shown in Figure 2.6-4. This section discusses direct and indirect emissions from synthetic fertilizer, N fixing crops, and crop residue. Livestock and residue burning emissions are discussed in other sections, as are international N₂O emissions.

FASOM estimates direct and indirect emissions from synthetic fertilizer, N fixing crops, and crop residues based on the amount of fertilizer used and different regional factors to represent the percent of N applied that results in N₂O emissions. This approach is consistent with IPCC guidelines for calculating N₂O emissions from these sources.

In order to have a better representation of the N₂O emissions from agricultural production, EPA is working with Colorado State University (CSU) to use the DAYCENT model to update the N₂O factors in the FASOM model. CSU will obtain initial projections of land use trends from FASOM to simulate a suite of domestic U.S. land use and crop management changes associated with potential biofuel production between 2007 and 2030. CSU will use the DAYCENT model to simulate direct N₂O emissions in croplands as well as the N losses associated with leaching, volatilization and surface runoff and cropping pattern changes. Leaching, volatilization and surface runoff losses will be used to estimate the indirect N₂O emissions with IPCC default factors.

Separate DAYCENT simulations will be conducted for each of the 63 agricultural regions included in the FASOM analysis. In each region, DAYCENT will simulate land use conversions from grassland and forestland, as well as changes in existing cropping rotations that are needed to meet the biofuel market demand according to initial FASOM results. Several scenarios may be addressed in the analysis.

Specifically, CSU will provide several key refinements for a re-analysis of land use, cropping trends and GHG emissions in the FASOM assessment, including:

- Direct N₂O emissions based on DAYCENT simulations with an accounting of all N inputs to agricultural soils, including mineral N fertilizer, organic amendments, symbiotic N fixation, asymbiotic N fixation, crop residue N, and mineralization of soil organic matter. CSU will provide the total emission rate on an acre basis for each simulated bioenergy crop in the 63 regions, and also a disaggregation by N source.
- Indirect N₂O emissions on a per acre basis using results from DAYCENT simulations of volatilization, leaching and runoff of N from each bioenergy crop included in the analysis for the 63 regions, combined with IPCC factors for the N₂O emission associated with the simulated N losses.

The analyses with updated N₂O estimates are not yet complete, but we expect to incorporate updated emissions data into FASOM for future analyses. Below we describe the current procedures used in FASOM to generate estimates of N₂O emissions.

The primary categories of direct N₂O emissions are nitrogen fertilizer and nitrogen-fixing crops. Changes in FASOM direct N₂O emissions from croplands result from either changes in

crop acreage or crop mix. To calculate direct N₂O emissions from N fertilizer use, FASOM uses data on N fertilizer application per acre from the crop budgets. This value varies widely across crops, regions, and crop management activities. Emissions from synthetic fertilizer, manure applied as fertilizer, and non-manure organic fertilizers are calculated based on IPCC guidance. N₂O emissions are calculated similarly for organic fertilizers. In FASOM, the only N-fixing crops for which N₂O emissions are calculated are soybeans and alfalfa hay. More details about current FASOM modeling of direct N₂O emissions are available in DRIA Chapter 5.

In addition to direct N₂O emissions from croplands, there are several additional sources of indirect emissions, including emissions from volatilization, leaching, crop residues, and residue burning. Some of the N applied to agricultural soils as fertilizer volatilizes, entering the atmosphere as ammonia and other oxides of nitrogen. The volatilized N subsequently returns to soils through N deposition and then contributes to N₂O emissions. After fertilizer application or heavy rain, large amounts of N may leach from the soil into drainage ditches, streams, rivers and eventually estuaries. Some of this N is emitted as nitrous oxide when the leached nitrogen fertilizer undergoes the process of nitrification or denitrification. There are also N₂O emissions from crop residues that are incorporated into agricultural soils. Following IPCC guidance, N₂O emissions are calculated as 1% of the N from crop residues that is incorporated into the soil. FASOM also assumes that a certain fraction of fields are burned each year, which results in N₂O (and methane) emissions. These emissions are calculated using the IPCC default value, which assumes that on average 0.7% of N contained in the burned residue is emitted as N₂O. In addition, methane emissions are calculated based on the average methane emissions per acre, but these emissions are typically quite small relative to the other emissions tracked in FASOM. All FASOM calculations of N₂O emissions are based on IPCC guidance (See DRIA Chapter 5 for more details). Figure 2.6-12 summarizes FASOM average direct and indirect N₂O emissions per acre by crop.

**Figure 2.6-12. FASOM Average N₂O Emissions by Crop
Non-Irrigated, No Residue Harvesting
(kgCO₂.eq per acre)**

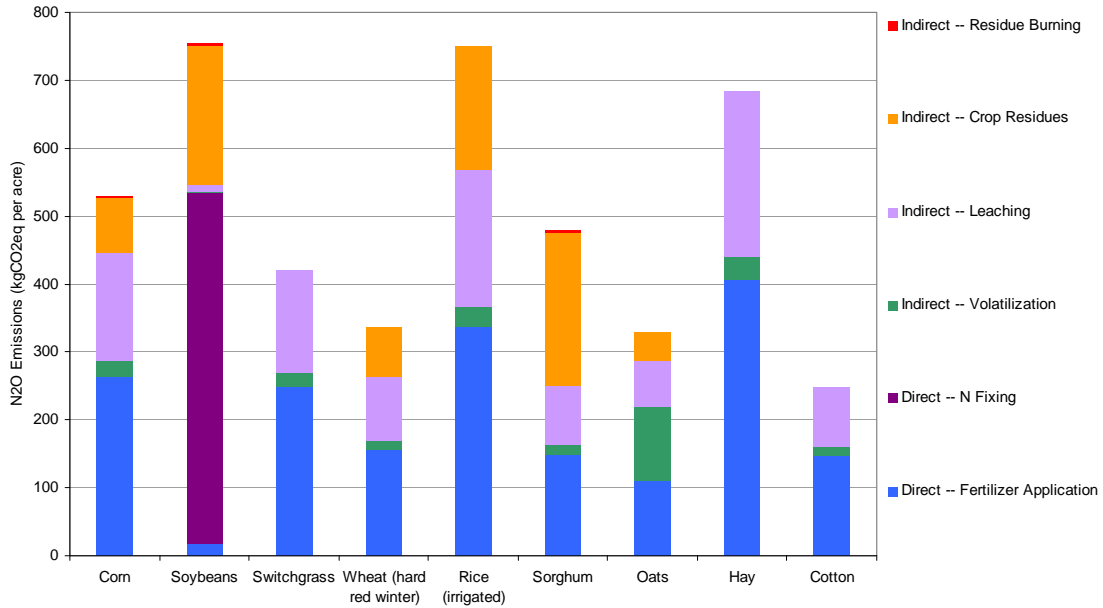

Current N₂O emission calculations from FASOM are from three main sources of emissions, fertilizer application (including direct emissions and indirect emissions from N leaching), Emissions from N fixing crops, and emissions associated with residues and N in the residue. Total N₂O emissions for the different fuels analyzed are presented in Table 2.6-8.

Table 2.6-8. Change in N₂O Emissions in 2022 from Different Fuel Scenarios

Source	Units	Corn Ethanol Only Case	Soy-based Biodiesel Only Case	Corn Stover Ethanol Only Case	Switchgrass Ethanol Only Case
N Fert Application	'000 tons CO ₂ -eq.	442	-524	1,562	848
Emissions from N fixing crops	'000 tons CO ₂ -eq.	-1,157	899	130	-2,033
Emissions from Crop residue	'000 tons CO ₂ -eq.	-218	279	-33	-809
<i>Domestic Net N₂O Emissions</i>	<i>'000 tons CO₂-eq.</i>	<i>-933</i>	<i>654</i>	<i>1,659</i>	<i>-1,994</i>

The changes in N₂O emissions from the different scenarios reflect the crop pattern, and management practice changes between the different fuel volumes considered. For example, increased corn ethanol production results in more corn and less soybean acres, this is reflected in more N₂O emissions from increased nitrogen fertilizer and lower N₂O emissions from N fixing crops. Switchgrass ethanol production results in similar land use changes and less N fixing crops. Soy-based biodiesel has the opposite effect, more soybean acres and less other crops. As discussed previously, these results do not consider any changes in crop inputs for example increased nitrogen fertilizer input to make up for lost soybean nitrogen fixing.

2.6.2.3 Domestic Emissions from Grain Drying

Energy use for grain drying is calculated in FASOM based on assumptions that removing 10 percentage points of moisture from 100 bushels of grain requires 17.5 gallons of propane and 9 kWh of electricity. Thus, energy use per acre is calculated as the number of percentage points of moisture to be removed multiplied by the yield per acre and the energy use per percentage point and yield unit for each crop that is dried. Emissions are then calculated based on assumed emissions factors per unit of energy use by energy type. Table 2.6-9 shows the average emissions associated with grain drying that are used in FASOM. Drying rice is a relatively energy intensive process, as reflected in the grain drying GHG emissions per acre in Table 2.6-9. Emissions from grain drying are included in the overall domestic agricultural GHG emissions estimates.

Table 2.6-9. FASOM Average Carbon Dioxide Emissions from Grain Drying by Region (kgCO₂-eq. / acre)

Crop	CB	GP	LS	NE	PNWE	PSW	RM	SC	SE	SW
Dryland										
Corn	161.4	135.9	202.2	160.5	NA	NA	66.1	24.5	43.8	15.2
Sorghum	99.4	22.3	NA	54.3	NA	17.7	NA	NA	NA	NA
Soybeans	26.0	7.0	24.1	14.3	NA	NA	NA	NA	NA	NA
Wheat, Durham	NA	5.1	23.4	NA	NA	NA	NA	NA	NA	NA
Wheat, Hard Red Spring	NA	6.7	25.4	NA	9.1	NA	NA	NA	NA	NA
Wheat, Hard Red Winter	51.3	11.1	51.6	34.5	NA	11.6	NA	NA	NA	NA
Wheat, Soft White	NA	NA	NA	NA	NA	NA	11.6	NA	NA	NA
Irrigated										
Corn	NA	185.1	NA	NA	132.6	121.6	103.2	21.0	NA	30.7
Rice	1,216.6	NA	NA	NA	NA	1,667.3	NA	1,254.8	NA	1,400.8
Sorghum	NA	33.0	NA	NA	NA	NA	NA	NA	NA	NA
Soybeans	NA	10.3	NA	NA	NA	NA	NA	NA	NA	NA
Wheat, Durham	NA	11.3	NA	NA	NA	21.0	NA	NA	NA	NA
Wheat, Hard Red Spring	NA	10.2	NA	NA	NA	NA	17.6	NA	NA	NA
Wheat, Hard Red Winter	NA	15.4	NA	NA	NA	22.6	NA	NA	NA	NA
Wheat, Soft White	NA	NA	NA	NA	NA	NA	18.3	NA	NA	NA

2.6.2.4 Domestic Rice Production Emissions

Another source of non-combustion GHG emissions from the agricultural sector is CH₄ emissions from rice production. Most of the world's rice, and all rice in the United States, is grown on flooded fields. When fields are flooded, aerobic decomposition of organic material gradually depletes most of the oxygen present in the soil, causing anaerobic soil conditions. Once the environment becomes anaerobic, CH₄ is produced through anaerobic decomposition of

soil organic matter by methanogenic bacteria. Some of this CH₄ is transported from the submerged soil to the atmosphere primarily by diffusive transport through the rice plants. Minor amounts of CH₄ also escape from the soil via diffusion and bubbling through floodwaters.

FASOM assumes that all rice produced in the United States is grown in flooded fields and has associated methane emissions. Although there are potentially changes in water and soil management practices that could be implemented to reduce methane emissions, FASOM currently assumes that the only method available for reducing methane emissions from rice cultivation is to reduce rice acreage. Thus, changes in methane emissions from rice cultivation will result only from changes in the acreage planted to rice.

Methane emissions per acre are calculated based on regional emissions factors per acre calculated for each region based on 2001 data from the EPA GHG inventory for 1990–2003 (see Table 2.6-10).⁵²⁴ The model then calculates emissions from rice production based on emissions factors for each region and the distribution of rice acreage in the model solution.

Table 2.6-10. FASOM Average Methane Emissions from Rice Cultivation by Region (kg CO₂-eq. / acre)

Crop	CB	GP	LS	NE	PNWE	PSW	RM	SC	SE	SW
Irrigated										
Rice	1,826.1	NA	NA	NA	NA	1,783.4	NA	2,249.2	NA	4,375.0

Note: NA indicates not applicable, i.e., those crops were not cultivated under that irrigation status in that FASOM region. In addition, there is no dryland rice or sugarcane production or irrigated hybrid poplar, switchgrass, or willow production in FASOM.

As with other sources of emissions different management methods and other factors (such as soil type and amounts of fertilization) will impact CH₄ emissions from rice production. Rice methane emissions are projected to decrease due to a decrease in rice acres as shown in Table 2.6-11.

Table 2.6-11. Percent Change in Domestic Rice Emissions in 2022 from Different Fuel Scenarios

	Corn Ethanol	Soybean Biodiesel	Corn Stover Ethanol	Switchgrass Ethanol
Rice Methane Emissions ('000 tons CO ₂ -eq.)	-352	-355	-38	-457

2.6.2.5 Domestic Residue Burning Emissions

An additional minor source of GHG emissions from agricultural residue burning is also included in this analysis. Field burning of crop residues is not considered a net source of CO₂, because the carbon released to the atmosphere as CO₂ during burning is assumed to be reabsorbed during the next growing season. Crop residue burning is, however, a net source of CH₄ and N₂O, which are released during combustion. Field burning is not a common method of agricultural residue disposal in the United States. The primary crop types whose residues are typically burned in the United States are wheat, rice, sugarcane, corn, barley, soybeans, and

peanuts. FASOM is predicting a minor reduction in GHG emissions from residue burning due to reductions in crop production with residues that are typically burned. Non-CO2 residue burning emissions factors by crop and region are included in DRIA Chapter 5.

2.6.2.3 Domestic Livestock Emissions

Livestock production and management also contribute significant non-combustion GHG emissions from the agricultural sector. GHG emissions from livestock come from two main sources: enteric fermentation and manure management. Enteric fermentation produces CH₄ emissions as part of the normal digestive processes in animals. During digestion, microbes resident in an animal’s digestive system ferment food consumed by the animal. This microbial fermentation process, referred to as enteric fermentation, produces CH₄ as a by-product. The amount of CH₄ produced and excreted by an individual animal depends primarily upon the animal’s digestive system, and the amount and type of feed it consumes. Ruminant animals (e.g., cattle, buffalo, sheep, goats, and camels) are the major emitters of CH₄ because of their unique digestive system.

The FASOM modeling reflects changes in livestock enteric fermentation emissions due to changes in livestock herds. For example, as more corn is used in producing ethanol the price of corn increases, driving changes in livestock production costs and demand. Enteric fermentation emissions from livestock are calculated based on the number of animals of each type and a calculated value of average emissions per head based on the 2001 emissions values by livestock type and the number of livestock in each livestock category reported in the EPA GHG inventory report for 1990–2003.⁵²⁵ Average emissions per head of livestock are listed in DRIA Chapter 5. There are emissions mitigation options included within the FASOM model, but these options do not enter the market in the absence of incentives for reducing CH₄ emissions. Thus, similar to the case of manure management, emissions from this source are currently affected only by the number of animals in each livestock category. The FASOM model predicts reductions in livestock herds as shown in Table 2.6-12.

Table 2.6-12. Percent Change in Domestic Livestock Herd by Scenario, 2022

Livestock Type	Corn Ethanol	Soy-based Biodiesel	Corn Stover Ethanol	Switchgrass Ethanol
Dairy	-0.52%	0.04%	0.03%	-0.81%
Beef	-0.48%	-0.23%	-0.10%	-0.48%
Poultry	-0.16%	0.00%	0.00%	-0.98%
Swine	-1.63%	-0.15%	-0.26%	-1.04%

Enteric fermentation emissions are impacted by type and quality of feed. As described in DRIA Chapter 5, the mix of feed types used will change based on the increased use of corn in ethanol and changes to corn prices. This change in feed type is not reflected in enteric fermentation emissions shown here. The direction of this change would be likely be additional reductions in enteric fermentation emissions due to the fact that use of ethanol co-products DDGS as feed have been found to reduce enteric fermentation emissions. We plan to include these CH₄ reductions as part of the final rule analysis.

The management of livestock manure can produce anthropogenic CH₄ and N₂O emissions. CH₄ is produced by the anaerobic decomposition of manure. N₂O is produced as part of the nitrogen cycle through the nitrification and denitrification of the organic nitrogen in livestock manure and urine. The type of manure management methods will impact the amount of GHG emissions produced. FASOM calculates these manure management emissions based on for emissions factors from the different types of livestock and management methods as reported in the EPA GHG inventory report for 1990–2003.⁵²⁶ Manure management emissions are projected to be reduced as a result of lower livestock herd values.

2.6.2.6 Domestic Agriculture Sector Results (Excluding Land Use Change)

Table 2.6-13 provides an overview of the total GHG emissions impacts from the domestic agricultural sector based on the results of the FASOM modeling in terms of absolute changes between the GHG emissions from the different volume scenarios considered. Results are also presented on a per mmBtu basis by dividing total GHG changes by the mmBtu change in volume of biofuel produced between the different scenarios. Land use change impacts are discussed in Section 2.6.5.

**Table 2.6-13.
Domestic Agriculture GHG Emission Changes by Scenario, 2022**

Emission Source	Corn Ethanol		Soy-Based Biodiesel		Corn Stover Ethanol		Switchgrass Ethanol	
	Tonnes CO ₂ -eq.	g/MMBtu CO ₂ -eq.	Tonnes CO ₂ -eq.	g/MMBtu CO ₂ -eq.	Tonnes CO ₂ -eq.	g/MMBtu CO ₂ -eq.	Tonnes CO ₂ -eq.	g/MMBtu CO ₂ -eq.
On-Farm Combustion	-218,314	-1,105	-228,655	-5,147	-299,049	-518	-578,771	-1,641
Fuel Production Upstream	-29,726	-151	-31,032	-698	-62,305	-108	-108,720	-308
Farm Chemical Production / Transport Upstream	305,681	1,548	-296,291	-6,669	1,228,269	2,127	369,162	1,047
Livestock Change	-1,061,886	-5,377	-181,679	-4,089	-90,825	-157	-1,047,699	-2,970
Rice Production Changes	-352,374	-1,784	-354,897	-7,988	-37,899	-66	-456,840	-1,295
Fertilizer Application / Soil N ₂ O Emissions	-933,136	-4,725	654,440	14,730	1,658,579	2,872	-1,994,025	-5,653
Residue Burning	3,127	16	1,851	42	326	1	-34,647	-98
Total:	-2,286,628	-11,579	-436,263	-9,820	2,397,095	4,150	-3,851,541	-10,920

As can be see in Table 2.6-13, the net GHG impact of increased biofuel production on the U.S. agriculture sector is in general a reduction in GHG emissions. This is driven primarily by indirect or secondary impacts such as decreases in energy use from crop shifting and reductions in livestock GHG emissions due to higher corn prices. The exception for this reduction is the corn stover ethanol case that shows an increase in domestic agricultural sector GHG emissions. This is mainly due to the fact that the corn stover case includes energy use for residue harvesting and transport, and, because the use of stover for ethanol does not increase feed or food prices, less indirect impacts in comparison with other feedstocks.

Overall the small impact in the domestic agricultural sector is due to the indirect effects and demand changes, specifically demand changes in U.S. exports. For example, the sources of corn used in ethanol production in the FASOM model are shown in Figure 2.6-13. Some of the additional corn comes from increased corn production; however, the increase in corn acres is

mostly offset by reductions in other crop acres as shown in figure 2.6-2. Some of the corn used for ethanol comes from decreased corn used for feed. As ethanol produces the co-product DDG, this partially offsets the use of corn directly as feed. The reduction in livestock herds also lowers the use of corn for feed.

Figure 2.6-13. Source of Corn for Ethanol

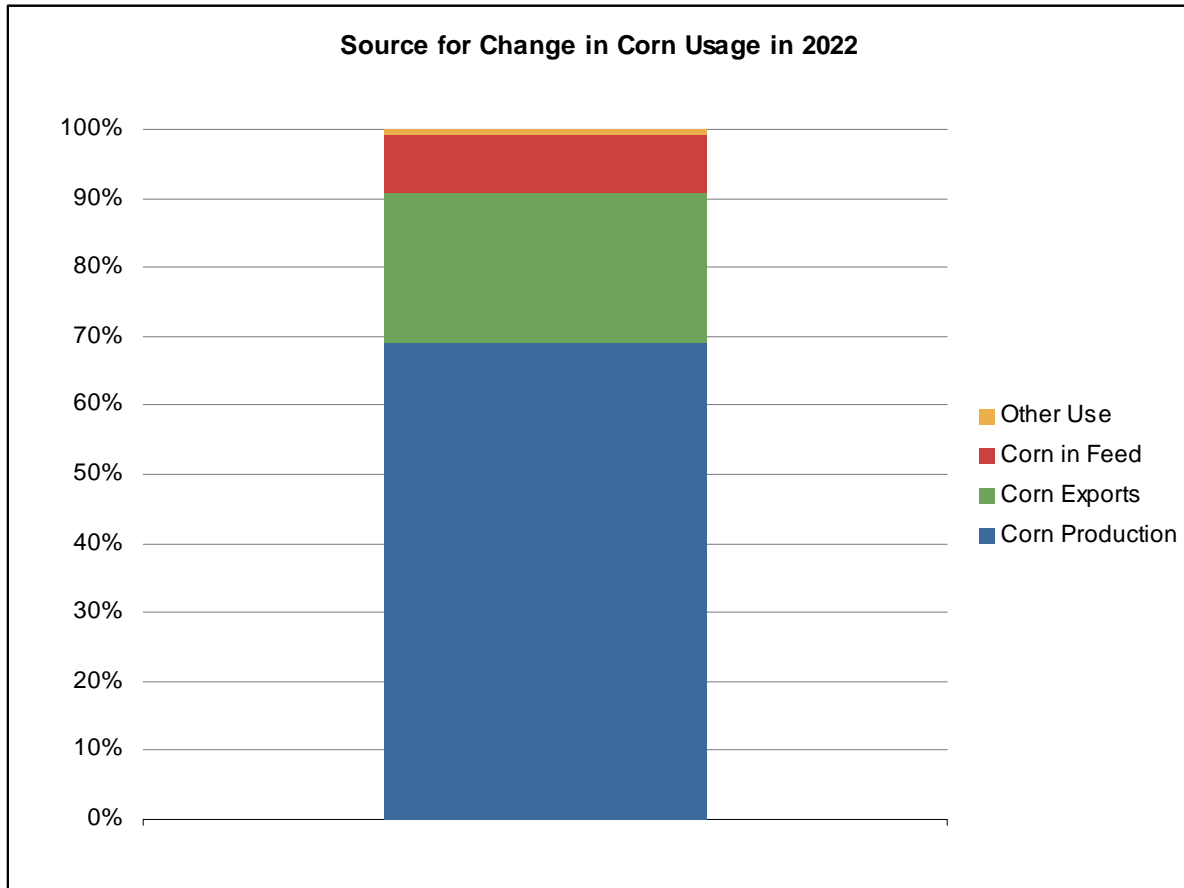

However, as seen from Figure 2.6-13, one of the biggest sources of corn for ethanol production is projected to come from reductions in corn exports. Therefore, the domestic agricultural sector impacts are only a portion of the total impacts due to increased ethanol production in the U.S. The change in corn and other crop exports will have impacts on the international agricultural sector that need to be accounted for when determining lifecycle GHG impacts of biofuel production in the U.S.

2.6.3 Export Comparison between FASOM and FAPRI

In order to estimate the impact on international agricultural sector GHG emissions the FAPRI model was run with domestic biofuel volume scenarios similar to the analysis conducted with FASOM. The model provided changes in international production of corn, soybeans, and other crops to replace lost U.S. exports.

The impact on the international agricultural sector is highly dependent on the U.S. export assumptions. As we are using the FASOM model to represent domestic agricultural sector impacts with an assumed export picture, the international agricultural sector impacts should be based on a consistent set of export assumptions. Therefore we worked with both models to build in a consistent set of assumptions in order to have an equivalent basis for modeling domestic and international impacts.

One of the key differences we worked to reconcile was based on the different time frames considered in the models. FASOM is a long term econometric model, while FAPRI captures more short term impacts. Therefore, we worked to put some of the supply and demand elasticities on a more consistent basis, specifically the export response and livestock demand and feed use. We also coordinated on some of the key input assumptions in the two models as follows:

- Current crop yields and projected increases for corn and soybeans based on USDA baseline projections. These drive the amount of land required and price and demand response of the different commodities in the different fuel scenarios.
- Ethanol yield and co-product use values, this impacts how much commodity is needed to produce a certain quantity of fuel as well as how co-products help to offset feed use and overall change in crop and livestock production.
- Reversion of CRP acres was limited such that 32 mill acres would remain in CRP. We also worked to have consistent set of assumptions for when and where CRP acres would be used across both models.

As a result, the total changes in projected export impacts shown in Figure 2.6-14 are relatively consistent across both models with the possible exception of impacts related to increased biodiesel production.

Figure 2.6-14.
Comparison of FASOM and FAPRI Projected Change in U.S. Exports by Scenario, 2022
(tons per million ethanol equivalent gallons)

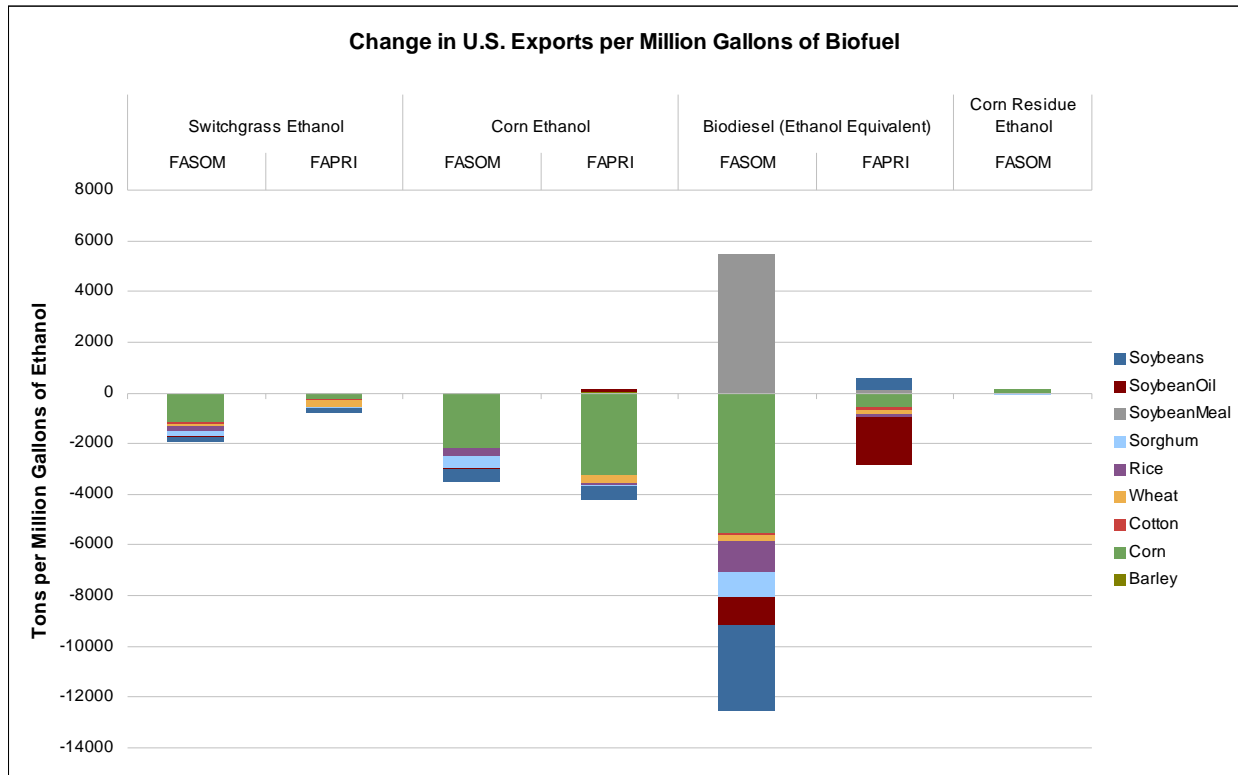

The differences in switchgrass exports are primarily driven by how the different models have considered switchgrass acres. Currently, FAPRI does not specifically model cellulosic ethanol feedstocks, so CRP land was used as a proxy for switchgrass acres. FASOM specifically models switchgrass and how it competes for land with other crops. Therefore, FAPRI domestic crop competition and associated export changes are not as large as those predicted in FASOM.

Compared to other crops, FASOM and FAPRI differ more in their predicted impact on soybean export volumes. FASOM assumes more biodiesel will come from new soybean acres (but total domestic acres are relatively constant as other crops offset the increase in soybean acres). In comparison, FAPRI contains more types of oil, and has a more elastic demand in the soybean oil market. In addition, the FAPRI model allows for some corn oil fractionation from DDGs, which can be used as a substitute for soybean oil.

For the analysis conducted and presented here we have used both the FASOM and FAPRI results as-is with no adjustments. Because the impact on international land use could be significantly different if we had used the FASOM export prediction rather than the FAPRI prediction, we intend to further refine the models with the goal of having export response more closely aligned for the final rule.

As the corn residue ethanol production has negligible export change impacts, it is assumed that there are no international emissions impacts associated with increased corn stover ethanol production in the U.S. However, we have modeled the impact of increased production of Brazilian sugarcane ethanol for use in the U.S. market. The FAPRI model has been used to determine the international impacts of Brazilian sugarcane ethanol production. The increase in Brazilian sugarcane ethanol production is assumed to have no impacts on domestic U.S. agriculture emissions.

2.6.4 International Agriculture

For this analysis we used the FAPRI model to estimate the impacts on international crop production due to changes in biofuel production. These results were used to generate GHG emissions from the international agricultural sector, similar to what was done to determine domestic agricultural GHG emission changes.

2.6.4.1 International Crop Input and GHG Impacts

The FAPRI model does not directly provide an assessment of the GHG impacts of changes in international agricultural practices (e.g., changes in fertilizer load and energy use). However, it does predict changes in crop area and production by crop type and country. We, therefore, determined international fertilizer and energy use based on data collected by the Food and Agriculture Organization (FAO) of the United Nations and the International Energy Agency (IEA).

We took the FAPRI provided activity data on changes in crop acres, by crop and country, and multiplied by regional fertilizer use rate factors (tons per acre) to determine the global impacts of biofuel production on fertilizer application. Fertilizer data was taken from the Food and Agricultural Organization's Fertistat database, which reports fertilizer use by crop and country for a single year between 1988 and 2004.⁵²⁷ Herbicide and pesticide use data was calculated in the same manner. We then used GREET factors for emissions from production of agricultural chemicals to estimate the upstream GHG impacts of fertilizer and chemical production to calculate total impacts for each fuel scenario. Table 2.6-14 provides the total change in fertilizer and chemical use for the different fuel scenarios.

Table 2.6-14.
International Change in Fertilizer and Chemical Use by Scenario, 2022
(tons)

Input	Corn Ethanol Only Case	Soy-Based Biodiesel Only Case	Switchgrass Ethanol Only Case	Sugarcane Ethanol Only Case
N Application	80,492	3,627	18,167	134,842
P Application	47,663	9,495	12,774	112,862
K Application	38,606	8,640	7,549	155,311
Herbicide Application	230	57	72	524
Pesticide Application	382	58	111	663

Foreign agricultural energy use was calculated slightly differently. We collected data from IEA on total CO₂ emissions from agricultural fuel combustion by country.⁵²⁸ We also

collected IEA data on agricultural electricity and fuel use by country, which was combined with emissions factors to estimate country-level GHG emissions from agricultural electricity and fuel use. Historical trends were used to project chemical and energy use in 2022. These total GHG emissions were only combustion related, so we scaled them to represent full lifecycle GHG emissions from fuel production, based on the ratio of combustion to full lifecycle GHG emissions from U.S. fuel and electricity use. Country-level GHG emissions from agricultural energy use were then divided by the area of agricultural land in each country, from the FAOSTAT land area database to derive a per acre GHG emissions factor from agricultural energy use by country. Our estimates use average energy consumption and GHG emissions per acre for all crops in each foreign country. We multiplied these agricultural energy consumption emissions factors by the country-level crop acreage changes projected by FAPRI to determine the change in GHG emissions from foreign agricultural energy use for each fuel scenario. Table 2.6-15 provides the total change in agricultural energy use GHG emissions for the different fuel scenarios. EPA is organizing external expert review of these calculations to be done before the final rule. Part of this review will be to look at how energy and fertilizer use will change as crop yields change.

**Table 2.6-15.
International Change in Agricultural Energy Use GHG Emissions by Scenario, 2022
(MTCO₂-eq.)**

	Corn Ethanol	Soybean Biodiesel	Switchgrass Ethanol	Brazilian Sugarcane Ethanol
Agricultural Sector Energy Use GHG Emissions	618,311	109,552	205,926	338,743

2.6.4.2 International N₂O Emissions

For international N₂O emissions we considered both direct and indirect emissions from synthetic fertilizer application, crop residue N, and manure management. Manure management emissions are discussed in the following section. Direct and indirect emissions from synthetic fertilizer application and crop residues were calculated based on IPCC guidance as shown in Table 2.6-16.⁵²⁹

Table 2.6-16. Calculations of N₂O Emissions from Synthetic Fertilizer and Crop Residues

Direct N ₂ O Emissions	
Direct Emissions (Overall Equation)	Equation
Emissions	= (N additions to soils from mineral fertilizer + N additions to soils from crop residues) × EF
EF for N additions from mineral fertilizer and crop residues	= 0.01 kg N ₂ O-N / kg N added
N Additions from Mineral Fertilizers	
N additions to soils from mineral fertilizers	= kg fertilizer N applied to soils (i.e., change in fertilizer N applications from Table 2.6-9)
N Additions from Crop Residues	
N additions to soils from crop residues	= above-ground residue dry matter × Crop Area × [N content of aboveground residues + ratio of belowground residues to harvested yield for crop × N content of belowground residues]
where,	
Above-ground residue dry matter and N additions to soils from crop residues	= Taken from IPCC default values by crop
Indirect N ₂ O Emissions	
<i>Note that for indirect emissions, the calculation of N applied to soils from fertilizers or crop residues is the same as for direct emissions</i>	
Indirect Emissions from Volatilization	Equation
Emissions	= N additions to soils from mineral fertilizers × N lost through volatilization × EF
N lost (from synthetic fertilizer additions) through volatilization	= 0.1 (kg NH ₃ -N + NO _x -N) / kg N applied
EF for N lost through volatilization	= 0.010 kg N ₂ O-N / (kg NH ₃ -N + NO _x -N volatilised)
Indirect Emissions from Leaching/Runoff	Equation
Emissions	= (N additions to soils from mineral fertilizers + N additions to soils from crop residues) × N lost through leaching or runoff × EF
N lost through leaching/runoff (from all N sources)	= 0.3 N losses by leaching or runoff / kg N addition
EF for N lost through leaching/runoff	= 0.0075 kg N ₂ O-N / kg N leaching or runoff

Based on the equations in Table 2.6-16 and the crop production changes projected by FAPRI, we estimated the total change in N₂O emissions for each fuel scenarios, as shown in Table 2.6-17. As noted above, we are also working with Colorado State University to update these factors as part of the final rule analysis.

Table 2.6-17.
International Change in N₂O Emissions in 2022 from Different Fuel Scenarios
(total metric tons N₂O)

	Corn Ethanol	Soybean Biodiesel	Switchgrass Ethanol	Brazilian Sugarcane Etanol
Direct and Indirect N ₂ O Emissions	1,901	104	446	2,642

2.6.4.4 International Livestock Change GHG Impacts

Similar to domestic livestock impacts associated with an increase in biofuel production, internationally the FAPRI model predicts changes in livestock production due to changes in feed prices. The GHG impacts of these livestock changes, enteric fermentation and manure management GHG emissions, were included in our analysis. Unlike FASOM, the FAPRI model does not have GHG emissions built in and, therefore, livestock GHG impacts were based on activity data provided by the FAPRI model (e.g., number and type of livestock by country) multiplied by IPCC default factors for GHG emissions. Table 2.6-18 shows the changes in livestock predicted by the FAPRI model in 2022 for each of the fuel scenarios considered.

Table 2.6-18.
Foreign Livestock Changes by Region and Renewable Fuel, 2022
(head per million gallons)

Corn Ethanol	Dairy	Cattle	Hog	Sheep	Poultry
North America (Canada)	-1.1	23.4	-117.7	0.0	268.0
Western Europe	-0.4	-11.0	-3.8	0.0	280.7
Eastern Europe	0.0	7.0	-19.7	0.0	1349.7
Oceania	1.4	75.0	-1.6	13.5	513.3
Latin America	-40.2	-144.4	13.8	0.0	792.8
Asia	-17.8	368.8	-27.8	-268.6	565.0
Africa and Middle East	-82.2	-14.3	0.0	0.0	-119.4
Indian Subcontinent	0.0	-11.9	0.0	0.0	10.0
Total	-140.3	292.6	-156.9	-255.1	3660.2
Soy-Based Biodiesel	Dairy	Cattle	Hog	Sheep	Poultry
North America (Canada)	0.3	1.3	64.2	0.0	-130.6
Western Europe	-0.2	16.5	-26.9	0.0	504.8
Eastern Europe	0.0	-1.5	8.5	0.0	-1017.0
Oceania	0.2	-4.7	-2.4	-37.9	-631.0
Latin America	-4.1	-66.9	10.5	0.0	-4131.9
Asia	11.4	-27.4	27.4	137.7	-696.5
Africa and Middle East	-12.0	6.4	0.0	0.0	-51.6
Indian Subcontinent	0.0	4.8	0.0	0.0	-625.7
Total	-4.3	-71.4	81.3	99.8	-6779.6
Sugarcane Ethanol	Dairy	Cattle	Hog	Sheep	Poultry
North America (Canada)	-0.2	2.7	-32.2	0.0	81.8
Western Europe	-0.1	-2.1	-0.6	0.0	90.1
Eastern Europe	0.0	1.7	-8.3	0.0	417.5
Oceania	0.2	-4.7	0.2	1.8	26.7
Latin America	-10.1	-40.7	-3.7	0.0	-1889.6
Asia	-3.8	-32.2	-31.1	-66.7	-136.8
Africa and Middle East	-13.0	0.0	0.0	0.0	4.4
Indian Subcontinent	0.0	26.3	0.0	0.0	-172.8
Total	-27.0	-48.9	-75.8	-64.9	-1578.7
Switchgrass Ethanol	Dairy	Cattle	Hog	Sheep	Poultry
North America (Canada)	0.4	-2.7	37.3	0.0	-99.0
Western Europe	0.1	3.4	0.0	0.0	-57.8
Eastern Europe	0.0	-2.4	10.2	0.0	-435.4

Oceania	-0.5	-11.1	0.4	-3.1	-108.6
Latin America	10.4	31.0	4.6	0.0	-81.9
Asia	6.7	1742.5	124.9	91.6	182.2
Africa and Middle East	21.4	2.3	0.0	0.0	90.1
Indian Subcontinent	0.0	5.5	0.0	0.0	12.0
Total	38.5	1768.5	177.3	88.5	-498.4

The enteric fermentation GHG impacts of livestock changes were calculated by applying regional default factors for enteric fermentation CH₄ emissions by livestock type. These factors are shown in Table 2.6-19.

Table 2.6-19. Enteric Fermentation Emission Factors

Enteric Fermentation (kg CH ₄ /head/year)	Dairy	Cattle	Swine	Sheep
North America	121	53	1.5	8
Western Europe	109	57	1.5	8
Eastern Europe	89	58	1.5	8
Oceania	81	60	1	5
Latin America	63	56	1	5
Asia	61	47	1	5
Africa and Middle East	40	31	1	5
Indian Subcontinent	51	27	1	5

Manure management GHG impacts of livestock changes for each fuel scenario were calculated by applying regional default factors for manure management CH₄ and N₂O emissions by livestock type. Manure management CH₄ emission factors are shown in Table 2.6-20. Manure management N₂O values were based on default IPCC nitrogen produced per livestock type and IPCC default manure management practices by region.

Table 2.6-20. Manure Management Methane Emission Factors

Manure Management (kg CH ₄ /head - year)	Dairy	Cattle	Swine	Sheep	Poultry
North America	78	2	23.5	0.28	0.02
Western Europe	51	15	15.5	0.28	0.02
Eastern Europe	27	13	6.5	0.28	0.02
Oceania	29	2	18	0.15	0.02
Latin America	1	1	1	0.15	0.02
Asia	18	1	4	0.15	0.02
Africa and Middle East	1.5	1	2	0.15	0.02
Indian Subcontinent	5	2	4	0.15	0.02

2.6.4.5 International Rice Production GHG Impacts

To estimate rice emission impacts internationally, we used the FAPRI model to predict changes in international rice production as a result of the increase in biofuels demand in the U.S.

Since FAPRI does not have GHG emissions factors built into the model, we applied IPCC default factors by country.

Calculating emissions from rice cultivation, per the IPCC 2006 guidelines, requires the following data: area of rice harvested, an emissions factor, and planting to harvesting season length. Area of rice harvested by country was provided by the FAPRI results. The default IPCC emission factors were used scaled for each cropping regime: irrigated, rainfed lowland, upland and deepwater by country. Rice cultivation season lengths were available from the International Rice Research Institute (IRRI).⁵³⁰

2.6.4.6 International Crop Residue Burning

International crop residue burning, and specifically changes in residue burning emissions from changes in U.S. biofuel policy, were not specifically included in this analysis. We did incorporate emissions from land clearing for crop production as discussed in Section 2.6.5. Changes in crop production and acres by country could lead to some changes in international residue burning emissions and we will examine methods of incorporating these impacts for the final rule.

2.6.4.7 International Agriculture Sector Results (excluding land use change)

Table 2.6-19 provides an overview of the total GHG emissions impacts from the international agricultural sector based on the results of the FAPRI modeling in terms of absolute changes between the GHG emissions from the different volume scenarios considered. Results are also presented on a per mmBtu basis by dividing total GHG changes by the mmBtu change in volume of biofuel produced between the different scenarios. Land use change impacts are discussed in Section 2.6.5.

This page intentionally left blank.

**Table 2.6-21.
Foreign Agriculture GHG Emission Changes in 2022 from Different Fuel Scenarios**

Emission Source	Corn Ethanol		Soybean Biodiesel		Switchgrass Ethanol		Brazilian Sugarcane Ethanol	
	Tonnes CO2-eq.	g/MMBtu CO2-eq.	Tonnes CO2-eq.	g/MMBtu CO2-eq.	Tonnes CO2-eq.	g/MMBtu CO2-eq.	Tonnes CO2-eq.	g/MMBtu CO2-eq.
Farm Energy Use Emissions	618,311	3,131	109,552	3,064	205,926	842	338,743	1,785
Farm Chemical Production / Transport Upstream Emissions	301,148	1,525	26,567	743	70,073	287	595,078	3,136
Livestock Changes GHG Emissions	210,309	1,065	-75,984	-2,125	2,666,036	10,906	-189,238	-997
Rice Production GHG Emissions	365,322	1,850	69,645	1,948	228,504	935	134,861	711
Fertilizer / Soil N2O Emissions	589,342	2,984	32,256	902	138,339	566	819,096	4,317
Total:	2,084,432	10,555	162,036	4,532	3,308,879	13,536	1,698,540	8,952

This page intentionally left blank.

2.6.5 Land Use Change GHG Impacts

Our lifecycle GHG estimates include emissions from domestic and international land use changes induced by increased renewable fuels consumption in the U.S. To estimate land use change GHG emissions we had to answer five key questions:

1. How much land is converted?
2. Where does land use change occur?
3. What types of land are converted?
4. What are the GHG emissions from that land conversion?
5. How do we account for the variable timing of land use change GHG releases?

This section describes our approach for answering these questions about land use change. We used FASOM to predict the total amount of cropland expansion in the U.S. FASOM was designed to simulate land use interactions to predict the types of land converted in the U.S. We used the FAPRI model to project international cropland expansion in response to increased U.S. biofuel consumption. The FAPRI model projects the area and amount of additional crop production, both by crop and country. FAPRI does not, however, project which types of land would be cleared to make room for additional cropland, or where within in each country or region cropland expansion would likely take place. To fill this information gap we used MODIS satellite data provided by Winrock International Incorporated (from now on referred to as Winrock), that shows recent trends in land use change from 2001 to 2004. To determine the GHG impacts of the projected land use changes we applied GHG emissions factors prepared by Winrock. We then used a net present value of GHG emissions to account for the variable time profile of land use change emissions.

2.6.5.1 How Much Land Is Converted

The main question regarding the amount of new land needed to meet an increasing demand for biofuels hinges on assumptions about the intensification of existing production versus expansion of production to other lands. This interaction is driven by the relative costs and returns associated with each option, but there are other factors as described in the following sections.

2.6.5.1.1 Co-Product Use

One factor determining the amount of new crop acres required under an increased biofuel scenario is the treatment of co-products. For example, distillers grains (DGs) are the major co-product of dry mill ethanol production that is also used as animal feed. Therefore, using the DGs as an animal feed to replace the use of corn tends to offset the loss of corn to ethanol production, and reduces the need to grow additional corn to feed animals. Along with the recent growth in corn ethanol production has been an expansion in the handling and use of DGs. FASOM and FAPRI use data about recent DGs usage to predict how DGs will affect agricultural markets as corn ethanol production expands even further, but there is still some uncertainty about how these co-products will be used in the future (e.g., whether it can be reformulated for higher

incorporation into pork and poultry diets, whether it will be dried and shipped long distances, whether fractionation will become widespread).

Both our FASOM and FAPRI models account for the use of DGs in the agricultural sector. The FASOM and FAPRI models both assume that a pound of co-product would displace roughly a pound of feed. DG replacement is driven by how much DG can be included in animal feed, this so called inclusion rate differs by type of animal. The inclusion rate in turn impacts what percent of the DG produced will be used in which animal feed market. Finally the DG will substitute for different alternative feed products in different animal diets.

USDA reports that typical inclusion rates are 30-40 percent for beef cattle, 20-25 percent for dairy, 20 percent for hogs and 15 percent for poultry.⁵³¹ Furthermore, the same report indicates that a pound of DG will replace a pound of corn in beef rations, 0.45 pounds of corn in dairy rations, 0.85 pounds of corn in hog rations and 0.55 pounds of corn in poultry rations, with the remainder replacing soybean meal. Based on these assumptions and also that the majority of DG is used in the beef cattle market, FASOM assumes that one pound of DG will offset 0.9 pounds of corn and 0.1 pound of soybean meal.

The FAPRI model uses a slightly different set of assumptions for DG inclusion rates.⁵³² Beef cattle feed ration has the highest inclusion rate at 41% to 50%, the maximum inclusion rate for dairy follows at 26% to 30%, for hogs 20%, and for poultry 20%. Furthermore FAPRI assumes that DG will replace corn in beef and dairy cattle rations at 0.97 pound per pound, followed by pork at 0.89 pound per pound, and then poultry at 0.79 pound per pound. Displacement of soybean meal as a source of protein is 0.03 pound per pound of DG for beef and dairy cattle, 0.11 for pork, and 0.21 for poultry. FAPRI accounts for DG exports so that not all of the DG produced in the domestic ethanol market is used in the U.S. animal feed sector. Of the amount that is used in the U.S., FAPRI assumes that the use of DG in animal feed is highest in the beef cattle sector (61% share), followed by the dairy sector (21%), and then pork (9%) and poultry (9%) sectors. Based on all these assumptions, FAPRI calculates that a pound of DG replaces 0.95 pounds of corn and 0.05 pounds of soybean meal.

A recent paper by Argonne National Laboratory⁵³³ estimates that 1 pound of DGs can displace more than a pound of feed due to the higher nutritional value of DGs compared to corn. However, the Argonne replacement ratios do not take into account the dynamic least cost feed decisions faced by livestock producers. The actual use of DGs will depend on the maximum inclusion rates for each type of animal (based on the digestibility of DGs), the displacement ratio for each type of animal (based on DGs energy and protein content), and the adoption rate (based on the feed value relative to price).

Furthermore, as world vegetable oil prices increase, dry mill ethanol producers will have an incentive to extract the corn oil from the DGs. This step changes the nutritional content of the DGs, which results in different replacement rates than currently used in FAPRI or FASOM or described by Argonne.

We plan to evaluate and incorporate a least cost feed rationing approach for the final rule in both the FASOM and FAPRI modeling systems. This will include assumptions about

inclusion rates and displacement ratios, including considering additional replaced feed inputs such as urea as a protein source.

2.6.5.1.2 Crop Yields

Assumptions about yields and how they may change over time can also influence land use change predictions. Domestic yields were based on USDA projections, extrapolated to 2022. In 2022 we estimate that the U.S. average corn yield will be approximately 180 bushels/acre (a 1.6% annual increase consistent with recent trends) and average U.S. soybean yields will be approximately 50 bushels per acre (a 0.4% annual increase).^{RRRRRRR} Using the FASOM model, we conducted a sensitivity analysis on the impact of higher and lower yields in the U.S. Details on this scenario are included in DRIA Chapter 5.1. International yields changes are also based on historic trends. The FAPRI model contains projected yields and yield growth rates that are generally lower in other countries compared to the U.S. For example, corn yields in Argentina are assumed to be approximately 140 bu/acre in 2022 (a 0.8% annual increase). Corn yields in Brazil are assumed to be 68 bu/acre in 2022 (a 1.1% annual increase).

The FASOM and FAPRI models currently do not take into account changes in productivity as crop production shifts to marginal acres or the impact of price-induced yield changes on land use change. We would expect these two factors to work in opposite directions, and therefore serve as offsetting impacts. Marginal acres in fully developed agricultural systems are expected to have lower yields, because most productive acres are already under cultivation. This may not be the case in developing systems where prime agricultural lands are not currently in full production due to, for example, lack of supporting infrastructure. Changes in agricultural inputs (e.g., fertilizer, pesticides) can also change crop yields per acre. Higher commodity prices might provide an incentive to increase production on existing acres. If the costs of increasing productivity on existing land were minimal relative to the value of the increased production, then agricultural landowners would presumably adopt these productivity-enhancing actions under the reference case. Although it is reasonable to assume a trend wherein some productivity-enhancing practices may become profitable if commodity prices are high enough, it is not clear that farmers would find significant increases in production per acre profitable. If crop yields either domestically or international are significantly impacted by higher commodity prices, this could affect our assessment of land use impacts and the resulting GHG emissions due to increased biofuel demand in the U.S. However, as described in Chapter 5, the change in commodity prices associated with the increase in U.S. biofuel as a result of the EISA mandates are relatively small and likely not large enough to induce very large yield changes.

2.6.5.1.3 Land Conversion Costs

The assumed cost associated with different types of land conversion can also play a key role in determining how much land will be converted. In FASOM, the decision to convert land from pasture or forest to cropland is based on whether the landowner can increase the net present value of expected returns through conversion (including any costs of conversion). Among other things, the decision to convert land depends on regional yields, costs, and other factors affecting

^{RRRRRRR} Note that these assumptions about exogenous yield increases were applied in every scenario.

profitability and on the returns to alternative land uses. In other words, FASOM assumes that land conversion is based on maximizing profits rather than minimizing costs.

FASOM allows acres to convert between different types of crops without incurring conversion costs. Crop land is allowed to move from the pasture land inventory into the crop land category and backwards; however, there are replacement costs for forage as well as conversion costs of moving between land uses. Conversion costs from pasture to crop are expected to be generally lower than conversion costs from forest to crop, because forest conversion requires an investment to clear stumps, level, and otherwise prepare the land for planting. Conversion cost will also depend on the type of forest land converted and the value of the lumber or other products removed. The land quality factors such as topography or soil characteristics generally restrict some lands to only be in forest. Likewise, growing conditions render some lands unsuitable for forest uses at all, particularly in the drier plains areas and would thus only be suitable for some agricultural uses. For land moving from forest to agriculture, the net present value of land in agriculture must exceed returns to a rotation in forestry plus the future value of forested land by the investment cost to transfer land plus any hurdle cost (this term is currently set to zero). In both land transfer cases, the land moves between sectors until the markets equilibrate and the net present value plus the investment and market wedges are equal across the sectors for lands on the margin. Land movement does not occur if the differences in the land returns are less than the hurdle cost plus the land transformation investment costs.

FAPRI does not explicitly model land conversion costs, but the international production supply curves in the FAPRI model implicitly account for conversion costs. FAPRI's supply curves are based on historical responses to price changes, which account for land conversion costs, based on expected future returns associated with land conversion. Thus, international land use changes projected by FAPRI are based on economic land-use decisions.

2.6.5.1.4 Total Area of Land Converted

We ran the FASOM and FAPRI models with the volume scenarios described in Table 2.3-1 to estimate biofuel induced crop expansion domestically and internationally. The FASOM results were used to represent domestic land use change and FAPRI results were used to determine international land use change.

FASOM domestic land use change was described in Section 2.6.2.1. Table 2.6-22 shows the FASOM land use change results for the different fuel scenarios considered.

Table 2.6-22. Domestic Crop Expansion by Scenario, 2022

Scenario	Total Cropland Increase (million acres)	Normalized Cropland Increase (acres per thousand ethanol equivalent gallons)
Corn Ethanol	0.3	0.13
Soybean Biodiesel	0.2	0.34
Corn Stover Ethanol	0.0	0
Switchgrass Ethanol	1.3	0.28

The FAPRI model predicted cropland shifting internationally due to changes in U.S. exports for the different fuel volume scenarios considered. Not all export losses are made up with production, as there are shifts in crops and decreases in demand that also occur. Figure 2.6-14 shows absolute internationally crop production pattern changes and Figure 2.6-14 shows per gallon crop pattern changes due to the changes in U.S. exports.

Figure 2.6-14.
Foreign Cropland Changes by Scenario, 2022
(millions harvested acres)

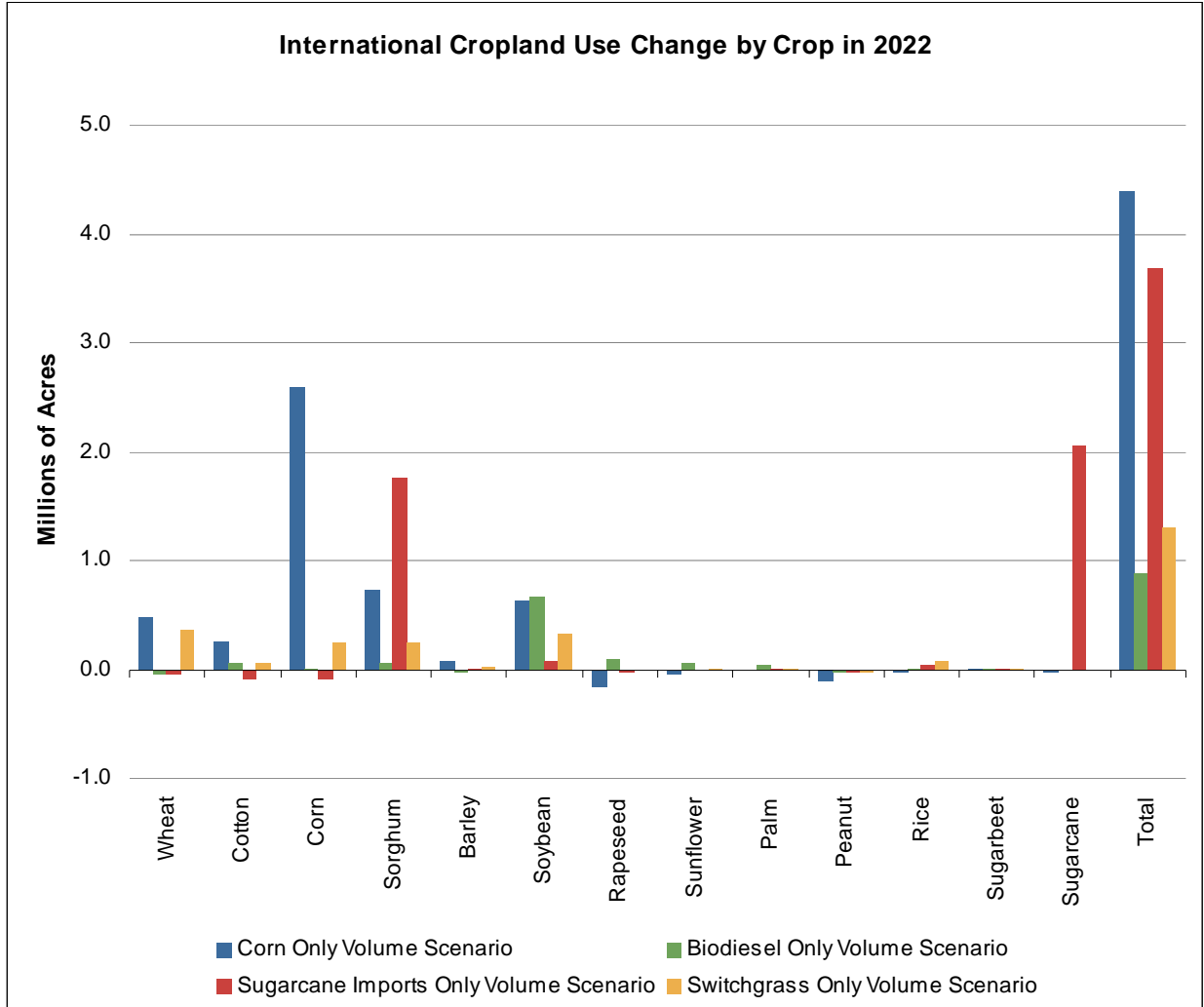
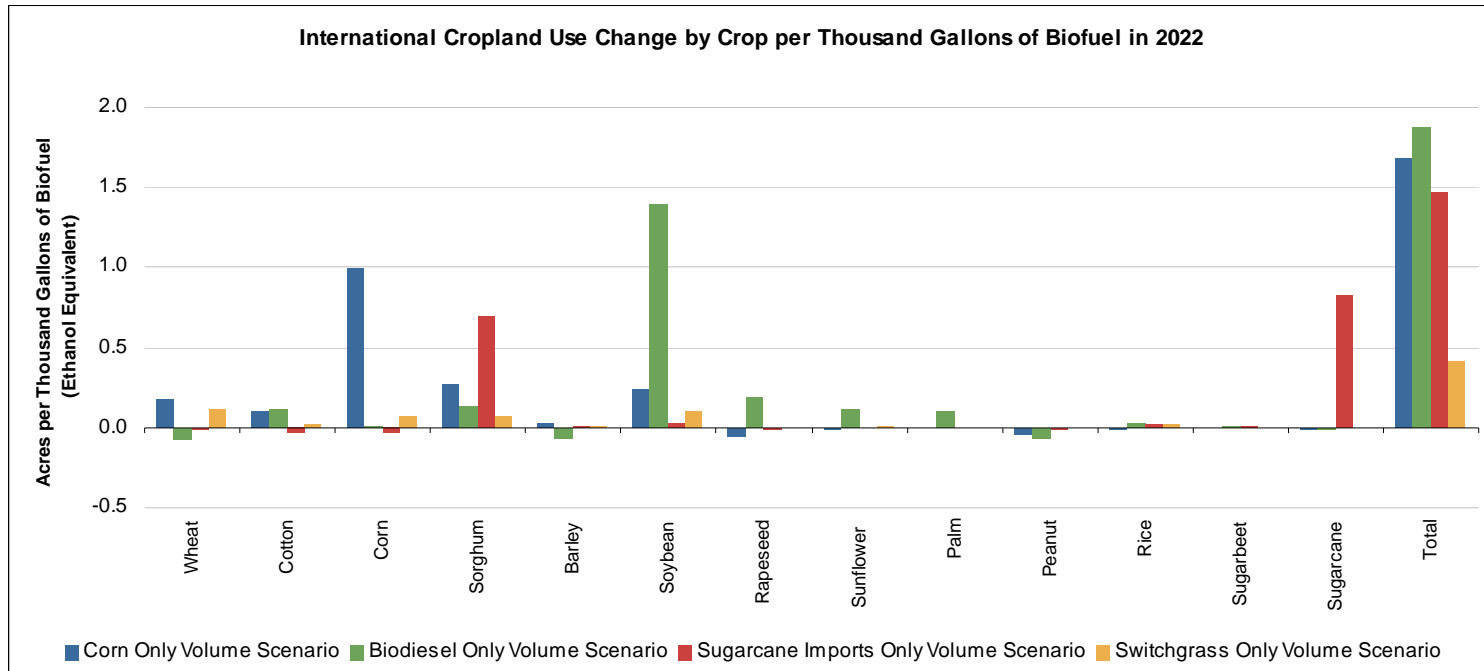

Figure 2.6-15.
Normalized Foreign Cropland Changes by Scenario, 2022
(harvested acres per thousand gallons)



This page intentionally left blank.

Table 2.6-23 shows the FAPRI land use change results for the different fuel scenarios considered.

Table 2.6-23. Foreign Cropland Increase by Scenario, 2022

Scenario	Total Cropland Increase (million harvested acres)	Normalized Cropland Increase (acre per thousand ethanol equivalent gallons)
Corn Ethanol	4.4	1.68
Soybean Biodiesel	0.9	1.87
Switchgrass Ethanol	1.3	0.41
Brazilian Sugarcane Ethanol	3.7	1.48

The switchgrass ethanol scenario shows the least acreage change per gallon. This is partly due to the fact that in 2022 switchgrass ethanol is assumed to have high yields per acre. For example, corn ethanol yields in 2022 are assumed to be approximately 480 gal/acre, while switchgrass ethanol yields are assumed to be approximately 580 gal/acre. The corn stover ethanol case is not assumed to have any land use change impacts. The models also show that there are significant land use change impacts associated with increased sugarcane production in Brazil, and resultant changes in Brazilian commodity exports. Soybean biodiesel has lower gallons per acre yields than other fuels, approximately 75 gallons per acre, requiring more land per gallon of soy-based biodiesel production. However, biodiesel has a higher energy content than ethanol, so on a per gallon basis offsets more petroleum fuel, which decreases the land use impact per gallon of biodiesel production.

2.6.5.2 Where Does Land Use Change Occur

The first step in determining what domestic and international land will be converted due to biofuels production is to determine to what extent the increased demand for biofuel feedstock will be met through increased U.S. agricultural production or reductions in exports.

This question has several implications. For example, U.S. agricultural production is typically more energy and input intensive, but has higher yields, than agricultural production in other parts of the world. This implies that increased production in the U.S. has higher input GHG emission impacts but lower land use change impacts compared to overseas production. In addition, the types of land where agriculture expands would be different in the U.S. as compared to other parts of the world.

As noted previously, EPA's analysis relies on FASOM predictions to represent changes in the U.S. agricultural sector, including land use, and on FAPRI to predict the resulting international agricultural sector impacts, including the amount of additional cropland needed under different scenarios. The impact on the international agricultural sector is highly dependent on U.S. agricultural commodity export fluctuations resulting from increased biofuel production. As shown in Section 2.6.3, coordination of assumptions between FASOM and FAPRI has generated a consistent export picture response from both the FASOM and FAPRI model for the majority of biofuel and feedstock scenarios considered.

FASOM and FAPRI also show similar domestic land use change responses, with large shifts between crops. Figure 2.6-16 shows the comparison of FASOM and FAPRI domestic crop acre changes for the different fuel scenarios. Soy-based biodiesel production has the largest impact on U.S. exports per ethanol equivalent gallon. For the corn and switchgrass ethanol, the models show the same type of response, with FAPRI showing slightly higher overall net crop acreage growth.

Figure 2.6-16.
Comparison of FASOM and FAPRI Domestic Crop Acre Changes by Scenario, 2022
(acres per thousand ethanol equivalent gallons)

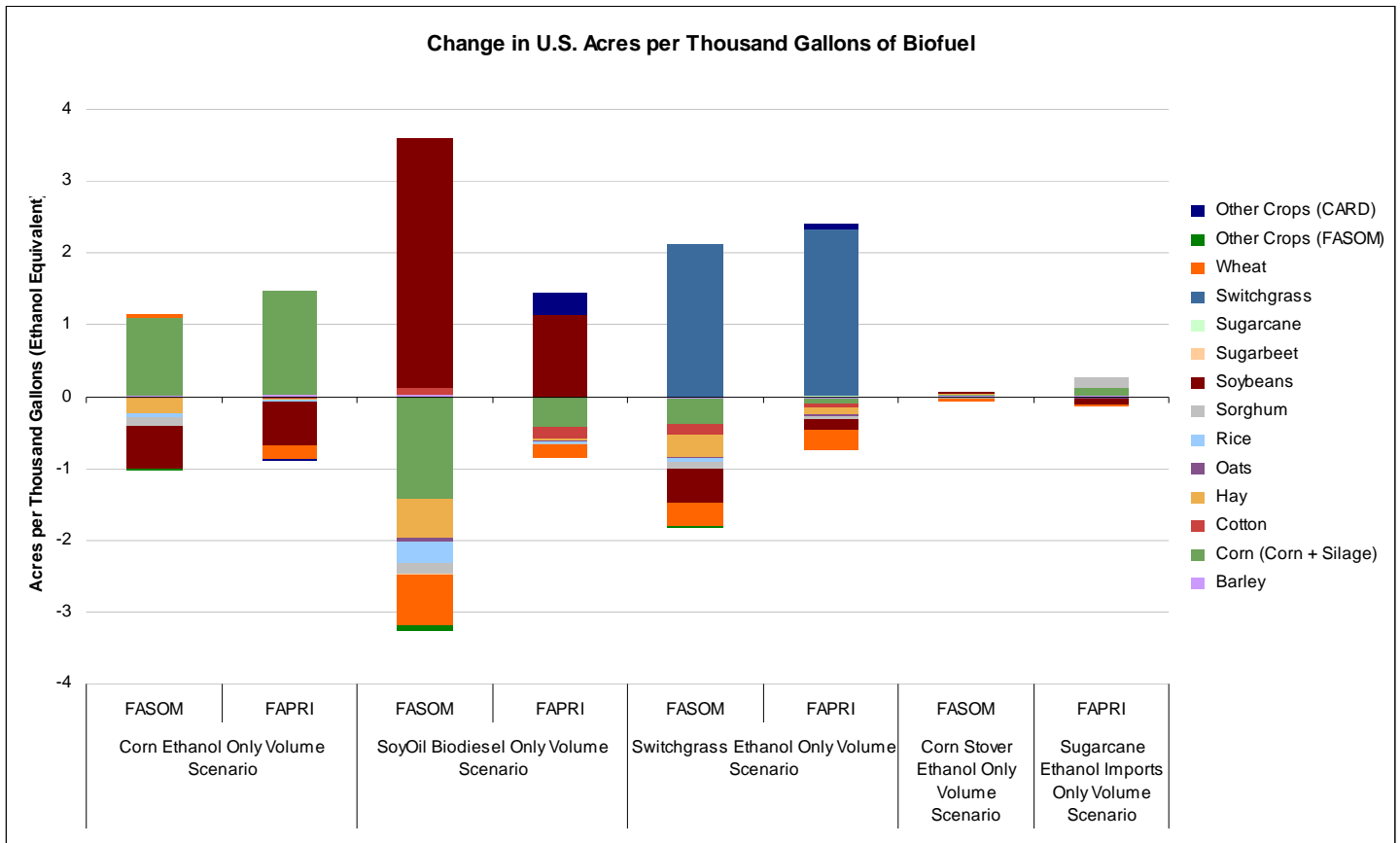

Due to the wide range of carbon and biomass properties associated with land in different parts of the world, the location of crop conversion is also important to our lifecycle analysis. For example, an acre of forest in Southeast Asia stores a much larger quantity of carbon than an acre of forest in Northern Europe. The FAPRI model provides estimates of the acreage change by country and crop that result from a decrease in U.S. exports due to the increase in U.S. biofuel demand. These estimates are based on historic responsiveness to changes in prices in other countries. Implicit in these supply curves are the costs associated with converting new land to crop production and the relative competitiveness of each country to increase production based on production costs, yields, and transportation costs. FAPRI also includes in its baseline projections estimates of future population growth, GDP growth, and other macroeconomic changes. FAPRI

also takes into account the fact that not all U.S. exports will need to be made up in international production, as there are small decreases in demand due to shifts in crop production and higher prices.

Figure 2.6-17 shows absolute acres of crop conversion, and Figure 2.6-18 includes normalized cropland changes for the different fuel scenarios. Our modeling predicts that Brazil will account for a large portion of international crop expansion as a result of U.S. biofuel production and production of sugarcane ethanol in Brazil. However, other countries have major crop expansion as well, including India and Nigeria.

Figure 2.6-17.
Regional Crop Expansion by Renewable Fuel, 2022
(thousand harvested acres)

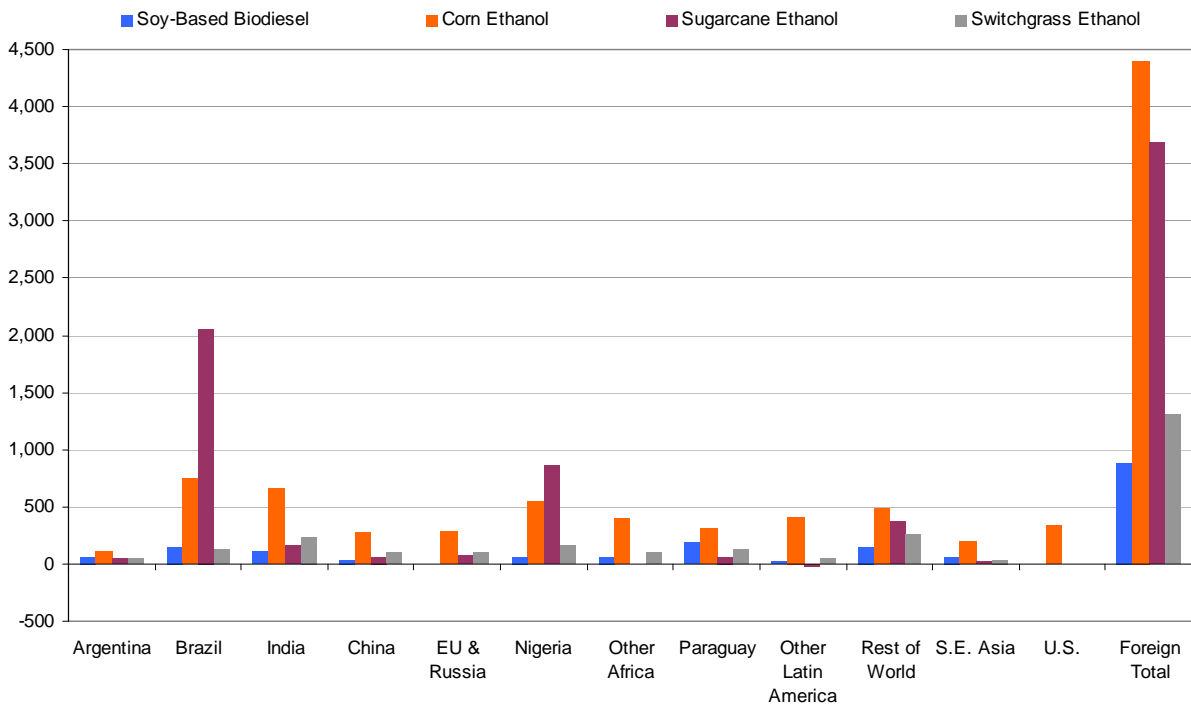

**Figure 2.6-18.
Normalized Regional Crop Expansion by Renewable Fuel, 2022
(harvested acres per thousand gallons)**

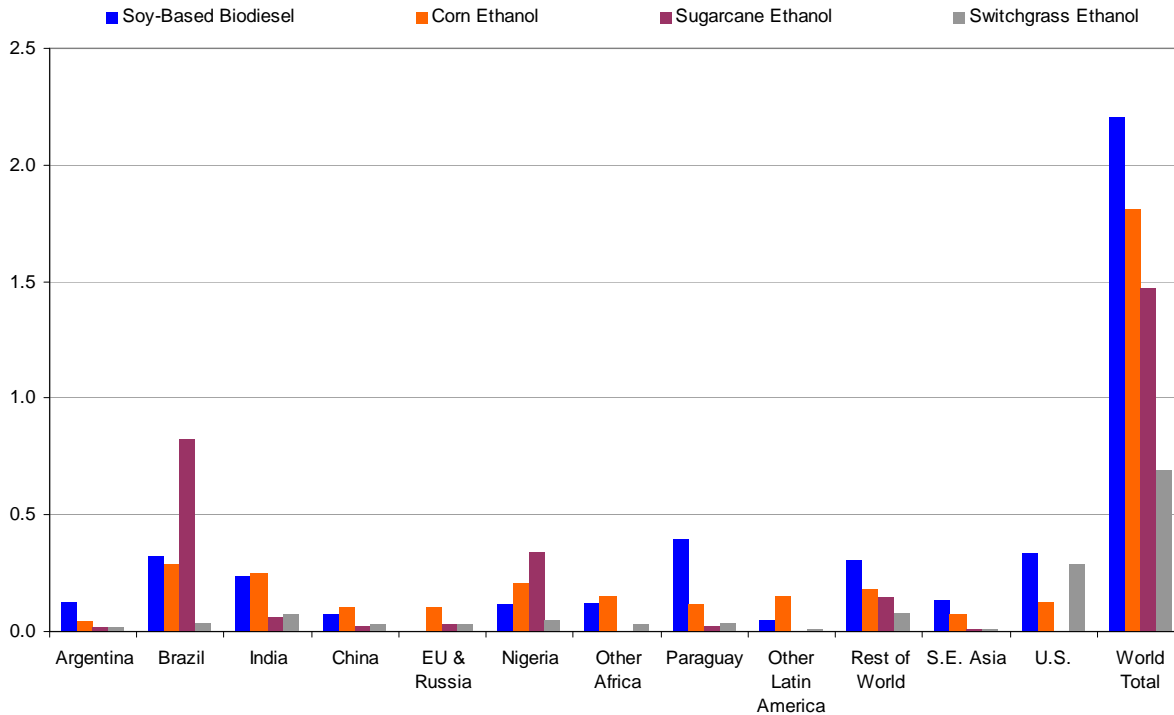

2.6.5.3 What Type of Land is Converted

2.6.5.3.1 Domestic Land Use Conversion

The FASOM model includes competition for land between agriculture, pasture, and forest. The interaction is based on providing the highest rate of return across the different land types. Therefore, domestically we have the ability to explicitly model what types of land would be converted to increased agriculture based on the rates of return for different land types for the 63 regions in FASOM. For this proposal we incorporated the agricultural component of the FASOM model, but not the forestry component, so domestically all additional cropland comes from pasture. As we incorporate the FASOM forestry model for the final rule we expect to see more interaction between the forestry and agriculture sectors, such that there may be conversion of forest to agriculture. While we do not know if forest will be converted to cropland, or the extent that this might occur, if domestic forests were converted to cropland, we would expect domestic GHG emissions to increase. On the other hand, if more crop expansion occurs domestically we would expect that to offset some of the growth in foreign crop acreage. This work will be incorporated for our final rule.

2.6.5.3.2 International Land Use Conversion

Since FAPRI does not contain information on what type of land would be converted into cropland, we worked with Winrock to address this question. Using satellite data from 2001-

2004, Winrock provided a breakdown of the types of land that have been converted into crop land for a number of key agricultural producing regions. We used this information about recent land use trends to estimate which types of land would be cleared in each region. Below we provide details about the data sources and methods used for these calculations.

2.6.5.3.2.1 International Land Use Conversion Data Sources

Change in land use and land cover (LU/LC) was estimated at the country and state level using MODIS satellite imagery (1 km resolution pixels) for the years 2001 and 2004 for all countries. MODIS imagery was chosen for this analysis due to its global coverage and homogenous classification scheme that allows direct comparison across time and space. MODIS (Moderate Resolution Imaging Spectroradiometer) is a sensor that offers a unique combination of features: it detects a wide spectral range; it takes measurements at three spatial resolutions (levels of detail); it takes measurements all day, every day; and it has a wide field of view. MODIS is one of several sensors carried on both the Terra and Aqua satellites, managed by NASA. Terra was launched in December 1999 and Aqua was launched in May 2002. Both satellites complete a north to south orbit of the Earth in less than 2 days. The land cover dataset published by the USGS used in this analysis, MODIS/Terra Land Cover Type Yearly L3 Global 1km SIN Grid (MOD12Q1) version 4, comes from the Terra satellite.^{sssssss}

The MOD12Q1 data are compiled from several sources to create a yearly global land cover map. Inputs to the MODIS/Terra Land Cover Type Yearly L3 Global 1km SIN Grid include:

1. Land/water mask that restricts classification to land regions and shallow water regions
2. The MODIS Land Bands (1-7)
3. Spatial texture derived from Band 1
4. Directional reflectance information
5. MODIS Enhanced Vegetation Index (EVI)
6. Snow cover
7. Land surface temperature
8. Terrain elevation information

These data are composited over a 32-day cycle and values for land classification, change detection and mixture modeling are assigned by algorithms using decision tree and artificial neural network classifiers. Land cover classes are processed by continent. The 32 day products are used to produce the yearly globally-consistent, multi-temporal MOD12Q1 database on a 1-km grid.

The algorithm development and validation efforts for the Land Cover Product are based on a network of test sites developed to represent major global biomes and cover types. Sites for which temporal sequences of Thematic Mapper (TM) and AVHRR data, coupled with fine-resolution land cover and vegetation data, are available, especially in North and South America

^{sssssss} The official MOD12Q1 version 4 data were publicly released at the EDC DAAC on April 16, 2004. It can be found at <http://edcdaac.usgs.gov/modis/mod12q1v4.asp>

(Belward 1999). According to the MODIS land team validation website, the accuracy of the IGBP land cover product, version 3, is 75-80 percent globally; 70-85 percent by continental regions; and in individual classes ranges from 60 in closed shrubland to 90 percent for barren or sparse land cover.^{TTTTTTT} This analysis used version 4 of the MODIS/Terra Land Cover Type Yearly L3 Global 1km SIN Grid which is published as being validated to Stage 1. A Stage 1 validation means that the product accuracy has been estimated using a small number of independent measurements obtained from selected locations and time periods and ground-truth/field program effort. There are no published reports as to the accuracy of version 4 but it would be safe to assume it is no worse than version 3 and in all likelihood better.

Two tools are used by the MODIS land team to assess data quality; confusion matrixes and aggregations of confidence values. The confusion matrixes describe how well the training sites are classified when they are unknown by the classifier, and so provide information on the accuracy of the classification process as applied to the training site database. The confidence values are generated by the classifier and indicate how well the pattern of spectral and temporal variation in annual observations of each pixel fits the examples of training data provided to the classifier. They may be treated as probabilities of correct classification, given the input training data.

Within the classification process, errors are generated when the classification algorithm selects the wrong class. With respect to a particular class, errors of omission occur when pixels of that class are assigned wrong labels; errors of commission occur when other pixels are wrongly assigned the label of the class considered. These errors occur when the signal of a pixel is ambiguous, perhaps as a result of spectral mixing, or when the signal is produced by a cover type that is not accounted for in the training process. These errors are a normal part of the classification process. They can be minimized, but not voided entirely. Although they cannot be identified on a pixel-by-pixel basis due to processing constraints, they can be characterized in a statistical sense.

Although other global land cover products are available (such as the Global Land Cover 2000 dataset), the purpose of this analysis was to analyze *change* in land use and cover over time. Thus we chose to use the MODIS imagery because it adheres to a uniform 17-category IGBP classification scheme at both time periods (2001 and 2004), allowing for direct comparison over multiple regions and years.

MODIS data are published using the International Geosphere Biosphere Programme (IGBP) global land cover categories, a list of 17 cover classes (Table 2.6-23). The IGBP land cover list includes eleven classes of natural vegetation, three classes of developed and mosaic lands, and three classes of non-vegetated lands. The natural vegetation units distinguish evergreen and deciduous, broadleaf and needle-leaf forests, mixed forests, where mixtures occur; closed shrublands and open shrublands; savannas and woody savannas; grasslands; and permanent wetlands of large areal extent. The three classes of developed and mosaic lands distinguish among croplands, urban and built-up lands, and cropland/natural vegetation mosaics. Classes of non-vegetated land cover units include snow and ice; barren land; and water bodies.

^{TTTTTTT} The MODIS land team validation website can be accessed at <http://landval.gsfc.nasa.gov/ProductStatus.php?ProductID=MOD12>

**Table 2.6-23.
Original IGBP and Modified Classification Schemes for MODIS Land Cover Imagery
for the Years 2001 and 2004.**

IGBP Land cover class	Modified land cover class (this analysis)	IGBP Class Explanation
Water Bodies	<i>Excluded</i>	
Evergreen Needleleaf Forests	Forest	Lands dominated by trees with a %canopy cover >60% and height >2m. Almost all trees remain green all year, canopy is never without green foliage.
Evergreen Broadleaf Forests	Forest	Lands dominated by trees with a %canopy cover >60% and height >2m. Almost all trees remain green all year. Canopy is never without green foliage.
Deciduous Needleleaf Forests	Forest	Lands dominated by trees with a % canopy cover >50% and height exceeding 2m. Consists of seasonal needleleaf tree communities with an annual cycle of leaf-on and leaf-off periods.
Deciduous Broadleaf Forests	Forest	Lands dominated by trees with a %canopy cover >60% and height exceeding 2m. Consists of seasonal broadleaf tree communities with an annual cycle of leaf-on and leaf-off periods.
Mixed Forests	Forest	Lands dominated by trees with a %canopy cover >60% and height >2m. Consists of tree communities with interspersed mixtures or mosaics of the other four forest cover types. None of the forest types exceeds 60% of landscape.
Closed Shrublands	Shrubland	Lands with woody vegetation <2m tall and with shrub canopy cover >60%. The shrub foliage can be either evergreen or deciduous.
Open Shrublands	Shrubland	Lands with woody vegetation <2m tall with shrub canopy cover between 10-60%. The shrub foliage can be either evergreen or deciduous.
Woody Savannas	Savanna	Lands with herbaceous and other understory systems and canopy cover of 30-60%. Height >2m.
Savannas	Savanna	Lands with herbaceous and other understory systems and canopy cover of 10-30%. Height >2m.
Grasslands	Grassland	Lands with herbaceous types of cover. Tree and shrub cover is less than 10%.
Permanent Wetlands	<i>Excluded</i>	
Croplands	Cropland	Lands covered with temporary crops followed by harvest and a bare soil period (e.g., single and multiple cropping systems). Note that perennial woody crops will be classified as the appropriate forest or shrub land cover type.
Urban and Built-Up	<i>Excluded</i>	
Cropland/Natural Vegetation Mosaic	<i>Excluded</i>	
Permanent Snow and Ice	<i>Excluded</i>	
Barren or Sparsely Vegetated	<i>Excluded</i>	
Unclassified	<i>Excluded</i>	

The IGBP land cover categories were not designed for use with MODIS specifically. Rather, the classification system was first published with the IGBP Global Land Cover Map (DISCover v 1.0) in 1997. This dataset was derived at 1 km resolution from the Advanced Very High Resolution Radiometer (AVHRR) sensor on board several NOAA satellites and the 17 land cover classes are based on biophysical properties.

We first reclassified the land use and land cover categories included in the original MODIS imagery into five general classes: cropland, forest, grassland, savanna and shrubland (See Table 2.6-23). As the MODIS land cover maps used for this analysis are coarse resolution (1-km, equivalent to a pixel area of 100 hectares) and classified into broad land cover categories, the spectral characteristics of the finer classes may be similar to each other in many cases and thus land use conversions among them could be ambiguous. Other categories in the MODIS imagery that fell outside these five land cover classes (e.g., urban/built-up land) were excluded from the analysis. An example of the imagery before and after reclassification is shown for Argentina (top) and Brazil (bottom) in Figure 2.6-18.

Figure 2.6-18.
Comparison of Original MODIS Classification (left) and Reclassification Used for This Analysis (right) for Two Sample Countries: Argentina (Top) and Brazil (Bottom).

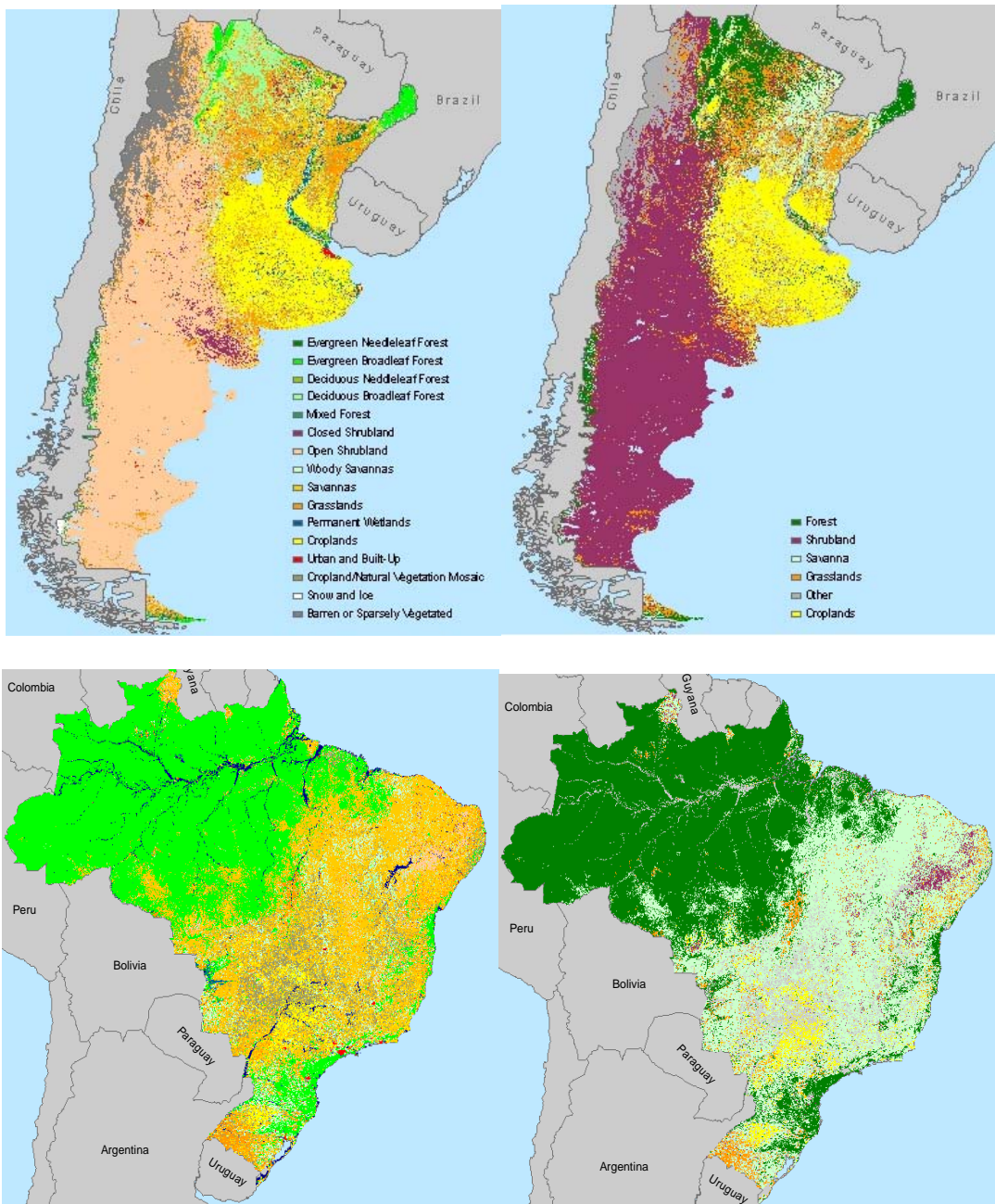

After we had reclassified the two map products, change analyses were conducted by comparing the land cover map from 2001 with that for the same location at 2004. A new dataset for each country, now referred to as land change data, was produced that showed how the original land cover categories within each state and country changed, if at all, and into what new category the change occurred—often referred to as a land cover change matrix.

Comparing two products directly is not the best way to analyze change in LU/LC, as errors in the interpretation of the first map can be compounded when compared to a second map. The ideal way is to conduct a change analysis directly and interpret the change. However, a direct change analysis requires a major effort to not only perform the change detection but to also interpret what the change is (from what to what). A comparison of the two LU/LC maps to obtain change is not the most desirable approach but it is the only approach available given the products that exist. Furthermore, very few countries have LU/LC products that have been prepared using change detection techniques for full change detection in all LU/LC classes.

Even with the best available imaging technology, we found that the areas of some of the LU/LC classes and their changes are somewhat ambiguous. In an attempt to shed light on the causes of these ambiguities, we first compared the area of forest cover for the 2004 MODIS product with that given in the FAO FRA 2005 report (See Table 2.6-24.⁵³⁴ Several anomalies in the two data sets are evident:

-- All countries report greater area of forest in the FRA 2005 report than we obtained from the MODIS product, *except* for the three Southeast Asian countries of Indonesia, Malaysia, and Philippines.

-- The greater area of forest reported by FRA 2005 is to be expected as FAO requires countries to report area of all wooded lands with a canopy cover of 10% or higher, whereas the MODIS product defines forests with a canopy cover greater than 50-60%. For example, FRA 2005 gives almost 478 million ha of forest for Brazil –this includes not only the Amazonian and Atlantic forests, but also a range of woody savanna/shrublands that have a canopy cover of >10%. In our analysis, these woody savannas and shrublands are purportedly reported as a separate class, resulting in an area of forest of about 406 million ha. The reasons for the greater forest cover reported under FRA 2005 versus the MODIS estimate for the other countries are likely to be the same as for Brazil.

-- For Indonesia, Malaysia, and the Philippines, the MODIS product results in considerably greater forest area than reported by FRA 2005. This suggests that the large areas of plantation, perennial tree crops (e.g. rubber and palm oil plantations), and the woody formations are classed as forest under the MODIS algorithm.

**Table 2.6-24.
Country-Level MODIS Forest Area Cover Data and Forest Cover
Reported in FAO FRA 2005**

Country	MODIS 2004 Forest Area (ha)	FAO FRA2005 Forest Area (ha)
Argentina	23,566,147	33,021,000
Brazil	402,472,52+	477,698,000
China	149,007,347	197,290,000
India	31,807,808	67,701,000
Indonesia	150,652,300	88,495,000
Malaysia	28,309,936	20,890,000
Philippines	15,952,945	7,162,000

There are other ambiguities in the MODIS data. For some countries forest area appeared to increase (Brazil, China, Malaysia) or show little change (Indonesia, Philippines) in the period 2001-2004, and the rest had a loss in forest cover as is often expected. However, Table 2.6-25 shows the net change, and just because total area appears to change little or even increase it does not mean that forests are not being cleared. The value of the MODIS data is that transitions between all LU/LC classes can be estimated for the period 2001-2004. For example, Table 2.6-25 shows that 341,186 hectares of land were converted from forest to cropland in Brazil from 2001 to 2004.

**Table 2.6-25.
Area of Main LU/LC Classes in Brazil in 2001 and 2004 Based on MODIS Data**

BRAZIL		2004						Total Hectares 2001
2001	Cropland	Forest	Grassland	Mixed	Savanna	Shrub		
Cropland	9,477,369	249,901	919,366	4,346,228	8,529,974	116,682	23,639,519	
Forest	341,186	379,059,490	1,408,111	1,500,199	15,947,827	1,136,045	399,392,858	
Grassland	1,472,851	1,453,441	9,152,627	2,576,107	22,384,406	1,456,720	38,496,152	
Mixed	4,918,777	1,813,684	2,064,084	21,433,207	25,956,386	211,126	56,397,265	
Savanna	6,004,819	18,614,978	12,295,754	21,595,617	214,505,969	4,698,914	277,716,052	
Shrub	304,374	1,281,032	2,190,966	440,100	16,752,860	7,296,200	28,265,531	
Total Hectares 2004	22,519,377	402,472,526	28,030,907	51,891,458	304,077,422	14,915,687	823,907,377	

MODIS also provides intra-country LU/LC changes by state or administrative unit. For example, using MODIS data Table 2.6-26 shows where forest to cropland conversion took place in Brazil between 2001 and 2004.

**Table 2.6-26.
MODIS Forest to Crop Conversion in Brazil , 2001 to 2004**

Country	State	Share of Forest to Crop Conversion
Brazil	Acre	0.0%
	Alagoas	2.0%
	Amapa	0.6%
	Amazonas	0.1%
	Bahia	3.5%
	Ceara	0.2%
	Distrito Federal	0.0%
	Espirito Santo	0.7%
	Goiias	4.1%
	Maranhao	1.1%
	Mato Grosso	3.2%
	Mato Grosso Do Sul	11.5%
	Minas Gerais	4.1%
	Para	1.6%
	Paraiba	0.3%
	Parana	31.2%
	Pernambuco	1.5%
	Piaui	0.1%
	Rio De Janeiro	0.2%
	Rio Grande Do Norte	0.1%
	Rio Grande Do Sul	15.4%
	Rondonia	0.0%
	Roraima	0.1%
Santa Catarina	2.9%	
Sao Paulo	14.5%	
Sergipe	0.8%	
Tocantins	0.2%	
All Brazil		100.0%

2.6.5.3.2.2 Calculating the Type and Location of Land Use Change

We used the MODIS LU/LC data described above to estimate what types of land would be cleared to make room for cropland expansion, and where within countries that land conversion would occur. The steps in this calculation are described below, with Brazil as the primary example.

2.6.5.3.2.2.1 What Type of Land is Converted to Cropland by Region

Table 2.6-27 shows the percentage of land type converted to cropland according to the MODIS data. We used these percentages to calculate a weighted average of the types of land converted into cropland. For example, if FAPRI predicts that one additional hectare of cropland

will be brought into production in Brazil, we used the Winrock data to estimate that 4% on average of that hectare will come from forest, 18% of that hectare will come from grassland, 74% of that land will come from Savanna, and 4% will come from shrubland.

Table 2.6-27.
MODIS Types of Land Converted to Cropland by Country

COUNTRY	Forest	Grassland	Savanna	Shrub
Argentina	8%	40%	45%	8%
Brazil	4%	18%	74%	4%
China	17%	38%	23%	21%
EU	27%	16%	36%	21%
India	7%	7%	33%	53%
Indonesia	34%	5%	58%	4%
Malaysia	74%	3%	19%	3%
Nigeria	4%	56%	36%	4%
Philippines	49%	5%	44%	3%
South Africa	10%	22%	53%	15%

2.6.5.3.2.2.2 In Which States or Administrative Regions Does the Land Conversion Occur

We also used the MODIS data to estimate where the land conversions would occur within countries or regions. Table 2.6-24 shows where in Brazil cropland was added, and what type of land was cleared in each state. This is important information because an acre of forest in the State of Amazonas, for example, sequesters substantially more carbon than an acre of forest in Sao Paulo. As you can see in Table 2.6-28, recent forest to cropland conversion has been far more common in Sao Paulo than Amazonas. Therefore, an estimate of land use change emissions in Brazil that does not weight forest to cropland conversion by the States where it would likely occur would tend to overestimate emissions per acre of crop expansion.

Table 2.6-28.
MODIS Land Conversion to Cropland in Brazil by Land Type and State, 2001 to 2004
(percent of land conversion type by state)

	Start Category	Forest	Grassland	Savanna	Shrub
	End Category	Crop	Crop	Crop	Crop
Country	State				
Brazil	Acre	0.0%	0.0%	0.0%	0.0%
	Alagoas	2.0%	2.3%	0.8%	1.1%
	Amapa	0.6%	0.0%	0.0%	0.1%
	Amazonas	0.1%	0.0%	0.0%	0.0%
	Bahia	3.5%	13.4%	7.6%	24.9%
	Ceara	0.2%	0.4%	0.3%	1.5%
	Distrito Federal	0.0%	0.2%	0.2%	0.2%
	Espirito Santo	0.7%	1.3%	1.2%	0.4%
	Goias	4.1%	7.5%	11.5%	6.6%
	Maranhao	1.1%	0.9%	0.6%	1.4%
	Mato Grosso	3.2%	12.0%	8.9%	10.2%
	Mato Grosso Do Sul	11.5%	11.6%	9.0%	3.6%
	Minas Gerais	4.1%	7.6%	15.7%	10.5%
	Para	1.6%	0.2%	0.2%	0.1%
	Paraiba	0.3%	2.3%	0.9%	3.9%
	Parana	31.2%	10.5%	8.4%	5.7%
	Pernambuco	1.5%	3.6%	1.6%	5.2%
	Piaui	0.1%	0.3%	0.3%	1.4%
	Rio De Janeiro	0.2%	0.8%	2.8%	2.6%
	Rio Grande Do Norte	0.1%	1.5%	0.6%	2.5%
	Rio Grande Do Sul	15.4%	6.9%	6.7%	2.7%
	Rondonia	0.0%	0.0%	0.0%	0.0%
	Roraima	0.1%	0.3%	0.1%	1.0%
	Santa Catarina	2.9%	0.7%	0.5%	0.9%
	Sao Paulo	14.5%	13.4%	21.0%	11.6%
	Sergipe	0.8%	1.7%	0.4%	1.1%
Tocantins	0.2%	0.5%	0.6%	0.7%	
All Brazil		100.0%	100.0%	100.0%	100.0%

We used the data summarized in Tables 2.6-27 and 2.6-28 to estimate where and what types of land in Brazil would be cleared per hectare of cropland expansion. This calculation can be summarized with the following formula:

Land clearing per acre crop expansion by land-type and State = $CE_L * CE_{LS}$, where:
 CE_L = share of crop expansion from land-type L ;
 CE_{LS} = share of crop expansion from land-type L in State S ;
 L = forest, shrubland, savanna, or grassland
 S = one of the 26 Brazilian States

Using this calculation we estimated the land use changes per hectare of cropland expansion in Brazil shown in Table 2.6-29. For example, in Brazil 4% of crop expansion occurs on shrubland and 25% of shrub to crop conversion occurred in the state of Bahia. Therefore, for each hectare of crop expansion in Brazil, we projected that approximately 0.01 hectares of shrub would be converted to cropland in Bahia. We repeated this calculation for all land types and for each of the ten countries that we had MODIS data for.

Table 2.6-29.
Projected Crop Expansion in Brazil by Land Type and State
(acres of conversion per acre of crop expansion)

	Start Category	Forest	Grassland	Savanna	Shrub
	End Category	Crop	Crop	Crop	Crop
Country	State				
Brazil	Acre	0.00	0.00	0.00	0.00
	Alagoas	0.00	0.00	0.01	0.00
	Amapa	0.00	0.00	0.00	0.00
	Amazonas	0.00	0.00	0.00	0.00
	Bahia	0.00	0.02	0.06	0.01
	Ceara	0.00	0.00	0.00	0.00
	Distrito Federal	0.00	0.00	0.00	0.00
	Espirito Santo	0.00	0.00	0.01	0.00
	Goiias	0.00	0.01	0.08	0.00
	Maranhao	0.00	0.00	0.00	0.00
	Mato Grosso	0.00	0.02	0.07	0.00
	Mato Grosso Do Sul	0.00	0.02	0.07	0.00
	Minas Gerais	0.00	0.01	0.12	0.00
	Para	0.00	0.00	0.00	0.00
	Paraiba	0.00	0.00	0.01	0.00
	Parana	0.01	0.02	0.06	0.00
	Pernambuco	0.00	0.01	0.01	0.00
	Piaui	0.00	0.00	0.00	0.00
	Rio De Janeiro	0.00	0.00	0.02	0.00
	Rio Grande Do Norte	0.00	0.00	0.00	0.00
	Rio Grande Do Sul	0.01	0.01	0.05	0.00
	Rondonia	0.00	0.00	0.00	0.00
	Roraima	0.00	0.00	0.00	0.00
	Santa Catarina	0.00	0.00	0.00	0.00
Sao Paulo	0.01	0.02	0.16	0.00	
Sergipe	0.00	0.00	0.00	0.00	
Tocantins	0.00	0.00	0.00	0.00	
All Brazil		0.04	0.18	0.74	0.04

2.6.3.2.2.3. Land Use Change Beyond Cropland Expansion

As described above, we used the FAPRI model to project how much cropland expansion would occur in each country, and MODIS satellite data provided by Winrock to estimate where and what types of land would be cleared within each country or region to make room for new cropland. Table 2.6-27 shows that in many countries cropland has been added in areas that were previously categorized as grassland or savanna. In consultation with Winrock we determined that lands categorized as grassland or savanna, according to IGPB the classification scheme, could be used as pasture for livestock grazing. Therefore, if we used the land use change estimates in Table 2.6-29 as our end point, we would project significant losses of actively managed pasture. However, it may be unreasonable to project pasture losses unless we also project comparable overall declines in livestock production and/or increases in pasture intensification. To resolve this issue and to estimate overall land use changes as accurately as possible, we added a certain amount of “pasture replacement” land use change to our total land use change estimates.

We assumed that actively managed pasture converted to cropland would have to be replaced with new pasture acreage, thereby capturing some of the domino effects associated with converting fertile land into crop production. We used land cover information from the GTAP database to estimate the proportion of grassland and savanna that is actively managed as pasture in each country (see Table 2.6-30). According to the GTAP database 64% of grassland and savanna in Brazil is actively managed for livestock grazing. We applied this data to our land use change estimates, which implies that, on average, 64% of the grassland and savanna converted to crop production in Brazil would previously have been used for livestock grazing. Therefore, since recent trends indicate that 92% of Brazilian crop expansion would occur on grasslands or savanna (see Table 2.6-27), we projected that approximately 59% of crop expansion would occur on land previously used as pasture.

Table 2.6-30.
Grassland and Savanna Actively Managed for Livestock Grazing by Region, 2000-2001

COUNTRY	Unmanaged Savanna and Grassland (hectares)	Managed Pasture (hectares)	Percent of Savanna and Grassland Managed for Pasture
Argentina	77,716,560	96,452,176	55.4%
Brazil	101,991,992	181,046,752	64.0%
China	42,534,708	286,370,272	87.1%
European Union	14,529,446	64,005,559	81.5%
India	12,806,170	11,798,180	48.0%
Indonesia	7,704,545	2,462,572	24.2%
Malaysia	0	292,900	100.0%
Nigeria	24716916	18762928	43.2%
Phillipines	0	131,755	100.0%
South Africa	19132926	77293112	80.2%

SOURCE: GTAP Land Cover Data (2000-2001)

Figure 2.6-18 is a graphical representation of our Brazil pasture replacement estimates. In order to replace pasture displaced by crop expansion, we assumed that forest and shrubland would be cleared to make room for new pasture areas. We used the MODIS satellite data to estimate the shares of forest and shrubland that would then be cleared and converted to pasture to

replace the pasture converted to crops. We used the state-by-state distribution of each of these conversions to estimate where in Brazil the pasture replacement would occur. For example, we used the MODIS data's state-by-state breakdown of where forest was converted to savanna in Brazil to estimate where forest would likely be converted to savanna to replace some of the lost pasture. The per hectare emissions factors shown in Figure 2.6-18 are non-discounted emissions over 80 years for each type of land conversion. Notice that in Brazil, average GHG emissions are greater for projected forest to grassland conversion than projected forest to cropland projection, because recent trends suggest that forest to grassland conversion tends to occur in regions with very carbon-rich forests. These emissions factors are discussed in detail below.

Figure 2.6-18.
Brazil Land Use Change Flow Chart with Cropland Expansion and
Managed Pasture Replacement

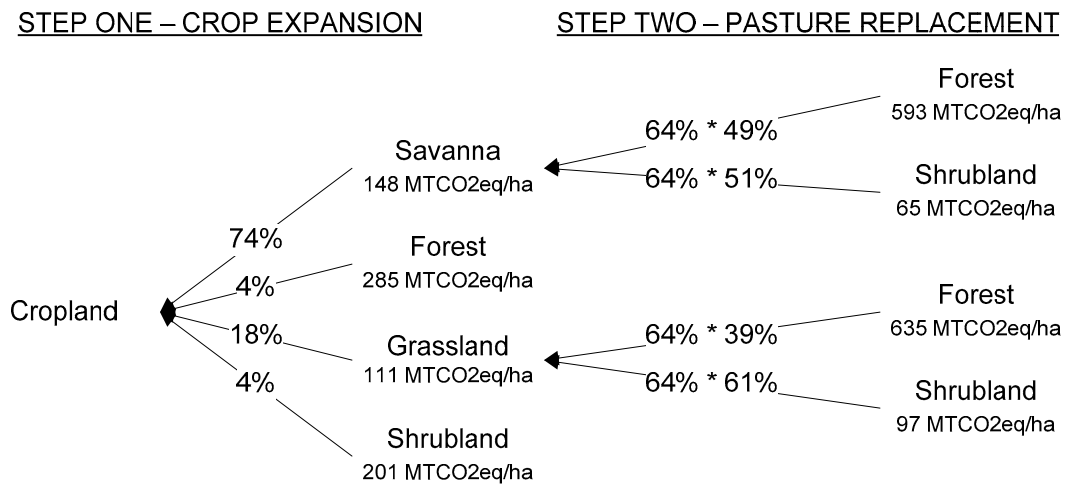

Table 2.6-31 provides a complete summary of projected land use change in Brazil per hectare of crop expansion. Notice that the land use changes under step one (cropland expansion) are exactly the same as in Table 2.6-29. The difference is that the complete summary of land use change in Brazil includes the pasture replacement step. We used the same methodology to calculate land use changes for all ten countries for which MODIS satellite data was provided.

**Table 2.6-31.
Summary of Brazil Land Use Change with Managed Pasture Replacement
(acres of land conversion per acre of crop expansion)**

		Step One: Crop Expansion				Step Two: Pasture Replacement			
						Replace Grassland		Replace Savanna	
	Start Category	Forest	Grassland	Savanna	Shrub	Forest	Shrub	Forest	Shrub
	End Category	Crop	Crop	Crop	Crop	Grassland	Grassland	Savanna	Savanna
Country	State								
Brazil	Acre	0.00	0.00	0.00	0.00	0.00	0.00	0.00	0.00
	Alagoas	0.00	0.00	0.01	0.00	0.00	0.00	0.00	0.00
	Amapa	0.00	0.00	0.00	0.00	0.00	0.00	0.00	0.00
	Amazonas	0.00	0.00	0.00	0.00	0.00	0.00	0.00	0.00
	Bahia	0.00	0.02	0.06	0.01	0.00	0.02	0.02	0.06
	Ceara	0.00	0.00	0.00	0.00	0.00	0.00	0.00	0.03
	Distrito Federal	0.00	0.00	0.00	0.00	0.00	0.00	0.00	0.00
	Espirito Santo	0.00	0.00	0.01	0.00	0.00	0.00	0.00	0.00
	Goiias	0.00	0.01	0.08	0.00	0.00	0.00	0.00	0.01
	Maranhao	0.00	0.00	0.00	0.00	0.00	0.00	0.02	0.01
	Mato Grosso	0.00	0.02	0.07	0.00	0.01	0.00	0.04	0.01
	Mato Grosso Do Sul	0.00	0.02	0.07	0.00	0.00	0.00	0.01	0.00
	Minas Gerais	0.00	0.01	0.12	0.00	0.00	0.01	0.01	0.02
	Para	0.00	0.00	0.00	0.00	0.00	0.00	0.03	0.00
	Paraiba	0.00	0.00	0.01	0.00	0.00	0.00	0.00	0.02
	Parana	0.01	0.02	0.06	0.00	0.00	0.00	0.02	0.00
	Pernambuco	0.00	0.01	0.01	0.00	0.00	0.01	0.00	0.02
	Piaui	0.00	0.00	0.00	0.00	0.00	0.00	0.01	0.01
	Rio De Janeiro	0.00	0.00	0.02	0.00	0.00	0.00	0.00	0.00
	Rio Grande Do Norte	0.00	0.00	0.00	0.00	0.00	0.01	0.00	0.02
	Rio Grande Do Sul	0.01	0.01	0.05	0.00	0.01	0.00	0.01	0.00
	Rondonia	0.00	0.00	0.00	0.00	0.00	0.00	0.01	0.00
	Roraima	0.00	0.00	0.00	0.00	0.00	0.00	0.00	0.01
Santa Catarina	0.00	0.00	0.00	0.00	0.00	0.00	0.01	0.00	
Sao Paulo	0.01	0.02	0.16	0.00	0.00	0.00	0.01	0.00	
Sergipe	0.00	0.00	0.00	0.00	0.00	0.00	0.00	0.00	
Tocantins	0.00	0.00	0.00	0.00	0.00	0.00	0.00	0.01	
All Brazil		0.04	0.18	0.74	0.04	0.05	0.07	0.23	0.24

EPA is reviewing parameters used to estimate pasture replacement, including further research and peer-review of these issues. For example, we plan to look at studies about whether it is more or less likely for pasture to be converted to crop production than grassland or savanna that is not already used for grazing. Grazing tends to occur near agricultural activity, suggesting that crop expansion would be more likely to occur on pasture. On the other hand, there is an extra opportunity cost associated with converting pasture to crop production, so farmers may prefer to expand crop production onto lands not already used for grazing. More detailed regional land use studies and economic modeling will help to answer these questions.

Intensification of grazing lands also has the potential to change the impacts of crop expansion, and to reduce the overall land use footprint of agriculture. For example, in Brazil cattle per hectare increased by 10% from 2001-2005, and one estimate suggests almost 50 million acres of pastureland could become available due to more efficient use of land for cattle. This could reduce economic pressures to expand livestock grazing into unused lands, such as forests. We also plan more research to distinguish between grazing intensification that would occur regardless of biofuel production, and intensification induced by biofuel production.

The amount of lost pasture that would be replaced and the types of land that would be cleared to replace it are also important. Based on recent land use trends, we assumed that forest and shrubland would be cleared to replace lost pasture. We did not, therefore, include the possibility that grassland and savanna that is not currently used for pasture could be put into grazing activities. Section 2.8 includes sensitivity analysis of the pasture replacement assumptions used in our analysis, which indicates that this is an important factor in land use change projections for lifecycle GHG analysis.

To calculate the total area of land use changes in Brazil, we simply took the product of the total area of crop expansion projected by FAPRI and the land use changes per hectare summarized in Table 2.6-31. For an increase in U.S. corn ethanol consumption from 12.4 to 15 billion gallons in 2022 (i.e. the difference between our Corn Only and Control Case), FAPRI projected 747,000 hectares of crop expansion in Brazil. A summary of total 2022 Brazil land use changes associated with this corn ethanol scenario is provided in Table 2.6-32. Land use change summaries for all ten countries are available in spreadsheets on the public docket for this proposed rulemaking.

Table 2.6-32.
Projected Brazil Land Use Changes in Corn Ethanol Only Scenario, 2022
(acres)

		Step One: Crop Expansion				Step Two: Pasture Replacement			
		Forest	Grassland	Savanna	Shrub	Replace Grassland	Shrub	Replace Savanna	Shrub
	Start Category	Crop	Crop	Crop	Crop	Grassland	Grassland	Savanna	Savanna
Country	State								
Brazil	Acre	0	8	39	0	74	4	2,407	5
	Alagoas	630	3,156	4,399	316	220	258	717	891
	Amapa	174	39	205	32	696	389	2,069	317
	Amazonas	16	24	16	8	2,539	781	2,088	256
	Bahia	1,107	18,206	41,789	6,966	2,877	13,174	16,595	44,016
	Ceara	55	607	1,563	418	49	2,789	755	19,584
	Distrito Federal	0	266	1,108	64	12	96	35	314
	Espirito Santo	217	1,770	6,839	104	90	44	1,456	411
	Goiias	1,278	10,095	63,275	1,835	253	1,112	1,718	4,273
	Maranhao	338	1,230	3,548	397	737	1,163	18,568	4,969
	Mato Grosso	996	16,252	49,333	2,863	5,217	3,122	26,670	6,371
	Mato Grosso Do Sul	3,608	15,717	49,598	1,001	2,268	964	6,867	2,190
	Minas Gerais	1,296	10,269	86,582	2,926	1,514	3,990	7,921	14,424
	Para	505	284	1,182	32	2,597	1,211	24,164	928
	Paraiba	102	3,108	5,146	1,103	37	3,708	307	13,367
	Parana	9,786	14,225	46,476	1,598	1,648	253	12,628	1,463
	Pernambuco	486	4,834	8,689	1,444	237	4,204	1,763	18,257
	Piaui	39	391	1,880	402	149	1,802	4,810	10,111
	Rio De Janeiro	59	1,093	15,414	726	88	102	697	429
	Rio Grande Do Norte	31	2,091	3,205	698	12	4,137	57	16,006
	Rio Grande Do Sul	4,837	9,379	36,900	760	4,692	2,424	10,941	3,516
Rondonia	8	54	124	8	1,301	313	9,243	93	
Roraima	24	422	670	268	1,751	2,568	1,735	6,962	
Santa Catarina	898	896	2,819	251	1,742	235	7,967	1,326	
Sao Paulo	4,559	18,143	115,807	3,256	984	444	6,097	2,288	
Sergipe	251	2,271	2,399	315	257	278	473	360	
Tocantins	78	613	3,189	201	1,853	3,177	3,509	7,829	
All Brazil		31,375	135,441	552,194	27,990	33,895	52,740	172,259	180,954

It is important to note that our analysis for the proposed rule treats all acres of crop expansion the same in an individual country. This implies that an additional acre of corn in Brazil would result in the same land conversion as an additional acre of soybeans or sugarcane in Brazil. However, it is possible that different types of crop expansion would occur in different regions and thus have different impacts on land conversion. Current areas where corn and soybeans are grown in Brazil are largely in the same regions in the south, however, there are areas further north where production of soybeans occur as shown in Figures 2.6-19 and 2.6-20,

indicating that different types of crop production in Brazil would potentially have different impacts.

Figure 2.6-19. Corn Production in Brazil

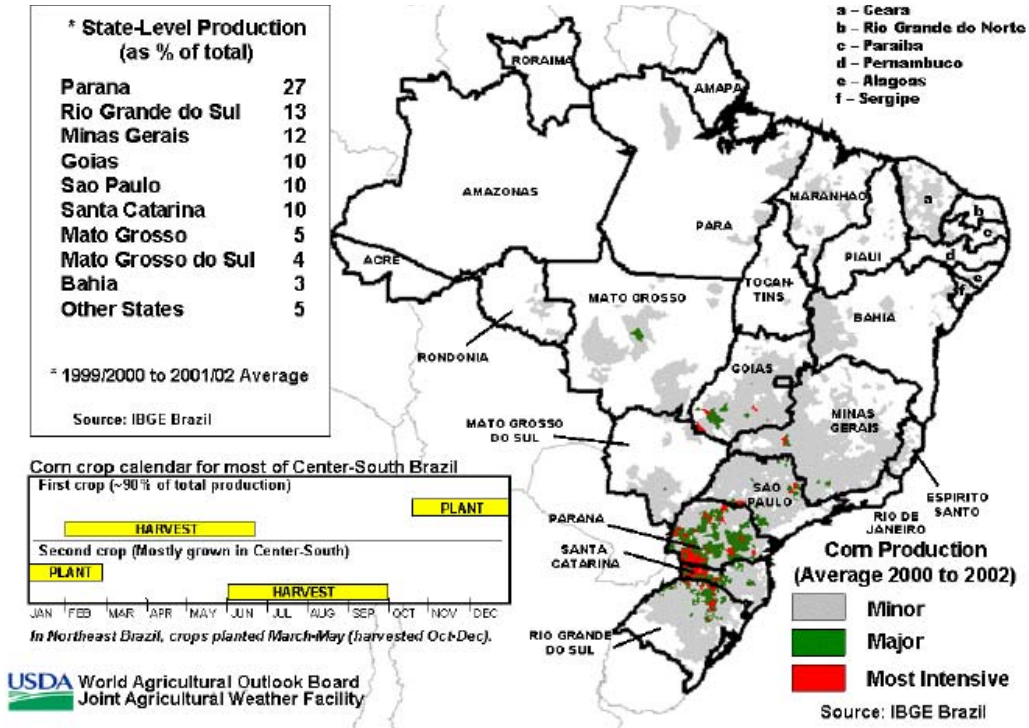
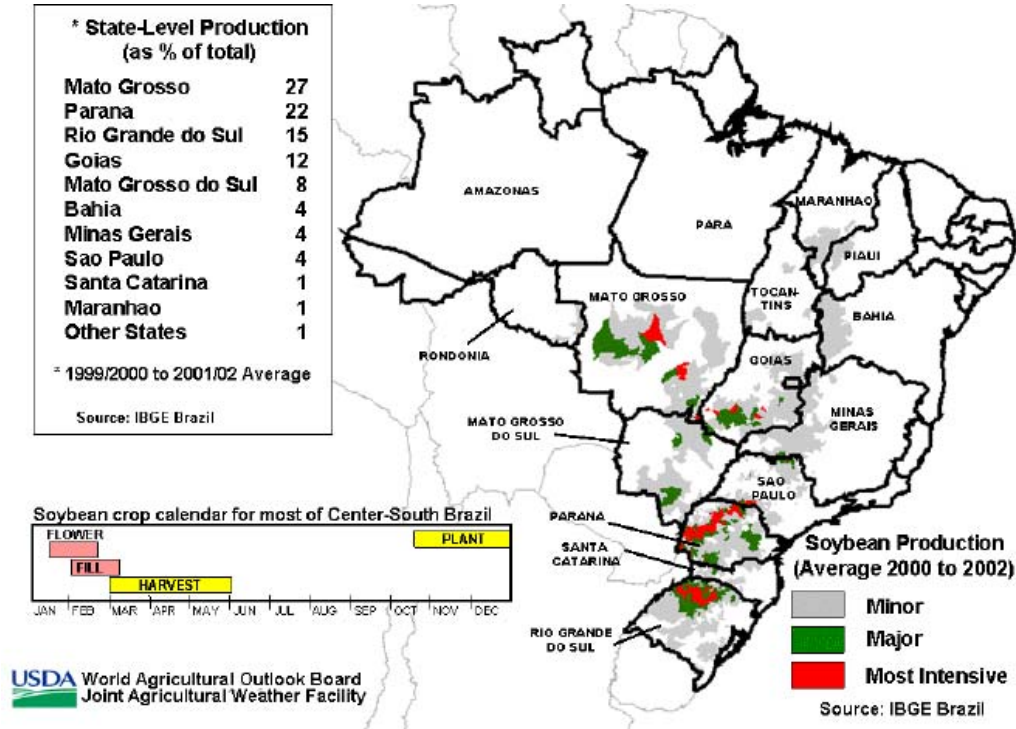

Figure 2.6-20. Soybean Production in Brazil



The impact of this assumption on overall results is somewhat mitigated by the fact that each fuel scenario in the U.S., e.g., corn ethanol and soybean biodiesel will result in a mix of crop export changes and a mix of crop expansion internationally. For example, increased corn ethanol production in the U.S. results in reduced exports of not just corn, but other crops as well, due to crop shifting in the U.S. agricultural sector. Also the MODIS satellite data is based on a mix of crop expansion in different countries such that it is already reflecting crop expansion in a mix of different crops. However, this is an area that will be examined for the final rule analysis.

2.6.5.3.3 GTAP Approach

GTAP is an economy-wide general equilibrium model that was originally developed for addressing agricultural trade issues among countries. The databases and versions of the model are widely used internationally by a large modeling community.⁵³⁵ Since its inception in 1993, GTAP has rapidly become a common "language" for many of those conducting global economic analysis. For example, the WTO and the World Bank co-sponsored two conferences on the so-called Millennium Round of Multilateral Trade talks in Geneva. Here, virtually all of the quantitative, global economic analyses were based on the GTAP framework. Over the past few years, a version of the model was developed to explicitly model global competition among different land types (e.g., forest, agricultural land, pasture) and different qualities of land based on the relative value of the alternative land-uses. More recently, it was modified to include biofuel substitutes for gasoline and diesel. In simulating land use changes due to biofuels production, GTAP explicitly models land-use conversion decisions, as well as land management intensification. For example, it allows for price-induced yield changes (e.g., farmers can

reallocate inputs to increase yields when commodity prices are high) and considers the marginal productivity of additional land (e.g., expansion of crop land onto lower quality land as a result of the increased use of biofuels). Most importantly, in contrast to other models, GTAP is designed with the framework of predicting the amount and types of land needed in a region to meet demands for both food and fuel production. The GTAP framework also allows predictions to be made about the types of land available in the region to meet the needed demands, since it explicitly represents different land types within the model.

The global modeling of land-use competition and land management decisions is relatively new, and evolving.⁵³⁶ GTAP is currently adding cellulosic biofuel feedstocks. In addition, GTAP does not currently contain unmanaged land, which could be a major factor driving current GTAP land use projections and is a significant potential source of GHG emissions. We will continue to consider using GTAP as it develops a more comprehensive treatment of biofuel pathways and land supply.

Our proposal is therefore based on the FAPRI/Winrock estimates. Additional refinements will be made to the GTAP model between the proposal and final rule and we plan to include information about important developments in the docket as it becomes available.

2.6.5.4 What Are the GHG Emissions Associated with Different Types of Land Conversion

2.6.5.4.1 Domestic Land Use Change Emissions

Domestic land use change GHG emissions are based on outputs of the FASOM model. As we are just using the agricultural portion of the FASOM model for this analysis the land use change GHG emissions are limited to changes in land use for existing crop and pasture land. Some of that crop land could currently be fallow and some of the pasture land could currently be unused. However, no new crop or pasture land (beyond some CRP land due to legislative changes in the program) are added compared to current levels. Thus FASOM only models shifts in the use of this land.

Changes in the agricultural sector due to increased crops used for biofuels have impacts on land use change in a number of ways. FASOM explicitly models change in soil carbon from increased crop production acres and from different types of crop production. FASOM also models changes in soil carbon from converting non-crop land into crop production. Land converted to crop land could include pasture land.

Land conversion GHG emissions in FASOM include above ground carbon and soil carbon changes from land conversion and crop pattern changes. The FASOM land conversion factors are based on factors for different crops, management practices, and land conversion effects, e.g., converting pasture to crop production. Therefore, FASOM soil carbon changes capture not only converting new land into crop but also changes from existing cropland due to changing management practices or cropping patterns. As part of the ongoing work with Colorado State University we are in the process of updating the soil and land conversion factors in FASOM based on new DAYCENT model runs. We plan to include these updates as part of the analysis for the final rule.

2.6.5.4.2 International Land Use Change Emissions

Land use change emissions factors were calculated by the non-profit organization Winrock International following 2006 IPCC AFOLU Guidelines. Winrock's staff is highly regarded for their years of experience and accomplishment in this field, including their work with the IPCC to develop the AFOLU Guidelines. For the proposed rule, emissions factors were estimated for ten countries including Argentina, Brazil, China, India, Indonesia, Malaysia, Mexico, Philippines, EU and South Africa. Emissions factors were based on the initial change in biomass stocks as well as changes in soil carbon stocks, non-CO₂ emissions from biomass burning due to land clearing, and forgone forest sequestration. In general, emission factors for all land use types were highest in the Southeast Asian countries of Malaysia, Indonesia and Philippines and lowest in Argentina and Nigeria. This section describes the methods used to estimate GHG emissions from international land use change.

2.6.5.4.2.1 Data sources used to estimate land use change GHG emissions factors

Forest Carbon Stocks: To calculate changes in biomass carbon stocks due to land use change, data were compiled at the state level to estimate carbon stocks of various land use types. Average forest carbon stocks per administrative unit in each country were extracted from spatial data layers developed for various regions of the world. Estimates represent both above- and belowground biomass. Data sources for each region are summarized below:

Argentina: A global map of forest carbon stocks developed by Gibbs et al. (2007) was used to estimate forest carbon stocks in Argentina.

Asia: A map developed by Gibbs and Brown (2007) was used to estimate forest carbon stocks in the year 2000 in the Asian countries of Indonesia, Malaysia and Philippines.

Mexico: A map developed by Harris and Brown (unpublished results) was used to estimate forest carbon stocks in Mexico. The map was developed using similar methods to the products developed for Asia and Africa by Gibbs and Brown (2007, 2008), where potential biomass maps were developed based on various climatic and biophysical factors and were then degraded based on population density for the year 2000 to estimate actual forest biomass. The biomass estimates were then expanded to account for roots based on factors given in Cairns et al. (1997) and then converted to carbon stocks (carbon = biomass*0.5).

South America: A map of aboveground forest biomass was obtained from Saatchi et al. (200x), an example of which is shown in Figure 2.6-21. The biomass estimates were first expanded to account for roots based on factors given in Cairns et al (1997) and then converted to carbon stocks (carbon = biomass*0.5).

Figure 2.6-21. Example of a Spatial Data Base for Forest Carbon Stocks

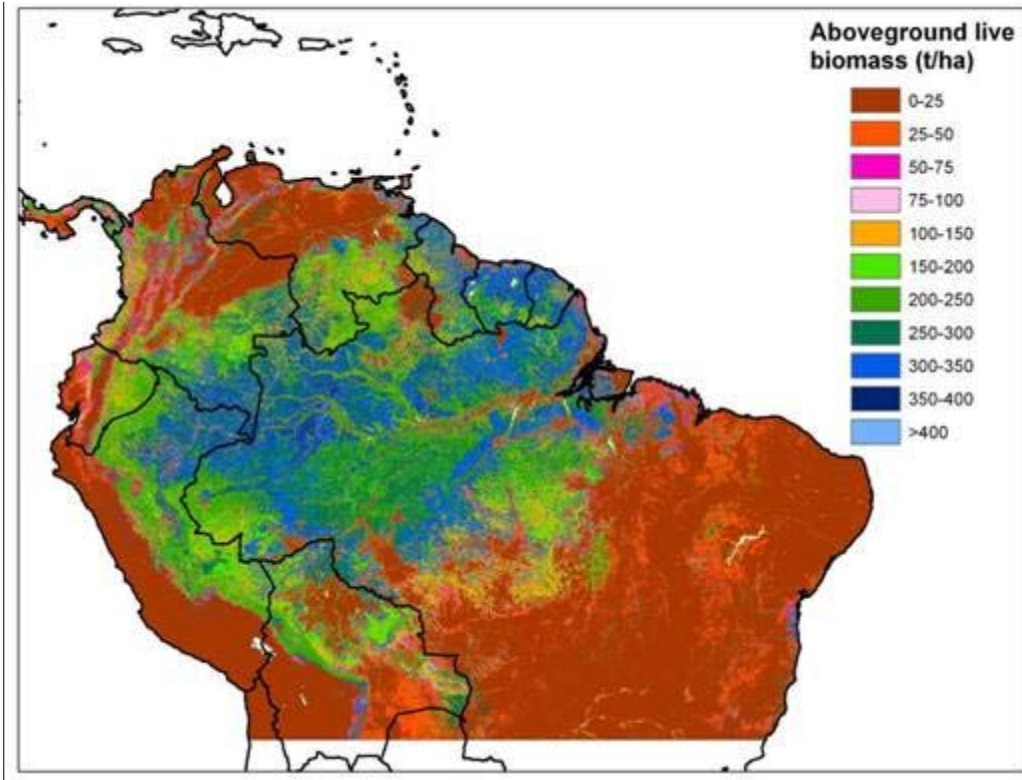

Soil Carbon Emissions: Soil carbon emissions associated with land use change in different regions around the world were estimated using global soil carbon maps. A digital soil carbon map of the world is available from the U.S. Department of Agriculture, Natural Resources Conservation Service, see Figure 2.6-22. This map is based on a reclassification of the FAO-UNESCO Soil Map of the World combined with a soil climate map. The map shows little variation for soil C in the tropics with most areas showing a range in soil carbon of 40-80 t C/ha (4-8 Kg C/m²). The soil organic carbon map shows the distribution of the soil organic carbon to 30 cm depth.⁵³⁷ This data layer was chosen because land use change (e.g., tilling for cropland conversion) typically affects only the upper layers of the soil profile.

Figure 2.6-22. Estimates of Soil Organic Carbon to 30cm Depth^a

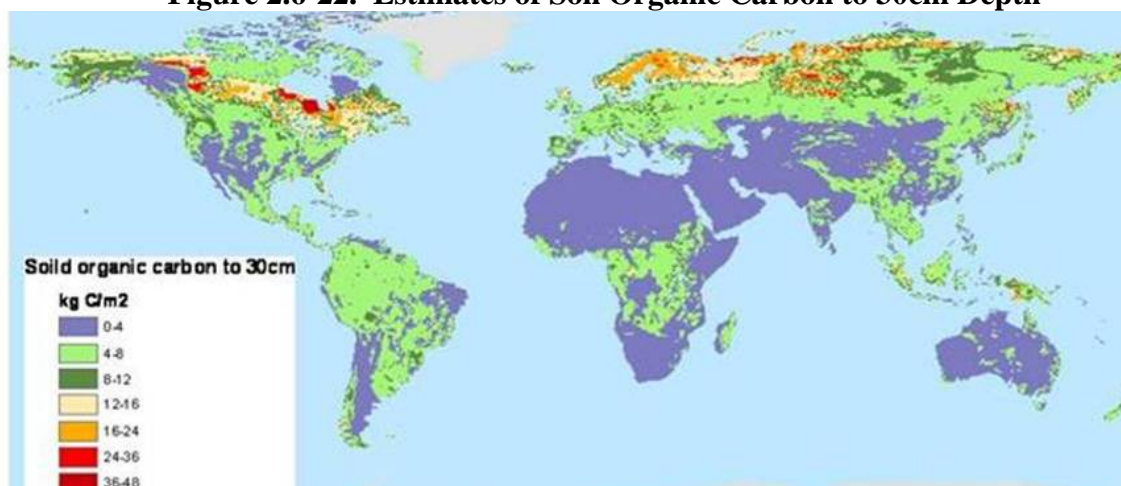

^a The GIS data product has higher resolution than indicated here in the map ($1 \text{ kg m}^{-2} = 10 \text{ t C ha}^{-1}$).

Cropland Carbon Stocks: Carbon stocks on annual cropland were estimated as 5 metric tons of carbon per hectare (MT C ha^{-1}), based on Table 5.9 of the IPCC AFOLU. In Malaysia, carbon stocks for oil palm and rubber were estimated using values from Table 5.3 of the IPCC AFOLU (68 and 89 MT C ha^{-1} , respectively).

Grassland, Savanna and Shrubland Carbon Stocks: Above- and belowground biomass values for grassland, savanna and shrublands were obtained from a variety of sources, see Table 10-11. Biomass estimates were obtained from de Castro and Kauffman (1998) for the Brazilian vegetation gradient that spans campo limpo (pure grassland), campo sujo (a savanna with a sparse presence of shrubs), campo cerrado (a dominance of shrubs with scattered trees and a grass understory), cerrado *sensu stricto* (a dominance of trees with scattered shrubs and a grass understory) and cerrado (a closed canopy forest) (Coutinho 1978, Eiten 1972, Goodland & Pollard 1973). Shrubland carbon stocks were estimated from the average of biomass values reported for cerrado aberto and cerrado denso. Savanna carbon stocks were estimated from the biomass value reported for campo sujo. Grassland carbon stocks were estimated from the biomass value reported for campo limpo.

Estimating carbon stocks in other countries for the grassland-savanna-shrubland continuum was slightly more problematic. For all countries except Brazil (explained in the paragraph above), grassland carbon stocks were estimated for each administrative unit as the default value given in Table 6.4 of the IPCC AFOLU, where values are given as a function of temperature and moisture regime.

Very few carbon stock estimates were available for savanna and shrubland outside of Brazil. Therefore, carbon stocks of these land cover types were estimated using a proportional approach based on the Brazil dataset, which indicates an increasing trend in carbon stocks from grassland \rightarrow savanna \rightarrow shrubland of 10.9 to 19.7 to $37.3 \text{ MT C ha}^{-1}$, respectively, translating into a ratio of 1 to 1.8 to 3.4 . These ratios were applied to other countries for estimating carbon stocks in savanna and shrubland based on the estimated carbon stocks of grassland within each country. One exception to the ratio approach was for the Southeast Asian countries of Indonesia, Malaysia and Philippines, where a shrubland biomass value of 85 MT ha^{-1} (42 MT C ha^{-1}) was

applied based on actual data reported in Grace et al. 2006 for a savanna woodland in Klong Hoi Khong, Thailand.

Table 2.6-33.
Estimated Carbon Stocks (MT C ha⁻¹) for Grassland, Savanna and Shrubland
in Each Country Analyzed^a

Country	Grassland	Savanna	Shrubland
Brazil	10.9	19.7	37.3
India	4.1 – 7.6	7.4 – 13.6	13.9 – 25.7
Malaysia	7.6	13.6	42.0
Indonesia	7.6	13.6	42.0
Philippines	7.6	13.6	42.0
China	7.6	13.6	25.7
Argentina	2.7 – 6.4	5.1 – 11.5	9.7 – 21.7
Mexico	4.1 - 7.6	7.4 – 13.6	13.9 – 25.7

^a ranges are reported for countries in which carbon stocks varied by state

2.6.5.4.2.2 Methods for Land Use Change GHG Emissions Factors Estimation

For each state in each country, emission factors were calculated for various land cover conversions using data tables and equations from the 2006 IPCC AFOLU Guidelines and from other global data sets. Emission factors account for changes in above- and belowground biomass carbon stocks, soil carbon stocks and lost forest sequestration. Non-CO₂ emissions were also accounted for, including methane (CH₄) and nitrous oxide (N₂O) emissions resulting from land clearing with fire and CH₄ emissions resulting from rice cultivation.

Changes in biomass carbon stocks: Initial changes in biomass carbon stocks on land converted to another land category (e.g., from forest to cropland) were calculated based on Equation 2.16 in the IPCC AFOLU:

$$\Delta C_{CONVERSION} = \sum_i (B_{AFTER_i} - B_{BEFORE_i}) \bullet CF$$

where:

$\Delta C_{CONVERSION}$ = initial change in biomass carbon stocks on land converted to another land category, tonnes C ha⁻¹ yr⁻¹

B_{AFTER_i} = biomass stocks on land type I immediately after the conversion, tonnes d.m. ha⁻¹

B_{BEFORE_i} = biomass stocks on land type I before the conversion, tonnes d.m. ha⁻¹

CF = carbon fraction of dry matter, tonne C (tonnes d.m.)⁻¹

i = type of land use converted to another land-use category

Initial changes in biomass carbon stocks reflect gross emissions rather than net emissions; harvested wood products, including long-term storage and retirement, were not considered in the analysis. Based on consultation with Winrock we determined that including IPCC default GHG credits for harvested wood products (HWPs) would have an insignificant impact on our estimates of land use change emissions, as there is limited evidence that trees cleared from converted forestland is converted to durable wood products. The 2006 IPCC Guidelines for National Greenhouse Gas Inventories also states that (p 12.8) the HWP contribution can be reported as zero if the annual change in carbon in HWP stocks is judged insignificant. Even if we assumed that forestland cleared from Brazil had 10m³ of timber/ha, which is likely an upper bound for many of the forests being cleared, this would translate to about 8tCO₂/ha, or less than 2% of the total emissions from converting forest to cropland. However, we intend to analyze the impact of wood product credits for the final rule.

Winrock provided emissions factors for land conversion to perennial crops, but only emissions factors for conversion to annual crops were used for the proposed rule analysis. We intend to differentiate between annual and perennial cropland expansion for the final rule.

Changes in soil carbon stocks: Changes in soil carbon stocks on land converted to cropland were calculated based on Section 5.3.3.4 of the IPCC AFOLU.

Soil carbon stocks after conversion to cropland were based on specific soil stock change factors for land use, management and inputs (F_{LU} , F_{MG} , F_i , respectively) listed in Table 5.10 of the IPCC AFOLU. (Relevant factors are listed in Table 2.6-34 of this report). Stock change factors were selected for each land cover type (before and after conversion) and multiplied by reference soil carbon stocks. Following the IPCC AFOLU guidelines, the total difference in carbon stocks before and after conversion was averaged over 20 years. Thus the average annual change in soil carbon stocks due to land use conversion were calculated as:

$$\Delta SOC = \frac{(SOC_{Ref} \cdot F_{LU, before} \cdot F_{MG, before} \cdot F_{I, before}) - (SOC_{Ref} \cdot F_{LU, after} \cdot F_{MG, after} \cdot F_{I, after})}{20}$$

where:

- ΔSOC = average annual change in carbon stocks in top 30 cm of soil; t C ha⁻¹ yr⁻¹
 SOC_{Ref} = reference carbon stocks in top 30 cm of soil; t C ha⁻¹
 F_{LU} = land use factor before or after conversion
 F_{MG} = management factor before or after conversion
 F_I = input factor before or after conversion

As default values for stock change factors (F_{LU} , F_{MG} , F_I) are all one for forest soils and non-degraded grassland soils, soil carbon stocks were assumed to remain unchanged for all conversion types (conversion to shrubland, savanna, perennial cropland) except conversion to cropland. Full tillage and medium inputs were assumed in all scenarios of cropland conversion. Consistent with IPCC default guidelines, soil carbon stock changes were spread equally over 20 years.

Table 2.6-34.
Relative Stock Change Factors (F_{LU} , F_{MG} , F_I) for Different Management Activities Based on Tables 5.5 and 5.10 in 2006 IPCC AFOLU

Factor value type	Level	Temperature Regime	Moisture Regime	IPCC default
Land use (F_{LU})	Native forest or grassland (non-degraded)	All	All	1
Land use (F_{LU})	Long-term cultivated	Temperate/Boreal	Dry	0.8
			Moist	0.69
		Tropical	Dry	0.58
			Moist/Wet	0.48
	Tropical montane	n/a	0.64	
Land use (F_{LU})	Paddy rice	All	All	1.1
Land use (F_{LU})	Perennial/tree crop	All	All	1
Tillage (F_{MG})	Full	All	All	1
Input (F_I)	Medium	All	All	1

Peat soil drainage: Winrock provided emissions factors for peat drainage for countries where that is likely to occur, such as Indonesia, and Malaysia. However, emissions from peat soil were not included in our analysis for the proposed rule. Below is a description of the

methodology Winrock used to provide factors for peat drainage, which we intend to use for the final rule.

For countries containing peat (organic) soils, emission factors were chosen that accounted for annual losses of CO₂ due to peat drainage. Emission factors were based on a regional dataset from Southeast Asia that correlates peat drainage depth with annual peat CO₂ emissions. Emission factors were estimated using this regional dataset rather than basing them on climate type (Table 5.6 of the IPCC AFOLU) because all countries included in the analysis that contained peat soils were located in Southeast Asia. Thus the use of regional data was appropriate. The emission factor for drained organic soils was estimated based on the following equation (from Hooijer et al. 2006):

$$Y = 0.91X$$

where:

$$Y = \text{CO}_2 \text{ emissions from drained peat, MT CO}_2 \text{ ha}^{-1} \text{ yr}^{-1}$$

$$X = \text{drainage depth, cm}$$

Drainage depth was assumed as 80 centimeters, which is the minimum likely peat drainage estimate for conversion to croplands cited in Hooijer et al. (2006). Thus the annual emission factor from drained peat soils was estimated as $80 \times 0.91 = 72.8 \text{ MT CO}_2 \text{ ha}^{-1} \text{ yr}^{-1}$.

Emission factors for draining peat soils were estimated for land use conversions originating from forest and grassland only, based on the assumption that in Southeast Asia, the only land cover types on peat are intact or degraded peat swamp forest or already drained and deforested peatland that has revegetated to *Imperata* grasslands.

Lost forest sequestration: Over time, trees sequester carbon dioxide from the atmosphere and accumulate carbon as biomass. When forests are converted to another land use, the trees that would have continued to grow are cut down and no longer act as carbon sinks. Therefore, each year after a land use conversion has occurred the carbon that would have been sequestered in the growing trees is “lost”. In an avoided emissions scenario, carbon benefits can be generated not only from preventing the immediate loss of biomass carbon stocks, but also from allowing carbon to accumulate over time in the vegetation that would have been cleared.

Average annual biomass accumulation rates are given in Table 4.9 of the 2006 GL AFOLU and are specified according to ecological zone and continent. These values were used to estimate the lost biomass accumulation of forests that were converted to another land use (Table 2.6-36). Average values were used where a range of values is listed. Lost carbon accumulation was then assumed equal to the biomass accumulation value multiplied by the carbon fraction in dry matter (IPCC default = 0.47).

The area of forest in each state was stratified by FAO ecozone and continent, and appropriate values from Table 2.6-30 were applied to calculate an average area-weighted value. As biomass accumulation rates in Table 4.9 of the 2006 GL AFOLU are separated into rates for forests less than and greater than a 20 year threshold, in this analysis all forests that were being converted were assumed to be >20 years in age. The average annual foregone sequestration is calculated as:

$$\Delta C_{lostseq} = \sum_i (Cseq_{LUbefore,i} - Cseq_{LUafter,i})$$

where:

$\Delta C_{lostseq}$ = change in carbon sequestration in aboveground biomass; MT C ha⁻¹ yr⁻¹

$Cseq_{LUbefore,i}$ = annual sequestration in aboveground biomass before conversion; MT C ha⁻¹ yr⁻¹

$Cseq_{LUafter,i}$ = annual sequestration in aboveground biomass after conversion MT C ha⁻¹ yr⁻¹

i = type of land use converted to another land use category.

Studies have estimated that new forests grow for 90 years to over 120 years.^{UUUUUUU} More recent estimates suggest that old growth forests accumulate carbon for up to 800 years.^{VVVVVVV} For this analysis we assumed that foregone sequestration would continue for 80 years, which is within the range supported by the scientific literature and the 2006 IPCC guidelines. Section 2.8 presents a sensitivity analysis of the length of foregone sequestration assumed.

^{UUUUUUU} See Greenhouse Gas Mitigation Potential in U.S. Forestry and Agriculture, EPA Document 430-R-05-006 for a discussion of the time required for forests to reach carbon saturation.

^{VVVVVVV} Luyassert, S et al., 2008. Old-growth forests as global carbon sinks. *Nature* 455: 213-215.
Link: <http://www.nature.com/nature/journal/v455/n7210/abs/nature07276.html>

**Table 2.6-35.
Aboveground Net Biomass Growth in Natural Forests
From Table 4.9 in IPCC AFOLU**

Domain	Ecological Zone	Continent	Aboveground biomass growth (tonnes d.m. ha-1 yr-1)
Tropical	Tropical rain forest	Africa	3.1
		South America	3.1
		Asia (continental)	2.2
		Asia (insular)	3.4
	Tropical moist deciduous forest	Africa	1.3
		South America	2.0
		Asia (continental)	2.0
	Tropical dry forest	Asia (insular)	3.0
		Africa	1.8
		South America	1.0
		Asia (continental)	1.5
	Tropical shrubland	Asia (insular)	2.0
		Africa	0.9
		South America	1.0
		Asia (continental)	1.3
	Tropical mountain systems	Asia (insular)	1.0
Africa		1.0 - 1.5	
South America		0.4 - 1.4	
Asia (continental)		0.5 - 1.0	
Sub-tropical	Subtropical humid forest	Asia (insular)	1.0 - 3.0
		Asia (continental)	2.0
		North and South America	2.0
	Subtropical dry forest	Asia (insular)	3.0
		Asia (continental)	2.0
		Asia (insular)	1.5
	Subtropical steppe	Asia (insular)	2.0
		Asia (continental)	1.3
		Africa	0.9
	Subtropical mountain systems	Asia (insular)	1.0
		North and South America	1.0
		Africa	0.2 - 1.6
Temperate	Temperate continental forest	Asia (continental)	0.4 - 1.4
		North and South America	0.5 - 7.5
	Temperate mountain systems	Asia, Europe, North America	0.5 - 6.0
Boreal	Boreal coniferous forest	Asia, Europe, North America	0.1 - 2.1
	Boreal tundra woodland	Asia, Europe, North America	0.4
Boreal	Boreal mountain systems	Asia, Europe, North America	1.0 - 2.2
		Asia, Europe, North America	1.0 - 1.1

Non-CO₂ emissions from land clearing: In countries where fire is used commonly as a land clearing practice for conversion to agriculture, non-CO₂ emissions were estimated using

emission factors in Table 2.5 and Equation 2.27 of the IPCC AFOLU. Fire for land clearing was assumed to occur in all countries included in the analysis except China and Argentina.

Non-CO₂ emissions from land clearing with fire were estimated as:

$$L_{fire} = A \cdot M_B \cdot C_f \cdot G_{ef} \cdot 10^{-3}$$

Where:

L_{fire} = amount of greenhouse gas emissions from fire, MT of each GHG (i.e., CH₄, N₂O)

A = area burnt, ha

M_B = mass of fuel available for combustion, MT ha⁻¹.

C_f = combustion factor, dimensionless

G_{ef} = emission factor, g kg⁻¹ dry matter burnt

The mass of fuel available for combustion was conservatively assumed to be equal to the above- and belowground biomass only; dead wood and litter pools were not included in the fuel load estimates.

IPCC defaults were used for the forest combustion factor. Values from de Castro and Kaufmann (1998) were used for clearing other land cover types (grassland, savanna, shrubland). Combustion factors and emission factors used in this analysis are summarized in Table 2.6-36 and 2.6-37 respectively.

Table 2.6-36.
Combustion Factor Values (Proportion of Pre-Fire Fuel Biomass Consumed)
for Fires in a Range of Vegetation Types

Vegetation Type	Subcategory	Value
Primary tropical forest (slash and burn)	Primary tropical forest	0.32
	Primary open tropical forest	0.45
	Primary tropical moist forest	0.5
	Primary tropical dry forest	-
All primary tropical forests		0.36
Shrubland		0.43
Savanna		0.84
Grassland		0.92

Table 2.6-37.
Emission Factors (g kg⁻¹ Dry Matter Burnt) Used in This Analysis
for Biomass Burning From Table 2.5 of IPCC AFOLU

Category	CO ₂	N ₂ O
Savanna and grassland	1613	0.21
Tropical forest	1580	0.2
Extra tropical forest	1569	0.26

2.6.5.4.2.3 Integrated Emissions Factors for Land Use Change

In summary, emissions factors were estimated for each state for each land use conversion as metric tonnes CO₂ equivalent. All non-CO₂ estimates were converted using IPCC SAR GWP factors:

$$EF_{LUC} = \Delta C_{biomass,LUC} + \Delta C_{soil,LUC} + \Delta C_{lost_seq,LUC} + E_{fire,LUC} + E_{rice,LUC}$$

where:

- EF_i = emission factor for converting one hectare of land to land use *LUC*;
- $\Delta C_{biomass,LUC}$ = change in biomass carbon stocks as a result of land use change *LUC*;
- $\Delta C_{soil,LUC}$ = change in soil carbon stocks (top 30 cm) as a result of land use change *LUC*;
- $\Delta C_{lost_seq,LUC}$ = lost forest sequestration resulting from land use change (if applicable);
- $E_{fire,LUC}$ = non-CO₂ GHG emission associated with land clearing with fire (if applicable);

The per hectare emissions factors used for the proposed rule are presented in Table 2.6-34. The emissions factors in Table 2.6-38 are weighted by where land conversions are likely to take place within each country, based on the MODIS satellite data discussed above. For example, the forest to cropland emissions factor for Brazil is weighted by where forest was converted to cropland in Brazil from 2001 to 2004. The MODIS satellite data suggests that in Brazil forest to grassland conversion tends to occur in regions with more carbon-rich forests than the areas that have more forest to cropland conversion. This explains why, for example, the Brazil per hectare emissions factor for forest to grassland conversion is greater than the factor for forest to cropland conversion. The emissions factors in Table 2.6-34 are undiscounted emissions over 80 years.

As depicted in Figure 2.6-14 for Brazil, the per hectare emissions factors in Table 2.6-38 were weighted by the shares of land types converted to cropland, and by the types of land cleared to replace pasture converted to cropland. With the weighting approach discussed above, we derived land use change emissions factors per hectare of cropland expansion. Table 2.6-39 includes the country-level weighted average emissions factors (WAEFs) per hectare of cropland expansion that were used for the proposed rule central estimate. The WAEFs in Table 2.6-39 are undiscounted emissions over 80 years.

**Table 2.6-38.
Regional Land Conversion GHG Emissions Factors
Undiscounted Emissions Over 80 Years
(MTCO₂-eq. / acre)**

Country / Region	To	From			
		Forest	Grassland	Savanna	Shrub
Argentina	Crop	115	16	17	33
	Grassland	136			15
	Savanna	129			9
Brazil	Crop	258	45	60	82
	Grassland	257			39
	Savanna	240			26
China	Crop	237	23	34	49
	Grassland	186			27
	Savanna	240			27
European Union	Crop	318	28	38	47
	Grassland	216			22
	Savanna	181			14
India	Crop	247	26	26	38
	Grassland	249			249
	Savanna	236			12
Indonesia	Crop	432	43	51	94
	Grassland	455			51
	Savanna	415			42
Malaysia	Crop	473	50	57	103
	Grassland	457			51
	Savanna	438			42
Nigeria	Crop	96	18	23	78
	Grassland	92			58
	Savanna	112			28
Philippines	Crop	402	34	44	88
	Grassland	371			51
	Savanna	359			42
South Africa	Crop	111	18	36	79
	Grassland	109			58
	Savanna	86			47

Table 2.6-39.
Regional Weighted Average Emissions Factors (WAEF)
(MTCO₂-eq. per acre of crop expansion)

Country / Region	Crop Expansion	Pasture Replacement	Total WAEF
Argentina	25	34	60
Brazil	66	76	142
China	68	45	113
European Union	106	41	147
India	48	33	81
Indonesia	182	60	242
Malaysia	367	93	461
Nigeria	25	31	56
Philippines	219	170	389
South Africa	47	32	79

2.6.5.4.2.3.4 What Are the Total GHG Emissions Associated With International Land Use Change

To determine the GHG impacts of the land use changes we applied GHG emissions factors based on data prepared by Winrock to the land use changes projected by the combination of FAPRI and satellite data. Table 2.6-39 shows our emissions factors for ten countries. The ten countries we have emissions factors for account for a majority of foreign cropland expansion projected by FAPRI. Table 2.6-40 shows the share of projected cropland expansion in these ten countries in the FAPRI fuel-specific scenarios. We are in the process of acquiring data for more countries to be used for the final rule.

Table 2.6-40.
Share of Projected Foreign Crop Expansion Covered by
Proposed Rule Winrock/MODIS Data

Fuel-Specific Scenario	Share of 2022 Crop Expansion Covered
Corn Ethanol	63%
Soy-Based Biodiesel	87%
Imported Sugarcane Ethanol	53%
Switchgrass Ethanol	57%

Note: Winrock/MODIS data covers Argentina, Brazil, China, EU, India, Indonesia, Malaysia, Nigeria, Philippines and South Africa

We used a weighted average emissions factor (WAEF) from the ten countries we have Winrock data for to estimate the GHG emissions from cropland expansion in countries not covered by Winrock data. The country-level shares of crop expansion varied by fuel-specific scenario, so the WAEF applied to missing countries also varied by scenario. Table 2.6-41 shows the WAEF used for missing countries for each scenario. The WAEF for missing countries is highest for the soy biodiesel scenario because FAPRI projects that U.S. soy biodiesel consumption encourages crop expansion in tropical countries with very large emissions factors for crop expansion, such as Malaysia and Philippines. Crop expansion in these South East Asian

oil palm exporting countries is large in the soy biodiesel scenario, because oil palm is a substitute for soy oil.

Table 2.6-41.
Weighted Average Emissions Factors (WAEFs) Applied to Countries without Winrock/MODIS Data

	Regions Covered by Winrock/MODIS	Fuel-Specific Scenario			
		Corn Ethanol	Soy-Based Biodiesel	Sugarcane Ethanol	Switchgrass Ethanol
Share of crop expansion by region	Argentina	4%	2%	13%	7%
	Brazil	27%	64%	33%	17%
	China	10%	2%	7%	13%
	E.U.	6%	1%	-3%	5%
	India	24%	5%	24%	31%
	Indonesia	5%	1%	6%	3%
	Malaysia	0%	0%	6%	0%
	Nigeria	20%	27%	12%	21%
	Philippines	3%	0%	2%	2%
	South Africa	3%	-1%	1%	1%
	WAEF applied to missing regions (MTCO ₂ -eq. / acre crop expansion)	114	117	132	104

Figure 2.6-23 shows results for 2022 total undiscounted land use change GHG emissions over 80 years per million Btu of renewable fuel.

Figure 2.6-23. Total Land Use Change GHG Emissions by Scenario
Undiscounted GHG Emissions Over 80 Years
(MTCO₂-eq. / mmBtu)

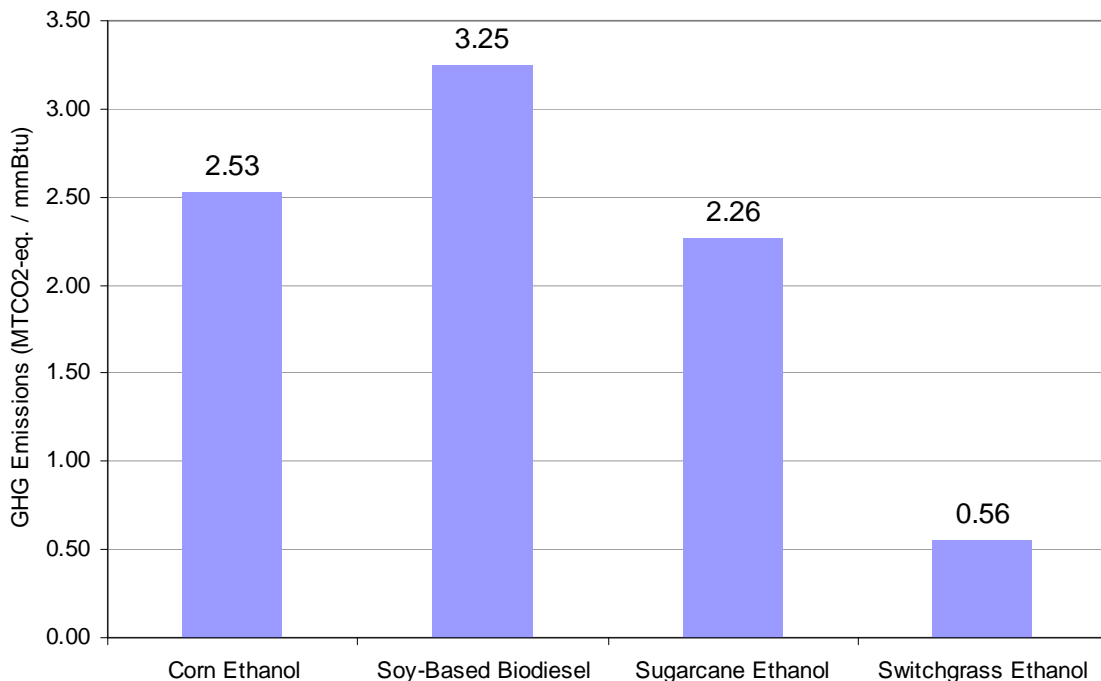

2.6.5.5 Timing of GHG Emissions

When comparing the lifecycle GHG emissions associated with biofuels to those associated with gasoline or diesel emissions, it is critical to take into consideration the time profile associated with each fuel's GHG's emissions stream. With gasoline, a majority of the GHG emissions associated with extraction, conversion, and combustion are likely to be released over a short period of time (i.e., annually) as crude oil is converted into gasoline or diesel fuel which quickly pass to market.

In contrast, the GHG emissions from the production of a typical biofuel (e.g., corn-based ethanol) may continue to occur over a long period of time. As with petroleum based fuels, GHG emissions are associated with the conversion and combustion of biofuels in every year they are produced. In addition, GHG emissions could be released through time if new acres are needed to produce corn or other crops for biofuels. The GHG emissions associated with converting land into crop production would accumulate over time with the largest release occurring in the first few years due to clearing with fire or biomass decay. After the land is converted, moderate amounts of soil carbon would continue to be released for approximately 20 years. Furthermore, there would be foregone sequestration associated with the fact that the forest would have continued to sequester carbon had it not been cleared for approximately 80 years (See Figure 2.6-24).

Figure 2.6-24.
Timing of International Land Use Change Emissions in Corn Ethanol Scenario
(gCO₂-eq. / mmBtu)

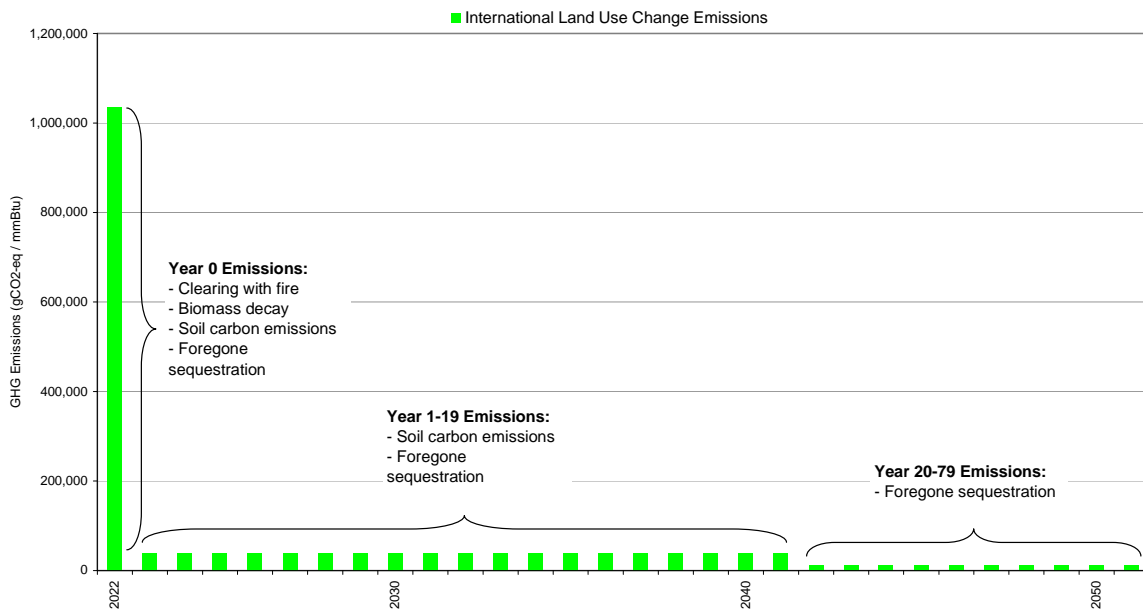

While biomass feedstocks grown each year on new cropland can be converted to biofuels that offer an annual GHG benefit relative to the petroleum product they replace, these benefits may be small compared to the upfront release of GHG emission. Depending on the specific

biofuel in question, it can take many years for the benefits of the biofuel to make up for the large initial releases of carbon that result from land conversion (e.g., the payback period).

As required by EISA, our analysis must demonstrate whether biofuels reduce GHG emissions by the required amount relative to the 2005 petroleum baseline. A payback period alone cannot answer that question. Since the payback period is not sufficient for our analysis, we have developed methods for capturing the stream of emissions and benefits over time. For our analytical purposes, it is important for us to determine how the time profiles of emission releases of different fuels compare. It is useful to have a unitary metric that allows for a direct comparison of biofuels compared to gasoline or diesel, which requires an accounting system for GHG emissions over time. When considering the time profile of GHG emissions, the two assumptions that have a significant impact on the determination of whether a biofuel meets the emissions reduction threshold include: 1) the time period considered and 2) the discount rate we apply to future emissions. The preamble to the proposed rule presents results using a 100-year time horizon and a 2% discount rate, as well as results with a 30-year time horizon and a 0% discount rate. The preamble includes a discussion of the important factors to consider when choosing a time horizon and discount rate. In Section 2.8, we present lifecycle GHG results using a variety of time horizons and discount rates.

2.6.6 Feedstock Transport

The GHG impacts of transporting biofuel feedstock from the field to the biofuel facility and transporting co-products from the biofuel facility to the point of use were included in this analysis. The GREET default of truck transportation of 50 miles was used to represent corn and soybean transportation from farm to plant. This includes 10 miles from farm to stacks and 40 miles from stacks to plant. Transportation assumptions for DGs transport were 14% shipped by rail 800 miles, 2% shipped by barge 520 miles, and 86% shipped by truck 50 miles. The percent shipped by mode was from data provided by USDA and based on Association of American Railroads, Army Corps of Engineers, Commodity Freight Statistics, and industry estimates. The distances DGs were shipped were based on GREET defaults for other commodities shipped by those transportation modes. Default GREET assumptions were also used for cellulosic ethanol feedstock transport. Crop residues, switchgrass and forest wastes were all assumed to be shipped by truck from point of production to plant. Crop residue distance shipped was 30 miles, switchgrass distance was 40 miles, and forest waste was 75 miles.

The GHG emissions from transport of feedstock and co-product are based on GREET default emission factors for each type of vehicle including capacity, fuel economy, and type of fuel used.

As part of this rulemaking analysis we have conducted a more detailed analysis of biofuel production locations and transportation distances and modes of transport used in the criteria pollutant emissions inventory calculations described in DRIA Chapter 1.6 and for the cost analysis of this rule described in DRIA Chapter 4.2. Given the timing of when the current analysis was completed we were not able to incorporate this updated transportation information into our lifecycle analysis but plan to do that for the final rule.

Furthermore, the transportation modes and distances assumed for corn and DGs do not account for the secondary or indirect transportation impacts. For example, decreases in exports will reduce overall domestic agricultural commodity transport and emissions but will increase transportation of commodities internationally. We plan to consider these secondary transportation impacts in our final rule analysis.

2.6.7 Biofuel Production

The GHG emissions associated with the processing of renewable fuels is dependent on a number of assumptions and varies significantly based on a number of key variables. For example, for corn ethanol the ethanol yield impacts the total amount of corn used and associated agricultural sector GHG emissions. The amount of DGs and other co-products produced will also impact the agricultural sector emissions in terms of being used as a feed replacement. Finally the energy used by the ethanol plant will result in GHG emissions, both from producing the fuel used and through direct combustion emissions. The following sections outline the assumptions used to model biofuel production for different feedstocks and fuel pathways.

In each case, the GHG emissions from renewable fuel production are calculated by multiplying the Btus of the different types of energy inputs by emissions factors for combustion of those fuel sources. The emission factors for the different fuel types are from GREET and are based primarily on assumed carbon contents of the different process fuels. The emissions from producing electricity are also taken from GREET and represent average U.S. grid electricity production emissions. The emissions from combustion of biomass fuel source are not assumed to increase net atmospheric CO₂ levels. Therefore, CO₂ emissions from biomass combustion as a process fuel source are not included in the lifecycle GHG inventory of the biofuel production plant.

2.6.7.1 Corn Ethanol

The two basic methods for producing ethanol from corn are dry milling and wet milling. In the dry milling process, the entire corn kernel is ground and fermented to produce ethanol. The remaining components of the corn are then dried for animal feed (dried distillers grains with solubles, or DDGS). In the wet milling process, the corn is soaked to separate the starch, used to make ethanol, from the other components of the corn kernel. Wet milling is more complicated and expensive than dry milling, but it produces more valuable products (ethanol plus corn syrup, corn oil, and corn gluten meal and feeds). The majority of ethanol plants in the United States are dry mill plants, which produce ethanol more simply and efficiently.

For this analysis the amount of corn used for ethanol production as modeled by the FASOM and FAPRI models was based on yield assumptions built into those two models. Assumptions were ethanol yields of 2.71 gallons per bushel for dry mill plants and 2.5 gallons per bushel for wet mill plants (yields represents pure ethanol).

As mentioned above, in traditional lifecycle analyses, the energy consumed and emissions generated by a renewable fuel plant must be allocated not only to the renewable, but also to each of the by-products. However, for corn ethanol production, this analysis accounts for

the DGs and other co-products use directly in the FASOM and FAPRI agricultural sector modeling described above. DGs are considered a partial replacement for corn and other animal feed and thus reduce the need to make up for the corn production that went into ethanol production. Since FASOM takes the production and use of DGs into account, no further allocation was needed at the ethanol plant and all plant emissions are accounted for here.

In terms of the energy used at renewable fuel facilities, there is a lot of variation between plants based on the process type (e.g., wet vs. dry milling) and the type of fuel used (e.g., coal vs. natural gas). There can also be variation between the same type of plants using the same fuel source based on the age of the plant and types of processes included, etc. For our analysis we considered different pathways for corn ethanol production. Our focus was to differentiate between facilities based on the key differences between plants, namely the type of plant and the type of fuel used. One other key difference we modeled between plants was the treatment of the co-products DGs. One of the main energy drivers of ethanol production is drying of the DGs. Plants that are co-located with feedlots have the ability to provide the co-product without drying. This has a big enough impact on overall results that we defined a specific category for wet vs. dry co-product. One additional factor that appears to have a significant impact on GHG emissions is corn oil fractionation from DGs. Therefore, this category is also broken out as a separate category in the following section. See DRIA Chapter 1.4 for a discussion of corn oil fractionation.

Furthermore, as our analysis was based on a future timeframe, we modeled future plant energy use to represent plants that would be built to meet requirements of increased ethanol production, as opposed to current or historic data on energy used in ethanol production. The energy use at dry mill plants was based on ASPEN models developed by USDA and updated to reflect changes in technology out to 2022 as described in DRIA Chapter 4.1. The modeling provided energy use for the different types of dry mill ethanol plants as shown in Table 2.6-41.

Table 2.6-41. Energy Use at Ethanol Plants (Btu/gal)

Type	Technology	NG Use	Coal Use	Biomass Use	Purchased Elec	
Corn Ethanol – Dry Mill NG	Near Term Technology (dry DDGS)	33,032			2,660	
	2022 Base Plant (dry DDGS)	28,660			2,251	
	2022 Base Plant w/ CHP (dry DDGS)	30,898			512	
	2022 Base Plant w/ CHP and Fractionation (dry DDGS)	22,014			714	
	2022 Base Plant w/ CHP, Fractionation and Membrane Separation (dry DDGS)	17,994			714	
	2022 Base Plant w/ CHP, Fractionation, Membrane Separation, and Raw Starch Hydrolysis (dry DDGS)	13,408			714	
	2022 Base Plant (wet DGS)	17,081			2,251	
	2022 Base Plant w/ CHP (wet DGS)	19,320			512	
	2022 Base Plant w/ CHP and Fractionation (wet DGS)	15,594			714	
	2022 Base Plant w/ CHP, Fractionation and Membrane Separation (wet DGS)	11,574			714	
	2022 Base Plant w/ CHP, Fractionation, Membrane Separation, and Raw Starch Hydrolysis (wet DGS)	8,841			714	
	Corn Ethanol – Dry Mill Coal	2022 Base Plant (dry DDGS)		35,824		2,694
2022 Base Plant w/ CHP (dry DDGS)			39,407		205	
2022 Base Plant w/ CHP and Fractionation (dry DDGS)			28,301		447	
2022 Base Plant w/ CHP, Fractionation and Membrane Separation (dry DDGS)			23,276		447	
2022 Base Plant w/ CHP, Fractionation, Membrane Separation, and Raw Starch Hydrolysis (dry DDGS)			17,545		447	
2022 Base Plant (wet DGS)			21,351		2,694	
2022 Base Plant w/ CHP (wet DGS)			24,934		205	
2022 Base Plant w/ CHP and Fractionation (wet DGS)			20,277		447	
2022 Base Plant w/ CHP, Fractionation and Membrane Separation (wet DGS)			15,252		447	
2022 Base Plant w/ CHP, Fractionation, Membrane Separation, and Raw Starch Hydrolysis (wet DGS)			11,836		447	
Corn Ethanol – Dry Mill Biomass		2022 Base Plant (dry DDGS)			35,824	2,694
		2022 Base Plant w/ CHP (dry DDGS)			39,407	205
	2022 Base Plant w/ CHP and Fractionation (dry DDGS)			28,301	447	
	2022 Base Plant w/ CHP, Fractionation and Membrane Separation (dry DDGS)			23,276	447	
	2022 Base Plant w/ CHP, Fractionation, Membrane Separation, and Raw Starch Hydrolysis (dry DDGS)			17,545	447	
	2022 Base Plant (wet DGS)			21,351	2,694	
	2022 Base Plant w/ CHP (wet DGS)			24,934	205	
	2022 Base Plant w/ CHP and Fractionation (wet DGS)			20,277	447	
	2022 Base Plant w/ CHP, Fractionation and Membrane Separation (wet DGS)			15,252	447	
	2022 Base Plant w/ CHP, Fractionation, Membrane Separation, and Raw Starch Hydrolysis (wet DGS)			11,836	447	
	Corn Ethanol – Wet Mill	Plant with NG	45,950			
		Plant with coal		45,950		
Plant with biomass				45,950		

2.6.7.2 Biodiesel

Two scenarios for biodiesel production were considered, one utilizing soybean oil as a feedstock and one using yellow grease.

For the soybean oil scenario, the energy use and inputs for the biodiesel production process were based on a model developed by USDA and used by EPA in the cost modeling of soybean oil biodiesel including crushing, as discussed in Chapter 4. Soybean crushing was modeled assuming yields of 11.2 lbs soybean oil/bu soybeans and energy use of 14,532 Btu of natural gas and 2,740 Btu of purchased electricity per gallon of biodiesel produced.

Similar to the case with corn ethanol co-products, we analyze the aggregate GHG emissions from soybean crushing and transesterification that occur as a result of increased demand for a particular biofuel. Therefore, any increase in soybean meal or soybean oil produced as a result of larger biodiesel volumes would take into account GHG emissions reductions from a decrease in the production of other feed and vegetable oil substitutes from our FASOM modeling.

Biodiesel is produced through the transesterification process where vegetable oil (triglyceride) is reacted with an alcohol (e.g., methanol) and a catalyst (e.g., sodium hydroxide) to produce biodiesel and glycerin. Soybean biodiesel transesterification was modeled assuming yields of one kilogram of biodiesel from a kilogram of soybean oil and energy use of 5,559 Btu of natural gas and 340 Btu of purchased electricity per gallon of biodiesel produced.

For the yellow grease case, no soybean agriculture emissions or energy use was included. Soybean crushing natural gas use was included as a surrogate for yellow grease processing (purification, water removal, etc.). Also, due to additional processing requirements, the energy use associated with producing biodiesel from yellow grease is higher than for soybean oil biodiesel production. The energy use for yellow grease biodiesel production was assumed to be 1.7 times the energy used for soybean oil biodiesel and yields of 0.94 kilograms of biodiesel from a kilogram of yellow grease.

GHG emissions from other biodiesel production raw material inputs were also included in the analysis. HCl, methanol, NaOCH₃ and sodium hydroxide are used in the production of biodiesel and GHG emissions from producing the raw material inputs were also added to the model. Table 2.6-42 shows the values that were used to convert raw material inputs into GHG emissions used in the analysis.

Table 2.6-42.
Lifecycle Factors for Biodiesel Raw Material Production

Factor	Unit	Methanol	Sodium Methoxide	Sodium Hydroxide	HCl
CO ₂	g/g	0.401	0.966	0.923	1.011
CH ₄	g/g	0.003	0.002	0	0
N ₂ O	g/g	3.9E-06	2.5E-06	0	0
Total Energy	Btu/g	19.05	24.10	9.67	9.35

2.6.7.3 Cellulosic Ethanol

Cellulosic ethanol can be produced through two main types of production processes, either fermentation or gasification. The fermentation option is mainly used for homogeneous feedstock sources like farmed trees, switchgrass and corn stover whereas the gasification option is recommended for more heterogeneous sources like forestry waste.

As discussed in Chapter 1, we have worked with NREL to generate models of cellulosic ethanol production. NREL has estimates for plants that were assumed to be in operation in the near-future (2010) and future (2015 and 2022). Currently NREL has generated results for a corn stover ethanol fermentation plant. We have used this to represent both corn stover and switchgrass ethanol production. The modeling assumes 78,378 Btu of biomass and 118 Btu of diesel fuel is required per gallon of ethanol produced. Process energy is assumed to be generated through the unfermentable portion (mainly lignin) of incoming biomass being burned for electricity production. The process is assumed to generate 8,053 Btu of excess electricity per gallon of ethanol produced.

The benefit of electricity generation is the possibility of lowering greenhouse gas emissions by offsetting other forms of electricity production. This is captured in our analysis by assuming that the excess electricity produced by the ethanol plant will offset U.S. grid electricity production. Therefore, GHG emissions from U.S. grid electricity are calculated for the amount of excess electricity produced based on GREET defaults for electricity production and subtracted from the lifecycle results of cellulosic ethanol production.

We are also examining ways to incorporate this excess electricity co-product offset evaluation in our secondary energy sector modeling with the NEMS model. This would be more consistent with our treatment of corn ethanol and biodiesel co-products where we expand the system boundaries to include the specific use of the co-products in an economic sector model. We will be examining this approach for our final rule analysis.

2.6.7.4 Brazilian Sugarcane Ethanol

Processing energy use for sugarcane ethanol was modeled similar to cellulosic ethanol in that it can produce excess electricity from burning bagasse. The assumption was that Brazilian sugarcane ethanol would produce 1.78 kWh of excess electricity per gallon of ethanol produced. The excess electricity from ethanol production was assumed to offset Brazilian grid electricity to calculate GHG emissions savings.

2.6.8 Fuel Transport

The default values in GREET for ethanol transportation and modes were used to represent transport of ethanol from the plant to the retail location. These default values are shown in Table 2.6-42.

Table 2.6-42. GREET Ethanol Transportation Input Data

Mode	Plant to Terminal		Terminal to Station	
	%	Distance (miles)	%	Distance (miles)
Barge	8%	520	0%	
Pipeline	63%	400	0%	
Rail	29%	800	0%	
Truck	0%		100%	30

Typically if ethanol facilities are located within 100-200 miles of a terminal, trucking is preferred. Rail and barge are used for longer distances. Pipelines are not currently used to transport ethanol and are not projected to play a role in ethanol transport in the future time frame considered.

For biodiesel transport, the values assumed in the RFS1 analysis were used to represent biodiesel transport. The assumptions were 22% of biodiesel shipped by barge and 78% shipped by rail. The GREET default distances for biodiesel rail and barge transport as well as terminal to station assumptions are consistent with ethanol transportation and distribution assumptions and were used in this analysis.

As with feedstock transport we have conducted a more detailed analysis of fuel transport and distribution impacts for use in criteria pollutant inventories (see DRIA Chapter 1.6) and for our cost analysis described in DRIA Chapter 4.2. Due to the timing of this analysis we were not able to incorporate the results in our lifecycle calculation but plan to do that for the final rule.

2.7 Tailpipe Combustion

Combustion CO₂ emissions for ethanol, biomass-based diesel, petroleum diesel and gasoline were based on the carbon content of the fuel. However, over the full lifecycle of the fuel, the CO₂ emitted from biomass-based fuels combustion does not increase atmospheric CO₂ concentrations, assuming the biogenic carbon emitted is offset by the uptake of CO₂ resulting from the growth of new biomass. As a result, CO₂ emissions from biomass-based fuels combustion are not included in their lifecycle emissions results. Net carbon fluxes from changes in biogenic carbon reservoirs in wooded or crop lands are accounted for separately in the land use change analysis as outlined in the agricultural sector modeling above.

When calculating combustion GHG emissions, however, the CH₄ and N₂O emitted during biomass-based fuels combustion are included in the analysis. Unlike CO₂ emissions, the combustion of biomass-based fuels does result in net additions of CH₄ and N₂O to the atmosphere. Therefore, combustion CH₄ and N₂O emissions are included in the lifecycle GHG emissions results for biomass-based fuels.

Combustion related CH₄ and N₂O emissions for both biomass-based fuels and petroleum-based fuels are based on EPA MOVES model results. The values used are shown in Table 2.7-1. CO₂ emissions from biofuels are shown for illustrative reasons, but as mentioned above are not

included in the analysis because they are assumed to be offset by carbon uptake from plant growth.

**Table 2.7-1.
Tailpipe Combustion Emissions for Bio and Petroleum Based Fuels**

	CO2	CH4	N2O
Fuel Type	(g/mmBtu)	(g/mmBtu)	(g/mmBtu)
Ethanol	75,250	269	611
Biodiesel	81,044	11	689
Gasoline	77,567	67	1,659
Diesel Fuel	78,761	11	689

2.8 Fuel-Specific Lifecycle Greenhouse Gas Emissions Results

2.8.1 Renewable Fuel Payback Periods and Lifecycle GHG Emissions Results

In this section we present detailed lifecycle GHG analysis results, including the results of sensitivity and scenario analyses on key assumptions. As discussed above, to implement the EISA the crucial result that determines which renewable fuel pathways qualify for RFS2 credits is the percent reduction in lifecycle GHG emissions compared to the average lifecycle greenhouse gas emissions for gasoline or diesel sold or distributed as transportation fuel in 2005. To compare lifecycle GHG emissions from renewable fuels and petroleum, we present the grams of CO₂-equivalent emissions per Btu of fuel produced (gCO₂eq/mmBtu). The previous sections in this Chapter discussed our methodology for calculating lifecycle GHG emissions for each component of the renewable fuel lifecycle, and for the 2005 petroleum baseline. In this Section we present and compare the GHG emissions results for each of these components in the fuel lifecycle. We also discuss how key assumptions can change the GHG emissions from each component of the fuel lifecycle, and how they influence the final GHG percent reduction estimates.

In addition to estimating GHG emissions at every stage of the fuel lifecycle, EPA’s task in this rulemaking is to integrate the GHG emissions estimates from all stages of the lifecycle in order to estimate lifecycle GHG percent reductions for each renewable fuel pathway. We have considered a number of ways to meet this challenge, and have identified several key methodological issues that can influence whether a particular renewable fuel pathway meets the thresholds set forth in the EISA. For example, one issue that deserves attention is the timing of lifecycle GHG emissions.

Section 2.6.5.5 explained that the lifecycle GHG emissions associated with biofuels can vary over time. Clearing forests, grasslands, and other types of land that sequester carbon, for crop production can result in GHG emissions for many years. As depicted in Figure 2.6-19, this type of land conversion produces large immediate GHG emissions, followed by a lesser stream of emissions that can last for many years. Biomass feedstocks grown annually on new cropland can be converted to biofuels that offer a GHG benefit relative to the petroleum product they

replace, but these benefits may be small compared to the upfront GHG emissions associated with land clearing to expand crop production. Depending on the specific biofuel in question, it can take many years for the benefits of the biofuel to make up for the large initial releases of carbon that result from land conversion (e.g., the payback period).

The payback period calculation, presented graphically in Figure 2.8-1, represents the time it takes for the emissions savings from the production of biofuels to equal the potentially large initial emissions from land use changes. Although we do not believe it is appropriate to use the payback period for RFS2 compliance purposes, this calculation helps to illustrate the importance of the time dimension of renewable fuel lifecycle GHG emissions.

Figure 2.8-1. Corn Ethanol Payback Period

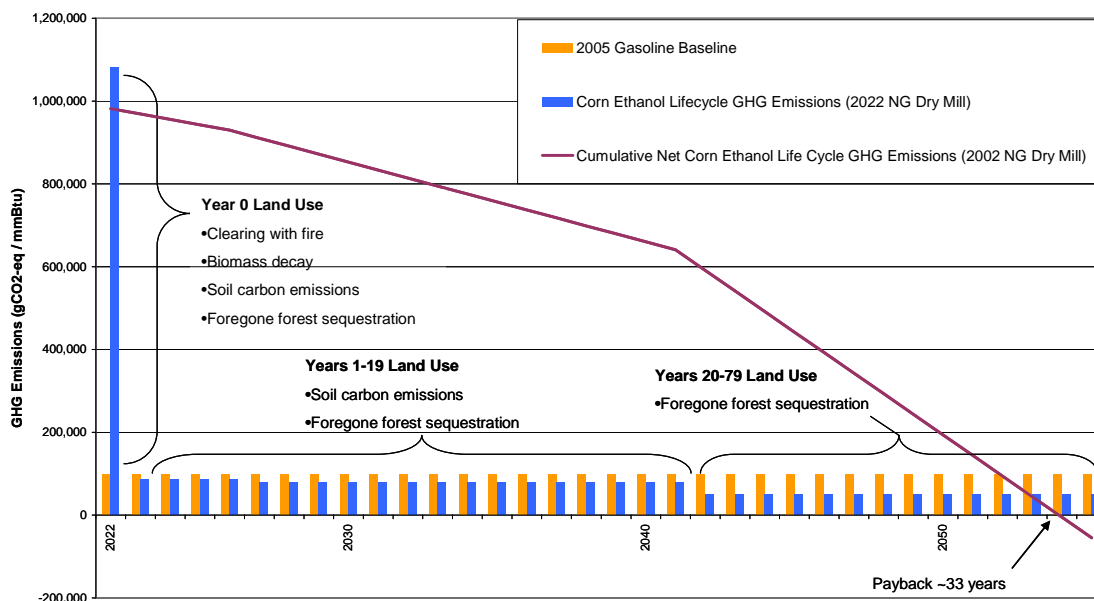
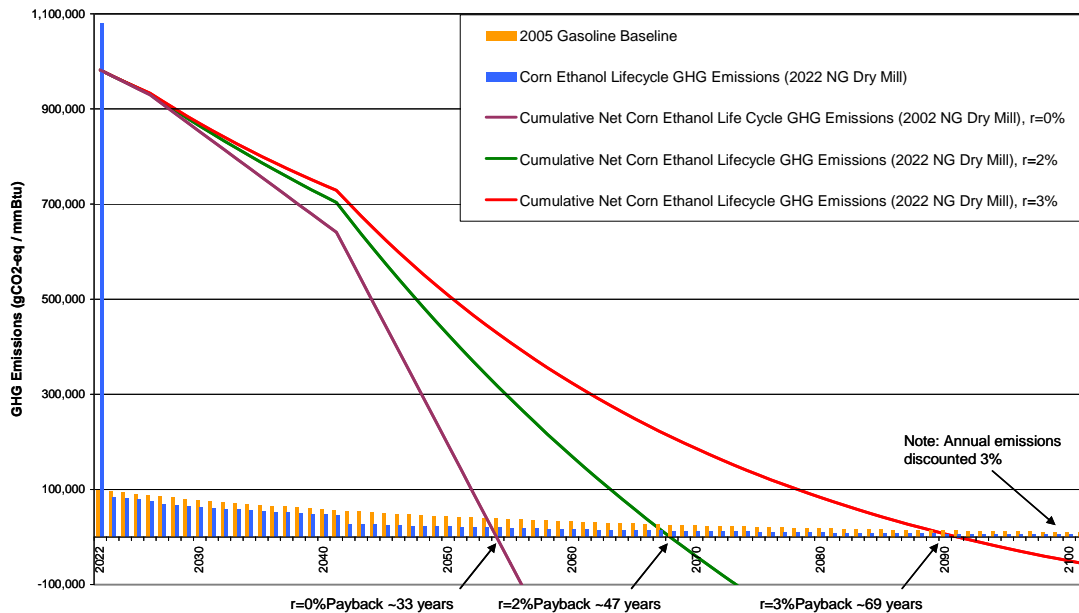

Figure 2.8-1 shows the lifecycle GHG emissions from corn ethanol produced with a 2022 technology natural gas fired dry mill, and from the 2005 gasoline baseline. In the first year, in this case 2022, corn ethanol lifecycle GHG emissions are more than ten times greater than the gasoline it replaces. However, corn ethanol has ongoing GHG benefits in every subsequent year. It takes approximately 33 years for the annual GHG benefits of corn ethanol compared to gasoline to pay back the initial GHG releases from land clearing. This tells us that unless we analyze the lifecycle GHG emissions of corn ethanol over more than 33 years, corn ethanol from this pathway will not achieve a reduction compared to gasoline. As we extend our analysis beyond 33 years we will see increasing GHG reductions associated with the use of corn ethanol.

As discussed in Section 2.6.5.5, economic theory suggests that in general consumers have a time preference for benefits received today versus receiving them in the future. Therefore, future benefits are often valued at a discounted rate. If we apply this concept to GHG emissions, the GHG reduction benefits achieved by corn ethanol in future years carries less weight than earlier emissions. Figure 2.8-2 illustrates that the payback period is significantly longer if we use a two percent or three percent discount rate.

Figure 2.8-2. Corn Ethanol Payback Period with Different Discount Rates



The payback period concept helps to demonstrate the importance of the choice of a discount rate and time horizon for this analysis. These factors are so important because of the variation in GHG emissions from renewable fuels over time, and the contrasting steady annual emissions from the petroleum baseline. It is difficult to compare these two very different emissions profiles unless we put them on an equal footing. To do this, we compared the net present value (NPV) of renewable fuels emissions and the NPV of emissions from the petroleum baseline. Using NPVs to compare streams of costs and benefits is a well established practice for cost-benefit analysis. Similarly, a net present value approach is commonly used to assess GHG emissions.^{wwwwww} The NPV of lifecycle GHG emissions is the sum of all terms:

$$\text{GHG}t / (1 + r)^t, \text{ where}$$

t = the year, where year 0 is the first year of analysis
 r = the discount rate
 $\text{GHG}t$ = the net flow of GHG emissions in year t

In the preamble for the proposed rule, we highlight results that use a discount rate of two percent (i.e., $r=2\%$), with a 100 year time horizon (i.e. $T=100$), and a 0% discount rate (i.e., $r=0\%$) with a 30 year time horizon ($T=30$). Figure 2.8-3 includes lifecycle GHG results using a 100-year time horizon and a 2% discount rate for a typical dry mill corn ethanol facility fired with natural gas.

^{wwwwww} See for example The Stern Review of the Economics of Climate Change, October 2006, <http://www.occ.gov.uk/activities/stern.htm>

**Figure 2.8-3. Corn Ethanol Lifecycle GHG Results
(NPV, r=2%, T=100 years)**

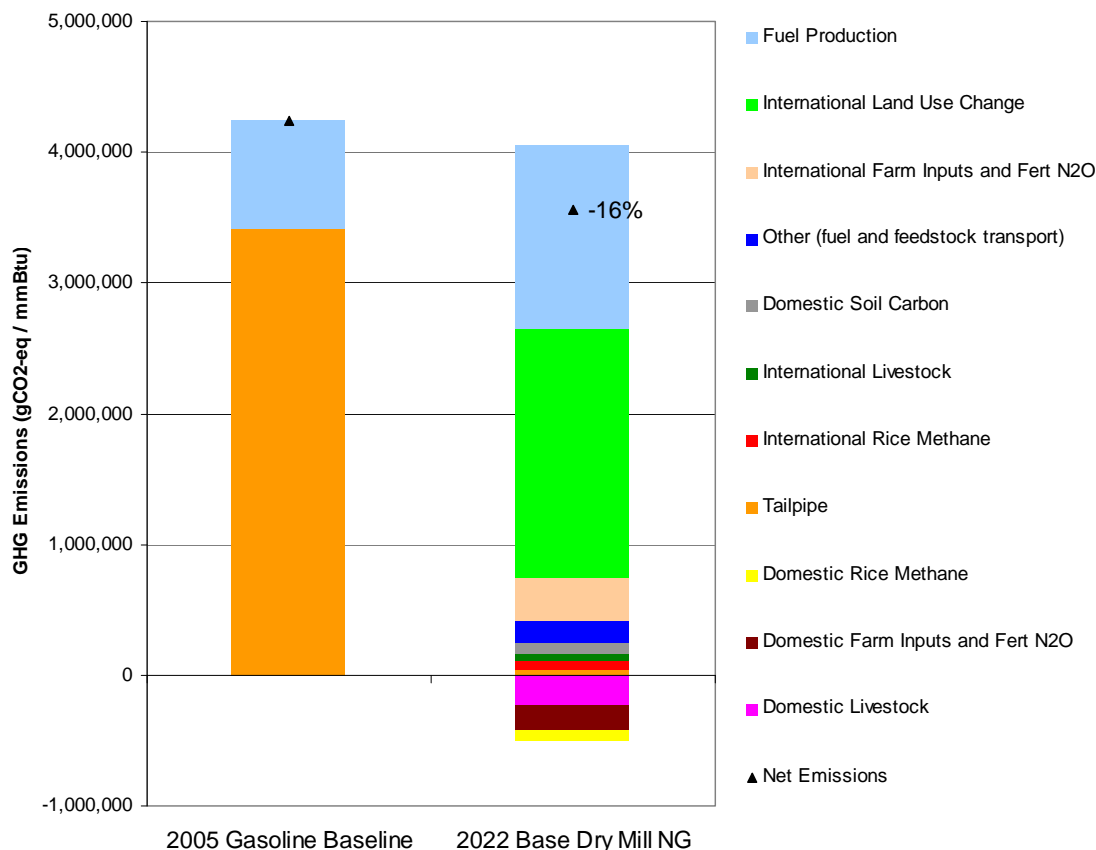

The NPV of gasoline GHG emissions over 100 years is presented on the left side of Figure 2.8-3. The chart shows that with a 2 percent discount rate the 100-year NPV of gasoline lifecycle GHG emissions is 4,240,674 gCO₂eq/mmBtu. Tailpipe emissions make up over 80% of the lifecycle GHG emissions from gasoline. The rest of gasoline’s lifecycle GHG emissions occur during the fuel production process, which includes both upstream and downstream production processes.

The lifecycle GHG emissions from corn ethanol appear on the right-hand side of Figure 2.8-3. With a 2 percent discount rate the 100 year net present value of lifecycle GHG emissions from corn produced in a typical natural gas fired dry mill is 3,563,294 gCO₂eq/mmBtu. This represents a 677,379 gCO₂eq/mmBtu benefit compared to the gasoline baseline, or a 16 percent lifecycle GHG reduction.

As discussed above in Section 2.7, tailpipe emissions are almost negligible for corn ethanol, because the carbon emitted upon ethanol combustion was sequestered when the corn was growing in the field. The result is a net carbon emission of zero, and small emissions of non-CO₂ GHGs.

Fuel production accounts for almost 40% of the net emissions from corn ethanol. The fuel production emissions presented in Figure 2.8-3 correspond with a typical dry mill corn ethanol production facility that uses natural gas and electricity for energy, and produces dried DGs. The ethanol production facility in this example has the projected efficiency of a typical dry mill in 2022. Emissions associated with transportation and distribution of feedstocks to the ethanol plant, and ethanol to the end consumer, account for almost 5 percent of corn ethanol’s net lifecycle GHG emissions.

As discussed in detail above, corn production requires land, fertilizer, pesticides, energy use, and other inputs that produce GHG emissions. However, using more corn for ethanol has other significant indirect impacts that ripple through the domestic agricultural sector. Many of the secondary agricultural sector impacts have significant GHG emissions implications. For example, as corn prices increase, corn-intensive livestock production tends to decrease and methane emissions from cattle also drop. As Figure 2.8-3 shows, we estimated that using more corn for ethanol results in net reductions of GHG emissions from domestic livestock, domestic farm inputs and nitrous oxide, and domestic rice methane emissions. Domestic soil carbon emissions increase modestly, but the net effect is a reduction in GHG emissions from domestic agriculture. Foreign agriculture is also a significant source of GHG emissions. As a result of using more U.S. corn for ethanol, we project that crop and livestock production will increase in foreign countries, with corresponding GHG emissions..

Figure 2.8-4 includes NPV lifecycle GHG results for four types of corn ethanol production facilities, and for ethanol made from other types of feedstocks.

Figure 2.8-4. Ethanol Lifecycle GHG Results (NPV, r=2%, T=100 years)

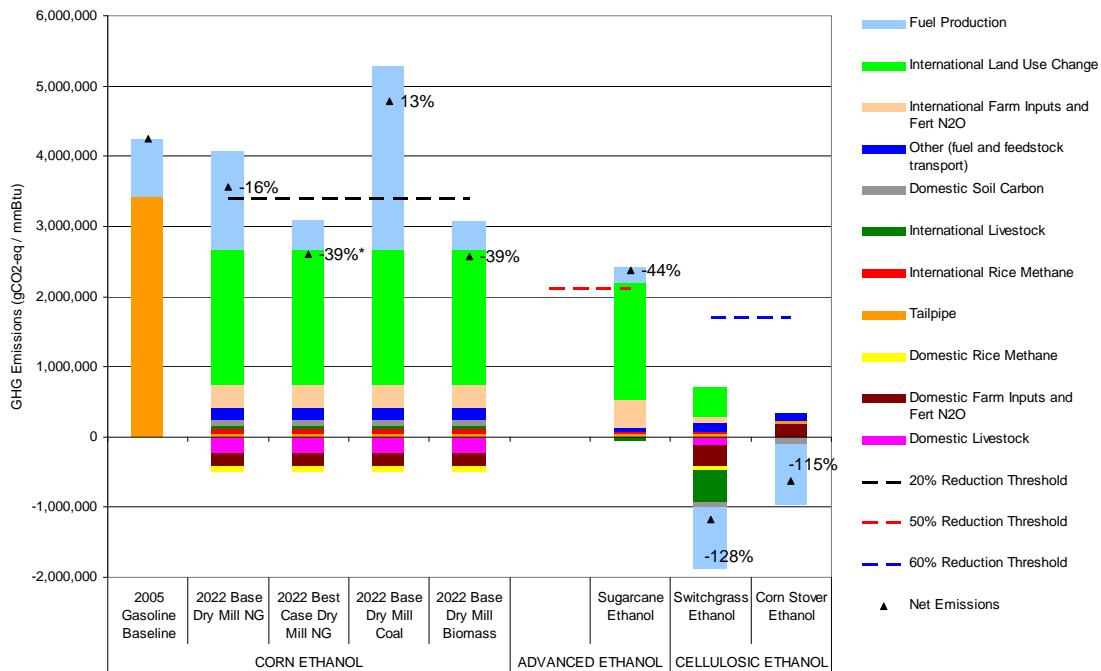

Note: “Best case” plants include CHP, fractionation, membrane separation and raw starch hydrolysis technologies

A “best case” corn ethanol plant fired with natural gas achieves a 39% reduction compared to gasoline. The best case plant is equipped with advanced technologies that can be deployed in tandem: combined heat and power (CHP), fractionation, membrane separation and raw starch hydrolysis. Details about these fuel production technologies are discussed in Section 2.6.7. The results in Figure 2.8-4 suggest that the energy efficiency of future corn production facilities could be an important determinant of which production pathways meet the thresholds specified in the EISA.

Figure 2.8-4 shows that imported sugarcane ethanol achieves a 44 percent reduction compared to the gasoline baseline, which is close to the 50 percent reduction threshold for advanced renewable fuels and exceeds the minimum adjusted threshold of 40 percent. Sugarcane ethanol has lower lifecycle GHG emissions than corn ethanol for a number of reasons. Converting sugarcane to ethanol is less energy intensive than the conversion process with corn. Standard sugarcane ethanol production facilities burn bagasse^{xxxxxxx} for energy, which shrinks their carbon footprints. International land use change emissions associated with sugarcane ethanol production are about 10 percent less than international land use change emissions from corn ethanol. Sugarcane ethanol also has benefits compared to corn ethanol in the international rice methane, international livestock, and other emissions categories.

The cellulosic ethanol pathways presented in Figure 2.8-4, corn stover and switchgrass ethanol, both achieve greater than 100 percent lifecycle GHG reductions compared to gasoline. In fact, as the figure shows, producing ethanol from these pathways creates a net abatement of GHG emissions. A major source of the emissions mitigation in the cellulosic ethanol lifecycle occurs at the fuel production stage. The cellulose and lignin in switchgrass and corn residue are separated with an enzymatic process. The cellulose is fermented to produce ethanol, leaving lignin as a by-product which can be burned for heat and electricity. Our process modeling suggests that by burning lignin, cellulosic ethanol production facilities utilizing an enzymatic conversion process will generate more electricity than they need. These facilities will be net exporters of electricity to the grid, offsetting an average mix of grid electricity. Switchgrass ethanol has modest impacts on international land use and crop production, because it competes with other crops for land.

In our results ethanol from switchgrass achieves the largest lifecycle GHG reductions compared to petroleum. The results include a large decrease in foreign livestock emissions as a result of switchgrass ethanol production. However, this result may be an artifact of the imperfect way that switchgrass was represented in the FAPRI model.^{yyyyyyy} As we refine this estimate for the final rule, we might see a different outcome for international livestock emissions. Switchgrass land use change emissions are roughly one-fifth as large as land use change emissions from corn ethanol because switchgrass can be produced on less fertile lands, thus displacing less commodity crop production. However, this estimate is also subject to change as we refine our modeling of switchgrass with the FAPRI model.

^{xxxxxxx} Bagasse is the biomass remaining after sugarcane stalks are crushed.

^{yyyyyyy} When we conducted our analysis for the proposed rule the FAPRI model did not explicitly include switchgrass cultivation. As a proxy for switchgrass we modeled an increase in domestic land enrolled in the Conservation Reserve Program (CRP).

Corn stover is a waste product that does not displace land from commodity crop production. In fact, using stover for ethanol creates a market for corn residue, making corn farming a more profitable enterprise. Corn residue is a source of nitrogen, so removing it from the field requires additional fertilizer application, which is why we see a modest increase in emissions from domestic farm inputs. On the other hand, farmers must employ no-till farming practices in order to harvest stover and sell it to ethanol. The spread of no-till farming has soil carbon benefits that show-up in Figure 2.8-4.

Biodiesel lifecycle GHG emissions results are presented in Figure 2.8-5. Over a 100-year time horizon soy-based biodiesel achieves a 22% lifecycle GHG reduction, and biodiesel derived from waste grease achieves a larger lifecycle GHG reduction. We did not include upstream or indirect impacts in the waste grease biodiesel lifecycle. Upstream emissions were fully attributed to the first use of the oil; not to the residual waste grease. Although indirect impacts are not included in the results presented here, we intend to conduct a closer study of the potential for indirect impacts from using waste grease for biodiesel, instead of using it for other purposes. This will include further review of waste grease supply and demand projections.

Figure 2.8-5.
Biodiesel Lifecycle GHG Results
 (NPV, r=2%, T=100 years)

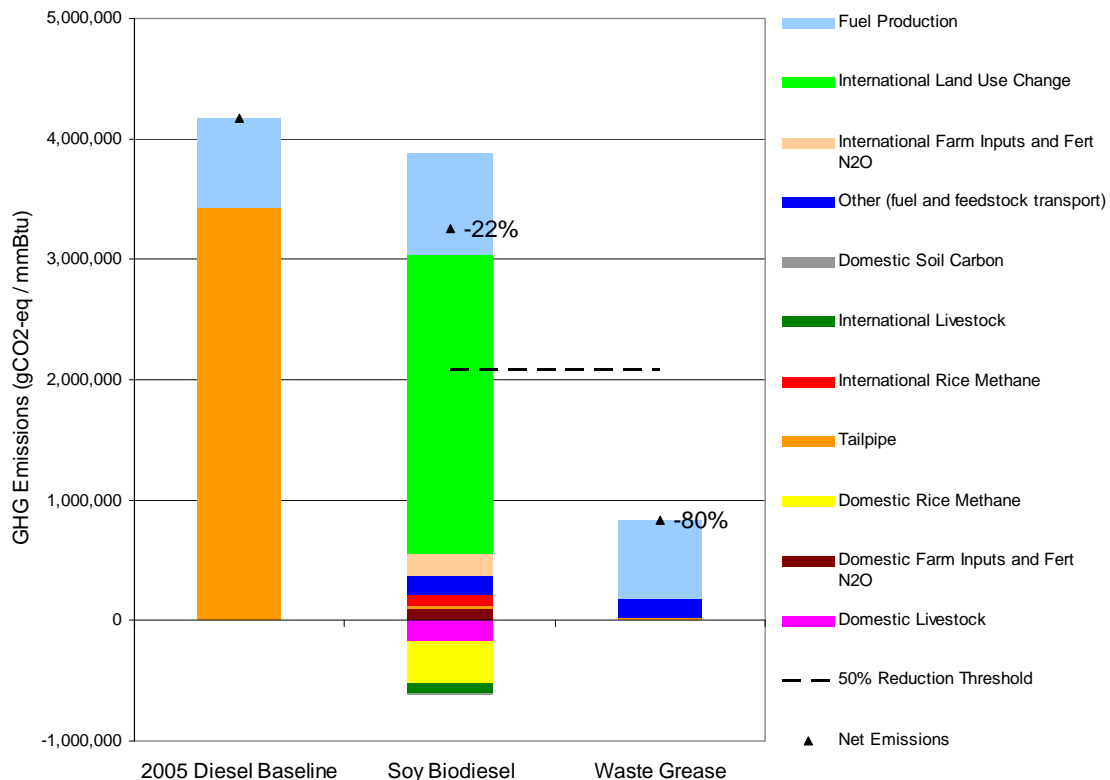
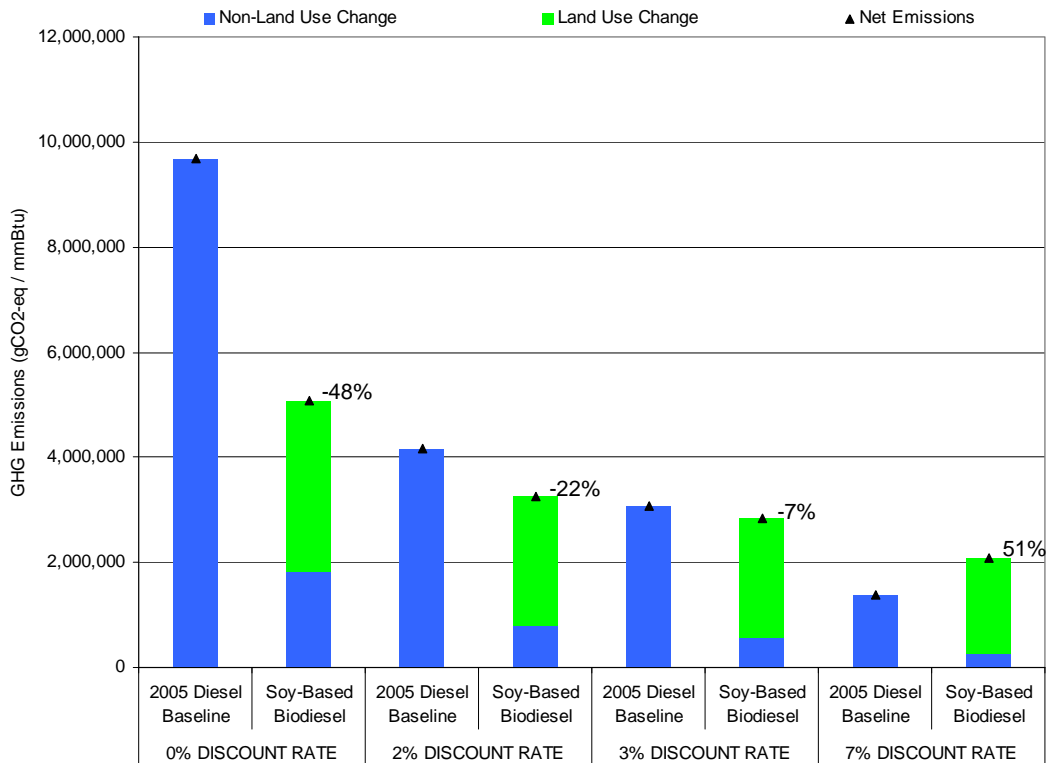

Figure 2.8-6 illustrates the effect of the choice of discount rate on lifecycle GHG results. As the discount rate increases, the NPV of non-land use change emissions decrease. This happens because a higher discount rate diminishes the relative valuation of emissions that occur

in the future. On the other hand, the NPV of emissions from of land use changes are less affected by the choice of discount rate. This is because, as displayed in Figure 2.8-1, a large share of international land use change emissions occur in the first year. Therefore, for renewable fuels that include international land use change emissions, increasing the discount rate will reduce their lifecycle GHG percent reduction compared to petroleum. In Figure 2.8-6, going from a 0% to 7% discount rate changes the lifecycle GHG emissions of biodiesel compared to average diesel from a 48% reduction to a 51% increase.

Figure 2.8-6
Biodiesel Lifecycle GHG Results with Different Discount Rates
 (NPV, $r=0\%$, 2% , 3% , 7% , $T=100$ years)



When lifecycle emissions vary over time—as they do for biofuels that induce indirect land use change—the choice of time horizon is essential. Figure 2.8-7 includes corn ethanol lifecycle GHG results using a 30-year time horizon and a 0% discount rate. This figure is similar to Figure 2.8-4 except for the time horizon. For corn ethanol produced in a typical natural gas fired dry mill, decreasing the time horizon from 100 to 30 years and shifting the discount rate from 2% to 0% changes the lifecycle GHG results from a 16 percent decrease to an 5 percent increase compared to gasoline.

Figure 2.8-7.
Corn Ethanol Lifecycle GHG Results
(NPV, r=0%, T=30 years)

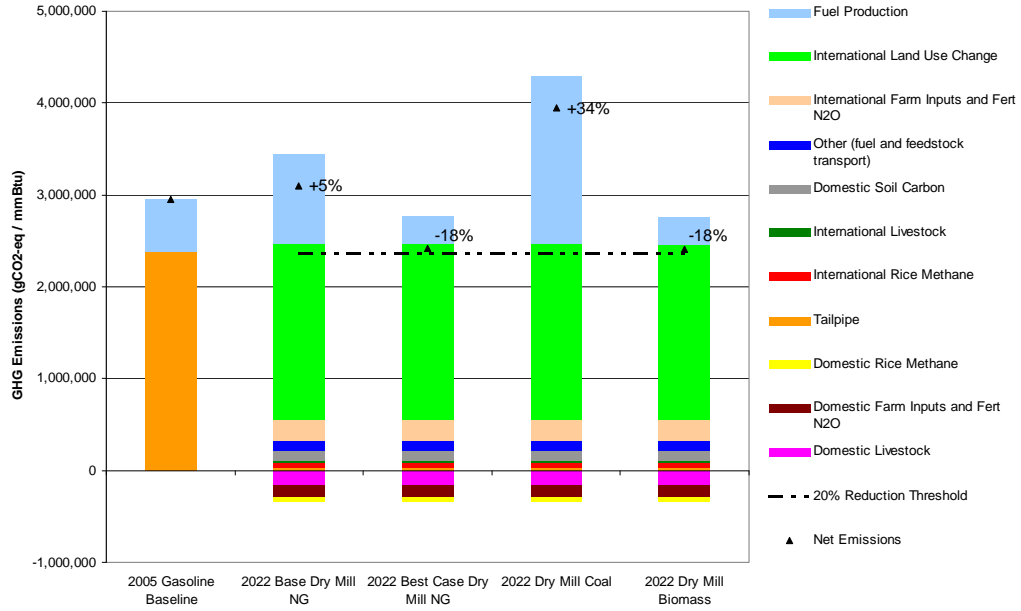
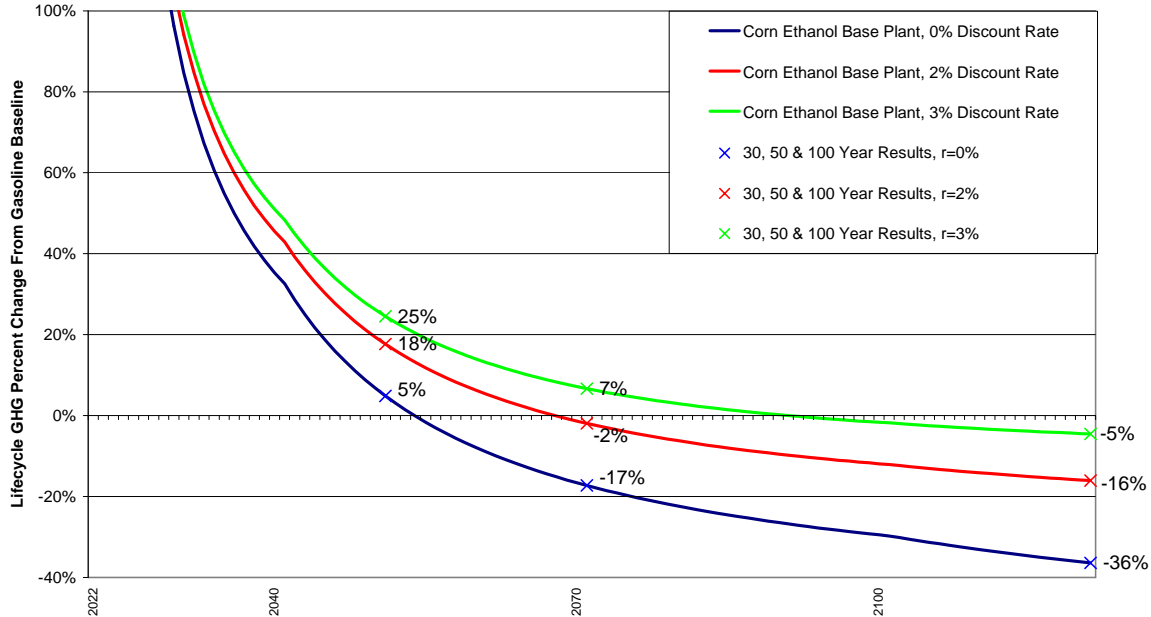

Figure 2.8-8 includes lifecycle GHG results for corn ethanol produced in a natural gas-fired dry mill over a continuum of time horizons. The horizontal axis is the choice of time horizon. As discussed above, our results indicate that the payback period for a standard corn ethanol pathway is approximately 33 years. With a zero percent discount (the blue line in Figure 2.8-8) corn ethanol increases GHG emissions by 5 percent over 30 years, and reduces emissions by 17 percent and 36 percent over 50 and 100 years respectively. With higher discount rates, it takes longer for the future benefits of corn ethanol production to payback earlier land clearing emissions. When we use a discount rate greater than zero, future benefits are discounted, causing the curves in Figure 10-8 to flatten out over time.

**Figure 2.8-8.
Lifecycle GHG Results for Corn Ethanol Produced in a Natural Gas Dry Mill
(Percent Change from Gasoline with Different Discount Rates and Time Horizons)**



2.8.2 Land Use Change Sensitivity Results

In our results, emissions from land use changes are a significant source of the lifecycle GHG emissions for renewable fuels produced with feedstocks that can be used in food products or grown on fertile land. As discussed above, we used a number of agricultural and economic models to estimate the land use impacts of these fuels. We used the FASOM model to estimate GHG emissions from land use changes in response to renewable fuel production. With the FAPRI model we projected which foreign countries would expand crop production as a result of the RFS2 program. We then used satellite data from 2001 to 2004 to project where cropland is likely to be added within foreign countries, and which types of land are cleared to make room for new crop areas. Emissions factors developed by the non-profit Winrock International, using 2006 IPCC guidelines, were applied to estimate the GHG emissions associated with foreign land use change. This approach for estimating land use change GHG emissions used the best available tools. However, even with the best available tools, projecting how a U.S. policy will effect international land use change is a task with inherent uncertainty. For this reason we identified key parameters within our land use change projections and conducted selective sensitivity analysis.

2.8.2.1 Types of Land Converted to Cropland Sensitivity Analyses

One of the most important questions that determine the magnitude of land use change GHG emissions is what types of land are cleared when new cropland is added. This question is significant because clearing forest to expand cropland produces more GHG emissions per acre

than clearing grassland, or other types of land that sequester less carbon. For example, we estimate that in Brazil an average acre of forest contains almost 10 times more carbon than an average acre of grassland. To address uncertainty, we conducted sensitivity analyses where we varied the types of land that are cleared internationally as a result of biofuel production.

A common input from stakeholders has been their belief that in many countries, such as Brazil, there is ample abandoned cropland, idle grassland and degraded pasture to accommodate crop expansion induced by biofuel production. The MODIS satellite data suggests that if recent trends persist, crop expansion would occur on land previously inhabited by a variety of ecosystem types. However, future economic conditions or government policies could dictate that cropland expansion would occur exclusively on idle grassland. We did a sensitivity analysis that assumes that all new cropland occurs on idle grassland, which also implies no pasture replacement is necessary.^{ZZZZZZ} Figure 2.8-9 shows that the assumption that all cropland expansion occurs on idle grassland has a dramatic impact on GHG emissions per acre. This assumption has a particularly large impact on the weighted average emissions factors for South East Asian countries that have a large portion of forest to cropland conversion in our central estimates for the proposed rule.

Figure 2.8-9.
GHG Emissions per Acre of Cropland Expansion
 (NPV, r=2%, T=100 years)

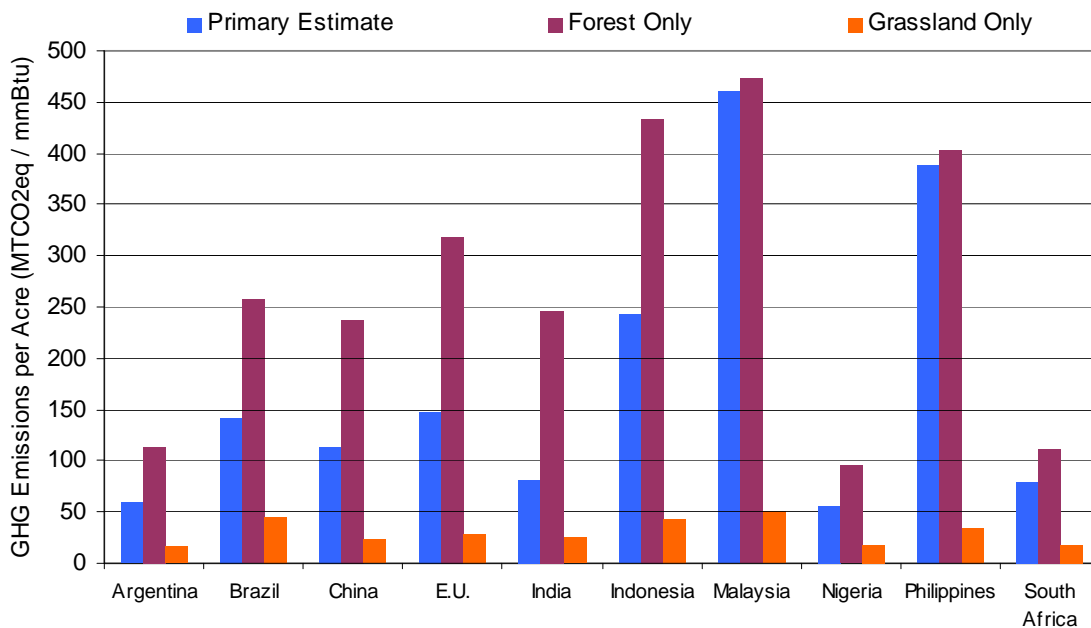

Tables 2.8-1 and 2.8-2 show how EPA’s lifecycle GHG emission estimates vary by renewable fuel. Table 2.8-1 includes results using a 100-year time horizon and a 2% discount rate. Table 2.8-2 includes results using a 30-year time horizon and a 0% discount rate. Our primary estimates include GHG emissions from forest and grassland clearing (proportionally estimated based on MODIS satellite data) resulting from the use of agricultural products for

^{ZZZZZZ} See Section 2.6 for a discussion of pasture replacement

biofuel production.^{AAAAA} The tables also show how the percent reduction estimates would vary if we assumed that all new cropland would come from forest, or all from grasslands.

**Table 2.8-1. Lifecycle GHG Results
100-Year Time Horizon with 2% Discount Rate**

Land Use Change	GHG Emissions Reductions Relative to the 2005 Petroleum Baseline		
	Forest Only	Primary Estimate	Grassland Only
Corn Ethanol (Natural Gas Dry Mill)	+20%	-16%	-48%
Corn Ethanol (Coal Dry Mill)	+48%	+13%	-19%
Corn Ethanol (Biomass Dry Mill)	-4%	-39%	-71%
Soy-Based Biodiesel	+15%	-22%	-65%
Waste Grease Biodiesel	-80%	-80%	-80%
Sugarcane Ethanol	-23%	-44%	-70%
Switchgrass Ethanol	-118%	-128%	-135%
Corn Stover Ethanol	-115%	-115%	-115%

**Table 2.8-2. Lifecycle GHG Results
30-Year Time Horizon with 0% Discount Rate**

Land Use Change	GHG Emissions Reductions Relative to the 2005 Petroleum Baseline		
	Forest Only	Primary Estimate	Grassland Only
Corn Ethanol (Natural Gas Dry Mill)	+49%	+5%	-38%
Corn Ethanol (Coal Dry Mill)	+78%	+34%	-9%
Corn Ethanol (Biomass Dry Mill)	+26%	-18%	-61%
Soy-Based Biodiesel	+49%	+4%	-54%
Waste Grease Biodiesel	-80%	-80%	-80%
Sugarcane Ethanol	-4%	-26%	-60%
Switchgrass Ethanol	-113%	-124%	-134%
Corn Stover Ethanol	-116%	-116%	-116%

As discussed in the preamble, in the case of sugarcane production in Brazil, a number of researchers argue that expanded sugarcane production is likely to occur in significant part through the use of degraded or abandoned pasture land without additional land use impact in Brazil.^{BBBBBBB} If these researchers are correct, then we estimate that sugarcane ethanol produced in Brazil would produce a 64% lifecycle GHG emissions reduction compared to gasoline with a 100-year time horizon and a 2% discount rate, or a 52% lifecycle GHG reduction with a 30-year time horizon and a 0% discount rate.

^{AAAAA} Per acre land use change emissions factors were estimated by Winrock International Inc., following 2006 Intergovernmental Panel on Climate Change guidelines

^{BBBBBBB} See for example “Mitigation of GHG emissions using sugarcane bio-ethanol - Working Paper” by Isaias C. Macedo and Joaquim E. A. Seabra, and “Prospects of the Sugarcane Expansion in Brazil: Impacts on Direct and Indirect Land Use Changes – Working Paper” by Andre Nassar et al, both received by EPA October 13, 2008

2.8.2.2 Foregone Forest Sequestration Sensitivity Analysis

Section 2.6 discussed our primary approach for estimating foregone forest sequestration when forests are converted to cropland. As discussed in that section, foregone sequestration was estimated using average annual biomass accumulation rates for forests greater than 20 years old given in Table 4.9 of the 2006 GL AFOLU according to ecological zone and continent. These values were used to estimate the lost biomass accumulation of forests that were converted to another land use. Foregone sequestration was assumed to continue at a constant rate for 80 years. Studies have estimated that new forests grow for 90 years to over 120 years.^{CCCCCCC} More recent estimates suggest that old growth forests accumulate carbon for up to 800 years.⁵³⁸ Our proposed estimate that foregone sequestration continues for 80 years is within the range supported by the scientific literature and the 2006 IPCC guidelines. However, there are other reasonable approaches that could have been used to estimate foregone sequestration.

Given the wide range of estimates about how long forests continue to accumulate carbon it would not be unreasonable to assume that we should account for more than 80 years of lost sequestration. On the other hand, if we expect that very old forests would be converted to cropland, it would also be reasonable to assume a shorter timeframe for lost sequestration, or no lost sequestration at all. Figure 2.8-10 shows how using different assumptions about the length of foregone sequestration affects weighted average emissions factors for forest to cropland conversion in Brazil.

^{CCCCCCC} See Greenhouse Gas Mitigation Potential in U.S. Forestry and Agriculture, EPA Document 430-R-05-006 for a discussion of the time required for forests to reach carbon saturation.

Figure 2.8-10.
Weighted Average Emissions per Acre of Forest to Cropland Conversion in Brazil
Different Lengths of Foregone Sequestration
 (NPV, r=2%, T=100 years)

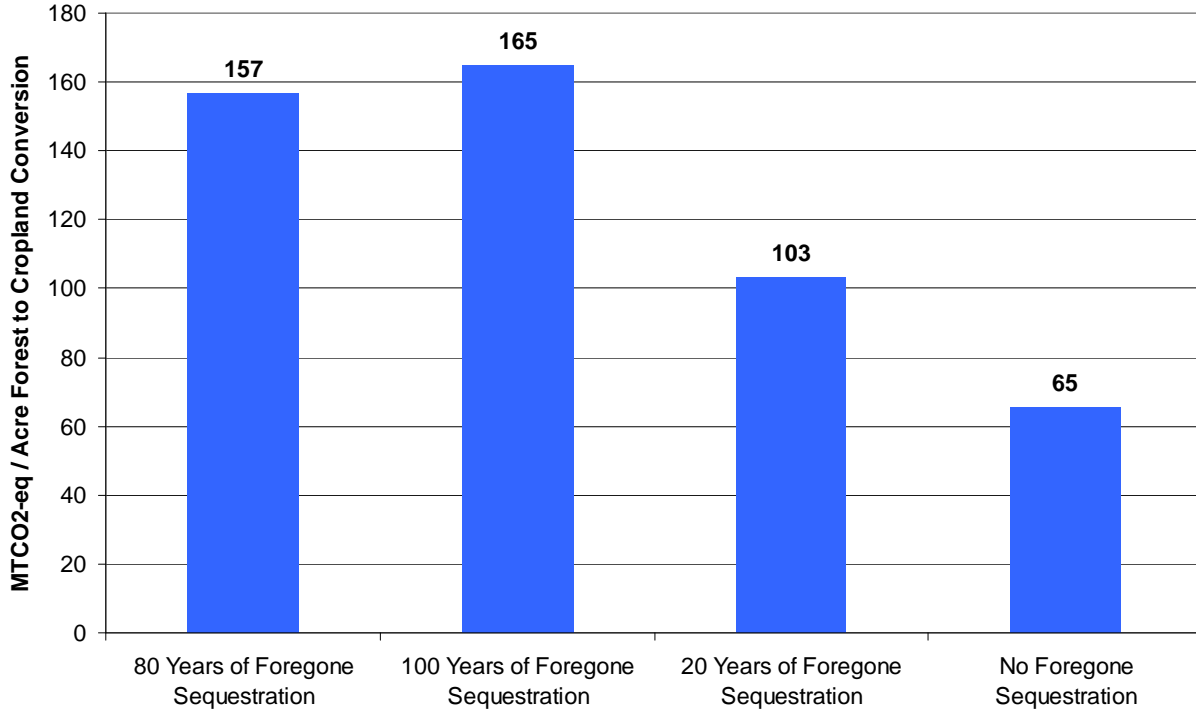
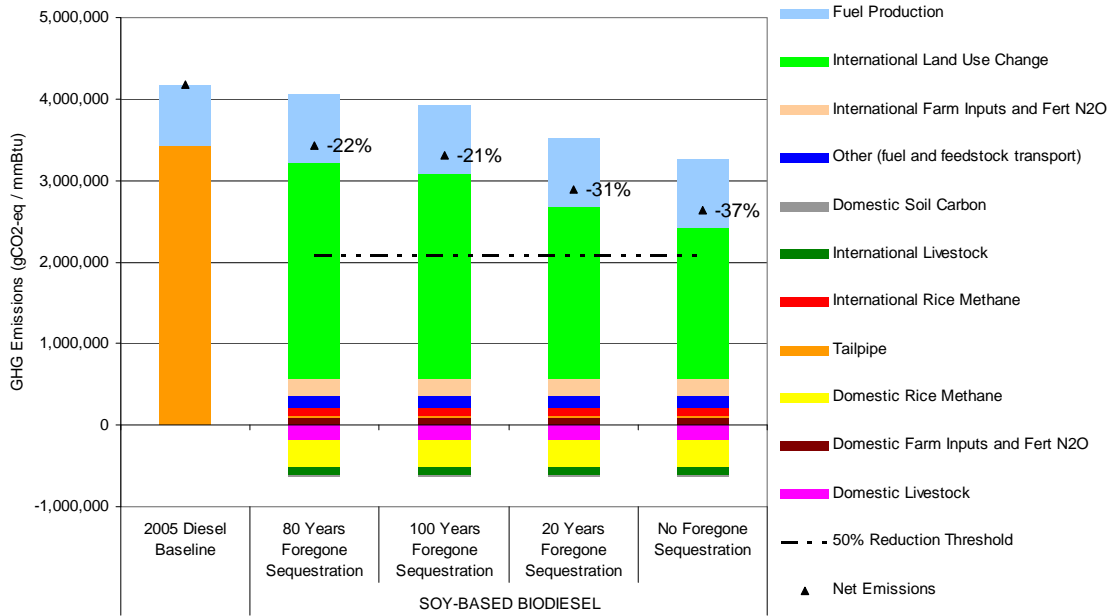

Figure 2.8-11 includes lifecycle GHG results for soy-based biodiesel with different assumptions about the length of foregone forest sequestration. The length of foregone sequestration is an important part of international land use change emissions, but even if we assume no foregone sequestration, our results suggest that soy-based biodiesel does not achieve a 40 percent lifecycle GHG reduction compared to average diesel fuel.

Figure 2.8-11.
Soy Biodiesel Lifecycle GHG Results – Foregone Sequestration Length Sensitivity (NPV, r=2%, T=100 years)



As discussed in detail in Section 2.6.5, annual foregone sequestration was calculated as:

$$\Delta C_{lostseq} = \sum_i (Cseq_{LUbefore,i} - Cseq_{LUafter,i})$$

where:

$\Delta C_{lostseq}$ = change in carbon sequestration in aboveground biomass t C ha⁻¹ yr⁻¹

$Cseq_{LUbefore,i}$ = annual sequestration in aboveground biomass before conversion t C ha⁻¹ yr⁻¹

$Cseq_{LUafter,i}$ = annual sequestration in aboveground biomass after conversion t C ha⁻¹ yr⁻¹

i = type of land use converted to another land use category.

Table 4.9 of the 2006 GL AFOLU was used to estimate the annual sequestration in aboveground forest biomass. The 2006 GL AFOLU provides a sequestration range for typical forest types by continent and ecological zone. The area of forest in each state was stratified by FAO ecozone and continent. This calculation is consistent with 2006 IPCC guidelines, but there are other reasonable methodologies available to estimate foregone sequestration. For example, foregone sequestration could be estimated as a percentage of a forest's initial aboveground biomass. As explained in Section 2.6, we used regional biomass maps to estimate forest carbon stocks in each state. Instead of using Table 4.9 of the 2006 GL AFOLU to estimate annual foregone sequestration, other approaches that were recommended by Winrock included calculating annual lost sequestration as one or two percent of the initial biomass in cleared forests. Figure 2.8-12 compares lifecycle GHG results for soy-based biodiesel using our primary estimate of foregone sequestration, and two other estimates that use one percent and two percent of initial forest biomass.

Figure 2.8-12
Soy-Based Biodiesel Results
Different Foregone Sequestration Calculation Methods
(NPV, r=2%, T=100 years)

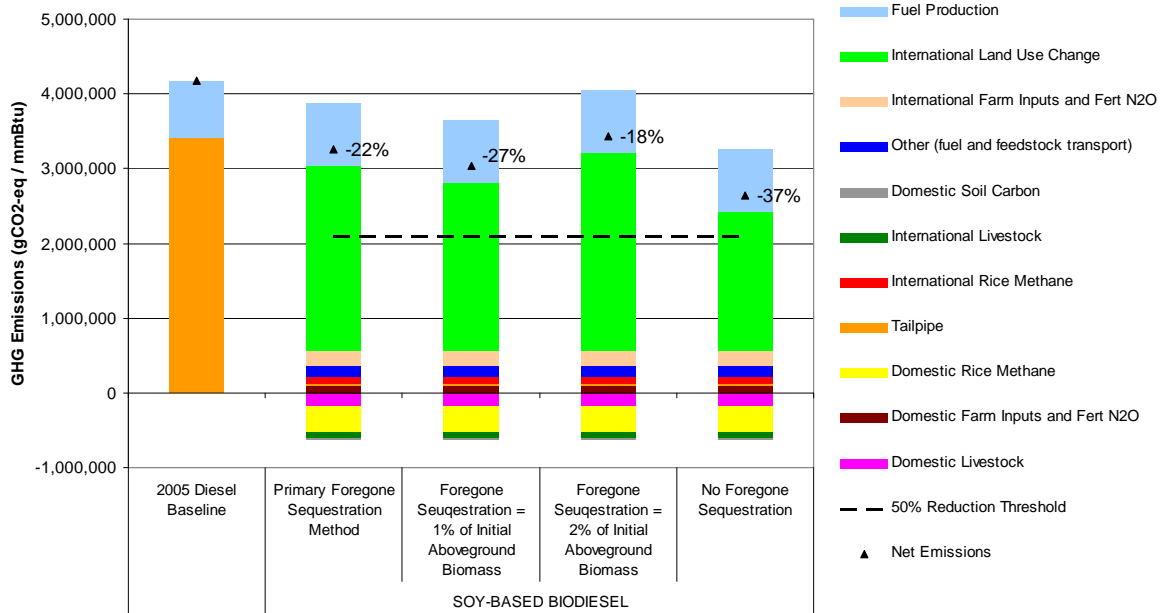

2.8.2.3 Soil Carbon Emissions Sensitivity Analysis

Land in annual crop production holds less soil carbon than lands with undisturbed root systems. A digital soil carbon map of the world available from USDA was used to estimate soil carbon by region.⁵³⁹ Carbon stocks on annual cropland were estimated as 5 metric tons of carbon per hectare based on Table 5.9 of the IPCC AFOLU. Changes in soil carbon stocks on land converted to cropland were calculated based on Section 5.3.3.4 of the IPCC AFOLU. Following the IPCC guidelines, the total difference in soil carbon stocks before and after conversion was averaged over 20 years. (See Section 2.6 for details about methods used to estimate changes in soil carbon stocks).

During the proposed rule making process, EPA received feedback from stakeholders that soil carbon emissions could occur more rapidly than 20 years. To gauge the importance of the timing of soil carbon emissions on our lifecycle, we calculated results assuming that soil carbon emissions occur immediately when land is plowed in preparation for crop production. The timing of soil carbon emissions could influence overall lifecycle GHG results, because, using a NPV approach, near term emissions are weighted more heavily than emissions further into the future. Figure 2.8-13 shows that the timing of soil carbon emissions has a modest impact on lifecycle GHG results for sugarcane ethanol.

**Figure 2.8-13.
Sugarcane Ethanol Results
Soil Carbon Emissions Sensitivity
(NPV, r=2%, T=100 years)**

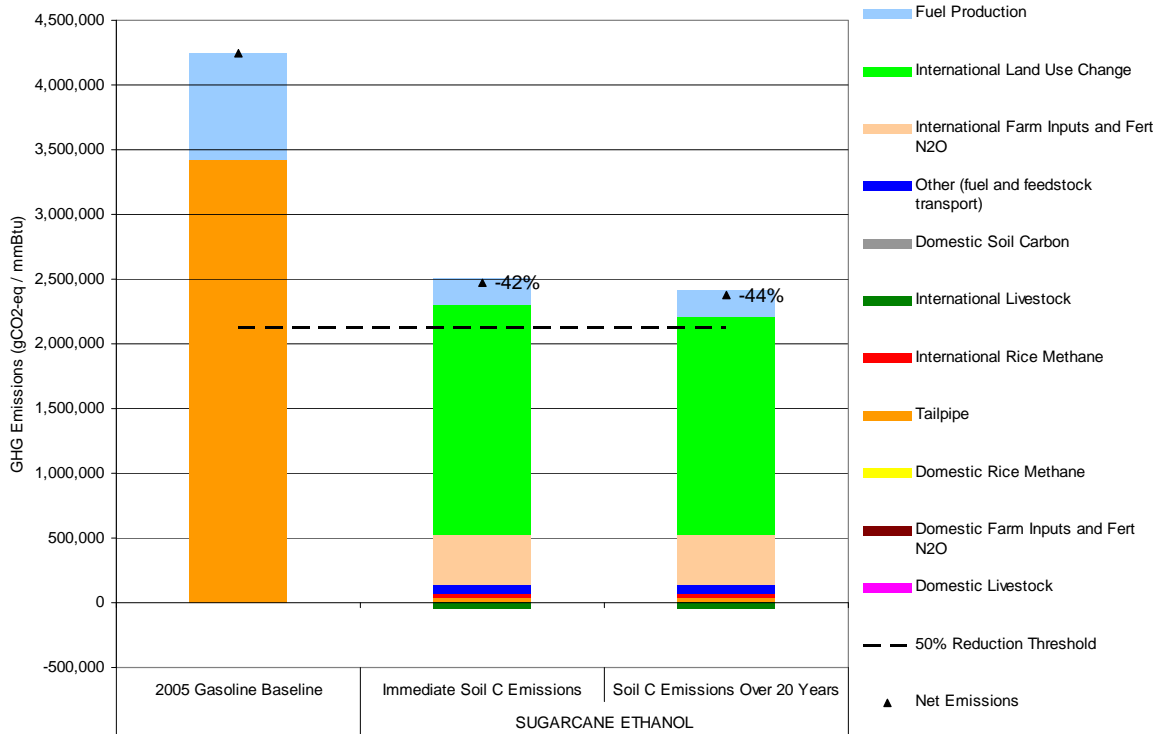

2.8.2.4 Pasture Replacement Sensitivity Analysis

We used a two step methodology to project biofuel induced land use change (See Section 2.6 for a detailed description). The first step includes land use changes associated with cropland expansion. The second step includes land shifting to replace managed pastures that were converted to cropland during the first step. To illustrate the importance of the pasture replacement concept, Figures 2.8-14 and 2.8-15 bound our primary corn ethanol lifecycle GHG results with results that do not include pasture replacement, and results that replace all grassland and savanna (not just managed pastureland) converted to cropland. It is clear that interactions between crop expansion and pasturelands can have a substantial impact on overall lifecycle GHG estimates. For the final rule we intend to conduct additional analysis of the secondary land use effects of converting pasture to crop production.

Figure 2.8-14.
Corn Ethanol Results
Pasture Replacement Sensitivity
(NPV, r=2%, T=100 years)

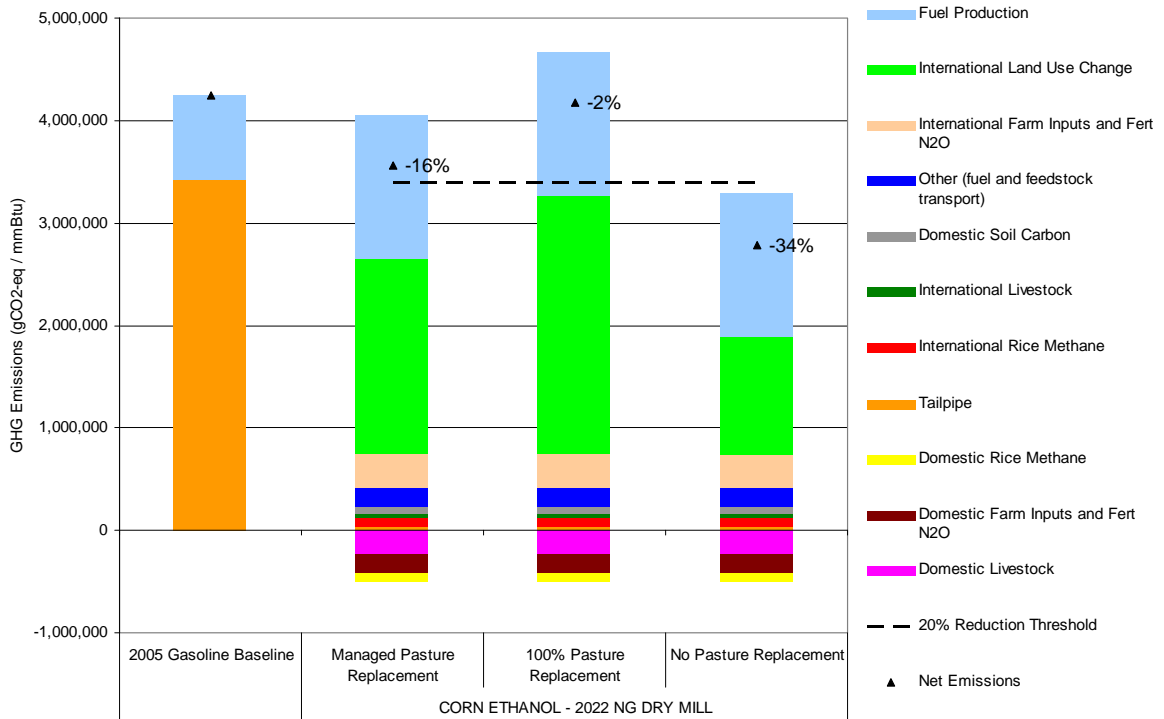

**Figure 2.8-15.
Corn Ethanol Results
Pasture Replacement Sensitivity
(NPV, r=0%, T=30 years)**

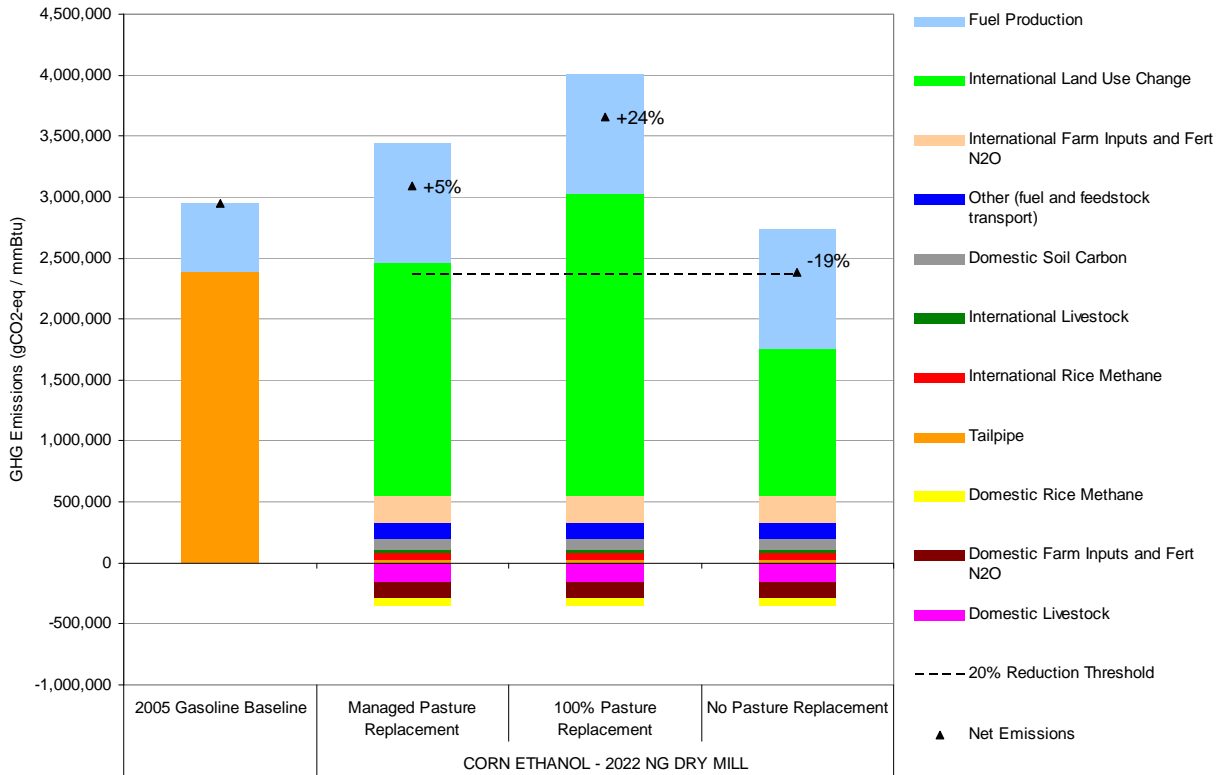

2.8.2.5 Year of Analysis Sensitivity Results

The EISA mandates increasing volumes of U.S. renewable fuel volumes, culminating in 36 billion gallons renewable fuel use in 2022. To estimate the full fuel-specific GHG impacts of the EISA mandates we used 2022 as the primary year for our analysis. To address whether the GHG emissions vary significantly over time, we also analyzed GHG emissions estimates in 2012 and 2017. As shown in Table VI.C.2-3, the GHG emissions reductions are fairly consistent over the time period of our analysis. There may be countervailing forces that stabilize land use change emissions over this period. Crop yields increase over time (therefore reducing land use pressure), but there is also more production of other renewable fuels that require land for feedstock production (therefore increasing land use pressure). The results for 2012 and 2017 used 2022 domestic soil carbon emissions impacts, because of issues with FASOM’s methodology for soil carbon projections. DDDDDDD

DDDDDDDD As discussed in Section 2.6, we are updating FASOM’s domestic soil emissions estimates for the final rule, which should allow for distinct soil carbon estimates in 2012, 2017 and 2022.

**Figure 2.8-16.
Corn Ethanol Results – Year of Analysis Sensitivity
(NPV, r=2%, T=100 years)**

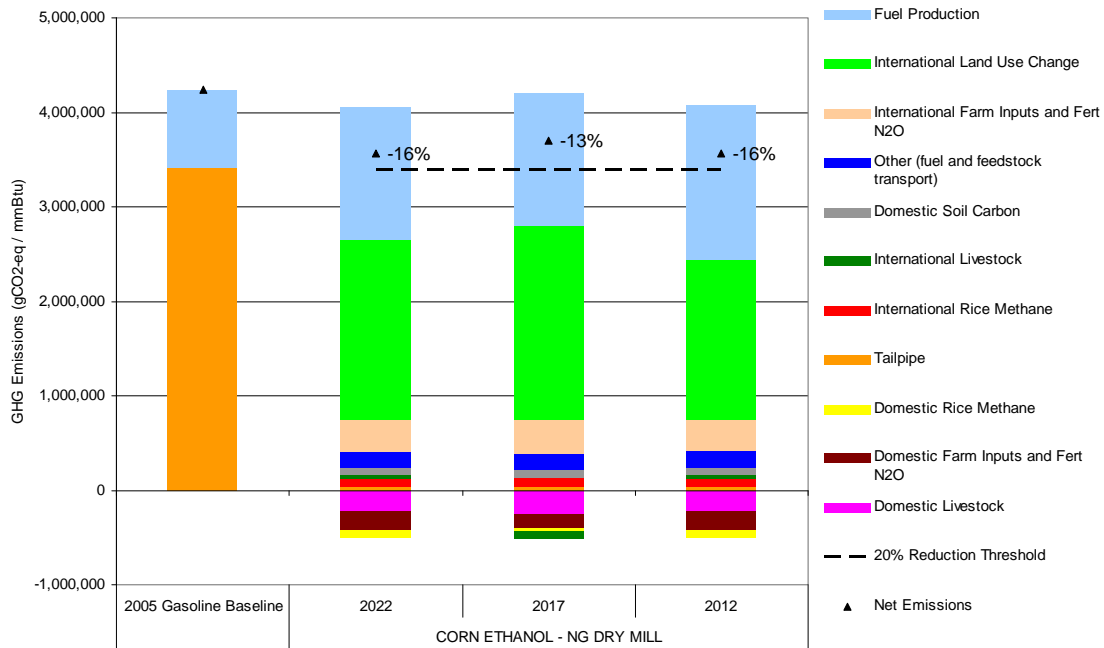

2.8.2.6 Fuel Volumes Modeled Sensitivity Analysis

The renewable fuel volume scenarios used for the proposed rule analysis are described above in Section 2.3.2. We modeled the difference between domestic fuel consumption without EISA and domestic fuel consumption with EISA. For corn ethanol, this meant modeling the difference between 12.4 and 15 billion gallons of domestic corn ethanol consumption in 2022. This approach allowed us to isolate the incremental impacts of the revisions to the RFS program. For the reasons discussed in the preamble for the proposed rule, we believe this is the most relevant analytical approach for RFS2 implementation. However, we also tested the lifecycle GHG impacts of a larger change in corn ethanol volumes. For this sensitivity analysis we estimated lifecycle GHG impacts for an increase in ethanol consumption from 8.7 to 15 billion gallons in 2022.

Figure 2.8-176 includes lifecycle GHG estimates with a lower corn ethanol volume in the reference case. The international land use emissions were very close between the two volume scenarios. In the lower volume reference case (i.e., 8.7 billion gallons in 2022), GHG emissions from domestic farm inputs such as fertilizer did not decrease as much as they did in our primary reference case. The largest difference between the scenarios is that overall livestock GHG emissions increased when we used a lower reference case volume, which is counter to the overall livestock response in our primary estimate. We intend to explore the sensitivity of the fuel volumes modeled in more depth for the final rule.

**Figure 2.8-17.
Corn Ethanol Results
Fuel Volumes Modeled Sensitivity
(NPV, r=2%, T=100 years)**

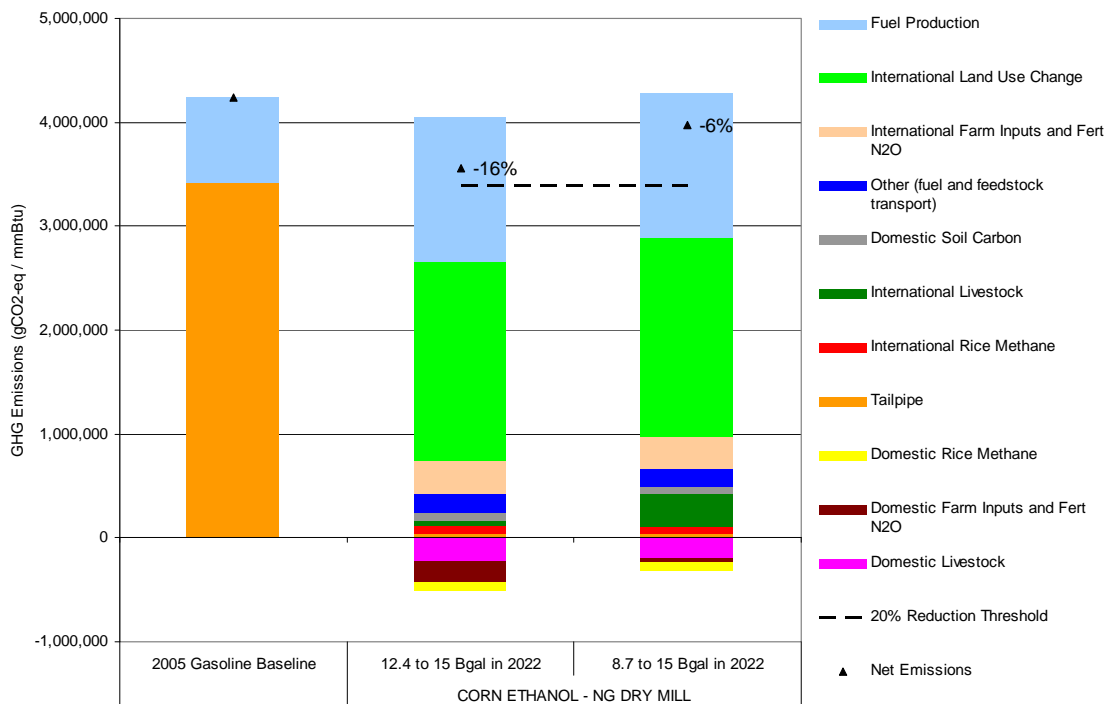

2.8.3 Fuel-Specific Results Conclusions

In addition to providing lifecycle GHG emissions estimates, EPA’s lifecycle analysis for the proposed rule highlights the importance of several key elements:

- The time horizon for analysis;
- The choice of discount rate;
- The types of land cleared to make room for cropland expansion;
- Interactions between cropland expansion and pasture area; and
- The size of renewable fuel volume increases.

The proposed rule is an important opportunity for EPA to solicit feedback on these and other issues that will improve and solidify our analysis before final rulemaking. For more information about our lifecycle GHG analysis, we have placed spreadsheets with all of our calculations and results on the docket for this rulemaking.

2.9 Overall Lifecycle Greenhouse Gas Emissions Results of Rulemaking Volume

Our analysis of the overall GHG emission impacts of this proposed rulemaking was performed in parallel with the lifecycle analysis performed to develop the individual fuel thresholds described in previous sections. The same system boundaries apply such that this analysis includes the effects of three main areas: a) emissions related to the production of biofuels, including the growing of feedstock (corn, soybeans, etc.) with associated domestic and international land use change impacts, transport of feedstock to fuel production plants, fuel production, and distribution of finished fuel; b) emissions related to the extraction, production and distribution of petroleum gasoline and diesel fuel that is replaced by use of biofuels; and c) difference in tailpipe combustion of the renewable and petroleum based fuels. As discussed in the previous section we will be updating our lifecycle approach for the final rule and there are some areas that we were not able to quantify at this time, such as secondary impacts in the energy sector. We are working to include this for our final rule analysis.

Consistent with the fuel volume feasibility analysis and criteria pollutant emissions evaluation, our analysis of the GHG impacts of this proposed rulemaking was conducted by comparing the difference between a 2022 reference case and a 2022 control case with volumes of renewable fuels meeting the RFS2 mandate. Similar to what was done to calculate lifecycle thresholds for individual fuels we considered the change in 2022 of these two volume scenarios of renewable fuels to determine overall GHG impacts of the rule. The reference case for the GHG emission comparisons was taken from the AEO 2007 projected renewable fuel production levels for 2022 prior to enactment of EISA. This scenario provided a point of comparison for assessing the impacts of the RFS2 standard volumes on GHG emissions. We ran these multi fuel scenarios through our FASOM and FAPRI models and applied the Winrock land use change assumptions to determine to overall GHG impacts of producing this increase in renewable fuels.

The main differences between this overall impacts analysis and the analysis conducted to develop the threshold values for the individual fuels were that we analyzed the total change in renewable fuels in one scenario as opposed to looking at individual fuel impacts. When analyzing the impact of the total 36 billion gallons of renewable fuel, we also took into account the agricultural sector interactions necessary to produce the full complement of feedstock. Figure 2.9-1 shows the different scenarios considered in this analysis.

**Figure 2.9-1.
Fuel Volume Scenario Considered to Determine GHG Impact of
Proposed Rulemaking**

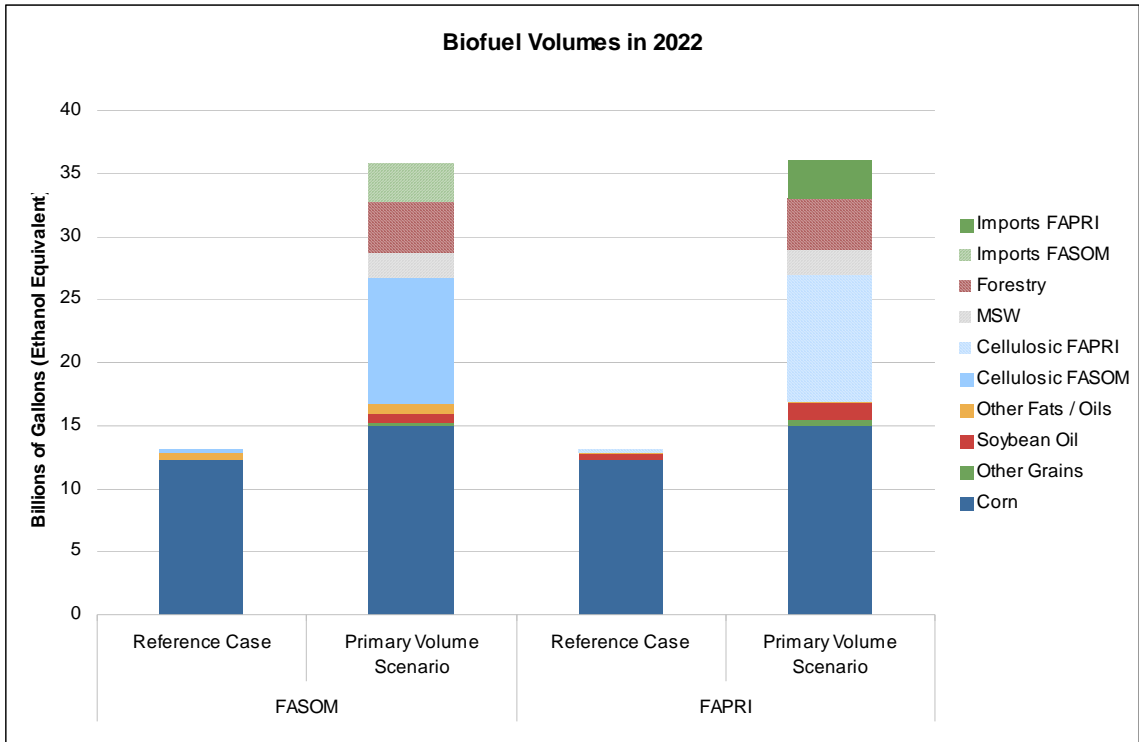

As discussed in Chapter 5, certain types of fuels and feedstocks are not specifically captured in the models, for example MSW and forestry feedstocks are not explicitly modeled in FASOM while cellulosic ethanol in general is not explicitly modeled in FAPRI. Also, imports are not explicitly modeled in FASOM but are included in FAPRI modeling.

We also considered a mix of plant types and configurations for the 2022 renewable fuel production representing the mix of plants we project to be in operation in 2022. The following table shows the types of plants considered in the analysis for the references and control cases.

Table 2.9-1. Types of Plants Considered in 2022

Plant Type	Technology	Volume of Fuel (Bgal)		
		Reference Case	Control Case	Difference
Corn Ethanol – Dry Mill	Plant with NG (dry DG)	7.19	8.77	1.58
	Plant with NG (wet DG)	2.62	3.25	0.63
	Plant with coal (dry DG)	1.11	1.17	0.06
	Plant with coal (wet DG)	0.11	0.10	-0.01
	Plant with biomass(dry DG)	0.09	0.19	0.09
	Plant with biomass (wet DG)	0.12	0.14	0.01
Corn Ethanol – Wet Mill	Plant with NG	0.00	0.16	0.16
	Plant with coal	1.30	1.23	-0.06
Cellulosic Ethanol – Enzymatic	Switchgrass feedstock & lignin used as fuel	0.00	1.28	1.28
	Corn stover feedstock & lignin used as fuel	0.25	8.80	8.55
Cellulosic Ethanol – Thermochemical	Forest waste feedstock	0.00	5.92	5.92
Biodiesel	Soybean oil feedstock	0.37	0.79	0.41
	Yellow grease / tallow feedstock	0.01	0.02	0.01
Renewable Diesel	Yellow grease / tallow feedstock	0.00	0.38	0.38
Imports	Brazilian Sugarcane Ethanol	0.64	3.14	2.50

The upstream feedstock production and processing impacts for each of the different fuel technologies were modeled based on the same assumptions used in determining the per fuel lifecycle GHG results described in previous sections.

For this overall impacts analysis we also used a different petroleum baseline fuel that is offset from renewable fuel use. The lifecycle threshold values are required by EISA to be based on a 2005 petroleum fuel baseline. For this analysis of the overall impacts of the rule we considered the crude oil and finished product that would be replaced in 2022.

Displaced petroleum product analysis was consistent with work performed for the energy security analysis described in Chapter 15. For this analysis we consider that 25% of displaced gasoline will be imported gasoline and 0% of displaced diesel fuel will be imported diesel fuel.

For the types of gasoline displaced we assume 65% of the displaced gasoline will be conventional gasoline and 35% will be RFG blendstock gasoline. We assume 100% of the displaced diesel fuel will be low sulfur diesel fuel.

In order to come up with GHG emissions for average crude oil used in producing gasoline and diesel fuel in 2022 we assumed 7.6% would be from tar sands and 3.8% would be from Venezuelan heavy crude. The basis for this was EIA projections for 2022⁵⁴⁰. EIA projects that roughly 64% of total Canadian crude oil production will be oil sand production in 2022, and that roughly 40% of total Venezuelan crude oil production will be heavy crude production in 2022. EIA also has assumptions on how much crude oil will be imported into the U.S. from

Canada and Venezuela in 2022. We assumed the percentage of this imported Canadian and Venezuelan crude oil that would be oil sands and heavy oil was the same percentage of total production that is unconventional crude in those countries (~64% for Canada and ~41% for Venezuela). Based on the percent of Canadian and Venezuelan imports to total crude oil projected in 2022, oil sands represented 7.6% and heavy oil represented 3.8% of total crude oil use.

For this analysis we did not assume any efficiency improvements at the petroleum refining portion of the gasoline and diesel fuel lifecycle. Therefore the same refining energy use and emissions was assumed that was used to represent the 2005 petroleum fuel baseline. On the one hand this may be overestimating energy use and emission from petroleum refining, however, this also does not factor in recent regulations that might increase energy use and emissions, such as increased desulfurization of both gasoline and diesel fuel.

Furthermore, the tailpipe emissions changes were determined based on the specific volumes and blends of fuel considered as opposed to looking at only the difference between the renewable fuel and petroleum fuel replaced. For highway vehicles, the impact of this rule on Methane (CH₄) and Nitrous Oxide (N₂O) emissions is primarily due to vehicles switching from gasoline to E85 fuel. Based on available data, we projected no change in N₂O or CH₄ emissions from highway vehicles that switched from conventional gasoline to E10. For diesel highway vehicles, emissions of N₂O and CH₄ are almost one hundred times less than emissions from gasoline vehicles,⁵⁴¹ thus diesels were omitted from this analysis.

E85 effects for this analysis based on available emission data from EPA's certification program, testing performed by EPA as part of the Mobile Source Air Toxic (MSAT) rulemaking, and a recent study performed by Environment Canada [insert reference]. This analysis found that on a per-vehicle basis using E85 resulted in a 56 percent decrease in N₂O emissions and a 123 percent increase in CH₄ emissions.

To estimate the inventory-wide impact, we used MOVES to model CH₄ and N₂O for highway gasoline vehicles using reference case fuels. Because MOVES does not vary CH₄ and N₂O emissions by temperature or by gasoline fuel properties, the model was run at the annual, national level. The control case was modeled by computing an E85 factor for each model year and vehicle type that was the product of the proportion of FFV fuel that is E85 and the proportion of FFVS in that model year, as described in Chapter 1. FFV use was assumed to be limited to light duty cars and light duty trucks. We multiplied the appropriate E85 factor by the emissions for that model year and then computed a weighted average of E85 and E10 emissions for both CH₄ and N₂O. In order to compare the results in a meaningful way, we also computed the CO₂ equivalent by multiplying the tons for each pollutant by the Global Warming Potential (310 for N₂O, 21 for CH₄⁵⁴²) and summing the products. The results are summarized in Table 2.21 below.

Table 2.9-2. Tailpipe Nitrous Oxide and Methane Emissions in 2022

	Pollutant	Reference Case Tons	Control Case Tons	Percent Change
LDGV & LDGT	N2O	31,447	29,191	-7%
	CH4	50,683	61,853	22%
	CO2 equiv.	10,812,803	10,348,003	-4%
All Gasoline Highway Vehicles	N2O	33,997	31,741	-7%
	CH4	55,277	66,447	20%
	CO2 equiv.	11,699,809	11,235,009	-4%

Given these many differences, it is clearly not possible to simply add up the individual lifecycle results determined in Section 2.8 multiplied by their respective volumes to assess the overall rule impacts. The two analyses are separate in that the overall rule impacts capture interactions between the different fuels but can not be broken out into per fuels impacts, while the threshold values represent impacts of specific fuels but do not account for all the interactions.

For example, when we consider the combined impact of the different fuel volumes the overall land use change is greater than when considering fuel independently, as shown in Table 2.9-3.

Table 2.9-3. Comparison of International Land Use Change ('000 Acres)

	Considering Only Change in Soybean Based Biodiesel Fuel Volumes	Considering Only Change in Corn Ethanol Fuel Volumes	Considering Only Change in Brazilian Sugarcane Ethanol Fuel Volumes	Considering Change of all Fuel Volumes Combined
Land Use Change	880	4,400	3,684	9,867

The primary reason for the difference in acre change between the sum of the individual fuel scenarios and the combined fuel scenarios is that when looking at individual fuels there is some interaction between different crops (e.g., corn replacing soybeans), but with combined volume scenario when all mandates need to be met there is less opportunity for crop replacement (e.g., both corn and soybean acres needed) and therefore more land is required.

Overall rule impacts were determined for the different components of the lifecycle analysis as described in previous sections. The domestic agricultural sector impacts include changes in energy use GHG emissions and fertilizer / soil N2O emissions as well as changes in livestock and rice production GHG emissions.

Our analysis indicates that overall domestic agriculture emissions would increase. There is a relatively small increase in total domestic crop acres however, there are additional inputs required due to the removal of crop residues. The assumption is that removal will require more inputs to make up for lost residue nutrients. These additional inputs result in GHG emissions

from production and from N₂O releases from application. This effect is somewhat offset by reductions due to lower livestock production. These results are dependent on our agricultural sector input and emission assumptions that are being updated for the final rule (e.g., N₂O emission factor work).

As with domestic agriculture impacts, the international agricultural sector impacts include changes in energy use GHG emissions and fertilizer / soil N₂O emissions as well as changes in livestock and rice production GHG emissions.

Increased crop production internationally resulted in increased fertilizer and fuel use emissions, however, these are offset by reductions in livestock GHG emissions. Higher commodity crop prices internationally are resulting in lower livestock production internationally.

We estimate the largest overall agricultural sector impact is an increase in land use change impacts, reflecting the shift of crop production both domestically and internationally to meet the biofuel demand in the U.S., and land use change emissions associated with converting land into crop production.

Domestic soil carbon change impacts are negative reflecting the soil carbon changes associated with crop shifting and production. There are several factors impacting this result, switchgrass has a large benefit in terms of soil carbon and carbon sequestration. Residue removal is greater on low and no till cropping management practices, and larger removal rates shift to some of these practices and result in increased soil carbon sequestration. However, land use change impacts are dominated by the international acreage and land use change increase.

Other portions of the biofuel lifecycle include fuel production and feedstock and fuel transport. We project reductions in GHG emissions from the renewable fuel production portion of the lifecycle due to the generation of electricity along with the increased production of cellulosic ethanol. A large portion of the cellulosic ethanol production is assumed to be produced through the enzymatic process which also produces excess electricity to be sold to the grid. This excess electricity is offsetting grid electricity production and results in GHG benefits. Cellulosic biofuels contribute by far the most to the total emission reductions due to both their superior per gallon emission reductions and the large volume of these fuels anticipated to be used by 2022. Process emission reductions are partially offset by both feedstock and fuel transportation emissions.

CO₂ produced in the combustion of biofuels is offset by the uptake of CO₂ in the biomass crop used to produce the fuel, resulting in a significant net reduction of CO₂ compared to fossil fuel tailpipe combustion. Net carbon fluxes from changes in biogenic carbon reservoirs in wooded or crop lands associated with land use change are accounted for in the domestic and international agriculture impacts shown in upstream impacts. In addition we assume biofuel use is offsetting petroleum fuel production which also results in GHG emissions reductions from reduced upstream emissions of petroleum fuel production (crude oil extraction and transport, refining, transport).

The results of the individual lifecycle stage results can be summed to determine the overall GHG impact of the proposed rulemaking. As discussed in previous sections on lifecycle GHG thresholds there is an initial one time release from land conversion and smaller ongoing releases but there are also ongoing benefits of using renewable fuels over time replacing petroleum fuel use. Figure 2.9-2 shows the GHG emissions impact of the change in fuel volumes considered over time.

Figure 2.9-2. GHG Impacts over time

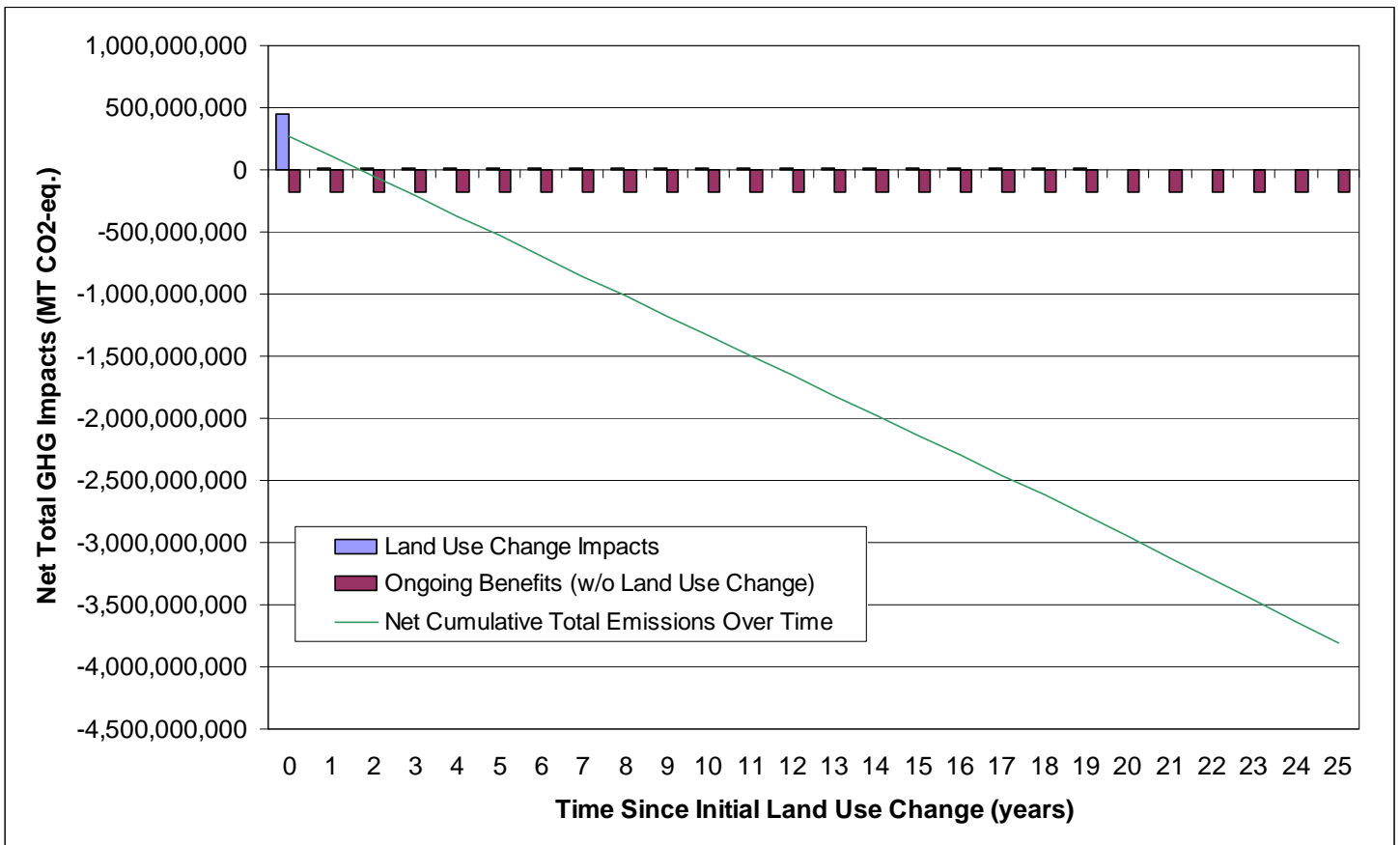

Based on the volume scenario considered the one time land use change impact results in 448 million metric tons of CO₂-eq. emissions. There are however, based on the biofuel use replacing petroleum fuels, annual reduction benefits of 161 million metric tons of CO₂-eq. emissions. This results in a less than two year payback period before the ongoing benefits of the biofuels use offsets the initial land use impacts.

The timing of the impact of land use change and ongoing renewable fuels benefits were discussed in the previous lifecycle results section. The issue is slightly different for this analysis since we are considering absolute tons of emissions and not determining a threshold comparison to petroleum fuels. However the results can be presented in a similar manner to our individual fuels analysis in that we can determine net benefits over time with different discount rates and over a different time frame for consideration.

If we consider a 2% discount rate and 100 years of benefits (i.e., 161 million tons of GHG emissions reductions per year) we get an estimated discounted NPV reduction in GHG emissions of 6.8 billion tons of GHG emissions. Assuming a 0% discount rate over 30 years would result in an estimate of 4.5 billion tons of discounted GHG emission reductions.

Furthermore, for the calculations of the monetized GHG benefits we calculate an annualized NPV GHG reduction. This annualized value is based on converting a lump sum present value into its annualized equivalent. For this analysis we convert the NPV results for the 100 year 2% discount rate into an annualized stream such that the NPV of the annualized emissions will equal the NPV of the emission stream over 100 years with a 2% discount rate. This results in an annualized emission reduction of 160 million metric tons of CO₂-eq. emissions. With a 30 year time horizon and 0% discount rate the annualized emission reduction is 150 million metric tons CO₂-eq.

2.10 Effects of GHG Emission Reductions and Changes in Global Temperature and Sea Level

2.10.1 Introduction

The reductions in CO₂ and other GHGs associated with the proposal will affect climate change projections. Because GHGs mix well in the atmosphere and have long atmospheric lifetimes, changes in GHG emissions will affect future climate for decades to centuries. One common indicator of climate change is global mean surface temperature. This section estimates the response in global mean surface temperature and sea level rise projections to the estimated net global GHG emissions reductions associated with the Proposed Rulemaking (See Section 2.9) for the estimated net reductions in global emissions over time by GHG).

2.10.2 Estimated Projected Reductions in Global Mean Surface Temperatures

EPA estimated changes in projected global mean surface temperatures to 2100 using the MiniCAM (Mini Climate Assessment Model) integrated assessment model^{EEEEEEEE} coupled with the MAGICC (Model for the Assessment of Greenhouse-gas Induced Climate Change) simple

^{EEEEEEEE} MiniCAM is a long-term, global integrated assessment model of energy, economy, agriculture and land use, that considers the sources of emissions of a suite of greenhouse gases (GHG's), emitted in 14 globally disaggregated global regions (i.e., U.S., Western Europe, China), the fate of emissions to the atmosphere, and the consequences of changing concentrations of greenhouse related gases for climate change. MiniCAM begins with a representation of demographic and economic developments in each region and combines these with assumptions about technology development to describe an internally consistent representation of energy, agriculture, land-use, and economic developments that in turn shape global emissions. Brenkert A, S. Smith, S. Kim, and H. Pitcher, 2003: Model Documentation for the MiniCAM. PNNL-14337, Pacific Northwest National Laboratory, Richland, Washington. For a recent report and detailed description and discussion of MiniCAM, see Clarke, L., J. Edmonds, H. Jacoby, H. Pitcher, J. Reilly, R. Richels, 2007. Scenarios of Greenhouse Gas Emissions and Atmospheric Concentrations. Sub-report 2.1A of Synthesis and Assessment Product 2.1 by the U.S. Climate Change Science Program and the Subcommittee on Global Change Research. Department of Energy, Office of Biological & Environmental Research, Washington, DC., USA, 154 pp.

climate model.^{FFFFFFF} MiniCAM was used to create the globally and temporally consistent set of climate relevant variables required for running MAGICC. MAGICC was then used to estimate the change in the global mean surface temperature over time. Given the magnitude of the estimated emissions reductions associated with the proposed rule, a simple climate model such as MAGICC is reasonable for estimating the climate response.

EPA applied the estimated annual GHG emissions changes for the proposal to the MiniCAM U.S. Climate Change Science Program (CCSP) Synthesis and Assessment Product baseline emissions. Specifically, the CO₂, N₂O, and CH₄ annual emission changes from 2022-2121 from Section 2.9 were applied as net reductions to the MiniCAM CCSP global baseline net emissions for each GHG. Post-2121, we assumed no change in emissions from the baseline. This assumption is more conservative than allowing the emissions reductions to continue.

Table 2.10-1 provides our estimated reductions in projected global mean surface temperatures and sea level associated with the proposed increase in renewable fuels in 2022. To capture some of the uncertainty in the climate system, we estimated the changes in projected temperatures and sea level across the most current Intergovernmental Panel on Climate Change (IPCC) range of climate sensitivities, 1.5°C to 6.0°C.^{GGGGGGG} To illustrate the time profile of the estimated reductions in projected global mean surface temperatures and sea level, we have also provided Figures 2.10-1 and 2.10-2.

^{FFFFFFF} MAGICC consists of a suite of coupled gas-cycle, climate and ice-melt models integrated into a single framework. The framework allows the user to determine changes in GHG concentrations, global-mean surface air temperature and sea-level resulting from anthropogenic emissions of carbon dioxide (CO₂), methane (CH₄), nitrous oxide (N₂O), reactive gases (e.g., CO, NO_x, VOCs), the halocarbons (e.g. HCFCs, HFCs, PFCs) and sulfur dioxide (SO₂). MAGICC emulates the global-mean temperature responses of more sophisticated coupled Atmosphere/Ocean General Circulation Models (AOGCMs) with high accuracy. Wigley, T.M.L. and Raper, S.C.B. 1992. Implications for Climate and Sea-Level of Revised IPCC Emissions Scenarios *Nature* 357, 293-300. Raper, S.C.B., Wigley T.M.L. and Warrick R.A. 1996. in *Sea-Level Rise and Coastal Subsidence: Causes, Consequences and Strategies* J.D. Milliman, B.U. Haq, Eds., Kluwer Academic Publishers, Dordrecht, The Netherlands, pp. 11-45. Wigley, T.M.L. and Raper, S.C.B. 2002. Reasons for larger warming projections in the IPCC Third Assessment Report J. Climate 15, 2945-2952.

^{GGGGGGG} In IPCC reports, equilibrium climate sensitivity refers to the equilibrium change in the annual mean global surface temperature following a doubling of the atmospheric equivalent carbon dioxide concentration. The IPCC states that climate sensitivity is “likely” to be in the range of 2°C to 4.5°C and described 3°C as a “best estimate.” The IPCC goes on to note that climate sensitivity is “very unlikely” to be less than 1.5°C and “values substantially higher than 4.5°C cannot be excluded.” IPCC WGI, 2007, *Climate Change 2007 - The Physical Science Basis*, Contribution of Working Group I to the Fourth Assessment Report of the IPCC, <http://www.ipcc.ch/>.

**Table 2.10-1.
Estimated Reductions in Projected Global Mean Surface Temperature and Global Mean Sea Level from Baseline in 2030, 2050, 2100, and 2200 for the Proposed Standard in 2022**

	Climate sensitivity				
	1.5	2	3	4.5	6
Change in global mean surface temperatures (degrees Celsius)					
2030	0.000	0.000	-0.001	-0.001	-0.001
2050	-0.001	-0.002	-0.002	-0.002	-0.003
2100	-0.003	-0.004	-0.005	-0.006	-0.007
2200	-0.003	-0.004	-0.006	-0.008	-0.009
Change in global mean sea level rise (centimeters)					
2030	-0.002	-0.002	-0.003	-0.003	-0.003
2050	-0.012	-0.014	-0.017	-0.020	-0.022
2100	-0.045	-0.052	-0.063	-0.074	-0.082
2200	-0.077	-0.091	-0.114	-0.143	-0.172

The results in Table 2.10-1 and Figures 2.10-1 and 2.10-2 show small, but detectable reductions in the global mean surface temperature and sea level rise projections across all climate sensitivities. Overall, the reductions are small relative to the IPCC’s “best estimate” temperature increases by 2100 of 1.8°C to 4.0°C.^{HHHHHHHHH} Although IPCC does not issue “best estimate” sea level rise projections, the model-based range across SRES scenarios is 18 to 59 cm by 2099.^{IIIIII} Both figures illustrate that the overall emissions reductions can decrease projected annual temperature and sea level for all climate sensitivities. This means that the distribution of potential temperatures in any particular year is shifting down. However, the shift is not uniform. The magnitude of the decrease is larger for higher climate sensitivities. Thus, the probability of a higher temperature or sea level in any year is lowered more than the probability of a lower temperature or sea level. For instance, in 2100, the reduction in projected temperature for climate sensitivities of 3 and 6 is approximately 65% and 140% greater than the reduction for a climate sensitivity of 1.5. This difference grows over time, to approximately 80% and 185% by 2200. The same pattern appears in the reductions in the sea level rise projections.^{JJJJJJJ} Also noteworthy in Figures 2.10-1 and 2.10-2, is that the size of the decreases grows over time due to the cumulative effect of a lower stock of GHGs in the atmosphere (i.e., concentrations).^{KKKKKKKK}

^{HHHHHHHHH} IPCC WGI, 2007. The baseline increases by 2100 from our MiniCAM-MAGICC runs are 2°C to 5°C for global mean surface temperature and 35 to 74 centimeters for global mean sea level.

^{IIIIII} “Because understanding of some important effects driving sea level rise is too limited, this report does not assess the likelihood, nor provide a best estimate or an upper bound for sea level rise.” IPCC Synthesis Report, p. 45
^{JJJJJJJ} In 2100, the reduction in projected sea level rise for climate sensitivities of 3 and 6 is approximately 40% and 80% greater than the reduction for a climate sensitivity of 1.5. This difference grows over time, to approximately 50% and 120% by 2200.

^{KKKKKKKK} For global average temperature after 2100, the growth in the size of the decrease noticeable slows. This is because the emissions changes associated with the policy were only estimated for 100 years. Note that even with emissions reductions stopping after 100 years, there continues to be a decrease in projected temperatures due to reduced inertia in the climate system from the earlier emissions reductions. However, unlike temperature, after 2100,

The bottom line is that the risk of climate change is being lowered, as the probabilities of any level of temperature increase and sea level rise are reduced and the probabilities of the largest temperature increases and sea level rise are reduced even more. For the Final Rulemaking, we hope to more explicitly estimate the shapes of the distributions and the estimated shifts in the shapes in response to the Rulemakings.

Figure 2.10-1
Estimated Projected Reductions in Global Mean Surface Temperatures across
Climate Sensitivities (CS) for the Proposed Standard in 2022

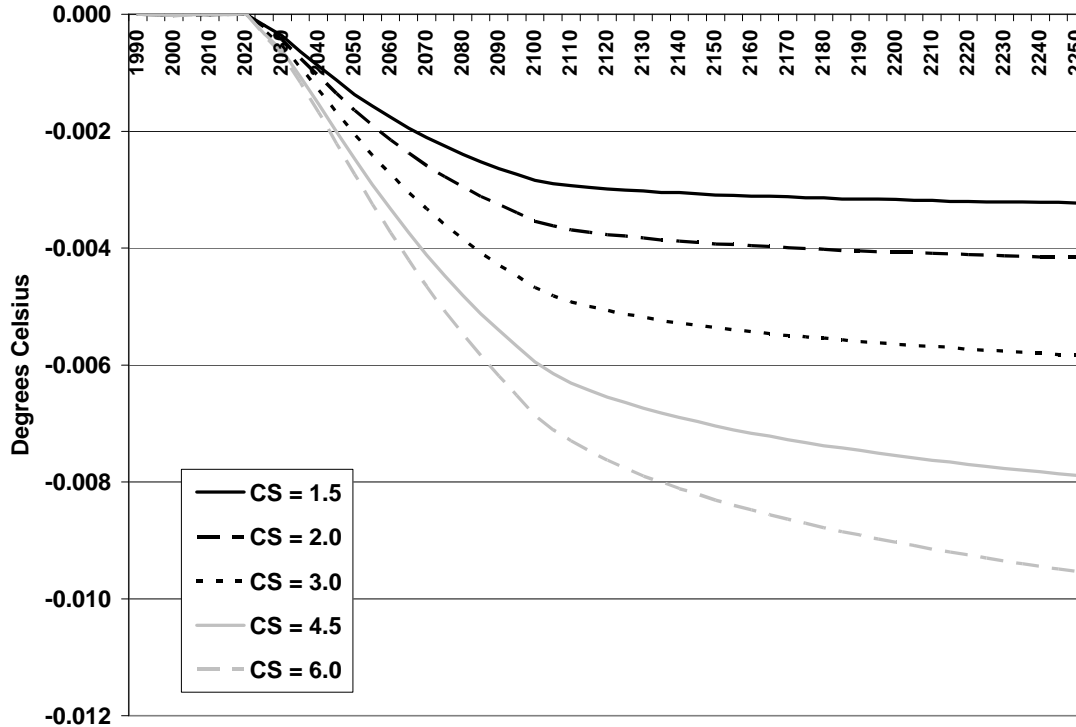

the size of the decrease in sea level rise increases as the projected reduction in warming has a continued effect on ice melt and ocean thermal expansion.

Figure 2.10-2
Estimated Projected Reductions in Global Mean Sea Level across Climate Sensitivities (CS) for the Proposed Standard in 2022

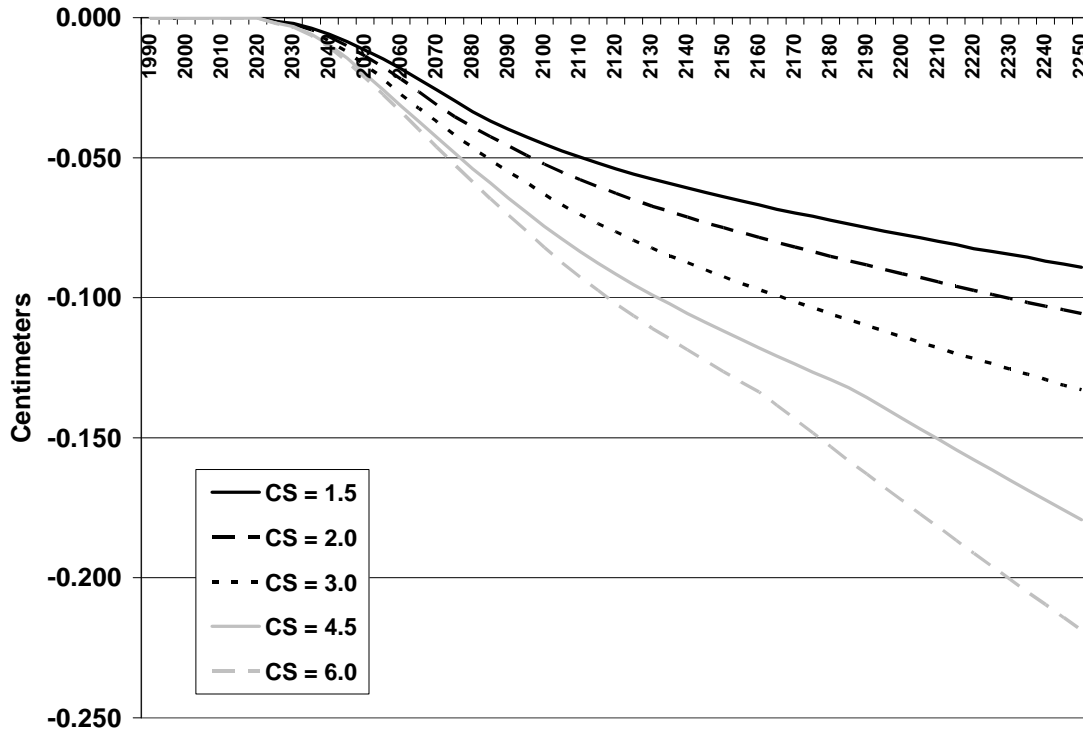

Chapter 3: Impacts of the Program on Non-GHG Pollutants

In addition to the GHG impacts laid out in Chapter 2, we project that today's proposal will affect emissions of "criteria" pollutants (those pollutants for which a National Ambient Air Quality Standard has been established), criteria pollutant precursors, and air toxics. Changes in these emissions would derive from the direct effect of renewable fuels on the tailpipe and evaporative emissions of vehicles and off-road equipment; and increased renewable fuel production and distribution including the effect of decreases in the production and distribution of gasoline and diesel displaced by renewable fuel. For today's proposal we have focused on estimating the change in mass emissions for these pollutants across the entire U.S. in 2022, when the program is fully implemented; for the final rule we plan to conduct full-scale air quality modeling and health impact assessment as well. This chapter presents national emission impacts for nitrogen oxides (NO_x), volatile organic compounds (VOC), carbon monoxide (CO), particulate matter 10 microns in diameter and less (PM₁₀), particulate matter 2.5 microns in diameter and less (PM_{2.5}), sulfur dioxide (SO₂), ammonia (NH₃), benzene, 1,3-butadiene, acrolein, formaldehyde, acetaldehyde, naphthalene, and ethanol. This chapter also presents the methodology for developing these estimates and discusses air quality and health impacts qualitatively.

3.1 Methodology for Calculating Non-GHG Emission Impacts

Our analysis focused on the projected impact of today's proposed action in 2022, the first full year of implementation. The impacts of the program were quantified as the difference in mass emissions between the proposed volumes and several reference cases, as presented in Section 3.2. In order to allow assessment of total emission impacts of mandated renewable volumes, the main reference case presented in this analysis was the RFS1 mandate volume of 7.5 billion gallons of renewable fuel (6.7 billion gallons ethanol). We are also presenting impacts relative to the roughly 14 billion gallons of renewable fuels projected by the Department of Energy (DOE) Annual Energy Outlook (AEO) 2007 (summarized in Table V.A.1-1 of the Preamble to today's proposal) to show the impact of today's action incremental to the projected renewable market pre-EISA. Finally, we also present impacts relative to the pre-RFS1 baseline of roughly 4 billion gallons renewable fuel. Due to time constraints, for the proposed rule we did not perform separate modeling runs for each reference case. Rather, we focused our modeling on the impacts between the AEO reference case and control case, and scaled our estimates of national emissions based on the volumes of ethanol. For the final rule inventories and air quality work we intend to model two of these reference cases - RFS1 mandate and AEO.

Our analysis of non-GHG emissions impacts was comprised of a) an analysis of direct impacts on motor vehicles, off-road equipment and other sources from burning (or evaporating) renewable fuels in place of petroleum-based fuels; and b) the emissions impacts from the production and distribution of renewable fuels. These analyses are discussed separately in Sections 3.1.1 and 3.1.2.

3.1.1 Impact on Non-GHG Emissions from Motor Vehicles and Equipment

Today's proposed volumes of renewable fuel will directly affect emissions from most mobile source categories, and for this analysis we have quantified the effects on exhaust and evaporative emissions of gasoline-fueled vehicles and equipment including passenger cars, light trucks, heavy trucks, motorcycles and off-road sources such as lawn mowers, recreational boats and all-terrain vehicles. We have also estimated the impact of ethanol on emissions from portable fuel containers, and increased refueling emissions due to higher volatility of ethanol-blended fuel and increased refueling events due to lower energy content of biofuels. The emissions impacts of biodiesel were also estimated on heavy-duty diesel vehicles, assuming additional biodiesel would be burned by on-road sources.

A considerable source of uncertainty in estimating the emission impacts of renewable fuels is the effect ethanol blends will have on emissions of cars and light trucks. Under today's proposed action every gasoline vehicle and piece of equipment would be fueled on at least E10, and with the volumes of E85 projected necessary to meet today's mandate, we estimate that, on average, flexible fueled vehicles with access to E85 would need to be using E85 about 74 percent of the time. The impacts of E10 emissions have been studied for years, but current data on newer technology vehicles is not definitive on its impact on NO_x and exhaust VOC emissions. Data on E85 is limited, and the results show large variability of emission effects in some pollutants. EPA is in the midst of a large-scale emission testing program to improve our understanding of fuel effects on Tier 2 cars and trucks, and we expect our analysis for the final rule to reflect the results of this program.⁵⁴³ In the meantime, in order to help bound the uncertainty of exhaust fuel effects, we calculated emissions impacts for two vehicle fuel effects scenarios as detailed in Section 3.1.1.2.

EPA is in the process of updating its mobile source emission platform to the Motor Vehicle Emissions Simulator (MOVES). For the analysis of gasoline-fueled highway vehicles, a pre-draft version of MOVES was used to generate national inventories based on the fuel supply scenarios determined for the RFS2. Although the model is not complete, we decided to use a pre-release version of MOVES for this analysis to begin to reflect significant updates in emissions from MOBILE6. As the other mobile source categories in MOVES were still under development at the time of this analysis, onroad diesel vehicles and all off-road equipment emissions were calculated with the National Mobile Inventory Model (NMIM) model, a platform which generates emission inventories based on EPA's MOBILE6 and NONROAD models.

The development of vehicle and equipment emission impact estimates for today's proposal required: a) developing fuel supply inputs at the county level for the 2005 base year and 2022 reference and control cases which accounted for the projected change in fuel properties due to today's proposed action; b) developing individual vehicle fuel effects; and c) running MOVES and NMIM to produce raw inventory estimates and post-processing these results as needed to account for different baselines, to apply "off model" corrections, or to estimate impacts not accounted for in the models. Each of these steps are detailed in the following sections

3.1.1.1 Fuel Inputs

As inputs to our emissions modeling, we developed a detailed profile of fuels for each modeling case. We prepared county-level databases of fuel properties and fuel market shares for the 2005 base case and the 2022 AEO reference case and 2022 control case. These county-level databases were applied in both NMIM and MOVES for consistency in fuel inputs across the different mobile source categories.

The 2005 base case fuel properties were derived from 2005 historical data. These data included national summer and winter fuels surveys, studies that tracked the total amount of ethanol produced for use in gasoline each year, and Reformulated Gasoline (RFG) measurements. Additional data were available on the fuel properties of all gasoline produced and imported annually by refiners, and on the distribution of gasoline to and from Petroleum Administration for Defense Districts (PADDs). Where survey data was available, it was used to determine a county's fuel properties for summer and winter. Where survey data was not available, fuel properties were set to equal the average fuel properties in that PADD. Special adjustments were made to some counties to account for local gasoline volatility control programs and winter oxygenated gasoline programs.

For the 2022 reference and control cases, the 2005 base case fuel properties were adjusted to account for implementation of other fuel regulations and to account for increased ethanol use. There is a greater percentage of ethanol in the 2022 AEO reference case than in the 2005 base case because methyl tert-butyl ether (MTBE) has been replaced with ethanol and because of AEO projected growth in ethanol production for 2022. For this analysis, ethanol was allocated to the state and county level based on the economics of distribution and blending, as well as other factors. Refer to Section 1.7.1 of this document for details. The 2022 control case models the requirements of EISA, in which approximately 34 bgal of ethanol are present in the fuel supply for 2022. The control case models this by assigning E10 gasoline to all U.S. counties, and E85 based on the economics of distribution, blending and other factors.

In general, future fuel properties in both the reference and control cases were adjusted to account for widespread increases in ethanol under the assumption that, while historically ethanol has been splash blended in conventional gasoline (CG), it will be match-blended (i.e., the changes associated with ethanol addition will be accounted for by refiners when producing the base gasoline) by 2022. We believe this is reasonable given that there will be a large (and thus more geographically predictable) volume of ethanol used in gasoline, and that certain property changes that take place when ethanol is blended (such as octane increase) could be financially beneficial to refiners if able to be assumed when producing the base gasoline. Thus, we adjusted aromatics, olefins, T50, and T90 fuel parameters by first backing out the effects of any existing oxygenate (by reverse dilution), and then re-adjusting the properties for ethanol blends based on refinery modeling done for the RFS1 rulemaking that projected how gasoline properties were likely to change given widespread use of ethanol. Table 3.1-1 shows the adjustment factors used per volume percent ethanol blended. Reid Vapor Pressure (RVP) was increased 1.0 psi wherever ethanol was present in conventional gasoline unless there was a state constraint.

Table 3.1-1. 2022 Adjustments for Ethanol Added to Conventional Gasoline

	Aromatics (vol%)	Olefins (vol%)	E200 (vol%)	E300 (vol%)
Additive change per vol% ethanol added	-0.464	0.019	0.909	0.063

For Reformulated Gasoline (RFG) areas, refiners already account for the blending of ethanol when producing the base gasoline, and therefore the properties are not predicted to change in the same ways as for conventional gasoline (CG). We used refinery modeling results for each PADD (produced along with those above for CG) to project the properties of fuel in RFG areas accounting for increased ethanol in the national gasoline pool. RFG properties used in the reference and control cases in 2022 are shown here in Table 3.1-2. The 2022 reference and control cases also incorporate reductions in gasoline sulfur resulting from Tier 2 regulations. It should be noted that fuel benzene levels presented in this table are higher than what they should be, given impacts of the 2007 mobile source air toxics (MSAT) rule, which mandates a 0.62% fuel benzene standard.⁵⁴⁴ For the final rule, we will use more recent refinery modeling, which provides better estimates of benzene levels with implementation of the MSAT rule.

Table 3.1-2. 2022 Reformulated Gasoline Properties by PADD

PADD	RVP (psi)	Aromatics (vol%)	Benzene (vol%)	Olefins (vol%)	E200	E300
Summer						
1	7.0	20.1	0.70	13.9	56.0	83.5
2	7.1	17.9	0.76	17.3	54.1	81.8
3	7.0	20.0	0.76	14.1	52.0	87.5
5	6.8	22.5	0.61	5.7	54.5	86.2
Winter						
1	12.8	19.6	0.71	15.3	60.8	83.2
2	13.0	17.8	0.64	12.3	63.9	79.5
3	11.8	21.2	0.64	12.6	53.4	87.5
5	12.6	23.7	0.61	5.7	58.2	86.2

For the control case, we also modeled flexible-fueled vehicles running on E85. For most emissions, these effects were modeled using fuel adjustments as described in Section 3.1.1.2, below. However, in MOVES, vapor venting emissions and sulfate emissions are calculated directly from the RVP and sulfur level of the fuel. These properties were derived for E85 fuels from the properties of the same county's E10 fuel in the control case, with the RVP adjusted to account for the lower vapor pressure of E85.⁵⁴⁵ and the sulfur level adjusted to 15% of that of the original E10 fuel in that county. The predicted sulfur adjustment underestimates the actual sulfur content of the fuel because it neglects the sulfur content of ethanol (about 1.5 ppm) and it does not account for any refinery increases in sulfur in the base gasoline; thus the benefit attributed to sulfate reductions in the E85 case may be overestimated.

For each of the modeled scenarios, fuel information was input into an NMIM database and used for NMIM runs. For MOVES runs, the NMIM databases were converted into MOVES

databases using a conversion program. To reduce time needed for MOVES runs, we reduced the size of the MOVES fuel database by processing the database with a "binner" program that grouped fuels with similar properties and assigned each group to a single fuel formulation identification number and a single set of fuel properties.

3.1.1.2 Effect of Fuels on Non-GHG Emissions from Vehicles & Equipment

The average effect of renewable fuels on an individual vehicle basis, based on available research, are the foundation of the emission impact assessment. This section contains discussion of the effects used in the emission impact assessment for E10 on gasoline vehicles and equipment, for E85 on gasoline vehicles, and for biodiesel.

3.1.1.2.1 On-road Gasoline Vehicle E10 Effects

3.1.1.2.1.1 Exhaust Emissions

A 10 percent ethanol blend can affect exhaust emissions from vehicles and off-road equipment. A comprehensive analysis of E10 impacts on exhaust emissions was undertaken for the RFS1 rule, as documented in Chapter 3 of the RFS1 Regulatory Impact Analysis.⁵⁴⁶ This analysis considered previous EPA work in coming up with a so-called "Predictive Model" to assess California's request for an oxygenate waiver in 2000, as well as test data from several test programs conducted by the auto trade associations (AAM/AIAM), ExxonMobil, Toyota, and the Mexican Petroleum Institute. This assessment concluded that for Tier 1 and later vehicles (nominally model year 1996 and later, comprising the majority of the fleet in 2022) there was not enough consistency across these studies to confidently predict the impact of oxygenated fuel on exhaust HC and NOx emissions. As a result the RFS1 analysis carried forward two sets of fuel effects: a "primary" analysis assuming no effect of oxygen on non-methane hydrocarbon (NMHC) and NOx emissions from Tier 1 and later vehicles, and a "sensitivity" analysis which applied EPA's Predictive Model effects to Tier 1 and later vehicles.

We are the midst of a large scale testing effort, scheduled for completion in 2009, aimed at quantifying the effects of several fuel parameters, including ethanol and other fuel properties impacted by the blending of ethanol into gasoline, on exhaust and evaporative emissions from Tier 2 vehicles.⁵⁴⁷ It is our expectation that data from this program will be used in our analysis for the final rule. For this proposal we are analyzing two ethanol effect scenarios: "less sensitive" based on the "primary" case used in RFS1, and "more sensitive" based on the RFS1 "sensitivity" case. While the effects of E10 on individual vehicles will vary depending on properties of the fuel (e.g., RVP, distillation, and aromatic content), Table 3.1-3 demonstrates the effects used for conventional and reformulated gasoline based on the fuel properties derived from Tables 3.1-1 and 3.1-2. The effects shown for NOx, HC and toxics were applied to only Tier 0 vehicles (mid 1990's and older) in the "less sensitive" case, and to all vehicles in the "more sensitive" case.

Table 3.1-3. Exhaust Effect of E10 Relative to E0 ^a

Pollutant	Source	CG	RFG
Exhaust HC (VOC)	EPA Predictive	-7.4%	-9.7%
NO _x	Models	7.7%	7.3%
CO ^b	MOBILE6.2	-11% / -19%	-36%
Exhaust Benzene	EPA Predictive	-24.9%	-38.9%
Formaldehyde	and Complex	6.7%	2.3%
Acetaldehyde	Models	156.8%	173.7%
1,3-Butadiene		-13.2%	6.1%

^a Assumes summer (July) conditions

^b The first figure shown applies to normal emitters; the second applies to high emitters.

3.1.1.2.1.2 Evaporative Emissions

3.1.1.2.1.2.1 Permeation

E10 affects evaporative emissions from gasoline vehicles due to the increased volatility of E10 blends, the increased permeation of fuel vapors through tanks and hoses, and the increased vapor emissions due to the lower molecular weight of E10. Each of these effects were modeled using the draft MOVES model, which separates permeation emissions from vapor venting emissions to allow better accounting for these different processes.

Permeation effects were developed from Coordinating Research Council's (CRC) E-65 program⁵⁴⁸, which measured evaporative emissions from ten fuel systems that were removed from the vehicles on E0 and E5.7 fuels; fuel systems were removed to ensure that all evaporative emissions measured were from permeation of the fuel through the different components of the fuel system. For this analysis, we estimated the effect by calculating the percent increase in average emissions from all vehicles between E0 and E5.7 fuels over the 65 to 105 degree Fahrenheit diurnal test. This value was 46 percent. In order to estimate the effect at E10 we simply multiplied this result by 1.75 (10/5.7), resulting in a 79 percent increase applied to cars and light trucks from all model years.

This approach heavily weights the emission contribution of older vehicles in the test program, and, in conjunction with lower emission rates for vehicles certified to Enhanced Evaporative and later standards in MOVES, may underestimate the impact of E10 on permeation from newer vehicles. The limited data on vehicles certified to Enhanced Evaporative standards showed an increase of 232 percent, versus 46 percent for all vehicles. We expect CRC to release a significant body of new E-77 program permeation data on later model vehicles before the end of 2008. We plan to revisit our permeation emissions estimates when these results are available.

3.1.1.2.1.2.2 Tank Vapor Venting

In MOVES, tank vapor venting (TVV) emissions from controlled vehicles are modeled as a function of uncontrolled vapor generation (TVG), which is affected by both ethanol content and RVP according to the formula (Reddy, 1989):

$$TVG = Ae^{B \cdot RVP} (e^{CT_x} - e^{CT_2})$$

where A, B, and C are coefficient dependent on ethanol level as described in the table 3.1-4, and T_x and T₂ are the temperatures at the start and end point of the vapor generation period.

Table 3.1-4. Tank Vapor Venting Coefficients (at sea level)

	E0	E10
Constant		
A	0.0082	0.0088
B	0.2357	0.2056
C	0.0409	0.0430

In MOVES, the relationship between TVV and TVG is a function of vehicle model year, temperature rise, and whether RVP is held constant or increased with the additional of ethanol. For example, for the 1978-1995 model year group over a temperature rise of 65 to 105 degrees F, the increase in tank vapor venting emissions is 6 percent for E10 relative to E0 with no change in RVP. However, the same scenario a 1.0 psi increase results in an increase in tank vapor venting emissions of 46 percent. The national impacts presented in this analysis reflect a composite effect of the mix of vehicle model years in 2022, hourly temperature differentials by county, and county-specific fuel property changes with the addition of ethanol.

3.1.1.2.2 On-road Gasoline vehicle E85 effects

As discussed in Section 1.7.1, because ethanol blended into E10 everywhere in the U.S. would account for less than half of the mandated ethanol volumes, we project that nearly 30 billion gallons of E85 will be required to fulfill the mandate. E85 is by no means a new fuel - automakers have been producing flex fuel vehicles (FFVs) capable of operating on E85 since the early 1990s. Nonetheless, there are relatively few sources of data available comparing the emissions of non-oxygenated (E0) and high-level (E85) ethanol blended fuels either for older (Tier 0 and 1), and particularly for current technology (i.e. Tier 2) vehicles. Understanding the emissions effects of E85 on the latter group of vehicles is of particular importance since Tier 2 FFVs will dominate the FFV fleet in future years. For this reason, we focused our analysis for this proposed rulemaking on newer technology (i.e. LEV and later) vehicles^{LLLLLLLL}.

For this analysis we identified three recent data sources that investigate the effects of E85 on current technology (i.e. Tier 2 and similar) vehicles^{MMMMMMMM 549, 550, 551}. Two of these sources are test programs conducted by Southwest Research Institute and Environment Canada, and the third is EPA certification data. This section briefly describes each data source and highlights the key findings, and explains how these data were used to generate E85 effects.

In 2006, Southwest Research Institute (SwRI) conducted a study for EPA on three model year 2005 Tier 2 FFVs (bins 5 and 8) operating on several gasoline and ethanol blends. This

^{LLLLLLLL} For a discussion of the effect of E85 on older technology vehicles, see Chapter 3 of the RFS RIA available here: <http://www.epa.gov/otaq/renewablefuels/420r07004chap3.pdf>

^{MMMMMMMM} EPA is aware of several test programs, either planned or underway, by CRC and others that may provide additional test data for future fuel effects modeling and rulemaking support.

study was primarily focused on the impacts of fuel ethanol content and reduced ambient test temperature (tests were conducted at 75°F and 20°F) on VOC and PM emissions. Multiple fuel blends were evaluated in this program, although for this analysis we will focus only on E0 and E85 emissions at 75° F. At this test temperature, Tier 2 certification fuel was used as the non-oxygenated test fuel (E0) as well as the base gasoline for the splash-blended E10 and E85 fuels. Additionally, EPA certification “cold CO” wintertime gasoline was used for reduced ambient temperature (20 °F) testing – used alone (E0) and as the base fuel for wintertime E10 and E70 blends. This base gasoline has a higher RVP than its summertime equivalent, which is necessary to ensure proper fuel vaporization at lower ambient temperatures. Repeat tests were conducted for the 20°F tests on the winter fuel blends, but no repeats were run for 75°F testing. In addition to the regulated pollutants, SwRI measured CO₂, CH₄, benzene, 1,3-butadiene, naphthalene, acetaldehyde, acrolein, and ethanol. This study saw reductions in PM 2.5, benzene, and 1,3-butadiene of 55% - 70% with E85 relative to E0. HC emissions increased while NO_x and CO decreased. Emissions of methane, formaldehyde, and acetaldehyde were found to increase significantly with E85 use. Table 3.1-6 summarizes the average percent change in emissions with E85 vs. E0. This table also compares the findings of this dataset with the other two programs described below.

Environment Canada released a report in 2005 in which an NLEV and an interim non-Tier 2 vehicle were tested on Tier 2 certification fuel and a commercially available E85 blend. Repeat tests were conducted in this study so that each vehicle was tested three times on each fuel. The pollutants measured include NMOG, NMHC, CO, NO_x, CO₂, CH₄, N₂O, benzene, 1,3-butadiene, acetaldehyde, formaldehyde, acrolein, and ethanol, among others. The results, summarized in Table 3.1-6 showed statistically significant reductions in CO and NO_x (-48% and -40%, respectively) when switching from E0 to E85. E85 caused non-methane organic gases (NMOG) emissions to increase in one vehicle and decrease in the other. Toxics reductions were of a similar order of magnitude as the vehicles tested in the SwRI study discussed above

EPA’s Certification and Fuel Economy Information System (CFEIS) database was accessed to identify data from five model year 2006 Tier 2 vehicles (bins 5, 8, and 9) tested on both E85 and Tier 2 certification gasoline. The E85 blend tested here was 85% denatured ethanol splash blended with 15% Tier 2 certification gasoline. Each vehicle was only tested once on each fuel. Weighted FTP results were reported for the regulated pollutants (except PM) as well as CO₂, acetaldehyde, and ethanol (formaldehyde, acetaldehyde, and ethanol were only measured for tests where E85 was used; therefore these are expressed as fractions of NMOG here). This data indicates that E85 causes a slight increase in NMOG emissions, a slight decrease in NO_x and CO₂, and significant reductions in CO. The average percent change in each pollutant for these vehicles when operated on E85 is shown in Table 3.1-5, below.

**Table 3.1-5.
Effect of E85 on LEV and Later Per-mile Exhaust Emissions Relative to
Conventional Gasoline: Percent change separated by data source**

	EPA - CFEIS	EPA - SwRI	Env. Canada
NMOG	10%	87%	5%
CO	-34%	-15%	-48%
NOx	-3%	-42%	-40%
Benzene	NA	-61%	-65%
1,3 Butadiene	NA	-66%	-74%
Acetaldehyde	12% of NMOG	5600%	3121%
Formaldehyde	2% of NMOG	116%	98%
Acrolein (E85 mg/mile emissions)	NA	0.023	0.010
Unburned Ethanol (E85 mg/mile emissions)	28.3 (55% of NMOG)	25.4 (33% of NMOG)	34.6 (48% of NMOG)
PM 2.5	NA	-68%	NA

Viewed independently, each study provides only limited insight on the effects of E85 on emissions relative to E0. Table 3.1-6 shows that while changes in some pollutants compare reasonably well between studies, others can vary widely. This makes it difficult to determine quantitative trends in emissions, since calculating an average percent change in emissions across all three studies does nothing to address the variability of the test data. Without this assessment of variability there is no way to estimate the statistical significance of the reported values. Only the Environment Canada conducted the repeat tests necessary to assess the test-to-test variability of a given vehicle, and none of the studies tested enough vehicles to confidently state that their findings can be applied to the Tier 2 FFV fleet as a whole. In this case it is desirable to combine the test data into a single dataset and apply a statistical modeling technique that allows one to estimate the average effect of E85 observed across the vehicles tested and to assess whether those changes are statistically significant.

Combining the data from these three studies results in a dataset that is still quite small (only 26 unique tests) and is by no means ideal. This clearly illustrates the need for additional testing in this area. In the absence of such data, we feel that combining the data is warranted since the majority of the vehicles employ similar emissions control technology and the base gasoline used in each study was Tier 2 certification fuel. In the SwRI and EPA CFEIS datasets, the E85 fuels were splash blended from denatured ethanol and Tier 2 gasoline. In the case of Environment Canada, their E85 was purchased from a commercial distributor, so its physical properties are slightly different than the splash blended E85 fuels. However, when approximately 82% of the fuel is a single compound (ethanol), the variability in the remaining fuel properties is small enough to consider the E85 fuels from all three data sources to be substantially similar for the purposes of this analysis. In other words, no distinction was made between the E0 and E85 fuels used in study A vs. the E0 and E85 fuels used in study B.

The fact that Environment Canada tested non-Tier 2 vehicles is noteworthy. The 2004 Chrysler Sebring was an interim non-Tier 2 bin 8 vehicle. Despite its name, however, the standard is equivalent to the final Tier 2 bin 8 FTP standards in all areas but the full useful life (120K miles vs. 100K miles). In fact this vehicle was cleaner than required by the standard, with observed emissions on E0 at the level of a Tier 2 bin 7 vehicle. The second vehicle tested by Environment Canada was a 2002 Dodge Caravan certified to the NLEV LEV LDT level. The standards at this certification level are considerably more relaxed than Tier 2 levels for some pollutants but not others. While these vehicles share the same NMOG certification standard (0.100 g/mi), the CO standard is roughly 30% higher and the NO_x standard nearly 4 times higher than the Tier 2 bin 8 level. As a result of this difference in standards, the Caravan emitted about 20% more CO and 2.5 times more NO_x than the Sebring. NMOG emissions were nearly the same for both vehicles with non-oxygenated gasoline. On a relative scale, both vehicles experienced similar percent changes in emissions between E0 and E85. The Sebring emitted more ethanol with E85 than did the Caravan, resulting in a higher E85 NMOG emissions factor for that vehicle. For the purposes of this analysis, we did not differentiate either of these vehicles from the Tier 2 vehicles tested in the other studies.

The fact that tests were conducted in different laboratories is of little consequence since we are attempting to quantify the average effect of E85 across individual vehicles, not necessarily comparing the results (in absolute terms) of one vehicle to another. Therefore any laboratory bias is implicitly included in an individual vehicle's test results and does not confound the relative effects of fuel on emissions for that vehicle.

The statistical software package SPSS (version 9.0.1) was used to create a univariate linear model using the natural log of a given pollutant (CO₂, NO_x, etc) as the dependent variable, the fuel terms as a fixed variable, and the vehicle term as a random variable. This is a so-called mixed model since it includes both fixed and random variables^{NNNNNNNN}. Only the first order (linear) fuel and vehicle terms were considered in this model since three fuel levels would have been needed to assess nonlinear fuel effects. The model also excluded the vehicle by fuel interaction term. This approach was taken since our primary focus is to identify the main effect of fuel on the natural log of emissions (the dependent variable). Including the vehicle by fuel interaction would have told us something about the sensitivity of each individual vehicle to changes in fuel, but for this analysis we are more concerned with the average effect of fuel across all vehicles in the dataset. Therefore we removed the interaction from the model since including it on such a small dataset would confound the main fuel effect and inappropriately constrain the model.

The results of the statistical analysis are summarized in Table 3.1-6. Statistically significant results are shown in bold.

^{NNNNNNNN} A sensitivity analysis was performed designating the vehicle term as a fixed variable (a fixed-effect model) but the results were identical to those with the mixed model so only these results are presented here.

Table 3.1-6: Combined E85 Effects over 3 Programs

Pollutant	E85 change from E0
NMOG	8.6%
CO	-38.7%
NO _x	-20.9%
Toxics (mg/mile)	
Benzene	-59.6%
1,3 Butadiene	-61.2%
Acetaldehyde	3739.8%
Formaldehyde	62.3%
Acrolein (mg/mile emission w/ E85)	
Unburned Ethanol (mg/mile emission w/ E85)	
PM 2.5	-68.2%

Bold = statistically significant at 95% CI

As shown in the table above, the effect of E85 on emissions was significant for all pollutants of interest except for NO_x and NMOG. For NO_x, the p-value is 0.83 and for NMOG the p-value is 0.55, meaning these results are only significant at the 17% and 45% confidence levels (respectively). While relatively speaking, NO_x is more statistically significant than NMOG, for our purposes they both can only be used qualitatively. Directionally, the NMOG increase and NO_x decrease are consistent with the observations of each individual study and agree with basic engineering judgment. The variability in the magnitude of these changes, however, is what weakens the statistical significance. Had additional observations been made, these results may have become more statistically significant. For our “more sensitive” fuel effects case, only those effects shown to be statistically significant were applied in the analysis. No E85 effects were applied for the “less sensitive” case.

The “more sensitive” case also included a 50 percent reduction in evaporative emissions with use of E85 based on results from one vehicle from CRC’s E-65 evaporative permeation program. For the final rule we expect to verify the change in evaporative emissions with E85 based on results from ongoing EPA and CRC testing.

Data from the analyses discussed above, and an additional dataset from a 1995 test program conducted by EPA’s Office of Research and Development, were used to develop inputs for MOVES, in order to model E85 impacts on air toxics inventories. Since MOBILE6 does not model air toxics for E85, ratios were developed to apply to E85 hydrocarbon or PM mass (Table 3.1-7). The exhaust ratios for all pollutants except naphthalene were obtained from data on seven vehicles from the 1995 test program in EPA’s Office of Research and Development, along with the previously discussed 2007 test program at Southwest Research Institute,⁵⁵² and the 2005 test program at Environment Canada.^{553, 554} The data from the ORD test program is unpublished, but is available in the docket for this rule. Naphthalene inputs for were derived from estimates from E10 values based on dilution of fuel with ethanol. The only source of data on evaporative emissions were results of hot soak tests from the Auto/Oil Air Quality Improvement Research Program.⁵⁵⁵

Table 3.1-7. Toxic to THC/PM Ratios used for E85 Fuel in MOVES

Pollutant	Exhaust/Ratio Type	Evaporative/Ratio Type
Benzene	0.0036/THC	0.0054/THC
1,3-Butadiene	0.0005/THC	N.A.
Acetaldehyde	0.0673/THC	N.A.
Formaldehyde	0.0093/THC	N.A.
Acrolein	0.0002/THC	N.A.
Ethanol	0.3316/THC	0.6123/THC
Naphthalene	0.0126/PM	0.00006/THC

3.1.1.2.2 Spark-Ignited Off-Road Engines

Effects of E10 relative to E0 on exhaust as well as fuel tank and hose permeation emissions from gasoline-fueled off-road engines are contained in EPA’s NONROAD model, based on limited data. The effects on exhaust HC, NOx, and CO are shown in Table 3.1-8. Effects on tank and hose permeation emissions vary by equipment type and were recently updated to reflect new information on uncontrolled emissions and their control due to recently finalized new standards.⁵⁵⁶ For most small spark-ignition engines and recreational marine engines in 2022 E10 is estimated to double the tank and hose permeation emissions. There can also be increases in diurnal and refueling emissions with E10 if the fuel volatility of the blend is allowed to be greater than E0. These volatility effects are accounted for in the NMIM model that has the county-specific fuel properties that were used to generate the emission inventory impacts for this proposal presented below in Section 3.2.

**Table 3.1-8.
Exhaust Effect of Ethanol (E10) on Spark-Ignited Gasoline Emissions**

	4 stroke	2 stroke
HC exhaust	-15.75%	-2.1%
NOx	+40.25%	+65.1%
CO	-21.7%	-22.75%

EPA, DOE and the California Air Resources Board (ARB) are in the midst of additional testing of off-road engines that will be used to update our analysis for the final rule.

3.1.1.2.4 Biodiesel Effects on Diesel Emissions

As discussed in Appendix A to this RIA, we investigated the emission impacts on NOx, PM, HC, and CO of 20 volume percent biodiesel fuels on emissions from heavy-duty diesel vehicles.⁵⁵⁷ Average NOx emissions were found to increase 2.2 percent, while PM, HC, and CO were found to decrease 15.6 percent, 13.8 percent, and 14.1 percent, respectively, for all test cycles run on 20 volume percent soybean-based biodiesel fuel (Table 3.1-9). These results are generally consistent with the exhaust emission impacts for heavy-duty, in-use diesel engines

found in our previous work on this subject.⁵⁵⁸ For our estimate of biodiesel impacts on toxics we applied the HC emission change from Table 3.1-9 to toxic emissions.

Table 3.1-9. BD20 Emission Impacts

	Percent change in emissions
NO _x	+2.2%
PM	-15.6%
HC	-13.8%
CO	-14.1%

3.1.1.3 Non-GHG Emission Impact Scenarios Analyzed

As discussed in Section 3.1.1.2.1, two sets of fuel effects scenarios were analyzed in the RFS1 rule in order to bound the uncertainty in ethanol effects on on-road gasoline engines. For today’s proposal we have carried forward these scenarios, but have expanded the sensitivity case to consider the impacts of E85 as well. Fuel effects cases differ only in how on-road gasoline exhaust emissions are modeled. For all other sources discussed above – on-road gasoline evaporative and refueling emissions, off-road spark ignition (SI), portable fuel containers, and heavy-duty diesel emissions – the same fuel effects, as summarized in the preceding sections, were used. The differences between the fuel effect cases are summarized below:

- 1) “Less Sensitive”: No exhaust VOC or NO_x emission impact on Tier 1 and later vehicles due to E10, and no impact due to E85. This was the “primary” case analyzed in the RFS1 rule, and results in only pre-Tier 1 vehicles having an effect from E10.
- 2) “More Sensitive”: VOC and NO_x E10 emission impacts based on test data on newer technology vehicles, as presented in Table 3.1-3, and the statistically significant E85 effects that were presented in Table 3.1-6.

3.1.1.4 Non-GHG Emission Impact Calculation Methodology

3.1.1.4.1 On-Road Gasoline

Emissions from gasoline highway vehicles were generated with a preliminary draft version of EPA's new MOVES model. This model is currently being prepared for release in draft form in early 2009. Although we applied a preliminary pre-draft version of the model and we anticipate changes between the version used for the NPRM analysis and the version to be released publicly (and the final rule version), our analysis does reflect significant updates in gasoline vehicle emissions from MOBILE6. Exhaust emission rates for HC, CO and NO_x were developed based on an analysis of state inspection/maintenance and roadside remote sensing data from millions of vehicles.⁵⁵⁹ Emissions of particulate matter are based on EPA's recent Kansas City gasoline PM study.^{560,561} Evaporative emission rates have been updated based on extensive evaporative testing conducted by EPA and the Coordinating Research Council (CRC) since the release of MOBILE6, including investigations quantifying the effects of ethanol on permeation

emissions.⁵⁶² For this assessment of toxics, MOVES applies toxic ratios from the MOBILE6.2 model to updated MOVES HC estimates within the model.⁵⁶³

Details of how MOVES was configured and run are documented in a report contained in the docket.⁵⁶⁴ To summarize, a separate MOVES run was configured for each year (2005 and 2022) and fuel effect case (“less sensitive” and “more sensitive”) for the reference case (AEO reference) and control case. Each of these runs required a unique “run specification” file and bundle of input databases to allow modeling of differences in analysis year, fuel supplies, and fuel effects. For example, for the 2005 base year run, MOVES was configured to run with the estimates of fuel formulations and market shares by county in 2005, using the inputs developed as discussed in Section 3.1.1.1, and two sets of fuel effects to reflect the “less sensitive” and “more sensitive” cases. Reference and control case runs in 2022 were run with estimates of fuel formulations and market shares for both cases by county as we project in 2022, again with the two fuel effects cases. MOVES was only run for the AEO reference case, so results relative to other reference cases (i.e. RFS1 mandate or baseline) were based on scaling the differences between the AEO reference and control cases. VMT used to model onroad emissions was that developed for the Office of Air Quality Planning and Standards's 2002 Version 3 Modeling Platform⁵⁶⁵ and used in the recently published Locomotive-Marine Rule.⁵⁶⁶

MOVES allows different levels of pre-aggregation depending on the level of resolution needed. For regional inventory applications, the finest level of aggregation the model can run is by county for each hour of the day, which maximizes the influence of inputs such as county-level fuel effects, hourly temperatures and activity patterns; however, since running the model at this level for the entire nation over multiple years and scenarios would be time prohibitive, the model was run at a higher level of aggregation to reduce run time. Exhaust emissions were run at the state/month aggregation for all cases, meaning that county-level inputs were aggregated to a single state average before being processed into MOVES, and hourly inputs were aggregated into an average monthly value. Likewise evaporative emissions were run at the state/hour level of aggregation, since evaporative emissions are required to be run at the hourly level. For further time savings runs were performed in January and July only and weighted to approximate an entire year – for most pollutants we simply used the number of days in each month to extrapolate to the full year (approximately 50/50), however due to the higher temperature sensitivity of PM, care was taken to develop weighting factors that better approximated a yearly total based on a month-by-month run (January/July weightings of approximately 30/70). While aggregation does lose some resolution in the overall emission results, test runs indicated that emissions differences are within a few percent of fully disaggregated runs and acceptable for estimating the emission impacts of the control programs.

MOVES categorizes vehicles according to use type; for this analysis the majority of the focus was on light vehicles, which would include the MOVES use types Passenger Car, Passenger Truck and Light Commercial Truck. To account for larger gasoline vehicles which will also have emissions affected by the change in gasoline formulations, we also ran additional MOVES use types: school buses, single-unit trucks, and motor homes. For the purposes of this rulemaking, the number of gasoline-powered refuse trucks, transit buses, intercity buses and combination trucks was determined to be negligible, and they were omitted from the MOVES

runs to reduce run time. Because the PM10 calculation inputs for MOVES were incomplete, PM 10 was calculated outside the model as PM2.5 times a correction factor of 1.086.

Because at the time of this analysis the MOVES module for automating the calculation of E85 emissions from flexible fueled vehicles (FFVs) was not complete, we calculated the emission impact of E85 use by running MOVES for all E85 and for all E10 and then weighted the emissions in a post-processing step. To run MOVES for "all E85" we created a special set of MOVES input files that essentially set all gasoline vehicles to run on E85. We created MOVES fuel supply and fuel adjustment tables that applied multiplicative E85 fuel adjustments from Table 3.1-7 to all gasoline vehicle emissions.⁰⁰⁰⁰⁰⁰⁰⁰ Because sulfate and vapor venting emissions are calculated using fuel properties (sulfur level and RVP) rather than fuel adjustments, we also created a specific MOVES table of E85 fuel properties as described in Section 3.1.1.1. In a post-processing step, we calculated a weighted average of the "all E85" results and the 2022 control case, sensitivity analysis results (called "all E10" results here). We chose to use the "sensitivity" results for consistency with its premise that modern vehicles are responsive to changes in fuel characteristics. The all E85 and all E10 results were weighted together by state, model year, and vehicle type using a weighting factor that was the product of the FFV fraction and the E85 market share, where FFV fraction is the fraction of that vehicle type and model year that are projected to be E85 flexible-fueled vehicles, and the E85 marketshare is the state fraction of FFV energy use that we project will be provided by E85. These fractions were generated using the assumptions described in the sections in Chapter 1, Section 1.7.1 pertaining to Primary FFV Growth Assumptions and Projected Growth in E85 Access. We performed this calculation for passenger cars and trucks and light commercial trucks only since the number of heavy-duty vehicles using E85 is expected to be small.

Toxic emissions are in development for MOVES; for this analysis some post-processing was required to generate complete inventory estimates. Specific toxic:hydrocarbon ratios by fuel formulation, vehicle class and model year were developed from a series of MOBILE6 runs and fed into MOVES, which applied these ratios to HC emissions to produce emissions of benzene, acetaldehyde, 1-3 butadiene, formaldehyde and acrolein for all of these cases analyzed. Naphthalene from heavy-duty vehicles was ratioed to PM 10 in MOVES. For light-duty vehicles, naphthalene emissions were calculated as the sum of PM 2.5 elemental carbon and PM 2.5 organic carbon emissions times a ratio of 0.088. Aggregate ratios from the running emissions were also applied to start emissions to develop overall toxic emission inventories. E85 emissions were calculated in MOVES using the factors in Table 3-1.7.

3.1.1.4.2 Off-Road Gasoline

Emissions from nonroad gasoline equipment were developed by running the National Mobile Inventory Model (NMIM), a consolidated emissions modeling system for EPA's MOBILE6 and NONROAD models.⁵⁶⁷ The key feature of NMIM is a national county database (NCD), which includes county-level information on temperatures, fuel properties, equipment populations, etc. NMIM runs MOBILE6 and NONROAD based on information in the NCD.

⁰⁰⁰⁰⁰⁰⁰⁰ The MOVES fuel adjustment table developed for this analysis contained all E85 fuel effects from Table 3.1-9, including the not statistically significant NOx and NMHC results; however, only results pollutants identified as statistically significant in Table 3.1-9 are reported in the sensitivity case inventory results

The NCD used to produce these inventories was updated as part of the 2005 National Emission Inventory (NEI) process.⁵⁶⁸ The NCD also included the 2005 and 2022 fuels described in Section 3.1.1.2. The version of the NONROAD Model used included the effects of the recently signed Final Rule: Control of Emissions of Air Pollution from New Nonroad Spark-Ignition Engines, Equipment, and Vessels.⁵⁶⁹ It is also capable of modeling the effects of gasoline blends containing 10 percent or less of ethanol.

Emissions from onroad and nonroad diesel equipment were also developed by running NMIM (see above), using the same NCD and version of the NONROAD Model described above. The version of MOBILE was MOBILE6.2. Diesel fuels are less fully characterized than gasoline, since the only property used by MOBILE and NONROAD is fuel sulfur.

Toxic emissions for off-road reference cases were taken directly from NMIM. Inventories for the control case were developed by applying ratios of the aggregate MOVES toxic exhaust, evaporative and refueling emissions for on-road gasoline for control versus reference case, to reference case toxic emissions for off-road from NMIM.

3.1.1.4.3 On-Road Diesel

Today's proposal requires an increase in biodiesel to 0.81 billion gallons by 2022. As it is likely this will be consumed in a variety of blend levels (e.g. 20 percent, 5 percent, 2 percent) by light-duty diesel vehicles and off-road diesel equipment as well as heavy-duty diesel vehicles, we assumed for this analysis that the effects of biodiesel on emissions are linear with biodiesel concentration as demonstrated by Sze, et al,⁵⁷⁰ and that impacts can be analyzed assuming all biodiesel is blended as BD20. We applied the BD20 effects discussed in Section 3.1.1.2.4 to baseline heavy-duty emissions generated by NMIM, as MOVES heavy-duty diesel estimates were not available in time for this analysis. Biodiesel impacts were using the following formula:

$$\text{Biodiesel Impact}_p = \text{Base HD Emissions}_p * \text{Effect}_p * (\text{Increase in BD20 Volume} / \text{Total Diesel Volume})$$

Where:

P = pollutant

$\text{Effect} = \text{Percent change with BD20 blend from Section 3.1.1.3.3}$

$\text{Increase in B20 Volume} = \text{Change in B20 volume from 2022 reference case to control case in billion gallons of B20 blend (ie, change in gallons of biodiesel * 5)}$

$\text{Total Volume} = \text{Total Highway Diesel Volume in 2022 in billion gallons}$

Toxic effects were calculated using the HC effects from Table 3.1-9

3.1.1.4.4 Portable Fuel Containers

There are several sources of emissions associated with portable fuel containers (PFC) used for gasoline. These sources include vapor displacement and spillage while refueling the gas can at the pump, spillage during transport, permeation and evaporation from the gas can during transport and storage, and vapor displacement and spillage while refueling equipment. As the

calculation of emissions for refueling non-road equipment includes spillage and some vapor displacement, these impacts are not included here.

As part of the 2007 regulation controlling emissions of hazardous pollutants from mobile sources (MSAT2 rule), EPA promulgated requirements to control VOC emissions from gas cans. The methodology used to develop emission inventories for gas cans is described in the regulatory impact analysis for the rule and in an accompanying technical support document.^{571, 572}

Based on the MSAT work, we generated two sets of hypothetical nationwide annual estimates of PFC VOC emissions, for calendar years 2017 and 2030, based on all E0 and all E10. Interpolation can be used to estimate PFC VOC emissions for the reference cases. Proportions of national E0 and E10 fuel use were calculated from the 2022 reference and policy scenarios. The reference case featured a mix of 89.1% E10 and 10.9% E0, while the policy case featured 100% E10. While E85 is used in flexible fueled highway vehicles, it is unlikely to be used in the near future in non-road equipment, and is therefore unlikely to be stored or dispensed from PFCs.

MSATs found in liquid gasoline will be present as a component of VOC emissions. These MSATs include benzene and naphthalene. Ethanol is present as well in VOC emissions from ethanol blends. Inventories for these pollutants were estimated by the application of toxic to VOC ratios.

For benzene emissions from all sources except permeation, the following formula was used to calculate toxic to VOC ratios:

$$PFC \text{ Benzene Emissions} = PFC \text{ VOC Emissions} \times \left(\frac{Re \text{ fueling Benzene}_{LDGV}}{Re \text{ fueling VOC}_{LDGV}} \right) \times 0.36$$

where the ratio of refueling benzene to VOC was estimated using average nationwide fuel properties for zero and 10 percent ethanol gasoline from refinery modeling, done for RFS rule, and applied to EPA's Complex Model for reformulated gasoline.^{573, 574} The 0.36 multiplier corrects for the difference in the percentage of gasoline in refueling emissions at 90° F, the temperature assumed for the algorithm in the Complex Model, versus a more typical lower fuel temperature of 60 ° F for gas cans. The basis of this adjustment is discussed in more detail in the regulatory impact analysis for the Mobile Source Air Toxics Rule. An additional adjustment factor is applied to the ratio for permeation emissions, based on a recent study⁵⁷⁵ that suggests that the ratio of benzene from permeation to total VOC from permeation is about 1.77 times higher than the ratio associated with evaporation, according to the following formula:

$$PFC \text{ Benzene Emissions} = PFC \text{ VOC Emissions} \times \left(\frac{Re \text{ fueling Benzene}_{LDGV}}{Re \text{ fueling VOC}_{LDGV}} \right) \times 0.36 \times 1.77$$

The resulting ratios for 0% and 10% ethanol did not differ at the fifth decimal place, and were 0.0135 for all sources except for permeation, and 0.00239 for permeation. Thus, impacts of this rule on benzene emissions are due to the overall impact of RVP changes on total VOC emissions.

A naphthalene to VOC ratio was estimated using the following formula:

$$PFC \text{ Naphthalene Emissions} = PFC \text{ VOC Emissions} \times \left(\frac{Evaporative \text{ Naphthalene}_{LDGV}}{Evaporative \text{ VOC}_{LDGV}} \right) \times 0.0054$$

An evaporative naphthalene to VOC ratio for light-duty gasoline vehicles of 0.0004 was obtained from analyses done for the Mobile Source Air Toxics Rule, and did not vary by fuel type. The 0.0054 adjustment was based on a recent analysis of average nationwide percentage of naphthalene in gasoline vapor from gasoline distribution with an RVP of 10 psi at 60 degrees Fahrenheit.^{576, 577} The resulting ratio applied to PFC emissions was 0.0000022.

For E10 fuel, we assumed 16.74 percent of the evaporative emissions were ethanol (SPECIATE profile 1301)⁵⁷⁸ and 33.34 percent of permeation emissions were ethanol.⁵⁷⁹

3.1.1.4.5 Refueling Emissions

Refueling emissions were calculated by NMIM, based on MOBILE6 refueling module. Emissions are impacted by the increase in RVP due to ethanol, and also because the reduced energy density of ethanol would require more fillups. NMIM directly provides the emission increase due to increased RVP for the areas allowing the 1.0 psi waiver, so no additional processing was required to estimate RVP effects on refueling.

In order to estimate the emission impact of the increase in refueling events, we developed ton per gallon refueling emission factors based on NMIM by dividing total refueling emissions from NMIM for each case by the number of gallons consumed in the AEO case. The ton per gallon emission factors were then applied to the total volume in gallons in each case. Fuel volumes for the control case, RFS 1 base, RFS 1 mandate and AEO cases are listed in Table 3.1-10. Our estimates of total gallons were calculated from energy balance, reflecting the various number of gallons needed to consume the same energy. We assume the number of trips to the pump will increase in proportion to the increased gallons estimated for the rule.

Table 3.1-10. Gasoline Volumes (Billion Gallons)

	RFS 1 Base	RFS 1 Mandate	AEO2007	Control Case
E0	77.95	107.51	16.03	0
E10	67.00	36.40	131.00	124.6
E85	0.00	0.00	0.11	29.3
Total Gallons	138.25	143.91	147.14	153.9

3.1.2 Impact on Non- GHG Emissions from Fuel Production and Distribution

In addition to the effects of increased renewable fuel use on emissions from the vehicles and equipment that use the fuels, as discussed above, there are shifts in the fuel production and transport/distribution methods that can have substantial impacts on emissions. These "upstream" emissions are associated with all stages of biofuel production and distribution, including biomass production (agriculture, forestry), fertilizer and pesticide production and transport, biomass transport, biomass refining (corn or cellulosic ethanol production facilities), biofuel transport to blending/distribution terminals, and distribution of finished fuels to retail outlets. Additionally, changes in agricultural economics associated with increased biomass production can result in shifts in related agricultural production, such as livestock.

This section describes the changes in upstream emission sources and related emission rates connected with the renewable fuel use. The emission inventory impacts resulting from these changes are described in Section 3.2. This section is divided into two major sub-sections, the first covering emissions of criteria pollutants, their precursors, and ammonia, and the second covering non-criteria air toxic emissions and ethanol. The specific air toxics covered are: benzene, acetaldehyde, formaldehyde, 1,3-butadiene, acrolein, and naphthalene.

3.1.2.1 Upstream Criteria Pollutants

3.1.2.1.1 Agricultural Sector

Introduction

In prior EPA estimates, such as the RFS1 rule, changes in agricultural emissions were based solely on the increases in bushels of corn (and soybeans for biodiesel), and the necessary acreage to produce those additional bushels. Given the greater pressure on farmland use likely in the 2022 timeframe for this proposed rule (15 billion gallons of corn ethanol) compared to the 2012 assessment for RFS1 (6.7 or 9.6 billion gallons of ethanol depending on scenario), additional factors have been added to the agricultural analysis, such as likely shifts of acreage to corn from certain other crops as corn prices increase.

The number of acres of cropland for corn, soy, and all other principle crops were estimated using the FASOM agriculture and forestry model, as described in Section 2.1 of this document. We are using the change in total acres of planted cropland to estimate changes in certain agricultural emissions, such as tillage dust and crop residue burning, that are not directly calculated by FASOM. Another substantial source of agricultural emissions (especially ammonia and methane) is livestock. Changes in livestock-related emissions are estimated based on the change in head counts of cattle, swine, and poultry predicted by FASOM.

The impacts relative to the two RFS1 reference cases (3.64 and 6.7 billion gallons) rely only on applying ethanol volume proportions to the modeling results of the AEO reference case (13.2 billion gallons). Due to the complex interactions involved in projections in the agricultural modeling, we did not attempt to adjust the agricultural inputs of the AEO reference case for the other two reference cases. So the fertilizer and pesticide quantities, livestock counts, and total

agricultural acres were the same for all three reference cases. The agricultural modeling that had been done for the RFS1 rule itself was much simpler and inconsistent with the new modeling, so it would be inappropriate to use those estimates. Thus, we plan to conduct additional agricultural modeling specifically for the RFS1 mandate case prior to finalizing this rule.

3.1.2.1.1.2 VOC/NO_x/CO/SO_x/PM_{2.5}

Criteria pollutants related to agricultural operations come from five major sources: farm equipment (mainly diesel engine emissions), fertilizer production and application, pesticide production and application, burning of crop residue, and fugitive dust from field tilling and related activities.

Agricultural Equipment Emissions

Changes in farm equipment emissions were estimated by multiplying an average fuel-based emission factor for diesel or gasoline farm equipment by the change in farm fuel consumption predicted by FASOM. The emission factors for each pollutant in units of grams emitted per million BTU of fuel burned were calculated from EPA NONROAD2005 nationwide modeling outputs for 2022 (pollutant tons emitted, gallons of fuel consumed) for each year of interest. The diesel emissions include all agricultural diesel equipment, which are dominated by agricultural tractors, while the gasoline emissions include only the limited number of larger agricultural gasoline-fueled equipment, such as tractors, combines, balers, swathers, and irrigation sets. The fuel energy contents (lower heating value) used for the unit conversions were 115,000 BTU/gallon for gasoline and 130,000 BTU/gallon for diesel. For comparison, the corresponding 2020 emission factors from GREET are shown, where available. Most of the differences between NONROAD and GREET are small and are likely attributable to the difference between 2020 and 2022 values. And although the gasoline equipment emission factors for VOC and CO from NONROAD are much greater than those used in GREET, this does not have much impact on emission inventories due to the small number of gasoline-fueled equipment used in agriculture relative to diesel equipment.

Table 3.1-11.
Agricultural Equipment Emission Factors
(grams per mmBTU of fuel burned)

Pollutant	Diesel		Gasoline	
	NONROAD	GREET	NONROAD	GREET
NOx	306	298	204	208
VOC	30.55	34.87	355.53	52.30
PM10	21.12	22.67	7.49	9.07
PM2.5	20.49	20.41	6.89	8.34
CO	130	136	10,067	204
Benzene	0.62	--	11.90	--
Ethanol	0.00	--	0.00	--
1,3-Butadiene	0.057	--	1.90	--
Acetaldehyde	1.62	--	1.63	--
Formaldehyde	3.61	--	3.17	--
Naphthalene	0.027	--	0.66	--
Acrolein	0.09	--	0.14	--
SO2	0.44	--	15.88	--
NH3	0.68	--	1.01	--

Fertilizer and Pesticide Production

The manufacturing processes for agricultural fertilizer and pesticides generate a variety of pollutants. The agricultural inputs from GREET provide emission factors in grams of pollutant per ton of nutrient for various types of fertilizers, herbicides, and insecticide, as shown in Table 3.1-13. These emission factors were multiplied by the changes in fertilizer and pesticide use predicted by FASOM, as shown in Table 3.1-12, to give projected changes in nationwide agricultural fertilizer and pesticide production emissions.

Table 3.1-12.
Changes in Agricultural Chemical Use Relative to AEO Reference Case

	Nitrogen (average)	Phosphate (P2O5)	Potash (K2O)	Limestone (CaCO3)	Herbicides	Pesticides
Annual Short Tons	322,430	211,988	657,066	-239	-11,240	-781
Percentage	2.42%	7.17%	19.09%	-2.12%	-5.07%	-1.86%

Table 3.1-13.
Agricultural Chemical Production & Transport Emission Factors
(grams per ton of nutrient)

Pollutant	Nitrogen (average)	Phosphate (P2O5)	Potash (K2O)	Limestone (CaCO3)	Herbicides	Pesticides
NOx	1,605	4,484	734	573	19,371	21,628
VOC	2,761	240	40.7	56.8	1,575	2,040
PM10	454	1,551	148	506	10,840	11,746
PM2.5	262	1,018	74.5	167	4,869	5,479
CO	2,595	790	129	186	5,417	6,872
Benzene	0.00	0.00	0.00	0.00	3.21	4.16
Ethanol	0.00	0.00	0.00	0.00	0.00	0.00
1,3-Butadiene	0.000	0.000	0.000	0.000	0.576	0.745
Acetaldehyde	0.018	0.001	0.000	0.000	0.082	0.106
Formaldehyde	20.75	1.55	0.19	0.41	18.11	23.44
Naphthalene	0.033	0.117	0.010	0.039	114.4	124.0
Acrolein	0.009	0.001	0.000	0.000	0.024	0.031
SO2	703	53,299	321	701	11,300	12,895
NH3	0.00	0.00	0.00	0.00	0.00	0.00

Until the 1990s it was reasonable to assume that all fertilizers and pesticides used on domestic agriculture were produced within the U.S. This has been less true in recent years as more agricultural chemicals, especially fertilizers, are being imported from countries with a greater availability of natural gas at lower costs. For greenhouse gases the location of these emissions is of less importance, but for criteria pollutants and toxics it is important to reduce the estimated impacts by the percentage of production and transportation occurring outside of the U.S. Using data from USDA^{580,581} the percentages applied from domestic sources are shown in Table 3.1-14. After applying these percentages to the production and initial transportation portions of the GREET emission factors, the unadjusted final (domestic) transportation portion of the GREET emission factors was added back in. Since the relative emissions from production versus transportation vary by pollutant, the net adjustments to the GREET emission factors also vary by pollutant, as shown in the second Section of Table 3.1-14. To calculate an overall factor for nitrogen fertilizers, the proportions from GREET were used: 70.7% ammonia, 21.1% urea, and 8.2% ammonium nitrate. The pesticide adjustment does not vary by pollutant because virtually all of the pesticide emissions come from actual production rather than transportation/distribution.

**Table 3.1-14.
Domestic Fractions of Fertilizer and Pesticide Production Applied to Crops**

	Nitrogen Fertilizers	Potash	Phosphate	Pesticides
Domestic Fraction of Production	50%	20%	94%	76%
Net Adjustment to Production, Transportation & Distribution Emission Factor from GREET				
VOC	50.63%	94.85%	53.62%	76%
CO	52.47%	94.92%	54.37%	76%
NOx	73.34%	94.92%	65.55%	76%
PM10	52.64%	94.12%	24.06%	76%
PM2.5	53.67%	94.14%	28.31%	76%
SOx	60.48%	94.02%	33.66%	76%

Fertilizer and Pesticide Application

In addition to the agricultural equipment emissions mentioned above, the application of fertilizer and pesticides (herbicides, insecticides, fungicides, etc.) to agricultural fields causes the release of certain types of pollutants into the air. For nitrogen fertilizers the only pollutant considered to be significant is ammonia (NH₃), the estimation of which is covered in Section 3.1.3.1.1.2. Pesticide application emissions are mainly VOC and various individual organic compounds, most notably benzene and acrolein. A discussion of the toxic pollutant emissions as a fraction of VOC is presented in Section 3.1.3.2.2, but the resulting emission factors and inventory impacts are shown here in Table 3.1-15. There are also potential toxicity concerns with volatilization of the pesticide active ingredients, and this is discussed in Section 3.4 of this document.

The basis of the pesticide application emissions for this analysis was the 2002 NEI area-source inventory. The ton per year emissions data from the NEI was used with USDA pesticide application data for 2002 (or the nearest year for which data were collected) to generate an overall average estimate of the pesticide application emissions per ton of pesticide applied. This ratio of pollutant tons (for VOC, benzene, and acrolein) per ton of pesticide applied was then multiplied by the change in total pesticide tons used (including herbicides) as projected by FASOM and shown in Table 3.1-12 to give the projected change in nationwide agricultural pesticide application emissions in Table 3.1-15.

**Table 3.1-15.
Herbicide and Pesticide Application Emission Factors and Impacts
Relative to AEO Reference Case**

Pollutant	Emission Factor	Impact
	(tons per ton applied)	(annual short tons)
VOC	0.543	-6,531
Benzene	0.142	-1,707
Acrolein	0.0036	-43.1

Agricultural Residue Burning Emissions

One source of air pollution related to crop farming is the burning of crop residues. This practice is one of the methods that is used to clear fields between crop cycles so that the old crop residue does not build up and clog or otherwise hinder the tilling of the fields in preparation for new crop planting. This practice is mainly used for grassy crops like wheat, rye, and barley, but in some areas it is also used for corn and other crops.

Crop residue burning produces substantial emissions of CO₂, VOC, CO, NO_x, as well as ammonia and toxic pollutants such as benzene, formaldehyde, 1,3-butadiene, and acrolein.

The use of crop residue burning is quite variable from area to area and among individual farmers, since there are alternative methods to deal with crop residue, including use of conservation tillage methods and equipment that allows planting through the residue. In some locations and time periods crop residue burning has been prohibited by law, due to the possible health effects in nearby residential areas.

Although the agricultural burning data in the NEI does not currently cover all states where crop residue burning occurs, the data available was used to generate a rough overall estimate of the average crop burning emissions per acre of planted crops. This was done using 2002 crop acreage data from USDA/NASS for the counties covered by the NEI agricultural burning data. The overall ratio of pollutant tons (for each pollutant) per total acre farmed was then multiplied by the change in total planted acres projected by FASOM to give a projected change in nationwide agricultural burning emissions. These values are shown below in combination with the agricultural dust emissions in Table 3.1-12.

Agricultural Dust Emissions

Soil and related dust particles (e.g., fertilizer, pesticide, manure) become airborne as a result of field tillage and animal grazing/foraging, especially in drier areas of the country. Some of this dust is in a size range that is a concern for human health and welfare. The NEI includes estimates of these particulate emissions by county.

As done for agricultural burning emissions, the agricultural dust data from the 2002 NEI was used to generate an estimate of the average fugitive dust emissions per acre of planted crops

for the crop related dust, and per head of cattle for the dust related to cattle. This was done using 2002 nationwide crop acreage and livestock inventory data from USDA/NASS. The calculated pollutant tons (for PM) per total acre farmed was then multiplied by the change in total planted acres projected by FASOM to give a projected change in nationwide crop related dust emissions. And the calculated PM tons per head of cattle was multiplied by the change in cattle inventory projected by FASOM to give a projected change in nationwide livestock related dust emissions.

The emission factors and inventory impacts of agricultural burning and fugitive dust from crop related activities and livestock are shown in Table 3.1-16 and 3.1-17. The ton per year impacts for the crop-related emissions are based on a modeled increase of 2,327,000 farmed acres (0.79%) in 2022 relative to the AEO reference case. The changes in fugitive dust from livestock operations are based on the head count changes shown in Table 3.1-19.

Table 3.1-16.
2022 Crop-related Burning and Dust Emission Impacts
Relative to AEO Reference Case

Pollutant	Emission Factors	Inventory Impacts
	(Tons per thousand acres farmed)	(annual short tons)
NOx	0.191	443.8
VOC	0.535	1,245
PM10	7.62	17,723
PM2.5	1.71	3,974
CO	6.13	14,255
Benzene	0.017	38.97
Ethanol	0	0
1,3-Butadiene	0.0073	17.06
Acetaldehyde	0.032	75.46
Formaldehyde	0.07	173.46
Naphthalene	unknown	unknown
Acrolein	0.013	30.01
SO2	0.059	136.6
NH3	0.071	165.5

**Table 3.1-17.
2022 Livestock-related Dust Emission Impacts
Relative to AEO Reference Case**

Pollutant	Beef Cattle Dust Emissions		Dairy Cattle Dust Emissions	
	(kg/head/year)	(annual short tons)	(kg/head/year)	(annual short tons)
PM10	0.888	-0.945	0.172	-0.008
PM2.5	0.089	-0.095	0.017	-0.001

3.1.2.1.1.2 Ammonia (NH₃)

The two primary sources of ammonia emissions on farms are fertilizer application and livestock waste. Fertilizer application emissions were estimated using an average emission factor of 57,428.71 grams per ton of fertilizer nitrogen applied for all forms of nitrogen, which is a weighted average of the standard EPA emission factors that are used to generate the NEI. The weightings for each type of fertilizer come from USDA Economic Research Service data for 2006. The individual emission factors, weightings, and resulting average emission factor are shown in Table 3.1-18. This average emission factor was multiplied by the nitrogen application quantities generated by the FASOM model for each scenario.

Table 3.1-18. Fertilizer Ammonia Emission Factors

Fertilizer Type	SCC	Emission Factor (lbs NH ₃ /Ton Nitrogen)	USDA 2006 all crops Weighting
Anhydrous Ammonia	2801700001	24	15.46%
Aqua Ammonia	2801700002	24	1.61%
Nitrogen Solutions	2801700003	61	40.88%
Urea	2801700004	364	21.73%
Ammonium Nitrate	2801700005	49	3.9%
Ammonium Sulfate	2801700006	194	4.93%
Ammonium Thiosulfate	2801700007	64	
Other Straight Nitrogen	2801700008	61	11.49%
Ammonium Phosphates	2801700009	97	
N-P-K	2801700010	97	
avg lbs/ton			126.61
avg grams/ton			57428.71

Changes in ammonia emissions from livestock waste were estimated using emission factors (kg/head/year) multiplied by the change in animal head counts predicted by FASOM. The ammonia emission factors and livestock head changes used in this analysis, along with resulting ammonia inventory impacts are shown in Table 3.1-19. This analysis was limited to these four types of livestock because they are the ones specifically modeled by FASOM.

Table 3.1-19. Livestock Ammonia Emission Impacts Relative to AEO Reference Case

Livestock Type	kg NH3 per head per year^a	Head count change (million head)	Percent change	Change in NH3 emissions (annual short tons)
Beef Cattle	9	-1.065	-1.40%	-9.58
Dairy Cattle	25	-0.047	-0.60%	-1.18
Swine	5	-2.553	-2.15%	-12.76
Poultry	0.22	-90.14	-0.97%	-19.83

^a Source: EPA/600/R-02-017, "Review of Emission Factors and Methodologies to Estimate Ammonia Emissions From Animal Waste Handling," April 2002.

Although it is a minor source of ammonia compared to fertilizer and livestock emissions described below, changes in farm equipment ammonia emissions were estimated by multiplying an average fuel-based emission factor for diesel or gasoline farm equipment by the change in farm fuel consumption predicted by FASOM. The ammonia emission factors in units of grams emitted per million BTU of fuel burned were calculated from the default ammonia emission factors used in the EPA NMIM model:

116 mg per gallon of gasoline burned;
and 88.3 mg per gallon of diesel fuel burned.

3.1.2.1.2 Biofuel Production

Emissions from the production of biofuels include the emissions from the production facility itself as well as the emissions from production and transport of the biomass and any other fuels used by the biofuel plant, such as natural gas, coal, and electricity. The biomass feedstock production emissions are discussed above in the section on agricultural emissions. The calculation of emissions from corn ethanol, cellulosic ethanol, and biodiesel plants, including feedstock transport, was done using the basic methodology of the GREET model. But some updates and enhancements were made to GREET, including updated feedstock energy requirements and estimates of excess electricity available for sale from new cellulosic ethanol plants, based on modeling by the National Renewable Energy Laboratory (NREL).

The facility emission factors used are shown in Table 3.1-20. The dry mill corn ethanol plant emission factors were developed for the RFS1 rule based on an average of state supplied data (RFS1 final rule RIA Table 3.4-2, based on C. Jackson memo Docket EPA-HQ-OAR-2005-0161, April 6, 2007). The dry mill PM2.5 factors and all the wet mill emission factors come from GREET 1.7. Emission factors for cellulosic ethanol plants, biodiesel, and renewable diesel production were taken from GREET (version 1.8 added renewable diesel). Additional analyses are still being conducted to determine potential decreased plant energy requirements and emission rates that may be feasible by 2022.

**Table 3.1-20.
Biofuel Production Plant Emission Factors in 2022
(grams per gallon produced)**

Biofuel Plant Type	VOC	CO	NOx	PM10	PM2.5	SOx	NH3
Corn Ethanol, Dry Mill NG	4.000	1.900	5.500	2.200	0.265	7.000	0.000
Corn Ethanol, Dry Mill NG (wet DGS)	4.000	1.900	5.500	2.200	0.222	7.000	0.000
Corn Ethanol, Dry Mill Coal	4.000	1.900	5.500	2.200	1.884	7.000	0.000
Corn Ethanol, Dry Mill Biomass	4.000	1.900	5.500	2.200	0.421	7.000	0.000
Corn Ethanol, Dry Mill Biomass (wet DGS)	4.000	1.900	5.500	2.200	0.313	7.000	0.000
Corn Ethanol, Wet Mill NG	2.330	1.039	1.677	0.998	0.288	0.012	0.000
Corn Ethanol, Wet Mill Coal	2.334	3.501	4.857	4.532	1.984	4.595	0.000
Cellulosic Ethanol (switchgrass or corn stover, enzymatic)	1.937	11.722	16.806	2.792	1.116	0.625	0.000
Cellulosic Ethanol (forest waste, thermochemical)	0.363	5.154	7.427	0.854	0.435	0.271	0.000
Biodiesel, Soybean oil	0.040	0.454	0.733	0.062	0.062	0.005	0.000
Renewable Diesel, Soybean Oil	0.029	0.329	0.530	0.045	0.045	0.004	0.000

3.1.2.1.3 Crude Oil Production/Transport/Refining

The estimate of emissions associated with production of gasoline and diesel fuel from crude oil is based on emission factors in the GREET model. The actual calculation of the emission inventory impacts of the decreased gasoline and diesel production is done in EPA's spreadsheet model for upstream emission impacts. This model uses the decreased volumes of the crude based fuels and the various crude production and transport emission factors from GREET to estimate the net emissions impact, which is shown below in Section 3.2 (see the displaced gasoline line of Table 3.2-5).

3.1.2.1.4 Finished Fuel Transport and Distribution

Transfer and Storage Evaporative Emissions from Gasoline, Gasoline/Ethanol Blends, and Ethanol -- VOC emissions are produced by transfer and storage activities associated with distribution of gasoline, gasoline/ethanol blends, and ethanol. These are referred to as Stage I emissions.⁵⁸² Stage I distribution begins at the point the fuel leaves the production facility and ends when it is loaded into the storage tanks at dispensing facilities.

There are five types of facilities that make up this distribution chain for gasoline. Bulk gasoline terminals are large storage facilities that receive gasoline directly from the refineries via pipelines, barges, or tankers (or are collocated at refineries). Gasoline from the bulk terminal storage tanks is loaded into cargo tanks (tank trucks or railcars) for distribution to smaller intermediate storage facilities (bulk plants), or directly to gasoline dispensing facilities (retail public service stations and private service stations). When ethanol is blended into gasoline it usually occurs in the pipes which supply the tank trucks.

There are two types of pipeline facilities found at various intervals along gasoline distribution pipelines: pipeline breakout stations and pipeline pumping stations. Pipeline breakout stations receive gasoline via pipelines, store it in storage tanks, and re-inject it into pipelines as needed to meet the demand from downstream facilities. Pipeline pumping stations are located along the entire length of a pipeline at about 40 mile intervals. Their purpose is to provide the extra “push” needed to move the product through the pipeline. They do not normally have gasoline storage capability.

Bulk plants are intermediate storage and distribution facilities that normally receive gasoline or gasoline/ethanol blends from bulk terminals via tank trucks or railcars. Gasoline and gasoline/ethanol blends from bulk plants are subsequently loaded into tank trucks for transport to local dispensing facilities.

Gasoline and gasoline/ethanol blend dispensing facilities include both retail public outlets and private dispensing operations such as rental car agencies, fleet vehicle refueling centers, and various government motor pool facilities. Dispensing facilities receive gasoline and gasoline/ethanol blends via tank trucks from bulk terminals or bulk plants. Inventory estimates for this source category only include the delivery of gasoline at dispensing facilities and does not include the vehicle or equipment refueling activities.

Emission factors (EFs) for gasoline were based on inventory estimates from the 2002 NEI.⁵⁸³ We used these data to develop E0 gasoline emission factors even though the 2002 emissions included the E10 that was in the fuel pool at that time. In 2002 this was still a relatively small proportion of gasoline consumption, so it should not substantially affect the national E0 estimates. Since ethanol is blended with gasoline at bulk terminals to produce E10 and E85 at the point fuel is loaded into tank trucks, we assumed bulk terminal emissions were associated with unblended gasoline. We then divided emissions into a refinery to bulk terminal component and a bulk terminal to dispensing facility component. Total nationwide emissions for these two components were divided by the energy content of the total volume of gasoline distributed in 1999, to obtain the emission factor in g/mmBTU. Total volume of gasoline was based on gasoline sales as reported by the Energy Information Administration.⁵⁸⁴ These emission factors are provided in Table 3.1-21.

We also developed emission factors for Stage 1 emissions of E10 and E85 subsequent to blending at bulk terminals. These emission factors were calculated by applying adjustment factors to the gasoline EF. The adjustment factors for E10 and E85 were based on an algorithm from the 1994 On-Board Refueling Vapor Recovery Rule⁵⁸⁵:

$$EF \text{ (g/gal)} = \exp[-1.2798 - 0.0049(\Delta T) + 0.0203(T_d) + 0.1315(RVP)] \quad (1)$$

where delta T is the difference in temperature between the fuel in the tank and the fuel being dispensed, and T_d is the temperature of the gasoline being dispensed. We assumed delta T is zero, temperature of the fuel being dispensed averages 60 degrees over the year, and that the RVP of conventional gasoline is 8.7 psi, 10% ethanol is 9.7, and 85% ethanol is 6.2. Using these assumptions, the adjustment factor is +14% for E10 and -30% for E85. Emission factors in grams per million BTU of fuel transferred are given in Table 3.1-21.

In addition to these Stage I emissions for gasoline and gasoline/ethanol blends, transport of ethanol to bulk terminals also results in evaporative emissions of ethanol, a VOC. These emissions are estimated based on an adjustment to the gasoline transport VOC emissions to account for the much lower vapor pressure (approximately 3 psi at 100F for denatured ethanol versus 9 psi for gasoline) and molecular weight (48.7 for denatured ethanol versus approximately 72 for gasoline vapor). The net factor is 0.23 x gasoline evap VOC, resulting in the value shown for E100 in Table 3.1-21:

$$\begin{aligned}
 &3.56 \text{ g/mmBTU of ethanol} \\
 &= 0.23 \times \text{gasoline VOC per-gallon EF} / \text{ethanol energy content} \\
 &= 0.23 \times (10.2137 \text{ g/mmBTU} \times 115000 \text{ BTU/gal}) / 76000 \text{ BTU/gal}
 \end{aligned}$$

Note that this very simplified methodology does not attempt to account for differences between ethanol and gasoline transport modes, distances, or transfer methods in movement of the fuel from production facility to the bulk distribution terminal. We plan to do a more thorough analysis of this for the final rule.

Significant evaporative emissions are not expected from storage and transport of biodiesel fuel due to its low volatility.

Table 3.1-21.
VOC Emission Factors for Gasoline and Gasoline/Ethanol Blend Storage and Transfer Emissions (Stage 1)

Process	Blend	EF(g/mmBTU)
Refinery to Bulk Terminal	E0	14.94
Refinery to Bulk Terminal	E100	3.56
Bulk Terminal to Pump	E0	27.79
Bulk Terminal to Pump	E10	32.74
Bulk Terminal to Pump	E85	25.93

Combustion Emissions from Transport and Distribution of Fuels and Feedstocks -- Emissions are produced by the vehicles and engines used to transport feedstocks such as crude oil, corn, and cellulosic biomass to fuel production facilities, as well as transport/distribution of the finished fuels from the production plants to distribution terminals and retail outlets. For example, corn would be transported from farms and grain facilities to ethanol plants by truck and possibly rail. The finished ethanol would be transported from there to bulk distribution terminals by truck, rail, or barge, and distribution from terminal to retail outlet is by truck. The emission factors for the year 2022 in Table 3.1-22 take into account the mix of newer better controlled engines (including trucks meeting the standards for 2008 and later engines⁵⁸⁶ and engines meeting the 2008 locomotive/marine diesel engine rule⁵⁸⁷), as well as any remaining older engines subject to less stringent standards. The truck EFs are given in terms of grams per vehicle mile traveled, while the other EFs are in grams per million BTU of fuel burned by the engine. Emission factors for these engines are taken from the rulemaking analyses.

To estimate the net emission rates for the assumed mix of transport modes for each fuel type, these emission factors were incorporated into a modified version of GREET⁵⁸⁸, since GREET 1.7 and 1.8 retained emission factors based only on earlier regulations. Thus, the miles traveled and quantities of fuel burned are those used by GREET for each transport mode and fuel being transported. For the final rule air quality analysis we will have a more detailed analysis of miles and fuel volumes transported by mode within each county.

Table 3.1-22. 2022 Criteria Emissions from Fuel and Feedstock Transport/Distribution

Transport Mode	Year	VOC	CO	NOx	PM10	PM2.5
Class 2B HD Diesel Trucks (g/mile)	2005	0.282	1.303	3.594	0.163	0.139
	2022 (2020)	0.137	0.205	0.483	0.033	0.019
Medium HD Diesel Trucks (g/mile)	2005	0.653	2.482	8.297	0.309	0.271
	2022 (2020)	0.289	0.417	1.243	0.053	0.035
Locomotive (g/mmBTU of fuel burned)	2005	84.733	212.861	1620.376	51.575	50.028
	2022 (2020)	34.070	203.984	815.271	19.015	18.445
Barge (avg of C1 & C2 vessels) ⁵⁸⁹ (g/mmBTU of fuel burned)	2005	26.761	237.513	1276.901	47.923	46.485
	2022 (2020)	15.527	188.994	676.097	22.017	21.356
Ocean Tanker (C3 vessels) (g/mmBTU of fuel burned)	2005	79.943	181.746	2177.881	181.410	166.930
	2022 (2020)	79.891	181.526	2054.819	181.118	166.666

3.1.2.2 Upstream Air Toxics

3.1.2.2.1 Upstream Air Toxics Reference Case

Air toxic emissions are associated with a variety of upstream processes. These processes include production of agricultural pesticides and fertilizers, as well as their application, operation of petroleum refineries, operation of ethanol and biodiesel production facilities, operation of electrical production facilities which supply power to these facilities, and distribution of agricultural pesticides and fertilizers, feedstocks, gasoline, gasoline/ethanol and biodiesel blends.

Although a large number of compounds which are considered air toxics could be impacted by this rule, we focused on those which were identified as national and regional-scale cancer and noncancer risk drivers in the 1999 NATA⁵⁹⁰ and were also likely to be significantly impacted by this rule. These compounds include benzene, 1,3-butadiene, formaldehyde, acetaldehyde, and acrolein. Naphthalene impacts were included for petroleum refineries, since it is a significant emission product for those facilities. Ethanol impacts were also included in our analyses because of health concerns (Section 3.4.5) and its role as an acetaldehyde precursor.

2002 air toxic emissions for stationary sources, other than for fires, were obtained from the 2002 National Emissions Inventory (NEI), version 3. Future year emissions of benzene, 1,3-butadiene, formaldehyde, acetaldehyde, and acrolein were estimated for sectors only, rather than individual sources. These sectors included non-EGU (electric generating unit) point sources,

EGU point sources, the nonpoint storage and transfer subsector, and other nonpoint sources. Emissions were estimated by applying future year to 2002 VOC ratios to 2002 air toxic estimates. Air toxics from fires were estimated by applying toxics-to-VOC ratios to the VOC emissions from a fire inventory developed for air quality modeling. 2002 and future year ethanol emissions were estimated by speciating the VOC estimates. This was done using the Sparse Matrix Operator Kernel Emissions (SMOKE) modeling system, version 2.3. More details on the methods and data used to develop these inventories are found in a memo included in the docket for this rule.⁵⁹¹

Air toxic emission estimates for agricultural equipment (mainly diesel agricultural tractors) were obtained from the EPA NMIM model, as described for criteria pollutants in Section 3.1.2.1.1.1.

3.1.2.2.2 Upstream Air Toxics Control Cases

As described below, we developed emission factors for several air toxics using the most recent available data. These emission factors were used with estimates of changes in fuel volumes and associated energy outputs to estimate inventory changes associated with the proposed program. In general, emission factors are expressed as grams per million BTU (g/mmBTU) of energy produced or distributed as part of the process. Underlying data are available in the docket for the rule.

Agricultural Pesticides and Fertilizers – The estimation of air toxic emissions from production and application of pesticides and fertilizers was done using toxic fractions of the corresponding VOC emissions described in Section 3.1.3.1.1.1. Table 3.1-23 shows the toxic fractions, which were calculated from the 2002 NEI inventories for VOC and each of the listed toxic pollutants. All the pollutants except acrolein from pesticide application are based on nationwide inventories. California was the only state that reported acrolein emissions associated with pesticide application, so the 0.66% value shown in the table represents the sum of acrolein emissions divided by the sum of VOC emissions from pesticide application for all counties in California in 2002. The fertilizer and pesticide application data come from queries of the NEI area source inventories for SCCs like "28017*" (for fertilizer application) and SCCs like "246180*" or like "246185*" (for pesticide application).

The production and blending data for fertilizer and pesticides come from queries of the NEI point source data that were submitted by 40 states and Puerto Rico for the following MACT codes

0911 - Pesticide Active Ingredient Production

0960 - Agricultural Chemicals and Pesticides Manufacturing

1410 - Phosphate Fertilizers Production

The data for these codes was compiled for the following four categories: Fertilizer production (F), Fertilizer mixing blending (FMB), Pesticide production (P), and Pesticide mixing blending (PMB).

Table 3.1-23. Air Toxic Fractions of VOC for Fertilizers and Pesticides

	Fertilizer Production & Blending	Pesticide Production & Blending	Fertilizer Application	Pesticide Application
1,3-Butadiene	--	0.0003653	--	--
Acetaldehyde	6.530 E-06	5.198 E-05	--	--
Acrolein	3.320 E-06	1.513 E-05	--	0.0066
Benzene	--	0.002038	--	0.2615
Ethanol	--	--	--	--
Formaldehyde	0.007517	0.011494	--	--

Petroleum Refineries – Total nationwide emissions of air toxics for 153 U. S. petroleum refineries in 2002 were obtained from data collected as part of a risk and technology review (RTR) for EPA’s proposed rule, “National Emission Standards for Hazardous Air Pollutants From Petroleum Refineries.”⁵⁹² These emissions were divided by BTUs of energy produced by those refineries in 2002 to obtain emission factors in g/mmBTU. Thus the resultant emission factors represent 2002 technology and emission standards. Energy output estimates included all refinery products, such as conventional and reformulated gasoline, aviation gasoline, jet fuel, kerosene, distillate fuel oil, residual fuel oil, petrochemical feedstocks, naphthas, lubricants, and other miscellaneous products. Energy output was estimated by multiplying volume of each product supplied⁵⁹³ by its heating value in BTUs per gallon.

Resultant emission factors are provided below in Table 3.1-25, along with those for ethanol and electricity production.

Ethanol Production Facilities – There are a number of processes at ethanol production facilities that result in emissions of air toxics. These processes include fermentation, distillation of the resultant mash, and drying of spent wet grain to produce animal feed. Emissions of air toxics vary tremendously from facility to facility due to a variety of factors, and it is difficult to determine how differences in the production processes individually impact emissions. Numerous production facilities have commenced operation in the last few years. To develop emission factors we used the most recent available inventory for benzene, formaldehyde, acetaldehyde, and acrolein, from calendar year 2005. These data were obtained from two sources:

- 1) 2005 NEI State submittals for SCCs associated with ethanol production facilities
- 2) the 2005 Toxics Release Inventory (TRI)

2005 NEI data submittals were obtained from EPA’s Office of Air Quality Planning and Standards. These data are included in the docket for the rule. Additional data for facilities not included in these submittals were obtained from the 2005 TRI (<http://www.epa.gov/triexplorer/list-chemical-hap.htm>). Where emissions data were not available for a facility, the facility was excluded from subsequent calculations.

Only a few facilities reported very low emissions of 1,3-butadiene, and the rest reported no emissions, so emissions of this pollutant from ethanol production facilities were assumed to

be insignificant. Almost all of the data were from wet mill plants running on natural gas, so it was not possible to develop separate emission factors for wet and dry mill plants, or those running on coal or natural gas.

Energy output for each facility was estimated by multiplying production capacity by the heating value for ethanol. Since data on actual production by facility were not available, all plants were assumed to operate at capacity. Estimates of production capacity were obtained from data collected by the Renewable Fuels Association (<http://www.ethanolrfa.org/industry/locations/>). For some major ethanol producers production capacity was not available for specific facilities.

Data for facilities where both emissions and production capacity were available were used to estimate nationwide emission rates in g/mmBTU. Table 3.1-24 lists the number of ethanol production facilities with emissions data for various air toxics, as well as production capacity estimates.

**Table 3.1-24.
Number of Facilities with Emission Inventory Data
by Pollutant and Production Capacity Estimates**

Pollutant	No. of Facilities with Emissions Data and Production Capacity Estimates.
Benzene	30
Formaldehyde	35
Acetaldehyde	50
Acrolein	22

An emission factor for ethanol was estimated using data collected in Minnesota from 16 facilities, all of which were dry mill plants.⁵⁹⁴ Since most ethanol emissions occur during fermentation, and new production of ethanol is likely to occur at dry mill facilities, these data are likely to provide representative estimates of future year increases in ethanol emissions under the control scenarios modeled. The resultant emission factors for ethanol production facilities are provided in Table 3.1-25.

Distillers' grains with solubles (DGS) is a co-product of dry mill corn ethanol production that can be used as animal feed. Corn oil remaining in the DGS can be extracted and sold for commercial uses, such as biodiesel production, at a relatively high value compared to the DGS itself. The oil can be extracted by gravimetric methods or by extraction with n-hexane, which is a potentially important toxic emission associated with increased ethanol production. Capital costs for solvent extraction are higher, but so are yields.

Corn oil for food grade use is produced by a process wherein corn is separated into component parts, prior to fermentation, with the starch heavy dehulled-degermed corn portion fed to the ethanol plant and the corn germ fed to a hexane-based corn oil extraction facility. This process is capital intensive and must be designed into the plant. We expect the food grade extraction process to be less widespread than commercial grade processes for these reasons.

VeraSun recently submitted an application to the Iowa Department of Natural Resources (IDNR) to add a facility for solvent extraction of corn oil to an ethanol plant in Fort Dodge Iowa.⁵⁹⁵ In this application, Verasun proposed to control particulate matter emissions from the process using a baghouse, and to minimize VOC emissions through good design and operating processes. Verasun estimated that this plant, with an annual DDGS capacity of 455,000 tons of DDGS per year, would produce 305 tons of VOCs per year, with n-hexane emissions of 295 tons per year. PM₁₀ emissions would be about 13 tons.

EPA used the Verasun application data to develop an estimate of potential nationwide n-hexane emissions from ethanol plants nationwide. EPA estimates that about 40% of ethanol production will have corn oil extraction by 2022; thus, we assumed that about half of this would be from solvent extraction and 20% of dry mill plants would employ this process. It is likely a number of plants will use gravimetric recovery, since it can be easily retrofitted to any size plant at modest capital cost. First, we developed emission rates per ton of DDGS production. Then we developed an estimate of DDGS produced nationwide, using industry characterization estimates of 13.67 billion gallons of dry mill ethanol production in 2022, and 0.00334 tons DDGS per gallon of ethanol produced by dry mills.⁵⁹⁶ Multiplying the emission rate from the Verasun application by total production of DDGS, EPA estimates these facilities could emit about 9,000 tons of n-hexane nationwide. However, given the very limited data on emissions from such facilities and the nascent nature of this process at ethanol production facilities, such estimates should be regarded as highly uncertain.

Biodiesel Production Facilities -- To estimate emission factors for biodiesel production facilities, we identified air toxic emission data for individual facilities developed for the 2005 NEI. Unfortunately, only toxics data for two existing biodiesel facilities could be found. These data were used to develop toxic to VOC ratios, then applied to VOC emission factors for biodiesel plants obtained from GREET, with modifications to add energy used in crushing soybeans. VOC emission rates vary by feedstock. Toxic to VOC ratios, VOC emission rates, and resultant toxic emission rates in grams per gallon are give in Table 3.1-26.

Transportation and Distribution of Gasoline, Ethanol, Gasoline/Ethanol Blends and Biodiesel -- Air toxic emissions associated with distributing fuel and fuel blends come from two sources. The first source is evaporative, spillage and permeation emissions from storage and transfer activities, and the second source is emissions from vehicles and pipeline pumps used to transport the fuels. Since a pipeline system does not exist for ethanol, increased ethanol use is likely to increase toxic emissions from vehicles used to transport it, while a corresponding decrease in gasoline distribution would decrease any emissions related to pipeline pumping.

Storage and transfer activities result in evaporative emissions of benzene and ethanol from gasoline, ethanol, and gasoline/ethanol blends. Evaporative emissions from biodiesel fuel are not expected to be significant. Emissions of ethanol occur both during transport of ethanol from production facilities to bulk terminals, and after blending, at bulk terminals. In addition, emission factors for benzene must be estimated separately for fuel before and after blending. As previously discussed, we assumed bulk terminal emissions were associated with unblended gasoline. We then divided emissions into a refinery to bulk terminal component and a bulk terminal to dispensing facility component. Benzene emission factors for gasoline transport from

refinery to bulk terminals were weighted by the fraction of 2002 VOC emissions for this part of the process, whereas emission factors for E0 gasoline, E10 gasoline, and E85 were weighted by the fraction of 2002 VOC from the bulk terminal to the pump. Benzene emission rates from these activities also vary with the year being modeled, since phase-in of the recently finalized Mobile Source Air Toxics Rule will substantially reduce the amount of benzene in gasoline beginning in 2011.⁵⁹⁷ Thus, one set of emission factors were developed for 2002, and a separate set of emission factors for the reference case in that year. The reference case also includes impacts of the 2007 renewable fuels standard.⁵⁹⁸ Thus, the reference case already reflects ethanol volumes mandated by RFS1.

The emission factors used for 2002 were derived from the estimated gasoline distribution inventory for benzene in 1999, estimated for the Mobile Source Air Toxics Rule.⁵⁹⁹ Total nationwide emissions were divided by the energy content of the total volume of gasoline distributed in 1999, to obtain the emission factor in g/mmBTU. Total volume of gasoline was based on gasoline sales as reported by the Energy Information Administration.⁶⁰⁰ To estimate the energy content, sales of fuel types (conventional, Federal reformulated, California reformulated) were multiplied by their respective heating values.

The emission factors used for the reference case in 2022 were derived from an estimated gasoline distribution inventory for that year. This inventory estimate was calculated by linear interpolation of 2020 and 2030 inventories from the Mobile Source Air Toxics Rule. Total nationwide emissions were divided by the energy content of the total volume of gasoline projected for 2022 by the Energy Information Administration.⁶⁰¹ To estimate the energy content, the projected gasoline volume was multiplied by the heating value for low-sulfur gasoline (115,000 BTU/gallon).

We assumed that in order to attain the fuel benzene standard for gasoline promulgated in the Mobile Source Air Toxics Rule, E10 would have the same fuel benzene content per gallon as E0. However, for E10 the E0 emission factor was adjusted to account for the lower energy content of E10 relative to E0. For E85, the E0 emission factor was adjusted to account for 66% lower benzene emissions per gallon, as well as the lower energy content of E85.

The emission factors for benzene are provided in Table 3.1-27.

To estimate ethanol emissions associated with the distribution of E10 and E85, ethanol to benzene emission ratios were applied to benzene estimates. The ratios were 14.8 for E10 and 112.8 for E85. The ratio for E10 was obtained from the profile for composite evaporative emissions from U. S. EPA's SPECIATE database, profile 1301.⁶⁰² The ratio for E85 was obtained from analyses of evaporative emissions from three vehicles tested as part of the Auto/Oil program in the early 1990's.⁶⁰³ These emission factors are reported in Table 3.1-27.

Table 3.1-25. Air Toxic Emission Factors for Petroleum Refineries, Ethanol Refineries, and Electricity Production (g/mmBTU of fuel or electricity produced)

Pollutant	Petroleum Refinery	Ethanol refinery	Electricity Production
1,3-butadiene	0.0014	N. A.	0.0001
Acetaldehyde	0.0002	3.0585	0.0297
Acrolein	0.0001	0.1323	0.0115
Benzene	0.0264	0.0998	0.0443
Ethanol	0.0000	21.6858	
Formaldehyde	0.0042	0.5263	0.0629
Naphthalene	0.0029		

Table 3.1-26. Air Toxic Emission Factors for Biodiesel Production Facilities (g/gallon produced)

Pollutant	Toxic/VOC Ratio	Biodiesel Soybean Oil EF (g/gal)	Biodiesel Yellow Grease/tallow (g/gal)	Renewable Biodiesel Soybean Oil (g/gal)
VOC		0.040	0.042	0.029
Benzene	7.4×10^{-7}	3.0×10^{-8}	3.1×10^{-8}	2.1×10^{-8}
1,3-Butadiene	0	0	0	0
Formaldehyde	3.5×10^{-5}	1.4×10^{-6}	1.5×10^{-6}	1.0×10^{-6}
Acetaldehyde	5.6×10^{-6}	2.3×10^{-7}	2.4×10^{-7}	1.6×10^{-7}
Acrolein	4.8×10^{-6}	1.9×10^{-7}	2.0×10^{-7}	1.4×10^{-7}
Ethanol	0	0	0	0
Naphthalene	6.3×10^{-7}	2.5×10^{-8}	2.6×10^{-8}	1.8×10^{-8}

Table 3.1-27. Air Toxic Evaporative Emission Factors for Gasoline, Ethanol, and Blend Transport and Distribution (g/mmBTU of fuel transported)

Pollutant	Process	Year	Fuel	EF (g/mmBTU)
Benzene	Refinery to Bulk Terminal	2002	E0	0.0488
	Refinery to Bulk Terminal	2022	E0	0.0270
	Bulk Terminal to Pump	2002	E0	0.0908
	Bulk Terminal to Pump	2022	E0	0.0502
	Bulk Terminal to Pump	2022	E10	0.0519
	Bulk Terminal to Pump	2022	E85	0.0228
	Ethanol	Bulk Terminal to Pump	2022	E10
Bulk Terminal to Pump		2022	E85	7.1432

As mentioned previously, ethanol vapor emissions during transport from the ethanol plant to the bulk terminal are based on an adjustment to the gasoline transport VOC emissions to account for the much lower vapor pressure and molecular weight.

There are also toxic emissions associated with combustion of fuels used in transport and distribution of feedstocks and fuels. The emission factors for these are shown in Table 3.1-28 as fractions of exhaust VOC, or PM10 for exhaust naphthalene. The VOC and PM10 emission factors that these fractions are applied to are presented above in Table 3.1-22. The locomotive, marine distillate, and residual boiler estimates come from a 2005 EPA report.⁶⁰⁴ The heavy-duty diesel truck emission fractions come from a 2002 report documenting the toxics module of EPA's MOBILE6.2 model,⁶⁰⁵ and the pipeline values come from the EPA AP-42 document.⁶⁰⁶

**Table 3.1-28.
Toxic Fractions of Exhaust VOC (or fraction of PM10 for exhaust naphthalene)
(grams toxics per gram of VOC or PM10)**

Mode	Source	1,3-Butadiene	Acetaldehyde	Acrolein	Benzene	Formaldehyde	Naphthalene
Rail	Diesel Locomotive	0.003246519	0.018786	0.0031238	0.002587511	0.04328653	0.0018716
Barge	Marine Diesel -- Distillate	0.00061	0.074298	0.0035	0.020344	0.1496	0.0018716
Ocean Tanker	Residual Boiler	0	0.003858	0	0.000165354	0.02645669	0.0025885
Truck	HD Diesel Trucks	0.00061	0.0288	0.0035	0.0105	0.0782	0.00128892
Pipeline	Natural Gas Turbines	0	0.019048	0.0030476	0.005714286	0.33809524	
Gasoline Farm Equip	HD Gasoline Trucks						0.088005387

3.2. Non-GHG Emission Impact Results

The reference case emission inventories used for this proposed rule are based on different sources depending on sector.

For stationary/area sources and aircraft we used the 2002 National Emissions Inventory (NEI), Version 3, including the NEI projections for 2020. The development of these inventories is documented in the November 27, 2007, memo titled, "Approach for Developing 2002 and Future Year National Emission Summaries," from Madeleine Strum to Docket EPA-HQ-OAR-2007-0491. That memo summarizes the methodologies and additional reference documents for criteria air pollutants (CAP) and mobile source air toxics (MSATs).

For onroad mobile sources we used a special version of the MOVES model that estimates emissions from light-duty and heavy-duty gasoline vehicles, except for motorcycles. For other onroad vehicles including diesel vehicles and motorcycles, we relied on the MOBILE6.2 model as run using the NMIM platform with county specific fuel properties and temperatures. Most nonroad equipment was modeled with NONROAD2005d using NMIM, which is a version of the NONROAD that includes the benefits of the two nonroad regulations published in 2008 (the locomotive and marine diesel rule and the small spark-ignition and recreational marine engine rule).

Inventories for locomotives and commercial marine vessels are not covered by the NONROAD model, and they have been updated since the 2002 NEI was published. Thus we used the more recent inventories published in the regulatory impact analyses of their respective recent rulemakings. Locomotives and C1/C2 commercial marine vessel inventories come from the spring 2008 final rule, and the C3 commercial marine emission inventory is from the Advance Notice of Proposed Rulemaking (ANPRM) published in late 2007.

Table 3.2-1 shows the total 2022 mobile and non-mobile source inventory projections that were used as the basis for the impact percentages shown above in Table 3.2-1 through 3.2-4. The mobile source values in this table use the inventory values of the AEO reference case.

Table 3.2-1. 2022 Reference Case Emissions by Sector

	VOC	CO	NOx	PM10	PM2.5	SO2	NH3
Onroad Gasoline	909,960	26,250,531	1,333,977	48,472	44,633	34,031	390,486
Onroad Diesel	140,854	243,820	501,660	29,894	16,533	4,352	11,426
Nonroad Gasoline	1,434,660	14,718,809	228,632	54,432	50,077	1,422	1,112
Other Nonroad ^a	276,526	1,608,678	3,379,781	232,711	212,053	1,027,440	3,035
Stationary/Area	8,740,057	11,049,239	5,773,927	3,194,610	3,047,714	7,864,681	3,839,925
Total	11,502,057	53,871,078	11,217,977	3,560,119	3,371,010	8,931,926	4,245,983

Table 3.2-1 continued	Benzene	Ethanol	1,3-Butadiene	Acetaldehyde	Formaldehyde	Naphthalene	Acrolein
Onroad Gasoline	25,363	43,875	3,282	6,623	7,866	4,037	384
Onroad Diesel	1,749	0	958	3,857	10,589	20	513
Nonroad Gasoline	26,193	71,433	4,935	4,033	7,245	713	436
Other Nonroad ^a	3,815	12	939	9,549	22,355	24	1,021
Stationary/Area	111,337	462,566	1,847	13,118	23,846	9,404	3,412
Total	168,457	577,885	11,961	37,181	71,901	14,198	5,766

^a Nonroad diesel, LPG, CNG engines and all locomotive, aircraft, and commercial marine

Our projected overall emission impacts for the less sensitive and more sensitive cases are shown in Table 3.2-2 and 3.2-3 for 2022, showing the expected emission changes for the U.S. in that year, and the percent contribution of this impact relative to the total U.S. inventory across all sectors relative to each of the reference cases.

Table 3.2-2.
RFS2 “Less Sensitive” Case Emission Impacts in 2022 Relative to Each Reference Case

Pollutant	RFS1 Base		RFS1 Mandate		AEO2007	
	Annual Short Tons	% of Total US Inventory	Annual Short Tons	% of Total US Inventory	Annual Short Tons	% of Total US Inventory
NOx	312,400	2.8%	274,982	2.5%	195,735	1.7%
HC	112,401	1.0%	72,362	0.6%	-8,193	-0.07%
PM10	50,305	1.4%	37,147	1.0%	9,276	0.3%
PM2.5	14,321	0.4%	11,452	0.3%	5,376	0.16%
CO	-2,344,646	-4.4%	-1,669,872	-3.1%	-240,943	-0.4%
Benzene	-2,791	-1.7%	-2,507	-1.5%	-1,894	-1.1%
Ethanol	210,680	36.5%	169,929	29.4%	83,761	14.5%
1,3-Butadiene	344	2.9%	255	2.1%	65	0.5%
Acetaldehyde	12,516	33.7%	10,369	27.9%	5,822	15.7%
Formaldehyde	1,647	2.3%	1,348	1.9%	714	1.0%
Naphthalene	5	0.03%	3	0.02%	-1	-0.01%
Acrolein	290	5.0%	252	4.4%	174	3.0%
SO2	28,770	0.3%	4,461	0.05%	-47,030	-0.5%
NH3	-27,161	-0.6%	-27,161	-0.6%	-27,161	-0.6%

Table 3.2-3.
RFS2 “More Sensitive” Case Emission Impacts in 2022 Relative to Each Reference Case

Pollutant	RFS1 Base		RFS1 Mandate		AEO2007	
	Annual Short Tons	% of Total US Inventory	Annual Short Tons	% of Total US Inventory	Annual Short Tons	% of Total US Inventory
NOx	402,795	3.6%	341,028	3.0%	210,217	1.9%
HC	100,313	0.9%	63,530	0.6%	-15,948	-0.14%
PM10	46,193	1.3%	33,035	0.9%	5,164	0.15%
PM2.5	10,535	0.3%	7,666	0.2%	1,589	0.05%
CO	-3,779,572	-7.0%	-3,104,798	-5.8%	-1,675,869	-3.1%
Benzene	-5,962	-3.5%	-5,494	-3.3%	-4,489	-2.7%
Ethanol	228,563	39.6%	187,926	32.5%	105,264	18.2%
1,3-Butadiene	-212	-1.8%	-282	-2.4%	-430	-3.6%
Acetaldehyde	16,375	44.0%	14,278	38.4%	9,839	26.5%
Formaldehyde	3,373	4.7%	3,124	4.3%	2,596	3.6%
Naphthalene	-175	-1.2%	-178	-1.3%	-187	-1.3%
Acrolein	253	4.4%	218	3.8%	143	2.5%
SO2	28,770	0.3%	4,461	0.05%	-47,030	-0.5%
NH3	-27,161	-0.6%	-27,161	-0.6%	-27,161	-0.6%

Fuel production and distribution emission impacts of the proposed program were estimated in conjunction with the development of life cycle GHG emission impacts, and the GHG emission inventories discussed in chapter 2. These emissions are calculated according to the breakdowns of agriculture, feedstock transport, fuel production, and fuel distribution; the basic calculation is a function of fuel volumes in the analysis year and the emission factors associated with each process or subprocess. Additionally, the emission impact of displaced petroleum is estimated, using the same domestic/import shares discussed in chapter 2.

In general the basis for this life cycle evaluation was the analysis conducted as part of the Renewable Fuel Standard (RFS1) rulemaking, but enhanced significantly. While our approach for the RFS1 was to rely heavily on the “Greenhouse Gases, Regulated Emissions, and Energy Use in Transportation” (GREET) model, developed by the Department of Energy’s Argonne National Laboratory (ANL), we are now able to take advantage of additional information and models to significantly strengthen and expand our analysis for this proposed rule. In particular, the modeling of the agriculture sector was greatly expanded beyond the RFS1 analysis, employing economic and agriculture models to consider factors such as land-use impact, agricultural burning, fertilizer, pesticide use, livestock, crop allocation, and crop exports.

Other updates and enhancements to the GREET model assumptions include updated emission factors for NO_x, CO, and SO₂ from new cellulosic ethanol plant modeling by the National Renewable Energy Laboratory (NREL), and updated fuel and feedstock transport emission factors that account for recent EPA emission standards and modeling, such as the Tier 4 diesel truck standards published in 2004 and the locomotive and commercial marine standards finalized in 2008. Emission factors for new corn ethanol plants continue to use the values developed for the RFS1 rule, which were based on data submitted by states for dry mill plants. There are no new standards planned at this time that would offer any additional control of emissions from corn or cellulosic ethanol plants. In addition, GREET does not include air toxics or ethanol. Thus emission factors for ethanol and the following air toxics were added: benzene, 1,3-butadiene, formaldehyde, acetaldehyde, acrolein and naphthalene.

Results of these calculations relative to each of the reference cases for 2022 are shown in Table 3.2-4 for the criteria pollutants, ammonia, ethanol and individual air toxic pollutants. It should be noted that the impacts relative to the two RFS1 reference cases (3.64 and 6.7 billion gallons) rely on applying ethanol volume proportions to the modeling results of the AEO reference case (13.2 billion gallons). Due to the complex interactions involved in projections in the agricultural modeling, we cannot say how reliable this simple proportional methodology is, and the modeling that had been done for the RFS1 rule itself was much simpler and inconsistent with the new modeling. Thus, we plan to conduct additional agricultural modeling specifically for the RFS1 mandate case prior to finalizing this rule.

The fuel production and distribution impacts of the proposed program on VOC are mainly due to increases in emissions connected with biofuel production, countered by decreases in emissions associated with gasoline production and distribution as ethanol displaces some of the gasoline. Increases in NO_x, PM_{2.5}, and SO_x are driven by combustion emissions from the substantial increase in corn and cellulosic ethanol production. Ethanol plants (corn and cellulosic) tend to have greater combustion emissions relative to petroleum refineries on a per-

British thermal unit (BTU) of fuel produced basis. Increases in SOx emissions are primarily due to corn ethanol production. Ammonia emissions are expected to decrease substantially due to lower livestock counts, which more than offsets increased ammonia from fertilizer use.

Ethanol vapor and most air toxic emissions associated with fuel production and distribution are projected to increase. Relative to the US total reference case emissions with RFS1 mandate ethanol volumes, increases of 10 - 20 percent for acetaldehyde and ethanol vapor are especially significant because they are driven directly by the increased ethanol production and distribution. Formaldehyde and acrolein increases are smaller, on the order of 1 - 5 percent. Benzene emissions are estimated to decrease by 1 percent due to decreased gasoline use. There are also very small increases in 1,3-butadiene and decreases in naphthalene relative to the US total emissions.

**Table 3.2-4.
Fuel Production and Distribution Impacts in 2022 Relative to Each Reference Case**

Pollutant	RFS1 Base		RFS1 Mandate		AEO2007	
	Annual Short Tons	% of Total US Inventory	Annual Short Tons	% of Total US Inventory	Annual Short Tons	% of Total US Inventory
NOx	241,041	2.1%	222,732	2.0%	183,951	1.6%
HC	77,295	0.7%	46,702	0.4%	-17,501	-0.2%
PM10	50,482	1.4%	37,324	1.1%	9,453	0.3%
PM2.5	14,419	0.4%	11,550	0.3%	5,473	0.16%
CO	186,559	0.3%	179,855	0.3%	165,656	-0.5%
Benzene	-1,670	-1.0%	-1,686	-1.0%	-1,719	-1.0%
Ethanol	115,187	19.9%	100,134	17.3%	68,379	11.8%
1,3-Butadiene	16	0.13%	16	0.14%	17	0.14%
Acetaldehyde	7,460	20.1%	6,680	18.0%	5,029	13.5%
Formaldehyde	877	1.2%	800	1.1%	638	0.9%
Naphthalene	-6	-0.04%	-5	-0.04%	-4	-0.03%
Acrolein	278	4.8%	244	4.2%	174	3.0%
SO2	28,770	0.3%	4,461	0.05%	-47,030	-0.5%
NH3	-27,161	-0.6%	-27,161	-0.6%	-27,161	-0.6%

A breakout of these upstream emissions by where they occur in the production/distribution chain is shown in Table 3.2-5. The displaced gasoline line of this table refers to the impacts of decreasing the petroleum based gasoline and diesel fuel production as some of the needed energy is replaced with ethanol and biodiesel fuels.

**Table 3.2-5. Emission Inventory Impacts by Fuel Production/Distribution Segment
Relative to the AEO Reference Case (annual short tons)**

	VOC	CO	NOx	PM10	PM2.5	SO2	NH3
Agriculture	-4,619	15,449	-8,454	17,074	4,108	12,773	-27,161
Biofuel Feedstock Transport	534	786	2,201	348	149	917	0
Biofuel Production	32,278	159,188	217,975	5,372	6,150	-37,629	0
Biofuel Transport & Distribution	-2,217	3,610	12,755	470	355	1,147	0
Displaced gasoline	-43,477	-13,377	-40,526	-13,812	-5,288	-24,238	0
Total Upstream	-17,501	165,656	183,951	9,453	5,473	-47,030	-27,161

Table 3.2-5 continued	Benzene	Ethanol	1,3- Butadiene	Acetal- dehyde	Formal- dehyde	Naphthalene ^b	Acrolein
Agriculture	-1,665	0	17.71	75	179	-1.25	-13
Biofuel Feedstock Transport	6	0	0.33	15	42	0.45	2
Biofuel Production	156	37,856	-0.01	4,986	835	0.01	191
Biofuel Transport & Distribution	-89	30,523	1.78	17	40	0.84	2
Displaced gasoline	-127	0	-3.22	-64	-458	-4.21	-8
Total Upstream	-1,719	68,379	16.59	5,029	638	-4.17	174

Tables 3.2-6 and 3.2-7 summarize the vehicle and equipment emission impacts in 2022 for the “less sensitive” and “more sensitive” cases, including the biodiesel impacts. Table 3.2-8 shows that the biodiesel contribution to these impacts is quite small. While the three fuel effect scenarios were only modeled for passenger cars and trucks, these totals reflect the net emissions from all mobile sources, including passenger cars and trucks, heavy duty trucks, off-road sources and portable fuel containers, using the same emissions in all three cases for the non-passenger car/truck categories. A full description of the basis of these vehicle and equipment emission impacts is given in Section 3.1.1 of this document.

**Table 3.2-6.
2022 Vehicle and Equipment Emission Impacts by Fuel Type
for the “Less Sensitive” Case Relative to Each Reference Case**

Pollutant	RFS1 Base		RFS1 Mandate		AEO2007	
	Annual Short Tons	% of Total US Inventory	Annual Short Tons	% of Total US Inventory	Annual Short Tons	% of Total US Inventory
NOx	71,359	0.6%	52,250	0.5%	11,784	0.11%
HC	35,106	0.3%	25,659	0.2%	9,308	0.08%
PM10	-177	0.00%	-177	0.00%	-177	0.00%
PM2.5	-98	0.00%	-98	0.00%	-98	0.00%
CO	-2,531,205	-4.7%	-1,849,728	-3.4%	-406,599	-0.8%
Benzene	-1,122	-0.7%	-821	-0.5%	-174	-0.1%
Ethanol	95,493	16.5%	69,795	12.1%	15,383	2.7%
1,3-Butadiene	328	2.7%	238	2.0%	48	0.4%
Acetaldehyde	5,057	13.6%	3,689	9.9%	793	2.1%
Formaldehyde	771	1.1%	548	0.8%	76	0.11%
Naphthalene	10	0.07%	8	0.05%	3	0.02%
Acrolein	12	0.2%	8	0.14%	-0.4	-0.01%
SO2	0	0.0%	0	0.0%	0	0.0%
NH3	0	0.0%	0	0.0%	0	0.0%

Table 3.2-7.
2022 Vehicle and Equipment Emission Impacts by Fuel Type
for the “More Sensitive” Case Relative to Each Reference Case

Pollutant	RFS1 Base		RFS1 Mandate		AEO2007	
	Annual Short Tons	% of Total US Inventory	Annual Short Tons	% of Total US Inventory	Annual Short Tons	% of Total US Inventory
NOx	161,754	1.4%	118,295	1.1%	26,266	0.2%
HC	23,018	0.2%	16,828	0.15%	1,553	0.01%
PM10	-4,289	-0.12%	-4,289	-0.12%	-4,289	-0.12%
PM2.5	-3,884	-0.12%	-3,884	-0.12%	-3,884	-0.12%
CO	-3,966,131	-7.4%	-3,284,654	-6.1%	-1,841,524	-3.4%
Benzene	-4,293	-2.6%	-3,808	-2.3%	-2,770	-1.6%
Ethanol	113,376	19.6%	87,792	15.2%	36,886	6.4%
1,3-Butadiene	-228	-1.9%	-298	2.5%	-446	-3.7%
Acetaldehyde	8,915	24.0%	7,598	20.4%	4,809	12.9%
Formaldehyde	2,497	3.5%	2,324	3.2%	1,958	2.7%
Naphthalene	-170	-1.2%	-172	-1.2%	-182	-1.3%
Acrolein	-25	-0.4%	-27	-0.5%	-31	-0.5%
SO2	0	0.0%	0	0.0%	0	0.0%
NH3	0	0.0%	0	0.0%	0	0.0%

Table 3.2-8.
2022 Biodiesel Emission Impacts Relative to All Reference Cases
(these impacts are included in Tables 3.2-5 and 3.2-6)

Pollutant	Biodiesel Impacts
	Annual Short Tons
NOx	418
HC	-753
PM10	-177
PM2.5	-98
CO	-1,275
Benzene	-9.4
Ethanol	0.0
1,3-Butadiene	-5.1
Acetaldehyde	-21
Formaldehyde	-57
Naphthalene	-0.12
Acrolein	-2.7
SO2	0.0
NH3	0.0

Table 3.2-9 shows a breakout of the relative impacts of this proposal on the various types of vehicle and equipment emissions for the more sensitive case relative to the AEO reference case. The gasoline vehicle exhaust emission values were generated by MOVES, while the NMIM model was used to generate the other vehicle and equipment emission impacts. The impacts on portable fuel container emissions were estimated using an analysis of available data, adjusted for the ethanol and gasoline fuel volumes in this proposal. The methods used are described above in Section 3.1.1. The substantial CO and PM reductions from light-duty vehicles are due to the effects of E85. Evaporative and refueling vapor emissions only include VOC, benzene, and naphthalene.

Table 3.2-9. Vehicle and Equipment Emission Inventory Impacts by Source Type for the “More Sensitive” Case Relative to the AEO Reference Case (annual short tons)

	VOC ^a	CO	NO _x	PM10	PM2.5	SO ₂	NH ₃
Light-duty gasoline vehicle exhaust	-1,945	-1,418,363	14,258	-4,112	-3,786	0	0
Light-duty gasoline vehicle evap	-2,549	n/a ^b	n/a	n/a	n/a	n/a	n/a
Light-duty gasoline vehicle refueling	4,476	n/a	n/a	n/a	n/a	n/a	n/a
Heavy-duty gasoline vehicle exhaust	-141	839	1,060	0	0	0	0
Heavy-duty gasoline vehicle evap	44	n/a	n/a	n/a	n/a	n/a	n/a
Heavy-duty gasoline vehicle refueling	977	n/a	n/a	n/a	n/a	n/a	n/a
Nonroad gasoline equipment exhaust	-6,810	-422,725	10,530	0	0	0	0
Nonroad gasoline equipment evap	7,216	n/a	n/a	n/a	n/a	n/a	n/a
Nonroad gasoline equipment refueling	6,609	n/a	n/a	n/a	n/a	n/a	n/a
Portable fuel containers	1,037	n/a	n/a	n/a	n/a	n/a	n/a
Onroad diesel vehicles	-753	-1,275	418	-177	-98	0	0

Table 3.2-9 continued	Benzene	Ethanol	1,3- Butadiene	Acetal- dehyde	Formal- dehyde	Naph- thalene^b	Acrolein
Light-duty gasoline vehicle exhaust	-2,758	19,850	-474	4,489	1,948	-180	-29
Light-duty gasoline vehicle evap	27	7,981	n/a	n/a	n/a	-4	n/a
Light-duty gasoline vehicle refueling	15	1,034	n/a	n/a	n/a	2	n/a
Heavy-duty gasoline vehicle exhaust	-19	109	0.46	33	4.6	0	0
Heavy-duty gasoline vehicle evap	0.39	77	n/a	n/a	n/a	0.02	n/a
Heavy-duty gasoline vehicle refueling	3	214	n/a	n/a	n/a	0.11	n/a
Nonroad gasoline equipment exhaust	-156	3,071	32	308	63	0	1.2
Nonroad gasoline equipment evap	128	4,937	n/a	n/a	n/a	0	n/a
Nonroad gasoline equipment refueling	108	1,645	n/a	n/a	n/a	0	n/a
Portable fuel containers	-0.30	646	n/a	n/a	n/a	0.13	n/a
Onroad diesel vehicles	-9	0	-5	-21	-57	-0.12	-3

^a "VOC" values shown are actually THC for onroad gasoline exhaust and evaporative emissions.

^b n/a = Not applicable

Table 3.2-10 shows the relative impacts of various types of renewable fuels on the basis of tons per million BTUs of renewable fuel consumed. These values include all vehicle/equipment as well as upstream fuel production/distribution impacts.

**Table 3.2-10. Emission Inventory Impacts (tons per mmBTU)
by Type of Renewable Fuel Relative to the AEO Reference Case**

	VOC	CO	NOx	PM10	PM2.5	SO2	NH3
Ethanol from domestic corn (except coal)	32.50	-1,131	57.45	41.72	3.62	111.30	-18.85
Ethanol from domestic corn (coal)	-72.28	-1,038	-12.47	332.23	79.56	-131.38	-11.85
Ethanol from domestic cellulosic	-9.32	-1,035	131.30	-0.40	1.69	-55.03	-18.88
Ethanol from imported sugarcane	-23.82	-1,174	-30.37	-10.54	-5.33	-13.71	0.29
Biodiesel	-37.11	-15.20	5.02	4.97	0.35	10.78	-11.04
Renewable Diesel	-24.37	-3.85	-10.63	-2.69	-0.82	-4.85	0.00
Ethanol from domestic corn (except coal)	-0.94	43.35	0.0120	3.42	0.50	-0.0025	0.64
Ethanol from domestic corn (coal)	-0.60	43.35	0.0073	3.40	0.44	-0.0022	0.46
Ethanol from domestic cellulosic	-0.94	47.27	0.0119	3.67	0.51	-0.0026	0.63
Ethanol from imported sugarcane	0.12	19.39	-0.0008	-0.0272	-0.25	-0.0020	0.505
Biodiesel	-0.61	2.89E-07	0.0057	0.0095	-0.15	-0.0026	0.289
Renewable Diesel	-0.072	0	-0.0012	-0.0273	-0.25	-0.0022	-0.0035

3.3 Air Quality Impacts

Section 3.2 of this DRIA presents the projected emissions changes due to the proposed rule. Once the emissions changes are projected, the next step is to look at how the ambient air quality would be impacted by those emissions changes. This section presents information about ambient air quality, including discussion of the methodology that we will use to perform ambient air quality modeling for the final rule. Section 3.4 describes the health effects associated with criteria and air toxic pollutants. Section 5.4 describes the methodology for calculating monetized benefits of this rule due to reductions in adverse health effects associated with PM2.5 and ozone.

3.3.1 Air Quality Modeling

Air quality models use mathematical and numerical techniques to simulate the physical and chemical processes that affect air pollutants as they disperse and react in the atmosphere. Based on inputs of meteorological data and source information, these models are designed to characterize primary pollutants that are emitted directly into the atmosphere and secondary pollutants that are formed as a result of complex chemical reactions within the atmosphere. Photochemical air quality models have become widely recognized and routinely utilized tools for regulatory analysis by assessing the effectiveness of control strategies. These models are applied at multiple spatial scales - local, regional, national, and global. Section 3.3.1.2 of this DRIA provides more detail on the photochemical model, the Community Multi-scale Air Quality (CMAQ) model, which will be utilized for the final rule analysis.

3.3.1.1 Current and Projected Ambient Levels of Pollutants

Although the purpose of this proposal is to implement the renewable fuel requirements established by the Energy Independence and Security Act (EISA) of 2007, this proposed rule would also impact emissions of criteria and air toxic pollutants. This section describes current and recently projected ambient levels of ozone, PM and some air toxics without the standards being proposed in this rule.

3.3.1.1.1 Particulate Matter (PM_{2.5} and PM₁₀)

As of December 16, 2008, approximately 88 million people live in the 39 areas that are designated as nonattainment for the 1997 PM_{2.5} National Ambient Air Quality Standard (NAAQS). These PM_{2.5} nonattainment areas are comprised of 208 full or partial counties. The 1997 PM_{2.5} NAAQS was recently revised and the 2006 24-hour PM_{2.5} NAAQS became effective on December 18, 2006. Area designations for the 2006 24-hour PM_{2.5} NAAQS are expected to be promulgated in 2009 and become effective 90 days after publication in the Federal Register.

As of December 16, 2008, approximately 26 million people live in the 47 areas that are designated as nonattainment for the PM₁₀ NAAQS. There are 40 full or partial counties that make up the PM₁₀ nonattainment areas.

EPA has already adopted many mobile source emission control programs that are expected to reduce ambient PM levels. These control programs include the Marine Spark-Ignition and Small Spark-Ignition Engine rule (73 FR 59034, October 8, 2008), Locomotive and Marine Compression-Ignition Engine Rule (73 FR 25098, May 6, 2008), the Clean Air Nonroad Diesel rule (69 FR 38957, June 29, 2004), the Heavy Duty Engine and Vehicle Standards and Highway Diesel Fuel Sulfur Control Requirements (66 FR 5002, Jan. 18, 2001) and the Tier 2 Motor Vehicle Emissions Standards and Gasoline Sulfur Control Requirements (65 FR 6698, Feb. 10, 2000). As a result of these programs, the number of areas that fail to meet the PM_{2.5} NAAQS in the future is expected to decrease. This decrease is shown in the PM air quality analyses that were performed for the Marine Spark-Ignition and Small Spark-Ignition Engine

rule.^{PPPPPPP} That analysis projected that there would be 11 counties (down from 208 counties currently designated as nonattainment), where 24 million people are projected to live, with PM_{2.5} design values at or above the 2006 annual PM_{2.5} standard in 2020.

3.3.1.1.2 Ozone

As of December 16, 2008, approximately 132 million people live in the 57 areas that are designated as nonattainment for the 1997 8-hour ozone NAAQS. There are 293 full or partial counties that make up the 8-hour ozone nonattainment areas. The 1997 ozone NAAQS was recently revised and the 2008 ozone NAAQS was finalized on March 12, 2008. Table 3.3-2 presents the number of counties in areas currently designated as nonattainment for the 1997 ozone NAAQS as well as the number of additional counties that have monitored data that is greater than the 2008 ozone NAAQS.

**Table 3.3-2.
Counties with Design Values Greater than the 2008 Ozone NAAQS
Based on 2004-2006 Air Quality Data**

	Number of Counties	Population ^a
1997 Ozone Standard: counties within the 57 areas currently designated as nonattainment	293	131,977,890
2008 Ozone Standard: additional counties that would not meet the 2008 NAAQS ^b	74	15,984,135
Total	367	147,962,025

Notes:

^a Population numbers are from 2000 census data.

^b Attainment designations for the 2008 ozone NAAQS have not yet been made. Nonattainment for the 2008 Ozone NAAQS will be based on three years of air quality data from later years. Also, the county numbers in the table include only the counties with monitors violating the 2008 Ozone NAAQS. The numbers in this table may be an underestimate of the number of counties and populations that will eventually be included in areas with multiple counties designated nonattainment.

EPA has already adopted many mobile source emission control programs that are expected to reduce ambient ozone levels. These control programs include the Marine Spark-Ignition and Small Spark-Ignition Engine rule (73 FR 59034, October 8, 2008), Locomotive and Marine Compression-Ignition Engine Standards (73 FR 25098, May 6, 2008), the Clean Air Nonroad Diesel rule (69 FR 38957, June 29, 2004), the Heavy Duty Engine and Vehicle Standards and Highway Diesel Fuel Sulfur Control Requirements (66 FR 5002, Jan. 18, 2001) and the Tier 2 Motor Vehicle Emissions Standards and Gasoline Sulfur Control Requirements (65 FR 6698, Feb. 10, 2000). As a result of these programs, the number of areas that fail to meet the 8-hour ozone NAAQS in the future is expected to decrease. This decrease in areas that fail to meet the 8-hour ozone NAAQS is shown in the ozone air quality analyses that were performed for the Marine Spark-Ignition and Small Spark-Ignition Engine rule.^{QQQQQQQ} That analysis projected that there would be 8 counties (down from 293 counties currently designated as

^{PPPPPPP} Details on the air quality modeling are provided in the RIA for the Marine Spark-Ignition and Small Spark-Ignition Engine final rule, included in the docket for this proposed rule.

^{QQQQQQQ} Details on the air quality modeling are provided in the RIA for the Marine Spark-Ignition and Small Spark-Ignition Engine final rule, included in the docket for this proposed rule.

nonattainment), where 22 million people are projected to live, with 8-hour ozone design values at or above 85 ppb in 2020.

3.3.1.1.3 Air Toxics

According to the National Air Toxic Assessment (NATA) for 1999, mobile sources were responsible for 44 percent of outdoor toxic emissions and almost 50 percent of the cancer risk. Benzene is the largest contributor to cancer risk of all 133 pollutants quantitatively assessed in the 1999 NATA. Mobile sources were responsible for 68 percent of benzene emissions in 1999. Over the years, EPA has implemented a number of mobile source and fuel controls resulting in VOC reductions, which also reduce benzene and other air toxic emissions. Recent fuel and vehicle standards were implemented to specifically control benzene emissions, and it is expected that overall levels of air toxics will decrease through 2020, after which concentrations start to increase slowly due to expected increases in vehicle and engine activity.⁶⁰⁷

However, as presented in Section 3.2 of this DRIA, there would be a substantial increase in emissions of ethanol and acetaldehyde from the proposed fuels standards. This suggests a likely increase in ambient levels of acetaldehyde. Formaldehyde and acrolein emissions would also increase somewhat, while emissions of benzene and 1,3-butadiene would decrease as a result of the proposed standards. Full-scale photochemical modeling is necessary to provide the needed spatial and temporal detail to more completely and accurately estimate the changes in ambient levels of both criteria and non-criteria pollutants. The plans for full-scale photochemical air quality modeling are discussed immediately below in Section 3.3.1.2.

3.3.1.2 Community Multi-scale Air Quality (CMAQ) Modeling Plans

Full-scale photochemical air quality modeling is necessary to accurately project levels of PM_{2.5}, ozone and air toxics. For the final rule, a national-scale air quality modeling analysis will be performed to analyze the impacts of the standards on PM_{2.5}, ozone, and selected air toxics. The length of time needed to prepare necessary inventory and model updates precluded us from performing air quality modeling for this proposal.

The atmospheric chemistry related to ambient concentrations of PM_{2.5}, ozone and air toxics is very complex, and making predictions based solely on emissions changes is extremely difficult. Localized changes in VOC and NO_x emissions, as well as direct PM and PM precursors may impact concentrations of PM and ozone. Air quality modeling will allow us to account for both changes in the spatial distribution of PM and PM precursors, and changes in VOC speciation which could impact secondary PM formation. For example, reductions in aromatics in gasoline might reduce ambient PM concentrations by reducing secondary PM formation. Section 3.3.3 of this DRIA contains more information on aromatics and secondary aerosol formation.

In addition, air quality modeling would account for changes in fuel type and spatial distribution of fuels that would change emissions of ozone precursor species and thus could affect ozone concentrations. Section 3.3.2 of this DRIA provides more detail on the atmospheric chemistry and potential changes in ozone formation due to increased usage of ethanol fuels.

For the final rule, EPA intends to use a 2005-based CMAQ modeling platform as the tool for the air quality modeling. The CMAQ modeling system is a comprehensive three-dimensional grid-based Eulerian air quality model designed to estimate the formation and fate of oxidant precursors, primary and secondary PM concentrations and deposition, and air toxics, over regional and urban spatial scales (e.g., over the contiguous U.S.).^{608,609,610} The CMAQ model is a well-known and well-respected tool and is commonly used for both regulatory analyses, for instance the recent ozone NAAQS rule⁶¹¹, and in developing attainment demonstration State Implementation Plans. The CMAQ model (version 4.6) was peer-reviewed in February of 2007 for EPA as reported in “Third Peer Review of CMAQ Model.”⁶¹²

CMAQ includes many science modules that simulate the emission, production, decay, deposition and transport of organic and inorganic gas-phase and particle-phase pollutants in the atmosphere. We intend to use the most recent CMAQ version (v4.7) which was officially released by EPA’s Office of Research and Development (ORD) in December 2008, and reflects updates to earlier versions in a number of areas to improve the underlying science. These include (1) enhanced secondary organic aerosol (SOA) mechanism to include chemistry of isoprene, sesquiterpene, and aged in-cloud biogenic SOA in addition to terpene; (2) improved vertical convective mixing; (3) improved heterogeneous reaction involving nitrate formation; and (4) an updated gas-phase chemistry mechanism, Carbon Bond 05 (CB05), with extensions to model explicit concentrations of air toxic species as well as chlorine and mercury. This mechanism, CB05-toxics, also computes concentrations of species that are involved in aqueous chemistry and that are precursors to aerosols. Section 3.3.3 of the DRIA for this proposal discusses SOA formation and details about the improvements made to the SOA mechanism within this recent release of CMAQ.

As shown in Figure 3.3-3 the CMAQ modeling domain covers the continental U.S. and portions of Canada and Mexico. There are two 12 x 12 km horizontal grid resolution modeling domains, an Eastern US domain (outlined in red) and a Western US domain (outlined in blue). The modeling domain contains 14 vertical layers with the top of the modeling domain at about 16,200 meters, or 100 millibars (mb).

Figure 3.3-3. CMAQ 12-km Eastern and Western US Modeling Domains

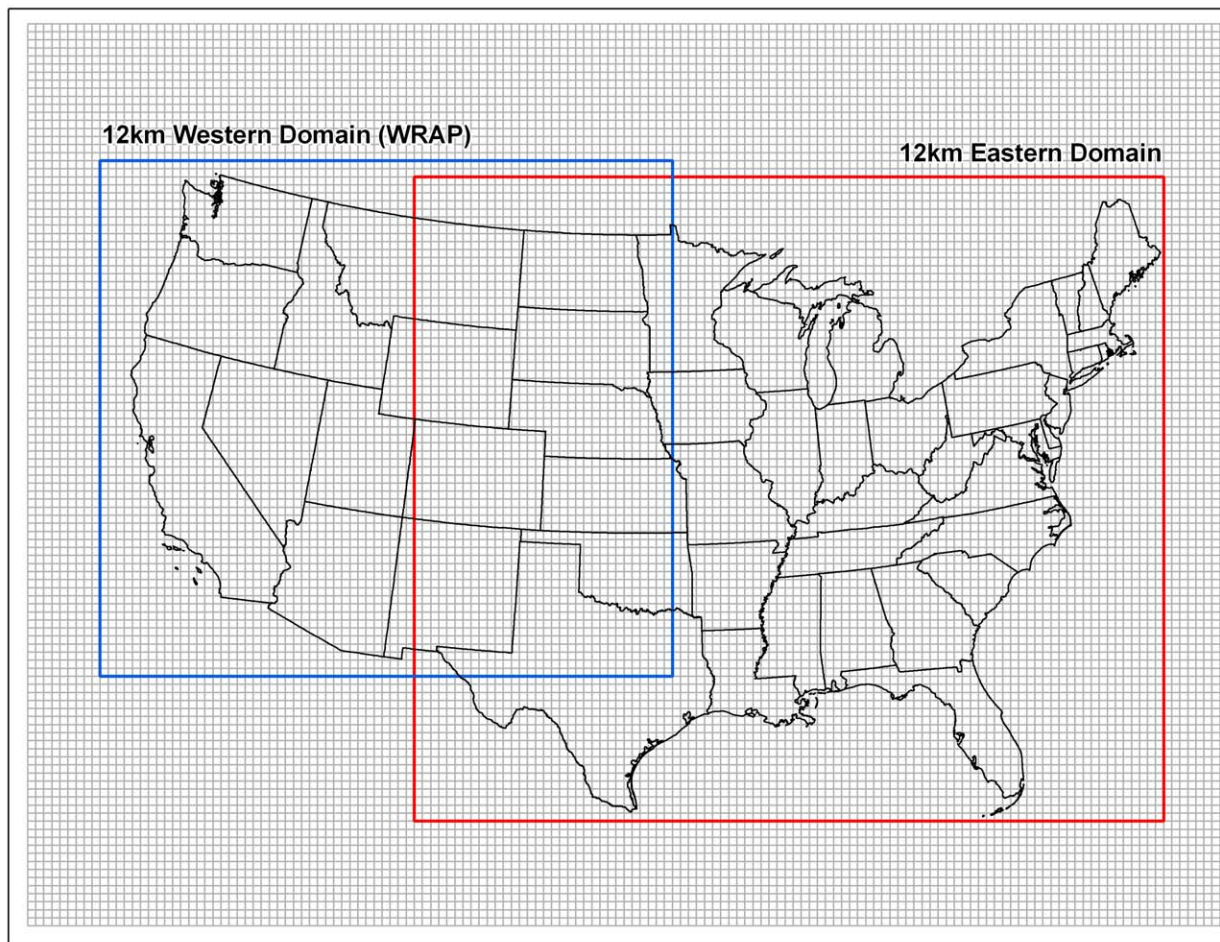

The key inputs to the CMAQ model include emissions from anthropogenic and biogenic sources, meteorological data, and initial and boundary conditions. The CMAQ meteorological input files will be derived from a simulation of the Pennsylvania State University / National Center for Atmospheric Research Mesoscale Model⁶¹³ for the entire year of 2005. This model, commonly referred to as MM5, is a limited-area, nonhydrostatic, terrain-following system that solves for the full set of physical and thermodynamic equations which govern atmospheric motions. The meteorology for the national 36 km grid and the 12 km Eastern and Western U.S. grids will be developed by EPA and described in more detail within the Air Quality Modeling Technical Support Document for the final rule.⁶¹⁴ The meteorological outputs from MM5 will be processed to create model-ready inputs for CMAQ using the Meteorology-Chemistry Interface Processor (MCIP) version 3.4 to derive the specific inputs to CMAQ, for example: horizontal wind components (i.e., speed and direction), temperature, moisture, vertical diffusion rates, and rainfall rates for each grid cell in each vertical layer.⁶¹⁵

The lateral boundary and initial species concentrations will be provided by a three-dimensional global atmospheric chemistry model, the GEOS-CHEM model.⁶¹⁶ The global GEOS-CHEM model simulates atmospheric chemical and physical processes driven by assimilated meteorological observations from the NASA's Goddard Earth Observing System

(GEOS). This model will be run for 2005 with a grid resolution of 2 degree x 2.5 degree (latitude-longitude) and 30 vertical layers. The predictions will be used to provide one-way dynamic boundary conditions and an initial concentration field for the 36 km CMAQ simulations. The future base conditions from the 36 km coarse grid modeling will be used as the initial/boundary state for all subsequent 12 km finer grid modeling.

3.3.2 Atmospheric Reactions Associated with Ethanol in Gasoline

Ethanol, molecular formula $\text{CH}_3\text{CH}_2\text{OH}$, is a volatile organic hydrocarbon and is present in the gas-phase in the atmosphere.⁶¹⁷ Complete combustion of ethanol in fuel produces carbon dioxide (CO_2) and water (H_2O).

Incomplete combustion results in the production of other air pollutants, such as acetaldehyde and other aldehydes, and the release of unburned ethanol. Ethanol is also present in evaporative emissions. In the atmosphere, ethanol from unburned fuel and evaporative emissions can undergo photodegradation to form aldehydes (acetaldehyde and formaldehyde) and peroxyacetyl nitrate (PAN), and also plays a role in ground level ozone formation.

Based on kinetic data for molecular reactions, the only important chemical loss process for ethanol (and other alcohols) is reaction with the hydroxyl radical ($\cdot\text{OH}$).⁶¹⁸ This reaction produces acetaldehyde (CH_3CHO) with a 90% yield.⁶¹⁹ The lifetime of ethanol in the atmosphere can be calculated from the rate coefficient, k , and due to reaction with the OH radical, occurs on the order of hours in polluted urban areas or several days in unpolluted areas. (All rate coefficients are listed at 298 K and, if applicable, 1 bar of air.)

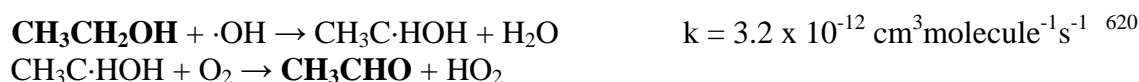

Reactions of ethanol (and other alcohols) with nitrate radical, ozone, and photolysis are slow and of negligible importance in the atmosphere.

3.3.2.1 Aldehydes

3.3.2.1.1 Acetaldehyde

Acetaldehyde is the main photodegradation product of ethanol (see Section 3.3.2 of this DRIA) as well as other precursor hydrocarbons. Acetaldehyde is also a product of fuel combustion. In the atmosphere, acetaldehyde can react with the OH radical and O_2 to form the acetyl peroxy radical [$\text{CH}_3\text{C}(\text{O})\text{OO}\cdot$].^{RRRRRRRR} This radical species can then further react with nitric oxide (NO), to produce formaldehyde (HCHO), or with nitrogen dioxide (NO_2), to produce PAN [$\text{CH}_3\text{C}(\text{O})\text{OONO}_2$]. An overview of these reactions and the corresponding reaction rates are provided below.

^{RRRRRRRR} Acetaldehyde is not the only source of acetyl peroxy radicals in the atmosphere. For example, dicarbonyl compounds (methylglyoxal, biacetyl, and others) also form acetyl radicals, which can further react to form peroxyacetyl nitrate (PAN).

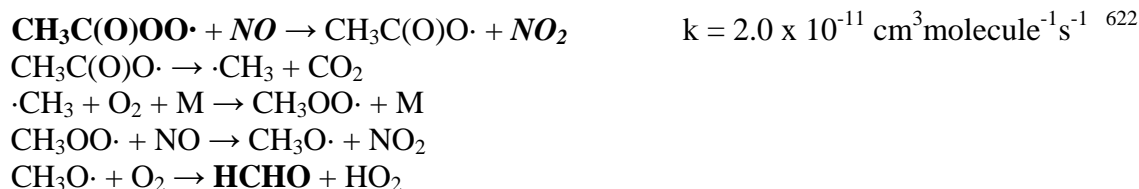
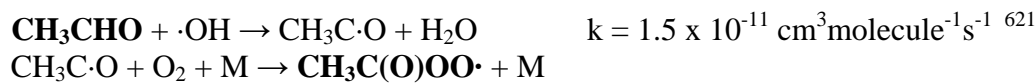

Acetaldehyde can also photolyze (hv), which predominantly produces $\cdot\text{CH}_3$ and HCO:



As described above, $\cdot\text{CH}_3$ is oxidized in the atmosphere to produce formaldehyde (HCHO).

3.3.2.1.2 Formaldehyde

Formaldehyde is the photodegradation product of acetaldehyde (DRIA Section 3.3.2.1.1 above) as well as other precursor hydrocarbons. Formaldehyde is also a product of hydrocarbon combustion. In the atmosphere, formaldehyde undergoes photolysis and reaction with the OH radical, NO₃ radical, and ozone, and the resulting lifetimes are ~4 hours, 1.2 days, 83 days, and >4.5 years, respectively.^{SSSSSSS} Formaldehyde is removed mainly by photolysis whereas the higher aldehydes, those with two or more carbons such as acetaldehyde, react predominantly with OH radicals. The photolysis of formaldehyde is important since it is a source of additional radicals.

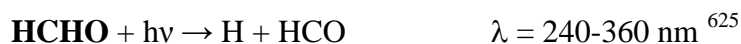

3.3.2.2 Peroxyacetyl Nitrate (PAN)

PAN is a reservoir and carrier of NO_x. PAN is the product of acetyl radicals reacting with NO₂ in the atmosphere. One source of PAN is the photooxidation of acetaldehyde (see Section 3.3.2.1.1 of this DRIA), but any hydrocarbon having a methyl group has the potential for forming acetyl radicals and therefore PAN.^{TTTTTTTT} PAN can undergo thermal decomposition with a lifetime of approximately 1 hour at 298K or 148 days at 250K.



^{SSSSSSS} Lifetime calculated using the following: for photolysis, with overhead sun (at noontime during the summer); for OH radical reactions, a 12-hour daytime average of $2.0 \times 10^6 \text{ molecule cm}^{-3}$; for NO₃ radical reactions, a 12-hour nighttime average of $5 \times 10^8 \text{ molecule cm}^{-3}$; and for ozone, a 24-hour average of $7 \times 10^{11} \text{ molecule cm}^{-3}$.

^{TTTTTTTT} Many aromatic hydrocarbons, particularly those present in high percentages in gasoline (toluene, m-, o-, p-xylene, and 1,3,5-, 1,2,4-trimethylbenzene), form methylglyoxal and biacetyl, which are also strong generators of acetyl radicals (Smith, D.F., T.E. Kleindienst, C.D. McIver (1999) Primary product distribution from the reaction of OH with m-, p-xylene and 1,2,4- and 1,3,5-Trimethylbenzene. J. Atmos. Chem., 34: 339- 364.).

This temperature sensitivity allows PAN to be stable enough at low temperatures to be transported long distances before decomposing to release NO₂. NO₂ can then participate in ozone formation in regions remote from the original NO_x source.⁶²⁷

3.3.2.3 Ozone Formation

The series of reactions described above plays a role in the formation of ground level ozone. In the photodegradation reactions, NO is converted to NO₂ (see OH radical reaction of acetaldehyde in Section 3.3.2.1.1 of this DRIA). In the thermal decomposition of PAN, NO₂ is released. In both cases, NO₂ further photolyzes to produce ozone (O₃).



3.3.2.4 Chemical Mechanisms in Modeling

The RFS2 rule is presenting inventories for ethanol and six air toxics -- benzene, 1,3-butadiene, formaldehyde, acetaldehyde, acrolein, and naphthalene. All of these compounds are explicit model species in the CMAQv4.7 model with carbon bond 5 (CB05) mechanisms.⁶²⁹ However, CMAQ also requires inventories for a large number of other air toxics and precursor pollutants. Inventories for these other pollutants will be developed either by running the National Mobile Inventory Model (NMIM) or by application of speciation profiles to VOC.

Emissions of benzene, 1,3-butadiene, formaldehyde, acetaldehyde, acrolein, and naphthalene for light duty gasoline vehicles will be generated using the Motor Vehicle Emissions Simulator (MOVES). Ethanol emissions for air quality modeling will be based on speciation of VOC using different ethanol profiles (E0, E10, and E85). Light duty gasoline vehicle air toxic emissions not modeled by MOVES will be based on NMIM outputs, as will emissions of mobile source air toxic pollutants from other vehicle classes and nonroad engines. All other pollutants will be modeled by application of speciation profiles to VOC. MOVES, NMIM, and the speciation profiles which will be used all account for impacts of ethanol on emissions.

CMAQ has the capability to track and quantify primary emissions of acetaldehyde separately from acetaldehyde formed by secondary reactions. In determining how much of the acetaldehyde in ambient air is from primary (emitted) versus secondary (produced in the atmosphere) sources, CMAQ would account for the degradation of primary emissions of acetaldehyde (lessening the impact of these emissions on total acetaldehyde) plus the formation of secondary acetaldehyde from other precursors.

The CB05 mechanisms also have a species^{UUUUUUUU} representing higher molecular weight aldehydes, those with three or more carbons. These aldehydes form, among other products, acetaldehyde. To the extent that these higher molecular weight aldehydes decrease or increase in the exhaust with increased use of ethanol, the amount of acetaldehyde formed in the ambient air is affected. The amount of acetaldehyde, as well as formaldehyde, formed in the

^{UUUUUUUU} The word species represents a technique used to lump several similar compounds into a single 'bin' for streamlining the numerical calculations performed by the model.

ambient air as well as emitted in the exhaust (the latter being accounted for in emission inventories) would also be affected by any changes in alkanes and alkenes due to the addition of ethanol to fuels (i.e., decreases in alkanes and alkenes would cause some decrease of acetaldehyde, and to a larger extent, formaldehyde). As mentioned above, the exhaust level of these aldehydes could be affected by use of ethanol which would also be incorporated into the modeling.

The addition of ethanol to fuels has been shown to contribute to PAN formation and therefore ozone formation (discussed below in DRIA Section 3.3.2.5), and these compounds would be quantified by CMAQ. Additionally, other aromatic hydrocarbons (AHC) and hydrocarbons are considered because any increase in acetyl peroxy radicals due to ethanol increases might be counterbalanced by a decrease in radicals resulting from decreases in AHC and other hydrocarbons.

CMAQ includes 63 inorganic reactions to account for the cycling of all relevant oxidized nitrogen species and cycling of radicals, including the termination of NO₂ and formation of nitric acid (HNO₃) without PAN formation.



The CB05 mechanism also includes more than 90 organic reactions that include alternate pathways for the formation of acetyl peroxy radical, such as by reaction of methylglyoxal, which is also formed from reactions of AHC. Alternate reactions of acetyl peroxy radical, such as oxidation of NO to form NO₂, which again leads to ozone formation, are also included.

It is unclear whether ozone and other atmospheric oxidants (such as OH radical) would increase or decrease with the increased usage of ethanol fuels, or where the largest impacts would occur. The decreases in hydrocarbons other than ethanol in fuels, especially the AHC, would counteract the effects of increased acetaldehyde exhaust emissions to some extent, since AHC contribute to ozone formation. NO_x increases or decreases would also have a critical effect on ozone. Moreover, changes in CO emissions would also impact regional background ozone. Modeling the ethanol fuels exhaust and evaporative emissions and the complex chemistry they undergo in the ambient atmosphere would allow a better assessment of the impacts of the changes in fuel composition.

3.3.2.5 Ambient Monitoring and Modeling Data

Ambient monitoring and modeling studies in the US and abroad quantify the relative concentrations of ethanol emissions and the potential air quality impacts of using ethanol in fuels.

3.3.2.5.1 US Studies

In the late 1980s Denver, Colorado adopted the first regulation in the country that required the use of oxygenated fuels to reduce carbon monoxide (CO) emissions. From the time the regulation was first adopted, the fuels used shifted from methyl tertiary butyl ether (MTBE)

and gasoline to largely ethanol-blended fuels. By the winter of 1996-1997, nearly all of the fuel was blended with ethanol at 10% by volume. The effect of using oxygenated fuels on formaldehyde and acetaldehyde concentrations were monitored from the winter of 1987-1988 (95% of fuel blended with MTBE) through the winter of 1996-1997 (nearly all fuel blended with ethanol).⁶³¹ Results showed no clear effect on ambient concentrations of formaldehyde and acetaldehyde through ten winters of oxygenated fuels use. It was hypothesized that the photochemical destruction of these compounds suppressed the emissions effect.

Albuquerque, NM is another location that mandated the use of oxygenates in the wintertime to reduce CO emissions. A field study was conducted in Albuquerque to determine the atmospheric impacts of the use of ethanol fuels.⁶³² Atmospheric concentrations of ozone, NO_x, CO, PAN, aldehydes, and organic acids were measured in the summer of 1993, before the use of ethanol fuels, and in the winters of 1994 and 1995, during the use of 10% ethanol fuel (>99%). Results showed increased levels of PAN and aldehydes in winter. Seasonal differences were not accounted for. The authors noted that the daytime temperatures were fairly comparable for the summer and winter study periods so it appeared that the significantly higher winter values, despite the much lower photochemical reactivity in winter, were primarily due to local production of PAN. For acetaldehyde, winter values were about twice as high as the summer values. These acetaldehyde levels anti-correlated with PAN levels, indicating a primary source of aldehydes in the winter.

Grosjean et al (2002) conducted monitoring studies in various California cities and measured daily maximum PAN concentrations ranging from 0.2 to 6.9 ppb.⁶³³ Peroxypropionyl nitrate (PPN, a compound similar to PAN) concentrations were measured at lower levels and ranged from 0.33-1.04 ppb. This study concluded that aromatics and alkene compounds are responsible for significant PAN formation with ethanol and acetaldehyde having a minor role.

A modeling analysis performed by the California Air Resources Board suggests PAN formation with increased use of ethanol, but the increase was somewhat minimal.⁶³⁴ Acetaldehyde and ethanol concentrations were shown to increase for the ethanol-blended fuels by 1 to 6% and 37 to 121%, respectively. The changes in acetaldehyde and ethanol concentrations were predicted to lead to a 1 to 3% increase in PAN concentration, similar to the 3% increase in PAN concentration predicted for the non-oxygenated gasoline. Benzene (0 to -9%), formaldehyde (-1 to -2%), and NO₂ (0 to 1%) concentrations stayed the same or decreased, and changes in 1,3-butadiene (-2 to 2%) and PPN (-1 to 4%) were similarly modest. Consequently, a sensitivity analysis of PAN formation indicated that increases in acetaldehyde and ethanol emissions would not lead to substantially higher PAN concentrations, presumably because other VOCs are larger contributors to PAN formation.

Another air quality modeling study investigated the impacts of widespread usage of E85 in Los Angeles and the US in 2020.⁶³⁵ Overall results showed increases in acetaldehyde and formaldehyde and decreases in 1,3-butadiene and benzene in Los Angeles and the US. Sources of acetaldehyde included direct emissions and to a larger degree photooxidation of unburned ethanol. Results of this modeling study also showed increases in unburned ethanol, PAN, and ozone for a future E85 scenario.

The US studies discussed here are winter studies and the lack of summer studies makes it difficult to quantify the magnitude of air quality impacts of ethanol fuel usage, which are expected to be greatest during the summer.

3.3.2.5.2 Brazilian Studies

The following studies investigate changes in ambient concentrations of several air pollutants that result from the use of ethanol fuels in Brazil. These studies are not directly relevant to the US due to differences such as vehicles, fuels, and climate; therefore, the EPA could not draw upon these conclusions to assess the magnitude of the impact of ethanol fuels on air quality. However, these studies do provide useful information on potential directional changes in pollutant levels with widespread ethanol use.

Brazil is the only country in the world where a nationwide, large-scale alcohol fuel program has been implemented. In 1997, approximately 4 million automobiles ran on neat ethanol and approximately nine million automobiles ran on a 22% ethanol-blended gasoline mixture.⁶³⁶

In Salvador, Bahia, Brazil, ambient levels of formaldehyde and acetaldehyde and their relationship with vehicular fleet composition was evaluated.⁶³⁷ The measured concentrations for formaldehyde and acetaldehyde ranged from 0.20 to 88 ppbv and from 0.40 to 93 ppbv, respectively. The ratio of formaldehyde to acetaldehyde revealed the relationship of vehicular fleet composition to ambient levels. In locations where ethanol-fueled vehicular emissions dominated, the ratio decreased, versus locations where diesel-fueled vehicles dominated. Sampling in rural areas showed no relationship between formaldehyde and acetaldehyde.

Acetaldehyde and formaldehyde concentrations were measured in the winter of 1999 in Sao Paulo, Brazil.⁶³⁸ Ambient levels of these carbonyls were similar. Higher average mixing ratios of acetaldehyde and formaldehyde were found in the morning (18.9 and 17.2 ppbv) than midday (9.5 and 11.8 ppbv) and evening (7.2 and 10.2 ppbv). In the morning, direct emission from vehicles seemed to be the main primary source, whereas at midday and evening these compounds appeared to result mainly from photochemistry.

A survey of volatile organic compounds in areas impacted by heavy traffic, including a tunnel, was obtained for Sao Paulo.⁶³⁹ Researchers found the ambient air was dominated by ethanol (414 ppbv) with elevated methanol and 1- and 2-propanol. These levels were well above those measurements available for US cities, particularly Los Angeles, CA. The overall data trend also showed levels of C₄-C₉ *n*-aldehydes to be approximately 10 times higher than in Los Angeles. They conclude that the use of alcohol-based fuels is the primary source for these differences since alcohol comprises about 40% of the mobile fuel by volume compared to 3% in Los Angeles. Also, the single-ring aromatic hydrocarbons (2.6 ppbv benzene, 9.0 ppbv toluene, 4.6 ppbv *m,p*-xylene) and the C₄-C₁₁ *n*-alkanes were similar or slightly elevated in concentration compared to Los Angeles.

A study in Rio de Janeiro, Brazil some years ago measured and modeled ambient PAN concentrations.⁶⁴⁰ The measurements were as high as 5 ppb over a 200 day period, but typically

below 1 ppb, at one site; at another site, as high as 3 ppb, but again generally below 1 ppb. Modeling estimates were as high as 3 ppb for PAN and 1 ppb for PPN. This study concluded that with increased use of ethanol in fuels there would be increases in ambient PAN.

More recent monitoring studies in Brazil measured daily maximum PAN concentrations ranging from 0.19 to 6.67 ppb.⁶⁴¹ Also, PPN was measured at lower levels of 0.06 to 0.72 ppb. During the 41 days of these measurements, PAN levels accounted for a large fraction of the ambient NO_x. This study concluded that aromatics and alkene compounds are responsible for significant PAN formation with ethanol and acetaldehyde having a minor role.

Speciated ambient carbonyls have also been measured in Rio de Janeiro.⁶⁴² The most abundant carbonyls were formaldehyde (9.3 ppb) and acetaldehyde (9.0 ppb). They also examined the ambient acetaldehyde to formaldehyde concentration ratio in Brazilian cities since mid-1980 in the context of changes in Brazil's reliance on ethanol as a vehicle fuel. They showed that this ratio has begun to decrease in recent years due to fleet turnover and decrease in ethanol-fueled vehicles. Ethanol-fueled vehicles are being replaced by lower-emitting models that run on a gasoline-ethanol blend.

Using an empirical kinetic modeling approach, researchers simulated ozone, formaldehyde, and acetaldehyde concentrations for the urban downtown area of Rio de Janeiro.⁶⁴³ The simulated ozone peak was in good agreement with monitoring results. Modeling results also showed that acetaldehyde and formaldehyde concentrations were highest in early morning, reaching a maximum which coincided with peak vehicular traffic. Additionally, they confirmed monitoring evidence that the high acetaldehyde to formaldehyde ratios were due to the use of alcohol-based fuels.

These studies modeled and measured ambient concentrations of several compounds that result from the use of ethanol fuels. However, the direct impacts of ethanol fuel usage on air quality in Brazil could not be evaluated since there were no ambient data available prior to the use of ethanol fuel.

3.3.3 Aromatics and SOA Formation

Particulate matter (PM) is an air pollutant consisting of a complex mixture of particles that can be solid, liquid or both, are suspended in the air, and consist of organic and inorganic substances. These particles vary in size, composition and origin. The major PM components are sulfate, nitrates, ammonia, carbon, crustal material and water.

Primary PM is emitted directly into the atmosphere from anthropogenic and biogenic processes. Primary PM includes PM from mobile sources and, on a mass basis, is largely carbonaceous in nature. Various studies have shown that mobile sources are a major source of primary PM in urban areas over many portions of the United States.^{644,645,646,647,648,649,650} Primary PM that is carbonaceous is also referred to as primary organic aerosol (POA).

Secondary PM is formed in the atmosphere from chemical transformations of gases. Secondary products include sulfates, nitrates and organics. Secondary organic aerosol (SOA)

results when products of atmospheric transformation or photooxidation of a volatile organic compound (VOC) form or partition to the particle phase. Current research suggests SOA contributes significantly to ambient organic aerosol (OA) concentrations, and in southeast and midwest states may make up more than 50% (although the contribution varies from area to area) of the organic fraction of PM_{2.5} during the summer (but less in the winter).^{651,652} A wide range of laboratory studies conducted over the past twenty years show that anthropogenic aromatic hydrocarbons and long-chained alkanes, along with biogenic isoprene, monoterpenes, and sesquiterpenes, contribute to SOA formation.⁶⁵³ Based on these laboratory results, SOA chemical mechanisms have been developed and integrated into air quality models such as the Community Multiscale Air Quality (CMAQ) model and have been used to predict OA concentrations.⁶⁵⁴ Studies have also shown that alkanes could be important anthropogenic SOA contributors.^{655,656,657,658}

Over the past 10 years, ambient OA concentrations have been routinely measured in the U.S. and some of these data have been used to determine, by employing source/receptor methods, the contributions of the major OA sources, including biomass burning and vehicular gasoline and diesel exhaust. Since mobile sources are a significant source of VOC emissions, currently accounting for approximately 50% of anthropogenic VOC,⁶⁵⁹ mobile sources are also an important source of SOA.

Toluene is an important contributor to anthropogenic SOA, although anthropogenic SOA is a small portion of all SOA. Other aromatic compounds contribute as well, but the extent of their contribution has not been quantified. Mobile sources are the most significant contributor to ambient toluene concentrations as shown by analyses done for the 1999 National Air Toxics Assessment (NATA)⁶⁶⁰ and the Mobile Source Air Toxics (MSAT) Rule.⁶⁶¹ MSAT rule analyses indicate that onroad and nonroad mobile sources accounted for 68% (2.22 µg/m³) of the total average nationwide ambient concentration of toluene in 1999 (3.24 µg/m³).

The amount of toluene in gasoline influences the amount of toluene emitted in vehicle exhaust and evaporative emissions. In turn, levels of toluene and other aromatics in gasoline are potentially influenced by the amount of ethanol blended into the fuel. Due to the high octane quality of ethanol, it greatly reduces the need for and levels of other high-octane components such as aromatics including toluene (which is the major aromatic compound in gasoline) when ethanol is used as a component of gasoline. Since toluene contributes to SOA and the toluene level of gasoline is decreasing, it is important to assess the effect of these reductions on ambient PM. To do this, EPA plans to run air quality models to assess the overall role of toluene's contribution to ambient PM and the benefits that would accrue from PM reductions associated with gasoline/ethanol blends having lower aromatic levels.

There is also the potential for ethanol to directly form SOA or affect SOA formation indirectly through changes in the radical populations from increasing ethanol exhausts. However, there is a lack of evidence for both. Scientists at the U.S. EPA's Office of Research and Development's National Exposure Research Laboratory recently directed a couple of experiments to investigate ethanol's SOA forming potential.⁶⁶² The experiments were conducted under conditions where peroxy radical reactions would predominate (irradiations performed in the absence of NO_x and OH produced from the photolysis of hydrogen peroxide). This was the

most likely scenario under which SOA formation could occur, since a highly oxygenated C4 organic would be potentially made. As expected, no SOA was produced. From these experiments, the upper limit for the aerosol yield would have been less than 0.01% based on scanning mobility particle sizer data. Given the expected negative result, this data was not published.

In general, a review of the literature shows limited data on SOA concentrations, largely due to the lack of analytical methods for identifying and determining the concentrations of the highly polar organic compounds that make up SOA. The most widely applied method of estimating total ambient SOA concentrations is the EC tracer method using ambient data and estimates of the OC/EC ratio in primary source emissions.^{663,664} SOA concentrations have also been estimated using OM (organic mass) to OC (organic carbon) ratios, which can indicate that SOA formation has occurred, or by subtracting the source/receptor-based total POA from the measured OC concentration.⁶⁶⁵ Such methods, however, may not be quantitatively accurate and provide no information on the contribution of individual biogenic and anthropogenic SOA sources, which is critical information needed to assess the impact of specific sources and the associated health risk. In particular, the contributions of anthropogenic SOA sources, including those of aromatic precursors, are required to determine exposures and risks associated with replacing fossil fuels with biofuels.

Upon release into the atmosphere, numerous VOC compounds can react with free radicals in the atmosphere to form SOA. While this has been investigated in the laboratory, there is relatively little information available on the specific chemical composition of SOA compounds themselves from specific VOC precursors. This absence of compositional data has largely prevented the identification of aromatically-derived SOA in ambient samples which, in turn, has prevented observation-based measurements of the aromatic and other SOA contributions to ambient PM levels.

As a first step in determining the ambient SOA concentrations, EPA has developed a tracer-based method to estimate such concentrations.^{666,667} The method is based on using mass fractions of SOA tracer compounds, measured in smog chamber-generated SOA samples, to convert ambient concentrations of SOA tracer compounds to ambient SOA concentrations. This method consists of irradiating the SOA precursor of interest in a smog chamber in the presence of NO_x, collecting the SOA produced on filters, and then analyzing the samples for highly polar compounds using advanced analytical chemistry methods. Employing this method, candidate tracers have been identified for several VOC compounds which are emitted in significant quantities and known to produce SOA in the atmosphere. Some of these SOA-forming compounds include toluene, a variety of monoterpenes, isoprene, and β-caryophyllene; the latter three of which are emitted by vegetation. Smog chamber work can also be used to investigate SOA chemical formation mechanisms.^{668,669,670,671}

Although these concentrations are only estimates, due to the assumption that the mass fractions of the smog chamber SOA samples using these tracers are equal to those in the ambient atmosphere, there are presently no other means available for estimating the SOA concentrations originating from individual SOA precursors. Among the tracer compounds observed in ambient PM_{2.5} samples are two tracer compounds that have been identified in smog chamber aromatic

SOA samples.⁶⁷² To date, these aromatic tracer compounds have been identified, in the laboratory, for toluene and *m*-xylene SOA. Additional work is underway by the EPA to determine whether these tracers are also formed by benzene and other alkylbenzenes (including *o*-xylene, *p*-xylene, 1,2,4-trimethylbenzene, and ethylbenzene).

One caveat regarding this work is that a large number of VOCs emitted into the atmosphere, which have the potential to form SOA, have not yet been studied in this way. It is possible that these unstudied compounds produce SOA species which are being used as tracers for other VOCs. This means that the present work could overestimate the amount of SOA formed in the atmosphere by the VOCs studied to date. This approach may also estimate entire hydrocarbon classes (e.g. all methylsubstituted-monoaromatics or all monoterpenes) and not individual precursor hydrocarbons. Thus the tracers could be broadly representative and not indicative of individual precursors. This is still unknown. Also, anthropogenic precursors play a role in formation of atmospheric radicals and aerosol acidity, and these factors influence SOA formation from biogenic hydrocarbons. This anthropogenic and biogenic interaction, important to EPA and others, needs further study. The issue of SOA formation from aromatic precursors is an important one to which EPA and others are paying significant attention.

For benzene, smog chamber studies show that benzene forms SOA possibly through reactions with NO_x. Early smog chamber work suggests benzene might be relatively inert in forming SOA, although this study may not be conclusive.⁶⁷³ However, more recent work shows that benzene does form SOA in smog chambers.⁶⁷⁴ This new smog chamber work shows that benzene can be oxidized in the presence of NO_x to form SOA with maximum mass of SOA being 8-25% of the mass of benzene. As mentioned above, work is needed to determine if a tracer compound can be found for benzene SOA which might indicate how much of ambient SOA comes from benzene.

The aromatic tracer compounds and their mass fractions have also been used to estimate monthly ambient aromatic SOA concentrations from March 2004 to February 2005 in five U.S. Midwestern cities.⁶⁷⁵ The annual tracer-based SOA concentration estimates were 0.15, 0.18, 0.13, 0.15, and 0.19 µg carbon/m³ for Bondville, IL, East St. Louis, IL, Northbrook, IL, Cincinnati, OH and Detroit, MI, respectively, with the highest concentrations occurring in the summer. On average, the aromatic SOA concentrations made up 17 % of the total SOA concentration. Thus, this work suggests that we are finding ambient PM levels on an annual basis of about 0.15 µg/m³ associated with present toluene levels in the ambient air in these Midwest cities. Based on preliminary analysis of recent laboratory experiments, it appears the toluene tracer could also be formed during photooxidation of some of the xylenes.⁶⁷⁶

Over the past decade a variety of modeling studies have been conducted to predict ambient SOA levels, with most studies focusing on the contributions of biogenic monoterpenes and anthropogenic aromatic hydrocarbons. More recently, modelers have begun to include the contribution of the isoprene SOA to ambient OC concentrations.⁶⁷⁷ In general, the studies have been limited to comparing the sum of the POA and SOA concentrations with ambient OC concentrations. The general consensus in the atmospheric chemistry community appears to be that monoterpene contributions, which are clearly significant, and the somewhat smaller aromatic contributions, are insufficient to account for observed ambient SOA levels. Part of this

gap has been filled recently by SOA predictions for isoprene. Furthermore, the identification in ambient SOA of a tracer compound for the sesquiterpene β -caryophyllene,⁶⁷⁸ coupled with the high sesquiterpene SOA yields measured in the laboratory,⁶⁷⁹ suggests this class of hydrocarbons should be included in SOA chemical mechanisms. In addition, recent data on SOA formation from aromatic hydrocarbons suggest their contributions could be larger than previously thought.⁶⁸⁰

Based on laboratory experiments, researchers have proposed a new aromatic SOA chemical mechanism that takes into account both the impact of NO_x on SOA formation and the contribution of benzene to SOA formation. EPA has updated the SOA treatment in CMAQ by using this new mechanism, along with (1) laboratory-determined thermodynamic enthalpies of vaporization and SOA-to-secondary organic carbon ratios, (2) SOA contributions from sesquiterpenes and isoprene, (3) an elementary treatment of acid catalyzed SOA from isoprene, (4) a simple treatment of SOA oligomerization, and (5) SOA contributions from dicarbonyl compounds (glyoxyl, methylglyoxyl) that dissolve in cloud water and are oxidized to form oligomers.

This new SOA mechanism was first evaluated by comparing simple box model predictions with field measurements, and initial comparisons indicated the mechanism might underpredict the ambient SOA data. This underprediction might be due to potential shortcomings in the tracer contribution method as well as difficulties associated with using the laboratory-based Odum model approach to predict ambient SOA concentrations. An underprediction in ambient SOA data might result in an underprediction of SOA benefits that might result from decreasing aromatic content due to increasing ethanol content in gasoline. On the other hand, aldehydes produced from the oxidation of ethanol could increase the SOA formed in cloud water, but only two aldehydes (glyoxal and methylglyoxal) are considered in the current SOA treatment. More fundamental research will be required to further enhance the SOA mechanism. Recently, the EPA awarded seven grants totaling \$3.8 million to leading SOA researchers for additional mechanistic research.

The new SOA mechanism has been integrated into CMAQ version 4.7 and has undergone internal EPA evaluation. The SOA predictions have been compared with ambient OC concentrations measured at PM_{2.5} monitoring sites across the country, CMAQ version 4.7 with the new SOA chemical mechanism will be used in the final rule. Public release of this version of the model occurred in December 2008.

3.4 Health Effects

In this section we will discuss the health and environmental effects associated with particulate matter, ozone, carbon monoxide and air toxics. The renewable fuel requirements established by the Energy Independence and Security Act (EISA) of 2007 will impact emissions of criteria and air toxic pollutants.

3.4.1 Health Effects of Particulate Matter

As stated in EPA's Particulate Matter Air Quality Criteria Document (PM AQCD), available scientific findings "demonstrate well that human health outcomes are associated with ambient PM."^{vvvvvvvv} We are relying on the data and conclusions in the PM AQCD and PM Staff Paper, which reflects EPA's analysis of policy-relevant science from the PM AQCD, regarding the health effects associated with particulate matter.^{681,682} We also present additional recent studies published after the cut-off date for the PM AQCD.^{wwwwwwww683} Taken together this information supports the conclusion that PM-related emissions are associated with adverse health effects.

3.4.1.1 Short-term Exposure Mortality and Morbidity Studies

As discussed in the PM AQCD, short-term exposure to PM_{2.5} is associated with mortality from cardiopulmonary diseases (PM AQCD, p. 8-305), hospitalization and emergency department visits for cardiopulmonary diseases (PM AQCD, p. 9-93), increased respiratory symptoms (PM AQCD, p. 9-46), decreased lung function (PM AQCD Table 8-34) and physiological changes or biomarkers for cardiac changes (PM AQCD, Section 8.3.1.3.4). In addition, the PM AQCD describes a limited body of new evidence from epidemiologic studies for potential relationships between short term exposure to PM and health endpoints such as low birth weight, preterm birth, and neonatal and infant mortality. (PM AQCD, Section 8.3.4).

Among the studies of effects from short-term exposure to PM_{2.5}, several specifically address the contribution of mobile sources to short-term PM_{2.5} effects on daily mortality. These studies indicate that there are statistically significant associations between mortality and PM related to mobile source emissions (PM AQCD, p.8-85). The analyses incorporate source apportionment tools into daily mortality studies and are briefly mentioned here. Analyses incorporating source apportionment by factor analysis with daily time-series studies of daily death indicated a relationship between mobile source PM_{2.5} and mortality.^{684,685} Another recent study in 14 U.S. cities examined the effect of PM₁₀ exposures on daily hospital admissions for cardiovascular disease. This study found that the effect of PM₁₀ was significantly greater in areas with a larger proportion of PM₁₀ coming from motor vehicles, indicating that PM₁₀ from these sources may have a greater effect on the toxicity of ambient PM₁₀ when compared with other sources.⁶⁸⁶ These studies provide evidence that PM-related emissions, specifically from mobile sources, are associated with adverse health effects.

3.4.1.2 Long-term Exposure Mortality and Morbidity Studies

^{vvvvvvvv} Personal exposure includes contributions from many different types of particles, from many sources, and in many different environments. Total personal exposure to PM includes both ambient and nonambient components; and both components may contribute to adverse health effects.

^{wwwwwwww} These additional studies are included in the 2006 Provisional Assessment of Recent Studies on Health Effects of Particulate Matter Exposure. The provisional assessment did not and could not (given a very short timeframe) undergo the extensive critical review by EPA, CASAC, and the public, as did the PM AQCD. The provisional assessment found that the "new" studies expand the scientific information and provide important insights on the relationship between PM exposure and health effects of PM. The provisional assessment also found that "new" studies generally strengthen the evidence that acute and chronic exposure to fine particles and acute exposure to thoracic coarse particles are associated with health effects.

Long-term exposure to elevated ambient PM_{2.5} is associated with mortality from cardiopulmonary diseases and lung cancer (PM AQCD, p. 8-307), and effects on the respiratory system such as decreased lung function or the development of chronic respiratory disease (PM AQCD, pp. 8-313, 8-314). Of specific importance to this proposal, the PM AQCD also notes that the PM components of gasoline and diesel engine exhaust represent one class of hypothesized likely important contributors to the observed ambient PM-related increases in lung cancer incidence and mortality (PM AQCD, p. 8-318).

The PM AQCD and PM Staff Paper emphasize the results of two long-term studies, the Six Cities and American Cancer Society (ACS) prospective cohort studies, based on several factors – the inclusion of measured PM data, the fact that the study populations were similar to the general population, and the fact that these studies have undergone extensive reanalysis (PM AQCD, p. 8-306, Staff Paper, p.3-18).^{687,688,689} These studies indicate that there are significant associations for all-cause, cardiopulmonary, and lung cancer mortality with long-term exposure to PM_{2.5}. One analysis of a subset of the ACS cohort data, which was published after the PM AQCD was finalized but in time for the 2006 Provisional Assessment, found a larger association than had previously been reported between long-term PM_{2.5} exposure and mortality in the Los Angeles area using a new exposure estimation method that accounted for variations in concentration within the city.⁶⁹⁰

As discussed in the PM AQCD, the morbidity studies that combine the features of cross-sectional and cohort studies provide the best evidence for chronic exposure effects. Long-term studies evaluating the effect of ambient PM on children's development have shown some evidence indicating effects of PM_{2.5} and/or PM₁₀ on reduced lung function growth (PM AQCD, Section 8.3.3.2.3). In another recent publication included in the 2006 Provisional Assessment, investigators in southern California reported the results of a cross-sectional study of outdoor PM_{2.5} and measures of atherosclerosis in the Los Angeles basin.⁶⁹¹ The study found significant associations between ambient residential PM_{2.5} and carotid intima-media thickness (CIMT), an indicator of subclinical atherosclerosis, an underlying factor in cardiovascular disease.

3.4.1.3 Roadway-Related PM Exposure and Health Studies

A recent body of studies examines traffic-related PM exposures and adverse health effects. However, note that the near-road environment is influenced by both gasoline spark-ignition (SI) and diesel vehicles, as well as re-entrained road dust and brake and tire wear. One study was done in North Carolina looking at concentrations of PM_{2.5} inside police cars and corresponding physiological changes in the police personnel driving the cars. The authors report significant elevations in markers of cardiac risk associated with concentrations of PM_{2.5} inside police cars on North Carolina state highways.⁶⁹² Other studies have found associations between traffic-generated particle concentrations at residences and adverse effects, including all-cause mortality, infant respiratory symptoms, and reduced cognitive functional development.^{693,694,695,696} There are other pollutants present in the near roadway environment, including air toxics which are discussed in Section 3.4.5, and it is important to note that current studies do not identify a single pollutant that is most associated with adverse health effects. Additional information on near-roadway health effects can be found in the recent Mobile Source Air Toxics rule (72 FR 8428, February 26, 2007).

3.4.2 Health Effects of Ozone

Exposure to ambient ozone contributes to a wide range of adverse health effects.^{xxxxxxx} These health effects are well documented and are critically assessed in the EPA ozone air quality criteria document (ozone AQCD) and EPA staff paper.^{697,698} We are relying on the data and conclusions in the ozone AQCD and staff paper, regarding the health effects associated with ozone exposure.

Ozone-related health effects include lung function decrements, respiratory symptoms, aggravation of asthma, increased hospital and emergency room visits, increased asthma medication usage, and a variety of other respiratory effects. Cellular-level effects, such as inflammation of lungs, have been documented as well. In addition, there is suggestive evidence of a contribution of ozone to cardiovascular-related morbidity and highly suggestive evidence that short-term ozone exposure directly or indirectly contributes to non-accidental and cardiopulmonary-related mortality, but additional research is needed to clarify the underlying mechanisms causing these effects. In a recent report on the estimation of ozone-related premature mortality published by the National Research Council (NRC), a panel of experts and reviewers concluded that short-term exposure to ambient ozone is likely to contribute to premature deaths and that ozone-related mortality should be included in estimates of the health benefits of reducing ozone exposure.⁶⁹⁹ People who appear to be more susceptible to effects associated with exposure to ozone include children, asthmatics and the elderly. Those with greater exposures to ozone, for instance due to time spent outdoors (e.g., children and outdoor workers), are also of concern.

Based on a large number of scientific studies, EPA has identified several key health effects associated with exposure to levels of ozone found today in many areas of the country. Short-term (1 to 3 hours) and prolonged exposures (6 to 8 hours) to ambient ozone concentrations have been linked to lung function decrements, respiratory symptoms, increased hospital admissions and emergency room visits for respiratory problems.^{700, 701, 702, 703, 704, 705} Repeated exposure to ozone can increase susceptibility to respiratory infection and lung inflammation and can aggravate preexisting respiratory diseases, such as asthma.^{706, 707, 708, 709, 710} Repeated exposure to sufficient concentrations of ozone can also cause inflammation of the lung, impairment of lung defense mechanisms, and possibly irreversible changes in lung structure, which over time could affect premature aging of the lungs and/or the development of chronic respiratory illnesses, such as emphysema and chronic bronchitis.^{711, 712, 713, 714}

Children and adults who are outdoors and active during the summer months, such as construction workers, are among those most at risk of elevated ozone exposures.⁷¹⁵ Children and outdoor workers tend to have higher ozone exposure because they typically are active outside, working, playing and exercising, during times of day and seasons (e.g., the summer) when ozone levels are highest.⁷¹⁶ For example, summer camp studies in the Eastern United States and Southeastern Canada have reported statistically significant reductions in lung function in

^{xxxxxxx} Human exposure to ozone varies over time due to changes in ambient ozone concentration and because people move between locations which have notable different ozone concentrations. Also, the amount of ozone delivered to the lung is not only influenced by the ambient concentrations but also by the individuals breathing route and rate.

children who are active outdoors.^{717, 718, 719, 720, 721, 722, 723, 724} Further, children are more at risk of experiencing health effects from ozone exposure than adults because their respiratory systems are still developing. These individuals (as well as people with respiratory illnesses, such as asthma, especially asthmatic children) can experience reduced lung function and increased respiratory symptoms, such as chest pain and cough, when exposed to relatively low ozone levels during prolonged periods of moderate exertion.^{725, 726, 727, 728}

3.4.3 Health Effects of Carbon Monoxide

We are relying on the data and conclusions in the EPA Air Quality Criteria Document for CO (CO Criteria Document), which was published in 2000, regarding the health effects associated with CO exposure.^{YYYYYYYY729} Carbon monoxide enters the bloodstream through the lungs and forms carboxyhemoglobin (COHb), a compound that inhibits the blood's capacity to carry oxygen to organs and tissues.^{730,731} Carbon monoxide has long been known to have substantial adverse effects on human health, including toxic effects on blood and tissues, and effects on organ functions. Although there are effective compensatory increases in blood flow to the brain, at some concentrations of COHb somewhere above 20 percent, these compensations fail to maintain sufficient oxygen delivery, and metabolism declines.⁷³² The subsequent hypoxia in brain tissue then produces behavioral effects, including decrements in continuous performance and reaction time.⁷³³

Carbon monoxide has been linked to increased risk for people with heart disease, reduced visual perception, cognitive functions and aerobic capacity, and possible fetal effects.⁷³⁴ Persons with heart disease are especially sensitive to CO poisoning and may experience chest pain if they breathe the gas while exercising.⁷³⁵ Infants, elderly persons, and individuals with respiratory diseases are also particularly sensitive. Carbon monoxide can affect healthy individuals, impairing exercise capacity, visual perception, manual dexterity, learning functions, and ability to perform complex tasks.⁷³⁶

Several epidemiological studies have shown a link between CO and premature morbidity (including angina, congestive heart failure, and other cardiovascular diseases). Several studies in the United States and Canada have also reported an association between ambient CO exposures and frequency of cardiovascular hospital admissions, especially for congestive heart failure (CHF). An association between ambient CO exposure and mortality has also been reported in epidemiological studies, though not as consistently or specifically as with CHF admissions. EPA reviewed these studies as part of the CO Criteria Document review process and noted the possibility that the average ambient CO levels used as exposure indices in the epidemiology studies may be surrogates for ambient air mixes impacted by combustion sources and/or other constituent toxic components of such mixes. More research will be needed to better clarify CO's role.⁷³⁷

3.4.4 Environmental Effects of Criteria Pollutants

^{YYYYYYYY} The NAAQS review process is underway for CO and the CO Integrated Science Assessment is scheduled to be completed in January 2010.

In this section we discuss some of the environmental effects of PM and its precursors such as visibility impairment, atmospheric deposition, and materials damage and soiling, as well as environmental effects associated with the presence of ozone in the ambient air, such as impacts on plants, including trees, agronomic crops and urban ornamentals.

3.4.4.1 Visibility Impairment

Visibility can be defined as the degree to which the atmosphere is transparent to visible light.⁷³⁸ Visibility impairment manifests in two principal ways: as local visibility impairment and as regional haze.⁷³⁹ Local visibility impairment may take the form of a localized plume, a band or layer of discoloration appearing well above the terrain as a result of complex local meteorological conditions. Alternatively, local visibility impairment may manifest as an urban haze, sometimes referred to as a “brown cloud.” This urban haze is largely caused by emissions from multiple sources in the urban area and is not typically attributable to only one nearby source or to long-range transport. The second type of visibility impairment, regional haze, usually results from multiple pollution sources spread over a large geographic region. Regional haze can impair visibility over large regions and across states.

Visibility is important because it has direct significance to people’s enjoyment of daily activities in all parts of the country. Individuals value good visibility for the well-being it provides them directly, where they live and work and in places where they enjoy recreational opportunities. Visibility is also highly valued in significant natural areas such as national parks and wilderness areas, and special emphasis is given to protecting visibility in these areas.

Fine particles are the major cause of reduced visibility in parts of the United States. To address the welfare effects of PM on visibility, EPA sets secondary PM_{2.5} standards which work in conjunction with the regional haze program. The secondary (welfare-based) PM_{2.5} NAAQS is equal to the suite of primary (health-based) PM_{2.5} NAAQS. The regional haze rule (64 FR 35714, July 1999) was put in place to protect the visibility in mandatory class I federal areas. These areas are defined in Section 162 of the Act as those national parks exceeding 6,000 acres, wilderness areas and memorial parks exceeding 5,000 acres, and all international parks which were in existence on August 7, 1977. Visibility is impaired in both PM_{2.5} nonattainment areas and mandatory class I federal areas.

3.4.4.2 Particulate Matter Deposition

Particulate matter contributes to adverse effects on vegetation and ecosystems, and to soiling and materials damage. These welfare effects result predominately from exposure to excess amounts of specific chemical species, regardless of their source or predominant form (particle, gas or liquid). Reflecting this fact, the PM AQCD concludes that regardless of size fractions, particles containing nitrates and sulfates have the greatest potential for widespread environmental significance, while effects are also related to other chemical constituents found in ambient PM, such as trace metals and organics. The following characterizations of the nature of these welfare effects are based on the information contained in the PM AQCD and PM Staff Paper.^{740,741}

3.4.4.2.1 Deposition of Nitrates and Sulfates

Nitrogen and sulfur interactions in the environment are highly complex. Both are essential, and sometimes limiting, nutrients needed for growth and productivity. Excesses of nitrogen or sulfur can lead to acidification, nutrient enrichment, and eutrophication.⁷⁴²

The process of acidification affects both freshwater aquatic and terrestrial ecosystems. Acid deposition causes acidification of sensitive surface waters. The effects of acid deposition on aquatic systems depend largely upon the ability of the ecosystem to neutralize the additional acid. As acidity increases, aluminum leached from soils and sediments, flows into lakes and streams and can be toxic to both terrestrial and aquatic biota. The lower pH concentrations and higher aluminum levels resulting from acidification make it difficult for some fish and other aquatic organisms to survive, grow, and reproduce. Research on effects of acid deposition on forest ecosystems has come to focus increasingly on the biogeochemical processes that affect uptake, retention, and cycling of nutrients within these ecosystems. Decreases in available base cations from soils are at least partly attributable to acid deposition. Base cation depletion is a cause for concern because of the role these ions play in acid neutralization and, because calcium, magnesium and potassium are essential nutrients for plant growth and physiology. Changes in the relative proportions of these nutrients, especially in comparison with aluminum concentrations, have been associated with declining forest health.

At current ambient levels, risks to vegetation from short-term exposures to dry deposited particulate nitrate or sulfate are low. However, when found in acid or acidifying deposition, such particles do have the potential to cause direct leaf injury. Specifically, the responses of forest trees to acid precipitation (rain, snow) include accelerated weathering of leaf cuticular surfaces, increased permeability of leaf surfaces to toxic materials, water, and disease agents; increased leaching of nutrients from foliage; and altered reproductive processes—all which serve to weaken trees so that they are more susceptible to other stresses (e.g., extreme weather, pests, pathogens). Acid deposition with levels of acidity associated with the leaf effects described above are currently found in some locations in the eastern U.S.⁷⁴³ Even higher concentrations of acidity can be present in occult depositions (e.g., fog, mist or clouds) which more frequently impacts higher elevations. Thus, the risk of leaf injury occurring from acid deposition in some areas of the eastern U.S. is high. Nitrogen deposition has also been shown to impact ecosystems in the western U.S. A study conducted in the Columbia River Gorge National Scenic Area (CRGNSA), located along a portion of the Oregon/Washington border, indicates that lichen communities in the CRGNSA have shifted to a higher proportion of nitrophilous species and the nitrogen content of lichen tissue is elevated.⁷⁴⁴ Lichens are sensitive indicators of nitrogen deposition effects to terrestrial ecosystems and the lichen studies in the Columbia River Gorge clearly show that ecological effects from air pollution are occurring.

Some of the most significant detrimental effects associated with excess reactive nitrogen deposition are those associated with a syndrome known as nitrogen saturation. These effects include: (1) decreased productivity, increased mortality, and/or shifts in plant community composition, often leading to decreased biodiversity in many natural habitats wherever atmospheric reactive nitrogen deposition increases significantly above background and critical thresholds are exceeded; (2) leaching of excess nitrate and associated base cations from soils into

streams, lakes, and rivers, and mobilization of soil aluminum; and (3) fluctuation of ecosystem processes such as nutrient and energy cycles through changes in the functioning and species composition of beneficial soil organisms.⁷⁴⁵

In the U.S. numerous forests now show severe symptoms of nitrogen saturation. These forests include: the northern hardwoods and mixed conifer forests in the Adirondack and Catskill Mountains of New York; the red spruce forests at Whitetop Mountain, Virginia, and Great Smoky Mountains National Park, North Carolina; mixed hardwood watersheds at Fernow Experimental Forest in West Virginia; American beech forests in Great Smoky Mountains National Park, Tennessee; mixed conifer forests and chaparral watersheds in southern California and the southwestern Sierra Nevada in Central California; the alpine tundra/subalpine conifer forests of the Colorado Front Range; and red alder forests in the Cascade Mountains in Washington.

Excess nutrient inputs into aquatic ecosystems (i.e. streams, rivers, lakes, estuaries or oceans) either from direct atmospheric deposition, surface runoff, or leaching from nitrogen saturated soils into ground or surface waters can contribute to conditions of severe water oxygen depletion; eutrophication and algae blooms; altered fish distributions, catches, and physiological states; loss of biodiversity; habitat degradation; and increases in the incidence of disease.

Atmospheric deposition of nitrogen is a significant source of total nitrogen to many estuaries in the United States. The amount of nitrogen entering estuaries that is ultimately attributable to atmospheric deposition is not well-defined. On an annual basis, atmospheric nitrogen deposition may contribute significantly to the total nitrogen load, depending on the size and location of the watershed. In addition, episodic nitrogen inputs, which may be ecologically important, may play a more important role than indicated by the annual average concentrations. Estuaries in the U.S. that suffer from nitrogen enrichment often experience a condition known as eutrophication. Symptoms of eutrophication include changes in the dominant species of phytoplankton, low levels of oxygen in the water column, fish and shellfish kills, outbreaks of toxic alga, and other population changes which can cascade throughout the food web. In addition, increased phytoplankton growth in the water column and on surfaces can attenuate light causing declines in submerged aquatic vegetation, which serves as an important habitat for many estuarine fish and shellfish species.

Severe and persistent eutrophication often directly impacts human activities. For example, losses in the nation's fishery resources may be directly caused by fish kills associated with low dissolved oxygen and toxic blooms. Declines in tourism occur when low dissolved oxygen causes noxious smells and floating mats of algal blooms create unfavorable aesthetic conditions. Risks to human health increase when the toxins from algal blooms accumulate in edible fish and shellfish, and when toxins become airborne, causing respiratory problems due to inhalation. According to a NOAA report, more than half of the nation's estuaries have moderate to high expressions of at least one of these symptoms – an indication that eutrophication is well developed in more than half of U.S. estuaries.⁷⁴⁶

3.4.4.2.2 Materials Damage and Soiling

The effects of the deposition of atmospheric pollution, including ambient PM, on materials are related to both physical damage and impaired aesthetic qualities. The deposition of PM (especially sulfates and nitrates) can physically affect materials, adding to the effects of natural weathering processes, by potentially promoting or accelerating the corrosion of metals, by degrading paints, and by deteriorating building materials such as concrete and limestone. Only chemically active fine particles or hygroscopic coarse particles contribute to these physical effects. In addition, the deposition of ambient PM can reduce the aesthetic appeal of buildings and culturally important articles through soiling. Particles consisting primarily of carbonaceous compounds cause soiling of commonly used building materials and culturally important items such as statues and works of art.

3.4.4.3 Impacts of Ozone on Vegetation

The Air Quality Criteria Document for Ozone and related Photochemical Oxidants notes that “ozone affects vegetation throughout the United States, impairing crops, native vegetation, and ecosystems more than any other air pollutant. Like carbon dioxide (CO₂) and other gaseous substances, ozone enters plant tissues primarily through apertures (stomata) in leaves in a process called “uptake”.⁷⁴⁷ Once sufficient levels of ozone, a highly reactive substance, (or its reaction products) reaches the interior of plant cells, it can inhibit or damage essential cellular components and functions, including enzyme activities, lipids, and cellular membranes, disrupting the plant's osmotic (i.e., water) balance and energy utilization patterns.^{748,749} This damage is commonly manifested as visible foliar injury, such as chlorotic or necrotic spots, increased leaf senescence (accelerated leaf aging) and/or reduced photosynthesis. All these effects reduce a plant's capacity to form carbohydrates, which are the primary form of energy used by plants.⁷⁵⁰ With fewer resources available, the plant reallocates existing resources away from root growth and storage, above ground growth or yield, and reproductive processes, toward leaf repair and maintenance. Studies have shown that plants stressed in these ways may exhibit a general loss of vigor, which can lead to secondary impacts that modify plants' responses to other environmental factors. Specifically, plants may become more sensitive to other air pollutants, more susceptible to disease, insect attack, harsh weather (e.g., drought, frost) and other environmental stresses. Furthermore, there is evidence that ozone can interfere with the formation of mycorrhiza, essential symbiotic fungi associated with the roots of most terrestrial plants, by reducing the amount of carbon available for transfer from the host to the symbiont.^{751,752}

Ozone can produce both acute and chronic injury in sensitive species depending on the concentration level and the duration of the exposure. Ozone effects also tend to accumulate over the growing season of the plant, so that even lower concentrations experienced for a longer duration have the potential to create chronic stress on sensitive vegetation. Not all plants, however, are equally sensitive to ozone. Much of the variation in sensitivity between individual plants or whole species is related to the plant's ability to regulate the extent of gas exchange via leaf stomata (e.g., avoidance of O₃ uptake through closure of stomata).^{753,754,755} Other resistance mechanisms may involve the intercellular production of detoxifying substances. Several biochemical substances capable of detoxifying ozone have been reported to occur in plants including the antioxidants ascorbate and glutathione. After injuries have occurred, plants may be capable of repairing the damage to a limited extent.⁷⁵⁶

Because of the differing sensitivities among plants to ozone, ozone pollution can also exert a selective pressure that leads to changes in plant community composition. Given the range of plant sensitivities and the fact that numerous other environmental factors modify plant uptake and response to ozone, it is not possible to identify threshold values above which ozone is consistently toxic for all plants. The next few paragraphs present additional information on ozone damage to trees, ecosystems, agronomic crops and urban ornamentals.

Ozone also has been conclusively shown to cause discernible injury to forest trees.^{757,758} In terms of forest productivity and ecosystem diversity, ozone may be the pollutant with the greatest potential for regional-scale forest impacts. Studies have demonstrated repeatedly that ozone concentrations commonly observed in polluted areas can have substantial impacts on plant function.^{759,760}

Because plants are at the center of the food web in many ecosystems, changes to the plant community can affect associated organisms and ecosystems (including the suitability of habitats that support threatened or endangered species and below ground organisms living in the root zone). Ozone impacts at the community and ecosystem level vary widely depending upon numerous factors, including concentration and temporal variation of tropospheric ozone, species composition, soil properties and climatic factors.⁷⁶¹ In most instances, responses to chronic or recurrent exposure in forested ecosystems are subtle and not observable for many years. These injuries can cause stand-level forest decline in sensitive ecosystems.^{762,763,764} It is not yet possible to predict ecosystem responses to ozone with much certainty; however, considerable knowledge of potential ecosystem responses has been acquired through long-term observations in highly damaged forests in the United States.

Laboratory and field experiments have also shown reductions in yields for agronomic crops exposed to ozone, including vegetables (e.g., lettuce) and field crops (e.g., cotton and wheat). The most extensive field experiments, conducted under the National Crop Loss Assessment Network (NCLAN) examined 15 species and numerous cultivars. The NCLAN results show that “several economically important crop species are sensitive to ozone levels typical of those found in the United States.”⁷⁶⁵ In addition, economic studies have shown reduced economic benefits as a result of predicted reductions in crop yields associated with observed ozone levels.^{766,767,768}

Urban ornamentals represent an additional vegetation category likely to experience some degree of negative effects associated with exposure to ambient ozone levels. It is estimated that more than \$20 billion (1990 dollars) are spent annually on landscaping using ornamentals, both by private property owners/tenants and by governmental units responsible for public areas.⁷⁶⁹ This is therefore a potentially costly environmental effect. However, in the absence of adequate exposure-response functions and economic damage functions for the potential range of effects relevant to these types of vegetation, no direct quantitative analysis has been conducted.

3.4.5 Health Effects of Air Toxics

Motor vehicle emissions contribute to ambient levels of air toxics known or suspected as human or animal carcinogens, or that have noncancer health effects. The population experiences

an elevated risk of cancer and other noncancer health effects from exposure to air toxics.⁷⁷⁰ These compounds include, but are not limited to, benzene, 1,3-butadiene, formaldehyde, acetaldehyde, acrolein, naphthalene, ethanol and PAN. These compounds, except acetaldehyde, ethanol and PAN, were identified as national or regional risk drivers in the 1999 National-Scale Air Toxics Assessment (NATA) and have significant inventory contributions from mobile sources.

According to NATA for 1999, mobile sources were responsible for 44 percent of outdoor toxic emissions and almost 50 percent of the cancer risk. Benzene is the largest contributor to cancer risk of all 133 pollutants quantitatively assessed in the 1999 NATA and mobile sources were responsible for 68 percent of benzene emissions in 1999. In response, EPA has recently finalized vehicle and fuel controls that address this public health risk.⁷⁷¹

Noncancer health effects can result from chronic,^{ZZZZZZZ} subchronic,^{AAAAAAAAA} or acute^{BBBBBBBBB} inhalation exposures to air toxics, and include neurological, cardiovascular, liver, kidney, and respiratory effects as well as effects on the immune and reproductive systems. According to the 1999 NATA, nearly the entire U.S. population was exposed to an average concentration of air toxics that has the potential for adverse noncancer respiratory health effects. This will continue to be the case in 2030, even though toxics concentrations will be lower. Mobile sources were responsible for 74 percent of the noncancer (respiratory) risk from outdoor air toxics in 1999. The majority of this risk was from exposure to acrolein. The confidence in the RfC for acrolein is medium and confidence in NATA estimates of population noncancer hazard from ambient exposure to this pollutant is low.^{772,773}

The NATA modeling framework has a number of limitations which prevent its use as the sole basis for setting regulatory standards. These limitations and uncertainties are discussed on the 1999 NATA website.⁷⁷⁴ Even so, this modeling framework is very useful in identifying air toxic pollutants and sources of greatest concern, setting regulatory priorities, and informing the decision making process.

Benzene: The EPA's IRIS database lists benzene as a known human carcinogen (causing leukemia) by all routes of exposure, and concludes that exposure is associated with additional health effects, including genetic changes in both humans and animals and increased proliferation of bone marrow cells in mice.^{775,776,777} EPA states in its IRIS database that data indicate a causal relationship between benzene exposure and acute lymphocytic leukemia and suggest a relationship between benzene exposure and chronic non-lymphocytic leukemia and chronic lymphocytic leukemia. The International Agency for Research on Carcinogens (IARC) has determined that benzene is a human carcinogen and the U.S. Department of Health and Human Services (DHHS) has characterized benzene as a known human carcinogen.^{778,779}

^{ZZZZZZZ} Chronic exposure is defined in the glossary of the Integrated Risk Information (IRIS) database (<http://www.epa.gov/iris>) as repeated exposure by the oral, dermal, or inhalation route for more than approximately 10% of the life span in humans (more than approximately 90 days to 2 years in typically used laboratory animal species).

^{AAAAAAAAA} Defined in the IRIS database as exposure to a substance spanning approximately 10% of the lifetime of an organism.

^{BBBBBBBBB} Defined in the IRIS database as exposure by the oral, dermal, or inhalation route for 24 hours or less.

A number of adverse noncancer health effects including blood disorders, such as preleukemia and aplastic anemia, have also been associated with long-term exposure to benzene.^{780,781} The most sensitive noncancer effect observed in humans, based on current data, is the depression of the absolute lymphocyte count in blood.^{782,783} In addition, recent work, including studies sponsored by the Health Effects Institute (HEI), provides evidence that biochemical responses are occurring at lower levels of benzene exposure than previously known.^{784,785,786,787} EPA's IRIS program has not yet evaluated these new data.

1,3-Butadiene: EPA has characterized 1,3-butadiene as carcinogenic to humans by inhalation.^{788,789} The IARC has determined that 1,3-butadiene is a human carcinogen and the U.S. DHHS has characterized 1,3-butadiene as a known human carcinogen.^{790,791} There are numerous studies consistently demonstrating that 1,3-butadiene is metabolized into genotoxic metabolites by experimental animals and humans. The specific mechanisms of 1,3-butadiene-induced carcinogenesis are unknown; however, the scientific evidence strongly suggests that the carcinogenic effects are mediated by genotoxic metabolites. Animal data suggest that females may be more sensitive than males for cancer effects associated with 1,3-butadiene exposure; there are insufficient data in humans from which to draw conclusions about sensitive subpopulations. 1,3-butadiene also causes a variety of reproductive and developmental effects in mice; no human data on these effects are available. The most sensitive effect was ovarian atrophy observed in a lifetime bioassay of female mice.⁷⁹²

Formaldehyde: Since 1987, EPA has classified formaldehyde as a probable human carcinogen based on evidence in humans and in rats, mice, hamsters, and monkeys.⁷⁹³ EPA is currently reviewing recently published epidemiological data. For instance, research conducted by the National Cancer Institute (NCI) found an increased risk of nasopharyngeal cancer and lymphohematopoietic malignancies such as leukemia among workers exposed to formaldehyde.^{794,795} NCI is currently performing an update of these studies. A recent National Institute of Occupational Safety and Health (NIOSH) study of garment workers also found increased risk of death due to leukemia among workers exposed to formaldehyde.⁷⁹⁶ Extended follow-up of a cohort of British chemical workers did not find evidence of an increase in nasopharyngeal or lymphohematopoietic cancers, but a continuing statistically significant excess in lung cancers was reported.⁷⁹⁷

In the past 15 years there has been substantial research on the inhalation dosimetry for formaldehyde in rodents and primates by the CIIT Centers for Health Research (formerly the Chemical Industry Institute of Toxicology), with a focus on use of rodent data for refinement of the quantitative cancer dose-response assessment.^{798,799,800} CIIT's risk assessment of formaldehyde incorporated mechanistic and dosimetric information on formaldehyde.

Based on the developments of the last decade, in 2004, the working group of the IARC concluded that formaldehyde is carcinogenic to humans (Group 1), on the basis of sufficient evidence in humans and sufficient evidence in experimental animals - a higher classification than previous IARC evaluations. After reviewing the currently available epidemiological evidence, the IARC (2006) characterized the human evidence for formaldehyde carcinogenicity as "sufficient," based upon the data on nasopharyngeal cancers; the epidemiologic evidence on leukemia was characterized as "strong."⁸⁰¹ EPA is reviewing the recent work cited above from

the NCI and NIOSH, as well as the analysis by the CIIT Centers for Health Research and other studies, as part of a reassessment of the human hazard and dose-response associated with formaldehyde.

Formaldehyde exposure also causes a range of noncancer health effects, including irritation of the eyes (burning and watering of the eyes), nose and throat. Effects from repeated exposure in humans include respiratory tract irritation, chronic bronchitis and nasal epithelial lesions such as metaplasia and loss of cilia. Animal studies suggest that formaldehyde may also cause airway inflammation – including eosinophil infiltration into the airways. There are several studies that suggest that formaldehyde may increase the risk of asthma – particularly in the young.^{802,803}

Acetaldehyde: Acetaldehyde is classified in EPA's IRIS database as a probable human carcinogen, based on nasal tumors in rats, and is considered toxic by the inhalation, oral, and intravenous routes.⁸⁰⁴ Acetaldehyde is reasonably anticipated to be a human carcinogen by the U.S. DHHS in the 11th Report on Carcinogens and is classified as possibly carcinogenic to humans (Group 2B) by the IARC.^{805,806} EPA is currently conducting a reassessment of cancer risk from inhalation exposure to acetaldehyde.

The primary noncancer effects of exposure to acetaldehyde vapors include irritation of the eyes, skin, and respiratory tract.⁸⁰⁷ In short-term (4 week) rat studies, degeneration of olfactory epithelium was observed at various concentration levels of acetaldehyde exposure.^{808,809} Data from these studies were used by EPA to develop an inhalation reference concentration. Some asthmatics have been shown to be a sensitive subpopulation to decrements in functional expiratory volume (FEV1 test) and bronchoconstriction upon acetaldehyde inhalation.⁸¹⁰ The agency is currently conducting a reassessment of the health hazards from inhalation exposure to acetaldehyde.

Acrolein: EPA determined in 2003 that the human carcinogenic potential of acrolein could not be determined because the available data were inadequate. No information was available on the carcinogenic effects of acrolein in humans and the animal data provided inadequate evidence of carcinogenicity.⁸¹¹ The IARC determined in 1995 that acrolein was not classifiable as to its carcinogenicity in humans.⁸¹²

Acrolein is extremely acrid and irritating to humans when inhaled, with acute exposure resulting in upper respiratory tract irritation, mucus hypersecretion and congestion. Levels considerably lower than 1 ppm (2.3 mg/m³) elicit subjective complaints of eye and nasal irritation and a decrease in the respiratory rate.^{813,814} Lesions to the lungs and upper respiratory tract of rats, rabbits, and hamsters have been observed after subchronic exposure to acrolein. Based on animal data, individuals with compromised respiratory function (e.g., emphysema, asthma) are expected to be at increased risk of developing adverse responses to strong respiratory irritants such as acrolein. This was demonstrated in mice with allergic airway-disease by comparison to non-diseased mice in a study of the acute respiratory irritant effects of acrolein.⁸¹⁵

EPA is currently in the process of conducting an assessment of acute exposure effects for acrolein. The intense irritancy of this carbonyl has been demonstrated during controlled tests in

human subjects, who suffer intolerable eye and nasal mucosal sensory reactions within minutes of exposure.⁸¹⁶

Naphthalene: Naphthalene is found in small quantities in gasoline and diesel fuels. Naphthalene emissions have been measured in larger quantities in both gasoline and diesel exhaust compared with evaporative emissions from mobile sources, indicating it is primarily a product of combustion. EPA released an external review draft of a reassessment of the inhalation carcinogenicity of naphthalene based on a number of recent animal carcinogenicity studies.⁸¹⁷ The draft reassessment completed external peer review.⁸¹⁸ Based on external peer review comments received, additional analyses are being undertaken. This external review draft does not represent official agency opinion and was released solely for the purposes of external peer review and public comment. Once EPA evaluates public and peer reviewer comments, the document will be revised. The National Toxicology Program listed naphthalene as "reasonably anticipated to be a human carcinogen" in 2004 on the basis of bioassays reporting clear evidence of carcinogenicity in rats and some evidence of carcinogenicity in mice.⁸¹⁹ California EPA has released a new risk assessment for naphthalene, and the IARC has reevaluated naphthalene and re-classified it as Group 2B: possibly carcinogenic to humans.⁸²⁰ Naphthalene also causes a number of chronic non-cancer effects in animals, including abnormal cell changes and growth in respiratory and nasal tissues.⁸²¹

Ethanol: EPA is conducting an assessment of the cancer and noncancer effects of exposure to ethanol, a compound which is not currently listed in EPA's IRIS. A description of these effects will be presented, as required by Section 1505 of EPAct, in a Report to Congress on public health, air quality and water resource impacts of fuel additives. We expect to release that report in 2009.

Extensive data are available regarding adverse health effects associated with the ingestion of ethanol while data on inhalation exposure effects are sparse. As part of the IRIS assessment, pharmacokinetic models are being evaluated as a means of extrapolating across species (animal to human) and across exposure routes (oral to inhalation) to better characterize the health hazards and dose-response relationships for low levels of ethanol exposure in the environment.

The IARC has classified "alcoholic beverages" as carcinogenic to humans based on sufficient evidence that malignant tumors of the mouth, pharynx, larynx, esophagus, and liver are causally related to the consumption of alcoholic beverages.⁸²² The U.S. DHHS in the 11th Report on Carcinogens also identified "alcoholic beverages" as a known human carcinogen (they have not evaluated the cancer risks specifically from exposure to ethanol), with evidence for cancer of the mouth, pharynx, larynx, esophagus, liver and breast.⁸²³ There are no studies reporting carcinogenic effects from inhalation of ethanol. EPA is currently evaluating the available human and animal cancer data to identify which cancer type(s) are the most relevant to an assessment of risk to humans from a low-level oral and inhalation exposure to ethanol.

Noncancer health effects data are available from animal studies as well as epidemiologic studies. The epidemiologic data are obtained from studies of alcoholic beverage consumption. Effects include neurological impairment, developmental effects, cardiovascular effects, immune system depression, and effects on the liver, pancreas and reproductive system.⁸²⁴ There is

evidence that children prenatally exposed via mothers' ingestion of alcoholic beverages during pregnancy are at increased risk of hyperactivity and attention deficits, impaired motor coordination, a lack of regulation of social behavior or poor psychosocial functioning, and deficits in cognition, mathematical ability, verbal fluency, and spatial memory.^{825,826,827,828,829,830,831,832} In some people, genetic factors influencing the metabolism of ethanol can lead to differences in internal levels of ethanol and may render some subpopulations more susceptible to risks from the effects of ethanol.

N-Hexane: N-Hexane is associated with polyneuropathy in humans. Effects observed in rodents include nasal lesions as well as neurotoxic effects. EPA has developed a reference concentration of 700 µg/m³ from a study of peripheral neuropathy.⁸³³ There is inadequate data to assess its carcinogenic potential.

Peroxyacetyl nitrate (PAN): PAN has not been evaluated by EPA's IRIS program. Information regarding the potential carcinogenicity of PAN is limited. As noted in the EPA air quality criteria document for ozone and related photochemical oxidants, cytogenetic studies indicate that PAN is not a potent mutagen, clastogen (a compound that can cause breaks in chromosomes), or DNA-damaging agent in mammalian cells either in vivo or in vitro. Some studies suggest that PAN may be a weak bacterial mutagen at high concentrations much higher than exist in present urban atmospheres.⁸³⁴

Effects of ground-level smog causing intense eye irritation have been attributed to photochemical oxidants, including PAN.⁸³⁵ Animal toxicological information on the inhalation effects of the non-ozone oxidants has been limited to a few studies on PAN. Acute exposure to levels of PAN can cause changes in lung morphology, behavioral modifications, weight loss, and susceptibility to pulmonary infections. Human exposure studies indicate minor pulmonary function effects at high PAN concentrations, but large inter-individual variability precludes definitive conclusions.⁸³⁶

Pesticides: There are potential toxicity concerns with volatilization of pesticide active ingredients,⁸³⁷ in addition to concerns with contamination of foods and drinking water. Furthermore, raising acreage under corn production may increase the quantity of pesticide products in use. As the domestic corn supply grows between the years of 2005 and 2022, the percentage of corn used for ethanol production in the US is expected to increase, though the agricultural impacts of this shifting of crop production domestically are anticipated to be small. Whether there is the potential for adverse human health effects from any increase in pesticide use associated with increased corn production domestically warrants further assessment. Additional information on pesticides and health effects is included in Section 6.1 of this DRIA.

Other Air Toxics: In addition to the compounds described above, other compounds in gaseous hydrocarbon and PM emissions from vehicles will be affected by today's proposed action. Mobile source air toxic compounds that will potentially be impacted include ethylbenzene, polycyclic organic matter, propionaldehyde, toluene, and xylene. Information regarding the health effects of these compounds can be found in EPA's IRIS database.⁸³⁸

3.4.6 Environmental Effects of Air Toxics

Fuel combustion emissions contribute to ambient levels of pollutants that contribute to adverse effects on vegetation. PAN is a well-established phytotoxicant causing visible injury to leaves that can appear as metallic glazing on the lower surface of leaves with some leafy vegetables exhibiting particular sensitivity (e.g., spinach, lettuce, chard).^{839,840,841} PAN has been demonstrated to inhibit photosynthetic and non-photosynthetic processes in plants and retard the growth of young navel orange trees.^{842,843} In addition to its oxidizing capability, PAN contributes nitrogen to forests and other vegetation via uptake as well as dry and wet deposition to surfaces. As noted above in Section 3.4.2.2, nitrogen deposition can lead to saturation of terrestrial ecosystems and research is needed to understand the impacts of excess nitrogen deposition experienced in some areas of the country on water quality and ecosystems.⁸⁴⁴

Volatile organic compounds (VOCs), some of which are considered air toxics, have long been suspected to play a role in vegetation damage.⁸⁴⁵ In laboratory experiments, a wide range of tolerance to VOCs has been observed.⁸⁴⁶ Decreases in harvested seed pod weight have been reported for the more sensitive plants, and some studies have reported effects on seed germination, flowering and fruit ripening. Effects of individual VOCs or their role in conjunction with other stressors (e.g., acidification, drought, temperature extremes) have not been well studied. In a recent study of a mixture of VOCs including ethanol and toluene on herbaceous plants, significant effects on seed production, leaf water content and photosynthetic efficiency were reported for some plant species.⁸⁴⁷

Research suggests an adverse impact of vehicle exhaust on plants, which has in some cases been attributed to aromatic compounds and in other cases to nitrogen oxides.^{848,849,850} The impacts of VOCs on plant reproduction may have long-term implications for biodiversity and survival of native species near major roadways. Most of the studies of the impacts of VOCs on vegetation have focused on short-term exposure and few studies have focused on long-term effects of VOCs on vegetation and the potential for metabolites of these compounds to affect herbivores or insects.

Chapter 4: Impacts on Cost of Renewable Fuels, Gasoline, and Diesel

4.1 Renewable Fuel Production Costs

4.1.1 Ethanol Production Costs

4.1.1.1 Corn Ethanol

Corn ethanol costs for our work were estimated using a model developed by USDA that was documented in a peer-reviewed journal paper on cost modeling of the dry-grind corn ethanol process.⁸⁵¹ The USDA model considers a 40 MMgal/yr corn plant producing ethanol with a primary co-product of distillers dried grains with solubles (DDGS). The ethanol yield used in the model is 2.76 gallons per bushel with 2.0% gasoline denaturant. The model is based on work done in chemical process simulation software to generate equipment sizes, stream flowrates, and material and energy balances. These results were then put together with feedstock, energy, and equipment cost information in a spreadsheet format to arrive at a final per-gallon cost estimate. Although the model is current in terms of technology, yields, and capital estimates, we made some modifications to allow estimation of costs for ethanol plants of different sizes and operating under different energy and feedstock prices. We believe that these updates, in combination with the industry and supplier surveys done by USDA in developing the model, result a reasonable estimate for projected ethanol production costs.

We estimate an average corn ethanol production cost of \$1.43 per gallon in 2022 (2006 dollars) for the policy case. The cost of ethanol production is most sensitive to the prices of corn and the primary co-product, DDGS. Utilities, capital, and labor expenses also have an impact, although to a lesser extent. Corn feedstock minus DDGS sale credit represents about 57% of the final per-gallon cost, while utilities, facility, and labor comprise about 22%, 11%, and 4%, respectively. For this work, we used corn and DDGS price projections generated by the Forestry and Agricultural Sector Optimization Model, which is described in Section 5.1.1 of this RIA. Figure 4.1-1 shows the cost breakdown for production of a gallon of ethanol. Note that this production model does not account for the cost to ship the DDGS. Those costs are external and are expected to increase the price of DDGS an end user located far from the plant.

**Figure 4.1-1.
Cost Breakdown of Natural Gas Dry Mill Corn Ethanol Production (2006\$).**

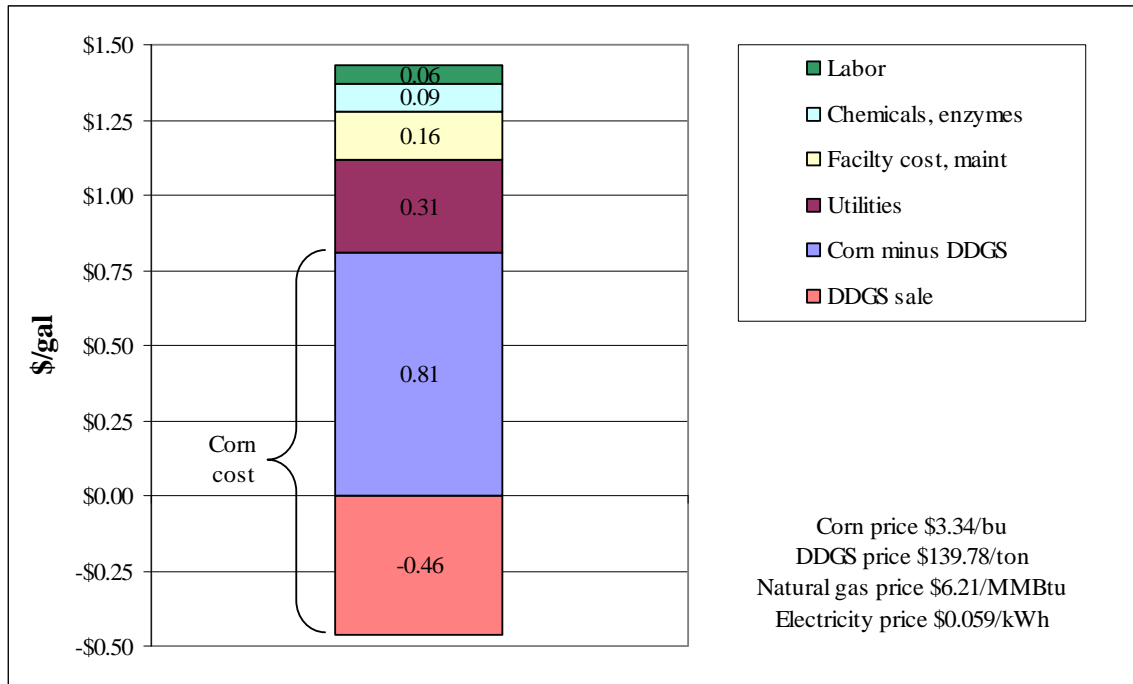

The effect of plant scaling on production cost can be estimated by applying an engineering scaling factor to all plant equipment. In past rulemakings involving modifications to refineries we have used a material scaling factor of 0.65. This factor is applied as an exponent to the ratio of the new size to the original size, the result of which is then multiplied by the original capital cost. The fact that this figure is less than 1.0 reflects the per-unit or per-gallon savings that is often realized when processes are scaled up. However, there is information suggesting that a general factor may be considerably higher for ethanol plants. A factor of 0.84 was put forth in a recent publication on dry mill ethanol production.⁸⁵² Using this larger factor, we find that the change in per-gallon production cost due to economies of scale is very small over the range of typical plant sizes, on the order of \$0.02 between 40 and 100 MMgal/yr. Thus, in computing production costs for this rulemaking we chose to ignore effects of any changes average plant size. Capital cost for a 40 million gal/yr facility is estimated at \$58.1 million (2006\$) based on the USDA production model.

We considered the per-gallon cost impact of coal, biomass, and biogas as a process energy source rather than natural gas. Our industry characterization and forecast work suggests that ethanol production in the timeframe of our analysis will use a mix of feedstocks for process energy. We assumed that on average, coal and biomass combustion systems would have the capital cost due to similarities in feed, ash handling, and emission controls; the same argument can be made for use of biogas combustion relative to natural gas combustion (excluding the digesters or other source). Tables 4.1-2 and 4.1-3 show the breakdown of fuel sources and their cost impacts in cents per gallon. The weighted average cent per gallon change to baseline for ethanol production is given at the bottom of Table 4.1-3.

**Table 4.1-2.
Breakdown of fuel types used in estimating production cost of corn ethanol**

Plant Type	Fuel Type				Total by Plant Type
	Biomass	Coal	Natural Gas	Biogas	All Fuels
Coal/Biomass Boiler	11%	0%	-	-	11%
Coal/Biomass Boiler + CHP	10%	4%	-	-	14%
Natural Gas Boiler	-	-	49%	14%	63%
Natural Gas Boiler + CHP	-	-	12%	-	12%
Total by Fuel Type	21%	4%	61%	14%	100%

**Table 4.1-3.
Breakdown of cost impacts by fuel type used in estimating production cost of corn ethanol**

Plant Type	Fuel Type				Total by Plant Type
	Biomass ^a	Coal	Natural Gas	Biogas ^b	All Fuels
Coal/Biomass Boiler	-\$0.02	-\$0.02	-	-	-
Coal/Biomass Boiler + CHP	+\$0.14	+\$0.14	-	-	-
Natural Gas Boiler	-	-	baseline	+\$0.00	-
Natural Gas Boiler + CHP	-	-	+\$0.16	-	-
Total by Fuel Type	-	-	-	-	\$0.04

Table 4.1.3 shows that we made the assumption that biomass firing has the same overall cost impact on ethanol production as coal firing. One reason for this is that our analysis of biomass feedstock costs suggests a range of \$72 per ton in future years which is comparable to the cost of coal supplied to non-electric-power industries after transportation is included.⁸⁵³ Wood and stover biomass has on average approximately 85% of the energy content of coal on a mass basis, varying by type of biomass and coal, again suggesting that they are comparable on an energy per mass basis.⁸⁵⁴ Thus, it is plausible that some ethanol producers near biomass sources (such as the Midwest and Southeast) may have a cost incentive to transition from coal to biomass for process heat. A second reason the assumption of biomass replacing coal in ethanol plants a desire for ethanol plant owners to comply with or hedge against potential fossil carbon emission limits for stationary sources and/or transportation fuel producers.

Similarly, we made the assumption that biogas combustion for process heat would have the same cost impact on ethanol production as natural gas combustion. Use of biogas is somewhat different from biomass in that it would require some capital investment for on-site anaerobic digesters and related feedstock and gas handling equipment. However, we anticipate the digester feedstock itself would have very low or no cost, thus it is reasonable to assume that the ongoing operating costs besides capital would be considerably less than purchasing natural gas. As with biomass combustion, most plants utilizing biogas would take advantage of situations such as co-location with feedlots or MSW facilities where suitable biomass resources are available.

Energy prices used in the model were taken from EIA Annual Energy Outlook 2008, and are shown in Table 4.1-4.⁸⁵⁵ Gasoline denaturant was assumed to cost \$2.05 per gallon in all cases, and coal was assumed to be \$1.94/MMBtu in all cases. The impact of coal firing and CHP were figured as changes from baseline. Table 4.1-5 shows the feedstock prices used for the reference and low-yield agricultural cases. The low-yield case refers to a reduction of per-acre

corn yields by approximately 12%, which has a higher impact on prices than the AEO high oil case.

**Table 4.1-4.
Energy Prices Used for Ethanol Cost Modeling for 2022 (2006\$)**

EIA Price Case	Crude Oil \$/bbl	Natural Gas \$/MMBtu	Electricity \$/kWh
Reference	53	6.21	0.059
High oil	92	7.21	0.061

**Table 4.1-5.
Feedstock Prices Used for Ethanol Cost Modeling for 2022 (2006\$)**

AEO Price Case	Agricultural Case	Corn \$/bu	DDGS \$/ton
Reference	Reference	3.34	139.78
Reference	Low yield	3.84	160.32
High	Reference	3.42	141.68

4.1.1.2 Cellulosic Ethanol

Crop Residue Costs

We could have used any of the crop residues as an example feedstock in the following discussion, since similar logistics apply to all of them. We chose to use corn stover, e.g., the stalks, leaves, and cobs that remain following grain harvest, since it is likely to represent a significant portion of cellulosic feedstocks in the future. Since there is no equipment specifically designed to harvest corn, the system we describe below uses combines, mowers, rakes, balers, and bale haulers already in use for harvesting hay or straw. Differences in stalk or stem diameter and density, bale density, moisture content, machine field speeds and efficiencies are a few things that make it relatively more difficult to harvest stover than hay or straw. One of the main concerns is that the density of the large stover bales, whether round or rectangular, can be as little as one-half that of similar dimension hay bales, which usually translates into higher transportation costs.⁸⁵⁶

Most biomass feedstocks must be harvested, stored, and transported to a processing facility before they can be converted into ethanol. At present, there are no commercial sized cellulosic ethanol plants in the U.S. Likewise, there are no commercially proven, fully-integrated feedstock supply systems dedicated to providing any of the crop residues or other feedstocks to ethanol facilities of any size. We emphasize ‘integrated feedstock supply systems’ because logistically the delivery of a feedstock to a processing facility will require the planning, executing, and controlling of several different, closely integrated operations, e.g., feedstock harvesting, gathering, storing, and moving by road and rail. Apart from the large numbers and wide variety of equipment, these operations will require professional and technical support services and personnel such as office space, staff, and office equipment such as computers and printers. Also, engineers, light- and heavy-duty equipment operators, vehicle maintenance

personnel and repair and storage facilities for tractors, rakes, balers, loaders, and trucks and trailers, as well as transportation infrastructure planning and management.

Ordinarily, to determine the operational sufficiency and efficiency of such a system, we would ‘analyze’ it. We would first break it down into its component parts or essential features and then study them, e.g., how much they cost, and how and/or whether they operate efficiently within the ‘system.’ However, no such system currently exists. Therefore, we ‘synthesized’ a feedstock supply system in order to analyze it. We used a Purdue University, School of Industrial Engineering simulation study of corn stover logistics from satellite storage to an ethanol plant, to set up our feedstock harvesting and gathering operation. Purdue’s notional cellulosic ethanol plant was to be constructed next to an actual existing corn grain plant in northern Indiana. They used discrete event simulation software and GIS tools to study the transportation logistics associated with supplying the conversion facility directly from satellite storage. They identified 785,200 available acres out of 848,453 potential acres, on 2,052 actual farms, of 200-, 400-, or 800-acres, in 12 northern Indiana counties within 50-miles of the production facility (they disregarded fields or farms of less than 200-acres). We reproduced their original table as Table. 4.1-6.

**Table 4.1-6.
Feedstock Availability at Various Distances From South Bend, IN**

Average Distance	County	Actual Acres	Cumulative Acres	Average Farm Size			Available Acres	Cumulative Acres	bales/day	bales/day /farm set
				200	400	800				
12	St Joseph	69	69	74	51	35	63	63	4,956	4,956
25	Elkhart	150	219	90	47	23	55	118	4,328	10,257
	Marshall			110	52	41	76	194	5,928	
30	La Porte	113	332	113	73	70	108	302	8,453	8,453
35	Starke	60	392	34	39	41	55	357	4,328	4,328
40	Kosciusko	93	485	108	66	43	82	439	6,461	6,461
45	Lagrange	132	617	53	47	20	45	485	3,560	9,049
	Fulton			86	66	43	70	555	5,489	
50	Porter	225	842	76	59	34	66	621	5,175	18,224
	Noble			115	47	21	59	679	4,595	
	Pulaski			39	72	64	108	787	8,453	
		842		998	619	435	787		61,726	61,728

We initially assumed that the stover had been harvested (square bales), gathered, field-transported, and stored at seven-satellite storage areas located near the corn fields.⁸⁵⁷ However, upon further study, we determined the counties that Purdue combined into each of the farm sets, weren’t anywhere near each other. In reality, it would have been far too costly to gather all the bales from the Porter, Noble, and Pulaski counties into one site, because these three counties are actually separated by other counties. Rather than try to construct seven satellite storage sites, we constructed a site at the center of each county. This was done in order to estimate the cost to collect the bales from all the fields in each county. We determined that the distance from the center of each of the Porter, Noble, and Pulaski counties, as well as the other two so-called farm-sets, to the ethanol plant was about equal, so regardless of whether we treat them as single sites, the transport costs for the bales to the ethanol plant will be the same. We ‘synthesized’ the feedstock system to harvest, gather, field transport, and store stover bales at the 11-notional

satellite storage units rather than the seven farm-set units used in the Purdue transportation model (our study was not done in conjunction with the Purdue study; rather we used their information/data as the basis from which to synthesize our notional operation). The format we chose to analyze was to shred, rake, square-bale, gather, field-side, and then load and haul the bales to satellite storage; then, as needed, haul the bales to the processing plant.

Rather than guess at how such a system should look and function, we carefully studied several similar systems that were put forward by various agricultural and biological experts.^{858, 859, 860, 861, 862, 863, 864, 865, 866} We used the American Society of Agricultural and Biological Engineers (ASABE), 2007 Standards, Engineering Practices, and Data as the primary source for our equipment capital and operating cost estimates. It has a machinery management section, ASE EP496.3, FEB2006, devoted to providing helpful information in making management decisions involving machine power requirements, capacities, cost, selection, and replacement, as well section ASAE D497.5 FEB2006, with data which includes representative values of farm machinery operating parameters, to aid managers, planners, and designers in estimating the performance of field machines. These data are intended for use with ASAE EP496 (some data are also presented in equation form for easier use with computers, etc.).⁸⁶⁷ We used these sections along with other examples by other experts to estimate the machinery capital and operating costs for our analysis.^{868, 869, 870, 871, 872} We were able to get some machinery purchase prices from vendors whose identities are confidential. We reduced the equipment listed price by 10% to determine the purchase price, a standard industry estimating practice. Otherwise, most of the data used to calculate machinery costs were generated with equations and appropriate data from the ASABE 2007 Standards. We used the equipment, list and purchase prices, along with their power and size estimates, with the suggested data and equations, mentioned previously, to calculate the lifetime hours and years, annual use, field efficiency, salvage value, fuel and oil use and cost (we obtained vendor quotes for oil cost), capital charge, repairs, insurance, housing, taxes, and labor. We compared our data, where appropriate, with the USDA 2006 Price Summary, published July 2007.⁸⁷³ We also compared our results with those generated by the experts we listed earlier in this paragraph.

The Purdue study was based on supplying a 100-million gallon per year ethanol production facility, which they assumed would convert the stover-to-ethanol at 72-gallons per ton; they assumed that the on-farm stover yield was 2-dry tons per acre, as did we. We used National Agricultural Statistical Service (NASS) data to determine the actual corn grain yield in 2005 (the data year for the Purdue study) for the counties studied in the simulation. We determined how much corn each county produced and from that how much stover was produced, 2,455,058 tons or 3.12 dry tons per acre, with an assumed harvest index (HI) of 1:1 (see Table. 4.1.1.2.2.)⁸⁷⁴ HI is based on the assumption that, for a single corn plant, half of the above ground dry matter is made up of stover and the other half is made up of grain. This is a fairly common assumption, although more than one group of researchers has found that this 1:1 ratio may not be the most accurate under some conditions. When considering above ground dry matter before and after full grain physiological maturation, they found that a stover to grain ratio of 0.8 to 1 may be more realistic especially when grain moisture is between 18 and 31 percent.⁸⁷⁵

**Table 4.1-7.
Data Comparison: NASS Indiana Data with Purdue Data and with EPA Calculations**

USDA-NASS – Counties in State of Indiana - 2005					Purdue Model Year – 2005				
	Planted	Harvested	Yield	Production	Model	Available acres	Prorated Production	wet tons	dry tons
County	acres x 10 ³	acres x 10 ³	bu/acre	bu x 10 ⁶	acres x 10 ³	acres x 10 ³	bu x 10 ⁶	x 10 ³	x 10 ³
St Joseph	71	70	147	10.2	69	65	9.5	266	225
Elkhart	60	53	142	7.6	150	52	7.4	206	174
Marshall	94	89	150	13.4	0	87	13.1	366	309
La Porte	117	112	137	15.3	113	104	14.2	398	336
Starke	61	60	137	8.2	60	56	7.7	214	181
Kosciusko	102	100	149	14.9	93	93	13.8	386	326
Lagrange	55	51	113	5.8	132	45	5.0	141	119
Fulton	90	89	159	14.1	0	78	12.3	345	291
Porter	68	67	137	9.2	225	61	8.4	234	198
Noble	65	62	142	8.8	0	57	8.0	225	190
Pulaski	103	101	152	15.3	0	92	13.9	390	330
		855			842	787		3,172	2,455

However, a professor of agricultural engineering at the University of Wisconsin found that several researchers, going back to 1973 reported a grain mass fraction of 45% to 55% of total corn crop DM yield. On average, the variations seem to confirm the common rule of thumb of one unit mass of stover for a unit mass of grain. However, differences among harvesting methods, stages of maturity, and harvest dates can no doubt lead to much of the variation the researchers found in this estimate. His research indicates that the ratio of grain dry mass to total mass increased from about 38% in late August to about 59% on in mid-October, during a recent harvest. Therefore, the stover to total ratio declined from 62% to 41%. During the typical harvest period in the Upper Midwest when grain moisture is between 20% and 30%, the ratio of stover to total dry mass was less than 45% and averaged 43%. These results are similar to those found by others.⁸⁷⁶ Mainly, because we have no information upon which to base a reason to use something different, we chose to use the 1:1 ratio for corn stover to corn grain. We also assumed 56-lbs per wet bushel (15.5% moisture) and 47.3-lbs per dry bushel, for the corn grain, to make our stover yield calculations.⁸⁷⁷ Table 4.1-8 summarizes the general operating parameters for our study.

Table 4.1-8. Operating Parameters

EtOH Operating Year	350-days/yr
On Stream Factor	0.96
Hours per year	8,400-hr/yr
EtOH Production Rate	100,000,000-gal/yr
EtOH Yield	72-gal/dry ton
Feedstock Required	
per year	1,388,889-dry tons/yr
per day	3,968-dry tons/day
Expected Dry Matter Loss	11.8%
Feedstock Harvested	1,574,400-dry tons/yr
Feedstock Yield	2-dry tons/acre
Harvest Period	
Days,	50-days
Hours per Day	16-hr/day
Harvest Hours	800-hr
Format:	Shred/Rake,
	Bale - Lg. Sq. - 3'x4'x8'
	Field Side - Self-Propelled Wagon
	Satellite Storage – Pole Barn on Concrete
	Transport to EtOH Facility – Truck & Trailer

At 72 gallons per dry ton, the processing plant would require 1,388,889 dry tons of stover per year. However, we believe storage and transportation losses can be significant and should be taken into account. If, as stated in the report, they harvested 2-tons per acre, they actually harvested 1,574,400 tons of stover, or 64% of the 2,455,058 tons of available dry stover. The quantity of stover used versus the quantity harvested represents an 11.8% loss.^{cccccccc} Thus, we assumed that with an 11% loss, we would need to harvest 4,498- dry tons of stover per day, which by the time it reaches the plant will actually equal 3,968-dry tons – the amount required per day at the ethanol plant. During a 350-day production year, 1.574-million tons of stover would have be stored in about 3.499-million, 900-lb bales (Purdue study bale weight), at the various satellite storage areas. For this study, we assumed all the loss took place between the satellite storage areas and the ethanol plant, rather than guess what the losses would be at various points within the harvest/transport scheme.

In the following analysis, we did not account for the extra time or equipment that would be necessary for inevitable break-downs. Nor was time and equipment factored in for driving between fields and for weather delays. Stover suppliers face several, in some cases, difficult problems. At best, the actual harvest period is nearly always too short; winter weather can suddenly set in, which in some cases may completely stop a potential stover or straw harvest. Once the grain is harvested and the stalks are mowed, stover usually must be left in the field for three or four days to dry to below 20% moisture before it's baled, otherwise spoilage or rot as well as spontaneous combustion are possible. If it rains, additional time is required for drying and muddy roads and fields can be badly damaged and the field-soil compacted by the increased

^{cccccccc} We indicated in a previous section that there may be as little as 25% to 50% stover actually available; however, since we didn't have the computer software and database Purdue used and therefore couldn't rerun the simulation, we chose to use the data we had.

heavy-weight harvest and transport equipment traffic. One expert commented that, “If there’s a rainy harvest, you might as well forget about it. Also, the longer the wet material is left in the field, there’s more of a chance for microbes to eat away at the hemicellulose.”⁸⁷⁸ Also, delayed baling raises the chances of dry matter loss. The stover needs to field-dry, so the stover harvest can’t actually begin for at least a few days after the grain harvest starts. But, once it begins it can continue until either it’s finished or until winter weather stops it. For reasons that weren’t explained in the report, the researchers at Purdue chose 50-days for the harvest period, which at their 16-hr per day schedule, provided a total of 800-hrs to complete the harvest and store the stover. In this harvest format (800-hrs), most of the machinery will be stored for the balance of the year. Crop harvest schedules in the Midwest and upper-Midwest are determined by the length of the growing season, the time of year when the crops are mature enough to harvest, and the time when winter weather sets in. Under ordinary conditions, farmers use their harvesting machinery during just a few weeks each year. During the past few years, as machinery costs have risen, many farmers have turned to custom harvesters, that move into an area and harvest several farms. A farmer must always weigh the differences in the custom rates and what it would cost him to own the equipment and complete the harvest himself, but then store most of the harvesting machinery for the rest of the year. In the South, winters are milder and it’s possible to harvest some crops all year long. In such cases, feedstocks could conceivably be harvested and shipped to a conversion facility on an ‘as needed’ basis; storage costs could be saved and machinery would be used all year long. However, an important factor, when it comes to harvest machinery, is the usable-life of the equipment. The more hours used each year, the more often the machine will need to be replaced. A machine lasts only so many hours, whether it’s used 800-hrs per year or 8,000-hours per year. We obviously could have arbitrarily chosen some longer period, but in order to maintain at least some consistency with the Purdue study, we chose to use the 50-day schedule for our study. This short period means we must harvest and store a full year’s inventory within a few weeks.

Mow, Shred, Rake: Modern corn combines strip most of the leaves from a corn stalk, but leave up to about half of the stalk standing when they cut it off just below the bottom ear. In the combine, the corn grain is stripped from the cob, and the top part of the stalk, the leaves, and the cobs are subsequently discharge out the spreader at the rear of the machine. According to a group of researchers, at the time of grain harvest, of the total stover dry mass, 16% resides in the cob, 7% in the husk, 16% in the leaves, and 60% in the stalk fractions. Of the stalk dry mass, roughly 45% is found in the bottom one-quarter and 80% in bottom one-half of the stalk. If stover yield is to be maximized, harvesting systems must be developed that allow the bottom half of the stalk to be fully harvested⁸⁷⁹ We summarized the costs to shred and rake in Table 4.1-9

Table 4.1-9. Corn Stover Shredding & Raking Operation

	Tractor – 245-hp	Flail- Shredder -30'	Tractor 75-hp MFWD	Wheeled V-Rake - 20 ft
Equipment Factors				
Purchase price	\$ 144,502	28,733	59,383	3,660
Useful life	yrs 11.3	3.1	11.3	15
Discounted Salvage value	\$ 11,736	0.00	7,861	
Annual use	hr 800	800	800	800
Fixed Costs \$/hr				
Depreciation and interest	25.47	14.51	10.06	1.87
Taxes Insurance Housing (THI)	\$/hr 3.97	0.79	1.63	0.10
Total Fixed Costs	\$/hr 29.44	15.30	11.69	1.97
Variable Costs				
Repairs and maintenance	\$/hr 19.62	14.05	8.06	1.63
Fuel consumption	gal/hr 9.6	8	5.6	
Fuel and lubrication	\$/hr 23.82	19.87	13.81	4.27
Operating Interest	1.70	1.21	0.82	0.21
Labor	\$/hr 15.91	15.91	15.91	4.00
Total Variable Cost	\$/hr 61.05	51.04	38.60	10.11
Total Costs				
Total	\$/hr 90.49	66.34	50.29	12.08
Equipment capacity	MT/hr	32.7		13.27
Total	\$/ton	4.80		4.70

It will likely be necessary to flail-cut or mow the standing-stalks, and then rake and bale the windrows. We estimated that it cost about \$4.80 per ton of stover for shredding and about \$4.70 per ton for raking.

Bale: As previously discussed, large square bales will likely be the bale-format for this system, although large round bales could be used. There are currently more round balers than square balers in use, mainly because large square balers are more expensive. However, gathering, stacking, and transporting large, round bales is much less efficient. It is difficult to stack round bales more than about three high, since they tend to deform rather badly, during even short storage periods; square bale stacks can be stacked up to five or six bales high, which translates into a more efficient use of storage area as well as more stable stacks that are far less prone to deformation over extended storage periods. Although large round bales tend to weather better out in the open, for the reasons just stated as well as those given in the Purdue report, we used large square bales in this analysis. Table 4.1-10 summarizes the cost of the baling operation.

Table 4.1-10. Corn Stover Baling Operation

		Tractor - 275-hp	Lg. Sq. Baler - 3' x 4' x 8'
Equipment Factors			
Purchase price	\$	147,102	110,723
Useful life	yrs	11.3	3.8
Discounted Salvage value	\$	7,553	32,455
Annual use	hr	800	800
Fixed Costs \$/hr			
Depreciation and interest		25.93	36.74
Taxes Insurance Housing (THI)	\$/hr	4.05	3.04
Total Fixed Costs	\$/hr	29.98	39.78
Variable Costs			
Repairs and maintenance	\$/hr	19.98	45.11
Fuel consumption	gal/hr	10	8
Fuel and lubrication	\$/hr	24.84	19.87
Operating Interest		1.71	2.38
Labor	\$/hr	15.91	10.66
Total Variable Cost	\$/hr	62.44	78.02
Total Costs			
Total	\$/hr	92.42	117.80
Equipment capacity	DMT/hr	19.4	
Total	\$/ton	10.87	

Another, sometimes overlooked issue, is that when stover is shredded, raked, and baled dirt tends to be picked-up with the bales, which must be removed prior to processing. Dirt can usually be traced back to dirt clods left by the producer’s cultivation practices and when the pickup on the harvester is set too low in an attempt to pickup as much stover as possible. Some dirt sticks to the corn stover if the stalks are left on the ground and run over by equipment; occasionally roots, attached to the short, cut-off stalks that are left following the shredding operation may be tipped out of the ground by harvest equipment and end up in the bales. Exact amounts of dirt aren’t easily measured, but are thought to be in the 2% to 5% range. Areas that contain excessive weeds should be avoided, if possible. Some weed types also contribute to additional moisture and dirt and these are thought to be major factors in stover deterioration and overall shrinkage. Furthermore, dirt that’s carried through the harvesting process causes severe equipment wear; grinders, mills, valves, pipes, conveyors, and other associated equipment fail much sooner, which translates into increased maintenance costs and reduced on-stream operating time. We estimated that baling cost about \$10.87 per ton.^{880, 881,}

Bale Pick-Up & Field Side: It is important to remove the stover bales from off the fields. Few farmers will tolerate bales left for long periods on their fields, especially if there is a chance spring planting will be negatively affected. Nor do we expect farmers will allow random piles of bales left at field edges, for retrieval over the winter and spring months. Aside from the likelihood that trucks and other equipment would get stuck in muddy roads and fields, thus slowing down deliveries and running up operating costs, farmers would have little tolerance for torn-up roads and fields. This may not be a big problem, if the farmer/grower intends to plow a field in the spring. However, it could be highly problematic for a farmer/grower who “no till” farms and would be forced to repair ruts and holes in fields and roads before Spring planting. Apart from this, dry matter losses from bales, left out in the open on dirt, can be as high as 10%

to 20%. At harvest time, the bales, regardless of format, must be picked up and hauled either to a satellite storage site for intermediate storage or hauled directly to the processing plant.

Several variables must be taken into account for bale pickup and the field-side haul operation that could easily affect the cost. Because the exact location on a field where a bale lands as it falls from a baler varies, at a minimum, according to stover yield and harvest efficiency, there is no easy or accurate method for predicting the exact location of each bale on the field, either relative to each other or to the field edges or entry. The distance between bales and the potential variability in the area, shape, and relative dimensions of each field add to the difficulty of estimating bale pickup costs. If it was possible to somehow tag each bale with GPS coordinates as it fell to the ground, theoretically the coordinates could be used in some type of ‘bale retrieval’ program to optimize the time and pickup distance traveled.^{882, 883}

For this study, we used the theoretical stover density on the field, the speed and width of the harvester to estimate the distance between bales. We used a spreadsheet with these data to position the bales in a variety of patterns on a notional rectangular 100-acre field. We devised three or four drive-patterns in which the bales could be retrieved, by using simple visual inspection. We calculated the time to pick up the bales using each pattern and the average speed of the self-propelled bale-wagon. There were a few variables for which we couldn’t adjust our numbers because we simply had no way of knowing their effect. For example, if the field was furrowed, it seemed that the less time spent driving across the furrows, at, as we assumed a slower speed than could be traveled along the furrows, the more efficient would be the pick up. Table 4.1-11 summarizes the information we used for our calculations.

Table 4.1-11. Bale Pickup and Field-Side

Ft. Between Each Bale	490		
Pickup One 10-Bale Load - Ft/Load	4,901		
Bales/Acre	4.4		
Bales/Load	10		
Tons/Load	4.5		
Loader Speed - mph	7.5		
Field Size - Acres	200	400	800
Number of Loads per Field Size	89	178	356
Bales/Field Size - Total	889	1,778	3,556
Miles Traveled per Load	1.74	2.05	2.51
Tons/Hour	26	22	18
Cost per Ton – Pickup & Field-Side	\$2.82	\$3.31	\$ 4.05

In any case, using our basic assumptions, the time it took to retrieve a 10-bale load didn’t vary significantly for any of our plots. Table 4.1-12 presents the operating data for the bale wagon.

Table 4.1-12 Self-Propelled Bale-Wagon

		Bale Wagon
Equipment Factors		
Purchase price	\$	153,716
Useful life	yrs	18.1
Discounted Salvage value		6,013
Annual use	hr	800
Fixed Costs		
Depreciation and Interest	\$/hr	20.70
Taxes Insurance Housing (THI)	\$/hr	4.23
Total Fixed Costs	\$/hr	24.93
Variable Costs		
Repairs and Maintenance	\$/hr	12.96
Fuel Consumption	gal/hr	7
Fuel and Lubrication	\$/hr	17.39
Operating Interest		1.21
Labor	\$/hr	15.91
Total Variable Cost	\$/hr	47.47
Total Costs	\$/hr	72.40
Total	\$/hr	72.40
Equipment capacity	DMT/hr	23
Total	\$/ton	3.15

Since the fields were no smaller than 200-acres, we piled the bales at one of the corners, which we assumed as the field-entry. We calculated the cost to haul bales for each of the 200-, 400-, and 800-acre fields. We assumed the 20-ft rake made 148-passes across the 200-acre field; 209-passes across the 400-ft field; and 295-passes across the 800-ft field. We used the number of windrows the rake left to determine the number of passes the baler would make. The baler dropped a bale every 490-ft; to collect a 10-bale load the loader would need to travel 4,900-ft. We estimated that the average distance every bale would need to travel to the corner of the field, e.g., the field entry, would be the distance from the field center to the corner (field-entry); we assumed the fields were square. The loader would need to travel that distance and then return empty, for the next load. Therefore, each loader would travel 4,900-ft to pickup the load, and then an additional 4,174-ft for the 200-acre field; 5,903-ft for the 400-acre field; and 8,348-ft for the 800-acre field to haul to the field edge (corner) and return. We chose to pick up 10-bales per load with a self-propelled bale wagon with an average speed of about 10-mph. We assumed the bales would be picked up, transported, and dumped at the field-edge at a cost of \$2.82-per ton for the 200-acre fields; \$3.31-per ton for the 400-acre fields; and \$4.05-per ton for the 800-acre fields. We weighted the DM hauled for each field size by the total tons recovered from each size, to arrive at 23-weighted dry tons/hr hauled for \$3.15-per ton

Haul to Satellite Storage: Theoretically, we could store all the bales at the ethanol plant. If so, we would need to move 3,148,800-bales or about 101-loads per hour for 16 hours each day during the 50-day harvest. It would require 50-stacks, each, eight-bales wide by 5-bales high, by 1,577-bales (12,615-ft.) long, with 51 x 20-ft aprons and isles, between each stack and along two-sides of the entire area, plus a 20-ft apron, across the entire front and rear. The area would total ~33-million square feet or 1.19-square miles.

We stored the bales at satellite facilities near the center of each county. As previously discussed, the Purdue study established ‘farm-sets,’ but did not describe how they were configured and how bales were to be hauled to each storage site, nor did the study specify exactly where each storage site was. Rather, they only estimated the distance between each storage area and the ethanol plant. The following table summarizes the cost factors used to estimate the costs to haul the bales to satellite storage.

**Table 4.1-13.
Haul - Field Side to Satellite Storage**

		High-Speed Tractor	Bale Wagon	2-Telescopic Handlers
Equipment Factors				
Purchase price	\$	133,865	23,851	130,106
Useful life	yrs	15	15	12.5
Discounted Salvage Value	\$	10,782	4,803	6,490
Annual use	hr	800	800	800
Fixed Costs				
Depreciation and Interest	\$/hr	19.62	3.34	21.48
Taxes Insurance Housing(THI)	\$/hr	3.68	0.66	3.58
Total Fixed Costs	\$/hr	23.30	4.00	25.06
Variable Costs				
Repairs and Maintenance	\$/hr	13.63	1.94	15.90
Fuel Consumption	gal/hr	6	0	2
Fuel and Lubrication	\$/hr	14.90	0	9.94
Operating Interest	\$/hr	1.13	0.09	1.02
Labor	\$/hr	15.91	7.95	31.82
Total Variable Cost	\$/hr	45.57	9.98	58.68
Total Costs	\$/hr	68.87	13.98	83.74
Total	\$/hr	166.59		
Equipment capacity	DMT/hr	9.3		
Total	\$/ton	17.91		

We assumed that a telescopic loader would load the bales at the field-edges onto 20-bale, 2-axle, 30-ft long wagons, each pulled by a high-speed tractor to the storage area located at the center of each county, where they were unloaded by another telescopic loader and the bales stacked for temporary storage. Several variables make the cost of this operation difficult to estimate. A cursory inspection of the general outline/shape of many of the counties in the study reveals that they are by no means square. However, to make our calculations manageable, we assumed they were in order to determine the average distance each bale would need to be transported to its respective storage area in each county. We estimated that the average distance any load would travel from any position in the counties, e.g., from the furthest to the nearest, would be equal to one-half the distance from the corner of the county to its center. We used the published area of each county, from which we determined the distance from one-corner to the center; that distance equaled the trip to the storage area and the return. We multiplied each by a 30% winding factor (rather than a straight-line drive, this accounts for turns and other meanderings).⁸⁸⁴ We estimated the operation would cost about \$17.91 per ton.

Satellite Storage: We assumed each storage unit would consist of a concrete slab with open sides and pole-supported tin roof. Smooth paved surfaces are safer and make work easier. Gravel and dirt do not stick to the bottoms of the bales. If winter (wet, muddy) access is necessary, this cost should be included in the overall costs for storage; particularly from the highway to the stack. Beyond the need to keep the area around the stack accessible and clean, there could be problems with local authorities, if trucks leaving the property carry significant quantities of mud onto a public highway. Ordinarily, in an agricultural area a certain amount of mud is expected to be left on highways during wet weather. However, at the truck and trailer volumes we're anticipating, the amount being tracked onto highways and possibly through municipalities, would increase rapidly. We used 1% of construction costs for upkeep, and 2% of the construction cost for the storage unit to cover the cost of access. These are incurred costs within the overall maintenance of stored stacks of biomass. These costs are essentially insignificant in the overall storage costs, are subject to great fluctuations due to weather and equipment availability, and, therefore, were rolled up into a percentage of the overall storage costs of stacked bales. The following table summarizes our storage area construction cost factors and costs.

**Table 4.1-14.
Satellite Storage Construction & Maintenance Costs – For Each of 11-Areas**

Land Rent	\$/acre/yr	100						
Land Preparation	\$/acre	30,000						
Construction	\$/sq ft	3.75						
Upkeep – Construction	1% of \$/t	0.91						
Access – 2% of Construction	\$/t	1.81						
Depreciation Period	yrs	12						
		Number of Bales	Bale Storage Area sq ft	Bale Storage Area acres	Number of Bales per site	Tons Stover per site	Supply days	Total Storage Cost \$/dry ton
St Joseph		280,889	2,943,716	280,889	280,889	126,400	28.1	1,123,463
Elkhart		245,333	2,571,093	245,333	245,333	110,400	24.5	981,252
Marshall		336,000	3,521,280	336,000	336,000	151,200	33.6	1,343,889
La Porte		479,111	5,021,084	479,111	479,111	215,600	47.9	1,916,286
Starke		245,333	2,571,093	245,333	245,333	110,400	24.5	981,252
Kosciusko		366,222	3,838,009	366,222	366,222	164,800	36.6	1,464,768
Lagrange		201,778	2,114,631	201,778	201,778	908,00	20.2	807,044
Fulton		311,111	3,260,444	311,111	311,111	140,000	31.1	1,244,342
Porter		293,333	3,074,133	293,333	293,333	132,000	29.3	1,173,236
Noble		260,444	2,729,458	260,444	260,444	117,200	26.1	1,041,692
Pulaski		479,111	5,021,084	479,111	479,111	215,600	47.9	1,916,286
							350	
Total Cost	\$/ton	8.89						

With well-paved surfaces, equipment can be maneuvered regardless of weather, and surfaces can be sloped to enhance drainage. We also assumed the bales would be stored in multiple stacks, 8-bales wide and 5-bales high, and long enough to accommodate the number of bales we expect; there would 20-ft aprons along the outside of the stacks and 20-ft isles between stacks for stacking, stack management, and for general and fire safety.⁸⁸⁵ One researcher

determined that the economics of size, in the current situation, did not really apply. In order to determine a cost per square foot, we assumed all 3,148,800 bales would be stored on a single slab/pole barn. Stacked five-high, it would require 758-acres or 1.18 sq. miles of concrete and roof. We estimated that storage would cost about \$8.89 per ton.⁸⁸⁶ We used this as the cost per ton for the satellite storage as well as for storage at the plant.

We estimated that to shred, rake, bale, field side, construct satellite storage, and haul to satellite storage plus pay the farmer/grower \$10/t and replace the nutrients for \$11.81/ton, it would cost about \$72.20 per dry ton.^{887 888}

We used 11-telehandlers at the storage areas. (However, once the harvest is complete the telehandlers being used for loading and unloading bale wagons during the field-side to storage area operation could possibly be pressed into transport – load, unload service (see Table 4.1-15). If so, the cost to use the telehandlers could be reduced from \$3.28 to \$3.08 per ton.) Plus 11-telehandlers at the plant to load and unload trucks and trailers that deliver the stover from satellite storage to the plant; extra telehandler time at the plant will be used to move feedstock as needed. The following table summarizes the cost associated with the transportation. The following table summarizes the cost associated with the transportation

Table 4.1-15. Haul From Satellite Storage to Plant

		Class 8 Truck	53-ft Flatbed Trailer	22-Telescopic Handlers
Equipment Factors				
Purchase price	\$	103,839	42,173	130,106
Useful life	yrs	20	22	13
Discounted Salvage Value	\$	4,025	931	6,490
Annual use	hr	5,600	5,600	800
Fixed Costs \$/hr				
Depreciation and Interest	\$/hr	1.91	0.74	236.28
Taxes Insurance Housing(THI)	\$/hr	0.41	0.71	39.38
Total Fixed Costs	\$/hr	2.31	1.45	275.66
Variable Costs				
Repairs and Maintenance	\$/hr	1.13	3.16	174.90
Fuel Consumption	gal/hr	9	0	2
Fuel and Lubrication	\$/hr	33.95	0	109.34
Operating Interest	\$/hr	0.37	0.14	11.22
Labor	\$/hr	17.46		350.02
Total Variable Cost	\$/hr	52.91	2.31	\$645.48
Total Costs	\$/hr	55.22	3.76	921.14
Total	\$/hr	58.97		921.14
Equipment capacity	DMT/hr	4.5		281
Total, each	\$/ton	13.10		3.28
Total	\$/ton	16.38		

To transport the bales to the ethanol plant, we calculated the ton-weighted average trip-time to be 4.09 hr. We plan to ship 4,497-tons of stover to the plant on each of the 350-operating days. At 17.5-tons per load, we anticipate there will be about 256-loads per day. Using the 4.09-ton weighted trip time, we estimated that it would require 63-trucks and trailers to haul 4 x 17.5-

ton per day. The cost of transportation plus loading and unloading is estimated to be \$16.38 per dry ton. The following table summarizes the total cost to harvest, bale, field-side, haul to satellite storage, store, and haul to the plant. The following table summarizes all the costs.

**Table 4.1-16.
Ag Residue Cost Summary**

Farm-Set Size, acres		200	400	800	Total Tons
Tons per Farm-Set, t		756,439	476,402	341,559	1,574,400
Farmer/Grower \$/t		10.00	10.00	10.00	
Nutrient Replace \$/t		11.81	11.81	11.81	
Shred \$/t		4.80	4.80	4.80	
Rake \$/t		4.70	4.70	4.70	
Bale \$/t		10.84	10.84	10.84	
Haul – Edge \$/t		2.82	3.31	4.05	
Total Farm Edge Cost \$/t		44.97	45.46	46.20	
Haul – SS \$/t		17.91	17.91	17.91	
Storage \$/t		8.89	8.89	8.89	
Haul to Ethanol Plant \$/t		16.38	16.38	16.38	
Field to Plant – Total \$/t		43.18	43.18	43.18	
Per Farm- Set – Total \$/t		88.15	88.64	89.38	
Avg. Total Cost \$/t		88.71			

The FASOM agricultural econometric model also estimated the farm edge price for corn stover. Like our analysis, the FASOM model accounted for harvesting, shredding, raking, baling and hauling the corn stover to the farm edge, and replenishing the soil with nutrients. However, FASOM did not add on a \$10 farmer payment. Adding on a \$10 farmer payment, FASOM’s farm edge price for baled corn stover was \$42.70/ton. There was good agreement between our cost estimate and FASOM’s.

As mentioned previously, a supply system organized in the near-term could look something like the one we’ve just described, but there are several potential drawbacks;. a comment, which we can’t attribute for confidentiality reasons was about the inefficiency of expending energy to package biomass just to expend more energy to unpackage this same biomass in order to meet the requirements of the conversion process.

We anticipate that industry will address most of these drawbacks by 2022 in order to improve the delivery and reduce the cost of feedstocks. The current harvest-system is usually referred to as a multipass system: the corn grain is first combined, and then the stover is shredded, raked, baled, and the bales hauled to the field side. Each field-pass adds to the final cost and further compacts the soil; soil compaction is especially critical if the soil is prone to compaction or in no-till situations.⁸⁸⁹ Because the combine-spreader drops the stover on to the ground, not only are fewer cobs collected, but dirt, dirt clods, and other debris, including metal,

are inevitably gathered up with the stover by the baler.^{890, 891} Thus, extra effort and money must be expended to remove the debris before processing can begin, apart from the fact that dry matter is also lost during this operation. In their 2002 study report, NREL included a wash table to remove dirt and grit and had magnets to remove tramp iron, e.g., wire, etc. from the stover.⁸⁹² We discussed many of these issues previously.

According to a few sources, which for reasons of confidentiality, we can't quote, there appears to be active interest in restructuring the system we just described to move the preprocessing (feedstock preparation) forward in the chain, away from the ethanol plant, and closer to the fields. Including the issues highlighted in the previous paragraphs, a major concern has to do with the use of standard hay and forage equipment, for which the overall collection efficiency of stover (ratio of stover collected to the total above-ground stover excluding grain) using flail choppers, rakes, and balers was less than 30%.⁸⁹³ Until now, most research has been based on a multipass system similar to the one we synthesized.^{894, 895} In addition, the timeliness for collection (weather concerns) and moisture content issues are major problems associated with a multipass corn stover harvest.⁸⁹⁶

The restructuring efforts also include exploring other methods to more efficiently gather the stover that avoids the need to pick it up from the ground, e.g., gather or catch it before it hits the ground.⁸⁹⁷ In one early case, a baler was hitched directly onto a combine, to capture the combine effluent and square-bale it. The problem was that there was a strict need to limit moisture to under 20% if bales are to be stored, plus the extra equipment slowed the grain harvest.⁸⁹⁸ Ideally, the stover harvest system should be capable of harvesting stover at any level of moisture even while the grain is being harvested. All the cobs would be collected, the stover wouldn't touch the ground and a controlled amount of residue would be left to meet any conservation requirements (we believe finding a way to leave the correct amount of residue behind will be difficult, and should be a top priority).

A modification of the system we previously described, would be to use a mobile tub grinder that could be towed from one satellite storage area to the next. A telehandler would feed the grinder to directly fill trucks for transport to the production facility. The 'walking floor,' rear-dump, or belly-dump trailers would unload the ground-up stover into silos or tanks at the facility. These silos or tanks could be sized to provide as much feed surge capacity as the facility required to maintain continuous operation.⁸⁹⁹

Again, ideally, the corn stover harvest should be reduced to a single-pass operation during which the amount of residue left on the field will be less a function of harvest efficiency and more a function of the farmer/grower and the harvesting company being able to determine how much residue must be left to maintain soil health. In reality, most of the equipment doesn't actually exist that could perform some of the operations we will describe. Nevertheless, we believe this reflects some of the forward thinking that is currently taking place. For example, a combine designed specifically for the job must still be constructed. A single-pass harvester would cut the whole stalk a few inches above the soil, leaving some stalk anchored to the ground. It would pull the entire plant, e.g., stalks, leaves, and cobs with grain into the combine, where they are mixed into a single, clean, grain and stover stream. It would then blow the entire stream into tractor-pulled grain-carts that run along-side the harvester. It is important to be able

to change full carts for empties without stopping the harvester. As a cart is filled, it is pulled from beneath the discharge tube, as an empty cart is pulled under it. The full cart is hauled to the field side, where the harvested material is unloaded directly into bulk 'walking-floor' semi trailers, for transport to a co-op or depot type elevator/facility. After the biomass stream is unloaded, equipment at the elevator/depot separates the stover from the grain, following which the stover is chopped, dried, and sent to tanks or silos for intermediate storage. Currently, there are no simple methods for drying wet corn stover, other than to let it field-dry. However, if the single-pass harvest is to become a reality, the stover will need to be dried or else stored in much the same way silage is stored.⁹⁰⁰ At harvest, corn grain has a moisture content of 25%, while at the same time, the stover ordinarily ranges from 35% to well over 50% moisture. There have been studies to artificially dry corn stover as well as other biomass types; there will likely be changes to the reported results of these and other studies, but, then we expect advancements and certainly changes in several parts of the feedstock supply system.^{901, 902, 903} Given that these changes take place, the stover, would have flowability characteristics similar to small cereal grains, and could be moved by standard grain loading and unloading systems into large corrugated steel bins (silos) for intermediate storage. In this harvest format, the stover is handled by only two machines before it reaches the roadside and never hits the ground. Dry matter losses should be significantly reduced.⁹⁰⁴

Harvesting, storing, and transporting a denser feedstock should offer significant savings.⁹⁰⁵ Using this and other anticipated improvements, it appears possible that in the out years, e.g., by 2022, corn stover and other residues could be commoditized, much as is the case with grain, and then purchased by a processor on an as-needed basis.

However, commoditization offers its own set of issues, among which are both tangible and non-tangible infrastructures. Although tangible infrastructure with regard to ethanol distribution are discussed in greater detail in Section 4.2, we believe the following comments fit within the context of our preceding information. The impact of both feedstock and finished ethanol on rural road, highway and railroad infrastructure is likely to be even greater than the current and anticipated impact of corn based ethanol. Raw cellulosic feedstocks have lower levels of concentrated fermentable carbohydrates and therefore require a greater mass of feedstock to produce an equivalent level of ethanol. Thus, public and private transportation infrastructure must move a greater volume of feedstock per gallon of ethanol produced. The magnitude of the impact will depend on the field density of feedstocks near the plant and whether feedstock densification will make it possible to ship more dense carbohydrate product to the cellulosic ethanol plant.

Intangible infrastructure is essentially absent for crop residue type cellulosic feedstocks. Intangible infrastructure includes such things as uniform grade and quality standards, market price discovery mechanisms, collateral warehouse receipts, regulatory structure and other marketing institutions. Grain market institutions have been developed and fine-tuned over the past century that give corn ethanol plants a decided benefit. Daily price information, as well as a wealth of crop condition, and supply and demand information from a variety of public and private sources is available on corn grain. Well known institutions such Uniform Grade and Quality Standards, FGIS, Grain Warehouse Regulations, Collateral Warehouse Receipts, Trade Associations, Non-Recourse Government Commodity Loans, and a set of futures markets that

efficiently price grain over time and space are all readily available. This infrastructure is already in place, tested and readily accessible to corn grain ethanol producers. Although not highly visible and frequently taken for granted, it plays a critical role in efficient feedstock pricing, risk management, trading and financing. The cellulosic marketing infrastructure required for similar efficient commercial transactions will need to be established from top to bottom.

Pricing infrastructure is one of the most pressing needs. Large daily volumes of corn and other grains are traded on well established exchanges with a great deal of confidence on the part of buyers and sellers that the other party will perform. Initially, it could be difficult, at best, to develop these infrastructure benefits for crop residues such as corn stover. Cellulosic feedstocks will be starting from a relatively small production base with no pricing institutions in place. There are no existing grades and quality standards to underpin transactions over distance and time. Nor are there any trade rules or established patterns for prompt and efficient settlement of trade disputes between buyers and sellers. The absence of these factors does not mean that they won't develop, but there could be a stressful transition period.

Also, there is no regulatory infrastructure to protect producers who wish to hold inventory after harvest in a public warehouse or handlers warehouse. This kind of infrastructure serves an important role in underpinning warehouse receipts and producer financing by creating a higher and more reliable collateral value for inventory. Nor are there equivalents to the U.S. grain grades and quality standards or Federal Grain Inspection Service. While there are other ways these functions can be provided some type of commodity grades and standards will be necessary to permit trading. Another possibility would be to have the production of cellulosic feedstocks and the production of ethanol vertically integrated in some fashion so that the responsibility for quality is internalized.⁹⁰⁶

Energy Crops

Energy crops such as switchgrass and miscanthus would be harvested, baled, stored and transported very similar to crop residues. Because of their higher production density per acre, though, we would expect that the "farm gate" costs to be slightly lower than crop residues (we estimate the costs to be about \$1 per dry ton lower). Also, the higher production density would allow for fewer secondary storage facilities compared to crop residue and a shorter transportation distance. For example, we estimate that switchgrass would require less than 30 secondary storage facilities which would help to lower the feedstock costs for a 100 million gallon per year plant compared to crop residues. As a result the secondary storage and transportation costs are estimated to be \$9 per ton lower than crop residue such as corn stover. Thus, we estimate that cellulosic feedstock costs sourced from switchgrass would be about \$77 per dry ton. Table 4.1-17 contains a summary of our feedstock cost estimate for switchgrass.

Table 4.1-17. Switchgrass Cost Summary

Farm-Set Size, acres		400
Tons per Farm-Set, t		1,891,000
Farmer/Grower \$/t		10.00
Nutrient Replace \$/t		11.81
Shred \$/t		4.80
Rake \$/t		3.95
Bale \$/t		10.84
Haul – Edge \$/t		2.81
Total Farm Edge Cost \$/t		44.20
Haul – SS \$/t		15.3
Storage \$/t		7.89
Haul to Ethanol Plant \$/t		9.76
Field to Plant – Total \$/t		32.95
Per Farm- Set – Total \$/t		77.15

Forestry Residue

Harvest and transport costs for woody biomass in its different forms vary due to tract size, tree species, volumes removed, distance to the wood-using/storage facility, terrain, road condition, and other many other considerations. There is a significant variation in these factors within the United States, so timber harvest and delivery systems must be designed to meet constraints at the local level. Harvesting costs also depend on the type of equipment used, season in which the operation occurs, along with a host of other factors. Much of the forest residue is already being harvested by logging operations, or is available from milling operations. However, the smaller branches and smaller trees proposed to be used for biofuel production are not collected for their lumber so they are normally left behind. Thus, this forest residue would simply have to be collected and transported out of the forest, although it would still have to be chipped before transport to the biofuel plant.

In general, most operators in the near future will chip at roadside in the forest, blowing the chips directly into a chip van. When the van is full it will be hauled to an end user's facility and a new van will be moved into position at the chipper. The process might change in the future as baling systems become economically feasible or as roll-off containers are proven as a way to handle logging slash. At present, most of the chipping for biomass production is done in connection with fuel-reduction treatments. This could change if the price of raw biomass increases to a point where it becomes feasible to recover logging residues associated with normal commercial operations. The major problem associated with collecting logging residues and biomass from small trees is handling the material in the forest before it gets to the chipper. Balers and roll-off containers offer some promise to reduce this cost. Whether the material is collected from a fuel-reduction treatment or a commercial logging operation, chips from residues

will be dirty and will require screening or some type of filtration at the end-user's facility.^{DDDDDDDD}

Results from a study in South Georgia show that under the right conditions, a small chipper can be added to a larger operation to obtain additional chip production without adversely impacting roundwood production, and chips can be produced from limbs and tops of harvested trees at costs ranging from \$11 per ton and up. Harvesting understory (the layer formed by grasses, shrubs, and small trees under the canopy of larger trees and plants) for use in making fuel chips is about \$1 per ton more expensive.

Per ton costs decrease as the volume chipped increases per acre. Some estimates suggest that if no more than 10 loads of roundwood are produced before a load of chips is made, that chipper-modified system could break even. Cost projections suggest that removing only limbs and tops may be marginal in terms of cost since one load of chips is produced for about every 15 loads of roundwood.

Instead of conducting our own detailed cost estimate for making forest residue chips available at the edge of the harvested forests, we instead relied upon the expertise of the U.S. forest service. The U.S. Forest Service provided us a cost curve for different categories of forest residue, including logging residue, other removals (i.e., clearing trees for new building construction), timberland trimmings (forest fire prevention strategy) and mill residues.⁹⁰⁷ The data was provided to us on a county-by-county basis. The national forest lands are omitted from consideration, and the urban forest residue is not considered here, but in the section discussing MSW. The information was also provided at different price points. The quantities of forest residue is summarized by source type in Tables 4.1-18, 4.1-19 and 4.1-20. To avoid presenting a huge amount of data, we aggregated the county data by state, and we are presenting the data at specific price points: \$30/dry ton, \$45/dry ton and \$70/dry ton.

^{DDDDDDDD} Personal Communication, Eini C. Lowell, Research Scientist, USDA Forest Service

Table 4.1-18.
Volume of Forest Residue Available for Producing Biofuel
Biomass Available at \$30/ton (dry tons)

	Logging Residue	Other Removals	Timberland Thinnings	Primary Mill Residue	Total Quantity
Alabama	2,405,083	507,240	867,038	7,117	3,786,478
Arizona	17,698	44,871	66,171	1,351	130,091
Arkansas	1,703,543	770,985	738,165	12,889	3,225,582
California	669,740	0	1,742,702	65,088	2,477,530
Colorado	18,405	14	0	2,302	20,721
Connecticut	8,391	30,678	20,929	3,949	63,948
Delaware	30,101	24,218	9,835	0	64,155
Florida	1,070,430	515,407	481,893	2,202	2,069,932
Georgia	3,113,907	993,262	1,107,254	45,138	5,259,561
Idaho	253,145	0	83,095	6,006	342,247
Illinois	278,202	235,178	230,863	18,523	762,766
Indiana	562,483	104,173	396,225	10,627	1,073,508
Iowa	112,098	55,160	97,983	159	265,400
Kansas	14,658	88,405	19,353	8,720	131,136
Kentucky	1,027,977	664,358	689,896	55,196	2,437,427
Louisiana	2,634,279	880,585	601,848	30,075	4,146,788
Maine	2,412,877	940	160,628	42,483	2,616,927
Maryland	181,443	830	81,988	17,067	281,327
Massachusetts	70,921	62,087	27,602	0	160,610
Michigan	758,926	244,952	655,280	13,763	1,672,922
Minnesota	697,614	662,985	265,424	26,878	1,652,900
Mississippi	3,097,069	710,142	850,688	95,138	4,753,038
Missouri	774,868	530,292	684,154	79,787	2,069,100
Montana	262,670	0	133,185	9,136	404,990
Nebraska	21,145	18,771	23,414	4,971	68,302
Nevada	29	105	0	0	134
New Hampshire	314,642	348	95,604	7,019	417,613
New Jersey	5,918	77	4,847	1,437	12,279
New Mexico	23,858	2,557	51,796	4,902	83,113
New York	734,006	109,342	326,672	27,390	1,197,410
North Carolina	2,026,330	1,259,265	1,121,627	12,811	4,420,033
North Dakota	2,906	15,202	7,644	265	26,017
Ohio	370,795	18,106	167,351	22,600	578,853
Oklahoma	347,738	197,587	106,086	495	651,906
Oregon	1,520,552	63	1,055,405	16,316	2,592,335
Pennsylvania	1,087,327	1,372	449,956	170,972	1,709,626
Rhode Island	1,769	45,721	5,600	389	53,478
South Carolina	1,429,102	696,577	603,700	1,051	2,730,431
South Dakota	13,944	28,873	5,986	2,294	51,096
Tennessee	633,412	489,840	847,812	187,583	2,158,647
Texas	1,233,553	436,927	371,437	3,021	2,044,938
Utah	5,946	0	19,817	4,437	30,200
Vermont	209,752	37,304	96,790	0	343,845
Virginia	1,483,346	813,600	873,740	39,366	3,210,052
Washington	1,282,288	44	1,850,958	21,446	3,154,736
West Virginia	976,712	49,428	323,306	118,779	1,468,225
Wisconsin	1,137,600	982,264	520,587	60,410	2,700,862
Wyoming	22,685	0	28,100	34,014	84,799
Total	37,061,885	12,330,137	18,970,435	1,295,560	69,658,018

Table 4.1-19.
Tons of Forest Residue Available for Producing Biofuel
Biomass Available at \$45/ton (dry tons)

	Logging Residue	Other Removals	Timberland Thinnings	Primary Mill Residue	Total Quantity
Alabama	2,405,083	507,240	1,012,090	7,117	3,931,530
Arizona	27,131	49,020	69,934	1,351	147,436
Arkansas	1,703,543	770,985	858,827	12,889	3,346,244
California	1,166,955	0	1,898,937	65,088	3,130,980
Colorado	20,112	22	61,238	2,302	83,674
Connecticut	8,601	32,190	20,929	3,949	65,670
Delaware	35,863	28,290	13,400	0	77,554
Florida	1,070,430	515,407	533,194	2,202	2,121,234
Georgia	3,113,907	993,262	1,288,591	45,138	5,440,898
Idaho	432,605	0	105,188	6,006	543,799
Illinois	278,305	235,178	230,863	18,523	762,869
Indiana	562,928	104,173	443,691	10,627	1,121,419
Iowa	112,100	55,215	99,102	159	266,576
Kansas	14,658	88,405	19,353	8,720	131,136
Kentucky	1,027,977	664,358	814,743	55,196	2,562,273
Louisiana	2,634,279	880,585	661,023	30,075	4,205,963
Maine	2,561,023	989	204,885	42,483	2,809,379
Maryland	189,159	842	81,988	17,067	289,054
Massachusetts	78,254	66,382	27,602	0	172,239
Michigan	783,465	257,201	820,603	13,763	1,875,033
Minnesota	717,037	683,787	319,980	26,878	1,747,683
Mississippi	3,097,069	710,142	935,870	95,138	4,838,219
Missouri	774,868	530,292	932,163	79,787	2,317,110
Montana	431,194	0	141,549	9,136	581,879
Nebraska	21,419	18,867	23,414	4,971	68,672
Nevada	44	142	0	0	186
New Hampshire	331,037	395	115,132	7,019	453,583
New Jersey	6,368	79	4,847	1,437	12,731
New Mexico	34,478	2,575	53,724	4,902	95,679
New York	768,914	113,104	379,391	27,390	1,288,799
North Carolina	2,026,330	1,259,265	1,336,840	12,811	4,635,245
North Dakota	2,907	15,202	7,644	265	26,018
Ohio	372,045	18,139	177,144	22,600	589,927
Oklahoma	347,738	197,587	125,400	495	671,220
Oregon	2,502,187	68	1,095,253	16,316	3,613,824
Pennsylvania	1,092,836	1,386	604,355	170,972	1,869,549
Rhode Island	1,913	50,079	5,600	389	57,981
South Carolina	1,429,102	696,577	704,036	1,051	2,830,767
South Dakota	23,743	31,161	6,505	2,294	63,704
Tennessee	633,412	489,840	1,015,395	187,583	2,326,230
Texas	1,233,553	436,927	438,374	3,021	2,111,876
Utah	7,515	0	21,571	4,437	33,524
Vermont	217,084	38,363	107,673	0	363,120
Virginia	1,483,346	813,600	1,048,745	39,366	3,385,057
Washington	2,135,174	46	1,963,678	21,446	4,120,344
West Virginia	976,712	49,428	482,367	118,779	1,627,287
Wisconsin	1,153,876	998,604	654,054	60,410	2,866,943
Wyoming	36,327	0	36,405	34,014	106,745
Total	40,084,609	12,405,402	22,003,291	1,295,560	75,788,862

Table 4.1-20.
Tons of Forest Residue Available for Producing Biofuels
Biomass available at \$70/ton (dry tons)

	Logging Residue	Other Removals	Timberland Thinnings	Primary Mill Residue	Total Quantity
Alabama	2,405,083	507,240	1,163,309	7,117	4,082,749
Arizona	27,131	49,020	77,357	1,351	154,859
Arkansas	1,703,543	770,985	984,188	12,889	3,471,605
California	1,166,955	0	2,001,231	65,088	3,233,274
Colorado	20,112	22	61,238	2,302	83,674
Connecticut	8,601	32,190	20,929	3,949	65,670
Delaware	35,863	28,290	13,400	0	77,554
Florida	1,070,430	515,407	664,706	2,202	2,252,745
Georgia	3,113,907	993,262	1,553,823	45,138	5,706,130
Idaho	432,605	0	123,852	6,006	562,463
Illinois	278,305	235,178	230,863	18,523	762,869
Indiana	562,928	104,173	443,691	10,627	1,121,419
Iowa	112,100	55,215	99,102	159	266,576
Kansas	14,658	88,405	19,353	8,720	131,136
Kentucky	1,027,977	664,358	927,808	55,196	2,675,339
Louisiana	2,634,279	880,585	750,104	30,075	4,295,044
Maine	2,561,023	989	332,233	42,483	2,936,728
Maryland	189,159	842	81,988	17,067	289,054
Massachusetts	78,254	66,382	27,602	0	172,239
Michigan	783,465	257,201	1,066,214	13,763	2,120,643
Minnesota	717,037	683,787	401,197	26,878	1,828,900
Mississippi	3,097,069	710,142	1,033,196	95,138	4,935,545
Missouri	774,868	530,292	1,287,857	79,787	2,672,803
Montana	431,194	0	166,045	9,136	606,375
Nebraska	21,419	18,867	23,414	4,971	68,672
Nevada	44	142	0	0	186
New Hampshire	331,037	395	116,195	7,019	454,646
New Jersey	6,368	79	4,847	1,437	12,731
New Mexico	34,478	2,575	64,375	4,902	106,330
New York	768,914	113,104	385,701	27,390	1,295,109
North Carolina	2,026,330	1,259,265	1,600,910	12,811	4,899,315
North Dakota	2,907	15,202	7,644	265	26,018
Ohio	372,045	18,139	177,144	22,600	589,927
Oklahoma	347,738	197,587	163,268	495	709,088
Oregon	2,502,187	68	1,133,187	16,316	3,651,758
Pennsylvania	1,092,836	1,386	680,995	170,972	1,946,189
Rhode Island	1,913	50,079	5,600	389	57,981
South Carolina	1,429,102	696,577	791,111	1,051	2,917,842
South Dakota	23,743	31,161	8,258	2,294	65,457
Tennessee	633,412	489,840	1,033,100	187,583	2,343,935
Texas	1,233,553	436,927	507,340	3,021	2,180,841
Utah	7,515	0	29,434	4,437	41,386
Vermont	217,084	38,363	142,210	0	397,658
Virginia	1,483,346	813,600	1,260,733	39,366	3,597,045
Washington	2,135,174	46	2,059,970	21,446	4,216,636
West Virginia	976,712	49,428	575,278	118,779	1,720,198
Wisconsin	1,153,876	998,604	841,550	60,410	3,054,440
Wyoming	36,327	0	43,195	34,014	113,536
Total	40,084,609	12,405,402	25,186,746	1,295,560	78,972,317

The U.S. Forestry Service recommended that we choose \$45 per dry ton as the price point for our cost analysis.⁹⁰⁸ This seemed reasonable since this price point was roughly the same as farm gate crop residue discussed above, and so we used this price point for our analysis. Assuming that the wood chips would be ground further in the field adds an additional \$11 per dry ton to the feedstock cost.

Delivery of woody biomass from the harvesting site to a conversion facility, like delivery of more conventional forest products, accounts for a significant portion of the delivered cost. In fact, transportation of wood fiber (including hauling within the forest) accounts for about 25 to 50 percent of the total delivered costs and highly depends on fuel prices, haul distance, material moisture content, and vehicle capacity and utilization. Also, beyond a certain distance, transportation becomes the limiting factor and the costs become directly proportional to haul distance.^{EEEEEEEEEE} We used the Class 8 over-the-road hauling costs estimated in Table 4.1-15 for estimating the hauling costs for forest residue. As a feedstock, forest residue is expected to be available at a higher density per area than corn stover. Thus, its hauling costs would potentially be lower than those for corn stover because the forest residue would be hauled a shorter distance. However, forest residue is often located in more remote locations, so it may have to be hauled a further distance to reach the plant site. We anticipate hauling forest residue to a plant will cost about \$14 per ton. Totalling up the feedstock cost at the forest edge, the grinding cost and the hauling costs results in a total delivered price of \$70 per dry ton.

Municipal Solid Waste

Million of tons of municipal solid waste (MSW) continue to be disposed of in landfills across the country, despite recent large gains in waste reduction and diversion. The biomass fraction of this total stream represents a potentially significant resource for renewable energy (including electricity and biofuels). Because this waste material is already being generated, collected and transported (it would solely need to be transported to a different location), its use is likely to be less expensive than other cellulosic feedstocks. One important difficulty facing those who plan to use MSW fractions for fuel production is that in many places, even today, MSW is a mixture of all types of wastes, including biomaterials such as animal fats and grease, tin, iron, aluminum, and other metals, painted woods, plastics, and glass. Many of these materials can't be used in biochemical and thermochemical ethanol production, and, in fact, would inflate the transportation costs, impede the operations at the cellulosic ethanol plant and cause an expensive waste stream for biofuel producers.

Thus, accessing sorted MSW would likely be a requirement for firms planning on using MSW for producing cellulosic biofuels. In a confidential conversation, a potential producer who plans to use MSW to produce ethanol indicated that their plant plans are based on the obtaining cellulosic biowaste which has already been sorted at the waste source (e.g., at the curbside, where the refuse hauler picks up waste already sorted by the generating home-owner or business). For example, in a tract of homes, one refuse truck would pick up glass, plastic, and perhaps other types of waste destined for a specific disposal depot, whereas a different truck

^{EEEEEEEEEE} Ashton, S.; B. Jackson; R. Schroeder. Cost Factors in Harvesting and Transporting Woody Biomass, 2007. Module 4: Introduction to Harvesting, Transportation, and Processing :: Fact Sheet 4.7

would follow to pick up wood, paper, and other cellulosic materials to be hauled to a depot that supplies an ethanol plant. However, only a small fraction of the MSW generated today is sorted at the curbside.

Another alternative would be to sort the waste either at a sorting facility, or at the landfill, prior to dumping. There are two prominent options here. The first is that there is no sorting at the waste creation site, the home or business, and thus a single waste stream must be sorted at the facility. This operation would likely be done by hand or by automated equipment at the facility. To do so by hand is very labor intensive and somewhat slower than using an automated system. In most cases the 'by-hand' system produces a slightly cleaner stream, but the high cost of labor usually makes the automated system more cost-effective. Perhaps the best approach for low cost and a clean stream is the combination of hand sorting with automated sorting.

The third option is a combination of the two which requires that there is at least some sorting at the home or business which helps to prevent contamination of the waste material, but then the final sorting occurs downstream at a sorting site, or at the landfill.

We have little data and few estimates for the cost to sort MSW. One estimate we generated within our Office of Solid Waste for a combination of mechanically and manually sorting a single waste stream downstream of where the waste is generated puts the cost in the \$20 to \$30 per ton range. There is a risk, though, that the waste stream could still be contaminated and this would increase the cost of both transporting and using this material at the biofuel plant due to the toxic ash produced which would require disposal at a toxic waste facility. If a less contaminated stream is desired it would probably require sorting at the generation site – the home or business - which would likely be more costly since many more people in society would then have to be involved and special trucks would need to be used. Also, widespread participation is difficult when a change in human behavior is required as some may not be so willing to participate. Offering incentives could help to speed the transition to curbside recycling (i.e., charging fee for nonsorted waste, or paying a small amount for sorted tree trimmings and construction and demolition waste). Assuming that curbside sorting is involved, at least in a minor way, total sorting costs might be in the \$30 to \$40 per ton range. We request comment on the costs incurred for sorting cellulosic material from the rest of MSW waste.

These sorting costs would be offset by the cost savings for not disposing of the waste material. Most landfills charge tipping fees, the cost to dump a load of waste, a societal cost that would be avoided. In the United States, the national average nominal tipping fee increased fourfold from 1985 to 2000. The real tipping fee almost doubled, up from a national average (in 1997 dollars) of about \$12 per ton in 1985 to just over \$30 in 2000. Equally important, it is apparent that the tipping fee is much higher in densely populated regions. For example, in 2004, the trend differed by municipality level, from \$9 a ton in Denver to \$97 in Spokane. Statewide averages also varied widely, from \$8 a ton in New Mexico to \$75 in New Jersey. Tipping fees ranged from \$21 to 98 per ton in 2006 for MSW and \$18/ton to \$120/ton for construction and demolition waste. It is likely that the tipping fees are highest for waste contaminated by toxic materials that require the disposal at Resource Conservation and Recovery Act (RCRA) certified toxic waste sites as opposed to a composting site. However, this same contaminated material would not be desirable to biofuel producers. Presuming that only the noncontaminated cellulosic

waste (yard trimmings, building construction and demolition waste and some paper) is collected as feedstocks for biofuel plants, the handling and tipping fees are likely much lower, in the \$30 per ton range.^{FFFFFFF}

The avoidance of tipping fees, however, is a complex issue since landfills are generally not owned by municipalities anymore. Both large and small municipalities recognized their inability to handle the new and complex solid waste regulations at a reasonable cost. Only 38 out of the 100 largest cities own their own landfills. To deal with the solid waste, large private companies built massive amounts of landfill capacity. The economic incentive is for private landfill operators to fill their landfills with garbage as early as possible to pay off their capital investment (landfill site) quickly. Also, the longer the landfill is operating the greater is its exposure to liability due to leakages and leaching. Furthermore, landfills can more cost-effectively manage the waste as the scale of the landfill is enlarged. As a result, there are fewer landfills and landfill owners, and an expansion of market share by large private waste management firms, thus decreasing the leverage an ethanol producer may have.^{GGGGGGGG} Hence, MSW-ethanol plants could be opposed by landfill operators. This may also be true in the case of a waste-to-energy (WTE) facility, which burns as much garbage as possible to produce electricity. For sustainable operation, a certain amount of daily waste supply should be guaranteed. A MSW-ethanol plant may therefore be seen as an unwelcome competition to both landfill owners and WTE facilities. This competition may increase the cost of cellulosic biomass to the biofuel producers. We request comment on the costs avoided for diverting cellulosic material from landfills and WTE facilities.

Once the cellulosic biomass has been sorted from the rest of MSW, it would have to be transported to the biofuels plant. Transporting is different for MSW biomass compared to forest and crop residues. Forest and crop residues are collected from a forests and farms, which are both rural sites, and transported to the biofuel plant which likely is located at a rural site. The trucks which transport the forest and crop residues can be large over-the-road trucks which can average moderate speeds because of the lower amount of traffic that they experience. Conversely, MSW is being collected from throughout the urban areas and would have to be transported through those urban areas to the plant site. If the cellulosic biomass is being collected at curbside, it would likely be collected in more conventional refuse trucks. If the plant is nearby, then the refuse trucks could transport the cellulosic biomass directly to the plant. However, if the plant is located far away from a portion of the urban area, then the refuse trucks would probably be offloaded to more conventional over-the-road trucks with sizable trailers to make transport more cost-effective. We believe that in most cases, MSW will be transported by class 8, over-the-road trucks with operating characteristics like those summarized in Table 4.1-15. The trucks would likely need to pick up the sorted MSW at a MSW sorting facility and haul the MSW to the cellulosic biofuel plant. The cellulosic biofuel plant would likely be located on the outskirts of the medium or large city, and so the MSW feedstock would have to be hauled through the urban area to reach the plant. Some of the trucks may not have to travel very far and would avoid most of the urban traffic since the MSW would be available on the same side of city

^{FFFFFFF} A much more thorough analysis of tipping fees by waste type is planned for the final rulemaking analysis.
^{GGGGGGGG} Osamu Sakamoto, The Financial Feasibility Analysis of Municipal Solid Waste to Ethanol Conversion, Michigan State University, Plan B Master Research Paper in partial fulfillment of the requirement for the degree of Master of Science, Department of Agricultural Economics, 2004

as the plant. However, another portion of the MSW may be located on the opposite side of city from the plant and the trucks may have to endure significant traffic from time-to-time. We estimate that the cost to transport the cellulosic biomass sourced from MSW to the biofuel plant would average \$15 per ton.

Cellulosic biomass sourced from MSW can be generated year-round in many parts of the U.S. If a steady enough stream of this material is available, then secondary storage would not be necessary, thus avoiding the need to install secondary storage. We assumed that no secondary storage costs would be incurred for MSW-sourced cellulosic biomass.

The total costs for MSW-sourced cellulosic biomass is estimated to be \$30 -\$40 per ton for sorting costs, \$30 per ton for tipping costs avoided, \$15 per ton for transportation costs and \$11 per ton for grinding the cellulose to prepare it as a feedstock - resulting in a total feedstock cost of \$26 to \$36 per ton. In our cost analysis, we assumed an average cost of \$31 per ton.

Table 4.1-21 below summarizes major cost components for each cellulosic feedstock..

**Table 4.1-21.
Summary of Cellulosic Feedstock Costs (\$53/bbl crude oil costs)**

Ag Residue	Switchgrass	Forest Residue	MSW
60% of Total Feedstock	1% of total Feedstock	25% of Total Feedstock	14% of Total Feedstock
Mowing, Raking, Baling, Hauling, Nutrients and Farmer Payment \$43/ton	Mowing, Raking, Baling, Hauling, Nutrients and Farmer Payment \$42/ton	Harvesting, Hauling to Forest Edge, Chipping \$45/ton	Sorting, Contaminant Removal, Tipping Fees Avoided \$0 – \$10/ton
Hauling to Secondary Storage, Secondary Storage, Hauling to Plant \$45/ton	Hauling to Secondary Storage, Secondary Storage, Hauling to Plant \$37/ton	Grinding, Hauling to Plant \$25/ton	Grinding, Hauling to Plant \$26/ton
Total \$88/ton	Total \$77/ton	Total \$70/ton	Total Avg \$31/ton

Weighting the cellulosic feedstock costs by their supply quantities results in an average cellulosic feedstock cost of \$71 per ton which we used at the reference crude oil price of \$53/bbl.

We also estimated the feedstock costs assuming that crude oil is priced at \$92/bbl. We adjusted the transportation costs higher by 10 percent based on our analysis of how ethanol

distribution costs would be affected by the higher crude oil price. We adjusted the farm gate costs upwards by about \$2 per ton based on FASOM agricultural market modeling at the higher crude oil price. We also increased grinding costs upwards by 10 percent. Table 4.1-22 summarized our estimated feedstock costs at \$93 per barrel crude oil prices.

**Table 4.1-22.
Summary of Cellulosic Feedstock Costs (\$92/bbl crude oil costs)**

Ag Residue	Switchgrass	Forest Residue	MSW
60% of Total Feedstock	1% of total Feedstock	25% of Total Feedstock	14% of Total Feedstock
Mowing, Raking, Baling, Hauling, Nutrients and Farmer Payment \$45/ton	Mowing, Raking, Baling, Hauling, Nutrients and Farmer Payment \$42/ton	Harvesting, Hauling to Forest Edge, Chipping \$47/ton	Sorting, Contaminant Removal, Tipping Fees Avoided \$3 – \$13/ton
Hauling to Secondary Storage, Secondary Storage, Hauling to Plant \$49/ton	Hauling to Secondary Storage, Secondary Storage, Hauling to Plant \$39/ton	Grinding, Hauling to Plant \$28/ton	Grinding, Hauling to Plant \$28/ton
Total \$94/ton	Total \$77/ton	Total \$75/ton	Total Avg \$36/ton

We estimate that at the crude oil price of \$92 per barrel, the average feedstock cost increases to \$76 per ton

Cellulosic Ethanol Production Costs

We contracted with the National Renewable Energy Laboratory (NREL) to estimate the cost to convert corn stover into ethanol for the years 2010, 2015, and 2022. It is of particular importance for the following discussion, to note the following: NREL used the same feedstock mass (772,168 dry tons of corn stover) in all three cases.

For the three cases, NREL assumed the feedstock, ‘as-needed,’ was hauled to the plant by trucks and trailers from satellite storage, already shredded to the appropriate size for processing, and free of dirt, iron, and other contaminants; in other words – process ready. The transport vehicles were unloaded into surge tanks, large enough to hold feedstock for three days of operation. The pretreatment and hydrolysis reactors are charged from these feed surge tanks.

The following is background information for our discussion of both operating and capital costs, some of which is also included in our brief discussion of the process flow description and capital equipment charges. The first step was to develop a set of process flow diagrams that set the arrangement of the equipment. Based on the desired production volume, these diagrams, were used within an ASPEN Plus4[®] model to develop complete mass and energy balance. The model consists of 164 unit operation blocks, 457 streams (247 material and 210 heat or work), 63 components, and 82 control blocks.

The overall model is thermodynamically rigorous and uses physical properties for the feedstock and process chemicals included in the ASPEN software as well as property data developed at NREL. The individual unit models are also thermodynamically consistent and can be either rigorous (for example, the simulation of the distillation) or simple. The reactors could be modeled with kinetic expressions, but because of the level of development of the experimental data, they were modeled as experimentally determined conversions of specific reactions. This type of model still satisfies the rigorous mass and energy balance. Other unit operations, such as liquid-solid separations, are typically modeled with fixed solids removal and liquid retention (in the solids stream) data from vendor tests.^{HHHHHHHHHH} Using the process flow diagrams and the mass and energy balance information, NREL estimated stream flows and conditions, along with the estimated quantities of raw materials and other process chemicals.

The following table presents NREL's summary of each of the three year's total project investment. For each year's total project investment, NREL provided capital charge, which includes income tax, depreciation, and average return on investment, the cost of raw materials, waste handling charges, and by-product credits.

^{HHHHHHHHHH} A. Aden, M. Ruth, K. Ibsen, J. Jechura, K. Neeves, J. Sheehan, and B. Wallace National Renewable Energy Laboratory (NREL); L. Montague, A. Slayton, and J. Lukas Harris Group, Seattle, Washington, Ethanol Process Design and Economics Utilizing Co-Current Dilute Acid Prehydrolysis and Enzymatic Hydrolysis for Corn Stover; June 2002; NREL is a U.S. Department of Energy Laboratory Operated by Midwest Research Institute • Battelle • Bechtel; Contract No. DE-AC36-99-GO10337

Table 4.1-23. Summary of NREL’s Capital Charges and Operating Costs

Year Technology	2010		2015		2022	
Plant Size MMgal/yr	56		69		71	
Capital Cost \$MM (TPI)	232		220		199	
	\$MM/yr	¢/gal	\$MM/yr	¢/gal	\$MM/yr	¢/gal
Capital Charge 10% after tax ROI	42	75	39	56	35	50
Fixed Costs	9	16	9	12	8	12
Feedstock Cost	84	46	51	35	50	35
Other Raw Matl. Costs	17	30	4	5	16	16
Enzyme Cost	18	32	7	10	5	8
Enzyme Nutrients	8	14	2	3	2	2
Electricity	-6	-10	-7	-9	-12	-16
Waste Disposal	1	2	3	4	1	1
Total Costs	173	205	108	116	105	108

The quantities of all raw material, generated electricity, and produced wastes were determined using the ASPEN mass and energy balance model. These costs include: *Feedstock* – corn stover, *CSL* – purchased corn steep liquor (a nutrient); *Cellulase* – purchased cellulase enzymes; *Other Raw Materials* – sulfuric acid, diammonium phosphate, make-up water, boiler feed water chemicals, cooling water chemicals. *Waste Disposal* – waste water chemicals, waste water polymers, ash disposal, gypsum disposal. *Electricity* – marketing and distribution of surplus electricity to the grid for credit.

We note that the percent change in total project investment from year to year is not insignificant and reflects improvements in mechanical process efficiencies among other general improvements in the process technology, including the automatic distributed process control system, all of which are off-set to some extent by increases in the real cost of the technology improvements, as well as those of constructions materials. We discuss capital costs following this discussion of operating costs.

The most notable reductions in NREL’s operating costs are in the price per dry ton of the corn stover feedstock and in the cost of cellulase enzyme. NREL anticipates significant improvement in the efficiency of these enzymes, especially those that saccharify glucan to

glucose and xylose oligomersⁱⁱⁱⁱⁱⁱⁱ generated during hydrolysis. They also expect improvement in the yeasts that ferment xylose. According to the 2007 NREL – State of Technology report, they anticipate that as a first step, the relationship between corn stover hydrolysate conditioning and fermentation will be better defined and understood. Commercial cellulase preparations will continue to be analyzed for baseline performance (specific activity), and due to increased research efforts, cellulase function will be better understood, which should lead to efficiency improvements. Integrated testing of whole slurry and recycle options will also be conducted resulting in potential improvements in that area. Last, the efficacy of advanced enzyme preparations (including oligomerases and/or hemicellulases) will continue to be tested in conjunction with alternative pretreatment technologies. NREL expects that the cost of pretreatment will diminish, hydrolysis time will decrease, and the sugar (xylose and glucose) yields will increase.^{jjjjjjj}

As the process costs decline over time, the feedstock costs become a larger fraction of the overall costs. We also note that in the following table that the cost of the feedstock makes up 50% of the total cost in 2010; 67% in 2015; and 68% in 2022. The reduction in feedstock cost, from \$60 per dry ton in 2010, to \$45.90 per dry ton in both 2015 and 2022 also has a significant effect on operating costs. In addition, NREL did not include payments to the farmers/growers nor for soil nutrients (fertilizer, etc.) that were removed with the harvested corn stover. The cost of the cellulase enzyme is the next highest contributor, with percent reductions contributed to total cost that reduced from ~19% in 2010, to 13% in 2015 and 10% in 2022. It should be obvious that any reductions in these costs have significant effects on the total operating cost. The majority of research going forward will be focused on these two items, although some work will be done to reduce the cost of the others. Table 4.1-24 summarizes NREL’s operating costs for a biochemical cellulosic ethanol plant.

ⁱⁱⁱⁱⁱⁱⁱ Xylan polymer chains, with considerably fewer residue numbers in the chain than were in the original xylan polymer; they were broken off the polymer as these short chains rather than as single molecule sugars.

^{jjjjjjj} Andy Aden, National Renewable Energy Laboratory, Golden, Colorado, [Biochemical Production of Ethanol from Corn Stover: 2007 State of Technology Model](#), Technical Report NREL/TP-510-43205, Task No. BB07.2410; May 2008

**Table 4.1-24.
Percent of the total operating cost for each actual operating cost item**

	2010		2015		2022	
	¢/gal	% of Total	¢/gal	% of Total	¢/gal	% of Total
Feedstock	84	50	51	67	50	68
Biomass to Boiler	0.0	0.0	0.0	0.0	0.0	0.0
CSL ^a	14	8	3	4	2	3
Cellulase	32	19	9	13	8	10
Other Raw Matl. Costs	31	18	5	7	16	22
Waste Disposal	2	1	4	5	2	2
Electricity	-10	-6	-9	-12	-16	-22
Fixed Costs	16	10	12	16	12	16
	168		76		72	

^aCorn steep liquor – provides nutrients for the enzymes.

The following table includes our adjustments to NREL’s variable or operating cost data for the three years studied. We note that the two main differences between NREL’s and our estimates are in the feedstock costs and in the way we calculate capital charges. We adjusted NREL’s capital charges which were calculated using a 10% after tax return on investment, to reflect a 7 percent before tax rate of return, which is the capital cost basis for our cost analyses. We also adjusted the NREL feedstock costs to those that we estimated in Table 4.1-21, which was \$71.23 per ton. This significant difference between their and our feedstock cost estimates is due to our including payments to farmers/growers plus covering the cost to replace nutrients (fertilizer, etc.) removed at the time the stover was harvested. According to a personal communication, NREL used unpublished data from the Idaho National Laboratory that indicate feedstock costs will be significantly reduced between 2010 and 2015.

Table 4.1-25. Adjusted Capital Charges and Operating Costs

Year Technology	2010		2015		2022	
Plant Size MMgal/yr	56		69		71	
Capital Cost \$MM	232		220		199	
	\$MM/yr	¢/gal	\$MM/yr	¢/gal	\$MM/yr	¢/gal
Capital Cost 7% ROI before taxes	25	46	24	35	22	31
Fixed Costs	9	16	9	12	8	12
Feedstock Cost	55	99	55	79	55	77
Other Raw Matl. Costs	17	30	4	5	16	16
Enzyme Cost	18	32	7	10	5	8
Enzyme Nutrients	8	14	2	3	2	2
Electricity	-6	-10	-7	-9	-12	-16
Waste Disposal	1	2	3	4	1	1
Total Costs	127	229	96	139	84	131

The changes in the minimum ethanol selling prices for the three years studied are partially due to the changes in necessary capital investments. In order to determine capital costs, NREL developed specifications pieces of equipment that fall within different areas of a biochemical plant. A biochemical plant is divided up into 8 different areas (Area 200 through Area 900). For each equipment specification, they developed individual purchased equipment and installation costs. Vendors supplied installation costs where possible; in other cases installation factors were used. Equipment costs were obtained from vendor quotations when possible, especially for uncommon equipment such as pretreatment reactors. These costs reflect the base case for which the equipment was designed. If process changes were made and the equipment size changed, the equipment is not generally re-costed, in detail. Rather, the cost was adjusted by scaling using the following exponential scaling expression, [New Cost = Original Cost x (New Size/Original Size)^{exp}]. They also scaled the size of equipment that was known to change linearly with a change in inlet flow. The scaling exponents (exp) were obtained from vendor quotes, or from a standard reference, such as Garrett.^{KKKKKKKKK}

KKKKKKKKK Garrett, D.E., Chemical Engineering Economics, Van Nostrand Reinhold, New York, 1989

Installation costs were taken primarily from Delta-T, a process consultant's experience. Once the scaled, installed equipment costs (total installed capital costs) were determined, they applied overhead and contingency factors to determine a total plant investment cost. That cost, along with the plant operating expenses (generally developed from the ASPEN model) was used in a discounted cash flow analysis to determine the cost of ethanol production, using a set discount rate. NREL use a discount rate of 10%, whereas we used 7%, a factor generally used in our financial calculations. For this analysis, the minimum ethanol selling price was the primary value used to compare cases.

The total project investment was briefly discussed previously in our summary discussion of operating costs; we used NREL's total project investment for our estimates. The following summarizes the capital expenditures that account for that capital investment.

Area 200: Pretreatment and Hydrolysis. The equipment in this area consists of an assortment of pipe, pumps, tanks, tank-agitators, tank-mixers, coolers, 3-pneumapress filters, as well as three separate process trains, each of which includes a presteamer, a blow tank, and a reactor. The presteamer uses low-pressure steam to heat the feedstock to about 212 °F. It discharges the hot, saturated mix into a blow tank that serves as a seal between the presteamer and the hydrolysis reactor. The mix is charged to the reactor and dilute sulfuric acid is added; the reactor operates at 191 psia and 547 °F. Most of the hemicellulose, e.g., primarily xylose, mannose, arabinose, and galactose are converted into sugars. Glucan in the hemicellulose and a small portion of the glucan in the cellulose are converted to glucose. These conditions also solubilize some of the lignin in the feedstock and 'expose' the cellulose for subsequent enzymatic hydrolysis, in a downstream section. In addition, acetic acid is liberated from the hemicellulose hydrolysis. Degradation products of pentose sugars (primarily furfural) and hexose sugars (primarily hydroxymethyl furfural (HMF)) are also formed.

Following the pretreatment reactor, the hydrolyzate liquid and solids are flash cooled, which vaporizes a large amount of water, a portion of the acetic acid, and much of the furfural and HMF, which can be toxic to downstream fermentation microorganisms.

In addition to the flash removal of aldehydes, the solids are washed and filter-pressed to remove the liquid portion of the hydrolyzate, which contains sulfuric acid. The liquid is then neutralized to pH 10 with ammonia and held until the gypsum precipitates and is filtered out. The hydrolyzate, which contains the hydrolyzed xylose sugars and some glucose sugars, is mixed back with dilution water and the filter cake, which contains the unhydrolyzed cellulose and is sent to saccharification and co-fermentation (Area 300)

An important issue on an industrial scale is accurate pH control. By pH 11, as much as 30% of the glucose may be lost to HMF and other side reactions. Several factors increase the probability of overshooting pH endpoints during neutralization. The natural buffering capacity of hydrolyzates causes neutralization reactions to be slow. Plus, measurements using pH membrane probes are affected by temperature and the presence of dissolved organic compounds (sugars and lignin).

Since we are handling the same mass of feedstock in each of the modeled years, we don't expect the cost of the equipment for pretreatment and hydrolysis will change much over the 2010-2022 time period. The equipment costs for Area 200 – Pretreatment & Hydrolysis are 2010: \$23-million; 2015: \$22.7-million; and 2022: \$18.9-million. Neutralization and Conditioning costs were separated out from the Pretreatment & Hydrolysis costs, even though the NREL's design report includes both cost centers in Area 200. Neutralization and Conditioning costs are as follows: 2010: \$8.4-million; 2015: \$9.4-million; and 2022: \$7.7-million. The combined cost for Area 200 is as follows: 2010: \$31.4-million; 2015: \$32.1-million; and 2022: \$26.6-million. In total, this area contributed about 23.5% to the total installed capital cost of the project in 2010; about 25.3% in 2015; and 23.2% in 2022.

Area 300: Saccharification and Co-Fermentation. The equipment in this area consists of pumps, tanks, tank-agitators, coolers, and heaters. Two different operations take place in this process area — the saccharification of the cellulose to glucose using cellulase enzymes, and the fermentation to ethanol of that glucose plus the xylose and glucose sugars from the dilute acid pretreatment of hemicellulose from Area 200.

Glucan from the cellulose undergoes hydrolysis or saccharification, at about 149 °F, prior to fermentation. This slightly higher temperature increases enzyme activity and reduces the time and amount of enzyme required for saccharification. Saccharification or cellulase enzymes, purchased from an enzyme manufacturer, and the diluted, detoxified hydrolyzate are continuously added to a train of five 1-million gallon saccharification vessels; residence time is estimated to be 36-hours.

Cellulase enzyme is actually a 'cocktail' of enzymes, comprised of: (1) endoglucanases, which attack randomly along the cellulose fiber to reduce polymer size rapidly; (2) exoglucanases, which attack the ends of cellulose fibers, allowing it to hydrolyze highly crystalline cellulose; and (3) β -glucosidase, which hydrolyzes cellobiose to glucose. Several bacteria and fungi naturally produce these enzymes, including bacteria in ruminant and termite guts and white rot fungus. The most common organism used to produce cellulase industrially is *Trichoderma reesei*. Genencor International and Novozymes Biotech are developing more cost effective cellulase enzymes. DOE is funding this important work, which should improve the economic viability of biomass conversion.

The recombinant *Z. mobilis bacterium* is used as the biocatalyst to ferment glucoses and xyloses to ethanol. Several research institutions are genetically engineering strains, such as *Z. mobilis*, to treat additional sugars and identifying other naturally occurring organisms that metabolize hemicellulosic sugars.

The *Z. mobilis* must be 'grown' in increasingly higher volume stages. Initially, a small amount of saccharified slurry and nutrients are combined in a very small vessel with a seed inoculum, that's been grown in the laboratory. This initial seed batch is used as the inoculum for the next larger size seed batch, and so on. This series of batch scale-ups continues until the last batch is large enough to support the actual production fermentation.

Finally, the seed inoculum, nutrients (corn steep liquor) & (diammonium phosphate – a source of nitrogen for the yeast), and saccharified slurry are cooled to about 106 °F and added to a train of five 1-million gallon continuous fermentors. At this point, the process actually becomes a simultaneous saccharification and co-fermentation (SSCF) process. Even though the temperature in the fermentation tanks has been reduced to account for the ethanologen's intolerance to heat, the enzymes do continue to hydrolyze cellulose, albeit at a slightly reduced rate. The main byproduct, produced during fermentation is carbon dioxide (CO₂), which is removed in a later process stage. The ethanol broth called 'beer' is collected in a storage tank, called a beer well, before it's pumped to distillation.

NREL anticipates significant capital savings for saccharification and co-fermentation between 2010 and 2015, with fewer between 2015 and 2022. We note that this area contributed 15.4% to the total installed capital cost in 2010, but only 8.8% in 2015 and 8.8% in 2022. The equipment costs for Area 300 – Saccharification and Fermentation are 2010: \$20.5-million; 2015: \$11.2-million; and 2022: \$10.1-million.

Area 400 – In earlier studies, NREL included plans to produce enzymes in Area 400. For the current studies, Area 400 has been removed and enzymes will be purchased and grown on site under licensing agreements with enzyme suppliers.

Area 500 – Product, Solids, and Water Recovery (Distillation, Dehydration, Evaporation, and Solid-Liquid Separation). The equipment in this area includes distillation and rectification columns, pumps, condensers and coolers, pumps, pipe, filter-presses, and evaporators.

Beer, from the beer well in Area 300, is preheated and fed to a distillation column. The column overhead containing all the CO₂ and about 0.2% of the ethanol and a small quantity of water is sent to a scrubber, which recovers and recycles about 99% of the vented ethanol. In the tower bottoms, about 90% of the water has been removed and it contains approximately 0.7% of the total volume of ethanol fed to the tower. Over 99% of the total ethanol fed to the tower is removed as a 39.4% w/w mixture with water vapor through a side draw and fed directly to a rectification column for further ethanol enrichment. We discuss the distillation column bottoms in the evaporation and solid-liquid separation section of this area.

The rectification tower operating conditions are set to produce an overhead 92.5% w/w ethanol/water saturated vapor mixture. The tower bottoms are a 0.05% w/w ethanol/water mixture. In fact, only 0.1% of the total ethanol from the fermentation area is lost to the bottoms.

The rectification column overhead is superheated and fed to one of two adsorption columns in a molecular sieve adsorption unit. The two columns operate alternately; while one bed is operated to remove water from the ethanol, the other is regenerated by passing a very small slipstream of pure ethanol vapor back through the loaded bed that strips the water off the adsorbent, while the column is under a vacuum. The mixture is condensed and returned to the rectification column feed stream. The adsorption column removes 95% of the water and a small quantity of ethanol. The 99.5% pure ethanol vapor is condensed, cooled, and pumped to storage.

Evaporation, and Solid-Liquid Separation: The beer column bottoms, with about 5.8% insoluble solids, are fed to the first effect evaporator, where 24% of the water in the feed is evaporated. The evaporator bottom slurry, cooled from ~243 °F to ~189 °F, is sent to a filter-press, from which the filtrate is returned to the second evaporator effect; the filter cake is not washed. In the second effect evaporator, 44% of the feed water is evaporated. The third effect evaporates 76% of the remaining water. The final vapor is condensed and fed to a condensate drum. Of the total feed to the evaporation/separation system, 10.5% remains as syrup, 11.5% is removed as a wet cake in the pressure filter, 17% is recycled back to the process as recycle water, and 61% is evaporated. The syrup from the third evaporator bottoms is 60% water, e.g., the maximum dissolved solids level that can be achieved without rapid fouling of the evaporator; the flow of very low-pressure steam to the evaporator is set to achieve this level. This syrup is mixed with the cake from the filter-press and sent to the combustor for disposal. Air from the filter-press is used for combustion air.

The equipment costs for Area 500 – Product, Solids, and Water Recovery (Distillation, Dehydration, Evaporation, and Solid-Liquid Separation) are for 2010: \$23.4-million; 2015: \$26.1-million; and 2022: \$23.3-million. This area’s contribution to the total installed capital cost in 2010 is 17.5%; in 2015, 20.6%; and in 2022, 20.3%. We believe that some of the increase from 2010 to 2015 has to do with the increased liquid flow due to the conversion improvements; larger pipe, pumps, tanks, etc may be necessary to handle the increased flow. The changes from 2015 to 2022 are not that significant, as reflected by the percent contribution of the area to total installed equipment cost.

Area 600 – Wastewater Treatment: The equipment in Area 600 consists mainly of aerobic and anaerobic digesters, digester agitators, tanks (basins), a biogas emergency flare, coolers, and pumps. The main purpose of the wastewater treatment section is to reduce the plant makeup water requirement by recovering, treating and recycling as much process water as possible. The feed to the wastewater treatment section consists of: condensed pretreatment flash vapor, condensate from the hydrolyzate filter-press vent, boiler blowdown, cooling tower blowdown, clean-in-place waste, and the non-recycled evaporator condensate. Rain and snow run-off, equipment washing, and other non-process wastewater are assumed to flow to the municipal wastewater treatment system. The stream is screened to remove large waste particles that are sent to a landfill; any remaining organic matter is anaerobically and aerobically digested. Anaerobic digestion produces a methane rich (75%-methane, 25%-carbon dioxide) biogas that’s fed to the combustor. Aerobic digestion produces relatively clean water that’s recycled back to the process and sludge that’s burned in the combustor.

NREL didn’t expect much change over the 2010 to 2022 time period. In 2010 the installed capital cost for this area was \$3.4-million; in 2015, \$3.7-million; and in 2022 it was 3.1-million. As important as this area is to the entire operation its contribution to the total project installed capital cost is relatively minor. In 2010 the contribution was 2.5%; in 2015, 2.9%; and in 2022 it was 2.7%.

Area 700: Bulk Storage of Chemicals. This section of the plant stores chemicals in bulk for the process and for finished, fuel-grade ethanol. The feedstock feed surge tanks we discussed just prior to the discussion of Area 200 are not included in this area. Process chemicals stored in

this area include: corn steep liquor (a nutrient), sulfuric acid, cellulase enzyme, gasoline (used as a denaturant finish the fuel grade ethanol), and water for fire suppression.

There is approximately five-days of SS316-stainless steel^{LLLLLLLLL} tank sulfuric acid storage. Corn steep liquor (CSL), a nutrient for fermentation seed growth and ethanol production, also has about five-days of SS304-stainless steel^{MMMMMMMMM} storage; NREL expects the plant will require about three-25,000 gallon rail cars of CSL every three-days. There are seven-days of storage for diammonium phosphate (DAP), delivered as pellets via rail car. Appropriate quantities of CSL and DAP are mixed in a day-tank and used in Area 300 for fermentation seed production and ethanol production. A producer that supplies cellulase enzymes is expected to set up an enzyme production operation either on site or on a nearby location. Liquid enzyme storage is set for four-days in SS304 stainless steel tanks. The carbon steel fire-fighting water storage tanks provide about four-hours of operating time; the firewater pump delivers 2,500 gpm. Other pumps are sized per process requirements

There is seven-days of ethanol product storage in two 600,000 gallon carbon steel tanks. Five percent gasoline (v/v), a denaturant, is added to the ethanol as it's loaded for shipment to customers. The pumps in this section are generally sized to load a 10,000 gallon truck and trailer in about 15 min. to 20 min. maximum filling time. They can also be used to fill process day tanks.

The installed capital costs for bulk storage are, for 2010, \$3.8-million; for 2015, \$2.4-million; and for 2022, \$2.4-million. The contribution to total project installed capital costs are, for 2010, 2.8%; for 2015, 1.9%; and for 2022, 2.1%.

Area 800: Combustor, Boiler, and Turbogenerator. The purpose of the combustor, boiler, and turbogenerator is to burn various by-product or waste streams to produce steam and to generate electricity. All of the feedstock lignin and some of the cellulose and hemicellulose are not hydrolyzed in Area 300.

As previously discussed, a high soluble, solids syrup is generated in Area 600 and anaerobic and aerobic digestion of the remaining wastewater produced biogas and a small quantity of biomass sludge which are burned to generate steam and produce electricity. This contributes to over-all plant energy self-sufficiency, reduces solid waste disposal costs, and generates additional revenue through sales of excess electricity. Because of heightened interest in using biomass, pulping wastes, and sewage sludge in place of fossil fuels, new methods are being developed to handle higher moisture feeds. Traditional methods include blending the wet feed with dry material or adding auxiliary fuel to maintain the combustion temperature. When the dry solids from the filter-press cake are combined with the high soluble, solids syrup, it helps

^{LLLLLLLLL} SS316 is an improved version of SS304, with the addition of molybdenum and a slightly higher nickel content. The resultant composition of 316 gives it much increased corrosion resistance in many aggressive environments. The molybdenum makes the steel more resistant to pitting and crevice corrosion in chloride-contaminated media, sea water and acid vapors.

^{MMMMMMMMM} SS304-stainless steel is the most versatile and the most widely used of all stainless steels. Its chemical composition, mechanical properties, weldability and corrosion/oxidation resistance provide the best all-round performance stainless steel at relatively low cost.

ensure a stable combustion bed temperature and improved boiler efficiency. In these studies NREL used a circulating fluidized bed combustor that is suitable for varying feeds and feed characteristics; however, this flexibility makes the unit more expensive than a grate or pile combustor. A Lower Heating Value (LHV) of 2,000-2,500 BTU/lb is considered the minimum for maintaining combustion.^{NNNNNNNNN} The combined feed to the combustor has a LHV of 4,179 Btu/lb. Thus, the total higher-heating value energy of the combined feed streams to the combustor is 706 MMBtu/hr. The solids contribute 59% of this energy and the syrup contributes 37%. A baghouse removes particulates from the combustion flue gas after it preheats the incoming combustion air and before it's discharged through the stack.

The boiler feed water (BFW) system includes a softener for makeup and condensate water, a deaerator to remove air and other non-condensables, surge tanks and pumps. The amount of water pretreatment necessary depends on the incoming water quality, metallurgy of the boiler, and the ratio of makeup to condensate in the feed water. Pretreatment chemicals for pH control, scale removal, and oxygen removal are added. Treated well water used for makeup and condensate are softened, deaerated, preheated and mixed to provide BFW that's converted to steam that's superheated to 950 °F at 1,265 psia at the rate of 407,420 lb/hr. Support equipment includes BFW pumps, deaerator, automatic water pretreatment chemical injection, and condensate gathered from the various heat exchangers in the process. Boiler efficiency, the percentage of the feed heat converted to steam heat, is estimated to be 68%. Boiler blowdown is 3% of steam production. The turbine efficiency was estimated to be 85%.

The turbogenerator consisting of a multistage turbine with extraction ports, a generator, and condenser is used to generate electricity. After high pressure steam drives the multistage turbines, it is extracted at three different conditions for injection into the pretreatment reactor and heat exchange in distillation and evaporation. Twenty-eight percent of the steam is extracted from the turbine at 191 psia and 514°F, 60% at 65 psia and 327°F, and 3% at 25 psia and 239°F for process needs, as described. The remaining steam (9%) is condensed at 1.5 psia with cooling water and returned to the BFW system. For this design, a total of 30.4 megawatts (MW) of power is generated from the system. The process uses 11.7 MW, leaving 18.7 MW that is sold to the grid.

The installed capital cost for Area 800 are, for 2010, \$45.5-million; for 2015, \$46-million; and for 2022, \$43.3-million. This area's contribution to the total installed capital cost is, for 2010, 34.1%; for 2015, 36.2%; and for 2022, 37.7%.

Area 900: Utilities. All utilities, except steam and electricity, necessary for the production of ethanol are accounted for in this area. The utilities provided include cooling water, chilled water, plant and instrument air, process water, and the clean-in-place (CIP) system. No chilled water is used in the plant; the required process temperatures can be achieved by cooling water year-round.

^{NNNNNNNNN} Steam and Electricity Generation Options For the Biomass-To-Ethanol Process, NREL Subcontract ACO-8-18019-01, Reaction Engineering International, Salt Lake City, UT, March 16, 1998.
http://www.ott.doe.gov/biofuels/process_engineering.html

The plant and instrument air systems provide compressed air for air-driven equipment, instrument operation, for clean up, and the filter-press units in the post-distillation dewatering. The process water system mixes fresh well water with treated wastewater and provides water at a constant pressure to the facility. Water is provided to seed production, boiler feed water, cooling tower make-up, the CIP system, and the scrubber. It is also mixed with recycle water for dilution before saccharification. Process water is also used throughout the facility for cleaning on an as-needed basis. The CIP system provides a solution that can be heated and includes cleaning and sterilization chemicals to saccharification and co-fermentation, seed vessels, and the distillation system.

The installed capital costs for the utilities area are, for 2010, \$5.6-million; for 2015, \$5.5-million; and for 2022, \$6.1-million. This area's contribution to the total project installed equipment costs are, for 2010, 4.2%; for 2015, 4.3%; and for 2022, 5.3%.

Table 4.1-26 summarizes the total projected capital costs for a biochemical cellulosic ethanol plant for the years 2010, 2015 and 2022.

**Table 4.1-26. Projected Capital Costs for a Biochemical Cellulosic Ethanol Plant
(\$million/yr)**

	2010	2015	2022
Total Capital Investment	133.5	127	114.8
Added Costs*	98.2	93.1	83.8
Total Project Investment	231.7	220.1	198.6

*Added costs include the following:

Warehouse: This is estimated to be 1.5% of total installed cost

Site Development: This includes fencing, curbing, parking, lot, roads, well drainage, rail system, soil borings, and general paving. This factor allows for minimum site development assuming a clear site, with no unusual problems such as right-of-way, difficult land clearing, or unusual environmental problems, usually calculated as 9% of the installed cost of process equipment.

Prorateable Costs: This includes fringe benefits, burdens, and insurance of the construction contractor, usually calculated as 10% of total installed cost.

Field Expenses: This includes consumables, small tool equip. rental, field services, temporary construction facilities, and field construction supervision, usually calculated as 10% of total installed cost.

Home Office and Const.: This includes engineering plus incidentals, purchasing, and construction, usually calculated as 25% of total installed cost.

Project Contingency: These costs are small because of the detail included in the process design usually calculated as 3% of total installed cost.

Other Costs: This includes start-up and commissioning costs; land, rights-of-way, permits, surveys, and fees; piling, soil compaction/dewatering, unusual foundations; sales, use, and other taxes; freight, insurance in transit and import duties on equipment, piping, steel, instrumentation, etc.; overtime pay during construction; field insurance; project team; transportation equipment, bulk shipping containers, plant vehicles, etc.; escalation or inflation of costs over time; interest on construction loan. These other costs are usually calculated as 10% of total capital investment.

4.1.1.3 Imported Sugarcane Ethanol Costs

Our analysis of imported ethanol costs began with a literature search of recent estimates for production costs for sugar cane ethanol in Brazil. Since the liberalization of ethanol prices in Brazil, few cost estimation studies have been made and most of the cost analyses refer to the same study.⁹⁰⁹ This study was carried out by the Brazilian Ministry of Science and Technology (MC&T), based on 1990 data, and referred to a production cost of \$0.87/gallon. Table 4.1-27 gives a breakdown of costs based on this data.

Table 4.1-27. Sugarcane Ethanol Production Costs in Brazil, circa 1990

	Average cost (US\$ per gallon)
Operating costs	\$0.64
Labor	\$0.02
Maintenance	\$0.02
Chemicals	\$0.01
Energy	\$0.01
Other	\$0.02
Interest payments on working capital	\$0.08
Feedstock (cane)	\$0.48
Fixed costs	\$0.23
Capital at 12% depreciation rate	\$0.19
Other	\$0.04
Total	\$0.87

Since then, there have been significant variations in exchange rates, costs of sugarcane and oil products, etc. For example, earlier estimates may underestimate crude and natural gas costs which influence the cost of feedstock as well as energy costs at the plant. Another possible difference in production cost estimates is whether or not the estimates are referring to hydrous or anhydrous ethanol. Costs for anhydrous ethanol (for blending with gasoline) are typically several cents per gallon higher than hydrous ethanol (for use in dedicated ethanol vehicles in Brazil).⁹¹⁰ It is not entirely clear from the majority of studies whether reported costs are for hydrous or anhydrous ethanol. Yet another difference could be the slate of products the plant is producing, for example, future plants may be dedicated ethanol facilities while others involve the production of both sugar and ethanol in the same facility. Due to economies of scale, production costs are also typically smaller per gallon for larger facilities. Table 4.1-28 summarizes the various estimates reported by others. Production costs range from as low as \$0.57 per gallon of ethanol to as high as \$1.48 per gallon of ethanol.

Table 4.1-28. Other Sugarcane Ethanol Production Cost Estimates

Reference	Cost (US\$ per gallon)
AgraFNP. 2007. Sugar and Ethanol in Brazil: A Study of the Brazilian Sugar Cane, Sugar and Ethanol Industries.	\$0.80-\$1.07 per gallon (in 2006 \$'s depending on region in Brazil), avg. is \$0.78 per gallon for cane production cost and \$0.13 per gallon for industrial costs
IEA. 2004. Biofuels for Transport: An International Perspective.	\$0.87 per gallon (in 1990 \$'s) references MC&T study; also reports recent production cost estimates for hydrous ethanol as low as \$0.57 per gallon (at the prevailing exchange rate in Jan. 2004)
USDA. 2006. The Economic Feasibility of Ethanol Production from Sugar in the United States.	Avg. is \$0.81 per gallon
Von Lampe, Martin. OECD. 2006. Working Party on Agricultural Policies and Markets: Agricultural Market Impacts of Future Growth in the Production of Biofuels.	\$0.83 per gallon
Brazil Institute. April 2007. The Global Dynamics of Biofuels: Potential Supply and Demand for Ethanol. Issue No. 3.	\$0.83 per gallon.
ESMAP. October 2005. Potential for Biofuels for Transport in Developing Countries.	\$.87-\$1.10 per gallon
OECD, March 2008. ITF Round Tables No. 138. Biofuels: Linking Support to Performance.	Avg. is \$1.40 per gallon
Bain, R. December 2007. World Biofuels Assessment Worldwide Biomass Potential: Technology Characterizations. NREL/MP-510-42467.	\$1.04-\$1.48 per gallon depending on size of plant, i.e. 100 MGY-4.6 MGY; Sugarcane feedstock costs \$0.68 per gallon, Variable operating costs \$0.27 per gallon, Fixed costs \$0.02-0.13 per gallon, and Capital costs \$0.07-0.40 per gallon
Macedo, I.C. and L.A.H. Nogueira. 2005. "Biocombusíveis". Cadernos NAE, No. 2. Núcleo de Assuntos Estratégicos da Presidência da República, Brasília; As sited in OECD, <i>op. sit.</i>	\$0.79 per gallon in the Center-South Brazil
Kojima, M. and T. Johnson. 2006. "Potential for Biofuels for Transport in Developing Countries". ESMAP Knowledge Exchange Series, No. 4.; As sited in OECD, <i>op. sit.</i>	\$0.87-\$1.09 per gallon
Smeets, E. 2008. The Sustainability of Brazilian Ethanol-An Assessment of the Possibilities of Certified Production. Biomass and Bioenergy	\$1.18 assuming exchange rate of \$1.20= 1 Euro

The study by OECD (2008) entitled “Biofuels: Linking Support to Performance”, appears to provide the most recent and detailed set of assumptions and production costs. As such, our estimate of sugarcane production costs primarily relies on the assumptions made for the study, which are shown in Table 4.1-29. The estimate assumes an ethanol-dedicated mill and is based off an internal rate of return of 12%, a debt/equity ratio of 50% with an 8% interest rate and a selling of surplus power at \$57 per MWh.

Table 4.1-29. Cost of Production in a Standard Ethanol Project in Brazil

Sugarcane Productivity	71.5 t/ha
Sugarcane Consumption	2 million tons/year
Harvesting days	167
Ethanol productivity	85 liters/ton (22.5 gal/ton)
Ethanol Production	170 million liters/year (45 MGY)
Surplus power produced	40 kWh/ton sugarcane
Investment cost in mill	USD 97 million
Investment cost for sugarcane production	USD 36 million
O & M (Operating & Maintenance) costs	\$0.26/gal
Sugarcane costs	\$0.64/gal
Capital costs	\$0.49/gal
Total production costs	\$1.40/gal

The estimate above is based on the costs of producing ethanol in Brazil on average, today. However, we are interested in how the costs of producing ethanol will change by the year 2022. Although various cost estimates exist, analysis of the cost trends over time shows that the cost of producing ethanol in Brazil has been steadily declining due to efficiency improvements in cane production and ethanol conversion processes. Between 1980 and 1998 (total span of 19 years) ethanol cost declined by approximately 30.8%.⁹¹¹ This change in the cost of production over time in Brazil is known as the ethanol cost “Learning Curve”. See Figure 4.1-2.

Figure 4.1-2. Ethanol Cost “Learning Curve”

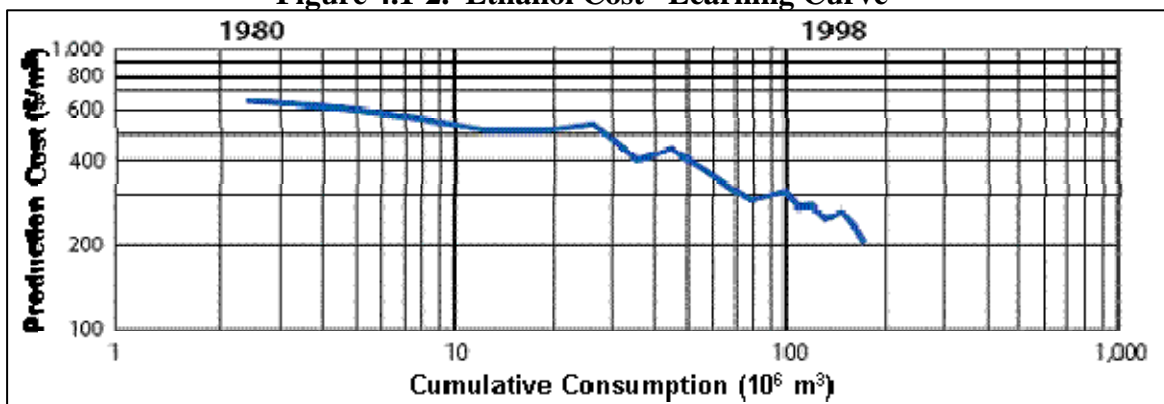

The change in ethanol costs will depend on the likely productivity gains and technological innovations that can be made in the future. As the majority of learning has already occurred, it is likely that the decline in ethanol costs will be less drastic as the production process

and cane practices have matured. In fact, there are few perspectives for substantial efficiency gains with the sugarcane processing technology. Industrial efficiency gains are already at about 85% and are expected to increase to 90% in 2015.⁹¹² Most of the productivity growth is expected to come from sugarcane production, where yields are expected to grow from the current 70 tons/ha, to 96 tons/ha in 2025.⁹¹³ Sugarcane quality is also expected to improve, with sucrose content growing from 14.5% to 17.3% in 2025.⁹¹⁴ All productivity gains together could allow the increase in the production of ethanol from 6,000 liters/ha (at 85 liters/ton sugarcane) to 10,400 liters/ha (at 109 liters/ton sugarcane) in 2025.⁹¹⁵

Assuming that ethanol productivity increases to 100 liters/ton by 2015 and 109 liters/ton by 2025, sugarcane costs are expected to decrease to approximately \$0.51/gal from \$0.64/gal since less feedstock is needed to produce the same volume of ethanol using the estimates from Table 4.1-29, above. Table 4.1-30 shows the calculated decrease for the years 2005-2025. We assumed a linear decrease between data points for 2005, 2015, and 2025. Adding operating (\$0.26/gal) and capital costs (\$0.49/gal) from Table 4.1-29, to a sugarcane cost of \$0.51/gal, total production costs are \$1.26/gal in 2022.

Table 4.1-30.
Estimated Decrease in Sugarcane Production Cost by 2022
Due to Increases in Ethanol Productivity

	Sugarcane Production Cost		
	\$/gal	liters/ton	gal/ton
2005	0.64	85	22.46
2006	0.63	86.5	22.85
2007	0.62	88	23.25
2008	0.61	89.5	23.65
2009	0.60	91	24.04
2010	0.59	92.5	24.44
2011	0.58	94	24.83
2012	0.57	95.5	25.23
2013	0.56	97	25.63
2014	0.55	98.5	26.02
2015	0.54	100	26.42
2016	0.54	100.9	26.66
2017	0.53	101.8	26.90
2018	0.53	102.7	27.13
2019	0.53	103.6	27.37
2020	0.52	104.5	27.61
2021	0.52	105.4	27.85
2022	0.51	106.3	28.08
2023	0.51	107.2	28.32
2024	0.50	108.1	28.56
2025	0.50	109	28.80

Brazil sugarcane producers are also expected to move from burned cane manual harvesting to mechanical harvesting. See Figure 4.1-3.⁹¹⁶ As a result, large amounts of straw are

expected to be available. Costs of mechanical harvesting are lower compared to manually harvesting, therefore, we would expect costs for sugarcane to decline as greater sugarcane producers move to mechanical harvesting. However, it is important to note that diesel use increases with mechanical harvesting, and with diesel fuel prices expected to increase in the future, costs may be higher than expected. Therefore, we have not assumed any changes to harvesting costs due to the switchover from manual harvesting to mechanical harvesting.

Figure 4.1-3. Phase-out Schedule for Trash Burning Practices

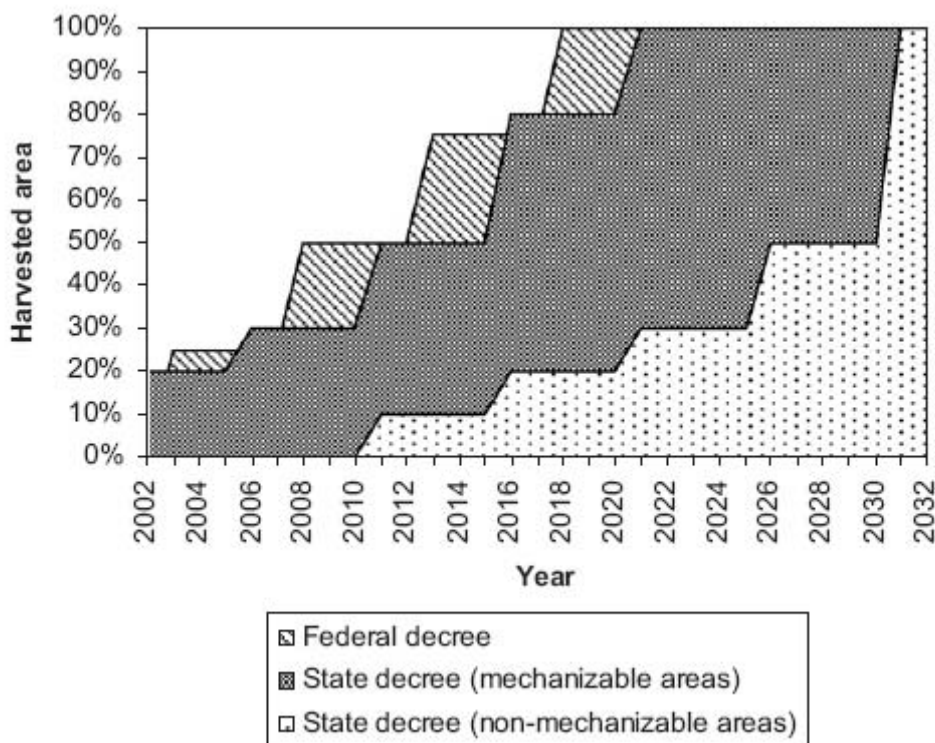

As more straw is expected to be collected at future sugarcane ethanol facilities, there is greater potential for production of excess electricity. The production cost estimates in the OECD study assumes an excess of 40kWh per ton sugarcane, however, future sugarcane plants are expected to produce 135 kWh per ton sugarcane.⁹¹⁷ Assuming excess electricity is sold for \$57 per MWh, the production of an additional 95 kWh per ton would be equivalent to a credit of \$0.22 per gallon ethanol produced. We did not include this potential additional credit from greater use of bagasse and straw in our estimates at this time. Our cost estimates do include, however, the excess electricity produced from bagasse that is currently used today (40 kWh/ton).

It is also important to note that ethanol production costs can increase if the costs of compliance with various sustainability criteria are taken into account. For instance, using organic or green cane production, adopting higher wages, etc. could increase production costs for sugarcane ethanol.⁹¹⁸ Such sustainability criteria could also be applicable to other feedstocks, for example, those used in corn- or soy-based biofuel production. If these measures are adopted in the future, production costs will be higher than we have projected.

In addition to production costs, there are also logistical and port costs. We used the report from AgraFNP to estimate such costs since it was the only resource that included both logistical and port costs. The total average logistical and port cost for sugarcane ethanol is \$0.19/gal and \$0.09/gal, respectively, as shown in Table 4.1-31.

**Table 4.1-31.
Imported Ethanol Cost at Port in Brazil (2006 \$'s)**

<u>Region</u>	<u>Logistical Costs US (\$/gal)</u>	<u>Port Cost US (\$/gal)</u>
NE Sao Paulo	0.146	0.094
W Sao Paulo	0.204	0.094
SE Sao Paulo	0.100	0.094
S Sao Paulo	0.170	0.094
N Parana	0.232	0.094
S Goias	0.328	0.094
E Mato Grosso do sul	0.322	0.094
Triangulo mineiro	0.201	0.094
NE Cost	0.026	0.058
Sao Francisco Valley	0.188	0.058
Average	0.192	0.087

Total fuel costs must also include the cost to ship ethanol from Brazil to the U.S. In 2006, this cost was estimated to be approximately \$0.15 per gallon of ethanol.⁹¹⁹ Costs were estimated as the difference between the unit value cost of insurance and freight (CIF) and the unit value customs price. The average cost to ship ethanol from Caribbean countries (e.g. El Salvador, Jamaica, etc.) to the U.S. in 2006 was approximately \$0.12 per gallon of ethanol. Although this may seem to be an advantage for Caribbean countries, it should be noted that there would be some additional cost for shipping ethanol from Brazil to the Caribbean country. Therefore, we assume all costs for shipping ethanol to be \$0.15 per gallon regardless of the country importing ethanol to the U.S.

The total imported ethanol fuel costs (at U.S. ports) over the time period of 2010 to 2022 are shown in Table 4.1-32. In 2022, the total sugarcane ethanol cost estimate prior to tariffs and taxes is \$1.69/gallon. Direct Brazilian imports are also subject to an additional \$0.54 per gallon tariff, whereas those imports arriving in the U.S. from Caribbean Basin Initiative (CBI) countries are exempt from the tariff. In addition, all imports are given an ad valorem tax of 2.5% for undenatured ethanol and a 1.9% tax for denatured ethanol. We assumed an ad valorem tax of 2.5% for all ethanol. Thus, including tariffs and ad valorem taxes, the average cost of imported ethanol is shown in Table 4.1-33 in the “Brazil Direct w/ Tax & Tariff” and “CBI w/ Tax” columns for the years 2010-2022.

Table 4.1-32. Average Imported Ethanol Costs Prior to Tariff and Taxes

	Sugarcane Production Cost (\$/gal)	Operating Cost (\$/gal)	Capital Cost (\$/gal)	Logistical Cost (\$/gal)	Port Cost (\$/gal)	Transport Cost from Port to US (\$/gal)	Total Cost (\$/gal)
2010	0.59	0.26	0.49	0.19	0.09	0.15	1.77
2011	0.58	0.26	0.49	0.19	0.09	0.15	1.76
2012	0.57	0.26	0.49	0.19	0.09	0.15	1.75
2013	0.56	0.26	0.49	0.19	0.09	0.15	1.74
2014	0.55	0.26	0.49	0.19	0.09	0.15	1.73
2015	0.54	0.26	0.49	0.19	0.09	0.15	1.72
2016	0.54	0.26	0.49	0.19	0.09	0.15	1.72
2017	0.53	0.26	0.49	0.19	0.09	0.15	1.71
2018	0.53	0.26	0.49	0.19	0.09	0.15	1.71
2019	0.53	0.26	0.49	0.19	0.09	0.15	1.71
2020	0.52	0.26	0.49	0.19	0.09	0.15	1.70
2021	0.52	0.26	0.49	0.19	0.09	0.15	1.70
2022	0.51	0.26	0.49	0.19	0.09	0.15	1.69
2023	0.51	0.26	0.49	0.19	0.09	0.15	1.69
2024	0.50	0.26	0.49	0.19	0.09	0.15	1.68
2025	0.50	0.26	0.49	0.19	0.09	0.15	1.68

Table 4.1-33. Average Imported Ethanol Costs

	Brazil Direct (\$/gal)	Brazil Direct w/ Tax & Tariff (\$/gal)	CBI (\$/gal)	CBI w/ Tax (\$/gal)
2010	1.77	2.35	1.77	1.81
2011	1.76	2.34	1.76	1.80
2012	1.75	2.33	1.75	1.79
2013	1.74	2.32	1.74	1.78
2014	1.73	2.32	1.73	1.78
2015	1.72	2.31	1.72	1.77
2016	1.72	2.30	1.72	1.76
2017	1.71	2.30	1.71	1.76
2018	1.71	2.29	1.71	1.75
2019	1.71	2.29	1.71	1.75
2020	1.70	2.28	1.70	1.74
2021	1.70	2.28	1.70	1.74
2022	1.69	2.27	1.69	1.73
2023	1.69	2.27	1.69	1.73
2024	1.68	2.27	1.68	1.73
2025	1.68	2.26	1.68	1.72

4.1.2 Biodiesel Production Costs

Biodiesel production costs for this rule were estimated using two variations of a model generated by USDA for a 10 million gallon per year transesterification biodiesel plant. One version uses degummed soy oil as feedstock, and a second version includes acid pre-treatment steps required to utilize feedstocks such as rendered fat and yellow grease, which have considerable free fatty acid content. USDA used the SuperPro Designer chemical process simulation software to build up a process flow with estimates of heat and material flowrates and equipment sizing. Outputs from this software were then combined in a spreadsheet with capital, energy, labor, and feedstock costs to generate a final estimate of production cost. Additional details on the model are given in a 2006 publication in Bioresource Technology, a peer-reviewed scientific journal.⁹²⁰ At 10 million gallons per year, the modeled plant size is between the mean and median plant sizes (13 million and 5 million gal/yr, respectively) given in our industry characterization. Therefore, the model cost estimate is believed to be sufficiently accurate for our analyses and no further work was done to determine the effect of scale on production cost.

Soy oil feedstock price was taken from the FASOM agricultural commodity modeling done for this proposal, described in more detail in section 5.1 of this DRIA. Distressed corn oil from ethanol plants was assumed to have a value 70% that of soy oil, consistent with historical yellow grease prices. A co-product stream produced by the model is crude glycerin valued at \$0.03/lb. Table 4.1-34 shows the feedstock prices and resulting biodiesel price. Energy inputs included natural gas for steam generation, and electricity. The prices used for these were the same as those given in Table 4.1-4 in the corn ethanol production cost section.

Table 4.1-34. Biodiesel feedstock and production costs used in this analysis, 2006\$

	Soy Oil	Yellow Grease ^a
Reference Case		
Feedstock \$/lb	\$0.23	\$0.16
Biodiesel \$/gal	\$2.11	\$1.99
Policy Case		
Feedstock \$/lb	\$0.32	\$0.22
Biodiesel \$/gal	\$2.75	\$2.47

^a Includes corn oil extracted from thin stillage/DGS, rendered fats, recycled greases, etc.

Production cost for biodiesel is primarily a function of feedstock price, with other process inputs, facility, labor, and energy comprising much smaller fractions. Table 4.1-35 shows the production cost allocation for the soy oil-to-biodiesel facility as modeled in the 2022 policy case.

Table 4.1-35. Production cost allocation for soy biodiesel derived from this analysis

Cost Category	Contribution to Cost
Soy Oil	87%
Other Materials ^a	5%
Capital & Facility	4%
Labor	3%
Utilities	1%

^a Includes acids, bases, methanol, catalyst

To arrive at a final weighted average for biodiesel production cost for the 2022 policy case, we weighted together the fraction of biodiesel produced from virgin oil (660 million gallons of soy and commodity-grade corn oil) and yellow grease (150 million gallons, primarily extracted corn oil) to arrive at \$3.18/gal (2006\$).

4.1.3 Renewable Diesel Production Costs

Renewable diesel can be produced using three processing options; 1.) a new standalone unit located in a refinery, 2.) co-processing in an existing refinery diesel hydrotreater and 3.) a standalone unit at a rendering plant (or another location outside of a refinery).

The renewable diesel production process converts vegetable oils and animal fats into a diesel type fuel using thermal depolymerization, which is similar to refinery hydro-treating to remove sulfur. The process uses hydrogen and catalyst to remove oxygen from the triglyceride molecules in the feedstocks oils via a decarboxylation and hydro-oxygenation reaction, yielding some light petroleum products and water as byproducts. The reactions also saturate the olefin bonds in the feedstock oils, converting them to paraffins. All of these reactions consume significant amounts of hydrogen. The extent of these reactions however, depends on the process conditions, as some of the carbon backbone of the oils can be cracked to naphtha and lighter products with higher severity. For our analysis though, we assume no such cracking and predict yields resulting in ninety nine percent diesel fuel with the balance as propane and water.

We derive our production cost estimates from those presented by UOP and Eni's at a 2007 industry conference to make renewable diesel in a grass roots standalone production process inside a refinery.^{OOOOOOOO} The process has a pre-treating unit that removes alkali and acidic producing compounds from feed streams, which removes the catalyst poisons. We also use the UOP engineering estimate to derive costs for co-processing renewable diesel in an existing refinery's diesel hydrotreater. For this, we assume that refiners will; 1) revamp their existing diesel hydrotreater to add capacity and 2) add a pre-treater to remove feedstock contaminants. Lastly, we derive costs for a standalone unit at a location outside a refinery at a rendering plant other facility, using a capital cost estimate from Syntroleum Corp.^{PPPPPPPP} We assume that all of the renewable diesel production will take place in PADD 2, as feedstock shipping cost are reduced since most of the sources for feedstock supply are located primarily in the Midwest.

At the moment, we do not have a exact way of predicting the how industry will develop to build processing capacity using the three processing methods, as only a few known projects have been announced. We therefore base our estimate for future renewable processing capacity on current public project announcements and our production cost estimates, along with feedstock availability. In early 2007, Tyson and ConocoPhillips entered into a strategic alliance to produce 175 MM gallons per year of renewable diesel at Conoco's refineries located in the Midwest, either through co-processing or as a standalone unit. Tyson also announced this fall start of construction for a 75 MM gal/yr standalone plant at rendering plant in location in Geismar,

^{OOOOOOOO} A New Development in Renewable Fuels: Green Diesel, AM-07-10 Annual Meeting NPRA, March 18-20, 2007.

^{PPPPPPPP} From Securities and Exchange Commission Form 8-K for Syntroleum Corp, June 25th 07.

Louisiana. We assume that future capacity additions will mirror these announcements, and that a large fraction of the capacity for refinery installation will be produced using the co-processing method, as the production costs are lower than those for a new standalone unit in a refinery. Using this, we speculate that about 50% of renewable diesel being produced by the refinery co-processing route, 17% from a new stand alone unit at a refinery and 33% at rendering plants or as a new site installation.

We derive an average processing cost to make renewable diesel as 39.6 cents per gallon using yellow grease/animal fats, while processing cost from soy oil feedstock are 37.1 cents per gallon. Both of these costs are the resulting average from using the processing industry capacities listed above, along with our cost estimates. It is advantageous, however to convert yellow grease and animal fats into renewable diesel, as the resulting diesel fuel has improved blending, cold flow, storage and shipping capabilities over yellow grease converted via the biodiesel process. Additionally, since the process-related costs for producing renewable diesel from yellow grease are considerably lower than for converting yellow grease to biodiesel, we assume that all of our projected feedstock supplies of yellow grease and animal fats will be converted using the renewable diesel process, yielding 375 million gallons per year in 2022. As such, we assume that future renewable processing capacity will mirror the volume produced from yellow grease. Considering the uncertainties with subsidies and that there is considerable capacity for processing soy oil in biodiesel plants, we assume that all soy oil will be processed in existing and announced biodiesel plants.

The specifics of our cost estimation are outlined in the sections that follow.

i. New Standalone Unit in Refinery

Capital costs:

We derived new standalone renewable diesel production costs based on the UOP estimate for a new unit built inside an existing petroleum refinery. The total capital cost from the UOP estimate included ISBL and OSBL equipment outlays, which were \$33.9 and \$6.8 MM in 2005 dollars, respectively for an 8,000 BPSD unit. We adjusted the original UOP capital estimates, which were assumed to be in 2006 dollars to 2005 dollars using CPI. Additionally, for our analysis, we assumed that the process was designed to accommodate a throughput flow rate to maintain an average of 8000 BPSD per day on an annual basis. To get installed costs, we escalated the above total capital costs by 20 percent, so as to account for unknown contingencies for installation and adjusted the resulting costs for locating the process in PADD 2, multiplying by a 1.3 factor. We amortized the resulting cost, assuming 7% return on capital after taxes, depreciation, and amortization to derive a cost for capital of 5.9 c/gal. All of the economic factors used for amortizing the capital costs are summarized in Table 4.1-36.

Table 4.1-36. Economic Factors Used in Deriving the Capital Cost Amortization Factor

Amortization Scheme	Depreciation Life	Economic and Project Life	Federal and State Tax Rate	Return on Investment (ROI)	Resulting Capital Amortization Factor
Societal Cost	10 Years	15 Years	0%	7%	0.11

Operating Costs:

For fixed costs, we assumed this is 7% of the total installed capital, resulting in a cost of 4.3 cents per gallon of renewable diesel fuel. For hydrogen operating costs, we used the UOP analysis and guidance from Conoco Philips^{QQQQQQQQ}, to derive our estimate to make renewable diesel, assuming that the feedstock oils were not cracked to other products. The UOP paper presents a range of 1000 to 2000 SCF per barrel for converting the various feedstock to renewable diesel. We derived feedstock specific hydrogen requirements, weighting hydrogen needs for feedstock oxygen saturation, along with cost for hydrogen and UOP’s total variable operating cost. The resulting renewable hydrogen needs are presented in the Table 4.1-37 below.

Table 4.1-37. Feedstock Hydrogen Demands for Renewable Diesel (std. ft³/gallon)

Feedstock Oil	Hydrogen (std ft ³)
Soy Oil	1410
Animal Grease and Yellow Grease	1590

Hydrogen costs were generated using annual projected hydrogen prices from Jacob’s along with the quantities listed above, resulting in a cost of 18.0 and 21.0 c/gal for soy oil and yellow grease, respectively. All other remaining operating variable costs are estimated as 6.5 c/gal, based on the UOP paper. This figure represents cost for manpower, electricity, catalyst, utility requirements, etc.

The resulting total production costs are 34.5 and 37.4 cents per gallon for soy oil and yellow grease, respectively for new unit co-located in a refinery.

ii. Co-Processing in Existing Refinery Diesel Hydrotreater

Co-processing in a refinery appears to be the most cost effective, though feedstock pre-treating equipment may be needed to remove impurities, so as to prevent degradation of refinery diesel hydrotreater catalyst. The advantage of co-processing in a hydrotreater, are that the capital cost are reduced as the existing diesel hydrotreater reactor, heat exchangers, pumps, process lines etc., can be used for the depolymerization reaction. Since the depolymerization reaction is highly exothermic, though there is a limit on the amount of oil feedstock that can be routed through an existing diesel hydrotreater. We derived our estimate for co-processing using the cost information from UOP’s standalone processing in the preceding section.

Capital costs:

^{QQQQQQQQ} Per EPA phone discussion July 23, 2007.

We estimate that pre-treater capital costs will be 40% of the total capital cost of a standalone unit, per guidance from UOP. We assume that this estimate includes capital costs to account for any needed refinery diesel hydrotreater modifications. The capital costs are amortized assuming 7% return on capital after taxes, depreciation, and amortization to derive a cost 2.7 cents.

Operating Costs:

For the fixed cost, we assume this is 8% of the total capital listed above, which equates to 1.9 c/gal. All other remaining operating costs were assumed to be the same as those listed for the UOP standalone unit in the preceding section. The resulting total operating costs are 26.1 and 29.2 c/gal for soy oil and yellow grease, respectively.

For co-processing in a refinery, the resulting total production costs are 28.5 and 30.6 c/gal for soy oil and yellow grease, respectively.

iii. Standalone Unit at Rendering Plant

For a standalone unit, not installed in a refinery, the capital cost are higher than a refinery new unit, as offsite and utility investments are needed to support the renewable processing equipment. These units, therefore require capital for these additional items, since there are little existing infrastructure at the site such as buildings, roads, tanks, pipelines, etc. and utility processes for steam generation, cooling water, etc. For our estimation of these extra costs, we used the total installed capital cost from Syntroleum, which is for a grass roost unit and accounts for offsite items. For operating costs, we assume this will be the same as those in a UOP unit.

Capital costs:

Syntroleum estimated that the total installed capital cost for new process is \$135 MM for a 4800 BPSD unit, located in the South. This figure includes capital costs for offsite and utility investments. We estimated capital cost assuming 7% rate of return, after taxes and depreciation, resulting in 20.0 cents per gallon.

Operating Costs:

We estimated fixed costs as 6% of the total installed capital outlay listed above, which equates to 10.9 c/gal. All other remaining operating costs were assumed to be the same as those listed for the UOP standalone unit.

The resulting overall production costs are 55.2 and 58.3 c/gal for soy oil and yellow grease for a standalone unit, respectively.

Table 4.1-38 summarizes the renewable processing costs outlined in this section. Note that these are per-gallon costs to be added to the cost of the feedstock. Also note that only the

production cost from yellow grease is presented, since this is the feedstock we project will be used in our policy case.

Table 4.1-38. Summary of Renewable Diesel Processing Costs (2006\$/gal)

Installation Type	Processing Cost from Yellow Grease	Volume Share in Policy Case
New unit at refinery	0.37	17%
Existing unit at refinery	0.31	50%
Stand-alone unit at rendering plant	0.58	33%
Weighted average	0.41	100%

4.1.4 BTL Diesel Production Costs

Biofuels-to-Liquids (BTL) processes, which are also thermochemical processes, convert biomass to liquid fuels via a syngas route. The primary product produced by this process is diesel fuel.

There are many steps involved in a BTL process which makes this a capital-intensive process. The first step, like all the cellulosic processes, requires that the feedstocks be processed to be dried and ground to a fine size. The second step is the syngas step, which thermochemically reacts the biomass to carbon monoxide and hydrogen. Since carbon monoxide production exceeds the stoichiometric ideal fraction of the mixture, a water shift reaction must be carried out to increase the relative balance of hydrogen. The syngas products must then be cleaned to facilitate the following Fischer-Tropsch reaction. The Fischer-Tropsch reaction reacts the syngas to a range of hydrocarbon compounds – a type of synthetic crude oil. This hydrocarbon mixture is then hydrocracked to maximize the production of high cetane diesel fuel, although some low octane naphtha is also produced. The many steps of the BTL process contribute to its high capital cost. One report by Iowa State University estimated that diesel fuel produced by a 35 million gallon per year cellulosic Fischer Tropsch plant would cost \$2.37 per gallon.⁹²¹ This cost seems to be based on amortizing the capital costs using a 7 percent before tax rate of return which is the basis for our cost analyses. The report’s estimate for capital cost was \$341 million. This cost was estimated in the year 2002, and adjusting this cost to a 2006 investment environment increases the cost to \$484 million. When we amortize this capital cost assuming a 7 percent rate of return before taxes, the yearly cost is \$53 million, or about \$1.51 per gallon of diesel fuel produced. The report estimates the operating costs to be \$1.48 per gallon, and adjusting the operating costs to reflect 2006 dollars increases the operating cost to \$1.48. Adding the adjusted operating cost to the adjusted capital cost results in a total cost of \$2.99 per gallon. Almost \$1.00 of the total operating cost is due to the feedstock costs, which seems to be assuming about \$75 per dry ton of feedstock. After we adjusted to 2006 dollars, the report would estimate the feedstock to cost \$84 per dry ton, which is higher than our average feedstock cost estimate of \$71 per dry ton. Adjusting to an average estimated feedstock cost of \$71 per dry ton reduces the total cost to \$2.85 per gallon of diesel fuel.

Initially, the estimated cost of \$2.85 per gallon seems high relative to the projected cost for a year 2015 biochemical cellulosic plant, which is \$1.39 per gallon of ethanol in 2006 dollars. However, ethanol provides about half the energy content as Fischer Tropsch diesel fuel. So if we double the biochemical cellulosic ethanol costs to \$2.78 per diesel fuel-equivalent gallon, the

estimated costs are very consistent between the two. The cellulosic biofuel tax subsidy favors the biochemical ethanol plant, though, because it is a per-gallon subsidy regardless of the energy content, and it therefore offsets twice as much cost as the BTL plant producing diesel fuel. There is one more issue worth considering and that is the relative price of diesel fuel to that of E10 or E85. Recently diesel fuel has been priced much higher than gasoline, and if this trend continues to hold, it would provide a better market for selling the BTL diesel fuel than for selling biochemical ethanol into the E85 market, which we believe will be a challenging pricing market for refiners.

4.2 Renewable Fuel Distribution Costs

Our analysis of the costs associated with distributing the volumes of renewable fuels that we project would be used under RFS2 focuses on: 1) the capital cost of making the necessary upgrades to the fuel distribution infrastructure system directly related to handling these fuels, and 2) the ongoing additional freight costs associated with shipping renewable fuels to the point where they are blended with petroleum-based fuels. Our analysis considers distribution costs within the U.S. only. The costs associated with bringing ethanol imports to the U.S. are considered in the context of the cost of the imports themselves.^{RRRRRRRRRR} The following sections outline our estimates of the distribution costs for the additional volumes of ethanol, biodiesel, and renewable diesel fuel that we project would be used in response to the RFS2 standards. There will be ancillary costs associated with upgrading the basic rail, marine, and road transportation nets to handle the increase in freight volume due to the RFS2. We have not sought to quantify these ancillary costs because 1) the growth in freight traffic that is attributable to RFS2 represents a minimal fraction of the total anticipated increase in freight tonnage (approximately 2% by 2022, see Section 1.6.5 of this DRIA), and 2) we do not believe there is an adequate way to estimate such non-direct costs.

The biofuels used in response to the RFS2 standards would displace petroleum-based fuels that would otherwise be used. Thus, it would be appropriate to subtract the distribution costs for the displaced petroleum-based fuels from the distribution costs attributed to the biofuels that replace these petroleum-based fuels. However, we choose not to do so for our primary analysis in order to help ensure a conservatively high estimate of biofuel distribution costs given the uncertainties in our analysis.^{SSSSSSSS}

A discussion of the changes that would be needed in the biofuels distribution system to accommodate the increased volumes of biofuels that we project would be used in response to the proposed RFS2 standards is contained in Section 1.6 of this DRIA. In this chapter, we further detail the nature of these projected changes and estimate the associated costs. Distribution capital costs associated with the additional volume of ethanol, biodiesel, and renewable diesel that we project would be used by 2022 in response to the RFS2 standards relative to a 13 BGY 2022 reference case total 12.448 billion dollars in the U.S., 97% of which is attributed to ethanol.

4.2.1 Ethanol Distribution Costs

^{RRRRRRRRRR} The cost of imported ethanol is discussed in Section 4.1.1.3 of this DRIA.
^{SSSSSSSS} This was the approach taken in the RFS1 final rule.

As discussed in the following sections, we estimate that the total capital costs in the U.S to support distribution of the additional volume of ethanol that would be used in response to the RFS2 standards would be 12.1 billion dollars by 2022. When amortized, this translates to 6.9 cents per gallon of additional ethanol attributed to the RFS2 standards. Amortization of capital costs was done over 15 years at a 7% annual cost of capital except in the case of the cost of tank trucks where a 10 year amortization schedule was used. These costs were calculated relative to the AEO 2007 baseline which projects that 13.2 BGY of ethanol would be used in 2022 absent the RFS2 standards. Under the RFS2 standards, we project that 34.1 BGY of ethanol would be used by 2022. Ethanol freight costs are estimated to be 11.3 cents per gallon on a national average basis. Thus, we estimate that total ethanol distribution costs would be 18.2 cents per gallon of ethanol attributed the RFS2 standards. The way in which we estimated these costs is detailed in the following sections.

As noted previously, we choose not to subtract the distribution costs for the petroleum-based fuels that would be displaced by the use of biofuels from our estimated biofuel distribution costs to help ensure a conservatively high estimate of biofuel distribution costs given the uncertainties in our analysis. We believe that the freight costs to ship petroleum-based fuels to the terminal are approximately 4 cents per gallon. If we were to subtract these costs from the estimated ethanol distribution costs, the result would be 14.2 cents per gallon.

We currently have a study underway through Oakridge National Laboratories (ORNL) to model the transportation of ethanol from production/import facilities to petroleum terminals. The ORNL model optimizes freight flows over the rail, marine, and road distribution net while addressing the use of multiple shipping modes. We plan to use the results of the ORNL study to adjust our ethanol freight and capital cost estimates for the final rule.

4.2.1.1 Capital Costs to Upgrade the Ethanol Distribution System

4.2.1.1.1 Summary of Ethanol Distribution Capital Costs

A summary of ethanol distribution capital costs is contained in Table 4.2-1. Our estimation of these costs is detailed in the following sections.

**Table 4.2-1.
Summary of Estimated Ethanol Distribution Infrastructure Capital Costs***

	Million \$
Fixed Facilities	
Marine Import Facilities	49
Ethanol Receipt Facilities at Rail Terminals	
Rail Car Handling and Miscellaneous Equipment	1,264
Ethanol Storage Tanks	354
Petroleum Terminals	
Rail Receipt Facilities	2,482
Ethanol Storage Tanks	1,611
Ethanol Blending and Miscellaneous Equipment	545
E85 Retail Facilities	2,957
Mobile Facilities	
Rail Cars	2,938
Barges	183
Tank Trucks	223
Total Ethanol Distribution Capital Costs	12,066

* Relative to the AEO 2007 13.2 BGY 2022 reference case

4.2.1.1.2 Petroleum Terminal Ethanol Distribution Capital Costs

The facility upgrades that we project would be needed at petroleum terminals to facilitate the distribution of the volume of ethanol that we project would be used in response to the RFS2 standards are discussed in Section 1.6.9 of this DRIA. Total capital costs at terminals by 2022 relative to the 13 BGY 2022 reference case are estimated at 4.637 billion dollars. These capital costs are detailed in the following sections.

4.2.1.1.2.1 Capital Cost of Additional Ethanol Rail Receipt Capability at Petroleum Terminals

As discussed in Section 1.6.9 of this DRIA, we estimate that an additional 21 unit train and 148 manifest rail car receipt facilities would be built at petroleum terminals by 2022 to handle the additional volumes of ethanol that project would be transported to petroleum terminals via these modes (relative to the 13 BGY reference case). Based on input from industry, we estimate the cost of installing ethanol rail receipt capability at 600 thousand dollars per rail car slot. This figure is meant to include various ancillary costs associated with the necessary track and rail car handling facilities within the terminal gates. We believe that this is an upper bound regarding the potential costs of installing rail receipt capability at terminals, particularly with respect to unit train installations. We hope to receive additional input from industry with which to refine this estimate for the final rule. We assumed that ethanol unit train receipt facilities would need room for 100 rail cars, and that ethanol manifest rail car receipt facilities would accommodate 8 rail cars. Ethanol unit trains are typically composed of 70 to 100

rail cars. Our assumption of an 8 ethanol manifest rail car receipt facility is based on an evaluation of how much ethanol could be handled by such a facility on an annual basis. Assuming 60 deliveries per year (5 per month), translates to an annual throughput at a manifest rail car receipt facility of approximately 14.2 million gallons per year, which we believe to be a reasonable volume for the terminals that would be served primarily by manifest rail. To accommodate contingencies associated with adding ethanol receipt capability, we added 1 million dollars per unit train facility and 500 thousand dollars per manifest rail car facility. Thus, within the gates of the terminal, the cost of a unit train receipt facility is estimated at 61 million dollars and the cost of a manifest rail car receipt facility is estimated at 5.3 million dollars. This does not include the cost of linking the petroleum terminal to a rail line to the extent that such linkage does not already exist.

There is no comprehensive data on the number of terminals that have rail access and the logistical considerations in adding rail access to terminals where proximity to a rail line makes this an option. Lacking such information, we assumed that 50% of terminals that add ethanol rail receipt capability would already have rail access and 50% would need to install a rail spur to bring rail access to their facility. Based on input from industry, we estimate the cost of installing track for a rail spur at 2 million dollars per mile. We assumed that a 4 mile spur would be needed to connect the rail line to the petroleum terminal for unit train receipt and that a 2 mile long spur would be needed to connect the terminal for manifest rail car receipt. This is based on the premise that the length of unit trains may require more gentle curves and/or limit placement of the link to the rail line, whereas accommodating connections for the short manifest rail car shipments would be less demanding. Ancillary costs associated with establishing a linkage to a rail line to allow rail receipt capability are estimated at 4 million dollars per unit train facility. This is meant as a contingency to cover costs that we could not foresee such as the potential need to acquire additional land in certain cases. Again, this is based on the premise that accommodating a long unit train would present additional logistical challenges. The actual cost could be less. Based on the above, we estimate that the cost of providing linkage to a rail line would be 12 million dollars to allow unit train receipt capability and 4 million dollars to support manifest rail car receipt capability at a petroleum terminal.

Summing the above, we arrived at the estimates contained in Table 4.2-2 for the total cost of providing rail receipt capability at terminals including the cost of providing rail access where needed.

**Table 4.2-2.
Estimated Cost of Installing Ethanol Rail Receipt Capability
at Petroleum Terminals**

	Cost Per Facility (million \$)
Unit Train Receipt Capability at a Terminal that Already had Rail Access	61
Unit Train Receipt Capability at a Terminal that Needed to Install New Rail Access	73
Manifest Rail Car Receipt Capability at a Terminal that Already had Rail Access	5.3
Manifest Rail Car Receipt Capability at a Terminal that Needed to Install New Rail Access	9.3

The total cost of the additional unit train receipt facilities (21) that we project would be installed at petroleum terminals by 2022 to support the distribution of the additional volume of ethanol that would be used in response to the RFS2 standards (relative to the 13 BGY reference case) is estimated at 1.4 billion dollars. The total cost of the additional manifest rail car receipt facilities (148) that we project would be needed by 2022 to support the distribution of the additional volume of ethanol that would be used in response to the RFS2 standards (relative to the 13 BGY reference case) is estimated at 1.08 billion dollars. These costs were amortized over 15 years at a 7% annual cost of capital to derive the cents-per-gallon distribution capital cost estimate in Section 4.2.1 of this DRIA.

As discussed in Section 1.6.9 of this DRIA, there is considerable uncertainty regarding the extent to which additional rail receipt facilities would be placed at petroleum terminals versus at rail terminals. This has implications not only with respect to whether the costs would be incurred by petroleum terminals or rail terminals but also the extent to which secondary transportation of ethanol is needed to reach petroleum terminals and the extent to which ethanol storage and handling capability would be needed at rail terminals. The projected modes of transporting ethanol to petroleum terminals are discussed in Section 1.6.2 of this DRIA. The projected capital costs at rail terminals to facilitate the distribution of ethanol are discussed in Section 4.2.1.1.3 of this DRIA.

4.2.1.1.2.2 Capital Cost of Additional Ethanol Storage Tanks at Petroleum Terminals

A discussion of how we estimated the volume of new ethanol storage that would be needed by 2022 as a result of the RFS2 standards (relative to the 13 BGY 2022 reference case) is contained in Section 1.6.9 of this DRIA. The breakdown of the amount of new ethanol storage that we believe could be accommodated through the retrofitting of existing tanks currently in gasoline service versus the amount that would require the construction of new storage tanks is also discussed in Section 1.6.9. We estimate that a total of 97.3 million barrels of new ethanol storage would be needed at petroleum terminals due to the RFS2 standards, 65.2 million barrels of which would be existing gasoline storage tanks retrofitted to ethanol service and 32.1 million barrels of which would be new construction. As discussed in Section 4.2.1.1.3.2, we estimate

that an additional 8.85 million barrels of new ethanol storage would also be needed at rail terminals, all of which would be satisfied with new construction. Based on information from industry with respect to the effect of increased steel prices on storage tanks costs, we estimate that the cost of constructing new ethanol storage tanks would be 40 dollars per barrel. The cost of installing an ethanol compatible liner and making other modifications to existing gasoline storage tanks to make them compatible for storing ethanol is estimated to be 5 dollars per barrel on average. Thus, we estimate that the total cost at petroleum terminals of new ethanol storage would be 1.61 billion dollars, 1.28 billion dollars of which is attributed to the construction of new tanks, and 326 million dollars of which is attributed to the conversion of existing gasoline tanks to ethanol service. These costs were amortized over 15 years at a 7% annual cost of capital to derive the cents-per-gallon distribution capital cost estimate in Section 4.2.1 of this DRIA.

4.2.1.1.2.3 Capital Cost of Ethanol Blending and Other Miscellaneous Equipment at Petroleum Terminals

As discussed in Section 1.6.9 of this DRIA, petroleum terminals would need to install additional equipment to blend ethanol with gasoline as well as making other miscellaneous upgrades to, piping, pumps, seals, and vapor recovery systems to ensure ethanol compatibility. As detailed in Section 1.6.9 of this DRIA, we projected that 164 terminals would need to install ethanol blending equipment by 2022 as a result of the RFS2 standards (relative to the 13 BGY 2022 reference case). We further project that 90% of all terminals (931) would need to install E85 blending capability by 2022 as a result of the RFS2 standards. The remaining terminals (132 out of a total of 1,063) were projected to have only E10 blending capability by 2022. We estimated that the terminals which would have installed E10 blending capability absent the RFS2 standards would be the ones that upgrade their ethanol blending capability to accommodate blending E85 as well as E10. We also estimated that the 164 terminals that would not have received ethanol absent the RFS2 standards would need to upgrade their vapor recovery systems and make other miscellaneous changes to handle ethanol blended fuel for the first time.

We estimated the costs of the changes needed at petroleum by 2022 relative to the 13 BGY 2022 reference case based on input from terminal operators and various other industry sources. The cost of upgrading the vapor recovery systems at petroleum terminals that would not have handled ethanol absent the RFS2 standards is estimated at 1 million dollars per terminal, and the miscellaneous costs associated with handling ethanol for the first time are estimated at 20,000 per terminal. This equates to a total of 176.3 million dollars for the 164 terminals that we project would not have handled ethanol absent the RFS2 standards. We estimate that all 1,063 petroleum terminals would incur 300 thousand dollars per facility on average to upgrade their piping, electrical, and other miscellaneous equipment in order to handle the increased ethanol throughput that they would experience due to the RFS2 standards. This is based on our engineering judgment and contains substantial contingency costs. Actual costs could be less. This would total 318.9 million dollars by 2022.

In addition, the cost of installing E10 blending equipment is estimated to average 300 thousand dollars for the 164 terminals that we estimate would not have installed ethanol blending capability in the absence of the RFS2 standards. This does not include the needed ethanol storage capability discussed in Section 4.2.1.1.2.2 of this DRIA and the miscellaneous piping and other

work needed that is discussed above. Input from terminal operators indicates that retrofitting E10 blending equipment to dispense E85 as well as E10 (apart from ethanol storage and delivery concerns) primarily involves changes to computer software. Based on this input, we estimate that E85 blending equipment would cost 10 thousand dollars more than E10 blending equipment. We applied this 10 thousand dollar differential to new installations of E85 blending equipment as well as retrofits of existing E10 blending equipment. Based on this, we estimate the total cost of the ethanol blending equipment that would be needed at petroleum terminals as a result of the RFS2 standards to be 58.5 million dollars.

Summing all of these estimated costs, we arrived at an estimate of the total cost by 2022 for the ethanol blending and other miscellaneous equipment that would be needed at petroleum terminals as a result of the RFS2 standards of 544.7 million dollars. These costs were amortized over 15 years at a 7% annual cost of capital to derive the cents-per-gallon distribution capital cost estimate in Section 4.2.1 of this DRIA.

4.2.1.1.3 Rail Terminal Ethanol Distribution Capital Costs

The facility upgrades that we project would be needed at rail terminals to facilitate the distribution of the volume of ethanol that we project would be used in response to the RFS2 standards are discussed in Section 1.6.3 of this DRIA. Total capital costs at terminals by 2022 relative to the 13 BGY 2022 reference case are estimated at 1.618 billion dollars. These capital costs are detailed in the following sections.

4.2.1.1.3.1 Capital Cost of Ethanol Unit Train Receipt Capability at Rail Terminals

As discussed in Section 1.6.3 of this DRIA, we project that 21 ethanol unit train receipt facilities would be located at rail terminals to facilitate the delivery of ethanol to petroleum terminals. Consistent with the approach taken in the estimation of the cost of installing a unit train facility at a petroleum terminals (as discussed in Section 4.2.1.1.2.1 of this DRIA), we estimated the cost of installing ethanol rail receipt capability at a rail terminal to be 600 thousand dollars per rail car slot. This translates to 60 million dollars for a facility capable of receiving a 100 rail car unit train. In the case of rail terminals, we believe this figure is sufficient to cover various ancillary costs associated with the necessary track and rail car handling facilities within the rail terminal gates. Given that rail terminals are already in the business of handling large numbers of rail cars, we believe that there would be significantly less ancillary costs associated with handling ethanol rail cars themselves compared to a petroleum terminal. Thus, we believe that the 600 thousand per rail slot is also sufficient to cover whatever truck loading, piping, and other miscellaneous costs that would be incurred at rail terminals (with the exception of the need for ethanol storage tanks that is discussed in the following section). Nevertheless, we added a 1 million dollar per rail terminal contingency cost to help ensure that these ancillary costs are accounted for. Consistent with our estimate of the cost of unit train facilities at petroleum terminals, we assumed the need to accommodate a 100 car ethanol unit train.

Based on the above, we project that the total cost of installing ethanol unit train receipt capability at a rail terminal to be 61 million dollars per facility. This totals 1.264 billion dollars for the 21 ethanol unit train rail receipt facilities that we project would be installed as a result of

the RFS2 standards by 2022 (relative to the 13 BGY 2022 reference case). These costs were amortized over 15 years at a 7% annual cost of capital to derive the cents-per-gallon distribution capital cost estimate in Section 4.2.1 of this DRIA.

As discussed in Section 1.6.9 of this DRIA (and noted in Section 4.2.1.1.2.1), there is considerable uncertainty regarding the extent to which additional rail receipt facilities would be placed at petroleum terminals versus at rail terminals. To the extent that logistical constraints prevent the placement of some of the 21 additional ethanol unit train receipt facilities and/or 148 manifest rail car facilities that we project would be installed at petroleum terminals (see Section 4.2.1.1.2.1), we expect that additional unit train receipt facilities would be placed at rail terminals to compensate.

4.2.1.1.3.2 Capital Cost of Ethanol Storage Tanks at Rail Terminals

As discussed in Section 1.6.3 of this DRIA, we project that 17.7 million gallons of new ethanol storage would be needed at rail terminals to support unit train deliveries. This equates to a total of 371.7 million gallons or 8.85 million barrels of new ethanol storage tanks for the 21 ethanol unit train receipt facilities that we project would be installed to support use of the volume of ethanol that we estimate would be used in response to the RFS2 standards (relative to the 13 BGY 2022 reference case). We used the same estimate of 40 dollars per barrel to construct new ethanol storage tanks that we used to estimate the cost of new ethanol storage tanks at petroleum terminals (in Section 4.2.1.1.2 of this DRIA). Thus, we estimate that the total cost of the additional ethanol storage tankage that would be needed due to the RFS2 standards is 354 million dollars. These costs were amortized over 15 years at a 7% annual cost of capital to derive the cents per gallon distribution capital cost estimate in Section 4.2.1 of this DRIA. Should some of the ethanol rail receipt facilities that we project would be installed at petroleum terminals instead be installed at rail terminals, ethanol storage at additional rail terminals would be needed instead.

4.2.1.1.4 Import Facility Ethanol Distribution Capital Costs

As discussed in Section 1.6.4 of this DRIA, we estimate that a total of 28 port facilities would receive imported ethanol by 2022, 12 of which had not received ethanol before. We believe that all such port facilities also serve as petroleum terminals. Thus, the cost of additional ethanol storage, ethanol blending equipment, and other miscellaneous equipment related to handling ethanol from the standpoint of terminal operations at such facilities is accounted for in the context of the costs at petroleum terminals (see Section 4.2.1.1.2 of this DRIA). However, there would be additional costs at the port facilities which had not received ethanol in the past. Input from industry indicates that offloading large marine transport containers of ethanol requires significantly upgraded vapory recovery equipment. Based on this input, we estimated the cost of making the needed upgrades to vapor recovery equipment at 2.5 million dollars per facility. We further estimated miscellaneous costs associated with delivery of ethanol into storage tanks from marine vessels at 1 million dollars per facility. This is meant to include new piping, pumps, various other fittings, and a contingency cost. The actual cost could be significantly lower. Thus, we estimate that the total cost to prepare for delivery of ethanol at a port that had not received ethanol before is 3.5 million dollars per facility. The total for the 12 ports that we

project had received imported ethanol before is 42 million dollars. As discussed in Section 1.6.4, we are considering whether 2 additional ports that have not received ethanol before should be added to the list of ports that we expect would receive ethanol imports by 2022. Including these 2 additional ports would increase the total cost for ports that had not received ethanol before to 49 million dollars. These costs were amortized over 15 years at a 7% annual cost of capital to derive the cents-per-gallon distribution capital cost estimate in Section 4.2.1 of this DRIA.

4.2.1.1.4 Ethanol Rail Car Capital Costs

As discussed in Section 1.6.3 of this DRIA, we estimate that an additional 26,644 ethanol tank cars would be needed by 2022 to transport the additional volume of ethanol that we project would be used to meet the RFS2 standards (relative to the 13 BGY 2022 reference case). Based on input from industry, we estimate that the cost of a new ethanol tank car of 30 thousand gallon nominal capacity at 90 thousand dollars. Thus, we estimate that the total cost of the ethanol rail tanks cars needed due to the RFS2 standards by 2022 would be 2.398 billion dollars. These costs were amortized over 15 years at a 7% annual cost of capital to derive the cents-per-gallon distribution capital cost estimate in Section 4.2.1 of this DRIA.

4.2.1.1.5 Ethanol Barge Capital Costs

As discussed in Section 1.6.4, we estimate that an additional 131 10,000 barrel capacity barges would be needed by 2022 to transport the additional volume of ethanol that we project would be used to meet the RFS2 standards (relative to the 13 BGY 2022 reference case). Based on input from industry, we estimate the cost of a new 10,000 barrel barge capable of transporting ethanol at 1.4 million dollars. Thus, we estimate that the total cost of barges needed to transport ethanol due to the RFS2 standards by 2022 would be 183 million dollars. These costs were amortized over 15 years at a 7% annual cost of capital to derive the cents-per-gallon distribution capital cost estimate in Section 4.2.1 of this DRIA.

We understand that the tank barge industry is trending towards the use of tank barges with a carrying capacity of 30,000 barrels which tend to be less expensive on a per-barrel basis than 10,000 barrel capacity barges. Thus, our assumed use of a 10,000 barrel capacity barges likely results in a conservatively high estimate of ethanol barge costs.

4.2.1.1.6 Ethanol Tank Truck Capital Costs

As discussed in Section 1.6.5 of this DRIA, we estimate that an additional 1,241 8,000 gallon capacity tank trucks would be needed by 2022 to transport the additional volume of ethanol that we project would be used to meet the RFS2 standards (relative to the 13 BGY 2022 reference case). Based on input from industry, we estimate that the cost of a new 8,000 gallon tank truck capable of transporting ethanol at 180 thousand dollars. This is based on a 110 thousand dollar cost for the tractor and a 70 thousand dollar cost for the tank trailer. Thus, we estimate that the total cost of tank trucks needed to transport ethanol due to the RFS2 standards by 2022 would be 223 million dollars. These costs were amortized over 10 years at a 7% annual cost of capital to derive the cents-per-gallon distribution capital cost estimate in Section 4.2.1 of

this DRIA. We used a 10 year amortization schedule for tank trucks as opposed to the 15 year schedule used for other capital equipment to reflect their likely shorter service life.

4.2.1.1.6 E85 Retail Facility Costs

As discussed in Section 1.6.10 of this DRIA, we estimate that an additional 24,250 E85 retail facilities would be needed by 2022 as a result of the RFS2 standards (relative to the 13 BGY 2022 reference case). We estimated that 40% of these new facilities would install 2 new E85 pumps with four nozzles. We assumed that no existing equipment would be retrofitted to meet this demand. On average, we estimate the cost per E85 facility would be 122,000 dollars as detailed below. This cost estimate includes the use of E85 compatible hardware and compliance with applicable regulations regarding the storing/dispensing fuels.

The following cost estimates are based on input from gasoline retailers and other parties with experience in the requirements and costs associated with installing E85 retail equipment. The total cost of installing a two nozzle E85 dispenser is estimated at 23,000 dollars. This is composed of 17,000 dollars for the dispenser itself, 750 dollars for hanging hardware, 950 for refueling island hardware, 3,000 for installation, and a 1,300 dollar contingency cost. Hanging hardware costs are composed of 310 dollars for 2 nozzles, 135 dollars for 2 breakaway connections, 135 dollars for 2 swivel connections, and 170 dollars for 2 hoses. Refueling hardware costs are composed of 450 dollars for the dispenser island, 250 for an island sump pump, and 250 dollars for bumper posts. Installation costs are composed of 1,500 dollars for concrete removal and replacement, and 1,500 dollars for wiring and piping.

The cost of automatic tank level gauging equipment is estimated at 6,500 dollars. It is estimated that 65% of retailers would install automatic tank gauging (ATG) equipment and the remainder would rely on manual means of determining the amount of fuel remaining in their underground storage tank. Thus, the average cost per facility would be 4,225 for ATG equipment. We estimate the cost of installing a canopy addition to provide cover for an additional dispenser at 15,000. We estimated that only 10% of facilities would need to install additional canopy coverage in order to accommodate the new E85 retail dispenser. Thus, the average canopy cost per facility is estimated at 1,500 dollars. The cost of installing a new 8,000 underground E85 storage tank system is estimated at 84,000 dollars. The cost of connecting the tank to the dispenser(s) is included in this cost along with other miscellaneous storage tank related costs.

We proposed that a label be placed near each E85 nozzle which states the E85 is for use only flex-fuel vehicles.^{TTTTTTTTT} Based on input from industry, the cost of compliance with this proposal would be approximately 5 dollars per label. New labels would be needed on all E85 dispensers, which totals approximately 385,000 dollars for the 76,900 E85 nozzles that we project would be in operation by 2022 under the RFS2 standards.

Based on the above, we estimate the cost of installing a new single dispenser E85 facility would be 113,000 dollars and the cost for a 2 dispenser facility would be 136,000 dollars. Based on our projection that 40% of facilities would install 2 dispensers, we estimate an average cost of

^{TTTTTTTTT} See proposed regulatory Section 80.1469.

122,000 per new E85 facility. Thus, the total cost of the 24,250 new E85 facilities that we project would be needed by 2022 due to the RFS2 program would be 2.96 billion dollars. These costs were amortized over 15 years at a 7% annual cost of capital to derive the cents-per-gallon distribution capital cost estimate in Section 4.2.1 of this DRIA. As discussed in Section 1.6.10 of this DRIA, this cost estimate is based on our assessment that it would be sufficient for one in four retail facilities to offer E85 in 70% of the country.

As discussed in Section 1.6.10, we performed several sensitivity analyses to evaluate the potential that additional dispensers or retail facilities might be needed to facilitate the use of the volume of E85 that we project would be needed by 2022 to support compliance with the RFS2 standards. Under one scenario, we assumed that 3 E85 dispensers would be needed at each facility that sells E85 in order to provide a less aggressive throughput per nozzle level. Under this scenario, the 4,500 E85 retail facilities that we estimate would be in place by 2022 absent the RFS2 requirements would need to install an additional 2 dispensers.^{UUUUUUUUUU} Based on the above, the cost to these facilities would be 46,000 dollars. We also assumed that 50% of new E85 facilities would convert one of its gasoline storage tanks to E85 service in addition to installing a new E85 storage tank.^{VVVVVVVVVV} Based on these assumptions and the cost information discussed above, the cost per new E85 facility would be 166,000 dollars. The total cost under this scenario would rise to 4.24 billion dollars.

We evaluated 3 additional sensitivity cases under which the total number of E85 facilities needed was increased by varying our estimates regarding what fraction of retailers would need to offer E85 in a given area to provide reasonable access and the fraction of the country that would need to have reasonable access to E85. In all cases, we maintained the assumption that 40% of new E85 retail facilities would install two dispensers while the remainder would install only one dispenser. Under the first such scenario, we assumed that one-in-three retail facilities in a given area would need to offer E85 to provide reasonable access, while maintaining our estimate that reasonable access would be needed in 70% of the county. Under this scenario, an additional 33,835 E85 retail facilities would be needed by 2022 relative to the 13 BGY 2022 reference case at a total cost of 4.13 billion dollars. Under the second such scenario, we assumed that one-in-four retail facilities in a given area would need to offer E85 to provide reasonable access consistent with our primary case, but that reasonable access would be needed in 100% of the county. Under this scenario, an additional 36,573 E85 retail facilities would be needed by 2022 relative to the 13 BGY 2022 at a total cost of 4.46 billion dollars. Under the third such scenario we assumed that one-in-three retail facilities in a given area would need to offer E85 to provide reasonable access and that reasonable access would be needed in 100% of the county. Under this scenario, an additional 50,264 E85 retail facilities would be needed by 2022 relative to the 13 BGY 2022 at a total cost of 6.13 billion dollars.

4.2.1.2 Ethanol Freight Costs

Our estimation of the cost of transporting ethanol from production/import facilities to the various locations where it would be used is based on the freight cost estimates developed for the

^{UUUUUUUUUU} As discussed in Section 1.6.10 of this DRIA we assumed that these facilities would install only a single E85 dispenser (with 2 nozzles) absent the RFS2 program.

^{VVVVVVVVVV} This cost includes all the necessary changes to make the tank and associated equipment E85 compatible.

RFS1 final rule⁹²² A comprehensive study of the infrastructure requirements for an expanded fuel ethanol industry conducted for the Department of Energy (DOE) in 2002 provided the foundation for our estimate of the freight costs to handle the increased volume of ethanol needed under the RFS1 program.⁹²³ As noted earlier, we currently have a study underway through Oakridge National Laboratories (ORNL) to model the transportation of ethanol from production/import facilities to petroleum terminals. The ORNL model optimizes freight flows over the rail, marine, and road distribution net while addressing the use of multiple shipping modes. We plan to use the results of the ORNL study to adjust our ethanol freight cost estimates for the final rule.

Our estimation of ethanol freight costs is based on our evaluation of where ethanol would be produced/imported and where it would be used under the RFS2 standards. Section 1.5 of this DRIA contains a discussion of our projections regarding where ethanol would be produced and the points of entry for ethanol imports to satisfy the RFS2 requirements. Section 1.7 of this DRIA contains a discussion of where we project ethanol would be used under the proposed RFS2 program. Overall ethanol freight costs were minimized by first filling demand within a state with ethanol produced within or imported into that state and then reaching out to areas that had an excess production capacity compared to in-state demand. We developed ethanol freight costs on a state-by-state basis for ethanol that is produced within and imported into the state, and ethanol that is shipped in from PADD2. A higher freight cost was assessed to rural versus urban areas for ethanol brought in from out-of-state. This is based on the premise that ethanol shipped to rural areas from out-of-state would typically either first be delivered to a hub terminal in an urban area (typically by unit train) for further shipment to terminals in rural areas or would be shipped directly to terminals in rural areas via manifest rail car.^{www}

In-state shipment of ethanol was assumed to be done by tank truck. Such in-state ethanol freight costs were developed based on a review of shipping distances and topography with the state and the trucking costs developed for the RFS1 final rule. Ethanol freight costs from PADD 2 production facilities to meet out-of-state demand were also based on the estimates developed for the RFS1 final rule for such shipments.⁹²⁴ We made several changes to the RFS1 freight cost estimates for the purpose of our RFS2 analysis. The freight cost estimates for shipment to rural areas in several states (California, Hawaii, and Michigan) were increased relative to those in the RFS1 rule based on our reanalysis of the difficulties in meeting all of the rural demand in these states. In part, this is based on the premise that ethanol would need to travel farther and more widely to satisfy the volume requirements under the RFS2 standards in comparison to the RFS1 standards. We also considered freight costs for the upper and lower peninsulas of the State of Michigan separately for the purposes of our RFS2 analysis, whereas the State of Michigan was treated as a whole under the RFS1 analysis.

Following is a discussion of our derivation of the freight costs for ethanol shipped from PADD2 production centers to meet out-of-state demand. The 2002 DOE study contains estimated ethanol freight costs for each of the 5 PADDs. These estimated costs are summarized in the following Table 4.2-3.⁹²⁵ A map of the PADDs is contained in Figure 4.2-1.

^{www} A discussion of our assessment of which areas are rural versus urban is contained in Section 1.7 of this DRIA.

**Table 4.2-3.
Estimated Ethanol Freight Costs from the 2002 DOE Study**

PADD	5.1 billion gallons per year (cents per gallon)	10.0 billion gallons per year (cents per gallon)
1	11.1	7.2
2	4.3	2.4
3	6.6	5.8
4	4.7	7.4
5	12.7	10.7
National Average	7.7	5.7

**Figure 4.2-1.
PAD District Definitions.**

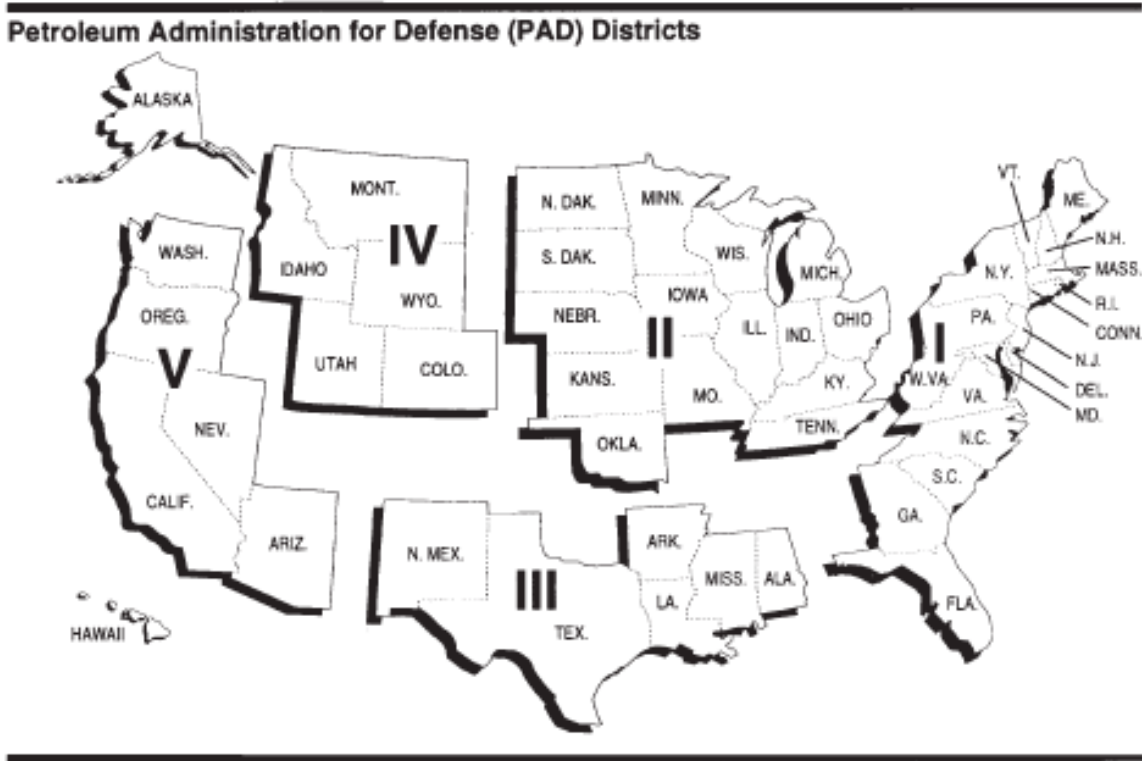

The Energy Information Administration (EIA) translated the cost estimates from the 2002 DOE study to a census division basis.⁹²⁶ A summary of the resulting (EIA) ethanol distribution cost estimates are contained in the following Table 4.2-4. A map of the census divisions is contained in Figure 4.2-2.

**Table 4.2-4.
EIA Estimated Ethanol Freight Costs
(Derived from the 2002 DOE Study)**

Census Division		Freight Cost (cents per gallon)
From	To	
East North Central	New England	9.8
East North Central	Middle Atlantic	9.8
East North Central	East North Central	4
East North Central	South Atlantic	9.8
East North Central	East South Central	4.7
East North Central	Pacific	14.0
West North Central	New England	11.4
West North Central	Middle Atlantic	11.4
West North Central	East North Central	4
West North Central	West North Central	4
West North Central	South Atlantic	11.4
West North Central	East South Central	4.7
West North Central	West South Central	4.7
West North Central	Mountain	4.5
West North Central	Pacific	13.0

Figure 4.2-2.
Census Divisions

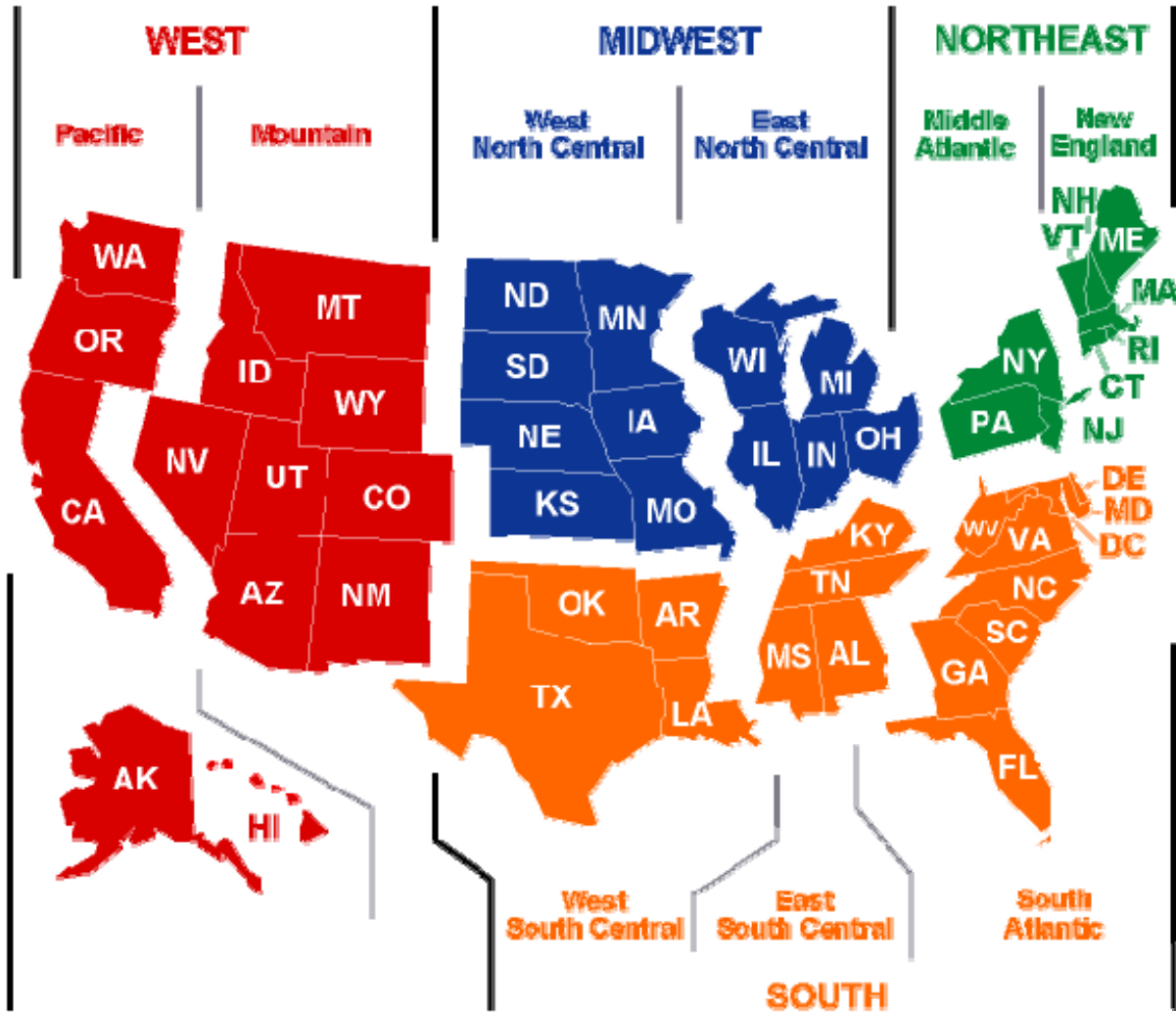

We took the EIA projections and translated them into state-by-state freight costs for shipment of the ethanol produced in the East and West North Central Census Divisions (corresponding closely to PADD 2). Distribution outside of PADD2 was assumed to be by rail, or marine vessel. In the case of Alaska and Hawaii, differences in ethanol delivery prices from the mainland were inferred from gasoline prices. A single average freight cost for each destination census division was generated by weighting together the freight costs given for each mode in both source census divisions according to their volume share. These cents per gallon figures were first adjusted upward by 10% to reflect the increased cost of transportation fuels used to ship ethanol between the 2002 DOE study and the publication of the RFS1 FRM, and then additional adjustments were applied to some individual states based on their position within the census division. We believe that these estimates reasonably correspond to the 53 dollar per barrel of crude case that we used in other areas of our analysis. We were unable to develop an estimate of how an increase in crude cost would affect ethanol freight costs for this proposal.

Freight costs are correlated to the cost of the transportation fuel used by the transportation modes employed. Transportation fuel costs represent a different fraction of overall freight costs for each of the different modes (rail, barge, tank truck). We were unable to obtain sufficient data with which to assess the effects on ethanol freight costs of increased crude costs for all of the modes employed. There are significant competitive issues with respect to how these costs are passed along to customers, and the extent to which increases in transportation fuel costs must be absorbed by the shipper as opposed to being passed along to the customer due to market conditions. We intend to pursue this issue further so that we can develop an estimate of ethanol freight costs under the 92 per barrel of crude case that was used in other areas of our analysis.

For some states, different freight costs for ethanol supplied to large hub terminals versus small satellite terminals were estimated. The reasoning behind this is that large shipments of ethanol shipped from the Midwest by barge, ship, and/or unit train will often be initially unloaded at hub terminals for further distribution to satellite terminals. In cases where redistribution from a hub to a satellite terminal doesn't take place, the volume of ethanol shipped directly from the producer to a lesser volume ("satellite") terminal would also incur a higher freight rate than ethanol shipped to a larger-volume "hub" terminal. The largest adjustment was applied to the Rocky Mountain States since they are generally large in area and additional expense is required to transport freight through higher elevations and rugged terrain. Smaller adjustments were applied to states that are smaller, flatter, or have access by navigable waterways. The states to which an adjustment was not applied were generally in the Midwest or were so small as to not warrant different distribution costs. The estimated additional freight cost of shipping ethanol to satellite terminals versus hub terminals is contained in the following Table 4.2-5. All areas were not assigned both hub and satellite terminal ethanol distribution costs. For example, all shipment to of ethanol to the upper peninsula of the State of Michigan was assumed to be to smaller volume terminals, since there is insufficient population density in the area to support a hub terminal.

**Table 4.2-5.
Additional Freight Cost to Deliver Ethanol to a Satellite Terminal
Compared to a Hub Terminal**

States*	cents per gallon
OH, MI (lower peninsula)	2
AL, AR, CA, FL, GA, KY, LA, MD, ME, MS, NC, NH, NY, OK, OR, PA, SC, TN, VA, VT, WA, WV	4
AK, AZ, CO, ID, NM, NV, TX, UT, WY	5

* States not listed were not assigned separate hub and satellite freight costs.

We also made adjustments to the DOE study derived freight cost estimates to better account for the cost of shipping ethanol from the production plant to the rail head / marine terminal either for large volume shipment by unit train or marine shipment to hub terminals, or for shipment at single car rates via multiple-product trains directly to satellite terminals. Chicago is a primary ethanol gathering point from producers for further distribution. A 4 cent per gallon conveyance fee is charged to account for delivery of ethanol from the production plant gate to

the Chicago Board of Trade delivery point for taking ethanol. This includes train shipments, loading costs, and other miscellaneous fees. Based on this information, we added 4 cents per gallon to our ethanol freight estimates.

We assumed that these freight costs do not include the costs associated with the recovery of capital for the distribution facility changes that are necessary to accommodate the increased volume of ethanol. This may tend to overstate distribution costs to some extent because some capital recovery may already be incorporated into the 4 cent per gallon conveyance fee. The inclusion of rail tank car lease fees also suggests that these estimated freight costs may be conservatively high given that rail car lease fees incorporate a capital recovery and a profit margin.

Our resulting estimates of the state-by-state ethanol freight costs in 2022 are contained in Table 4.2-6. Based on these estimates and our projections regarding where ethanol would be produced/imported and used, we estimate that the national average ethanol freight cost would be 11.3 cents per gallon.

Ethanol freight costs will vary from year-to-year based on where ethanol would be shipped versus where it would be produced. As the volumes of ethanol used increase over time, more ethanol would be used in rural areas that have higher distribution costs. Therefore, we believe that average ethanol freight costs would increase over time. Thus, basing our evaluation of ethanol freight costs on the 2022 case should provide a conservatively high estimate of freight costs for earlier years. A discussion of how we estimated the volumes of ethanol used in each state from in-state versus out-of-state production/imports and the estimation of volume that would be shipped to urban versus rural areas is contained in Section 1.7.1 of this DRIA.

**Table 4.2-6.
2022 Estimated Ethanol Freight Costs**

Destination	% of Use From In-State Supply (vs. Out-of-State Supply)	Freight Cost for In-State Supply (cpg)	% of Out-of-State Supply Shipped to Urban Areas (vs. Rural Areas)	Freight Cost for Out-of-State Supply Shipped to Urban Areas (cpg)	Freight Cost for Out-of-State Supply Shipped to Rural Areas (cpg)
Alabama	68	4.4	46	11.2	15.2
Alaska	0	NA	53	45.4	50.5
Arizona	5	5.4	76	19.4	24.4
Arkansas	76	5.4	37	11.3	16.3
California	26	4.4	94	20.5	24.5
Colorado	22	5.4	64	14.4	19.4
Connecticut	18	4.4	100	15.4	NA
Delaware	0	NA	100	15.4	NA
District of Columbia	0	NA	100	15.4	NA
Florida	29	4.4	84	12.4	16.4
Georgia	44	5.4	68	15.4	19.4
Hawaii	15	5.4	60	40.5	44.5
Idaho	34	5.4	29	19.4	24.4
Illinois	100	4.4	NA	NA	NA
Indiana	100	4.4	NA	NA	NA
Iowa	100	3.4	NA	NA	NA
Kansas	100	4.4	NA	NA	NA
Kentucky	16	5.4	47	6.2	10.2
Louisiana	100	4.4	NA	NA	NA
Maine	96	5.4	61	17.4	21.4
Maryland	0	NA	89	15.4	15.4
Massachusetts	18	4.4	100	15.4	NA
Michigan –LP	69	5.4	68	6.2	10.2
Michigan –UP	0	NA	0	NA	10.2
Minnesota	100	4.4	NA	NA	NA
Mississippi	38	4.4	27	10.2	14.2
Missouri	98	4.4	58	6	8
Montana	64	5.4	9	17.4	22.4
Nebraska	100	4.4	NA	NA	NA
Nevada	6	5.4	77	20.4	25.4

**Table 4.2-6. (continued)
2022 Estimated Ethanol Freight Costs**

Destination	% of use from in-State Supply (vs. Out-of-State Supply)	Freight Cost for in-State Supply (cpg)	% of Out-of-State Supply Shipped to Urban Areas (vs. Rural Areas)	Freight Cost for out-of-state supply to urban areas (cpg)	Freight Cost for out-of-state supply to rural areas (cpg)
New Hampshire	91	4.4	67	16.4	16.4
New Jersey	18	4.4	100	15.4	NA
New Mexico	8	4.4	33	16.4	21.4
New York	28	5.4	85	15.4	19.4
North Carolina	40	4.4	61	15.4	19.4
North Dakota	100	5.4	NA	NA	NA
Ohio	77	5.4	74	6.2	10.2
Oklahoma	100	4.4	NA	NA	NA
Oregon	84	5.4	57	20.5	24.5
Pennsylvania	20	5.4	72	12.4	16.4
Rhode Island	18	4.4	100	15.4	NA
South Carolina	45	4.4	49	15.4	19.4
South Dakota	100	5.4	NA	NA	NA
Tennessee	34	5.4	58	6.2	10.2
Texas	39	5.4	88	14.3	19.3
Utah	0	NA	72	17.4	22.4
Vermont	0	NA	0	NA	16.4
Virginia	17	5.4	68	15.4	19.4
Washington	38	5.4	60	20.5	24.5
West Virginia	67	5.4	28	15.4	19.4
Wisconsin	100	4.4	NA	NA	NA
Wyoming	8	5.4	0	NA	21.4

4.2.2 Biodiesel Distribution Costs

As discussed in the following sections, we estimate that the total capital costs to support distribution of the additional volume of biodiesel that would be used in response to the RFS2 standards would be 381 million dollars by 2022. When amortized, this translates to 9.8 cents per gallon of additional biodiesel attributed to the RFS2 standards. Amortization of capital costs was done over 15 years at a 7% annual cost of capital except in the case of the cost of tank trucks where a 10 year amortization schedule was used. These costs were calculated relative to the AEO 2007 baseline which projects that 380 MGY of biodiesel would be used in 2022 absent the RFS2 standards. Under the RFS2 standards, we project that an additional 430 MGY of biodiesel would

be used by 2022 for a total of 810 MGY. Biodiesel freight costs are estimated to be 9.3 cents per gallon on a national average basis.^{XXXXXXXXXX} Thus, we estimate that total biodiesel distribution costs would be 19.1 cents per gallon of biodiesel attributed the RFS2 standards. The way in which we estimated these costs is detailed in the following sections.

As noted previously, we choose not to subtract the distribution costs for the petroleum-based fuels that would be displaced by the use of biofuels from our estimated biofuel distribution costs to help ensure a conservatively high estimate of biofuel distribution costs given the uncertainties in our analysis. We believe that the freight costs to ship petroleum-based fuels to the terminal are approximately 4 cents per gallon. If we were to subtract these costs from the estimated biodiesel distribution costs, the result would be 15.1 cents per gallon.

4.2.2.1 Capital Costs to Upgrade the Biodiesel Distribution System

4.2.1.1.1 Summary of Biodiesel Distribution Capital Costs

A summary of biodiesel distribution capital costs is contained in Table 4.2-7. Our estimation of these costs is detailed in the following sections.

**Table 4.2-7.
Summary of Estimated Biodiesel Distribution Infrastructure Capital Costs***

	Million \$
Fixed Facilities	
Petroleum Terminals	
Biodiesel Storage Tanks	129
Biodiesel Blending and Miscellaneous Equipment	192
Mobile Facilities	
Rail Cars	35
Barges	17
Tank Trucks	8
Total Biodiesel Distribution Capital Costs	381

* Relative to the AEO 2007 380 MGY 2002 reference case.

4.2.1.1.2 Petroleum Terminal Biodiesel Distribution Capital Costs

The facility upgrades that we project would be needed at petroleum terminals to facilitate the distribution of the increased volume of biodiesel in response to the RFS2 standards are discussed in Section 1.6.9 of this DRIA. Total capital costs at terminals by 2022 relative to the BGY 2022 reference case are estimated at 321 million dollars.

^{XXXXXXXXXX} The projected shorter transportation distances on average for biodiesel compared to ethanol resulted in a lower per gallon freight cost for biodiesel compared to ethanol (11.3 cpg).

As discussed in Section 1.6.9 of this DRIA, we estimate that a total of 1.84 million barrels of new biodiesel storage would be needed at petroleum terminals due to the RFS2 standards, all of which would need to be satisfied by new construction. Based on information from industry with respect to the effect of increased steel prices on storage tanks costs, we estimate that the cost of constructing new biodiesel storage tanks would be 70 dollars per barrel. This is considerably higher than the 40 per barrel cost we estimated for construction of new ethanol tanks for two reasons. Biodiesel tanks need to be heated/insulated in colder climates. Biodiesel tanks tend to be of considerably smaller size compared to ethanol tanks. Both of these factors contribute significantly to the cost per barrel of constructing a new storage tank. We estimate that the total cost at petroleum terminals of new biodiesel storage tanks would be 129 million dollars.

As discussed in Section 1.6.9 of this DRIA, we projected that 200 terminals would need to install biodiesel blending equipment by 2022 as a result of the RFS2 standards (relative to the 380 MGY 2022 reference case). Based on input from industry, we estimated that the cost of biodiesel blending equipment would be 400 thousand dollars per terminal. The cost of additional piping is estimated at 60,000 per terminal. Miscellaneous costs associated with receiving/blending/storing biodiesel for the first time are estimated at 500 thousand dollars per terminal. Estimated equipment costs for handling biodiesel are higher than those for similar equipment designed to handle ethanol due to the need for insulated/heated equipment in colder climates.

Summing all of these estimated costs, we arrived at an estimate of the total cost for the biodiesel blending, storage, and other miscellaneous equipment that would be needed at petroleum terminals as a result of the RFS2 standards by 2022 of 321.1 million dollars. These costs were amortized over 15 years at a 7% annual cost of capital to derive the cents-per-gallon distribution capital cost estimate in Section 4.2.2 of this DRIA.

4.2.1.1.3 Biodiesel Rail Car Capital Costs

As discussed in Section 1.6.3 of this DRIA, we estimate that an additional 353 biodiesel tank cars would be needed by 2022 to transport the additional volume of ethanol that we project would be used to meet the RFS2 standards (relative to the 380 MGY 2022 reference case). Based on input from industry, we estimate that the cost of a new biodiesel tank car of 25,600 gallon capacity at 99,000 dollars. The estimated cost for a biodiesel rail car is 10% higher than that of an ethanol rail car to accommodate the need for insulated/heated tanks in colder climates. Thus, we estimate that the total cost of the biodiesel rail tanks cars needed due to the RFS2 standards by 2022 would be 35 million dollars. These costs were amortized over 15 years at a 7% annual cost of capital to derive the cents-per-gallon distribution capital cost estimate in Section 4.2.2 of this DRIA.

4.2.1.1.4 Biodiesel Barge Capital Costs

As discussed in Section 1.6.4, we estimate that an additional 11 10,000 barrel capacity barges would be needed by 2022 to transport the additional volume of biodiesel that we project would be used to meet the RFS2 standards (relative to the 380 MGY 2022 reference case).

Based on input from industry, we estimate that the cost of a new 10,000 barrel barge capable of transporting biodiesel at 1.54 million dollars. This estimated cost is 10% higher than the cost of a barge designed to transport ethanol due to the need for an insulated/heated tank in colder climates. Thus, we estimate that the total cost of barges needed to transport biodiesel due to the RFS2 standards by 2022 would be 16.6 million dollars. These costs were amortized over 15 years at a 7% annual cost of capital to derive the cents-per-gallon distribution capital cost estimate in Section 4.2.2 of this DRIA.

While the tank barge industry is trending towards the use of tank barges with a carrying capacity of 30,000 barrels (which tend to be less expensive on a per-barrel basis than 10,000 barrel capacity barges), we believe the assumed use of 10,000 barrel barges is appropriate for biodiesel transport due to the relatively smaller volumes of biodiesel that we project would be used.

4.2.1.1.5 Biodiesel Tank Truck Capital Costs

As discussed in Section 1.6.5 of this DRIA, we estimate that an additional 1,241 8,000 gallon capacity tank trucks would be needed by 2022 to transport the additional volume of biodiesel that we project would be used to meet the RFS2 standards (relative to the 380 MGY 2022 reference case). Based on input from industry, we estimate that the cost of a new 8,000 gallon tank truck capable of transporting biodiesel at 198 thousand dollars. This is based on an 110,000 dollar cost for the tractor and an 88,000 thousand dollar cost for the tank trailer. This estimate is 25% higher than the cost of a tank trailer designed to transport ethanol due to the need for an insulated/heated tank in colder climates. Thus, we estimate that the total cost of tank trucks needed to transport biodiesel due to the RFS2 standards by 2022 would be 7.8 million dollars. These costs were amortized over 10 years at a 7% annual cost of capital to derive the cents-per-gallon distribution capital cost estimate in Section 4.2.2 of this DRIA. We used a 10 year amortization schedule for tank trucks as opposed to the 15 year schedule used for other capital equipment to reflect their likely shorter service life.

4.2.2.2 Biodiesel Freight Costs

The distribution of biodiesel from production plants to petroleum terminals where it would be blended with diesel fuel is discussed in Section 1.6.3 of the DRIA. Tank truck was the assumed method of shipment for distances of less than 300 miles. Where distances are beyond 300 miles, shipment by manifest rail was assumed to be the preferred option other than in cases on the East coast where there were apparent barge routes from production to demand centers. In no case was it assumed that biodiesel would need to be shipped by multiple modes prior to delivery at the petroleum terminal.

Our estimation of biodiesel freight costs is based on our evaluation of where biodiesel would be produced and where it would be used under the RFS2 standards. Section 1.5 of this DRIA contains a discussion of our projections regarding where biodiesel would be produced to satisfy the RFS2 requirements. Section 1.7 of this DRIA contains a discussion of where we project biodiesel would be used under the proposed RFS2 program. Demand for biodiesel in each state was established based on current and anticipated future state biodiesel mandates and

the anticipated demand for 2% biodiesel in most heating oil used in the Northeast by 2022.^{YYYYYYYY} Production volumes from each plant were assigned to meet these demands based on minimizing overall distribution distances (and cost). The production volume that was not consumed in meeting the anticipated demand from state mandates and to meet heating oil demand was assumed to be used within trucking distance of the production plant to the extent possible while maintaining biodiesel blend concentrations below 5%. This may tend to result in a conservatively high estimate of biodiesel freight costs since biodiesel blend levels could exceed 5% in some areas. The remaining volume needed to match our estimated production volume was assumed to be shipped via manifest rail car or barge to the nearest areas where diesel fuel use was not already saturated with biodiesel to the 5% level. A 1,000 mile shipping distance was selected to ensure that all biodiesel not used to satisfy a state mandate, otherwise used in state, or used for bio-heat could find a market. It is likely that some fraction would not need to travel quite at far. Therefore, this assumption is also likely to result in a conservatively high estimate of biodiesel freight costs.

Our estimates of the freight costs for shipping biodiesel by tank truck are based on the ethanol tank truck freight costs that we developed for the RFS1 final rule.^{ZZZZZZZZ} These ethanol transport costs were increased by 10% to account for the increased cost associated with preventing fuel gelling during cold conditions. The cost of shipping biodiesel by truck when the trip (or multiple trips) could be completed in a day was estimated to range from 7 to 8 cents per gallon. Some long truck transports were assumed to be necessary (up to 300 miles), where a round trip could not be completed in a single day. In such cases, the need for an overnight layover was assumed to add 120 dollars to shipping costs, resulting in an estimated 9.5 cents per gallon freight cost.

Our estimate of the cost of shipping biodiesel by manifest rail cars is based on publicly available biodiesel freight tariff information from BNSF railway from February 2008.⁹²⁷ We used the BNSF fuel surcharge schedule to adjust our freight cost estimates to match our 53 per barrel of crude scenario. Specific tariff information was not available for source/destinations needed for our analysis. A minimum cost of 9 cents per gallon was assumed to accommodate loading, unloading, and rail car lease costs. Based on the BNSF tariff information, we estimated that every 100 miles of additional shipment by manifest rail car beyond 600 miles adds 1.4 cents per gallon to shipping cost. Thus, for the assumed 1,000 mile shipping distance for biodiesel used to meet miscellaneous demand (i.e. not used to meet state mandates or for bioheat) the cost to ship by manifest rail car was estimated at 15 cents per gallon. Barge shipping costs were assumed to be comparable to the cost of shipping by manifest rail. This will tend to overstate barge shipping costs, since we understand that barge freight costs tend to be significantly less than rail freight costs. However, given that only 1% of biodiesel is projected to be moved by barge, this will have only a minimal effect on our overall estimation of biodiesel freight costs. We intend to seek out additional information regarding the cost of shipping biodiesel by barge over the routes we have identified so that we can update our biodiesel freight cost estimate for the final rule. Shipping distances were estimated based on a review of biodiesel production plant locations, demand centers, and the rail/barge transportation net.

^{YYYYYYYY} When biodiesel is blending into heating oil, the product is commonly referred to as bioheat.
^{ZZZZZZZZ} See Section 4.2.1.2 of this DRIA.

Similar to the situation regarding our estimation of ethanol freight costs, we were not able to satisfactorily adjust our freight cost estimates across all modes in order to estimate biodiesel freight costs under the 92 per barrel crude cost scenario used in other parts of our analysis. We intend to pursue this analysis further so that we can provide an estimate of the impact on biodiesel freight costs of changes in transportation fuel costs in the final rule.

Due to the favorable match up in the location of biodiesel plants and biodiesel demand centers, 86% of biodiesel was projected to be shipped by truck, 13% was estimated to be shipped by manifest rail car, and 1% was estimated to be shipped by barge. We project that approximately 44% of the biodiesel production volume in 2022 would be used in the state where it was produced to meet state mandates, satisfy the demand for bioheat, or to meet other in-state miscellaneous demand. The average cost of shipping this volume by tank truck is estimated to average 8 cents per gallon. Approximately 3% of biodiesel production volume is estimated to be shipped out-of-state by manifest rail car to meet miscellaneous biodiesel demand at an average freight cost of 15 cents per gallon.

Approximately 54% of biodiesel production is projected to be shipped out of state to satisfy state mandates or bioheat demand which could not be satisfied with in-state production. We assigned portions of the production volumes from states that had already satisfied this demand to meet this demand in other states based on minimizing overall shipping distances (and costs). A freight cost estimate was derived for each source and destination pair based on the fraction of the volumes that would be shipped by each mode and the freight cost for each mode used given the shipping distance. On average the cost of shipping biodiesel from out-of-state to satisfy state biodiesel mandates or the demand for bioheat is estimated at 10 cents per gallon. By weighting the biodiesel volumes used to satisfy the three demand categories by the respective freight cost to ship that volume we arrived at a national average biodiesel freight cost estimate of 9.3 cents per gallon. Biodiesel freight costs are summarized in Table 4.2-8.

**Table 4.2-8.
Estimated Biodiesel Freight Costs**

Biodiesel Demand Category	Fraction of Biodiesel Production	Freight Cost (cpg)
Shipped In-State to Satisfy In-State Demand	43%	8
Shipped Out-of-State to Satisfy State Mandates and Demand for Bioheat	54%	10
Shipped Out-of-State to Satisfy Miscellaneous Demand	3%	15
Total (National Average)	100%	9.3

4.2.3 Renewable Diesel Distribution Costs

As discussed in Section 1.6.1.3, there are comparatively few additional costs associated with distributing renewable diesel fuel because the majority is projected to be produced at petroleum refineries and it can be shipped fungibly with petroleum-based diesel fuel. As discussed in Section 1.6.5 of this DRIA, we estimate that 8 additional 8,000 gallon capacity tank trucks would be needed by 2022 to transport the additional volume of renewable diesel fuel that

we project would be used to meet the RFS2 standards from stand-alone production facilities to petroleum terminals (relative to the 0 MGY 2022 reference case). Based on input from industry, we estimate that the cost of a new 8,000 gallon tank truck capable of transporting renewable diesel fuel at 180 thousand dollars. This is based on a 110 thousand dollar cost for the tractor and 70 thousand dollar cost for the tank trailer. Thus, we estimate that the total cost of tank trucks needed to transport renewable diesel fuel due to the RFS2 standards by 2022 would be 1.3 million dollars. These costs were amortized over 10 years at a 7% annual cost of capital. This translates to 0.2 cents per gallon of the renewable diesel that would be produced at stand-alone facilities and hence need to be transported separately (125 million gallons by 2022). We used a 10 year amortization schedule for tank trucks as opposed to the 15 year schedule used for other capital equipment to reflect their likely shorter service life.

As discussed in Section 1.6.4 of this DRIA, we estimate that renewable diesel fuel which does need to be transported separately from petroleum-based diesel fuel (because it is produced at stand-alone facilities not located at a refinery) would be shipped by tank truck to a terminal facility where it would be blended directly with diesel fuel. The freight cost for this truck transport is estimated at 5 cents per gallon. Thus, the total cost of distributing renewable diesel fuel is estimated at 5.2 cents per gallon, and this only applies to the renewable diesel that would be produced at stand-alone facilities.

As noted previously, we choose not to subtract the distribution costs for the petroleum-based fuels that would be displaced by the use of biofuels from our estimated biofuel distribution costs to help ensure a conservatively high estimate of biofuel distribution costs given the uncertainties in our analysis. We believe that the freight costs to ship petroleum-based fuels to the terminal are approximately 4 cents per gallon. If we were to subtract these costs from the estimated renewable diesel distribution costs, the result would be 1.2 cents per gallon.

4.2.4 Potential Fuel Retailer Costs to Facilitate the Use of Mid-Level Ethanol Blends

The potential changes that may be needed to the fuel distribution system to facilitate the introduction of mid-level ethanol blends are discussed in Section 1.6.11 of this DRIA. As discussed in Section 1.6.11, investigations are currently underway to evaluate the compatibility of existing retail fuel storage and dispensing equipment with Mid-level ethanol blends. If such equipment is found to be compatible or to require only modest modification to accommodate mid-level ethanol blends, then the costs could be small. Even if some pieces of the above ground equipment are found to be incompatible with mid-level ethanol blends, it may be possible to replace such equipment through normal attrition. For example, the “hanging hardware” on a fuel dispenser has a normal service life of only 3 to 5 years. Other components have longer service lives. The pump dispenser has an average service life of 20 years, with up-scale marketers replacing their dispensers more frequently and lower tier marketers retaining their dispensers for as long as 40 years. Storage tank systems have a service life of approximately 40 years. Thus, depending on the type of equipment that might need to be replaced, waiting for its replacement through normal attrition could delay the widespread introduction of mid-level ethanol blends.

If the extensive changes are needed, and particularly if concrete needs to be broken, the cost to introduce mid-level ethanol blends at retail could potential be large. To provide an upper

bound on the potential, we used cost estimates that we compiled for E85 capable equipment. It may be possible that even if current equipment needs to be replaced in order to accommodate mid-level ethanol blends, that such equipment might not need to be manufactured to the specifications necessary to be E85 capable. If this were the case, the costs of such equipment may be lower than comparable E85-capable equipment.

We estimate that the cost of replacing the fuel-wetted components of a fuel dispenser with E85-capable equipment to be as much as \$12,000 per dispenser. This includes the cost of the hanging hardware (at \$750 for 2 nozzles, hoses, and break-away connections), the cost of the dispenser's "hydraulic tree" (at \$10,000), and installation costs (\$1,250).^{AAAAAAAAA} Based on gasoline retailer survey data, we estimate that there is average of 3.9 gasoline dispensers at each gasoline retail facilities.⁹²⁸ It was estimated that in 2007 there were 164, 292 gasoline retail facilities in the U.S.⁹²⁹ Thus, we estimate that the cost of retrofitting all 641,000 gasoline pumps at \$7.7 billion. The cost would be considerably higher if the complete underground storage tank would need to be replaced. The cost of replacing an existing storage tank is estimated at \$84,000. Thus, the cost of replacing a single tank at each retail facility would result in an additional cost of \$13.8 billion for a total cost of \$21.5 billion. Many retail facilities have multiple storage tanks in order to keep pace with fuel sales. The replacement of such storage tanks would further increase the potential cost.

The introduction of a mid-level ethanol blend would not eliminate the need for the use of additional E85 (and additional E85 refueling facilities) to facilitate the consumption of the projected ethanol volumes needed to comply with the RFS2 standards.^{BBBBBBBBB} However, it could delay and to some extent reduce the need for additional E85 refueling facilities. To evaluate the potential effect on costs of the reduced need for additional refueling facilities that might result from the introduction of a mid-level ethanol blend, we evaluated a scenario where reasonable access to E85 would only be needed in 50% of the nation. Under our primary E85 retail facility case, we assumed that reasonable access to E85 would be needed in 70% of the country, and that 40% of new E85 facilities have 2 E85 pumps and the remainder would have 1 E85 pump.^{CCCCCCCCC} If we were to assume that to reasonable E85 availability in 50% of the nation while maintaining the same assumptions regarding the number of pumps per facility, the total cost of new E85 refueling facilities would be 2 billion dollars. This is approximately one billion dollars less than under our primary case where reasonable access is assumed to be needed in 70% of the country.

We evaluated a sensitivity case from our primary E85 retail facility cost estimate under which it was assumed that 3 pumps would be needed at each E85 retail facility to maintain the needed E85 throughput. Under this sensitivity case, if we to assume that reasonable E85 availability would only be needed in 50% of the country, the total cost of additional E85 refueling facilities needed due to the RFS2 standards would be reduced by approximately 1.4 billion dollars.

^{AAAAAAAAA} The shell of fuel dispenser and the electronic components would remain unchanged.
^{BBBBBBBBB} A discussion of the projected ethanol use levels under the RFS2 standards is discussed in Section 1.7.2 of this DRIA.
^{CCCCCCCCC} See Section 4.2.1.1.6 of this DRIA for a discussion of E85 retail facility costs under the RFS2 program.

4.3 Reduced Refining Industry Costs

As renewable and alternative fuel use increases, the volume of petroleum-based products, such as gasoline and diesel fuel, would decrease. This reduction in finished refinery petroleum products is associated with a reduction in refinery industry costs. This cost reduction would essentially be the volume of fuel displaced multiplied by the cost for producing the fuel. There is also a reduction in capital costs which is important because by not investing in new refinery capital, more resources are freed up to build plants that produce renewable and alternative fuels.

Although we conducted refinery modeling for estimating the cost of blending ethanol, we did not rely on the refinery model results for estimating the volume of displaced petroleum. Instead we conducted an energy balance around the increased use of renewable fuels, estimating the energy-equivalent volume of gasoline or diesel fuel displaced. This allowed us to more easily apply our best estimates for how much of the petroleum would displace imports of finished products versus crude oil for our energy security analysis which is discussed in Chapter 15 of the DRIA.

As part of this analysis we accounted for the change in petroleum demanded by upstream processes related to additional production of the renewable fuels as well as reduced production of petroleum fuels. For example, growing corn used for ethanol production requires the use of diesel fuel in tractors, which reduces the volume of petroleum displaced by the ethanol. Similarly, the refining of crude oil uses by-product hydrocarbons for heating within the refinery, therefore the overall effect of reduced gasoline and diesel fuel consumption is actually greater because of the additional upstream effect. We used the lifecycle petroleum demand estimates provided for in GREET model to account for the upstream consumption of petroleum for each of the renewable and alternative fuels, as well as for gasoline and diesel fuel. Although there may be some renewable fuel used for upstream energy, we assumed that this entire volume is petroleum because the volume of renewable and alternative fuels is fixed as described in Chapter 1 above.

For this proposed rule, we assumed that a portion of the gasoline displaced by ethanol is imported, while the other portion is produced from domestic refineries. The assumption we made is that one half of the ethanol market in the Northeast, which comprises about half of the nation's gasoline demand, would displace imported gasoline or gasoline blend stocks. Therefore, to derive the portion of the new renewable fuels which would offset imports (and not impact domestic refinery production), we multiplied the total volume of petroleum gasoline displaced by 50 percent to represent that portion of the ethanol which would be used in the Northeast, and 50 percent again to only account for that which would offset imports. The rest of the ethanol, including half of the ethanol presumed to be used in the Northeast, is presumed to offset domestic gasoline production. In the case of biodiesel and renewable diesel, all of it is presumed to offset domestic diesel fuel production. For ethanol, biodiesel and renewable diesel, the amount of petroleum fuel displaced is estimated based on the relative energy contents of the renewable fuels to the fuels which they are displacing. The savings due to lower imported gasoline and diesel fuel is accounted for in the energy security analysis contained in Chapter 15.

For estimating the reduced U.S. refinery costs, we multiplied the estimated volume of domestic gasoline and diesel fuel displaced by the wholesale price for each of these fuels, which are \$1.57 per gallon for gasoline, and \$1.61 per gallon for diesel fuel at \$53/bbl crude oil, and \$2.67 per gallon for gasoline, and \$3.35 per gallon for diesel fuel at \$92/bbl crude oil. For the volume of petroleum displaced upstream, we valued it using the wholesale diesel fuel price. Table 4.3-1 shows the net volumetric impact on the petroleum portion of gasoline and diesel fuel demand, as well as the reduced refining costs for 2022.

Table 4.3-1. U.S. Refinery Cost Reduction for the RFS2 Fuel Program in 2022

		Total Volume Displaced (billion gallons)	Refining Cost Reduction at \$53/bbl crude oil price (billion dollars)	Refining Cost Reduction at \$92/bbl crude oil price (billion dollars)
Upstream	Petroleum	-0.8	-\$1.3	-\$2.7
End Use	Gasoline	10.4	\$16.3	\$27.7
	Diesel Fuel	0.6	\$0.9	\$1.9
	Total	-	\$15.9	\$26.9

4.4 Overall Costs to Gasoline and Diesel Fuel

The previous sections of this chapter have presented estimates of the cost of producing and distributing ethanol, biodiesel and renewable diesel fuel. In this section, we summarize the results of refinery modeling conducted by Jacobs Consultancy under contract to EPA for using those biofuels.⁹³⁰ Jacobs's used the Haverly Linear Programming (LP) model to conduct the analysis. This model is widely used by the refining industry, consultants, engineering firms and government agencies to analyze refinery economics, refinery operations, fuel quality changes, refinery capital investments, environmental changes and demand changes. The Haverly model uses Jacobs's Refining Process Technology Database to represent refining operations.

The modeling was conducted to analyze the effect of the increased renewable fuel use on the production costs and composition of the nation's gasoline and diesel fuel. The refinery modeling output described in this section includes the changes in volumes and capital investments as well as the resulting capital and fixed operating costs, the variable costs, and the total of all these costs. Because of the significant increase in crude oil prices in mid-2008, we estimated the costs of this program at two different crude oil prices. The low price is \$53/bbl which represents the reference crude oil price estimated by the Energy Information Administration (EIA) for its 2008 Annual Energy Outlook (AEO).⁹³¹ The high price is \$92/bbl which represents the high crude oil price estimated by EIA for its 2008 AEO. We describe the methodology for adjusting the cost of the RFS2 standard further below in the methodology section.

4.4.1 Description of Refinery Modeling Cases Modeled and Methodology

The refinery modeling was set up to analyze the volumes required by the RFS as described in Chapter 1. The primary renewable fuel modeled was ethanol in gasoline, and we considered a small amount of biodiesel and renewable diesel as required under EISA. While the addition of ethanol was modeled with the refinery model to capture the blending costs of using a large amount of additional ethanol, the projected additional volume of biodiesel and renewable diesel was not captured by the refinery model. Instead, the blending of biodiesel and renewable diesel was captured outside the refinery model, although we modeled a slightly lower the energy-equivalent volume of diesel fuel based on the addition of the biodiesel and renewable diesel volume.

Jacobs conducted a Linear Programming modeling analysis of the refining industry for the various RFS scenarios using a model developed by Haverly's LP technology. The modeling was set up to analyze the extent to which ethanol will be used in conventional gasoline and reformulated gasoline by region and the resulting effects on gasoline composition. The refining industry was modeled based on five aggregate complex refining regions, representing Petroleum Administration for Defense Districts (PADD) 1, 2, 3, 4 & 5 together minus California, and California separately. All of the PADDs were modeled simultaneously together in the LP model which allowed the refinery model to most efficiently rebalance the regional gasoline production volumes in response to the addition of the renewable fuels.

The refinery modeling was conducted in three distinct steps which involved a base case, a reference case and a control case.

4.4.1.1 Base Case

The first step involved the establishment of a 2004 base case which calibrated the refinery model against 2004 volumes, gasoline quality, and refinery capital in place. We chose 2004 because the following year, 2005, as well as the beginning of 2006, were affected by hurricanes and would not be representative of a typical year, and 2007 data was not yet available when we started the analysis. Refinery unit capacities from the Oil and Gas Journal and Energy Information Administration (EIA), as well as refinery feedstock and product volumes from EIA data were entered into the refinery model. The refinery model was then run and the resulting gasoline quality compared and calibrated to actual gasoline quality data information from EPA's Reformulated Gasoline data base.

4.4.1.2 Reference Case

The reference case is a business-as-usual case that serves as a reference to the control cases. Thus, the year of analysis for the reference case must be the same as that used for control cases. Because the RFS2 fuel standard becomes fully implemented in 2022, we conducted our reference and control cases analysis in 2022. Two categories of adjustments were made to the base case refinery models to enable modeling the refining industry in 2022 for the reference case. First, the change in certain inputs assumptions such as product volumes and energy prices needed to be projected. U.S. refinery gasoline, diesel fuel and jet fuel demand were projected to grow to meet increased demand. These projected volumes were used for establishing finished product which then led to refinery production for each PADD to meet that increased demand.

This projected growth in U.S. refinery production is entered into the reference case version of the LP refinery model.

The refinery modeling was conducted using the projection of crude oil and product prices in 2022. Crude and other input prices were based on Jacobs’ projection of refinery margins and crude prices in 2022 cases, which was also based on the historical price spreads of fuels between the PADDs, using information from EIA’s 2004 price information tables, Platts, and AEO 2006. The average price of crude oil was projected to be about \$51 per barrel, although crude oil prices varied by PADD. For the reference case as well as for the control cases, we assumed the same crude oil and product prices. The crude oil prices and summertime and wintertime prices for gasoline, diesel fuel and jet fuel are summarized in Table 4.4-1.

Table 4.4-1. Crude Oil and Finished Product Prices used in Refinery Modeling

		PADD 1	PADD 2	PADD 3	PADD 4/5 CA excl.	California
Crude Oil (\$/bbl)	Year-round Average	53.6	53.0	50.6	51.8	50.2
Reformulated Gasoline (c/gal)	Summer	175.2	173.5	170.8	-	186.7
	Winter	161.4	158.7	155.3	-	173.7
Conventional Gasoline (c/gal)	Summer	167.6	165.1	161.4	173.6	-
	Winter	154.0	151.8	148.5	160.4	-
Diesel Fuel (c/gal)	Summer	156.6	157.6	154.6	166.6	164.6
	Winter	162.6	163.6	160.6	172.6	170.6
Jet Fuel (c/gal)	Summer	158.6	158.6	156.6	164.6	164.6
	Winter	156.6	156.6	154.6	162.6	162.6

We also modeled the implementation of several new environmental programs that will have required changes in fuel quality by 2022, including the 30 ppm average gasoline sulfur standard, the 15 ppm cap standards on highway and nonroad diesel fuel, the Mobile Source Air Toxics (MSAT) 0.62 volume percent benzene standard. Although there may still be a small amount high sulfur diesel fuel, we assumed that all distillate fuel would be ultra low sulfur in compliance with the 15 ppm cap standard. We modeled the implementation of the 2005 Energy bill, which by rescinding the RFG oxygenate standard, resulted in the discontinued use of MTBE, and a large increase in the amount of ethanol blended into reformulated gasoline. We modeled 13.2 billion gallons of ethanol in the gasoline pool (starch ethanol, cellulosic ethanol and sugar ethanol) and 0.3 billion gallons of biodiesel and renewable diesel fuel in the diesel pool for 2022, which is the “business-as-usual” volume as projected by AEO 2007.⁹³² However, we assessed the growth in energy demand using AEO 2008 which modeled the EISA Corporate Average Fuel Economy (CAFE) standards in the reference case because it will be phasing-in in parallel with the phase-in of the RFS2.⁹³³ For the reference case, the refinery model blended the ethanol as E10 as the refinery model did not find it economical to blend any ethanol as E85 (Although the refinery modeling did not capture today’s small volume of E85 in the reference

case, not capturing this volume does not appreciably impact the results of the refinery modeling.).

4.4.1.3 Control Case

The third step, or the control case, involved the modeling of the 34 billion gallons of ethanol and 1 billion gallons of biodiesel and renewable diesel to comply with the RFS requirements in 2022 when the proposed renewable fuels program is fully phased-in. The cost and other implications of this fully phased-in control case are compared to the reference case to assess the cost of the program. We also modeled two other cases which served as sensitivities to our primary control case. The first is a 100 percent E10 case which modeled the saturation of the gasoline pool with 10 percent ethanol, but did not require additional volumes of ethanol that would force the use of E85. The second case required the same volumes of renewable fuels as our primary control case, except that ethanol was allowed to be blended at 20 percent. We ran these sensitivity cases to isolate aspects of the primary control case. We ran the E10 case to isolate the effects of E10 blending from that of E85 on gasoline fuel properties and costs. We ran the mid-ethanol blend sensitivity case to assess what might happen to gasoline fuel properties and costs if a waiver were to be granted for mid-ethanol blends as some have suggested. These cases are summarized below at the end of this section.

The principal change in renewable fuel volumes modeled, relative to the reference case, was a large increase in ethanol blended into gasoline. Table 4.4-2 below summarizes the volume of biofuels estimated to be used in the year 2022 for the reference case and the control case.
DDDDDDDDDD

Table 4.4-2.
Summary of Reference and Control Case Volumes in 2022
(billion gallons)

	Reference Case	Control Case	Difference
Corn Ethanol	12.3	15	2.7
Cellulosic Ethanol	0.2	16	15.8
Imported Ethanol	0.4	3.1	0.27
Biodiesel	0.27	0.70	0.43
Renewable Diesel	0	0.19	0.19
Total	13.5	36	22.5

The gasoline and diesel fuel product energy output for each control and sensitivity case modeled was maintained the same as that for the reference case. Maintaining constant energy output assumes that vehicle miles traveled would remain the same between the various cases despite any change in gasoline and diesel fuel prices caused by the use of renewable fuels. In reality the increased use of renewable fuels may result in changes to fuel prices to consumers, either directly as estimated in this section, or indirectly by affecting world oil prices as discussed in Chapter 15. However, our analysis was conducted in parallel without the ability to input the

DDDDDDDDDD The renewable fuels cost modeling assessed the impact of biodiesel fuel costs not including 0.11 billion gallons of corn oil made into biodiesel fuel, which is included in the volumes summary shown in Tables 1.2-1.

results of the other analysis. Furthermore, it is difficult to predict the impacts on fuel prices to consumers, especially in light of the federal tax subsidies which we accounted for in our analysis, and the many and diverse state tax subsidies which we did not attempt to account for. Maintaining constant fuel product energy output captures the capital cost differences between the cases. Table 4.4-3 below summarizes the volumes of gasoline and diesel fuel used for the reference case, the primary control case and two sensitivity cases.^{EEEEEEEEEE}

**Table 4.4-3.
Volumes of Gasoline and Diesel Fuel Used in Refinery Modeling
(Billion Gallons/yr)**

	Reference Case	Primary Control Case	Sensitivity Cases	
	13.2 Bgals Ethanol as E10	35 Bgals of E10 & E85	E10	35 Bgals of E10, E20 & E85
Gasoline Volume (Gasoline and Ethanol)	169.3	176.7	171.4	176.7
Diesel Volume (Diesel Only)	69.3	68.5	68.5	68.5

All the other environmental and ASTM fuel quality constraints modeled in the reference case described above are assumed to apply to the control case as well. The reference and control cases were modeled assuming that ethanol CG blends are entitled to the current 1.0 psi RVP waiver during the summer (i.e., for all 9.0 RVP and many low RVP control programs) so as to assess the impact on summertime butane removal. The crude oil and product prices for the control case were the same as the reference case. The capital investments made for the reference case are not assumed to be sunk when the refinery model is assessing the economics for capital investments for the various control cases. Thus, the refinery model is free to optimize the capital investments made for each control case incremental to the base case. The control cases are run with capital costs evaluated at a 15 percent rate of return on investment (ROI) after taxes, but are then adjusted post-modeling to a 7 percent ROI before taxes.

4.4.1.4 Ethanol Blending and Prices

A special procedure was set up in the refinery model to capture the costs of blending ethanol. Because ethanol is primarily produced in the Midwest, but distributed to the final terminals where it is blended with the gasoline (or gasoline blendstock for blending with ethanol), hypothetical terminals were set up in each PADD within the refinery model which would receive the shipped ethanol as well as the gasoline blendstock for blending with ethanol

^{EEEEEEEEEE} The refinery modeling was run assuming about 20 billion gallons more gasoline demand and 8 billion gallons more diesel fuel demand than what AEO 2008 projects for the year 2022. This probably had only a very minor impact on the relative costs of the control cases compared to the reference case because the relative volume differences between the cases (considering the additions of renewable fuels) were modeled as intended. The actual AEO 2008 gasoline and diesel fuel volumes were used as the basis to estimate the per-gallon costs.

(also referred to as conventional blendstock for oxygenate blending (CBOB) for conventional gasoline and reformulated blendstock for oxygenate blending (RBOB) for RFG and CARFG). The gasoline blendstock either comes from the same PADD where the terminal is located, or transferred from a different PADD. This refinery modeling technique helps to more correctly estimate the distribution costs for both the ethanol and the gasoline. The refinery model assessed ethanol's use in each PADD based on its price relative to CG and RFG, which is based on its production cost and distribution costs, and its blending economics. For the base case we assumed that ethanol would be splash blended into gasoline. But by 2022 we expect that most, if not all, of the ethanol will be octane match-blended for blending up E10.

The price of ethanol used in the reference case, the primary control case and the sensitivity cases was based on the 2004 yearly average price spread between regular conventional gasoline sold into the spot market in Houston and ethanol sold on the spot market on Chicago Board of Trade (CBOT). This was used to determine a Midwest ethanol production price. To derive ethanol prices for all other PADDs outside the Midwest, the Midwest ethanol production price was then adjusted for transportation costs to deliver ethanol from the Midwest to end use terminals (see Section 4.2 for additional details). This assumes that the Midwest ethanol market will continue to set the price for ethanol – a reasonable assumption considering the significant amount of corn and other biomass available in the Midwest. The sales prices assigned to ethanol are summarized in Table 4.4-4.

Table 4.4-4. Ethanol Prices used in Refinery Modeling

	PADD 1	PADD 2	PADD 3	PADD 4/5 CA excl.	California
Summer	159.9	153.3	163.2	168.3	168.5
Winter	152.5	145.9	155.8	160.9	161.1

After the refinery modeling was completed, the ethanol prices and the costs for each case were adjusted to reflect the ethanol production and distribution costs described above in Sections 4.1 and 4.2. The ethanol production cost is the volume-weighted average for ethanol sourced from corn, cellulose and imports. The combined ethanol production cost and combined biodiesel and renewable diesel costs for 2022 for the reference crude oil price and the high crude oil price scenarios are shown in Table 4.4-5. The biodiesel and renewable diesel fuel production costs are principally comprised of the feedstock costs from the FASOM agricultural model, and this model estimated lower feedstock costs at the higher crude oil price. While this outcome initially seems unlikely, it could be possible based on changes in production levels of some agricultural products, so we opted to use the FASOM feedstock costs and the lower production costs at the higher crude oil price.

**Table 4.4-5.
Average Production Cost for Ethanol, Biodiesel and Renewable Diesel Fuel**

Crude Oil Price	\$53/bbl	\$92/bbl	
	Production Cost (c/gal)	Production Cost (c/gal)	Volumetric Fraction
Corn Ethanol	147	154	0.13
Cellulosic Ethanol	138	143	0.75
Imported Ethanol	169	171	0.12
Volume Weighted Cost	143	148	1.00
Biodiesel	270	268	0.69
Renewable Diesel Fuel	210	208	0.31
Volume Weighted Cost	251	249	1.00

The combined ethanol production and distribution costs and the biodiesel and renewable diesel production and distribution costs are summarized below in Table 4.4-6. We provided two sets of costs which represent the projected costs at the \$53/bbl crude oil price and at the \$92/bbl crude oil price.

Table 4.4-6. Ethanol Costs used in the Cost Analysis Post-Refinery Modeling

	Ethanol Costs					Biodiesel	Renewable Diesel
Region	PADD 1	PADD 2	PADD 3	PADD 4/5 excl. CA	CA	U.S.	U.S.
	\$53/bbl Crude Oil Price						
Production Cost	143	143	143	143	143	270	210
Distribution Cost	19.4	12.1	17.5	23.6	23.4	18.2	5.1
Total Cost	162.4	155.1	160.5	166.6	166.4	288.2	215.1
	\$92/bbl Crude Oil Price						
Production Cost	148	148	148	148	148	268	208
Distribution Cost	21.3	13.3	19.3	26.0	25.7	20	5.6
Total Cost	169.3	161.3	167.3	174	173.7	288.0	213.6

The ethanol production and distribution costs summarized in Table 4.4-6 are different in value compared to the ethanol prices used in the refinery modeling summarized above in Table 4.4-4. To capture the social costs of the RFS 2 program, we adjusted the initial costs of the refinery modeling cost analysis using the ethanol production and distribution costs. This cost adjustment was made by multiplying the difference in ethanol cost or price between Tables 4.4-6 and 4.4-4 by the difference in ethanol volume modeled between the control case and the reference case.

We also estimated the costs of the RFS 2 program taking into account the consumption

subsidies for corn ethanol, cellulosic ethanol, biodiesel and renewable diesel fuel. While these subsidies conceal large portions of the program costs, their economic effects deserve to be understood.

4.4.1.5 E85 Blending and Prices

We conducted the refinery modeling assuming that E85 will be blended differently in the future compared to how it is blended today. Today E85 is blended at 85 percent by volume in the summer and at 70 percent by volume in the winter. Ethanol must be blended at less than 85 percent in the winter because of ethanol’s low blending Reid Vapor Pressure (RVP). Unlike when ethanol is blended at 10 percent and causes a large vapor pressure increase, when ethanol is blended at 85 percent it blends much closer to its very low neat blending RVP of 2.2. When ethanol is blended with gasoline at the terminal, the available gasoline blendstock must be used. This blendstock is either a conventional blendstock for oxygenate blending (CBOB) or reformulated blendstock for oxygenate blending (RBOB) so that when this gasoline-like material blended with ethanol at 10 percent, the final blend complies with the local gasoline regulations. For example, reformulated gasoline (RFG) must comply with the hydrocarbon standard of the RFG program and therefore RFG tends to have an RVP of 6.8, and the RBOB that is blended with ethanol has an RVP of about 5.8. When this 5.8 RVP RBOB is blended with ethanol to make E85, its final RVP is estimated to be 5.05. However, the RVP minimum specified in the E85 ASTM standard shows the summertime lower limit of E85 is 5.5, thus, blending RBOB with 85 percent ethanol would not comply with the ASTM lower RVP standard. Table 4.4-7 summarizes ethanol’s blending RVP, gasoline’s RVP and the final blend RVP for summertime RFG and CG gasoline, and compares the blends RVP values to that of the E85 ASTM RVP standards.⁹³⁴

Table 4.4-7. Comparison of E85 RVP levels to the ASTM RVP Standard

	Summer E85			Winter E70	
	CG 10.0	RFG & low RVP 6.8	ASTM Std	CG/RFG 14	ASTM Std
Gasoline RVP ^a					
Gasoline Blendstock RVP	9.0	5.8		13	
Ethanol Blending RVP	4.9	4.9	-	6.5	
Blend RVP	5.67	5.05	5.5	8.5	9.5

^a Summertime CG is allowed a 1 psi waiver for blending with ethanol, however, RFG and some low RVP areas and wintertime CG/RFG do not receive 1 psi waivers.

Table 4.4-7 shows that summertime RFG and wintertime gasoline cannot meet the ASTM RVP minimum standards based on blending ethanol with the locally available gasoline blendstock for blending up E10. For this reason, we ran the refinery model assuming that all E85 will also be blended with some butanes or pentanes (whichever is available from the nearest refineries) to bring E85 up to the maximum ASTM RVP standard, in addition to the CBOB or

RBOB being supplied to the local area. The maximum ASTM E85 RVP standard is 8.5 in the summertime and 12.0 in the wintertime.

E85 is expected to be priced lower in the marketplace than E10 and even less relative to gasoline (E0) because of E85’s lower energy density. E85 contains about 77,900 BTUs per gallon compared to E10 which contains about 111,300 BTUs per gallon. Thus, when consumers consider refueling their vehicle using E85, they will bypass using it unless if it is priced at parity with gasoline on an energy basis. Parity pricing means that E85 would have to be priced 25 percent lower than E10. Assuming that E85 is priced 25 percent lower than E10 at retail to account for the energy content differences, the pricing disparity between ethanol and gasoline is even greater at the terminal. Table 4.4-8 summarizes the pricing of E85 at retail and at the terminal where ethanol is usually blended into gasoline blendstock to create the E85. Retail markup averages about 10 cents per gallon.⁹³⁵ Federal and state taxes average 46 cents per gallon (although this varies significantly by state), and transportation from the terminal to retail averages 3 cents per gallon.⁹³⁶ Thus, if E10 gasoline is priced 163 cents per gallon at the terminal, it would be priced at 223 cents per gallon at retail. Based on E85’s 25 percent lower energy density, E85 would have to be priced at 167 cents per gallon at retail to reflect its lower energy density. Using the same terminal to retail costs/taxes, E85 would be priced at 107 cents per gallon at the terminal. All this is shown in Table 4.4-8. The bottom row of the table shows what ethanol (E100) would have to be price at for terminals to breakeven using ethanol in E85 (this assumes that E85’s gasoline blendstock is priced the same as E10 at the terminal). Based on ethanol’s energy content alone, ethanol would have to be discounted significantly compared to gasoline for refiners to find it cost-effective to use.

Table 4.4-8. E85 Pricing at Retail and at Terminals (cents per gallon)

	Price at Retail	Retail Markup	Average Federal and State Taxes	Transportation terminal to retail	Terminal Price
Gasoline E10	223	10	46	3	164
E85	167	10	46	3	108
Ethanol Breakeven Price	-	-	-	-	97

In addition to this effect of energy equivalency, Section 1.7 above outlines the difficulty of using all this E85 because of the relatively low number of fuel flexible vehicles (FFVs) that will be available to consume the fuel. The relatively low number of FFVs means that the refueling rate of these vehicles will have to be very high. In the year 2022, we estimated in Section 1.7 that FFVs will have to refuel 74 percent of the time to use the volume of ethanol required by the RFS2 standard. This E85 refueling level is even more severe considering that that it is unlikely that every service station would make the capital investments to make E85 available for sale. In Section 4.2, we estimate that one out of very four service stations will carry E85. Thus, E85 may have to be priced even lower than its fuel economy-adjusted price to entice FFV owners to refuel at a station carrying E85. To estimate the marginal lower price at which FFV owners would refuel at this high rate, we referenced an analysis based on a willingness to pay survey conducted by David Greene of the Oak Ridge National Laboratory.⁹³⁷ The summary

of this analysis is depicted in the Figure 4.4-1.

Figure 4.4-1

Alternative Fuel Market Share as a Function of Fuel Availability and Price Advantage (David L. Greene, 1997, Figure 6)

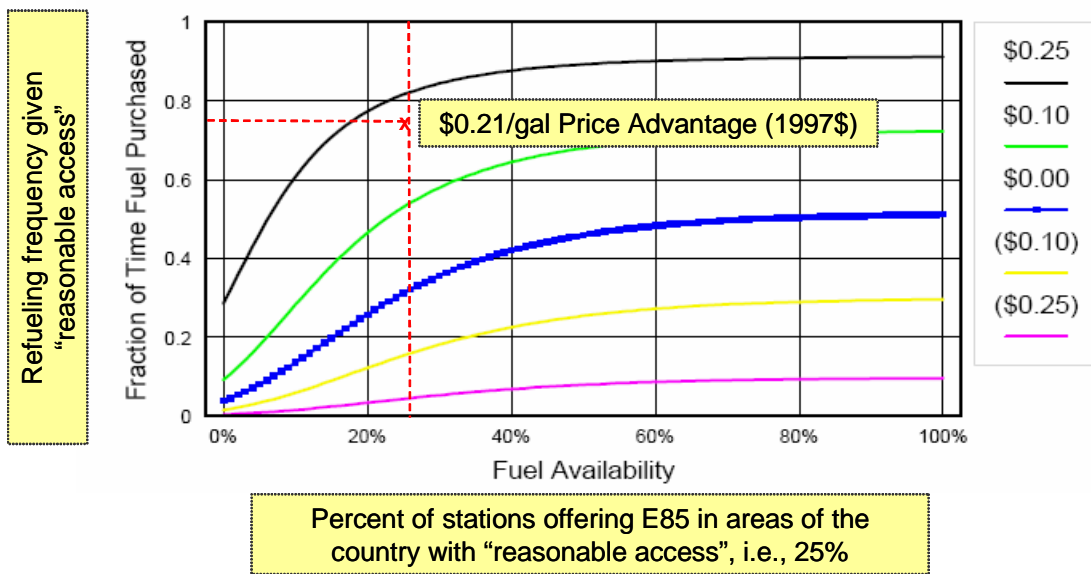

Based on our estimates that E85 would have to be purchased 74 percent of the time and that one out of every four service stations would carry E85, then Figure 4.4-1 estimates that E85 would have to be priced 21 cents per gallon lower than gasoline to match this availability and refueling scenario. This cost estimate is based in 1997 dollars. Adjusting this cost estimate to

2006 dollars increases this estimate to 26 cents per gallon.^{FFFFFFFFF}

There is one more factor which we believe could affect the price of E85. FFV owners who refuel on E85 will drive fewer miles before having to refuel compared to operating their vehicle on gasoline. The FFV drivers will therefore spend more time refueling their vehicle. As described above, FFV owners will drive 25 percent fewer miles per gallon and thus, will have to spend 25 percent more time refueling. We estimate that each refueling event requires 6 minutes of time, and that a person’s time is worth an average of 30 dollars per hour.^{938,939,940,941} Finally we assumed that a typical refueling volume for a refueling event is 15 gallons. Using these assumptions, the increased refueling frequency is costing the average FFV owner 5 cents per gallon more to use E85. To account for this additional cost, E85 would have to be priced 5 cents per gallon lower to make refueling FFVs a breakeven proposition. For our refinery modeling work, we reduced the refiner purchase price of E85 used in our refinery modeling analysis by this additional 5 cents per gallon.

Table 4.4-9 summarizes the E85 refinery purchase prices at terminals by PADD used in our refinery modeling work. These prices represent the total of the energy content, the price adjustment for reduced fuel availability and the cost for increased refueling events. The E85 prices should be compared to regular grade gasoline because the FFVs generally only require regular grade gasoline when operated on gasoline.

Table 4.4-9. Wholesale E85 Prices used within the Refinery Model

		E85 used in Conventional Gasoline Areas (c/gal)	E85 used in Reformulated Gasoline Areas (c/gal)
PADD 1	Summer	76	81
	Winter	67	72
PADD 2	Summer	75	80
	Winter	66	71
PADD 3	Summer	74	79
	Winter	65	70
PADDs 4/5	Summer	84	80
	Winter	75	81
CA	Summer	-	86
	Winter	-	77

While we used these E85 prices within the refinery model, they don’t necessarily represent the societal costs for using E85. The pricing to reflect reduced fuel availability, in particular, contains a significant amount of transfer payments from the refining industry to consumers and other entities, and these transfer payments do not represent the true cost for using

^{FFFFFFFFF} If E85 is used to comply with the RFS2 standard as envisioned, and if E85 would have to be priced as low as we projected, refiners would probably have to find a way to recoup their financial losses for using E85. One way refiners could do that would be to price E10 gasoline somewhat higher to recoup the E85 financial loss. Since we are solely interested in estimating the social cost of the RFS2 program, we did not make this sort of adjustment to the price of E10.

E85.^{GGGGGGGGGG}

For estimating the program costs for using E85 (shown in Tables 4.4-12 and 4.4-13), we adjusted E85 price back up to 5 cents per gallon less than the gasoline price for each case (the additional time spent refueling is a true cost). We then used the relative energy density of the E85 to that of gasoline as reported by the refinery model (see energy content values in Table 4.4-20) to account for the energy density costs for using E85. We preferred the energy content price cost made by the refinery model to our preliminary E85 energy content price adjustments because the refinery model can also account for changes in gasoline energy content made when accommodating the blending of ethanol. We are not assuming that the price adjustment that we made to account for lower E85 availability account for any additional social cost. If the FFV driver would have to drive out of his way from time-to-time to find the E85, then there would be some extra cost associated with the lower availability. But most of the time FFV drivers would likely learn where to find E85 along the routes that they normally frequent, thus, no additional effort and cost would be incurred for refueling on E85. Thus, we assume that the lower E85 price to account for reduced E85 availability is purely a transfer payment from the refiner to the FFV owner.

The assumption used here and throughout this proposed rulemaking is that ethanol's fuel economy is directly proportional to its energy density and its concentration in the fuel. Since the volumetric energy content of ethanol is approximately 33 percent less than conventional gasoline, we assumed this loss in fuel economy proportional to its concentration in the fuel. Some studies have suggested, however, that ethanol's decrease in fuel economy may be less than its relative decrease in volumetric energy content of the fuel. In other words, there is less of a fuel consumption decrease than what the lower energy density of ethanol would suggest. However, for a variety of reasons, we have reason to question the data from these studies. We therefore intend to investigate this issue more for the final rule as new data become available.

4.4.1.6 Other Adjustments to the Costs

As discussed above, we needed to adjust the estimated program costs from costs based on \$51/barrel crude oil, the crude oil price at which the refinery model was run, to \$53/bbl and \$92/bbl, the crude oil costs that served as the basis for our cost analysis. To make these adjustments we estimated the wholesale gasoline and diesel fuel prices (which are the surrogate for the gasoline and diesel fuel production costs) at the adjusted crude oil price and compared these adjusted wholesale gasoline and diesel fuel adjusted prices to the baseline wholesale gasoline and diesel fuel prices. The baseline wholesale gasoline and diesel fuel prices, based on an average \$51/bbl crude oil price, are summarized in Table 4.4-1. To adjust these wholesale prices, we needed to estimate how the price of crude oil will affect them. We conducted a regression between the annual average spot price of price of Western Texas Intermediate crude oil and the annual average retail gasoline and diesel fuel prices for the years 2002 through 2006.^{942,943} This regression is reflected in Table 4.4-10 as Gasoline Retail Price = Crude Oil Price multiplied times 2.95 plus 65.7, or Gasoline Retail Price = Crude Oil Price x "X" + "Y." The slope "X" and intercept "Y" for this equation are summarized in Table 4.4-10. The X and Y

^{GGGGGGGGGG} The possibility for this potentially large transfer payment associated with using ethanol in E85 would cause refiners to encourage the development of a cellulosic diesel fuel industry to avoid this E85 issue.

factors for diesel fuel are also summarized in Table 4.4-10 as well. However, we needed to estimate the wholesale prices instead of the retail prices, so we adjusted the equations to estimate the wholesale price using the Jacob's wholesale prices as the calibrating values. The regression, including the adjustment values to derive the wholesale prices equations are summarized in Table 4.4-10.

**Table 4.4-10.
Equations Used for Estimating Wholesale Average Gasoline and Diesel Fuel Prices***

	Equation for Retail Prices		Equation for Wholesale Prices	
	X	Y	X	Adjusted Y
Gasoline	2.95	65.7	2.95	+7.7
Diesel Fuel	3.46	41.5	3.46	-17.0

* The equation is used by multiplying the crude oil price (\$/bbl) times the X and then adding Y to that product resulting in a gasoline or diesel fuel cost expressed in cents per gallon.

The equations were used to estimate the average wholesale gasoline and diesel fuel prices. These average wholesale gasoline and diesel fuel prices are summarized in Table 4.4-11.

**Table 4.4-11
Average Gasoline and Diesel Fuel Wholesale Prices by Crude Oil Price
(c/gal)**

Crude Oil Price	Gasoline	Diesel Fuel
51	158	149
53	164	157
92	279	313

Table 4.4-11 shows the nationwide average costs, but our cost analysis was conducted on a PADD basis, thus, it was necessary to estimate revised gasoline and diesel fuel wholesale prices in each PADD. This was accomplished by generating a ratio of the average wholesale gasoline and diesel fuel prices at the higher crude oil price relative to the average wholesale and applying this ratio to the gasoline price in each PADD. It is important to note gasoline and diesel fuel pricing changes captured by our crude oil/gasoline and diesel fuel price relationship price model. Prior to 2005, diesel fuel was priced about the same as gasoline (+/- 5 cents per gallon on a yearly average). In 2005 and 2006, when crude oil was priced higher, diesel fuel was priced 13 cents per gallon higher than gasoline. Thus, the equation picks up this relatively higher diesel fuel price at the higher crude oil prices in 2005 and 2006 and projects an even greater relative higher price for diesel fuel at our high crude oil price of \$92/bbl. A higher relative diesel fuel price at higher crude oil prices in the future may be appropriate for a couple reasons. The first reason is that from January to mid-October 2008, when crude oil prices were very high, diesel fuel averaged 51 cents per gallon higher than gasoline. While we cannot say for certain that this association would always hold true at higher crude oil prices, we do have a possible explanation for a possible relationship here. Higher crude oil prices are likely to affect gasoline demand more than diesel fuel as more of the trips made by gasoline powered light-duty vehicles are discretionary. For example, people may readily change their vacations plans at higher crude oil prices, while diesel fuel used to power trucks that bring food to markets would be expected to

continue. Thus, as crude oil prices increase, gasoline consumption is likely more elastic resulting in greater reductions in gasoline demand compared to diesel fuel. We therefore believe that higher crude oil prices will tend towards relatively higher diesel fuel prices compared to gasoline.

For other reasons, diesel fuel prices may trend higher in the future relative to gasoline prices. Because EISA required that corporate average fuel economy (CAFE) standards be increased for light duty motor vehicles, over time light duty vehicles, which are almost exclusively gasoline powered, will become more fuel efficient. This will cause gasoline demand to decrease, while diesel demand is projected to continue to increase. A second reason why refinery gasoline production will decrease is that most of the renewable fuel volume being produced to comply with the RFS is ethanol, and it will displace gasoline. This will contribute to the over supply of gasoline and the relative undersupply of diesel fuel, thus causing gasoline prices to be soft relative to diesel fuel prices.

Another adjustment we made to the costs directly estimated by the LP refinery cost model was to add additional cost for distributing gasoline from the refinery to the terminal. The refinery cost model assigned a low distribution costs to gasoline for moving the gasoline from the refinery to the terminal. We estimate that this distribution cost should be about 4 cents per gallon, but the refinery model only assigned 2.5 cents per gallon for this. Thus, we credited ethanol 1.5 cents per gallon for each gasoline-equivalent gallon of ethanol blended into each PADD's gasoline, since this roughly corresponded to the volume of gasoline displaced by the ethanol.

4.4.2 Refinery Modeling Results

In this subsection, we summarize the results of the three refinery modeling cases that we conducted, the primary control case, and the sensitivity cases, which include the E10 case and the mid-ethanol blend case. Additional detail concerning the refinery modeling results is contained in Jacob's refinery modeling report contained in the docket.

4.4.2.1 Control Case

Tables 4.4-12 and 4.4-13 summarize the costs for the control case excluding federal ethanol, biodiesel and renewable diesel tax subsidies with crude oil priced at \$53/bbl and \$92/bbl, respectively. The costs are reported by different cost components as well as aggregated total and per-gallon costs.^{HHHHHHHHHH} This estimate of costs reflects the changes in gasoline that are occurring with the expanded use of ethanol, biodiesel and renewable diesel. The operating costs include the labor, utility and other operating costs and are a direct output from the refinery model. These costs are adjusted to reflect ethanol's production cost plus distribution costs instead of the ethanol prices used in the refinery cost model. The fixed costs are 3 percent of the reduced capital costs. The costs associated with lower energy density gasoline are accounted for

^{HHHHHHHHHH} EPA typically assesses social benefits and costs of a rulemaking. However, this analysis is more limited in its scope by sometimes examining the marginal production cost and the average production cost of ethanol and gasoline.

using the fractional change in energy density shown in Table 4.4-20, multiplied times the wholesale price of gasoline. By excluding the federal ethanol, biodiesel and renewable diesel fuel consumption subsidies, we avoid the transfer payments caused by these subsidies that would hide a portion of the program's costs. The variable operating costs line item in Table 4.4-12 and 4.4-13 capture several different aspects of this category of costs. In addition to ethanol's blending costs captured by the refinery model, this category of costs captures ethanol's higher production and distribution cost. At \$53 per barrel crude oil costs, ethanol's production and distribution costs are higher than the gasoline wholesale cost. Another item of the variable cost is the 5 cents per gallon refueling costs. Finally, this category of costs captures the 5 cents per E85 gallon cost which covers the cost of producing fuel flexible vehicles (FFVs) instead of non-FFVs.

Table 4.4-12.

Summary of Control Case Costs (without Tax Subsidies)

(million dollars/year and c/gal, except as noted; 2006 dollars, 7% ROI before taxes, \$53/bbl crude oil price)

	Cost to Gasoline	Cost to Diesel Fuel
Refinery Capital Costs (\$Billion)	-7.89	-
Amortized Refinery Capital Costs (\$MM/yr)	-842	-
Fixed Operating Cost (\$MM/yr)	-232	-
Variable Operating Cost (\$MM/yr)	7,690	590
Lower Energy Density (\$MM/yr)	10,340	187
Total Cost (\$MM/yr)	16,960	777
Amortized Refinery Capital Costs (c/gal)	-0.48	-
Fixed Operating Cost (c/gal)	-0.13	-
Variable Operating Cost (c/gal)	5.66	0.66
Lower Energy Density (c/gal)	5.85	0.54
Total Cost Excluding Subsidies (c/gal)	10.91	1.20

Table 4.4-13.

Summary of Control Case Costs (without Tax Subsidies)

(million dollars/year and c/gal, except as noted; 2006 dollars, 7% ROI before taxes, \$92/bbl crude oil price)

	Cost to Gasoline	Cost to Diesel Fuel
Amortized Refinery Capital Costs (\$MM/yr)	-842	-
Fixed Operating Cost (\$MM/yr)	-232	-
Variable Operating Cost (\$MM/yr)	-12,410	-419
Lower Energy Density (\$MM/yr)	17,598	373
Total Cost (\$MM/yr)	4,120	-46
Refinery Capital Costs (c/gal)	-0.48	-
Fixed Operating Cost (c/gal)	-0.13	-
Variable Operating Cost (c/gal)	-6.70	-1.15
Lower Energy Density (c/gal)	9.95	1.08
Total Cost Excluding Subsidies (c/gal)	2.65	-0.07

Our analysis shows that when considering all the costs associated with these fuel changes resulting from the expanded use of ethanol, that these various possible gasoline use scenarios will cost the U.S. nearly \$17 billion per year in the year 2022 when crude oil is priced at \$53 per barrel. Expressed as per-gallon costs, these fuel changes would cost the U.S. 10.91 cents per gallon of gasoline. The addition of biodiesel and renewable diesel fuel is estimated to cost about

\$780 million per year in the year 2022, or cost 1.20 cents per gallon.

At \$92 per barrel crude oil, the addition of the ethanol is estimated to cost 4.1 billion per year in 2022, and cost 2.65 cents per gallon. The addition of biodiesel and renewable diesel fuel is estimated to reduce the cost of diesel fuel by 46 million dollars in 2022, and reduce the per-gallon cost of diesel fuel by 0.07 cents per gallon.

Tables 4.4-12 and 4.4-13 express the total and per-gallon gasoline costs for the RFS case with the federal ethanol, biodiesel and renewable diesel subsidies included with crude oil priced at \$53/bbl and \$92/bbl, respectively. The federal tax subsidy is 45 cents per gallon for each gallon of new corn-based ethanol blended into gasoline and 101 cents per gallon for each gallon of cellulosic ethanol. Imported ethanol is also assumed to receive the 45 cents per gallon starch ethanol subsidy, although we assume that a greater volume of imported ethanol would be used than that which can flow through the Caribbean Basin, tariff free. Thus the 51 cents per gallon tariff would apply to that incremental volume of imported ethanol above the allowable Caribbean Basin initiative volume. We estimate that imported ethanol would earn 23 cents per gallon net subsidy. The biodiesel subsidy is 100 cents per gallon, and the renewable diesel fuel subsidy is 50 cents per gallon.ⁱⁱⁱⁱⁱⁱⁱⁱⁱⁱ The cost adjustment is estimated by multiplying the subsidy times the volume of new ethanol, biodiesel and renewable diesel estimated to be used.

Table 4.4-14.
Estimated Control Case Costs (Reflecting Tax Subsidies)

(million dollars/year and cents/gallon; 2004 dollars, 7% ROI before taxes, \$53/bbl crude oil price)

	Cost to Gasoline	Cost to Diesel Fuel
Total Cost (\$MM/yr)	16,957	777
Federal Subsidy (\$MM/yr)	-17,699	-525
Revised Total Cost (\$MM/yr)	-742	252
Per-Gallon Cost Excluding Subsidies (c/gal)	10.91	1.20
Federal Subsidy (c/gal)	-11.39	-0.81
Total Cost Including Subsidies (c/gal)	-0.48	0.39

Table 4.4-15.
Estimated Control Case Costs (Reflecting Tax Subsidies)

(million dollars/year and cents/gallon; 2004 dollars, 7% ROI before taxes, \$92/bbl crude oil price)

	Cost to Gasoline	Cost to Diesel Fuel
Total Cost (\$MM/yr)	4,116	-46
Federal Subsidy (\$MM/yr)	-17,699	-535
Revised Total Cost (\$MM/yr)	-13,583	-571
Per-Gallon Cost Excluding Subsidies (c/gal)	2.65	-0.07
Federal Subsidy (c/gal)	-11.39	-0.81
Total Cost Including Subsidies (c/gal)	-8.74	-0.88

The cost including subsidies would represent gasoline and diesel fuel's apparent cost as reflected to the fuel industry as a whole because the federal tax subsidies tends to transfer a

ⁱⁱⁱⁱⁱⁱⁱⁱⁱⁱ The recent economic stimulus law passed by Congress extended the biodiesel and renewable diesel fuel subsidies, and it also increased the renewable diesel fuel subsidy to 100 cents per gallon. However, the increase in renewable diesel fuel subsidy occurred too late to account for this change in our cost analysis.

portion of the actual costs. Our analysis estimates that when the oil price is \$53/bbl, the fuel industry will see a 0.48 cent per gallon decrease in the apparent cost of producing gasoline, and a 0.39 increase in the apparent cost of producing diesel fuel. At the higher oil price of \$93/bbl, the apparent cost of producing gasoline is estimated to decrease by 8.7 cents per gallon, and the apparent cost of producing diesel fuel is expected to decrease by 0.88 cents per gallon. These costs would also represent the apparent cost to consumers “at the pump” if the full tax credit were passed along to the consumers. However, it is possible that only a portion of the tax subsidy will be passed along to the consumer (historically, this has been the case). Thus, the price impact at the pump may be somewhere between the values in Tables 4.4-10 and 4.4-11, and Tables 4.4-12 and 4.4-13. However, consumers would also pay the full tax subsidy through higher taxes in addition to the values in Tables 4.4-12 and 4.4-13.

Table 4.4-14 summarizes the volumetric inputs to refineries in each PADD for this control case. Because of the increased use of biofuels, petroleum inputs would be expected to decrease, and this is confirmed.

Table 4.4-16.
Summary of the Total and Incremental Volumetric Refinery Inputs by PADD
(thousand barrels/day)

	PADD 1		PADD 2		PADD 3		PADD 4/5		CA	
	Control Case	Difference from Ref Case	Control Case	Difference from Ref Case	Control Case	Difference from Ref Case	Control Case	Difference from Ref Case	Control Case	Difference from Ref Case
PADD Crude	1,525	0	3,317	-245	8,642	-458	1,726	-21	2,098	-39
GTL Naphtha	0	0	0	0	0	0	0	0	0	0
GTL Diesel	0	0	0	0	0	0	0	0	0	0
VGO HS	0	0	0	0	483	-139	0	0	4	-24
VGO LS	0	0	1	0	0	0	0	0	0	0
HS AR (A960)	0	0	0	0	0	0	0	0	0	0
LS AR (Alg)	200	-1	0	0	267	139	0	0	0	0
Normal Butane	31	5	61	6	112	0	38	1	40	0
Isobutane	14	4	22	0	44	-23	10	-4	14	-10
MTBE	0	0	0	0	0	0	0	0	0	0
Ethanol - E10	360	14	237	46	180	85	82	27	163	-8
Ethanol - E20	0	0	0	0	0	0	0	0	0	0
Ethanol - E85	475	475	174	174	370	370	67	67	118	118
Reformer Feed	0	0	0	0	0	0	0	0	0	0
Methanol	0	0	0	0	0	0	0	0	0	0
Natural Gas (FOE)	67	-12	145	4	557	-13	119	-3	175	2
Hydrogen (MSCF)	0	0	0	0	0	0	0	0	0	0
Pentanes Plus	0	0	32	0	52	0	19	0	0	0
Import CBOB 10%	277	277	0	0	0	0	0	0	0	0
Import CBOB 20%	0	0	0	0	0	0	0	0	0	0
Import RBOB 10%	123	-77	0	0	0	0	0	0	0	0
Import RBOB 20%	0	0	0	0	0	0	0	0	0	0
Import Alkylate	46	30	0	0	0	0	0	0	0	0
Import Raffinate	4	-44	0	0	0	0	4	4	46	0
Import Reformate	0	0	0	0	0	0	0	0	0	0
Import FCC Naphtha	0	0	0	0	0	0	0	0	0	0
Import Lt Naphtha	14	14	0	0	23	-7	0	0	1	0
Import Hvy Naph	0	0	0	0	42	0	0	0	0	0
Transfer Lt Naphtha	0	0	0	0	0	0	0	0	12	-12
Transfer Reformate	0	0	0	-5	0	0	0	0	0	0
Transfer Alkylate	60	0	6	3	0	0	0	0	60	0
Transfer FCC Naphtha	0	0	0	0	0	0	0	0	0	0
Transfer Raffinate	0	0	4	2	0	0	0	0	60	0
Transfer RBOB 10%	662	-34	79	29	0	0	0	0	0	0
Transfer RBOB 20%	0	0	0	0	0	0	0	0	0	0
Transfer CBOB 10%	1,300	2	421	-29	0	0	1	1	0	0
Transfer CBOB 20%	0	0	0	0	0	0	0	0	0	0
Isooctane	2	2	0	0	0	0	0	0	35	7
Isocetene	1	-10	0	-2	0	0	0	0	0	0

Table 4.4-16 shows that inputs of crude oil decreases substantially in most of the PADDs. In two of the PADDs, vacuum gas oil (VGO) inputs to refineries decreases, which is reasonable

since VGO is a feedstock to fluidized catalytic cracker units, a large gasoline blendstock production unit within refineries.

Table 4.4-17 below summarizes the refinery output volumes and changes in refinery output volumes relative to the reference case by PADD.

**Table 4.4-17.
Summary of Total and Incremental Refinery Outputs by PADD
(thousand barrels/day)**

	PADD 1		PADD 2		PADD 3		PADD 4/5		CA	
	Control Case	Difference from Ref Case	Control Case	Difference from Ref Case	Control Case	Difference from Ref Case	Control Case	Difference from Ref Case	Control Case	Difference from Ref Case
Propane	33	-1	54	-10	145	0	26	-2	58	0
Propylene	19	0	43	0	245	0	2	0	12	0
Normal Butane	0	0	0	-4	30	-16	0	0	0	0
Isobutane	0	0	0	0	0	0	4	4	14	6
PC Naphtha	16	0	40	0	433	0	0	0	0	0
PC Gasoil	0	0	496	-60	158	0	0	0	0	0
CG Reg	0	-73	0	-552	0	-1,176	0	-246	0	0
CG Prem	0	0	0	0	0	-2	0	-33	0	0
CG E10 Reg	1,916	436	1,667	495	1,069	928	671	220	115	3
CG E10 Prem	268	10	343	14	262	11	143	43	22	1
RFG E10 Reg	1,099	-322	273	-55	358	-105	0	0	1,218	-94
RFG E10 Prem	285	14	65	3	92	4	0	0	258	8
CG E20 Reg	0	0	0	0	0	0	0	0	0	0
RFG E20 Reg	0	0	0	0	0	0	0	0	0	0
E85 to CG	156	156	133	133	306	306	78	78	0	0
E85 to RFG	398	398	70	70	125	125	0	0	137	137
Transfer RBOB 10%	0	0	0	0	741	-5	0	0	0	0
Transfer RBOB 20%	0	0	0	0	0	0	0	0	0	0
Transfer CBOB 10%	0	0	0	0	1,722	-27	0	0	0	0
Transfer CBOB 20%	0	0	0	0	0	0	0	0	0	0
Jet/Kero A (450ppm)	27	0	115	0	1,363	0	380	0	300	0
X-Fer Diesel Rundown	0	0	0	0	0	0	0	0	0	0
HSD Gr 76 (0.2%)	0	0	0	0	0	0	0	0	0	0
LSD Gr 74 (.05%)	0	0	0	0	0	0	0	0	0	0
ULSD (15 ppm)	565	13	648	-29	2,189	-34	515	4	0	0
CARB Diesel	0	0	0	0	0	0	0	0	354	-4
X-Fer C5's to Storage	0	0	0	0	0	0	0	0	0	0
1% Residual Fuel	0	0	0	0	0	0	0	0	0	0
Residual Fuel	86	16	57	0	251	-21	151	5	68	-5
Slurry	31	-1	80	-9	158	0	0	0	30	0
Asphalt & Wax	143	0	210	0	158	0	5	0	44	0
Gasoil	0	0	9	0	0	0	0	0	10	0
Lubes	19	0	17	0	158	0	0	0	20	0
Benzene	11	0	11	0	51	0	0	0	0	0
Toluene	0	0	0	0	35	0	0	0	0	0
Xylenes	0	0	0	0	8	0	0	0	0	0
Cumene	0	0	0	0	0	0	0	0	0	0
Cyclohexane	0	0	0	0	0	0	0	0	0	0
Transfer Raffinate	0	0	0	0	64	2	0	0	0	0
Transfer Alkylate	0	0	0	0	126	3	0	0	0	0
Transfer Reformate	0	0	0	0	0	-5	0	0	0	0
Transfer FCC naphtha	0	0	0	0	0	0	0	0	0	0
Transfer Lt Naphtha	0	0	0	0	0	0	0	0	12	-12
Transfer Blendstock	0	0	0	0	0	0	0	0	0	0
Sulfur (STons)	1	0	4	0	16	-1	2	0	4	0
Coke (STon)	1	-1	12	-2	65	-4	7	0	19	-1

Table 4.4-18 summarizes the change in refinery unit capacities by PADD comparing the control case to the reference case.

Table 4.4-18.
Change in Refinery Unit Capacities by PADD relative to the Reference Case
(thousand barrels/day)

Refinery Unit	PADD 1	PADD 2	PADD 3	PADD 4/5	CA	U.S.
Crude Tower	0	-421	-398	0	0	-818
Vacuum Tower	0	-188	-160	5	0	-343
Sats Gas Plant	-29	0	-35	1	-4	-66
Unsats Gas Plant	0	-1	-53	0	-12	-66
FCC DeC5 Tower	0	0	0	0	0	0
FCC	0	0	-175	0	-63	-238
FCC Splitter	0	-6	-97	0	-20	-123
Hydrocracker	0	0	0	-3	0	-3
H-Oil Unit	0	0	0	0	0	0
Delayed Coker	0	0	-91	0	0	-91
Visbreaker	48	0	0	0	0	48
Thermal Naphtha Splitter	0	-4	-11	0	-1	-16
CRU Reformer	0	0	0	0	0	0
SRU Reformer	0	0	0	0	3	3
BTX Reformer	0	1	0	0	0	1
C4 Isomerization	0	0	0	0	-4	-4
C5/C6 Isomerization	-1	0	0	0	0	-1
HF Alkylation	0	0	0	0	0	0
H2SO4 Alkylation	-22	0	-51	-15	-26	-113
Dimersol	0	0	0	0	0	0
Cat Poly	9	0	0	0	0	9
Isooctane	0	0	0	0	0	0
DHT - Total	7	0	-93	3	0	-84
DHT 2nd RCT - Total	11	53	-69	-4	15	7
DHT Arom Saturation	0	0	0	0	0	0
NHT - Total Fd	-16	0	0	-2	0	-17
CGH - Generic	2	-48	25	8	0	-13
CGH - Olefin Sat'n	0	0	0	0	0	0
FCCU Fd HDT	0	0	0	-34	60	26
LSR Splitter	0	16	0	0	0	16
LSR Bz Saturator	0	0	0	0	0	0
Reformat Saturator	-9	0	-1	0	0	-9
Reformat Splitter	-26	0	-2	0	0	-28
SDA	0	0	0	0	0	0
MTBE	0	0	0	0	0	0
TAME	0	0	0	0	0	0
Hydrogen Plant - Total MSCF	7	34	36	-19	20	77
Lube Unit	0	0	0	0	0	0
Sulfur Plant	0	0	-1,402	-56	-96	-1,553
Merox Jet	0	0	0	0	0	0
Merox Diesel	0	0	0	0	0	0
BTX Reformer - Tower feed	0	0	0	0	0	0
BTX Reformer - Extract feed	1	1	0	0	0	1

Most of the capacity throughput changes are negative, reflecting the decreased processing of crude oil and vacuum gas oil and decreased downstream refining units as projected by the refinery model. Of the negative throughput changes, the large reduced volume of the fluidized catalytic cracker unit is important. As discussed above, the refinery model likely chose to decrease the fluidized catalytic cracker throughput to crack less heavy hydrocarbons to light hydrocarbons, producing less gasoline material to offset the increased volume of ethanol. Another important decrease in refinery unit throughput is the alkylation unit. Because the

alkylation unit is responsible for increasing octane, its decrease reflects the rebalancing by the refinery model to adjust for the large increase in the volume of high octane ethanol.

These changes in refinery unit throughputs are associated with changes in capital investments. Table 4.4-19 summarizes the projected change in capital investments between the control case and the reference case. This Table shows that incremental to the reference case, refiners are expected to reduce their capital investments by \$7.9 billion compared to business as usual. Most of the reduction occurs in PADDs 2 and 3 where large volumes of ethanol, and other gasoline blendstocks are expected to enter the gasoline pool. Of course, this capital cost decrease is countered by the capital costs incurred to build new ethanol plants and to put into place the distribution system that the new ethanol requires (see Table 4.4-21 below).

Table 4.4-19.
Change in Refinery Unit Investments by PADD (million dollars/year)

Refinery Unit	PADD 1	PADD 2	PADD 3	PADD 4/5	CA	U.S.
Crude Tower	0	-995	-665	0	202	-1,660
Vacuum Tower	0	-527	-315	85	30	-756
Sats Gas Plant	-112	0	-103	3	17	-249
Unsats Gas Plant	0	0	-260	0	0	-362
FCC DeC5 Tower	0	0	0	0	0	0
FCC	0	0	-1,280	0	0	-2,066
FCC Splitter	0	-6	-47	0	0	-69
Hydrocracker	0	0	0	-65	0	-65
H-Oil Unit	0	0	0	0	0	0
Delayed Coker	0	0	-1,261	0	0	-1,261
Visbreaker	170	0	0	0	0	170
Thermal Naphtha Splitter	0	-5	-4	0	3	-11
CRU Reformer	0	0	0	0	0	0
SRU Reformer	0	0	0	0	32	72
BTX Reformer	0	11	2	0	0	13
C4 Isomerization	0	0	0	0	14	-23
C5/C6 Isomerization	-64	0	0	0	0	-64
HF Alkylation	0	0	0	0	0	0
H2SO4 Alkylation	-372	0	-557	-227	10	-1,617
Dimersol	0	0	0	0	0	0
Cat Poly	72	0	0	0	0	72
Isooctane	0	0	0	0	0	0
DHT - Total	42	0	-689	17	32	-631
DHT 2nd RCT - Total	50	344	-313	-17	60	133
DHT Arom Saturation	0	0	0	0	0	0
NHT - Total Fd	-70	0	0	-6	0	-76
CGH - Generic	8	-200	101	26	0	-64
CGH - Olefin Sat'n	0	0	0	0	0	0
FCCU Fd HDT	-2	0	0	-349	60	443
LSR Splitter	0	7	0	0	8	7
LSR Bz Saturator	0	0	0	0	0	0
Reformate Saturator	-39	0	-2	0	50	-41
Reformate Splitter	-39	0	-1	0	150	-40
SDA	0	0	0	0	0	0
MTBE	0	0	0	0	0	0
TAME	0	0	0	0	0	0
Hydrogen Plant - Total MSCF	19	118	95	-49	27	255
Lube Unit	0	0	0	0	56	0
Sulfur Plant	0	0	-3	0	437	-4
Merox Jet	0	0	0	0	0	0
Merox Diesel	0	0	0	0	0	0
BTX Reformer - Tower feed	0	1	0	0	0	1
BTX Reformer - Extract feed	3	3	0	0	0	6
Total	-334	-1,250	-5,304	-582	0	-7,887

Table 4.4-19 essentially expresses the change in refinery capacity input shown in Table 4.4-18, but expresses the changes in terms of dollars instead of thousands of barrels per day. The total reduced capital investment is 7.89 billion dollars.

Table 4.4-20 summarizes the gasoline volume and qualities by different gasoline types for the control case, and also, for comparison, lists the same for the reference case.

**Table 4.4-20.
Gasoline Volume, Quality and Energy Density by Gasoline Type
at the PADD Terminal**

RFG	PADD 1		PADD 2		PADD 3		PADD 4/5		CA		US	
	Ref Case	Control	Ref Case	Control	Ref Case	Control	Ref Case	Control	Ref Case	Control	Ref Case	Control
Total ('000 BPD)	1,692	1,384	391	338	551	450	-	-	1,562	1,476	4,197	3,649
Ethanol ('000 BPD)	171	140	39	34	56	45	-	-	158	149	424	369
RVP (psi)	10.7	10.6	10.4	11.3	9.7	10.6	-	-	9.5	9.4	10.1	10.2
Sulfur (ppm)	23	24	23	23	20	22	-	-	9	10	17	18
Octane (R+M/2)	88.1	88.3	88.0	88.2	88.0	88.2	-	-	87.6	87.7	87.9	88.0
Aromatics (vol%)	19.9	19.9	20.0	19.6	19.5	19.5	-	-	21.3	21.7	20.4	20.6
Benzene (vol%)	0.55	0.58	0.58	0.56	0.51	0.48	-	-	0.51	0.52	0.53	0.54
Olefins (vol%)	11.7	11.6	10.3	10.4	8.7	11.1	-	-	5.7	5.7	8.9	9.0
Oxygen (wt%)	3.7	3.7	3.7	3.7	3.7	3.7	-	-	3.7	3.7	3.7	3.7
E200 (vol%)	55.1	55.4	59.7	58.8	54.3	54.0	-	-	57.7	57.4	56.4	56.4
E300 (vol%)	93.9	95.1	84.3	95.2	87.4	95.2	-	-	86.2	86.2	89.3	91.5
Energy (MMBtu/Bbl)	4.954	4.948	4.920	4.905	4.983	4.961	-	-	4.991	5.001	4.969	4.967
CG												
Total ('000 BPD)	2,263	2,184	2,052	2,009	1,568	1,331	829	813	135	137	6,847	6,475
Ethanol ('000 BPD)	176	221	152	203	40	134	56	82	14	14	436	654
RVP (psi)	11.6	11.6	11.7	11.5	10.7	10.4	11.3	11.2	10.5	10.6	11.4	11.3
Sulfur (ppm)	24	24	23	24	24	22	27	28	25	26	24	24
Octane (R+M/2)	87.7	87.9	88.0	88.0	88.0	88.2	86.9	87.0	89.1	89.1	87.8	87.9
Aromatics (vol%)	24.2	22.4	24.4	22.5	27.2	22.3	19.4	17.3	28.4	28.5	24.4	21.9
Benzene (vol%)	0.61	0.53	0.64	0.52	0.59	0.50	1.16	1.04	0.60	0.56	0.68	0.58
Olefins (vol%)	13.9	14.7	11.1	11.0	14.9	11.9	6.9	7.4	17.1	15.1	12.5	12.0
Oxygen (wt%)	2.9	3.7	2.7	3.7	0.9	3.7	2.5	3.7	3.6	3.7	2.3	3.7
E200 (vol%)	55.4	55.6	55.7	57.8	46.5	55.6	59.6	63.2	55.8	55.4	54.0	57.3
E300 (vol%)	93.4	95.4	84.3	95.4	87.4	95.4	83.5	95.8	86.2	86.2	87.9	95.3
Energy (MMBtu/Bbl)	4.980	4.947	4.965	4.931	5.069	4.951	5.011	4.962	4.969	4.983	4.999	4.946
E85												
Total ('000 BPD)	-	554	-	202	-	431	-	78	-	137	-	1,402
Ethanol ('000 BPD)	-	475	-	174	-	370	-	67	-	118	-	1,204
RVP (psi)	-	10.1	-	10.8	-	11.1	-	12.0	-	11.7	-	10.8
Sulfur (ppm)	-	10	-	9	-	9	-	9	-	9	-	10
Octane (R+M/2)	-	107.7	-	107.8	-	107.9	-	107.9	-	107.9	-	107.8
Aromatics (vol%)	-	1.1	-	0.6	-	0.5	-	0.0	-	0.3	-	0.7
Benzene (vol%)	-	0.03	-	0.02	-	0.01	-	0.00	-	0.01	-	0.02
Olefins (vol%)	-	2.2	-	2.1	-	2.2	-	1.1	-	1.2	-	2.0
Oxygen (wt%)	-	30.5	-	30.6	-	30.7	-	30.8	-	30.7	-	30.6
E200 (vol%)	-	127.0	-	128.4	-	128.7	-	129.6	-	129.1	-	128.1
E300 (vol%)	-	95.6	-	96.1	-	96.2	-	96.6	-	96.5	-	96.0
Energy (MMBtu/Bbl)	-	3.652	-	3.630	-	3.623	-	3.596	-	3.607	-	3.632
All Mogas												
Total ('000 BPD)	3,955	4,122	2,443	2,550	2,120	2,212	829	891	1,697	1,751	11,044	11,526
Ethanol ('000 BPD)	347	836	191	411	95	550	56	149	171	281	860	2,226
RVP (psi)	11.2	11.1	11.5	11.4	10.5	10.6	11.3	11.3	9.6	9.7	10.9	10.9
Sulfur (ppm)	24	22	23	22	23	19	27	26	10	11	22	20
Octane (R+M/2)	87.9	90.7	88.0	89.6	88.0	92.1	86.9	88.8	87.8	89.4	87.8	90.4
Aromatics (vol%)	22.4	18.7	23.7	20.4	25.2	17.5	19.4	15.8	21.8	20.6	22.9	18.9
Benzene (vol%)	0.58	0.48	0.63	0.48	0.57	0.40	1.16	0.95	0.52	0.48	0.62	0.50
Olefins (vol%)	12.9	12.0	10.9	10.2	13.3	9.8	6.9	6.9	6.6	6.1	11.1	9.9
Oxygen (wt%)	3.2	7.4	2.9	5.9	1.7	9.1	2.5	6.2	3.7	5.9	2.9	7.1
E200 (vol%)	55.3	65.1	56.4	63.6	48.5	69.5	59.6	69.0	57.5	62.8	54.9	65.6
E300 (vol%)	93.6	95.3	84.3	95.4	87.4	95.5	83.5	95.9	86.2	87.0	88.4	94.2
Energy (MMBtu/Bbl)	4.969	4.773	4.958	4.824	5.046	4.695	5.011	4.843	4.989	4.890	4.988	4.792

Several very important differences are evident in Table 4.4-20. First, the energy content of the control case gasoline is much lower than that of the reference case due to the addition of low energy content ethanol. Another obvious change is the 4 volume percent decrease in aromatics content across the gasoline pool. This change is caused by two factors. One factor is the increase in high octane ethanol in E10 which allows for decreased production of high octane reformat, which is high in aromatics. Another factor is the blending of E85. The ethanol in E85 will dilute the aromatics contained in its gasoline blendstock. Another important change is the increase in the gasoline pool octane. Since the reference case gasoline pool was compliant in octane, the increased octane of the control case represents octane giveaway. Because of

ethanol's very high octane and high concentration in E-85, E85 contains a much higher octane level, and when averaged with the rest of the gasoline pool, results in a sizable increase the gasoline pool's average octane level, or octane giveaway. Similarly, the blending of E85 causes the decrease in gasoline pool benzene level.

The increased use of renewable and alternative fuels would require capital investments in corn and cellulosic ethanol plants, and renewable diesel fuel plants. In addition to producing the fuels, storage and distribution facilities along the whole distribution chain, including at retail, will have to be constructed for these new fuels. Conversely, as these renewable and alternative fuels are being produced, they supplant gasoline and diesel fuel demand which results in less new investments in refineries compared to business-as-usual. In Table 4.4-21, we list the total incremental capital investments that we project would be made for this proposed RFS2 rulemaking incremental to the reference case. These aggregate capital costs are estimated by deriving a total capital cost per gallon of product produced for each plant type and multiplying that capital cost per gallon factor by the total additional volume of that fuel supplied between the reference case and the control case.

**Table 4.4-21.
Projected Total RFS Program U.S. Capital Investments
(billion dollars)**

Plant Type	Capital Costs
Corn Ethanol	4.0
Cellulosic Ethanol	50.1
Ethanol Distribution	12.4
Bio/Renew Diesel Fuel Production and Distribution	0.25
Refining	-7.9
Total	58.9

Table 4.4-21 shows that the total U.S. incremental capital investments attributed to this program by 2022 is \$58.9 billion. One contributing reason why the capital investments made for renewable fuels technologies is so much more than the decrease in refining industry capital investments is that a large part of the decrease in petroleum gasoline supply was from reduced imports. In addition, renewable fuels technologies are more capital intensive per gallon of fuel produced than incremental increases in gasoline and diesel fuel production at refineries.

To understand entire costs of the program and their impacts on the U.S. economy, and to compare those costs to the benefits, we estimated the year-by-year costs from 2009, the first year of the program, to 2030. We first estimated renewable fuels volumes for each renewable fuels type based on the RFS2 volume standards and based on our projections of which renewable fuels would be used to comply with the standard. These volumes represent the increment between the RFS2 control case and the reference case. Based on AEO 2008, we also estimated the overall gasoline and diesel fuel volumes. Table 4.4-22 below summarizes the projected year-by-year incremental renewable fuel, and total gasoline and diesel fuel volumes.

**Table 4.4-22.
Summary of Year-by-Year Volumes (Billion Gallons/year)**

Year	Gasoline Volume	Corn Ethanol Volume	Cellulosic Ethanol Volume	Imported Ethanol Volume	Diesel Fuel Volume	Biodiesel Volume	Renewable Diesel Fuel Volume
2009	148.7	0.34	0.00	0.00	54.3	0.08	0.00
2010	149.8	1.04	0.00	0.00	55.8	0.23	0.01
2011	150.4	1.60	0.06	0.00	57.3	0.37	0.03
2012	151.4	2.12	0.25	0.00	58.2	0.62	0.04
2013	152.4	2.82	0.75	0.00	58.7	0.61	0.06
2014	153.2	3.39	1.50	0.16	59.3	0.69	0.07
2015	154.0	3.90	2.75	0.45	60.0	0.66	0.09
2016	154.7	3.84	4.00	0.80	60.7	0.54	0.10
2017	155.1	3.70	5.25	1.25	61.3	0.52	0.12
2018	155.1	3.51	6.75	1.71	61.9	0.51	0.13
2019	155.2	3.31	8.25	2.15	62.6	0.49	0.15
2020	154.8	3.17	10.25	2.10	63.4	0.47	0.16
2021	155.1	2.93	13.25	2.04	64.2	0.45	0.17
2022	155.4	2.71	15.75	2.50	65.0	0.43	0.19
2023	154.8	2.71	15.75	2.50	65.9	0.43	0.19
2024	154.3	2.71	15.75	2.50	66.8	0.43	0.19
2025	153.4	2.71	15.75	2.50	67.7	0.43	0.19
2026	153.2	2.71	15.75	2.50	68.8	0.43	0.19
2027	153.2	2.71	15.75	2.50	69.8	0.43	0.19
2028	153.3	2.71	15.75	2.50	70.9	0.43	0.19
2029	153.3	2.71	15.75	2.50	71.9	0.43	0.19
2030	153.7	2.71	15.75	2.50	73.0	0.43	0.19

Also for our year-by-year cost analysis, we needed year-by-year estimates of the production and distribution cost for each renewable fuel type. The feedstock costs were available for the years 2012, 2017 and 2022 from FASOM for corn ethanol and soy oil, used for producing biodiesel, with crude oil priced at \$53/bbl and \$92/bbl. We entered those feedstock costs into the respective cost models and interpolated and extrapolated the production costs for the years provided to develop production costs for the in-between years. For cellulosic ethanol, we assumed the same feedstock costs for all years, but we adjusted the production costs based on our adjusted NREL production costs, interpolating between the years for which we have specific cost data. Since the costs change so much for cellulosic ethanol, the costs in any one year were based on the accumulated costs from the previous years. For example, the production costs in the year 2015 are a function of the production costs times the new volume of cellulosic ethanol in 2015, plus the production costs times the volume of new cellulosic ethanol in 2014, and so on. This avoids underestimating the costs in the later years. Imported ethanol costs by year are from Section 4.1 above. Tables 4.4-23 and 4.4-24 summarize the renewable fuels production and distribution costs by year along with the projected crude oil, gasoline and diesel fuel wholesale costs. Table 4.4-23 represents the projected costs based on crude oil priced at \$53 per barrel, and Table 4.4-24 presents the projected costs based on crude oil priced at \$92 per barrel.

**Table 4.4-23.
Renewable Fuel Production and Distribution Costs Used in Year-by-Year Analysis
(\$53/bbl Crude Oil Case)**

Year	Crude Oil Price \$/bbl	Wholesale Gasoline Price	Corn Ethanol Prod Cost	Cellulosic Ethanol Prod Cost	Imported Ethanol Prod Cost	Wholesale Diesel Fuel Price	Biodiesel Prod Cost	Renewable Diesel Fuel Prod Cost
2009	68.3	204	155	-	178	220	270	210
2010	65.2	195	154	229	177	209	270	210
2011	62.7	188	153	211	176	200	270	210
2012	60.1	180	152	193	175	191	270	210
2013	57.4	172	151	175	174	182	273	212
2014	54.7	164	150	157	173	172	276	214
2015	52.0	156	149	139	172	163	279	217
2016	49.4	148	148	138	172	154	282	219
2017	49.5	149	147	137	171	154	285	221
2018	50.2	151	147	136	171	157	282	219
2019	50.9	153	147	134	171	159	279	217
2020	51.5	155	147	133	170	161	276	214
2021	52.1	156	147	132	170	163	273	212
2022	52.8	159	147	131	170	166	270	210
2023	53.8	161	147	131	170	169	270	210
2024	54.7	164	147	131	168	172	270	210
2025	55.7	167	147	131	168	176	270	210
2026	56.6	170	147	131	168	179	270	210
2027	55.8	167	147	131	168	176	270	210
2028	56.8	170	147	131	168	180	270	210
2029	57.9	174	147	131	168	184	270	210
2030	58.7	176	147	131	168	186	270	210

**Table 4.4-24.
Renewable Fuel Production and Distribution Costs Used in Year-by-Year Analysis
(\$92/bbl Crude Oil Case)**

Year	Crude Oil Price \$/bbl	Wholesale Gasoline Price	Corn Ethanol Prod Cost	Cellulosic Ethanol Prod Cost	Imported Ethanol Prod Cost	Wholesale Diesel Fuel Price	Biodiesel Prod Cost	Renewable Diesel Fuel Prod Cost
2009	67.8	203	161	-	180	218	269	208
2010	69.2	207	160	-	179	223	269	208
2011	71.0	212	160	216	178	229	269	208
2012	73.1	218	160	203	177	236	269	208
2013	75.0	224	160	188	176	243	272	210
2014	76.8	229	160	175	175	249	274	212
2015	78.6	234	159	161	174	255	277	214
2016	80.4	240	159	155	174	261	279	216
2017	82.8	247	159	152	173	270	282	218
2018	84.2	251	158	149	173	274	279	216
2019	86.3	257	157	148	173	282	277	214
2020	88.3	263	156	146	172	289	275	212
2021	90.7	270	155	144	172	297	272	210
2022	91.8	273	154	143	172	301	270	209
2023	89.9	268	154	143	172	294	270	209
2024	91.2	272	154	143	170	299	270	209
2025	90.9	271	154	143	170	298	270	209
2026	91.8	273	154	143	170	301	270	209
2027	93.1	277	154	143	170	306	270	209
2028	94.4	281	154	143	170	310	270	209
2029	95.4	284	154	143	170	313	270	209
2030	96.4	287	154	143	170	317	270	209

Based on the volumes and renewable fuels production and distribution costs, we estimated the program costs in years other than 2022 and summarized them in Tables 4.4-25 and 4.4-26. We started with the year 2022 costs as our basis. We then adjusted those costs using the volume and price relationship between ethanol and gasoline to estimate the costs in other years. We also calculated the total dollar amount of the subsidies based on the volumes of renewable fuels and the subsidy that applies to each renewable fuel, and what the subsidized cost would be when the subsidies are applied.

Table 4.4-25.

Year-by-Year Annual Average and Per-Gallon Costs for Gasoline

Year	\$53/bbl Crude Oil Price				\$92/bbl Crude Oil Price			
	Total Annual Cost \$MM/yr	Gasoline Cost c/gal	Subsidy \$MM/yr	Subsidized Gasoline Cost c/gal	Total Annual Cost \$MM/yr	Gasoline Cost c/gal	Subsidy \$MM/yr	Subsidized Gasoline Cost c/gal
2009	-52	-0.03	153	-0.14	172	0.12	153	0.01
2010	37	0.03	468	-0.29	441	0.29	468	-0.02
2011	513	0.34	783	-0.18	540	0.36	783	-0.16
2012	1,363	0.90	1,208	0.10	536	0.35	1,208	-0.44
2013	2,244	1.47	2,028	0.14	705	0.46	2,028	-0.87
2014	3,738	2.44	3,116	0.41	1,451	0.95	3,116	-1.09
2015	5,761	3.74	4,733	0.67	2,268	1.47	4,733	-1.60
2016	7,508	4.85	6,073	0.93	2,700	1.74	6,073	-2.18
2017	8,910	5.75	7,326	1.02	2,916	1.88	7,326	-2.84
2018	10,384	6.70	8,794	1.03	3,268	2.11	8,794	-3.56
2019	11,747	7.57	10,248	0.97	3,319	2.14	10,248	-4.46
2020	13,031	8.42	12,245	0.51	3,154	2.04	12,245	-5.87
2021	14,998	9.67	15,207	-0.14	2,867	1.85	15,207	-7.96
2022	16,957	10.91	17,708	-0.48	2,962	1.91	17,708	-9.49
2023	16,584	10.71	16,488	0.06	3,517	2.27	16,488	-8.38
2024	16,259	10.54	16,488	-0.15	2,979	1.93	16,488	-8.76
2025	15,867	10.34	16,488	-0.40	3,079	2.01	16,488	-8.74
2026	15,501	10.12	16,488	-0.64	2,732	1.78	16,488	-8.98
2027	15,806	10.31	16,488	-0.44	2,231	1.46	16,488	-9.30
2028	15,427	10.07	16,488	-0.69	1,771	1.16	16,488	-9.60
2029	15,005	9.79	16,488	-0.97	1,372	0.89	16,488	-9.86
2030	14,725	9.58	16,488	-1.15	977	0.64	16,488	-10.09

**Table 4.4-26.
Year-by-Year Annual Average and Per-Gallon Costs for Diesel Fuel**

Year	\$53/bbl Crude Oil Price				\$92/bbl Crude Oil Price			
	Total Annual Cost \$MM/yr	Diesel Fuel Cost c/gal	Subsidy \$MM/yr	Subsidized Diesel Fuel Cost c/gal	Total Annual Cost \$MM/yr	Diesel Fuel Cost c/gal	Subsidy \$MM/yr	Subsidized Diesel Fuel Cost c/gal
2009	83	0.15	83	0.00	84	0.15	83	0.00
2010	260	0.47	235	0.04	226	0.41	235	-0.02
2011	460	0.80	387	0.13	350	0.61	387	-0.07
2012	814	1.40	640	0.30	533	0.92	640	-0.18
2013	890	1.52	639	0.43	505	0.86	639	-0.23
2014	1,103	1.86	729	0.63	549	0.93	729	-0.30
2015	1,155	1.93	707	0.75	503	0.84	707	-0.34
2016	1,051	1.73	596	0.75	396	0.65	596	-0.33
2017	1,048	1.71	583	0.76	348	0.57	583	-0.38
2018	1,001	1.62	571	0.69	296	0.48	571	-0.44
2019	952	1.52	558	0.63	229	0.37	558	-0.53
2020	906	1.43	546	0.57	164	0.26	546	-0.60
2021	864	1.35	533	0.51	93	0.14	533	-0.69
2022	817	1.26	521	0.46	49	0.08	521	-0.73
2023	798	1.21	521	0.42	87	0.13	521	-0.66
2024	781	1.17	521	0.39	61	0.09	521	-0.69
2025	761	1.12	521	0.35	67	0.10	521	-0.67
2026	742	1.08	521	0.32	49	0.07	521	-0.69
2027	758	1.09	521	0.34	23	0.03	521	-0.71
2028	739	1.04	521	0.31	0	0.00	521	-0.74
2029	717	1.00	521	0.27	-21	-0.03	521	-0.75
2030	703	0.96	521	0.25	-41	-0.06	521	-0.77

4.4.2.2 Sensitivity Cases

We also ran two sensitivity cases to the 2022 control case. The two sensitivity cases were: 1) ethanol use is increased beyond the reference case until the gasoline pool is saturated with ethanol at 10 percent, and 2) ethanol, biodiesel and renewable diesel fuel are used at the same volumes as the primary year 2022 control case, however, the ethanol is primarily blended with gasoline at 20 percent which dramatically reduces the volume of E85 required. We ran sensitivity cases to isolate aspects of the primary control case. We ran the E10 case to isolate the effects of E10 blending from that of E85 on gasoline fuel properties and costs. We ran the mid-ethanol blend sensitivity case to assess what might happen to gasoline fuel properties and costs if a waiver were to be granted for mid-ethanol blends as some have suggested.

4.4.2.2.1 E10 Sensitivity Case

Tables 4.4-27 and 4.4-28 summarize the costs for the E10 sensitivity case ignoring federal ethanol tax subsidies and at two different crude oil prices. The costs are reported by different cost component as well as aggregated total and the per-gallon costs.^{JJJJJJJJ} This estimate of costs reflects the changes in gasoline that are occurring with the expanded use of ethanol. The operating costs include the labor, utility and other operating costs and are a direct output from the refinery model. These costs are adjusted to reflect ethanol’s production cost plus distribution costs instead of the ethanol prices used in the refinery cost model. The fixed costs were assumed to be 3 percent of the capital costs. The costs associated with lower energy density gasoline are accounted for using the fractional change in energy density shown in Table 4.4-28 multiplied times the wholesale price of gasoline. By ignoring the federal ethanol tax subsidies in the table, we avoid the transfer payments caused by these subsidies that would hide a portion of the program’s costs.

Table 4.4-27.
Summary of E10 Case Costs (without Ethanol Tax Subsidies)
(million dollars/year and c/gal, except as noted; 2004 dollars,
7% ROI before taxes, \$53/bbl crude oil price)

	Cost to Gasoline
Refinery Capital Costs (\$Billion)	-1.23
Amortized Refinery Capital Costs (\$MM/yr)	-131
Fixed Operating Cost (\$MM/yr)	-36
Variable Operating Cost (\$MM/yr)	940
Lower Energy Density (\$MM/yr)	1,930
Total Cost (\$MM/yr)	2,704
Refinery Capital Costs (c/gal)	-0.08
Fixed Operating Cost (c/gal)	-0.02
Variable Operating Cost (c/gal)	0.76
Lower Energy Density (c/gal)	1.13
Total Cost Excluding Subsidies (c/gal)	1.79

^{JJJJJJJJ} EPA typically assesses social benefits and costs of a rulemaking. However, this analysis is more limited in its scope by sometimes relying on the marginal production price which includes some market distortions , while other times relying on the average production cost for ethanol.

Table 4.4-28.
Summary of E10 Case Costs (without Ethanol Tax Subsidies)
(million dollars/year and c/gal, except as noted; 2004 dollars,
7% ROI before taxes, \$92/bbl crude oil price)

	Cost to Gasoline
Amortized Refinery Capital Costs (\$MM/yr)	-131
Fixed Operating Cost (\$MM/yr)	-36
Variable Operating Cost (\$MM/yr)	-1,348
Lower Energy Density (\$MM/yr)	2,690
Total Cost (\$MM/yr)	1,180
Refinery Capital Costs (c/gal)	-0.08
Fixed Operating Cost (c/gal)	-0.02
Variable Operating Cost (c/gal)	-0.69
Lower Energy Density (c/gal)	1.57
Total Cost Excluding Subsidies (c/gal)	0.78

Our analysis shows that when considering all the costs associated with these fuel changes resulting from the expanded use of ethanol, that increased ethanol use up to 100 percent E10 will cost the U.S. \$2.7 billion per year in the year 2022 when crude oil is priced at \$53 per barrel. Expressed as per-gallon costs, these fuel changes would cost the U.S. 1.79 cents per gallon of gasoline. At \$92 per barrel crude oil, the addition of the ethanol up to 100 percent E10 is estimated to cost \$1,180 million per year in 2022, and cost 0.78 cents per gallon. These cost impacts are far lower than for the control case described above due to the far lower volumes of ethanol, but also the lack of blending of E85.

Tables 4.4-29 and 4.4-30 expresses the total and per-gallon gasoline costs for the RFS case with the federal ethanol, biodiesel and renewable diesel subsidies included with crude oil priced at \$53/bbl and \$92/bbl, respectively. The federal tax subsidy is 45 cents per gallon for each gallon of new corn-based ethanol blended into gasoline and 101 cents per gallon for each gallon of cellulosic ethanol. The biodiesel subsidy is 100 cents per gallon, and the renewable diesel fuel subsidy is 50 cents per gallon. The cost adjustment is estimated by multiplying the subsidy times the volume of new ethanol, biodiesel and renewable diesel estimated to be used.

Table 4.4-29.
Estimated E10 Case Cost (Reflecting Ethanol Tax Subsidies)
(million dollars/year and cents/gallon; 2004 dollars,
7% ROI before taxes, \$53/bbl crude oil price)

	Cost to Gasoline
Total Cost (\$MM/yr)	2,704
Federal Subsidy (\$MM/yr)	-3,491
Revised Total Cost (\$MM/yr)	-787
Per-Gallon Cost Excluding Subsidies (c/gal)	1.79
Federal Subsidy (c/gal)	-2.32
Total Cost Including Subsidies (c/gal)	-0.53

Table 4.4-30.
Estimated E10 Case Cost (Reflecting Ethanol Tax Subsidies)
(million dollars/year and cents/gallon; 2004 dollars,
7% ROI before taxes, \$92/bbl crude oil price)

	Cost to Gasoline
Total Cost (\$MM/yr)	1,179
Federal Subsidy (\$MM/yr)	-3,491
Revised Total Cost (\$MM/yr)	-2,312
Per-Gallon Cost Excluding Subsidies (c/gal)	0.78
Federal Subsidy (c/gal)	-2.32
Total Cost Including Subsidies (c/gal)	-1.54

The cost including subsidies may better represent gasoline and diesel fuel’s apparent cost as reflected to the fuel industry as a whole and to consumers “at the pump” because the federal subsidies tends to transfer a portion of the actual costs. Our analysis estimates that when the oil price is \$53/bbl, the fuel industry and consumers will see a 0.53 cent per gallon decrease in the apparent cost of producing gasoline. At the higher oil price of \$92/bbl, the apparent cost of producing gasoline is estimated to decrease by 1.54 cents per gallon.

Table 4.4-31 summarizes the volumetric inputs to refineries in each PADD for this E10 control case.

**Table 4.4-31.
Summary of the Total and Incremental Volumetric Refinery Inputs by PADD
(thousand barrels/day)**

	PADD 1		PADD 2		PADD 3		PADD 4/5		CA	
	Control Case	Difference from Ref Case	Control Case	Difference from Ref Case	Control Case	Difference from Ref Case	Control Case	Difference from Ref Case	Control Case	Difference from Ref Case
PADD Crude	1,525	0	3,444	-118	9,037	-63	1,750	3	2,138	1
GTL Naphtha	0	0	0	0	0	0	0	0	0	0
GTL Diesel	0	0	0	0	0	0	0	0	0	0
VGO HS	0	0	0	0	613	-8	0	0	28	-1
VGO LS	0	0	1	0	0	0	0	0	0	0
HS AR (A960)	0	0	0	0	0	0	0	0	0	0
LS AR (Alg)	205	4	0	0	137	8	0	0	0	0
Normal Butane	25	-1	45	-10	112	0	36	-1	40	0
Isobutane	9	0	23	2	62	-4	13	-1	23	0
MTBE	0	0	0	0	0	0	0	0	0	0
Ethanol - E10	404	58	250	59	217	121	87	31	172	0
Ethanol - E20	0	0	0	0	0	0	0	0	0	0
Ethanol - E85	0	0	0	0	0	0	0	0	0	0
Reformer Feed	0	0	0	0	0	0	0	0	0	0
Methanol	0	0	0	0	0	0	0	0	0	0
Natural Gas (FOE)	80	1	142	2	576	6	122	1	172	0
Hydrogen (MSCF)	0	0	0	0	0	0	0	0	0	0
Pentanes Plus	0	0	32	0	52	0	19	0	0	0
Import CBOB 10%	421	421	0	0	0	0	0	0	0	0
Import CBOB 20%	0	0	0	0	0	0	0	0	0	0
Import RBOB 10%	187	-13	0	0	0	0	0	0	0	0
Import RBOB 20%	0	0	0	0	0	0	0	0	0	0
Import Alkylate	31	15	0	0	0	0	0	0	0	0
Import Raffinate	33	-15	0	0	0	0	0	0	46	0
Import Reformate	0	0	0	0	0	0	0	0	0	0
Import FCC Naphtha	0	0	0	0	0	0	0	0	0	0
Import Lt Naphtha	0	0	0	0	21	-9	0	0	1	0
Import Hvy Naph	0	0	0	0	42	0	0	0	0	0
Transfer Lt Naphtha	0	0	0	0	0	0	0	0	22	-2
Transfer Reformate	0	0	0	-5	0	0	0	0	0	0
Transfer Alkylate	60	0	10	7	0	0	0	0	60	0
Transfer FCC Naphtha	0	0	0	0	0	0	0	0	0	0
Transfer Raffinate	0	0	0	-2	0	0	0	0	60	0
Transfer RBOB 10%	734	38	79	29	0	0	0	0	0	0
Transfer RBOB 20%	0	0	0	0	0	0	0	0	0	0
Transfer CBOB 10%	1,300	2	421	-29	0	0	14	14	0	0
Transfer CBOB 20%	0	0	0	0	0	0	0	0	0	0
Isooctane	0	0	0	0	0	0	0	0	29	1
Isooctene	10	-1	2	0	0	0	0	0	0	0

Table 4.4-32 below summarizes the refinery output volumes and changes in refinery output volumes relative to the reference case by PADD.

**Table 4.4-32.
Summary of Total and Incremental Refinery Outputs by PADD
(thousand barrels/day)**

	PADD 1		PADD 2		PADD 3		PADD 4/5		CA	
	Control Case	Difference from Ref Case	Control Case	Difference from Ref Case	Control Case	Difference from Ref Case	Control Case	Difference from Ref Case	Control Case	Difference from Ref Case
Propane	35	1	59	-5	139	-6	27	-1	59	1
Propylene	19	0	43	0	245	0	2	0	12	0
Normal Butane	0	0	3	-1	47	2	0	0	0	0
Isobutane	0	0	0	0	0	0	0	0	10	1
PC Naphtha	16	0	40	0	433	0	0	0	0	0
PC Gasoil	0	0	527	-29	158	0	0	0	0	0
CG Reg	0	-73	0	-552	0	-1,176	0	-246	0	0
CG Prem	0	0	0	0	0	-2	0	-33	0	0
CG E10 Reg	1,935	455	1,745	573	1,334	1,192	723	273	114	2
CG E10 Prem	339	80	332	4	254	3	138	38	22	0
RFG E10 Reg	1,455	34	332	4	469	6	0	0	1,312	0
RFG E10 Prem	273	2	63	1	89	1	0	0	250	0
CG E20 Reg	0	0	0	0	0	0	0	0	0	0
RFG E20 Reg	0	0	0	0	0	0	0	0	0	0
E85 to CG	0	0	0	0	0	0	0	0	0	0
E85 to RFG	0	0	0	0	0	0	0	0	0	0
Transfer RBOB 10%	0	0	0	0	813	67	0	0	0	0
Transfer RBOB 20%	0	0	0	0	0	0	0	0	0	0
Transfer CBOB 10%	0	0	0	0	1,735	-13	0	0	0	0
Transfer CBOB 20%	0	0	0	0	0	0	0	0	0	0
Jet/Kero A (450ppm)	27	0	115	0	1,363	0	380	0	300	0
X-Fer Diesel Rundown	0	0	0	0	0	0	0	0	0	0
HSD Gr 76 (0.2%)	0	0	0	0	0	0	0	0	0	0
LSD Gr 74 (.05%)	0	0	0	0	0	0	0	0	0	0
ULSD (15 ppm)	556	5	627	-50	2,210	-14	524	12	0	0
CARB Diesel	0	0	0	0	0	0	0	0	354	-4
X-Fer C5's to Storage	0	0	0	0	0	0	0	0	0	0
1% Residual Fuel	0	0	0	0	0	0	0	0	0	0
Residual Fuel	70	0	57	0	269	-3	149	4	74	2
Slurry	31	-1	87	-3	158	0	1	1	30	0
Asphalt & Wax	143	0	210	0	158	0	5	0	44	0
Gasoil	0	0	9	0	0	0	0	0	10	0
Lubes	19	0	17	0	158	0	0	0	20	0
Benzene	11	0	11	0	51	0	0	0	0	0
Toluene	0	0	0	0	35	0	0	0	0	0
Xylenes	0	0	0	0	8	0	0	0	0	0
Cumene	0	0	0	0	0	0	0	0	0	0
Cyclohexane	0	0	0	0	0	0	0	0	0	0
Transfer Raffinate	0	0	0	0	60	-2	0	0	0	0
Transfer Alkylate	0	0	0	0	130	7	0	0	0	0
Transfer Reformate	0	0	0	0	0	-5	0	0	0	0
Transfer FCC naphtha	0	0	0	0	0	0	0	0	0	0
Transfer Lt Naphtha	0	0	0	0	0	0	0	0	22	-2
Transfer Blendstock	0	0	0	0	0	0	0	0	0	0
Sulfur (STons)	1	0	4	0	17	0	3	0	4	0
Coke (STon)	2	0	13	-1	68	-1	7	0	20	0

Table 4.4-34 summarizes the change in refinery unit throughputs by PADD comparing the E10 case to the reference case.

Table 4.4-34.
Change in Refinery Unit Capacities by PADD relative to the Reference Case
(thousand barrels/day)

Refinery Unit	PADD 1	PADD 2	PADD 3	PADD 4/5	CA	U.S.
Crude Tower	0	-202	-59	0	0	-261
Vacuum Tower	0	-90	-29	4	0	-115
Sats Gas Plant	0	0	-10	2	0	-8
Unsats Gas Plant	0	-1	-6	0	0	-6
FCC DeC5 Tower	0	0	0	0	0	0
FCC	0	0	-18	0	-4	-22
FCC Splitter	1	-6	-10	0	-1	-16
Hydrocracker	0	0	0	3	0	3
H-Oil Unit	0	0	0	0	0	0
Delayed Coker	0	0	-11	0	0	-11
Visbreaker	0	0	0	0	0	0
Thermal Naphtha Splitter	0	-4	-1	0	0	-5
CRU Reformer	0	0	0	0	0	0
SRU Reformer	0	0	0	0	3	3
BTX Reformer	0	0	0	0	0	0
C4 Isomerization	0	0	0	0	0	0
C5/C6 Isomerization	4	0	0	0	0	4
HF Alkylation	0	0	0	0	0	0
H2SO4 Alkylation	0	0	-7	2	-5	-9
Dimersol	0	0	0	0	0	0
Cat Poly	0	0	0	0	0	0
Isooctane	0	0	0	0	0	0
DHT - Total	7	0	-12	11	0	6
DHT 2nd RCT - Total	6	-25	-11	9	0	-21
DHT Arom Saturation	0	0	0	0	0	0
NHT - Total Fd	1	0	0	-1	0	0
CGH - Generic	-4	16	12	-15	0	8
CGH - Olefin Sat'n	0	0	0	0	0	0
FCCU Fd HDT	7	0	0	-29	0	-22
LSR Splitter	0	17	0	0	0	17
LSR Bz Saturator	0	0	0	0	0	0
Reformate Saturator	-2	0	0	0	0	-2
Reformate Splitter	-6	0	-1	0	0	-7
SDA	0	0	0	0	0	0
MTBE	0	0	0	0	0	0
TAME	0	0	0	0	0	0
Hydrogen Plant - Total MSCF	14	-16	107	17	-3	119
Lube Unit	0	0	0	0	0	0
Sulfur Plant	0	0	-98	-41	-5	-143
Merox Jet	0	0	0	0	0	0
Merox Diesel	0	0	0	0	0	0
BTX Reformer - Tower feed	0	0	0	0	0	0
BTX Reformer - Extract feed	0	0	0	0	0	0

**Table 4.4-35.
Change in Refinery Unit Investments by PADD (million dollars/yr)**

Refinery Unit	PADD 1	PADD 2	PADD 3	PADD 4/5	CA	U.S.
Crude Tower	0	-486	-62	0	0	-547
Vacuum Tower	0	-219	-34	83	0	-170
Sats Gas Plant	0	0	-38	5	0	-34
Unsats Gas Plant	2	0	-52	0	0	-49
FCC DeC5 Tower	0	0	0	0	0	0
FCC	0	0	-225	0	-26	-251
FCC Splitter	0	-6	-3	0	0	-10
Hydrocracker	0	0	0	49	0	49
H-Oil Unit	0	0	0	0	0	0
Delayed Coker	0	0	-121	0	0	-121
Visbreaker	0	0	0	0	0	0
Thermal Naphtha Splitter	0	-4	0	0	0	-5
CRU Reformer	0	0	0	0	0	0
SRU Reformer	0	0	0	0	71	71
BTX Reformer	0	0	0	0	0	0
C4 Isomerization	0	0	0	0	0	0
C5/C6 Isomerization	26	0	0	0	0	26
HF Alkylation	0	0	0	0	0	0
H2SO4 Alkylation	5	0	-57	20	-104	-136
Dimersol	0	0	0	0	0	0
Cat Poly	0	0	0	0	0	0
Isooctane	0	0	0	0	0	0
DHT - Total	45	0	-125	64	0	-15
DHT 2nd RCT - Total	28	-167	-34	40	0	-133
DHT Arom Saturation	0	0	0	0	0	0
NHT - Total Fd	4	0	0	-4	0	0
CGH - Generic	-22	101	28	-58	0	49
CGH - Olefin Sat'n	0	0	0	0	0	0
FCCU Fd HDT	51	0	0	-314	0	-264
LSR Splitter	0	7	0	0	0	7
LSR Bz Saturator	0	0	0	0	0	0
Reformate Saturator	-9	0	-1	0	0	-10
Reformate Splitter	-15	0	-1	0	0	-15
SDA	0	0	0	0	0	0
MTBE	0	0	0	0	0	0
TAME	0	0	0	0	0	0
Hydrogen Plant - Total MSCF	38	-37	284	87	-40	332
Lube Unit	0	0	0	0	0	0
Sulfur Plant	0	0	0	0	0	0
Merox Jet	0	0	0	0	0	0
Merox Diesel	0	0	0	0	0	0
BTX Reformer - Tower feed	0	0	0	0	0	0
BTX Reformer - Extract feed	0	0	0	0	0	0
Total	153	-811	-440	-29	0	-1,226

These changes in refinery unit throughputs are associated with changes in capital investments. Table 4.4-35 summarizes the projected change in capital investments between the reference case and the EIA control case. This Table shows that incremental to the reference case, refiners are expected to reduce their capital investments by \$1.2 billion compared to business as usual. Most of the reduction occurs in PADDs 2 and 3. This capital cost decrease is countered by the capital costs incurred to build new ethanol plants and put into place the distribution system that the new ethanol requires.

**Table 4.4-36.
Gasoline Volume, Quality and Energy Density by Gasoline Type at the PADD Terminal**

RFG	PADD 1		PADD 2		PADD 3		PADD 4/5		CA		US	
	Ref Case	Control	Ref Case	Control	Ref Case	Control	Ref Case	Control	Ref Case	Control	Ref Case	Control
Total ('000 BPD)	1,692	1,728	391	396	551	558	-	-	1,562	1,562	4,197	4,244
Ethanol ('000 BPD)	171	175	39	40	56	56	-	-	158	158	424	429
RVP (psi)	10.7	10.8	10.4	10.6	9.7	9.8	-	-	9.5	9.5	10.1	10.2
Sulfur (ppm)	23	24	23	24	20	22	-	-	9	9	17	18
Octane (R+M/2)	88.1	88.1	88.0	88.0	88.0	88.0	-	-	87.6	87.6	87.9	87.9
Aromatics (vol%)	19.9	19.9	20.0	20.0	19.5	19.5	-	-	21.3	21.3	20.4	20.4
Benzene (vol%)	0.55	0.56	0.58	0.58	0.51	0.51	-	-	0.51	0.51	0.53	0.54
Olefins (vol%)	11.7	12.2	10.3	10.6	8.7	9.3	-	-	5.7	5.7	8.9	9.3
Oxygen (wt%)	3.7	3.7	3.7	3.7	3.7	3.7	-	-	3.7	3.7	3.7	3.7
E200 (vol%)	55.1	55.3	59.7	57.8	54.3	53.9	-	-	57.7	57.6	56.4	56.2
E300 (vol%)	93.9	93.9	84.3	82.9	87.4	85.8	-	-	86.2	86.2	89.3	89.0
Energy (MMBtu/Bbl)	4.954	4.950	4.920	4.939	4.983	4.976	-	-	4.991	4.992	4.969	4.968
CG												
Total ('000 BPD)	2,263	2,274	2,052	2,078	1,568	1,588	829	1,588	135	136	6,847	6,937
Ethanol ('000 BPD)	176	230	152	210	40	160	56	160	14	14	436	701
RVP (psi)	11.6	11.8	11.7	11.5	10.7	10.7	11.3	10.7	10.5	10.6	11.4	11.4
Sulfur (ppm)	24	24	23	24	24	22	27	22	25	24	24	24
Octane (R+M/2)	87.7	88.1	88.0	88.0	88.0	88.0	86.9	88.0	89.1	89.2	87.8	87.9
Aromatics (vol%)	24.2	22.3	24.4	22.5	27.2	22.2	19.4	22.2	28.4	29.0	24.4	21.7
Benzene (vol%)	0.61	0.51	0.64	0.53	0.59	0.50	1.16	0.50	0.60	0.60	0.68	0.58
Olefins (vol%)	13.9	14.5	11.1	10.7	14.9	12.1	6.9	12.1	17.1	16.6	12.5	11.9
Oxygen (wt%)	2.9	3.7	2.7	3.7	0.9	3.7	2.5	3.7	3.6	3.6	2.3	3.7
E200 (vol%)	55.4	55.4	55.7	58.9	46.5	55.0	59.6	55.0	55.8	55.2	54.0	57.3
E300 (vol%)	93.4	93.9	84.3	82.9	87.4	85.8	83.5	85.8	86.2	86.2	87.9	88.1
Energy (MMBtu/Bbl)	4.980	4.931	4.965	4.923	5.069	4.971	5.011	4.971	4.969	4.973	4.999	4.942
All Mogas												
Total ('000 BPD)	3,955	4,003	2,443	2,473	2,120	2,146	829	861	1,697	1,698	11,044	11,181
Ethanol ('000 BPD)	347	404	191	250	95	217	56	87	171	172	860	1,129
RVP (psi)	11.2	11.3	11.5	11.4	10.5	10.4	11.3	11.4	9.6	9.6	10.9	10.9
Sulfur (ppm)	24	24	23	24	23	22	27	28	10	10	22	22
Octane (R+M/2)	87.9	88.1	88.0	88.0	88.0	88.0	86.9	86.9	87.8	87.8	87.8	87.9
Aromatics (vol%)	22.4	21.3	23.7	22.1	25.2	21.5	19.4	16.3	21.8	21.9	22.9	21.2
Benzene (vol%)	0.58	0.53	0.63	0.54	0.57	0.50	1.16	1.04	0.52	0.52	0.62	0.57
Olefins (vol%)	12.9	13.5	10.9	10.6	13.3	11.4	6.9	6.7	6.6	6.6	11.1	10.9
Oxygen (wt%)	3.2	3.7	2.9	3.7	1.7	3.7	2.5	3.8	3.7	3.7	2.9	3.7
E200 (vol%)	55.3	55.3	56.4	58.7	48.5	54.7	59.6	63.3	57.5	57.4	54.9	56.9
E300 (vol%)	93.6	93.9	84.3	82.9	87.4	85.8	83.5	90.2	86.2	86.2	88.4	88.5
Energy (MMBtu/Bbl)	4.969	4.939	4.958	4.926	5.046	4.972	5.011	4.957	4.989	4.990	4.988	4.952

4.4.2.2.2 Mid-Ethanol Blend Sensitivity Case

For this case, the year 2022 control case volumes were run assuming that ethanol was mostly blended as E20. About 10 percent of the gasoline pool was required to remain E10 to provide gasoline that would be compatible with nonroad gasoline powered engines and legacy cars. Most of the remainder of the gasoline was blended with ethanol at 20 percent by volume until the gasoline pool was saturated, allowing for a small amount of E85 to achieve the necessary volume of ethanol to comply with the RFS2 standard.

Tables 4.4-37 and 4.4-38 summarize the costs for the RFS case excluding federal ethanol, biodiesel and renewable fuels consumption subsidies with crude oil priced at \$53/bbl and \$92/bbl, respectively. The costs are reported by different cost component as well as aggregated total and the per-gallon costs. ^{KKKKKKKKKK} The operating costs include the labor, utility and other

operating costs and are a direct output from the refinery model. These costs are adjusted to reflect ethanol's production cost plus distribution costs instead of the ethanol prices used in the refinery cost model. The fixed costs are 3 percent of the capital costs. The costs associated with lower energy density gasoline are accounted for using the fractional change in energy density shown in Table 4.4-37, multiplied times the wholesale price of gasoline.

Table 4.4-37.

Summary of Mid-Ethanol Blend Case Costs (without Tax Subsidies)

(million dollars/year and c/gal, except as noted; 2004 dollars, 7% ROI before taxes, \$53/bbl crude oil price)

	Cost to Gasoline	Cost to Diesel Fuel
Refinery Capital Costs (\$Billion)	-7.30	-
Amortized Refinery Capital Costs (\$MM/yr)	-780	-
Fixed Operating Cost (\$MM/yr)	-215	-
Variable Operating Cost (\$MM/yr)	5,404	590
Lower Energy Density Gasoline (\$MM/yr)	9,630	187
Total Cost (\$MM/yr)	14,043	777
Refinery Capital Costs (c/gal)	-0.44	-
Fixed Operating Cost (c/gal)	-0.12	-
Variable Operating Cost (c/gal)	4.15	0.66
Lower Energy Density Gasoline (c/gal)	5.45	0.54
Total Cost Excluding Subsidies (c/gal)	9.04	1.20

Table 4.4-38.

Summary of Mid-Ethanol Blend Case Costs (without Tax Subsidies)

(million dollars/year and c/gal, except as noted; 2004 dollars, 7% ROI before taxes, \$92/bbl crude oil price)

	Cost to Gasoline	Cost to Diesel Fuel
Amortized Refinery Capital Costs (\$MM/yr)	-780	-
Fixed Operating Cost (\$MM/yr)	-215	-
Variable Operating Cost (\$MM/yr)	-16,662	-419
Lower Energy Density Gasoline (\$MM/yr)	16,390	373
Total Cost (\$MM/yr)	-1,267	-46
Refinery Capital Costs (c/gal)	-0.44	-
Fixed Operating Cost (c/gal)	-0.12	-
Variable Operating Cost (c/gal)	-9.53	-1.15
Lower Energy Density Gasoline (c/gal)	9.28	1.08
Total Cost Excluding Subsidies (c/gal)	-0.82	-0.07

Our analysis shows that when considering all the costs associated with these fuel changes resulting from the expanded use of ethanol that these various possible gasoline use scenarios will cost the U.S. \$14.0 billion per year in the year 2022 when crude oil is priced at \$53 per barrel. Expressed as per-gallon costs, these fuel changes would cost the U.S. 9.04 cents per gallon of gasoline. The addition of biodiesel and renewable diesel fuel is estimated to cost about \$780 million per year in the year 2022, or cost 1.20 cents per gallon.

At \$92 per barrel crude oil, the addition of the ethanol is estimated to decrease the cost of

KKKKKKKKK EPA typically assesses social benefits and costs of a rulemaking. However, this analysis is more limited in its scope by examining the average cost of production of ethanol and gasoline without accounting for the effects of farm subsidies that tend to distort the market price of agricultural commodities.

producing gasoline in 2022 by 1.3 billion per year, or 0.82 cents per gallon. The addition of biodiesel and renewable diesel fuel is estimated to reduce the cost of diesel fuel by 46 million dollars in 2022, and reduce the per-gallon cost of diesel fuel by 0.07 cents per gallon.

Tables 4.4-39 and 4.4-40 expresses the total and per-gallon gasoline costs for the RFS case with the federal ethanol, biodiesel and renewable diesel subsidies included with crude oil priced at \$53/bbl and \$92/bbl, respectively. The federal tax subsidy is 45 cents per gallon for each gallon of new corn-based ethanol blended into gasoline and 101 cents per gallon for each gallon of cellulosic ethanol. The biodiesel subsidy is 100 cents per gallon, and the renewable diesel fuel subsidy is 50 cents per gallon. The cost adjustment is estimated by multiplying the subsidy times the volume of new ethanol, biodiesel and renewable diesel estimated to be used.

Table 4.4-39.

Estimated Mid-Ethanol Blend Case Costs (Reflecting Tax Subsidies)

(million dollars/year and cents/gallon; 2004 dollars, 7% ROI before taxes, \$52/bbl crude oil price)

	Gasoline Costs	Diesel Fuel Costs
Total Cost (\$MM/yr)	11,561	777
Federal Subsidy (\$MM/yr)	-17,699	-525
Revised Total Cost (\$MM/yr)	-6,139	252
Per-Gallon Cost Excluding Subsidies (c/gal)	7.44	1.20
Federal Subsidy (c/gal)	-11.39	-0.81
Total Cost Including Subsidies (c/gal)	-3.95	0.39

Table 4.4-40.

Estimated Mid-Ethanol Blend Case Costs (Reflecting Tax Subsidies)

(million dollars/year and cents/gallon; 2004 dollars, 7% ROI before taxes, \$93/bbl crude oil price)

	Gasoline Costs	Diesel Fuel Costs
Total Cost (\$MM/yr)	-3,749	-46
Federal Subsidy (\$MM/yr)	-17,699	-535
Revised Total Cost (\$MM/yr)	-21,449	-571
Per-Gallon Cost Excluding Subsidies (c/gal)	-2.41	-0.07
Federal Subsidy (c/gal)	-11.39	-0.81
Total Cost Including Subsidies (c/gal)	-13.80	-0.88

The cost including subsidies may better represent gasoline and diesel fuel's apparent cost as reflected to the fuel industry as a whole and to consumers "at the pump" because the federal subsidies tends to transfer a portion of the actual costs. Our analysis estimates that when the oil price is \$53/bbl, the fuel industry and consumers will see a 3.95 cent per gallon decrease in the apparent cost of producing gasoline, and a 0.39 increase in the apparent cost of producing diesel fuel. At the higher oil price of \$93/bbl, the apparent cost of producing gasoline is estimated to decrease by 13.8 cents per gallon, and the apparent cost of producing diesel fuel is expected to decrease by 0.88 cents per gallon.

Table 4.4-41 summarizes the volumetric inputs to refineries in each PADD for this control case. Because of the increased use of biofuels, petroleum inputs would be expected to decrease, and this is confirmed.

Table 4.4-41.
Summary of the Total and Incremental Volumetric Refinery Inputs by PADD
(thousand barrels/day)

	PADD 1		PADD 2		PADD 3		PADD 4/5		CA	
	Control Case	Difference from Ref Case	Control Case	Difference from Ref Case	Control Case	Difference from Ref Case	Control Case	Difference from Ref Case	Control Case	Difference from Ref Case
PADD Crude	1,525	0	3,316	-247	8,633	-467	1,703	-44	2,121	0
GTL Naphtha	0	0	0	0	0	0	0	0	0	0
GTL Diesel	0	0	0	0	0	0	0	0	0	0
VGO HS	0	0	0	0	551	-70	0	0	7	0
VGO LS	0	0	1	0	0	0	0	0	0	0
HS AR (A960)	0	0	0	0	0	0	0	0	0	0
LS AR (Alg)	199	-2	0	0	199	70	0	0	0	0
Normal Butane	28	2	38	-16	112	0	42	5	40	0
Isobutane	14	4	22	1	62	-5	14	0	0	0
MTBE	0	0	0	0	0	0	0	0	0	0
Ethanol - E10	62	-285	39	-152	34	-62	13	-42	27	0
Ethanol - E20	699	699	438	438	358	358	153	153	310	0
Ethanol - E85	0	0	0	0	94	94	0	0	0	0
Reformer Feed	0	0	0	0	0	0	0	0	0	0
Methanol	0	0	0	0	0	0	0	0	0	0
Natural Gas (FOE)	78	-1	143	3	570	1	122	0	176	0
Hydrogen (MSCF)	0	0	0	0	0	0	0	0	0	0
Pentanes Plus	0	0	0	-32	52	0	8	-10	0	0
Import CBOB 10%	277	277	0	0	0	0	0	0	0	0
Import CBOB 20%	0	0	0	0	0	0	0	0	0	0
Import RBOB 10%	123	-77	0	0	0	0	0	0	0	0
Import RBOB 20%	0	0	0	0	0	0	0	0	0	0
Import Alkylate	25	9	0	0	0	0	0	0	0	0
Import Raffinate	39	-9	0	0	0	0	0	0	46	0
Import Reformate	0	0	0	0	0	0	0	0	0	0
Import FCC Naphtha	0	0	0	0	0	0	0	0	0	0
Import Lt Naphtha	0	0	0	0	16	-14	0	0	1	0
Import Hvy Naph	0	0	0	0	42	0	0	0	0	0
Transfer Lt Naphtha	0	0	4	4	0	0	0	0	0	0
Transfer Reformate	0	0	0	-5	0	0	0	0	0	0
Transfer Alkylate	60	0	6	3	0	0	0	0	23	0
Transfer FCC Naphtha	0	0	0	0	0	0	0	0	0	0
Transfer Raffinate	0	0	0	-2	0	0	0	0	60	0
Transfer RBOB 10%	650	-47	79	29	0	0	0	0	0	0
Transfer RBOB 20%	0	0	0	0	0	0	0	0	0	0
Transfer CBOB 10%	1,300	2	421	-29	0	0	17	17	0	0
Transfer CBOB 20%	0	0	0	0	0	0	0	0	0	0
Isooctane	7	7	0	0	0	0	0	0	42	0
Isocetene	21	10	0	-2	8	8	0	0	5	0

Table 4.4-42.
Summary of Total and Incremental Refinery Outputs by PADD
(thousand barrels/day)

	PADD 1		PADD 2		PADD 3		PADD 4/5		CA	
	Control Case	Difference from Ref Case	Control Case	Difference from Ref Case	Control Case	Difference from Ref Case	Control Case	Difference from Ref Case	Control Case	Difference from Ref Case
Propane	33	-1	53	-11	130	-15	22	-6	55	-3
Propylene	19	0	43	0	245	0	2	0	12	0
Normal Butane	0	0	6	2	45	0	0	0	0	0
Isobutane	0	0	0	0	0	0	0	0	19	10
PC Naphtha	16	0	40	0	433	0	0	0	0	0
PC Gasoil	0	0	495	-60	158	0	0	0	0	0
CG Reg	0	-73	0	-552	0	-1,176	0	-246	0	0
CG Prem	0	0	0	0	0	-2	0	-33	0	0
CG E10 Reg	0	-1,480	0	-1,172	0	-141	0	-450	0	-113
CG E10 Prem	334	75	317	-11	240	-11	134	34	18	-4
RFG E10 Reg	0	-1,421	0	-328	0	-463	0	0	0	-1,312
RFG E10 Prem	276	5	65	3	92	4	0	0	253	3
CG E20 Reg	2,009	2,009	1,825	1,825	1,397	1,397	757	757	125	125
RFG E20 Reg	1,449	1,449	343	343	373	373	0	0	1,409	1,409
E85 to CG	0	0	0	0	0	0	0	0	0	0
E85 to RFG	0	0	0	0	110	110	0	0	0	0
Transfer RBOB 10%	0	0	0	0	729	-17	0	0	0	0
Transfer RBOB 20%	0	0	0	0	0	0	0	0	0	0
Transfer CBOB 10%	0	0	0	0	1,738	-11	0	0	0	0
Transfer CBOB 20%	0	0	0	0	0	0	0	0	0	0
Jet/Kero A (450ppm)	27	0	115	0	1,363	0	380	0	300	0
X-Fer Diesel Rundown	0	0	0	0	0	0	0	0	0	0
HSD Gr 76 (0.2%)	0	0	0	0	0	0	0	0	0	0
LSD Gr 74 (.05%)	0	0	0	0	0	0	0	0	0	0
ULSD (15 ppm)	559	8	650	-27	2,182	-41	526	14	0	0
CARB Diesel	0	0	0	0	0	0	0	0	354	-4
X-Fer C5's to Storage	0	0	0	0	0	0	0	0	41	41
1% Residual Fuel	0	0	0	0	0	0	0	0	0	0
Residual Fuel	83	12	57	0	244	-28	146	1	54	-18
Slurry	29	-3	80	-9	153	-5	0	0	30	0
Asphalt & Wax	143	0	210	0	158	0	5	0	44	0
Gasoil	0	0	0	0	0	0	0	0	10	0
Lubes	19	0	17	0	158	0	0	0	20	0
Benzene	11	0	11	0	51	0	0	0	0	0
Toluene	0	0	0	0	35	0	0	0	0	0
Xylenes	0	0	0	0	8	0	0	0	0	0
Cumene	0	0	0	0	0	0	0	0	0	0
Cyclohexane	0	0	0	0	0	0	0	0	0	0
Transfer Raffinate	0	0	0	0	60	-2	0	0	0	0
Transfer Alkylate	0	0	0	0	89	-34	0	0	0	0
Transfer Reformate	0	0	0	0	0	-5	0	0	0	0
Transfer FCC naphtha	0	0	0	0	0	0	0	0	0	0
Transfer Lt Naphtha	0	0	0	0	4	4	0	0	0	-24
Transfer Blendstock	0	0	0	0	0	0	0	0	0	0
Sulfur (STons)	1	0	4	0	16	-1	2	0	4	0
Coke (STon)	1	0	12	-2	64	-5	7	0	21	1

Table 4.4-43 summarizes the change in refinery unit throughputs by PADD comparing the mid-ethanol blend case to the reference case.

Table 4.4-43.
Change in Refinery Unit Capacities by PADD relative to the Reference Case
 (thousand barrels/day)

Refinery Unit	PADD 1	PADD 2	PADD 3	PADD 4/5	CA	U.S.
Crude Tower	0	-421	-467	-41	-1	-930
Vacuum Tower	0	-188	-200	-11	0	-399
Sats Gas Plant	9	0	-24	-22	-14	-51
Unsats Gas Plant	0	-1	-46	0	-12	-59
FCC DeC5 Tower	0	0	0	0	0	0
FCC	0	0	-151	0	-63	-214
FCC Splitter	0	-6	-82	0	-20	-108
Hydrocracker	0	0	0	-5	0	-5
H-Oil Unit	0	0	0	0	0	0
Delayed Coker	0	0	-91	0	0	-91
Visbreaker	0	0	0	0	0	0
Thermal Naphtha Splitter	0	-4	-11	0	1	-14
CRU Reformer	0	0	0	0	0	0
SRU Reformer	0	0	0	0	-30	-30
BTX Reformer	0	1	0	0	0	1
C4 Isomerization	0	0	0	0	-3	-3
C5/C6 Isomerization	-16	0	0	0	0	-16
HF Alkylation	0	0	0	0	0	0
H2SO4 Alkylation	27	0	-46	-8	-29	-56
Dimersol	0	0	0	0	0	0
Cat Poly	0	0	0	0	0	0
Isooctane	0	0	0	0	0	0
DHT - Total	10	0	-17	-1	0	-8
DHT 2nd RCT - Total	15	56	-17	-8	24	71
DHT Arom Saturation	0	0	0	0	0	0
NHT - Total Fd	14	0	0	11	0	25
CGH - Generic	11	-49	-51	10	0	-79
CGH - Olefin Sat'n	0	0	0	0	0	0
FCCU Fd HDT	-1	0	0	-34	0	-35
LSR Splitter	0	17	0	0	0	17
LSR Bz Saturator	0	0	0	0	0	0
Reformate Saturator	-16	-9	5	0	-50	-70
Reformate Splitter	-48	-27	15	0	-150	-210
SDA	0	0	0	0	0	0
MTBE	0	0	0	0	0	0
TAME	0	0	0	0	0	0
Hydrogen Plant - Total MSCF	-2	81	253	17	83	432
Lube Unit	0	0	0	0	0	0
Sulfur Plant	0	0	-935	-98	-11	-1,044
Merox Jet	0	0	0	0	0	0
Merox Diesel	0	0	0	0	0	0
BTX Reformer - Tower feed	0	0	0	0	0	0
BTX Reformer - Extract feed	0	1	0	0	0	1

These changes in refinery unit throughputs are associated with changes in capital investments. Table 4.4-44 summarizes the projected change in capital investments between the mid-ethanol blend case and the reference case.

Table 4.4-44.
Change in Refinery Unit Investments by PADD (million dollars/yr)

Refinery Unit	PADD 1	PADD 2	PADD 3	PADD 4/5	CA	U.S.
Crude Tower	0	-995	-739	-154	-1	-1,889
Vacuum Tower	0	-527	-423	-18	-1	-968
Sats Gas Plant	53	0	-63	-102	-68	-181
Unsats Gas Plant	1	0	-240	0	-101	-341
FCC DeC5 Tower	0	0	0	0	0	0
FCC	0	0	-1,032	0	-786	-1,818
FCC Splitter	0	-6	-38	0	-16	-60
Hydrocracker	0	0	0	-95	0	-95
H-Oil Unit	0	0	0	0	0	0
Delayed Coker	0	0	-1,261	0	0	-1,261
Visbreaker	0	0	0	0	0	0
Thermal Naphtha Splitter	0	-5	-4	0	1	-9
CRU Reformer	0	0	0	0	0	0
SRU Reformer	0	0	0	0	-180	-180
BTX Reformer	2	11	0	0	0	13
C4 Isomerization	0	0	0	0	-15	-15
C5/C6 Isomerization	-198	0	0	0	0	-198
HF Alkylation	0	0	0	0	0	0
H2SO4 Alkylation	443	0	-518	-99	-508	-682
Dimersol	0	0	0	0	0	0
Cat Poly	0	0	0	0	0	0
Isooctane	0	0	0	0	0	0
DHT - Total	63	0	-146	-6	0	-89
DHT 2nd RCT - Total	66	354	-104	-34	186	468
DHT Arom Saturation	0	0	0	0	0	0
NHT - Total Fd	97	0	0	35	0	132
CGH - Generic	46	-203	-202	34	0	-325
CGH - Olefin Sat'n	0	0	0	0	0	0
FCCU Fd HDT	-9	0	0	-349	0	-358
LSR Splitter	0	7	0	0	0	7
LSR Bz Saturator	0	0	0	0	0	0
Reformate Saturator	-96	-56	14	0	-318	-455
Reformate Splitter	-56	-33	8	0	-166	-247
SDA	0	0	0	0	0	0
MTBE	0	0	0	0	0	0
TAME	0	0	0	0	0	0
Hydrogen Plant - Total MSCF	-5	266	607	84	289	1,241
Lube Unit	0	0	0	0	0	0
Sulfur Plant	0	0	-2	-1	0	-3
Merox Jet	0	0	0	0	0	0
Merox Diesel	0	0	0	0	0	0
BTX Reformer - Tower feed	0	1	0	0	0	1
BTX Reformer - Extract feed	0	3	0	0	0	4
Total	407	-1,183	-4,144	-703	0	-7,308

Table 4.4-44 shows that incremental to the reference case, refiners are expected to reduce their capital investments by \$7.3 billion compared to business as usual. Most of the reduction occurs in PADDs 2 and 3 where large volumes of ethanol, and other gasoline blendstocks are expected to enter the gasoline pool. Of course, this capital cost decrease is countered by capital costs incurred to build new ethanol plants and put into place the distribution system that the new ethanol requires.

Table 4.4-45 summarizes the gasoline qualities for the mid-ethanol blend case and the reference case.

**Table 4.4-45.
Gasoline Volume, Quality and Energy Density by Gasoline Type at the PADD Terminal**

RFG	PADD 1		PADD 2		PADD 3		PADD 4/5		CA		US	
	Ref Case	Control	Ref Case	Control	Ref Case	Control	Ref Case	Control	Ref Case	Control	Ref Case	Control
Total ('000 BPD)	1,692	1,725	391	408	551	465	-	-	1,562	1,661	4,197	4,260
Ethanol ('000 BPD)	171	321	39	76	56	85	-	-	158	310	424	791
RVP (psi)	10.7	10.3	10.4	10.2	9.7	9.1	-	-	9.5	9.3	10.1	9.8
Sulfur (ppm)	23	19	23	18	20	22	-	-	9	9	17	15
Octane (R+M/2)	88.1	90.2	88.0	90.2	88.0	90.3	-	-	87.6	88.3	87.9	89.5
Aromatics (vol%)	19.9	15.6	20.0	15.8	19.5	15.0	-	-	21.3	19.1	20.4	16.9
Benzene (vol%)	0.55	0.46	0.58	0.42	0.51	0.44	-	-	0.51	0.47	0.53	0.46
Olefins (vol%)	11.7	10.8	10.3	7.6	8.7	8.2	-	-	5.7	5.7	8.9	8.2
Oxygen (wt%)	3.7	6.8	3.7	6.8	3.7	6.7	-	-	3.7	6.8	3.7	6.8
E200 (vol%)	55.1	64.2	59.7	65.0	54.3	60.1	-	-	57.7	62.1	56.4	63.0
E300 (vol%)	93.9	89.5	84.3	88.2	87.4	85.6	-	-	86.2	86.2	89.3	87.6
Energy (MMBtu/Bbl)	4.954	4.806	4.920	4.784	4.983	4.848	-	-	4.991	4.905	4.969	4.847
CG												
Total ('000 BPD)	2,263	2,344	2,052	2,142	1,568	1,637	829	891	135	143	6,847	7,156
Ethanol ('000 BPD)	176	440	152	401	40	306	56	166	14	27	436	1,340
RVP (psi)	11.6	11.5	11.7	11.3	10.7	10.4	11.3	11.1	10.5	10.2	11.4	11.1
Sulfur (ppm)	24	22	23	23	24	21	27	28	25	26	24	23
Octane (R+M/2)	87.7	90.2	88.0	90.1	88.0	90.1	86.9	87.2	89.1	90.3	87.8	89.8
Aromatics (vol%)	24.2	20.2	24.4	20.4	27.2	20.2	19.4	13.4	28.4	24.4	24.4	19.5
Benzene (vol%)	0.61	0.45	0.64	0.46	0.59	0.45	1.16	1.02	0.60	0.55	0.68	0.53
Olefins (vol%)	13.9	12.9	11.1	10.2	14.9	11.0	6.9	6.3	17.1	16.8	12.5	10.9
Oxygen (wt%)	2.9	6.9	2.7	6.8	0.9	6.8	2.5	6.9	3.6	6.8	2.3	6.8
E200 (vol%)	55.4	62.2	55.7	64.1	46.5	61.1	59.6	68.5	55.8	64.9	54.0	63.3
E300 (vol%)	93.4	84.9	84.3	86.3	87.4	84.9	83.5	90.9	86.2	83.8	87.9	86.0
Energy (MMBtu/Bbl)	4.980	4.813	4.965	4.809	5.069	4.845	5.011	4.811	4.969	4.841	4.999	4.819
E85												
Total ('000 BPD)	-	0	-	0	-	110	-	0	-	0	-	110
Ethanol ('000 BPD)	-	0	-	0	-	94	-	0	-	0	-	95
RVP (psi)	-	10.5	-	10.5	-	12.2	-	10.3	-	10.4	-	12.2
Sulfur (ppm)	-	10	-	10	-	9	-	10	-	9	-	9
Octane (R+M/2)	-	107.8	-	107.8	-	108.0	-	107.6	-	107.7	-	108.0
Aromatics (vol%)	-	0.7	-	0.7	-	0.0	-	0.7	-	0.7	-	0.0
Benzene (vol%)	-	0.02	-	0.02	-	0.00	-	0.05	-	0.02	-	0.00
Olefins (vol%)	-	2.1	-	2.1	-	2.3	-	0.2	-	1.1	-	2.3
Oxygen (wt%)	-	30.6	-	30.6	-	30.8	-	30.6	-	30.6	-	30.8
E200 (vol%)	-	128.1	-	128.0	-	129.9	-	127.7	-	127.8	-	129.9
E300 (vol%)	-	96.1	-	96.0	-	96.6	-	96.0	-	96.1	-	96.6
Energy (MMBtu/Bbl)	-	3.635	-	3.636	-	3.598	-	3.635	-	3.637	-	3.598
All Mogas												
Total ('000 BPD)	3,955	4,069	2,443	2,550	2,120	2,212	829	891	1,697	1,804	11,044	11,526
Ethanol ('000 BPD)	347	760	191	477	95	485	56	167	171	337	860	2,226
RVP (psi)	11.2	11.0	11.5	11.2	10.5	10.2	11.3	11.1	9.6	9.4	10.9	10.6
Sulfur (ppm)	24	21	23	22	23	21	27	28	10	11	22	20
Octane (R+M/2)	87.9	90.2	88.0	90.1	88.0	91.0	86.9	87.2	87.8	88.5	87.8	89.8
Aromatics (vol%)	22.4	18.3	23.7	19.6	25.2	18.1	19.4	13.4	21.8	19.5	22.9	18.3
Benzene (vol%)	0.58	0.46	0.63	0.46	0.57	0.43	1.16	1.02	0.52	0.48	0.62	0.50
Olefins (vol%)	12.9	12.0	10.9	9.8	13.3	10.0	6.9	6.3	6.6	6.6	11.1	9.9
Oxygen (wt%)	3.2	6.9	2.9	6.8	1.7	8.0	2.5	6.9	3.7	6.8	2.9	7.1
E200 (vol%)	55.3	63.0	56.4	64.2	48.5	64.3	59.6	68.5	57.5	62.4	54.9	63.8
E300 (vol%)	93.6	86.8	84.3	86.6	87.4	85.6	83.5	90.9	86.2	86.0	88.4	86.7
Energy (MMBtu/Bbl)	4.969	4.810	4.958	4.805	5.046	4.784	5.011	4.811	4.989	4.900	4.988	4.818

Chapter 5: Economic Impacts and Benefits

5.1 Agricultural Impacts

5.1.1 Models Utilized

As described in the Preamble, we used a suite of tools to model the potential domestic and international impacts of this rulemaking on the agricultural sector. The Forest and Agricultural Sector Optimization Model (FASOM), developed by Professor Bruce McCarl of Texas A&M University and others, provides detailed information on domestic agricultural and greenhouse gas impacts of renewable fuels. The Food and Agricultural Policy Research Institute (FAPRI) at Iowa State University and the University of Missouri-Columbia maintains a number of econometric models that are capable of providing detailed information on impacts on international agricultural markets from the wider use of renewable fuels in the U.S.

FASOM is a long-term economic model of the U.S. agriculture sector that maximizes total revenues for producers while meeting the demands of consumers. Using a number of inputs, FASOM determines which crops, livestock, and processed agricultural products would be produced in the U.S. In each model simulation, crops compete for price sensitive inputs such as land and labor at the regional level. The cost of these and other inputs are used to determine the price and level of production of primary commodities (e.g., field crops, livestock, and biofuel products). FASOM also estimates prices using costs associated with the processing of primary commodities into secondary products (e.g., converting livestock to meat and dairy, crushing soybeans to soybean meal and oil). FASOM does not capture short-term fluctuations (i.e., month-to-month, annual) in prices and production, however, as it is designed to identify long-term trends.

The FASOM model also contains a forestry component. Running both the forestry and agriculture components of the model would show the interaction between these two sectors. However, the analysis for this proposal only shows the results from the agriculture component with no interaction from the forestry sector, as the forestry component of the model is in the process of being updated. We plan to utilize a complete version of the model for our analysis in the final rule, where agricultural land use impacts also affect forestry land use, and cellulosic ethanol produced from the forestry sector will affect cellulosic ethanol production in the agriculture sector.

FASOM uses supply and demand curves for the 11 major U.S. domestic regions,^{LLLLLLLLL} which are calibrated to historic price and production data. FASOM also includes detailed supply and demand data for corn, wheat, soybeans, rice and sorghum across 37

^{LLLLLLLLL} U.S. regions consist of the Pacific Northwest (West and East), Pacific Southwest, Rocky Mountains, Great Plains, Southwest, South Central, Corn Belt, Lake States, Southeast, and the Northeast.

foreign regions.^{MMMMMMMMMM} FASOM contains transportation costs to all regions and then uses all of this information to determine U.S. exports to the point where prices are then equated in all markets.

We chose to use FASOM to model the full potential impacts on the domestic agricultural sector given higher renewable fuel volumes, in part because FASOM also provides detailed greenhouse gas information resulting from these changes (see Chapter 2 of this RIA for more information). FASOM is not able to model land use and agricultural sector changes internationally, however. Therefore, we are working with the FAPRI models to better understand international agricultural impacts. Additional details on the FASOM model are included in the docket.^{NNNNNNNNN}

The FAPRI models are econometric models covering many agricultural commodities. These models capture the biological, technical, and economic relationships among key variables within a particular commodity and across commodities. They are based on historical data analysis, current academic research, and a reliance on accepted economic, agronomic, and biological relationships in agricultural production and markets. The international modeling system includes international grains, oilseeds, ethanol, sugar, and livestock models. In general, for each commodity sector, the economic relationship that supply equals demand is maintained by determining a market-clearing price for the commodity. In countries where domestic prices are not solved endogenously, these prices are modeled as a function of the world price using a price transmission equation. Since econometric models for each sector can be linked, changes in one commodity sector will impact other sectors. Elasticity values for supply and demand responses are based on econometric analysis and on consensus estimates. Additional details on the FAPRI models are included in the docket.

Agricultural and trade policies for each commodity in a country are included in the models to the extent that they affect the supply and demand decisions of the economic agents. These policies include taxes on exports and imports, tariffs, tariff rate quotas, export subsidies, intervention prices, and set-aside rates. The FAPRI models assume that existing agricultural and trade policy variables will remain unchanged in the outlook period.^{OOOOOOOOO}

We recognize that there are inherent challenges in reconciling the results from two different models, however we believe that using two models provides a more robust analysis than either model would be able to provide alone. Part of the difference in the model results is due to the fact that the two models have different time horizons. Since FASOM is a long term econometric model, short term spikes are smoothed out over the five year reporting period. In comparison, the FAPRI model captures annual fluctuations that may include short-term supply

^{MMMMMMMMMM} FASOM Foreign Regions include: the European Economic Community, North Central Europe, Southwest Europe, Eastern Europe, Adriatic, Eastern Mediterranean, Former Soviet Union, North Africa, East Africa, West Africa, South Africa, Red Sea, Iran, India, Taiwan, Japan, South Korea, North Korea, China, Bangladesh, Indonesia, Myanmar, Pakistan, Philippines, Thailand, Vietnam, West Asia, Southeast Asia, Australia, Caribbean, Eastern Mexico, Eastern South America, Western South America, Argentina, Brazil, Canada, Other.
^{NNNNNNNNN} Beach, Robert; McCarl, Bruce, *Agricultural Impacts of the Energy Independence and Security Act: FASOM Results and Model Description*, RTI International, October, 2008.
^{OOOOOOOOO} *Technical Report: An Analysis of EPA Biofuel Scenarios with the FAPRI International Models*, CARD Staff, November, 2008.

and demand responses. Some of the discrepancies may be attributed to different underlying assumptions pertaining to elasticities of supply and demand for different commodities. These differences, in turn, affect projections of imports and exports, acreage shifting, and total consumption and production of various commodities. Some of the differences in results are described in more detail in the following sections. We will continue to work with the two models to isolate some of the key differences in assumptions and calibrate the models to a more consistent Reference Case in time for the Final Rulemaking.

5.1.2 Volumes

For the agricultural sector analysis using the FASOM and FAPRI models of the RFS2 biofuel volumes, we assumed 15 billion gallons (Bgal) of corn ethanol would be produced for use as transportation fuel by 2022, an increase of 2.7 Bgal from the Reference Case. In addition, we modeled 1.0 Bgal per year of biodiesel use as fuel, an increase of 0.6 Bgal from the Reference Case, as well as an increase of 10 Bgal of cellulosic ethanol in 2022 from the agriculture sector. To satisfy the cellulosic ethanol requirements, the FASOM model was able to choose how much cellulosic ethanol was produced through the different production pathways. This is purely based on the economics of each feedstock, taking account the various harvesting and processing costs for each feedstock, and the income the agriculture sector derives from each feedstock. In FASOM, this volume consists of 7.5 billion gallons of cellulosic ethanol coming from corn residue in 2022, 1.3 billion gallons from switchgrass and 1.4 billion gallons from sugarcane bagasse. The volumes for the individual cellulosic ethanol feedstocks were not set exogenously.

Given the short time frame for conducting this analysis, some of the projected sources of biofuels analyzed in the RFS2 proposal are not currently modeled in FASOM and FAPRI. For example, biodiesel from corn oil fractionation is not currently accounted for in FASOM. In addition, since FASOM is a domestic agricultural sector model, it can't be utilized to examine U.S. biofuel imports. Also, neither of the two models used for this analysis — FASOM or FAPRI — include biofuels derived from domestic municipal solid waste or from the U.S. forestry sector. Thus, for the RFS2 agricultural sector analysis, these biofuel sources were estimated outside of the agricultural sector models (see Chapter 1). We estimate that approximately 2 billion gallons of cellulosic ethanol will be produced from municipal solid waste, and 4 billion gallons of cellulosic ethanol will be produced from the forestry sector in 2022.

All the results presented in this section are relative to the AEO 2007 Reference Case renewable fuel volumes, which include 12.3 Bgal of grain-based ethanol, 0.4 Bgal of biodiesel, and 0.3 Bgal of cellulosic ethanol in 2022. The domestic figures are provided by FASOM and FAPRI, and all of the international numbers are provided by FAPRI. For a more detailed set of results of the agricultural sector impacts of the RFS2 volumes, see the analytical reports submitted by FASOM and FAPRI in the docket of this rule.

**Table 5.1-1
Biofuel Volumes Modeled in 2022
(Billions of Gallons)**

Biofuel	Reference Case	Control Case	Change
Corn Ethanol	12.3	15.0	2.7
Corn Residue Cellulosic Ethanol	0	7.5	7.5
Sugarcane Bagasse Cellulosic Ethanol	0.3	1.4	1.1
Switchgrass Cellulosic Ethanol	0	1.3	1.3
Other Ethanol	0	0.2	0.2
Biodiesel	0.4	1.0	0.6

5.1.3 Biofuel Feedstock Assumptions

In order to run a representative model of the U.S. and international agriculture sectors to analyze the impact of the RFS2 biofuel volumes requirement, a series of assumptions and input parameters were set in order to achieve two major goals in our analysis. First, that the input assumptions are based on the most current data and projections available in government, industry, and academia; and second, to ensure that the two agriculture models, FASOM and FAPRI, were analyzing similar real-world assumptions, and thus present a detailed and consistent worldwide analysis. Table 5.1-2 lists some of the key assumptions associated with the agriculture sector modeling, as well as the source for these assumptions. Additional details on the assumptions included in FASOM^{PPPPPPPPP} and FAPRI^{QQQQQQQQQ} are included in the docket.

A series of information was gathered from and reviewed by other government agencies, such as USDA and DOE. These include corn and soybean yields,^{RRRRRRRRR} corn ethanol dry and wet mill plant processing energy use, corn ethanol yields, corn ethanol by-product use, and estimated corn stover yields. For other assumptions, we relied on external expertise, such as FAPRI; the Greenhouse gases, Regulated Emissions and Energy use in Transportation (GREET) model;^{SSSSSSSSS} the Assessment System for Population Exposure Nationwide (ASPEN) model;^{TTTTTTTTT} and the Agriculture Resource Management Survey (ARMS).^{UUUUUUUUU}

^{PPPPPPPPP} Beach, Robert; McCarl, Bruce, *Agricultural Impacts of the Energy Independence and Security Act: FASOM Results and Model Description*, RTI International, October, 2008.

^{QQQQQQQQQ} *Technical Report: An Analysis of EPA Biofuel Scenarios with the FAPRI International Models*, CARD staff, November, 2008.

^{RRRRRRRRR} USDA Agricultural Projections to 2017 (OCE-2008-1), February, 2008.

^{SSSSSSSSS} The GREET model is run by Argonne National Laboratory at the Department of Energy. GREET can simulate more than 100 fuel production pathways and more than 80 vehicle/fuel systems.

^{TTTTTTTTT} ASPEN is a computer simulation model used to estimate toxic air pollutant concentrations is called the Assessment System for Population Exposure Nationwide, or. This model is based on the EPA's Industrial Source Complex Long Term model (ISCLT) which simulates the behavior of the pollutants after they are emitted into the atmosphere. ASPEN uses estimates of toxic air pollutant emissions and meteorological data from National Weather Service Stations to estimate air toxics concentrations nationwide.

^{UUUUUUUUU} ARMS is sponsored by the Economic Research Service (ERS) and National Agricultural Statistics Service (NASS) at USDA, and provides observations of field-level farm practices, the economics of the farm business, and the characteristics of the American farm household.

Projected crop yields, both domestically and internationally, constitute one of the most influential factors of this agricultural analysis. The yields presented in Table 5.1-2 are based on the USDA projections through 2017 (the last year of their baseline projections report) and then extrapolated out to 2022. The yields in this table represented the national weighted average yields, which vary by region. These yields are based on historical averages for the region, which increase over time in both the AEO Reference case and the EISA Control Case. FASOM assumes the rate of increase is (1.6% per year). For this proposal, we modeled the same yields in both the Reference Case and the Control Case, assuming there was no significant impact on yields due to commodity price changes resulting from the RFS2 volumes (i.e., no price-induced yield changes). In addition, we did not model changes in yields that might occur based on increased planting on marginal land or management practices (e.g., residue removal, corn after corn rotations) as a result of the RFS2 volumes.

For cellulosic biofuels from corn residues, the current assumptions in FASOM for residue removal rates are based on the Graham et. al. paper^{VVVVVVVVVV} and the Perlack et al study.^{WWWWWWWWW} This approach uses a maximum percent removal of residues on acres based on tillage practices.^{XXXXXXXXXX} Other recent papers have raised the issue that a more relevant metric is a minimum amount of mass that must remain on an acre of land to prevent runoff and maintain soil carbon levels.^{YYYYYYYYYY} However, we were unable to obtain national or regional estimates in time for the proposal. We intend to review these assumptions between proposal and final, and, if possible, update these assumptions as appropriate. In addition, we plan to review in more detail the sustainable removal rates for other crops such as wheat and rice residues.^{ZZZZZZZZZ,AAAAAAAAA}

FASOM assumes fertilizer application rates do not increase over time in proportion to the increase in yields, as shown in Table 5.1-2. This data is based on USDA data that shows fertilizer application rates per acre remaining relatively steady for the past 30 years, during which time corn yields have increased approximately 70%.^{BBBBBBBBBB} However, it may be reasonable to assume that there may be a corresponding increase in fertilizer rates as crop yields increase into the future, and EPA requests comment on the relationship. In addition, when residues are removed from the field, some of the nutrients that are contained in the residue must be replaced through additional fertilizer use. For the proposal, we assumed that 7 additional pounds of nitrogen and 3.6 lbs of phosphorous must be applied per ton of residue removed. We will continue to review these assumptions for the final rule.

^{VVVVVVVVVV} See also <http://www.cpnrd.org/Harvesting%20Stover.pdf>

^{WWWWWWWWW} Available at http://feedstockreview.ornl.gov/pdf/billion_ton_vision.pdf.

^{XXXXXXXXXX} Many site specific factors associated with the sustainable removal of residue (e.g., crop type, soil type, soil fertility, slope, and climate) affect which geographic regions are suitable for crop residue removal. Detailed modeling of these factors was beyond the scope of this analysis.

^{YYYYYYYYYY} Wilhelm et. al Corn Stover to Sustain Soil Organic Carbon Further Constrains Biomass Supply, *Ag Journal* (2007)

^{ZZZZZZZZZ} Kerstetter JD, Lyons JK. Logging and agricultural residue supply curves for the Pacific Northwest. Washington State University Energy Publication; 2001

^{AAAAAAAAAAA} Banowetz et al. Assessment of straw biomass feedstock resources in the Pacific Northwest. *Biomass and Bioenergy*. In Press

^{BBBBBBBBBB} Data from the National Agriculture Statistics Service (NASS) at USDA: <http://www.nass.usda.gov/>

Lastly, there is a limit to how many acres crops can be planted on. The Conservation Reserve Program (CRP)^{CCCCCCCCC} is run by the Natural Resources Conservation Service at USDA. This program is designed to maintain Federal, State, and tribal environmental laws by making payments to farmers equivalent to the income otherwise earned from developing the land enrolled in the program. In the 2008 Farm Bill, the number of acres enrolled in the CRP was given a minimum limit of 32 million acres. It is assumed that USDA will increase payments to match the rising costs of crops that could be grown on CRP acres through the 2022 time period for this analysis.

^{CCCCCCCCC} See: <http://www.nrcs.usda.gov/programs/CRP/>

**Table 5.1-2.
Agriculture Model Assumptions**

Assumption	Notes
Feedstock Production	
U.S. national average corn yields are approximately 170 bu/acre in 2017 and 180 bu/acre in 2022 (a 1.6% annual increase over the baseline year)	Consistent with USDA projections (http://www.ers.usda.gov/publications/oce081/)
U.S. national average soybean yields are approximately 50 bu/acre in 2022 (a 0.4% annual increase)	
International corn yields increasing over time, for example: Argentina ~140 bu/acre in 2022 (a 0.8% annual increase) Brazil ~68 bu/acre in 2022 (a 1.1% annual increase)	FAPRI Models
International soybean yields increasing over time, for example: Argentina ~48 bu/acre in 2022 (a 0.7% annual increase) Brazil ~50 bu/acre in 2022 (a 1.1% annual increase)	
Corn residue removal rates of 50% are allowed for no till practices; 35% removal rate allowed for reduced till practices (no removal from conventional till)	Derived from Graham et. al., Agronomy Journal, 99:1–11 (2007). "Current and Potential U.S. Corn Stover Supplies." and Perlack, R. D., L. L. Wright, A. F. Turhollow, R. L. Graham, B. J. Stokes, and D. C. Erbach. 2005. Biomass as Feedstock for a Bioenergy and Bioproducts Industry: the Technical Feasibility of a Billion-ton Annual Supply. Report prepared for the U.S. Department of Energy and the U.S. Department of Agriculture.
The Conservation Reserve Program (CRP) has a minimum limit of 32 million acres enrolled in the program at any given time	2008 Farm Bill USDA baseline assumptions
Fertilizer Use	
U.S. nitrogen application rate in corn is approximately 136 lbs/acre in the corn belt in 2022 U.S. phosphorous application rate in corn is approximately 28 lbs/acre in the corn belt in 2022	Based on ARMS data, adjusted for differences in regions and irrigation practices
For U.S. assume higher yields require no increase in fertilizer use	Based on USDA baseline assumptions This holds for all farming rotations (e.g., corn / soybean and corn / corn) and land types (e.g., prime and marginal land); see below for stover removal impacts
Nitrogen nutrient replacement application = 7 lbs/ton corn residue removed Phosphorous nutrient replacement application = 3.6 lbs/ton corn residue removed	These numbers come from the Argonne National Lab Report, Fuel Cycle Assessment of Selected Bioethanol Production Pathways in the United States. (November 7, 2006). (Used and cited by GREET)
Processing	
1 bushel of corn produces 17 lbs of dried distillers grains (dry tons). 1 pound of DDG substitutes 0.9 pounds of corn and 0.1 pound of soybean meal feed	www.ethanol.org USDA baseline assumptions

5.1.4 Economic Impacts – Domestic – Control Case

For this analysis, the FASOM model is utilized for all domestic agriculture impacts. Although the FAPRI models do not provide the same amount of detail on GHG emissions for the domestic agriculture impacts as the FASOM model, FAPRI does estimate some of the same outputs, such as national crop acres, prices, and exports. Additionally, a common set of inputs were provided to both models, such as corn yields, energy prices, and the number of acres enrolled in the Conservation Reserve Program (CRP). In this chapter, we present both the FASOM and FAPRI results to demonstrate the range of potential agricultural impacts. Though our primary domestic analysis relies upon the FASOM model, as it contains more detail and scope beyond the FAPRI model for the U.S., this allows for a useful comparison between the two models, reinforces the accuracy of our domestic analysis, and ensures consistency when analyzing the impacts of the RFS2 fuel volume requirements on the domestic and international agriculture markets.

Commodity Prices

To satisfy the demands for increased biofuels for the RFS2 proposal, the FASOM model predicts an increase in prices for the primary feedstocks of biofuels. The proposed increase in corn ethanol production results in an increase in U.S. corn prices of \$0.15 per bushel (4.6%) above the Reference Case price of \$3.19 per bushel in 2022. Similarly, by 2022, the increase in demand for biodiesel production leads to an increase of U.S. soybean prices, which would increase by \$0.29 per bushel (2.9%) above the Reference Case price of \$9.97 per bushel. One of the major feedstocks of cellulosic ethanol is sugarcane bagasse, and as the demand for cellulosic ethanol increases with the RFS2 proposal, the price of sugarcane in 2022 would increase \$13.34/ton (41%) above the Reference Case price of \$32.49 per ton. There are also indirect effects from the RFS2 proposal reflected in commodity prices. For instance, corn is a major component in animal feed in the U.S., and as corn prices rise in 2022, beef prices would increase \$0.93 per hundred pounds (1.4%), relative to the Reference Case price of \$67.72 per hundred pounds. Higher U.S. corn prices would have a direct impact on the value of U.S. agricultural land. As demand for corn and other farm products increases, the price of U.S. farm land would also increase. Our analysis shows that land prices would increase by approximately 21% by 2022, relative to the Reference Case.

The FAPRI models also provide some domestic agriculture impacts in the U.S. In 2022, FAPRI predicts that U.S. corn prices would increase \$0.22 per bushel (8.2%) above the Reference Case to \$2.91 per bushel. Soybean prices would increase \$0.42 per bushel (5.7%) above the Reference Case to \$7.86 per bushel in 2022.

**Table 5.1-3.
Change in U.S. Commodity Prices from the Reference Case
(2006\$)**

FASOM Model		
Commodity	Change	% Change
Corn	\$0.15/bushel	4.6%
Soybeans	\$0.29/bushel	2.9%
Sugarcane	\$13.34/ton	41%
Fed Beef	\$0.93/hundred pounds	1.4%
FAPRI Model		
Commodity	Change	% Change
Corn	\$0.22/bushel	8.2%
Soybeans	\$0.42/bushel	5.7%

In FASOM, the increase in demand for cellulosic ethanol also leads to the production of feedstocks in the Control Case that previously had no value in the Reference Case. This includes dedicated energy crops, such as switchgrass, as well as crop residues, such as corn stover. The price of switchgrass in 2022 is \$30.18 per wet ton, and the farm gate feedstock price of corn residue is \$32.74/wet ton in the Control Case. These prices do not include the storage, handling, or delivery costs. We intend to update the costs assumptions (described in more detail in Section 4.1.1 of the DRIA) for the final rule. Since the FAPRI models do not explicitly model cellulosic ethanol production from agriculture residues or dedicated energy crops, comparable price impacts are not available.

Commodity Use Changes

Changes in the consumption patterns of U.S. corn can be seen by the increasing percentage of corn used for ethanol. FASOM estimates that the amount of domestically produced corn used for ethanol in 2022 would increase to 33%, relative to the 28% usage rate under the Reference Case. The rising price of corn and soybeans in the U.S. would have a direct impact on how corn is used. Higher domestic corn prices would lead to lower U.S. exports as the world markets shift to other sources of these products or expand the use of substitute grains. FASOM estimates that U.S. corn exports would drop 263 million bushels (-9.9%) to 2.4 billion bushels by 2022. In value terms, U.S. exports of corn would fall by \$487 million (-5.7%) to \$8 billion in 2022. FAPRI estimates that U.S. corn exports would decrease 288 million bushels (-7.6%) to 3.5 billion bushels in 2022. In value terms, U.S. corn exports not change, maintaining its value of \$10.2 billion.

U.S. exports of soybeans would also decrease under this proposal. FASOM estimates that U.S. exports of soybeans would decrease 96.6 million bushels (-9.3%) to 943 million bushels in 2022. In value terms, U.S. exports of soybeans would decrease by \$691 million (-6.7%) to \$9.7 billion in 2022. FAPRI predicts that U.S. soybean exports would decrease 43 million bushels (-5.1%) to 802 million bushels and in value terms, U.S. soybean exports would increase by \$19.4 million (0.3%) to \$6.3 billion in 2022.

**Table 5.1-4.
Reductions in U.S. Exports from the Reference Case in 2022**

FASOM Model		
Exports	Change	% Change
Corn in Bushels	263 million	-9.9%
Soybeans in Bushels	96.6 million	-9.3%
Total Value of Exports	Change	% Change
Corn (2006\$)	-\$487 million	-5.7%
Soybeans (2006\$)	-\$691 million	-6.7%
FAPRI Model		
Exports	Change	% Change
Corn in Bushels	288 million	-7.6%
Soybeans in Bushels	96.6 million	-5.1%
Total Value of Exports	Change	% Change
Corn (2006\$)	\$0	0%
Soybeans (2006\$)	\$19.4 million	0.3%

Higher U.S. demand for corn for ethanol production would cause a decrease in the use of corn for U.S. livestock feed. Substitutes are available for corn as a feedstock, and this market is price sensitive. Several ethanol processing byproducts could also be used to replace a portion of the corn used as feed, depending on the type of animal. Distillers dried grains with solubles (DDGS) are a byproduct of dry mill ethanol production, and gluten meal and gluten feed are byproducts of wet milling ethanol production. Based on the assumption that 1 bushel of corn produces 17 lbs of DDGS, and that 1 pound of DDGS substitutes for 0.9 lbs of corn and 0.1 lbs of soybean meal in animal feed (see Table 5.1-2), FASOM estimates that the use of these ethanol byproducts in feed would increase 19% to 30 million tons, compared to 25 million tons under the Reference Case in 2022.

**Table 5.1-5.
Percent Change in Ethanol Byproducts Use in Feed
Relative to the Reference Case**

Category	2022
Ethanol Byproducts	19%

The EISA cellulosic ethanol requirements result in the production of residual agriculture products as well as dedicated energy crops. By 2022, FASOM estimates 90 million tons of corn residue are harvested for cellulosic ethanol production, as well as 18 million tons of switchgrass. Additionally, sugarcane bagasse for cellulosic ethanol production increases by 15.7 million tons to 19.7 million tons relative to the Reference Case.

Land Use Change

In order to satisfy the increased demand for corn ethanol, FASOM estimates an increase of 3.2 million acres, 3.9%, in harvested corn acres, above the 83.4 million acres harvested under

the Reference Case.^{DDDDDDDDDD} Most of the new corn acres come from a reduction in existing crop acres, such as rice, wheat, and hay. Rice acres, in 2022, decreases by 151 thousand acres (-3.8%) to 3.8 million acres in the Control Case. Wheat acres decrease by 676 thousand acres (-1.5%) to 43.6 million acres in 2022. Hay acres decrease by 625 thousand acres (-1.1%) to 54.2 million acres in 2022. Similarly, FAPRI estimates that harvested U.S. corn acres increase by 3.6 million acres, 4.2%, in 2022. See Table 5.1-6 for changes in crop acres in the FASOM model. As stated above, the FASOM model does not currently account for the impacts of the RFS2 biofuel volume requirements' impact on the forestry sector. We plan on using the forestry component in combination with the agriculture component to analyze the final rule.

**Table 5.1-6.
Change in Crop Acres Relative to the Reference Case in 2022
(millions of acres)**

Crop	Change	% Change
Corn	3.2	3.9%
Hay	-0.6	-1.1%
Rice	-0.2	-3.8%
Soybeans	-0.4	-0.5%
Sugarcane	0.7	55%
Switchgrass	2.8	N/A
Wheat	0.7	-1.5%

Though demand for biodiesel increases, the models predict a fall in U.S. soybean acres harvested, assuming soybean-based biodiesel meets the EISA GHG emission reduction thresholds. According to the FASOM model, harvested soybean acres would decrease by approximately 0.4 million acres (-0.5%) relative to the Reference Case acreage of 71.5 million acres in 2022. Despite the decrease in soybean acres, soybean oil production would increase by 0.4 million tons (4.0%) by 2022 over the Reference Case. Additionally, FASOM predicts that soybean oil exports would decrease 1.3 million tons (-52%) in 2022 relative to the Reference Case.

Likewise, FAPRI estimates that the increased demand for biodiesel from soybean oil results chiefly in a reduction in soybean oil exports, rather than an increase in acres harvested. Harvested soybean acres decrease by 0.9 million acres (-1.3%) to 69.1 million acres in 2022. FAPRI also estimates little change in soybean oil production, with a decrease of 32 million pounds (-0.1%) to 26.9 billion pounds in 2022. Exports in 2022 decrease by 2.9 billion pounds (-26.8%), to 7.9 billion pounds in 2022.

In the FASOM model, as the demand for cellulosic ethanol increases, most of the production is derived from corn residue harvesting. FASOM projects that the least cost options for meeting the cellulosic ethanol mandate will be primarily residue based feedstocks. However, this assumption is highly dependent on the assumed densities associated with switchgrass production, as well as the sustainable removal rates associated with residue crops. If more mass

^{DDDDDDDDDD} FASOM estimates that total planted corn acres increase to 93.8 million acres from the Reference Case level of 90.1 million acres in 2017. Total planted acres increases to 92.2 million acres from the Reference Case level of 89 million acres in 2022.

is required on the land to prevent erosion or soil carbon loss, there could be insufficient residue for cellulosic feedstocks. In addition, there are harvesting, transporting, and storing logistical issues that must be overcome before large-scale cellulosic biofuels can be produced, as described in Chapter 1.

One of the primary crop residue feedstocks for cellulosic ethanol production is sugarcane bagasse. As demand for cellulosic ethanol increases, sugarcane acres increase by 0.7 million acres (55%) to 1.9 million acres in 2022. In addition, some of the cellulosic ethanol comes from switchgrass, which is not produced under the Reference Case. In the scenario analyzed, 2.8 million acres of switchgrass will be planted by 2022. As mentioned above, FAPRI does not explicitly model the production of cellulosic ethanol and the resulting impacts on the agriculture sector. For both the Reference Case and the Control Case, we assume 32 million acres would remain in the Conservation Reserve Program (CRP). Therefore, some of the new corn, soybean, and switchgrass acres may be indirectly coming from former land that is not re-enrolled in the program. Figure 5.1-1 shows the change in acres for all crops in the U.S. in 2022. Figure 5.1-2 shows the production levels of cellulosic feedstocks by region in 2022.

**Figure 5.1-1.
 FASOM Model Estimated Change in
 U.S. Crop Acres Relative to the Reference Case in 2022
 (millions of acres)**

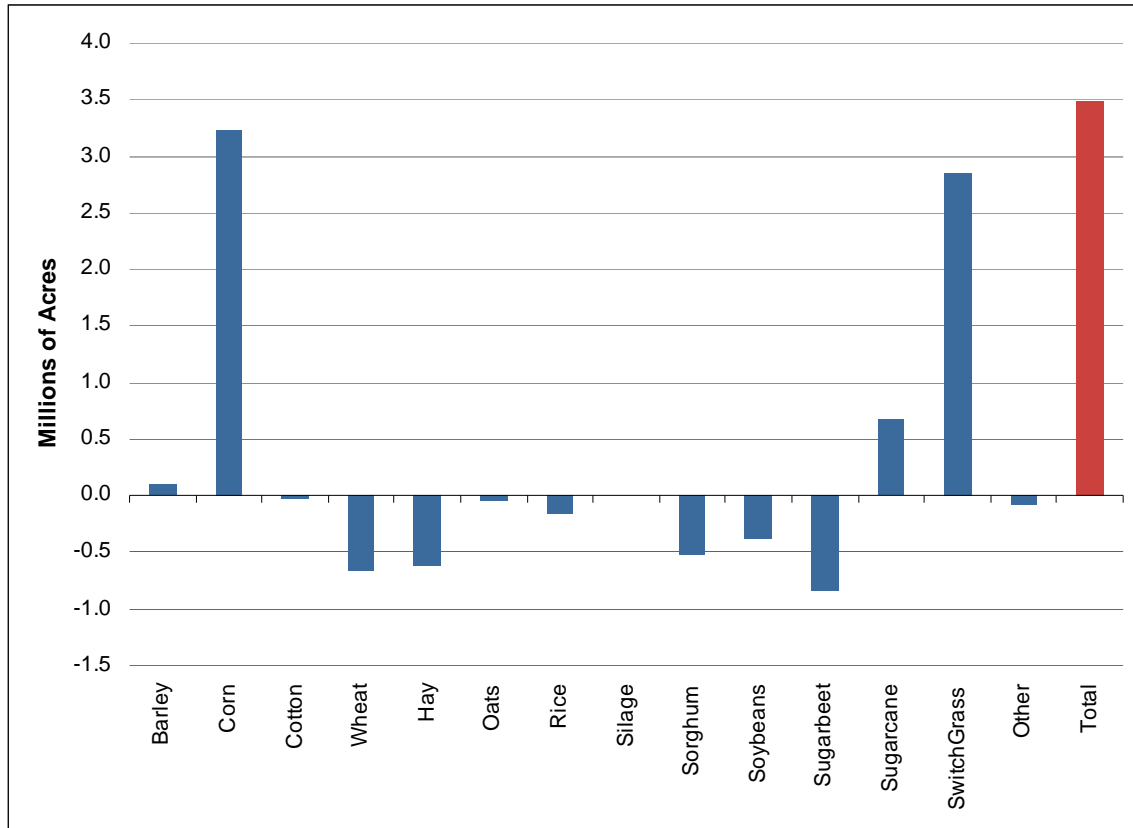

This page intentionally left blank.

**Figure 5.1-2.
Control Case Cellulosic Feedstock Production in the U.S. in 2022
(thousands of acres)**

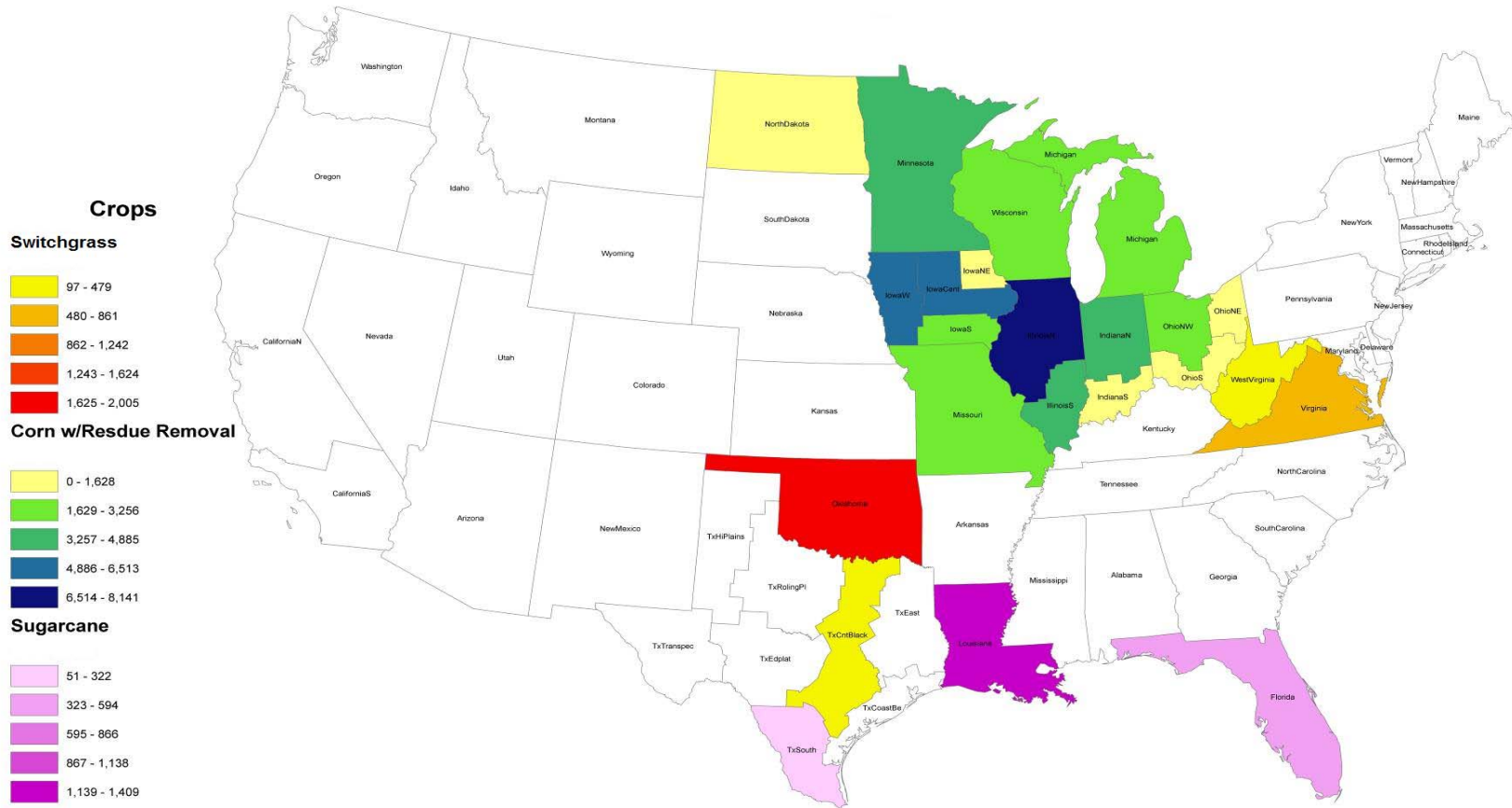

This page intentionally left blank.

As crop acres increase to meet the additional demand for corn and other crops for biofuel production, fertilizer use increases as a result. In 2022, FASOM estimates that nitrogen fertilizer use in the U.S. agricultural sector would increase by 897 million pounds, 3.4% over the Reference Case level of 26.2 billion pounds, and that phosphorous fertilizer use would increase by 496 million pounds, 8.6% higher than the Reference Case level of 5.8 billion pounds. The FAPRI model does not provide estimates for fertilizer use.

**Table 5.1-7.
Change in U.S. Fertilizer Use
Relative to the Reference Case
(millions of pounds)**

Fertilizer	Change	%Change
Nitrogen	897	3.4%
Phosphorous	496	8.6%

Impact on U.S. Farm Income

The increase in renewable fuel production provides a significant increase in net farm income to the U.S. agricultural and livestock sector. FASOM predicts that net U.S. farm income would increase by \$7.1 billion dollars (10.6%) in 2022 relative to the AEO 2007 Reference Case.

Impact on U.S. Food Prices

Due to higher commodity prices, FASOM estimates that U.S. food costs^{EEEEEEEEEE} would increase by \$10 per person per year by 2022, relative to the Reference Case.^{FFFFFFFFF} Total effective farm gate food costs would increase by \$3.3 billion (0.2%) in 2022.^{GGGGGGGGGG} To put these changes in perspective, average U.S. per capita food expenditures in 2007 were \$3,778 or approximately 10% of personal disposable income. The total amount spent on food in the U.S. in 2007 was \$1.14 trillion dollars.^{HHHHHHHHHH}

5.1.5 Economic Impacts – Domestic – Sensitivities

^{EEEEEEEEEE} FASOM does not calculate changes in price to the consumer directly. The proxy for aggregate food price change is an indexed value of all food prices at the farm gate. It should be noted, however, that according to USDA, approximately 80 percent of consumer food expenditures are a result of handling after it leaves the farm (e.g., processing, packaging, storage, marketing, and distribution). These costs consist of a complex set of variables, and do not necessarily change in proportion to an increase in farm gate costs. In fact, these intermediate steps can absorb price increases to some extent, suggesting that only a portion of farm gate price changes are typically reflected at the retail level. See <http://www.ers.usda.gov/publications/foodreview/septdec00/FRsept00e.pdf>.
^{FFFFFFFFF} These estimates are based on U.S. Census population projections of 318 million people in 2017 and 330 million people in 2022. See <http://www.census.gov/population/www/projections/natsum.html>.
^{GGGGGGGGGG} Farm Gate food prices refer to the prices that farmers are paid for their commodities.
^{HHHHHHHHHH} See www.ers.usda.gov/Briefing/CPIFoodAndExpenditures/Data/table15.htm.

In the impact analysis volumes of the RFS2 volumes, a number of key assumptions were set in both in the Reference Case and the Control Case. Namely, energy prices in both cases are from the AEO 08 Reference Case,ⁱⁱⁱⁱⁱⁱⁱⁱⁱⁱ national average corn yields in 2022 reached 183 bu/acre, and the number of acres enrolled in CRP is 32 million acres in 2022. In order to demonstrate their influence, the FASOM model was used to analyze variations on these key assumptions and observe the impacts on corn prices, harvested acres, and exports. With each sensitivity run, only one variable is changed, such as energy prices, corn yields, or acres in CRP, for both the Reference Case and the Control Case. The impact of the RFS2 volumes is observed under each set of new circumstances. In the original analysis, U.S. corn prices increase by \$0.15/bu, 4.6%, to \$3.34/bu; U.S. harvested corn acres increase by 3.2 million acres, 3.9%, to 86.6 million acres; and U.S. corn exports decrease by 263 million bushels, -9.9%, to 2.4 billion bushels in 2022.

The Reference Case and the Control Case contain energy prices from the AEO 08 Reference Case, in which gasoline prices are approximately \$2.36 per gallon in 2022. As a sensitivity, the FASOM model ran a “high price case”, where all other variables remaining equal, energy prices are from the AEO 08 High Price Case,^{jjjjjjjjj} in which gasoline prices are approximately \$3.28 per gallon in 2022. Higher energy prices lead to increased costs for crop production, leading to relatively higher prices. Under these circumstances, U.S. corn prices increase by approximately \$0.15/bu, 4.6%, to \$3.42/bu in 2022. Additionally, harvested U.S. corn acres increase by 2.7 million acres, 3.3%, to 85.3 million acres; and U.S. corn exports decrease by 278 million bushels (-11%) to 2.3 billion bushels in 2022.

Another key assumption examined here is the estimated technological rate of progress for corn yields. Different projected corn yield values in a given year have large implications for domestic agricultural land use and the export commodity market. If yields are relatively low, more land is required to supply the amount of corn demanded for biofuel production, which would also lead to relatively lower corn exports and higher corn prices. Conversely, if yields are relatively high, less land is required to meet the demand for corn ethanol, corn exports would be relatively higher, and corn prices would be relatively lower. In the original analysis, national average corn yields are approximately 183 bu/acre in 2022. In the “low yield case”, corn yields are equal to 163 bu/acre in 2022. Under this scenario, implementation of the RFS2 volumes would lead to U.S. corn prices increasing by \$0.34/bu (9.8%) to \$3.84/bu in 2022. Also, U.S. corn acres increase by 1.1 million acres (1.3%) to 90.1 million acres and U.S. corn exports decrease by 425 million bushels (-20%) to 1.7 billion bushels in 2022. In the “high yield case”, corn yields are equal to 208 bu/acre in 2022. Under these circumstances, implementation of the RFS2 volumes would lead to and increase of U.S. corn prices by \$0.07/bu (2.6%) to \$2.95/bu, an increase in U.S. corn acres of 1.4 million acres (1.7%) to 82 million acres, and a decrease of U.S. corn exports of 493 million bushels (-13.3%) to 3.2 billion bushels.

The final key assumption varied here regards the number of acres enrolled in CRP. In the original analysis, the number of acres in CRP were limited with a minimum of 32 million acres in accordance with the 2008 Farm Bill. As a sensitivity analysis, a scenario was examined where there is no minimum restriction imposed in the CRP program, and farmers may produce crops on

ⁱⁱⁱⁱⁱⁱⁱⁱⁱⁱ See: http://www.eia.doe.gov/oiaf/aeo/aeoref_tab.html

^{jjjjjjjjj} See: <http://www.eia.doe.gov/oiaf/aeo/aeohighprice.html>

these acres if it proves to be economically beneficial. With no limits on CRP acreage and more land becomes available for crop production, corn prices will be relatively lower. Under these circumstances, implementation of the RFS2 volumes would result in an increase in U.S. corn prices of \$0.12/bu (3.7%) to \$3.25/bu, an increase in U.S. corn acres of 2.6 million acres (3%) to 87.7 million acres, and a decrease of 299 million bushels of corn exports (-10.5%) to 2.5 billion bushels in 2022.

Figure 5.1-3.
Change in U.S. Corn Prices in 2022
(2006\$ per bushel)

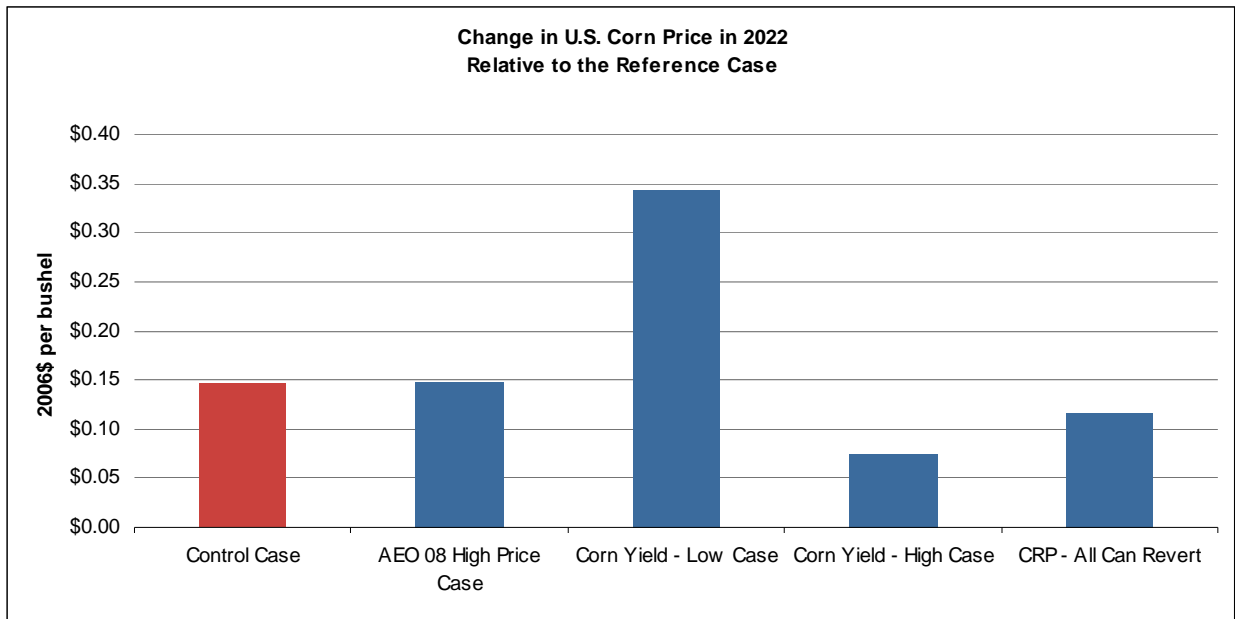

Figure 5.1-4.
Change in U.S. Harvested Corn Acres in 2022
(millions of acres)

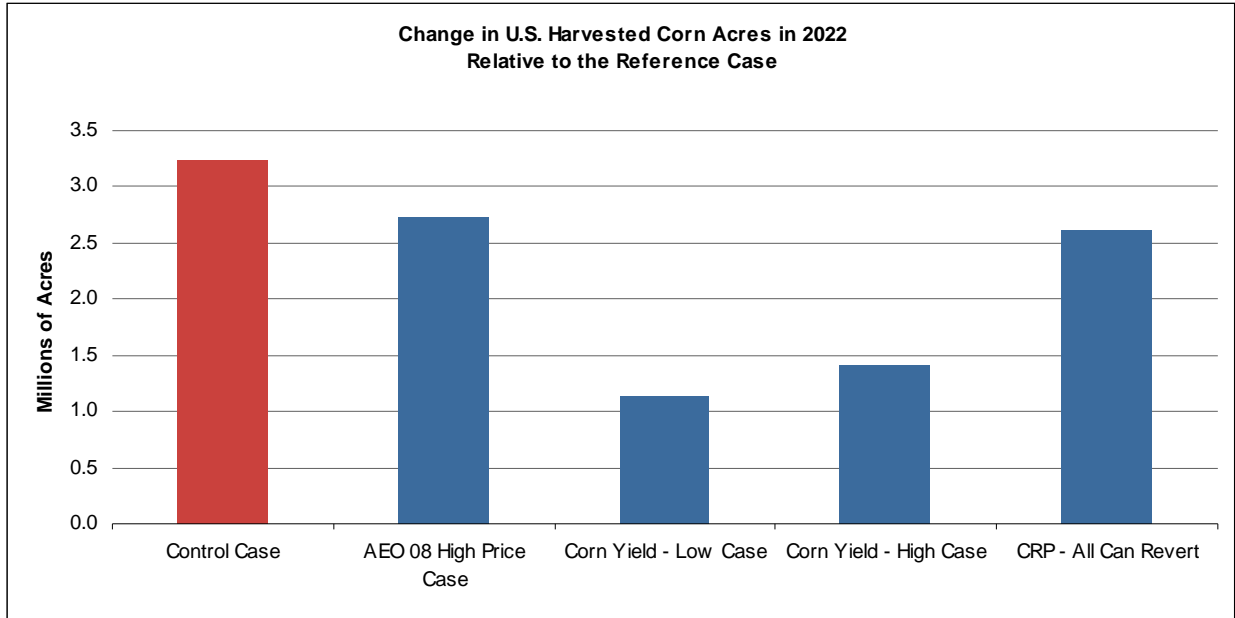
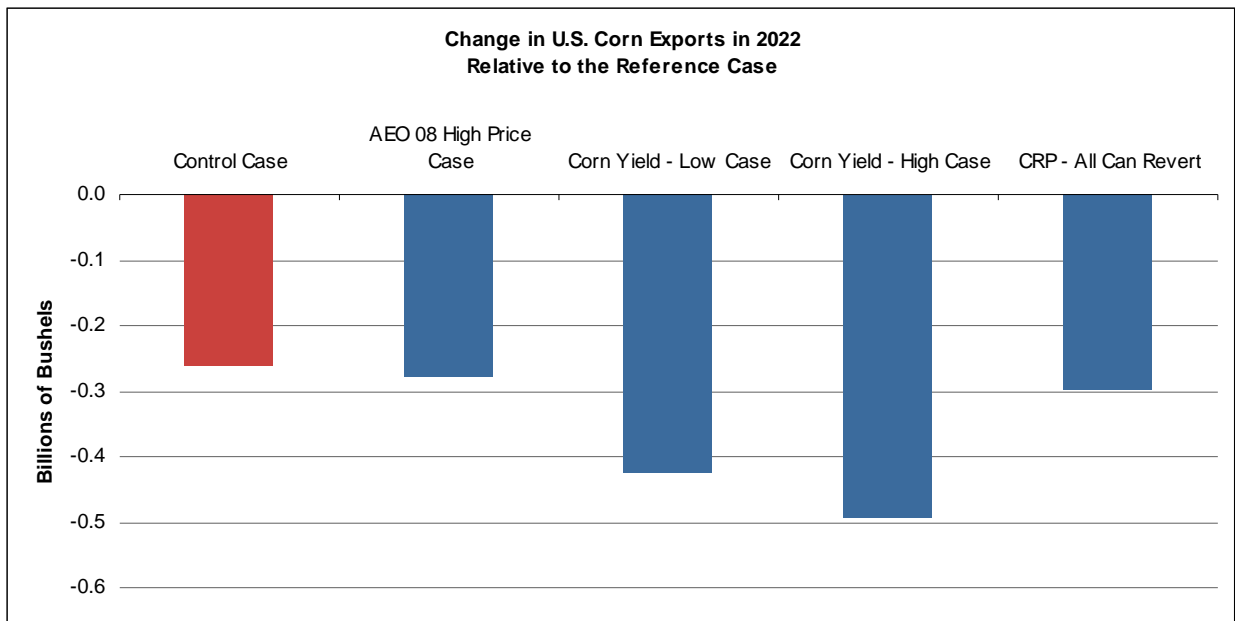

Figure 5.1-5.
Change in U.S. Corn Exports in 2022
(billions of bushels)



5.1.6 Economic Impacts - International

The FAPRI models are utilized to assess the international impacts on trade, land use, and food consumption as a result of the RFS2 biofuels requirement in the U.S. In the FAPRI models, links between the U.S. and international models are made through commodity prices and net trade equations. In general, for each commodity sector, the economic relationship that quantity supplied equals quantity demanded is achieved through a market-clearing price for the commodity. In other countries domestic prices are modeled as a function of the world price using a price transmission equation. Since econometric models for each sector can be linked, changes in one commodity sector will impact the other sectors.

The model for each commodity consists of a number of countries/regions, including a rest-of-the-world aggregate to close the model. The models specify behavioral equations for production, use, stocks, and trade between countries/regions. The models solve for representative world prices by equating excess supply and demand across countries. Using price transmission equations, the domestic price for each country is linked with the representative world price through exchange rates. It is through changes in world prices that change in worldwide commodity production and trade is determined.

Global Commodity Price Changes

As the RFS2 proposal alters various commodity production and prices in the U.S., it follows that the world price for these same commodities, and therefore their production and trade, are affected as well. As the U.S. increases its use of corn for ethanol production, the FAPRI model estimates that it reduces corn net exports (as mentioned above), which results in the world price of corn increasing by \$0.26/bu (7.5%) to \$3.69/bu in 2022. Similarly, the decrease in U.S. net exports of soybeans has a corresponding effect on the world price of soybeans, which increases by \$0.52/bu (5.6%) to \$9.94/bu in 2022. As a primary feedstock for domestic biodiesel production, the U.S. decreases in net exports of soybean oil to satisfy the increased demand for biodiesel, causing world soybean oil prices to increase by \$120.93/ton (12.2%) to \$1,116.43/ton in 2022.

World biofuel prices are also affected by the RFS2 proposal. As mentioned above in section 5.1.2, the U.S. satisfies a portion of the increased demand for biofuels by increasing its imports of ethanol. The FAPRI model predicts that this increased demand on the world supply of ethanol leads to an increase its world price by \$0.38/gallon (60.8%) to \$1.00/gallon in 2022. Though the U.S. does not change its level of import or export of biodiesel, which is zero, the change in the price of biodiesel feedstocks, such as soybean oil, affects the world price of biodiesel, which increases by \$0.10/gallon (2.11%) to \$4.89/gallon in 2022.

Table 5.1-8.
Global Commodity Price Changes in 2022
(2006\$ per unit)

Commodity	Change (2006\$ per Unit)	% Change
Corn	\$0.26/bushel	7.5%
Soybeans	\$0.52/bushel	5.6%
Soybean Oil	\$120.93/ton	12.2%
Ethanol	\$0.38/gallon	60.8%
Biodiesel	\$0.10/gallon	2.11%

World Trade in Biofuels

As the U.S. increases its demand for increased use of biofuels, this will also lead to impacts on the world trade market for biofuels. With the RFS2 proposal, the U.S. will increase its imports of ethanol. EPA estimates that in 2022, the U.S. will increase net imports of ethanol by 2.5 billion gallons (388%) to 3.1 billion gallons. In response, the only net exporter of ethanol in the world, Brazil, increases production of ethanol and increases its net exports by 2.2 billion gallons (65.9%) to 5.4 billion gallons. However, since the U.S. demand for ethanol imports exceeds the increase in Brazilian net exports, other countries see a reduction in their net imports of ethanol. China decreases its net imports by 96 million gallons (-60.3%) to 64 million gallons, Canada decreases its net imports by 31 million gallons (-7.1%) to 412 million gallons, and the European Union decreases its net imports of ethanol by 40 million gallons (-7.4%) to 507 million gallons in 2022. Additionally, India decreases its net imports of ethanol by 57 million gallons (-12.7%) to 388 million gallons, Japan decreases net imports of ethanol by 10 million gallons (-2.6%) to 365 million gallons, and South Korea decreases net imports of ethanol by 5 million gallons (-2.9%) to 175 million gallons. The rest of the world decreases net imports of ethanol by 2 million gallons (-0.4%) to 477 million gallons in 2022.

**Figure 5.1-6.
Ethanol Net Exports by Country in 2022
(billions of gallons)**

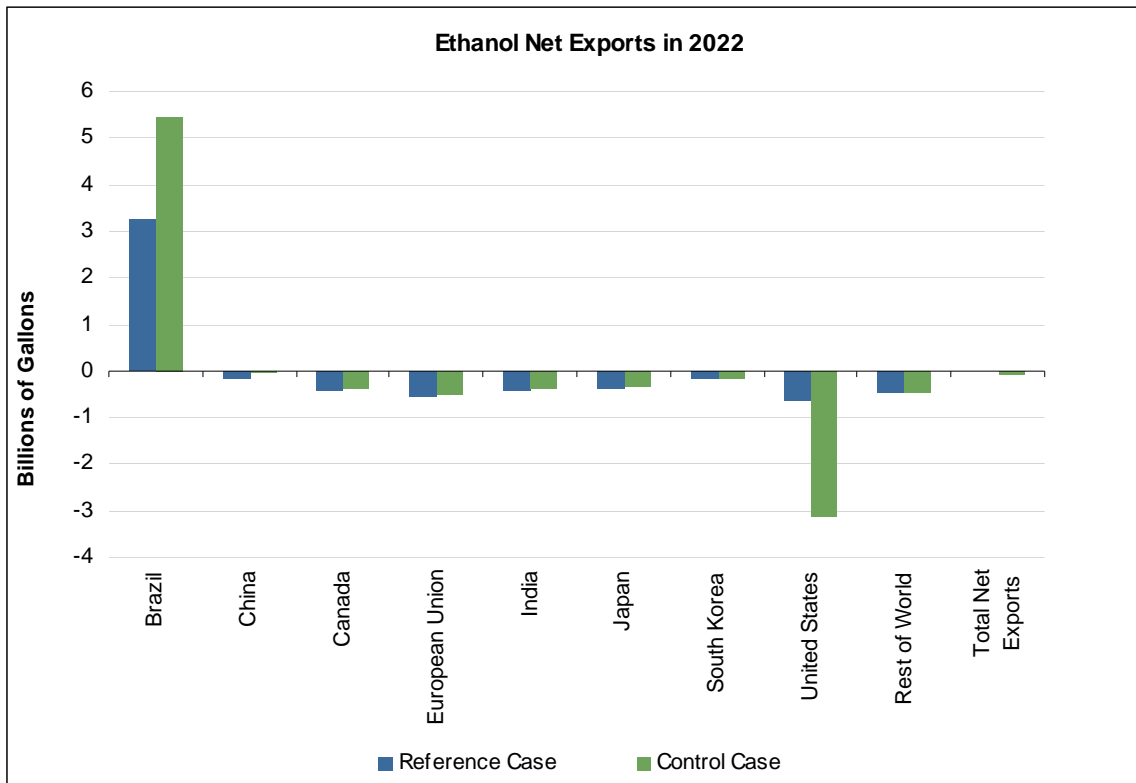

Though the U.S. does not import any biodiesel either in the AEO 2007 Reference Case nor the EISA Control Case, the decrease in soybean oil exports from the U.S. of 2.9 billion pounds (-27%) to 7.9 billion pounds, as estimated by the FAPRI model has implications in the biodiesel trade market. The decrease in U.S. soybean oil exports leads to an increase in the world price of soybean oil, causing other countries to increase their net exports of soybean oil. Argentina and Brazil increase their soybean oil net exports by 354 million pounds and 676 million pounds, respectively, in 2022. Since the world price of soybean oil increases at a much larger rate (12.2%) than the world price of biodiesel (2.1%) due to the RFS2 proposal, it becomes relatively more profitable to increase net exports of soybean oil for major producers. This results in less soybean oil being used in the production of biodiesel and therefore a decrease in biodiesel net exports. In 2022, Argentina decreases their biodiesel net exports by 8 million gallons (-3.0%) to 269 million gallons, and Brazil decreases their biodiesel net exports by 19 million gallons (-7.3%) to 240 million gallons. In response, the EU reduces their net imports of biodiesel by 26 million gallons (-5.2%) to 479 million gallons and Japan reduces its net imports of biodiesel by 1 million gallons (-1.3%).

Figure 5.1-7.
Biodiesel Net Exports by Country in 2022
(billions of gallons)

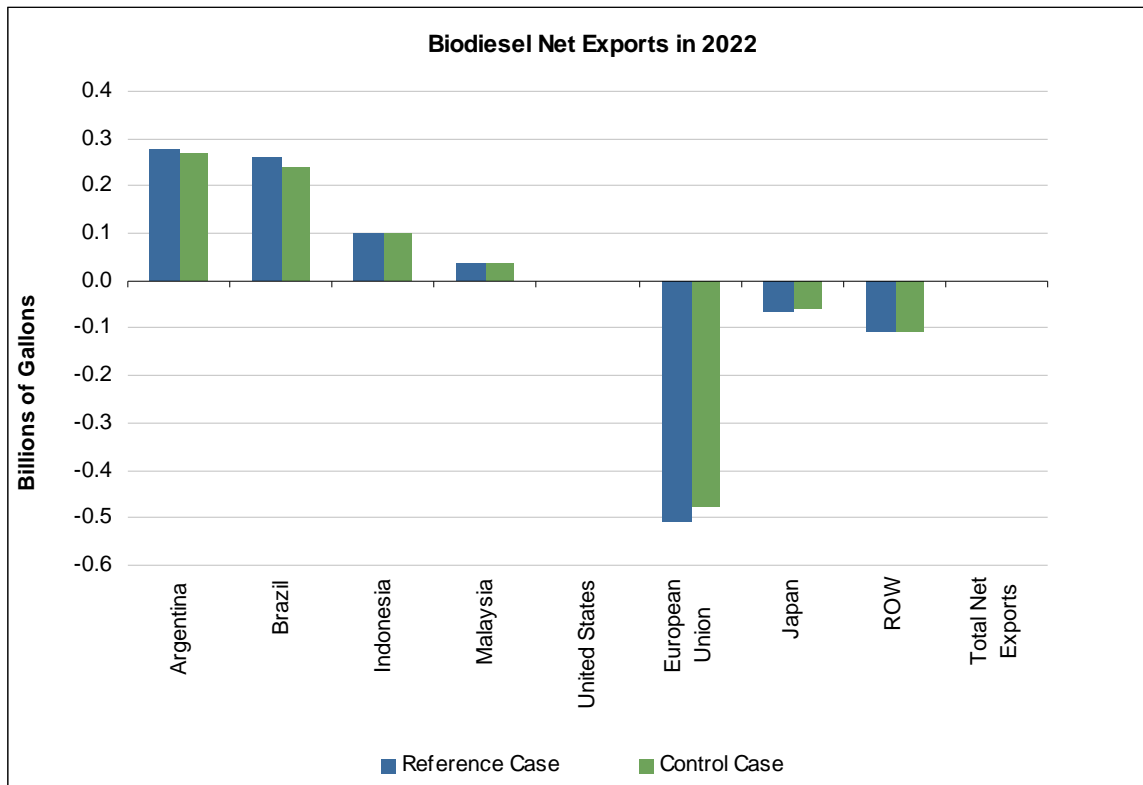

International Land Use Change

Changes to the global commodity trade markets and world commodity prices result in changes in international land use. The FAPRI model provides international change in crop acres as a result of the RFS2 proposal. Brazil has the largest positive change in crop acres in 2022, followed by the U.S., Nigeria, India, Paraguay, and China. As the U.S. increases its net imports of ethanol by 2.5 billion gallons in 2022, the major supplier of this increase in ethanol is Brazil which produces ethanol from sugarcane. The FAPRI model estimates that Brazil crop acres increase by 3.1 million acres (2.0%) to 153.6 million acres relative to the Reference Case. The major crop contributing to this increase is sugarcane, which increases by 2.0 million acres (8.7%) in 2022 to 24.4 million acres. Total U.S. acres increase by 2.3 million acres (1.0%) in 2022 to 232.6 million acres. The major crop contributing to this increase is corn, which increases by 3.7 million acres (4.2%) to 90 million acres in order to satisfy the increased demand for corn ethanol. Though Brazil and the U.S. increase their crop acres to meet the increased demand for biofuel, other countries, such as Nigeria and India, respond by increasing their major food crops: sorghum and rice, respectively. Nigeria has an increase in crop acres of 1.5 million acres (5.9%) to 27.3 million acres in 2022. This increase is entirely due to an increase in sorghum acres, which represents a 7.6% increase in sorghum acres in 2022. India's total crop acres increase by 1.0 million acres (0.3%) to 326 million acres in 2022. Rice is the largest contributor to this increase, rising by 0.4 million acres (0.4%) in 2022, though soybeans, sorghum, and corn also

increase by 0.25, 0.31, and 0.21 million acres, respectively. Total crop acres in Paraguay increase by 0.8 million acres (6.9%) to 12 million acres. This increase is entirely due to the increase of soybean acres, which rise 6.9% in 2022. China's total crop acres increase by 0.4 million acres (0.2%) to 257.8 million acres in 2022. The crop with the largest increase is corn, which rises by 0.7 million acres (1.0%) 70.4 million acres in 2022.

Figure 5.1-8.
Change in World Crop Acres By Country in 2022
 (millions of acres)

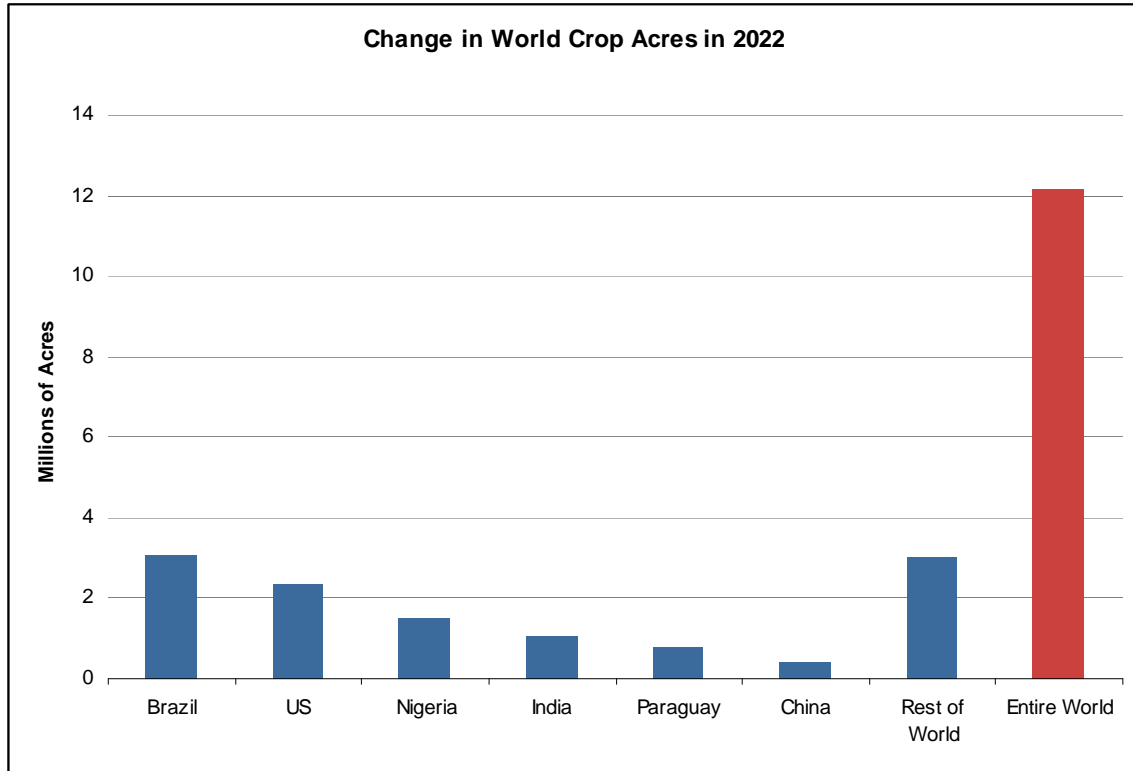

International Crop Yields

When analyzing the change in international crop acres in response to the RFS2 proposal, it is important to note that different countries have different yields for each crop. The FAPRI model bases each country's crop yield on historical trends and projects this technical rate of progress into the future. Similar to the FASOM model, the yield for each crop is the same in both the Reference Case and the Control Case in that neither model has price induced crop yields. Table 5.1-9 lists the production and yields for the top four producers of corn and soybeans in the Control Case in 2022.

**Table 5.1-9.
Corn and Soybean Control Case Production and Yields for the
Top Four Producing Countries in 2022**

<i>Corn</i>		
Country	Production (billions of bushels)	Yield (bushels/acre)
U.S.	16.6	184
China	7.0	99
Brazil	2.5	68
EU	2.3	111
<i>Soybeans</i>		
Country	Production (billions of bushels)	Yield (bushels/acre)
Brazil	3.8	50
U.S.	3.4	49
Argentina	2.4	48
China	0.6	30

World Food Consumption

The RFS2 mandate results in higher international commodity prices, which would impact world food consumption.^{KKKKKKKKKK} As mentioned above, with the RFS2 proposal world corn prices would increase by 7.5% to \$3.69 per bushel in 2022, relative to the Reference Case. The impact on world soybean prices is somewhat smaller, increasing 5.6% to \$9.94 per bushel in 2022. Since major agricultural commodity prices increase globally, it is anticipated that world consumption of food would decrease. The FAPRI model indicates that world consumption of corn for food falls by 1.1 million metric tons (-0.5%) in 2022 relative to the Reference Case. Similarly, the FAPRI model estimates that world consumption of wheat for food would decrease by 0.6 million metric tons (-0.1%) in 2022. World consumption of oil for food (e.g., vegetable oils) decreases by 1.8 million metric tons (-1.4%) by 2022. The model also estimates a small change in world meat consumption, decreasing by 0.3 million metric tons (-0.1%) in 2022. When considering all the food uses included in the model, world food consumption decreases by 0.9 million metric tons (-0.04%) by 2022. While FAPRI provides estimates of changes in world food consumption, estimating effects on global nutrition is beyond the scope of this analysis.

^{KKKKKKKKKK} The food commodities included in the FAPRI model include corn, wheat, sorghum, barley, soybeans, sugar, peanuts, oils, beef, pork, poultry, and dairy products.

Table 5.1-10.
Change in World Food Consumption Relative to the Reference Case
(millions of metric tons)

Category	Change	% Change
Corn	-1.1	-0.5%
Wheat	-0.6	-0.1%
Vegetable Oils	-1.8	-1.4%
Meat	-0.3	-0.1%
Total Food	-0.9	-0.4%

5.2 Petroleum and Energy Security Impacts

5.2.1 Impact on U.S. Petroleum Imports

In 2007, U.S. petroleum imports represented 19.5 percent of total U.S. imports of all goods and services.^{LLLLLLLLLL} In 2005, the United States imported almost 60 percent of the petroleum it consumed. This compares roughly to 35 percent of petroleum from imports in 1975.^{MMMMMMMMMM} Transportation accounts for 70 percent of the U.S. petroleum consumption. It is clear that petroleum imports have a significant impact on the U.S. economy. Diversifying transportation fuels in the U.S. is expected to lower U.S. petroleum imports. To estimate the impacts of this proposal on the U.S.'s dependence on imported oil, we calculate avoided U.S. expenditures on petroleum imports.

EPA analyzed two approaches to estimate the reductions in U.S. petroleum imports. The first approach utilizes a model of the U.S. energy sector, the National Energy Modeling System (NEMS), to quantify the type and volume of reduced petroleum imports based on supply and demand for specific fuels in a given year. The National Energy Modeling System (NEMS) is a computer-based, energy-economy modeling system of U.S. energy markets through the 2030 time period. NEMS projects U.S. production, imports, conversion, consumption, and prices of energy; subject to assumptions on world energy markets, resource availability and costs, behavioral and technological choice criteria, cost and performance characteristics of energy technologies, and demographics. NEMS is designed and implemented by the Energy Information Administration (EIA) of the U.S. Department of Energy (DOE). For this analysis, the NEMS model was run with the 2007 AEO levels of biofuels in the reference case compared with the biofuel volume RFS2 requirements.

Considering the regional nature of U.S. imports of petroleum imports, a second approach was utilized as well to estimate the impacts of the RFS2 proposal on U.S. oil imports. This approach is labeled "Regional Gasoline Market" approach. This approach makes the assumption that one half of the ethanol market is in the Northeast portion of the U.S., which also comprises

^{LLLLLLLLLL} Bureau of Economic Affairs: "U.S. International Transactions, Fourth Quarter of 2007" by Elena L. Nguyen and Jessica Melton Hanson, April 2008.

^{MMMMMMMMMM} Davis, Stacy C.; Diegel, Susan W., *Transportation Energy Data Book: 25th Edition*, Oak Ridge National Laboratory, U.S. Department of Energy, ORNL-6974, 2006.

about half of the nation’s gasoline demand. For this analysis, it is estimated that ethanol would displace imported gasoline or gasoline blend stocks in the Northeast, but not elsewhere in the country. Therefore, to derive the portion of the new renewable fuels which would offset U.S. petroleum imports (and not impact domestic refinery production), we multiplied the total volume of petroleum fuel displaced by 50 percent to represent that portion of the ethanol which would be used in the Northeast, and 50 percent again to only account for that which would offset imports. The rest of the ethanol, including half of the ethanol presumed to be used in the Northeast, is presumed to offset domestic gasoline production, which ultimately offsets crude oil inputs at refineries. Biodiesel and renewable diesel are presumed to offset domestic diesel fuel production.

The results shown in Table 5.2-1-1 below reflect the net lifecycle reductions in U.S. oil imports projected by NEMS. The net lifecycle reductions include the upstream petroleum used to produce renewable fuels, gasoline and diesel, as well as the petroleum directly used by end-users.

**Table 5.2-1-1.
Net Reductions in Oil Imports in 2022
(Using the NEMS Model)
(millions of barrels per day)**

Category of Reduction	2022
Imports of Finished Petroleum Products	0.823
Imports of Crude Oil	(0.007)
Total Reduction	0.815
Percent Reduction	6.15

The NEMS model projects that for the year 2022 all of the reduction in petroleum imports comes out of finished petroleum products. NEMS projects that 91 percent of the reductions in 2022 come from reduced net imports of crude oil and finished petroleum products (as compared to a 9 percent reduction in domestic U.S. production).

The results shown in Table 5.2.1-2 below reflect the net lifecycle reductions in U.S. oil imports projected by the use of the Regional Gasoline Market approach detailed above.

**Table 5.2.1-2.
Net Reductions in Oil Imports in 2022
(Using Regional Gasoline Market Approach)
(millions of barrels per day)**

Category of Reduction	2022
Imports of Finished Petroleum Products	0.250
Imports of Crude Oil	0.637
Total Reduction	0.887
Percent Reduction	6.17%

The Regional Gasoline Market approach projects that for 2022, 72% of the petroleum supply displacement (on a volume basis) comes out of reduced net crude oil imports, and 28% out of net imports of finished petroleum products (excluding biofuels). Using our two approaches for projecting total petroleum import reductions (the NEMS and the Regional Gasoline Market), we estimate that petroleum product imports will fall by between 0.815 to 0.887 million barrels per day in 2022 as a result of the RFS2 proposal.

Using the NEMS model, we also calculated the change in expenditures in both U.S. petroleum and ethanol imports with the RFS2 proposal and compared these with the U.S. trade position measured as U.S. net exports of all goods and services economy-wide. Changes in fuel expenditures were estimated by multiplying the changes in gasoline, diesel, and ethanol net imports by the respective AEO 2008 wholesale gasoline and distillate price forecasts, and ethanol price forecasts from the Food and Agricultural Policy Research Institute (FAPRI) for the specific analysis years. In Table 5.2.1-3, the net expenditures in reduced petroleum imports and increased ethanol imports are compared to the total value of U.S. net exports of goods and services for the whole economy for 2022. The U.S. net exports of goods and services estimates are taken from Energy Information Administration’s Annual Energy Outlook 2008. We project that avoided expenditures on imported petroleum products due to this proposal would be roughly \$16 billion in 2022. Relative to the 2022 projection, the total avoided expenditures on liquid transportation fuels are projected to be \$12.4 billion with the RFS2 proposal.

**Table 5.2.1-3.
Changes in Expenditures on
Transportation Fuel Net Imports
(billions of 2006\$)**

Category	2022
AEO Total Net Exports	16
Expenditures on Net Petroleum Imports	(15.96)
Expenditures on Net Ethanol and Biodiesel Imports	3.52
Net Expenditures on Transportation Fuel Imports	(12.44)

5.2.2 Background on U.S. Energy Security

U.S. energy security is broadly defined as protecting the U.S. economy against circumstances that threaten significant short- and long-term increases in energy costs. Most discussion of U.S. energy security revolves around the topic of the economic costs of U.S. dependence on oil imports. The problem is that the U.S. relies on sources of imported oil from potentially unfriendly and unstable sources. In addition, oil exporters have the ability to raise the price of oil by exerting monopoly power through the formation of a cartel, the Organization of Petroleum Exporting Countries (OPEC). Finally, these factors contribute to the vulnerability of the U.S. economy to episodic oil supply shocks and price spikes. In 2005, U.S. imports of crude oil were \$232 billion (see Figure 5.2.2-1).

Figure 5.2.2-1. U.S. Expenditures on Crude Oil

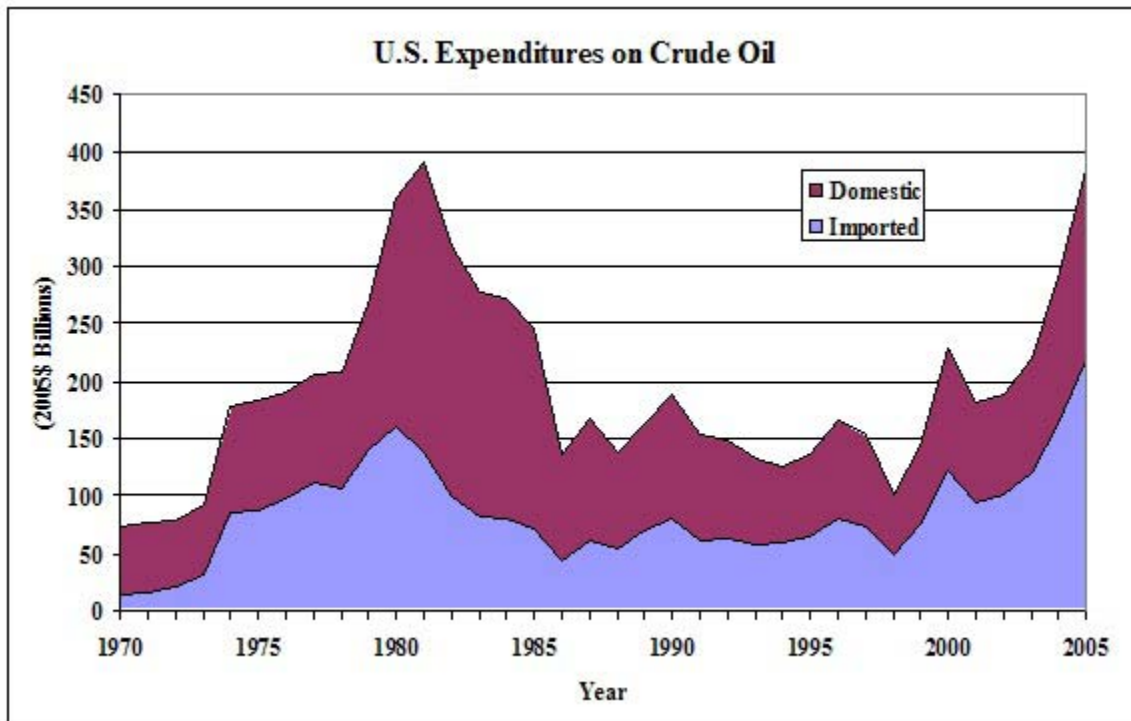

Source: Annual Energy Review 2006 and International Energy Review 2004. Year 2005 values are preliminary.

One effect of the RFS proposal is that it promotes diversification of transportation fuels in the U.S. The result is that it reduces U.S. oil imports, which reduces both financial and strategic risks associated with a potential disruption in supply or a spike in the cost of a particular energy source. This reduction in risks is a measure of improved U.S. energy security. For the RFS2 proposal an “oil premium” approach is utilized to identify those energy-security related impacts which are not reflected in the market price of oil, and which are expected to change in response to an incremental change in the level of U.S. oil imports.

5.2.3 Methodology Used to Estimate U.S. Energy Security Benefits

In order to understand the energy security implications of reducing U.S. oil imports, EPA has worked with Oak Ridge National Laboratory (ORNL), which has developed approaches for evaluating the social costs and energy security implications of oil use. In a new study entitled "*The Energy Security Benefits of Reduced Oil Use, 2006-2015*," produced for the Renewable Fuel Standard (RFS) Rule of 2007, ORNL has updated and applied the method used in the 1997 report "*Oil Imports: An Assessment of Benefits and Costs*", by Leiby, Jones, Curlee and Lee.^{NNNNNNNNNN,OOOOOOOOOO} A draft of this updated report was included as part of the record

^{NNNNNNNNNN} Leiby, Paul N., Donald W. Jones, T. Randall Curlee, and Russell Lee, *Oil Imports: An Assessment of Benefits and Costs*, ORNL-6851, Oak Ridge National Laboratory, November, 1997.

^{OOOOOOOOOO} The 1997 ORNL paper was cited and its results used in DOT/NHTSA’s rules establishing CAFE standards for 2008 through 2011 model year light trucks. See DOT/NHTSA, Final Regulatory Impacts Analysis: Corporate Average Fuel Economy and CAFE Reform MY 2008-2011, March 2006.

in the final RFS rulemaking, and the public was invited to analyze this Report and provide other perspectives for best quantifying energy security benefits. Since promulgation of the RFS rule, EPA has worked with ORNL to finalize the report and quantify the energy security benefits associated with a reduction in imported oil. In addition, the Report has been the subject to an external peer review by six experts from outside the U.S. government.^{PPPPPPPPPP} Updating the ORNL methodology to incorporate the comments from the Peer Reviewers, ORNL estimates that the total energy security benefits associated with a reduction of imported oil is \$12.38/barrel, with a range of \$6.88 - \$18.52/barrel of imported oil reduced. Highlights of the analysis are shown below.

The approach developed by ORNL estimates the incremental benefits to society, in dollars per barrel, of reducing U.S. oil imports, called "oil premium." Since the 1997 publication of this report, changes in oil market conditions, both current and projected, suggest that the magnitude of the oil premium has changed. Significant driving factors that have been revised include: projected world oil prices, current and anticipated levels of OPEC production, U.S. import levels, the estimated responsiveness of regional oil supplies and demands to price, and the likelihood of oil supply disruptions (see Table 5.2.3-1). For this analysis, oil prices from the EIA's AEO 2007 were used. Using the "oil premium" approach, estimates of benefits of improved U.S. energy security from reduced U.S. oil imports due to increased availability and use of other transportation fuels are calculated.

Table 5.2.3-1. Market and Parameter Changes Influencing Premium Estimate

Market and Parameter Changes Influencing Premium Estimate	
Condition (+ or – Indicates Directional Impact on Premium)	Percent Change Since 1996 Analysis*
U.S. Economy Larger (+)	+84%
Share of Oil in GDP (no net impact inferred)	Physical intensity -40%; Value share +67%
U.S. Oil Imports Higher (+)	+49%
World Oil Price Higher (+)	+125%
Estimated Ave. Likelihood of Oil Supply Disruption (+)	~+30%
U.S. Strategic Petroleum Reserve (SPR) Size Larger (-)	+15%
Estimated Short-run Responsiveness of U.S. Import Demand Greater (-)	+25%

*Percent changes compare the levels used in the 1996 study with the projected average level for the next 10 years, 2006-2015.

Source: Leiby, Paul N. "The Energy Security Benefits of Reduced Oil Use, 2006-2015", Oak Ridge National Laboratory ORNL/TM-2007/028, July 2007.

^{PPPPPPPPPP}Leiby, Paul N. "Estimating the Energy Security Benefits of Reduced U.S. Oil Imports: Final Report", ORNL/TM-2007/028, Oak Ridge National Laboratory, March 6, 2008.

In conducting this analysis, ORNL considered the full economic cost of importing petroleum into the U.S. The full economic cost of importing petroleum into the U.S. is defined for this analysis to include two components in addition to the purchase price of petroleum itself. These are: (1) the higher costs for oil imports resulting from the effect of U.S. import demand on the world oil price and OPEC market power (i.e., the "demand" or "monoposony" costs); and (2) the risk of reductions in U.S. economic output and disruption of the U.S. economy caused by sudden disruptions in the supply of imported oil to the U.S. (i.e., macroeconomic disruption/adjustment costs).

5.2.3.1 Effect of Oil Use on Long-Run Oil Price, U.S. Import Costs, and Economic Output

The first component of the full economic costs of importing petroleum into the U.S. follows from the effect of U.S. import demand on the world oil price over the long-run. Because the U.S. is a sufficiently large purchaser of foreign oil supplies, its purchases can affect the world oil price. This monopsony power means that increases in U.S. petroleum demand can cause the world price of crude oil to rise, and conversely, that reduced U.S. petroleum demand can reduce the world price of crude oil. Thus, one benefit of decreasing U.S. oil purchases, due to the increased availability and use of other transportation fuels, is the potential decrease in the crude oil price paid for all crude oil purchased.

The demand or monopsony effect can be readily illustrated with an example. If the U.S. imports 10 million barrels per day at a world oil price of \$50 per barrel, its total daily bill for oil imports is \$500 million. If a decrease in U.S. imports to 9 million barrels per day causes the world oil price to drop to \$49 per barrel, the daily U.S. oil import bill drops to \$441 million (9 million barrels times \$49 per barrel). While the world oil price only declines \$1, the resulting decrease in oil purchase payments of \$59 million per day (\$500 million minus \$441 million) is equivalent to an incremental benefit of \$59 per barrel of oil imports reduced, or \$10 more than the newly-decreased world price of \$49 per barrel. This additional \$10 per barrel "import cost premium" represents the incremental external benefits to U.S. society as a whole for avoided import costs beyond the price paid oil purchases. This additional benefit arises only to the extent that reduction in U.S. oil imports affects the world oil price. ORNL estimates this component of the energy security benefit to be \$7.65/barrel, with a range of \$2.86 – \$13.53/barrel of imported oil reduced.

5.2.3.2 Short-Run Disruption Premium from Expected Costs of Sudden Supply Disruptions

The second component of the oil import premium, the "disruption premium", arises from the effect of oil imports on the expected cost of disruptions. A sudden increase in oil prices triggered by a disruption in world oil supplies has two main effects: (1) it increases the costs of imports in the short run, further expanding the transfer of U.S. wealth to foreign producers, and (2) it can lead to macroeconomic contraction, dislocation and GDP losses. ORNL estimates the composite estimate of these two factors that comprise the "disruption premium" to be \$4.74/barrel, with a range of \$2.17 – \$7.64/barrel of imported oil reduced.

5.2.3.2.1 Higher Costs of Oil Imports and Wealth Transfer during Shocks

During oil price shocks, the higher price of imported oil causes increased payments for imports and a transfer of wealth from U.S. society to oil exporters. This increased claim on U.S. economic output is a loss to the U.S. that is separate from and additional to any reduction in economic output due to the shock. The increased wealth transfer during shocks is counted as a loss to the degree that the expected price increase is not anticipated and internalized by oil consumers.

5.2.3.2.2 Macroeconomic Costs: Potential Output Loss and Dislocation/Adjustment Costs

Macroeconomic losses during price shocks reflect both aggregate output losses and allocative losses. The former are a reduction in the level of output that the U.S. economy can produce fully using its available resources; and the latter stem from temporary dislocation and underutilization of available resources due to the shock, such as labor unemployment and idle plant capacity. The aggregate output effect, a reduction in “potential” economic output, will last so long as the price is elevated. It depends on the extent and duration of any disruption in the world supply of oil, since these factors determine the magnitude of the resulting increase in prices for petroleum products, as well as whether and how rapidly these prices return to their pre-disruption levels.

In addition to the aggregate contraction, there are “allocative” or “adjustment” costs associated with dislocated energy markets. Because supply disruptions and resulting price increases occur suddenly, empirical evidence shows they also impose additional costs on businesses and households which must adjust their use of petroleum and other productive factors more rapidly than if the same price increase had occurred gradually. Dislocational effects include the unemployment of workers and other resources during the time needed for their intersectoral or interregional reallocation, and pauses in capital investment due to uncertainty. These adjustments temporarily reduce the level of economic output that can be achieved even below the “potential” output level that would ultimately be reached once the economy’s adaptation to higher petroleum prices was complete. The additional costs imposed on businesses and households for making these adjustments reflect their limited ability to adjust prices, output levels, and their use of energy, labor and other inputs quickly and smoothly in response to rapid changes in prices for petroleum products.

Since future disruptions in foreign oil supplies are an uncertain prospect, each of the disruption cost components must be weighted by the probability that the supply of petroleum to the U.S. will actually be disrupted. Thus, the “expected value” of these costs – the product of the probability that a supply disruption will occur and the sum of costs from reduced economic output and the economy’s abrupt adjustment to sharply higher petroleum prices – is the relevant measure of their magnitude. Further, when assessing the energy security value of a policy to reduce oil use, it is only the change in the expected costs of disruption that results from the policy that is relevant. The expected costs of disruption may change from lowering the normal (pre-disruption) level of domestic petroleum use and imports, from any induced alteration in the likelihood or size of disruption, or from altering the short-run flexibility (elasticity) of petroleum use.

In summary, the steps needed to calculate the disruption or security premium are first, determine the likelihood of an oil supply disruption in the future; second, assess the likely impacts of a potential oil supply disruption on the world oil price; third, assess the impact of the oil price shock on the U.S. economy (in terms of import costs and macroeconomic losses); and fourth, determine how these costs change with oil imports. The value of price spike costs avoided by reducing oil imports becomes the oil security portion of the premium. ORNL estimates the composite value that comprises the “disruption premium” to be \$4.74/barrel, with a range of \$2.17 – \$7.64/barrel of imported oil reduced.

We recognize that our current energy security analysis does not take into account risk-shifting that might occur as the U.S. reduces its dependency on petroleum by increasing its use of biofuels. For example, our analysis did not take into account other energy security implications associated with biofuels, such as possible supply disruptions of corn-based ethanol. Between the proposal and the final rulemaking, EPA will attempt to broaden our energy security analysis to incorporate estimates of overall motor fuel supply and demand flexibility and reliability, and impacts of possible agricultural sector market disruptions (for example, a drought) for presentation in the final rule. The expanded analysis will also consider how the use of biofuels can alter short and long run elasticity (flexibility) in the motor fuel market, with implications for robustness of the fuel system in the face of diverse supply shocks. As part of this analysis, the Agency plans on analyzing those factors that can cause shifts in the prices of biofuels, and the impact these factors have on the energy security estimate.

5.2.3.3 Costs of Existing U.S. Energy Security Policies

The last often-identified component of the full economic costs of U.S. oil imports is the costs to the U.S. taxpayers of existing U.S. energy security policies. The two primary examples are maintaining a military presence to help secure a stable oil supply from potentially vulnerable regions of the world and maintaining the Strategic Petroleum Reserve (SPR). The SPR is the largest stockpile of government-owned emergency crude oil in the world. Established in the aftermath of the 1973-74 oil embargo, the SPR provides the U.S. a response option should a disruption in commercial oil supplies threaten the U.S. economy. It also allows the U.S. to meet part of its International Energy Agency obligation to maintain emergency oil stocks, and it provides a national defense fuel reserve.

U.S. military costs are excluded from the analysis performed by ORNL because their attribution to particular missions or activities is difficult. Most military forces serve a broad range of security and foreign policy objectives. Attempts to attribute some share of U.S. military costs to oil imports are further challenged by the need to estimate how those costs might vary with incremental variations in U.S. oil imports. Similarly, while the costs for building and maintaining the SPR are more clearly related to U.S. oil use and imports, historically these costs have not varied in response to changes in U.S. oil import levels. Thus, while SPR is factored into the ORNL analysis, the cost of maintaining the SPR is excluded.

5.2.3.4 Modifications to Analysis Based Upon Peer Reviewer Comments

The Agency commissioned ORNL to conduct a number of sensitivity analyses to address the comments of the Peer Reviewers. Based upon the Peer Reviewer comments, key parameters that influence the “oil import” premium were assessed. Since not all the comments were in agreement with each other, several ranges of different parameters were developed for the analyses. A summary of the results of the analyses are shown in Table 5.2.3-2.

Three key parameters were varied in order to assess their impacts on the oil import premium: (1) the response of OPEC supply, (2) the combined response of non-U.S., non-OPEC demand and supply and (3) the GDP response to a change in the world oil as a result of reduced U.S. oil imports. The cases in Table 5.2.3-2 used updated supply/demand elasticities for non-U.S./non-OPEC region after considering more recent estimates than those used in 1997 study. As a result, the total market responsiveness is greater than previous ORNL estimates. Only small changes to the world oil price are anticipated from a substantial reduction in U.S. demand, on average, about \$0.70/bbl for every million-barrels-per-day reduction in demand.

In the ORNL framework, OPEC-behavior is treated parametrically, with a wide range of possible responses represented by a range of supply elasticities. Case One in the Table below refers to the AEO 2007 estimates of energy market trends and uses the elasticity parameters from the original 1997 ORNL study. In Case Two, the OPEC supply elasticities range for 0.25 to 6 with a mean elasticity of 1.7. Case Three alters the distribution of the OPEC supply elasticities so that the mean elasticity is 2.2 instead of 1.7. With the more elastic OPEC oil supply in Case Three, the oil premium is lower. Alternatively, a candidate rule for OPEC strategic response behavior, adapted from a lead article on what behavior maximizes OPEC’s long run net revenue in a robust way,^{QQQQQQQQQQ} would have OPEC responding to preserve its worldwide oil market share. This is presented as Case Seven. Application of this rule instead of the range of OPEC supply responses used leads to an estimate of the oil import premium that is between Case Two and Case Three.

The second key parameter that was varied based upon Peer Reviewer comments was non-OPEC, non-U.S. demand and supply responsiveness to a change in the U.S. oil import demand and, hence, the world oil price. In Case Four (see Table below), the mean non-U.S./non-OPEC demand and supply elasticities are taken to each be 0.3 in absolute value terms. When combined together, the net elasticity of import demand from this region — the non-U.S./non-OPEC region is — roughly 1.6. Case Five takes the Case Four assumptions of a more elastic OPEC supply behavior and combines those assumptions with the 1.6 net elasticity of import demand for the non-U.S./non-OPEC region. Case Six looks at the consequences of a yet higher net elasticity of import demand — 2.28 — for the non-U.S./non-OPEC region. The impact on the oil import premium is relatively modest.

Cases Eight and Nine consider a reduced GDP elasticity, the parameter which summarizes the sensitivity of GDP to oil price shocks. Several Reviewers suggested a lower estimate for this parameter. In response to their comments, a couple of cases were examined

^{QQQQQQQQQQ} Gately, Dermot 2004. "OPEC's Incentives for Faster Output Growth," *The Energy Journal*, 25(2):75-96, "What Oil Export Levels Should We Expect From OPEC?" *The Energy Journal*, 28(2):151-173, 2007.

where the GDP elasticity was lowered to 0.032 in comparison to the original ORNL estimate of 0.0495. As anticipated, this change lowered the oil import premium modestly. For example, compared with Case Four where OPEC supply is more elastic, lowering the GDP elasticity with respect to the world oil price reduced the oil import premium by roughly \$0.40/barrel. This is because the GDP-dislocation component is only about one-quarter of the total premium, and there are offsetting changes in other components. The last case examined, Case Nine, looks at the consequences for the oil import premium with a reduced elasticity of GDP if OPEC attempts to maintain its share of the world oil market.

Clearly there is an unavoidable degree of uncertainty about the magnitude of marginal economic costs from the U.S. importation of petroleum, and the size of the oil import premium. ORNL sought to reflect this with probabilistic risk analysis over key input factors, guided by the available literature and the best judgment of oil market experts. Cases shown in Table 5.2.3-2 explore some reasonable variations in the ranges of input assumptions and the mean oil premium estimates vary in a fairly moderate range between roughly \$11 and \$15/barrel of imported oil. On balance, Case Eight suggested a reasonable and cautious assessment of the premium value to ORNL, and is ORNL's recommended case. This is based on a review of important driving factors, the numerical evaluations and simulations over major uncertainties, and taking into consideration the many comments and suggestion from the Reviewers, the EPA and other Agencies. This recommended case, and the premium range resulting from 90% of the simulated outcomes, encompasses a wide array of perspectives and potential market outcomes in response to a reduction of U.S. imports.

This recommended case relies on the most recent available projections of the U.S. and world oil market for the next ten years based upon the AEO 2007 Reference Case. OPEC-behavior is treated parametrically, with a wide range of possible responses represented by a wide range of supply elasticities, from small to quite large. This recommended case recognizes that the OPEC response is the most uncertain single element of this analysis. It could vary between inelastic defense of output levels, or market share, or could be highly elastic in defense of price, probably at the expense of longer run cartel power and discounted net profits. The balance between possible elastic and inelastic OPEC response is essentially even over a fairly wide range of elasticities. ORNL concluded that this is the best way to estimate OPEC behavior until greater progress can be made in synthesizing what insights are available from the evolving strategic game-theoretic and empirical research on OPEC behavior, and advancing that research. An alternative would have been to use OPEC strategic response behavior to maximize long-run net revenue, which may well correspond to market-share preservation behavior (e.g., Case Seven), and a somewhat higher premium value.

Finally, ORNL's recommended case uses a GDP elasticity range, the parameter which summarizes the sensitivity of GDP to oil price shocks, which is reduced compared to earlier estimates, and compared to the full range of historically-based estimates. This helps address the concerns of those who either question the conclusions of past empirical estimates or expect that the impacts of oil shocks may well be declining. EPA requests comment on the ORNL oil security methodology outline above and the estimates of the recommended "oil premium" estimate developed using the ORNL methodology.

This page intentionally left blank.

Table 5.2.3-2: Summary Results - Oil Import Premium Under Various Cases (\$2006/BBL)

Component	Statistic	1) AEO2007 Base Outlook, 1997 Study Elasticities	2) AEO2007 Base Outlook, Wider Range of OPEC Supply Elasticities	3) Case 2 with Revised Wider Range of OPEC Supply Elasticities	4) Case 2 with Updated Non-OPEC Supply/Demand Elasticities	5) Case 4 plus Revised Wider Range of OPEC Supply Elasticities	6) Case 4 Variant with Wider, Higher Range of Non-U.S./Non-OPEC Supply/Demand Elasticities	7) Case 6 with Applied Strategic OPEC Behavioral Rule: Maintain Market Share	8) Case 4 with Reduced GDP Elasticity	9) Case 7 with Reduced GDP Elasticity
Monopsony Component	Mean	\$5.42	\$9.99	\$7.95	\$7.57	\$6.35	\$6.27	\$9.11	\$7.65	\$9.17
	Range	(\$3.51 - \$7.98)	(\$3.02 - \$20.66)	(\$3.04 - \$18.79)	(\$2.86 - \$13.39)	(\$2.82 - \$12.72)	(\$2.62 - \$11.03)	(\$6.51 - \$12.09)	(\$2.86 - \$13.53)	(\$6.54 - \$12.21)
Disruption Import Costs	Mean	\$2.30	\$2.27	\$2.28	\$1.87	\$1.89	\$1.88	\$1.84	\$2.14	\$2.10
	Range	(\$0.5 - \$4.54)	(\$0.56 - \$4.45)	(\$0.64 - \$4.49)	(\$0.38 - \$3.65)	(\$0.37 - \$3.74)	(\$0.41 - \$3.6)	(\$0.43 - \$3.56)	(\$0.61 - \$3.96)	(\$0.6 - \$3.86)
Disruption Dislocation Costs	Mean	\$3.73	\$3.60	\$3.66	\$3.33	\$3.36	\$3.38	\$3.32	\$2.60	\$2.57
	Range	(\$1.03 - \$6.51)	(\$1.01 - \$6.4)	(\$1.03 - \$6.56)	(\$0.9 - \$6.07)	(\$0.92 - \$5.94)	(\$0.9 - \$5.97)	(\$0.85 - \$6.1)	(\$0.88 - \$4.71)	(\$0.85 - \$4.74)
Economic Disruption/Adjustment Costs	Mean	\$6.03	\$5.87	\$5.94	\$5.20	\$5.25	\$5.26	\$5.16	\$4.74	\$4.68
	Range	(\$2.86 - \$9.75)	(\$2.86 - \$9.49)	(\$2.82 - \$9.59)	(\$2.46 - \$8.46)	(\$2.53 - \$8.39)	(\$2.51 - \$8.69)	(\$2.47 - \$8.51)	(\$2.17 - \$7.64)	(\$2.19 - \$7.57)
Total Mid-Point	Mean	\$11.44	\$15.86	\$13.90	\$12.77	\$11.59	\$11.55	\$14.27	\$12.38	\$13.86
	Range	(\$7.83 - \$15.54)	(\$7.89 - \$26.7)	(\$7.69 - \$24.82)	(\$7.07 - \$19.08)	(\$6.78 - \$18.13)	(\$6.61 - \$16.78)	(\$10.74 - \$18.12)	(\$6.88 - \$18.52)	(\$10.48 - \$17.77)
Total Premium, in \$/Gallon	Mean	\$0.27	\$0.38	\$0.33	\$0.30	\$0.28	\$0.28	\$0.34	\$0.29	\$0.33
Price Reduction (\$/MMBD)	Mean	\$0.51	\$1.01	\$0.78	\$0.73	\$0.60	\$0.59	\$0.88	\$0.73	\$0.88

Cases

- 1) Based on AEO2007. Updated oil market outlook from AEO1994 Base Case to AEO2007 Base Case. Among other things, this means average crude price rises from \$20.33 to \$48.34. All elasticities match 1997 values. Non-U.S. elasticity of import demand = -0.876, parametric treatment of OPEC response with elasticity 1.0-5.0 (triangular distribution with mode 2.0).
- 2) AEO2007 Base Outlook, with wider range of OPEC supply elasticities, 0.25 to 6.0 and a mean elasticity of 1.76.
- 3) Revise Case 2, with OPEC behavior distributed over elasticities 0 to 6, so that 25% of response is inelastic (< 1.0), mode elasticity is 2.0 (mean elasticity is 2.2 rather than 1.76)
- 4) Updated Case 2 supply/demand elasticities for non-OPEC region with more recent estimates. Elasticity of non-U.S. demand -0.2 to -0.4, with mean and mode -0.3, non-U.S. Supply = 0.2 to 0.4, with mean and mode 0.3, implying (mode) net elasticity of import demand from non-U.S./non-OPEC regions ~doubled to -1.6.
- 5) Revise Case 4, with OPEC behavior distributed over elasticities 0 to 6, so that 25% of response is inelastic (< 1.0), mode elasticity is 2.0 (mean elasticity is 2.2 rather than 1.76). Net elasticity of import demand is -1.6 for the non-U.S./non-OPEC region.
- 6) Alternative to Case 4 with expanded (and higher) range of non-U.S. supply/demand elasticities. Elasticity of non-U.S. demand = -0.3 to -0.7, triangular distribution with mode -0.4 mean -0.467, elasticity of non-U.S. supply = 0.2 to 0.6, mode 0.3 and mean 0.367. Implying (mode) net elasticity of import demand from non-U.S./non-OPEC regions more than doubled to -1.92, mean -2.28.
- 7) Applied Strategic OPEC Behavioral Rule to Case 6: Maintain Market Share (Gately 2004 paper best strategy). This rule implies that OPEC Supply elasticity matches that of all non-OPEC supply. As a result non-U.S. elasticity of import demand ranges from -1.38 to -3.52, with mode -1.92, mean -2.28. Total elasticity of net import supply to U.S. then ranges from 4.8 to 8.6 (90% confidence interval).
- 8) Variant on version Case 4, considered reduced GDP elasticity for future disruptions (range -0.01 to -0.054; midcase value -0.032; mean value is -0.032, reduced from mean value of -0.0495). OPEC-behavior treated parametrically.
- 9) Revise Case 7 (which applied Strategic OPEC Behavioral Rule to Case 6: Maintain Market Share (Gately 2004 paper best strategy)) with reduced GDP elasticity for future disruptions (range -0.01 to -0.054; midcase value -0.032; mean value is -0.032, reduced from mean value of -0.0495).

This page intentionally left blank.

5.2.4 Estimates of per Barrel and Total U.S. Energy Security Benefits

Table 5.2.4-1 below summarizes ORNL’s estimate of the energy security benefits associated with the RFS2 proposal. The components of the energy security benefit estimate are shown as well as the total U.S. energy security benefits associated with U.S. import reductions due to this proposed rule, in Table 5.2.4-2.

**Table 5.2.4-1.
Energy Security Benefits
(\$/barrel in 2006\$)**

Effect	Updated ORNL Study
Monopsony (best estimate) (range)	\$7.65 \$3.35 – \$12.45
Macroeconomic Disruption (best estimate) (range)	\$4.74 \$2.64 – \$6.96
Total (best estimate) (range)	\$12.38 \$7.65 - \$17.23

Total energy security benefits associated with the RFS2 proposal are calculated in Table 5.2.4-1 for the year 2022. These benefits are derived from the estimated reductions in imports of finished petroleum products and crude oil using an energy security premium price of \$12.38/barrel.

**Table 5.2.4-2.
Total Energy Security Benefits
(billions of 2006\$)**

Year	2022
Benefits	\$3.7

5.3 Benefits of Reducing GHG Emissions

5.3.1 Introduction

The wider use of renewable fuels from the RFS2 proposal results in reductions in greenhouse gas (GHG) emissions. Carbon dioxide (CO₂) and other GHGs mix well in the atmosphere, regardless of the location of the source, with each unit of emissions affecting global regional climates; and therefore, influencing regional biophysical and socioeconomic systems. The effects of changes in GHG emissions are felt for decades to centuries given the atmospheric lifetimes of GHGs. This section provides estimates for the marginal and total benefits that could be monetized for the projected GHG emissions reductions of this proposal. EPA requests comment on the approach utilized to estimate the GHG benefits associated with the proposal.

5.3.2 Marginal GHG Benefits Estimates

The projected net GHG emissions reductions associated with the proposal reflect an incremental change to projected total global emissions. Therefore, as shown in Section 2.4, the projected global climate signal will be small but discernable (i.e., it incrementally shifts the distribution of projected global mean surface temperatures to the left with the upper end shifting more than the lower end). Given that the climate response is projected to be marginal relative to the baseline climate, it is conceptually appropriate to use an approach that estimates the marginal value of changes in climate change impacts over time as an estimate for the monetized marginal benefit of the GHG emissions reductions projected for this proposal. The marginal value of carbon is equal to the net present value of climate change impacts over hundreds of years of one additional net global metric ton of GHGs emitted to the atmosphere at a particular point in time. This marginal value (i.e., cost) of carbon is sometimes referred to as the “social cost of carbon.”

Based on the global implications of GHGs and the economic principles that follow, EPA has developed ranges of global *marginal* benefits estimates, as well as U.S. marginal estimates (Table 5.3-1).^{RRRRRRRRRRR} It is important to note at the outset that the estimates are incomplete since current methods are only able to reflect a partial accounting of the climate change impacts identified by the Intergovernmental Panel on Climate Change (IPCC; discussed more below). Also, domestic estimates omit impacts on the United States resulting from climate change impacts in other countries (e.g., economic or national security impacts). The global estimates were developed from a survey analysis of the peer reviewed literature (i.e., meta analysis). U.S. estimates, and a consistent set of global estimates, were developed from a single model and are highly preliminary, under evaluation, and likely to be revised. The single model used was the Climate Framework for Uncertainty, Negotiation, and Distribution (FUND; discussed below). It was necessary to develop the latter set of estimates because the peer reviewed literature does not provide regional (i.e., at the U.S. or China level) marginal benefits estimates, and, since the regional estimates are not directly comparable to the global meta analysis estimates, it was important to have a consistent set of regional and global estimates. Ranges of estimates are provided to capture some of the uncertainties associated with modeling climate change impacts.

The range of estimates is wide due to the uncertainties relating to socio-economic futures, climate responsiveness, impacts modeling, as well as the choice of discount rate.^{SSSSSSSSSS} For instance, for 2007 emission reductions and a 2% consumption discount rate the global meta analysis estimates range from \$-3 to \$159/t CO₂, while the U.S. estimates range from \$0 to \$16/t CO₂. For 2007 emission reductions and a 3% consumption discount rate, the global meta-estimates range from \$-4 to \$106/t CO₂, and the U.S. estimates range from \$0 to \$5/t CO₂.^{TTTTTTTTTTT} The global meta analysis mean values for 2007 emission reductions are \$68 and \$40/t CO₂ for discount rates of 2% and 3% respectively (in 2006 \$) while the domestic mean

^{RRRRRRRRRRR} For background on economic principles and the marginal benefit estimates, see *Technical Support Document on Benefits of Reducing GHG Emissions*, U.S. Environmental Protection Agency, June 12, 2008, www.regulations.gov (search phrase “Technical Support Document on Benefits of Reducing GHG Emissions”)

^{SSSSSSSSSS} A discount rate reflects the rate at which people trade-off a dollar received today versus a dollar received a year from now. People generally value benefits received today more than those received tomorrow. As a result, when making decisions today, they tend to discount the benefits they receive in the future. The actual discount rate depends on the decision-maker and the kind of investment. In this context, the decision-maker is the Federal Government and changing GHG emissions is an investment with an extremely long-run annual (non-constant) return. Therefore, social discounting and intergenerational discount rates are appropriate.

^{TTTTTTTTTTT} See Table 5.3-1 for global (FUND) estimates consistent with the U.S. estimates.

values from a single model are \$4 and \$1/t CO₂ for the same discount rates. The estimates for future year emission changes are likely to be higher as future marginal emissions increases are expected to produce larger incremental damages as physical and economic systems become more stressed as the magnitude of climate change increases.

**Table 5.3-1.
Marginal GHG Benefits Estimates for Consumption Discount Rates of
2%, 3%, and 7% and Year of Emissions Change
(all values are reported in 2006\$/tCO₂)**

		2%			3%			7%**		
		Low	Central	High	Low	Central	High	Low	Central	High
Meta global	2007	-3	68	159	-4	40	106	n/a	n/a	n/a
	2017	-2	91	213	-3	53	142	n/a	n/a	n/a
	2022	-2	105	247	-2	62	165	n/a	n/a	n/a
	2030	-1	134	314	-2	78	209	n/a	n/a	n/a
	2040	-1	179	421	-1	105	281	n/a	n/a	n/a
FUND global	2007	-6	88	695	-6	17	132	-3	-1	5
	2017	-4	118	934	-4	23	178	-2	-1	7
	2022	-4	136	1083	-4	26	206	-2	-1	9
	2030	-3	173	1372	-3	33	261	-1	0	11
	2040	-2	232	1843	-2	44	351	-1	0	15
FUND domestic	2007	0	4	16	0	1	5	0	0	0
	2017	0*	6	22	0*	1	7	0*	0*	0*
	2022	0*	7	26	0*	2	9	0*	0*	0*
	2030	0*	9	32	0*	2	11	0*	0*	0*
	2040	0*	12	44	0*	3	15	0*	0*	0*

* These estimates, if explicitly estimated, may be greater than zero, especially in later years. They are currently reported as zero because the explicit estimates for an earlier year were zero and were grown at 3% per year. However, we do not anticipate that the explicit estimates for these later years would be significantly above zero given the magnitude of the current central estimates for discount rates of 2% and 3% and the effect of the high discount rate in the case of 7%.

** Except for illustrative purposes, the marginal benefits estimates in the peer reviewed literature do not use consumption discount rates as high as 7%.

The meta analysis ranges were developed from the Tol (2008) meta analysis. The meta analysis range only includes global estimates generated by more recent peer reviewed studies (i.e., published after 1995). In addition, the ranges only consider regional aggregations using simple summation and intergenerational consumption discount rates of approximately 2% and 3%. Discount rates of 2% and 3% are consistent with EPA and OMB guidance on intergenerational discount rates (EPA, 2000; OMB, 2003). The estimated distributions of the meta global estimates are right skewed with long right tails, which is consistent with characterizations of low probability high impact damages, such as catastrophic events like collapse of the West Antarctic Ice

The IPCC suggests an increase of 2-4% per year (IPCC WGII, 2007. *Climate Change 2007 - Impacts, Adaptation and Vulnerability*. Contribution of Working Group II to the Fourth Assessment Report of the IPCC, <http://www.ipcc.ch/>). For Table 5.3-1., we assumed the estimates increased at 3% per year. For the final rule, we anticipate that we will explicitly estimate FUND marginal benefits values for each emissions reduction year.

Tol (2008) is an update of the Tol (2005) meta analysis. Tol (2005) was used in the IPCC Working Group II's Fourth Assessment Report (IPCC WGII, 2007).

OMB and EPA guidance on inter-generational discounting suggests using a low but positive discount rate if there are important intergenerational benefits/costs. Consumption discount rates of 1% to 3% are given by OMB and 0.5% to 3% by EPA (OMB Circular A-4, 2003; EPA Guidelines for Preparing Economic Analyses, 2000).

Sheet. XXXXXXXXXXXX YYYYYYYYYY ZZZZZZZZZZ Figure 5.3-1 provides the estimated probability density functions by discount rate. Following Tol (2008), we fit extreme value Fisher-Tippett distributions because they better reflected the right skewness of the data. AAAAAAAAAAAAAA Note that the x-axis of Figure 5.3-1 reflects that marginal value for emissions reductions circa 1995. As noted above, these values were grown to produce the estimates in Table 5.3-1. The central meta estimates in Table 5.3-1 are means, and the low and high are the 5th and 95th percentiles. Means are presented because, as a central statistic, they better represent the skewed shape of these distributions compared to medians.

Figure 5.3-1.
Probability Density Functions for Meta Analysis Global Marginal Benefit Estimates for a Marginal Emissions Reduction circa 1995 and Consumption Discount Rates of 2% and 3% (Developed from Tol, 2008, Meta Analysis)

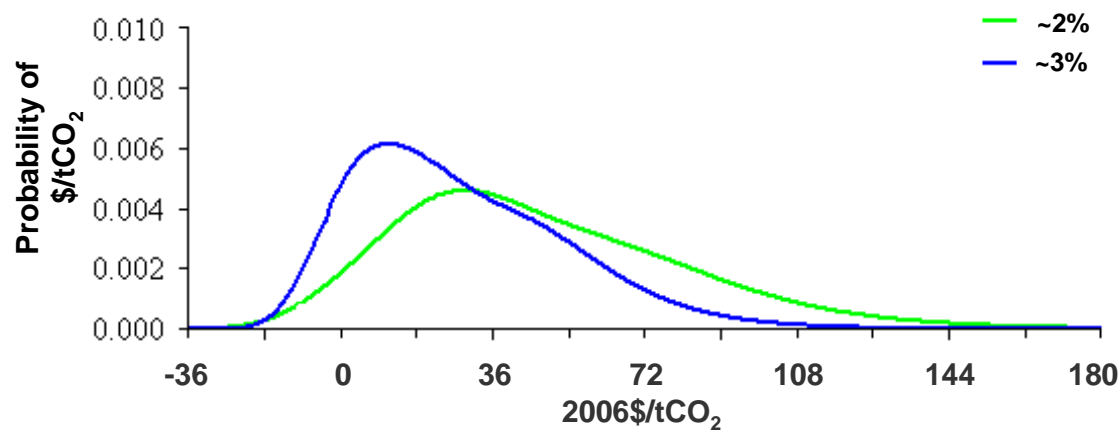

The consistent domestic and global estimates were developed using the FUND integrated assessment model. BBBBBBBBBBBBB The ranges were generated from sensitivity analysis where assumptions were varied with respect to climate sensitivity (1.5 to 6.0 degrees

XXXXXXXXXXXX Webster, M., C. Forest, J.M. Reilly, M.H. Babiker, D.W. Kicklighter, M. Mayer, R.G. Prinn, M. Sarofim, A.P. Sokolov, P.H. Stone & C. Wang, 2003. Uncertainty Analysis of Climate Change and Policy Response, *Climatic Change* 61(3): 295-320.

YYYYYYYYYYY Weitzman, M., 2007, "The Stern Review of the Economics of Climate Change," *Journal of Economic Literature*.

ZZZZZZZZZZ Weitzman, M., 2007, "Structural Uncertainty and the Statistical Life in the Economics of Catastrophic Climate Change," Working paper <http://econweb.fas.harvard.edu/faculty/weitzman/papers/ValStatLifeClimate.pdf>.

AAAAAAAAAAAAA For our meta analysis, the sample sizes were 13 and 10 for consumption discount rates of 2% and 3% respectively. A sample size of 10 or greater is considered sufficient for estimating an extreme value distribution (Carter, D. J. T. and P. G. Challenor, 1983. Application of extreme value analysis to Weibull data, *Quart. J. R. Met. Soc.* 109, 429-433).

BBBBBBBBBBBBB FUND is a spatially and temporally consistent framework across regions of the world (e.g., U.S., China), impacts sectors, and time. FUND explicitly models impacts sectors in 16 global regions. FUND is one of the few models in the world that explicitly models global and regional marginal benefits estimates. Numerous applications of FUND have been published in the peer reviewed literature dating back to 1997. See <http://www.fnu.zmaw.de/FUND.5679.0.html>.

Celsius),^{CCCCCCCCCCCC} the socio-economic and emissions baseline scenarios (the FUND default baseline and three baselines from the Intergovernmental Panel on Climate Change (IPCC) Special Report on Emissions Scenarios, SRES),^{DDDDDDDDDDDD} and the consumption discount rates of approximately 2%, 3%, and 7%, where 2% and 3% are consistent with intergenerational discounting.^{EEEEEEEEEEEE} Furthermore, the model was calibrated to the EPA value of a statistical life of \$7.4 million (2006\$).^{FFFFFFFFFFFF} The FUND global estimates are the sum of the regional estimates within FUND. The FUND global and domestic central values in Table 5.3-1 are weighted averages of the FUND estimates from the sensitivity analysis. The low and high values are the low and high estimates across the sensitivity runs. See Table 5.3-2 for the global and domestic marginal benefit estimates by baseline, climate sensitivity, and discount rate. The weighted averages were calculated using a climate sensitivity probability density function based on IPCC WGI (2007) and equal weights for the alternative socioeconomic baselines.^{GGGGGGGGGGGG}

**Table 5.3-2.
Global and Domestic Marginal Benefit Estimates from FUND Modeling by Baseline,
Climate Sensitivity (CS), and Discount Rate (DR) for an Additional Unit of Emissions in
2005 (2006\$/t CO₂)**

		CS = 1.5 deg C			2			3			4.5			6		
Baseline		DR = ~2%	~3%	~7%	~2%	~3%	~7%	~2%	~3%	~7%	~2%	~3%	~7%	~2%	~3%	~7%
Global	FUND	-\$2	-\$5	-\$3	\$9	-\$2	-\$3	\$43	\$9	-\$1	\$140	\$35	\$1	\$365	\$81	\$5
	A1b	-\$6	-\$5	-\$3	\$0	-\$3	-\$2	\$16	\$3	-\$2	\$54	\$16	\$0	\$114	\$37	\$3
	A2	-\$2	-\$6	-\$3	\$15	-\$1	-\$3	\$68	\$13	-\$2	\$240	\$51	\$1	\$655	\$125	\$5
	B2	-\$4	-\$5	-\$3	\$8	-\$2	-\$3	\$43	\$8	-\$2	\$145	\$34	\$1	\$409	\$83	\$4
Domestic	FUND	\$0	\$0	\$0	\$1	\$0	\$0	\$3	\$1	\$0	\$7	\$2	\$0	\$11	\$4	\$0
	A1b	\$0	\$0	\$0	\$1	\$0	\$0	\$2	\$1	\$0	\$6	\$2	\$0	\$10	\$3	\$0
	A2	\$0	\$0	\$0	\$2	\$0	\$0	\$4	\$1	\$0	\$9	\$3	\$0	\$15	\$5	\$0
	B2	\$0	\$0	\$0	\$1	\$0	\$0	\$3	\$1	\$0	\$7	\$2	\$0	\$11	\$4	\$0

^{CCCCCCCCCCCC} In IPCC reports, equilibrium climate sensitivity refers to the equilibrium change in the annual mean global surface temperature following a doubling of the atmospheric equivalent carbon dioxide concentration. The IPCC states that climate sensitivity is “likely” to be in the range of 2°C to 4.5°C and described 3°C as a “best estimate”, which is the mode (or most likely) value. The IPCC goes on to note that climate sensitivity is “very unlikely” to be less than 1.5°C and “values substantially higher than 4.5°C cannot be excluded.” IPCC WGI, 2007, Climate Change 2007 - The Physical Science Basis, Contribution of Working Group I to the Fourth Assessment Report of the IPCC, <http://www.ipcc.ch/>.

^{DDDDDDDDDDDD} The IMAGE model SRES baseline data were used for the A1b, A2, and B2 scenarios (IPCC, 2000. *Special Report on Emissions Scenarios*. A special report of Working Group III of the Intergovernmental Panel on Climate Change. Cambridge University Press, Cambridge). The A1b baseline represents a world focused on global economic growth with an increasingly globalized economy, with a balanced energy technology portfolio between fossil fuel and non-fossil fuel supply and consumption, and diffusion of technological advances. The A2 baseline represents a world focused on regional economic growth with increasing inequality between regions as developed regions grow more quickly than developing regions. B2 represents a world focused on both global economic growth and environmental improvement.

^{EEEEEEEEEEEE} The EPA guidance on intergenerational discounting states that “[e]conomic analyses should present a sensitivity analysis of alternative discount rates, including discounting at two to three percent and seven percent as in the intra-generational case, as well as scenarios using rates in the interval one-half to three percent as prescribed by optimal growth models.” (EPA, 2000)

^{FFFFFFFFFFFF} This number may be updated to be consistent with recent EPA Office of Air and Radiation regulatory impact analyses that has used a value of \$6.4 million (in 2006 real dollars).

^{GGGGGGGGGGGG} The climate sensitivity probability density function was calibrated to the cumulative density functions in Chapter 10 of IPCC WGI (2007), and the IPCC’s formal definitions for climate sensitivity likelihood.

Figures 5.3-2 through 5.3-5 provide the undiscounted global and domestic annual marginal benefits from our FUND modeling for an illustrative set of scenarios from our sensitivity analysis for an incremental emissions change in 2005.^{HHHHHHHHHHHHHHH} The figures illustrate the sensitivity of the global and domestic results to baseline and climate responsiveness. These streams of annual benefits were discounted following the common approach of Ramsey discounting, which incorporates changes in economic growth and the marginal utility of consumption over time.^{IIIIIIIIII} We calibrated our discounting to produce U.S. consumption discount rates of approximately 2% and 3% in order to be consistent with OMB and EPA inter-generational discounting guidance. The resulting calibration produced 2005 rates of 2.7% to 2.9% for the U.S., and 1.8% to 5.5% across regions. The rates vary by region and time period as regional annual growth in per capita consumption changes.

Figure 5.3-2.
Undiscounted Global Annual Marginal Benefits from FUND Modeling for an Emissions Reduction in 2005 with the FUND Default Baseline and Climate Sensitivities of 1.5, 2.0, 3.0, 4.5, and 6.0

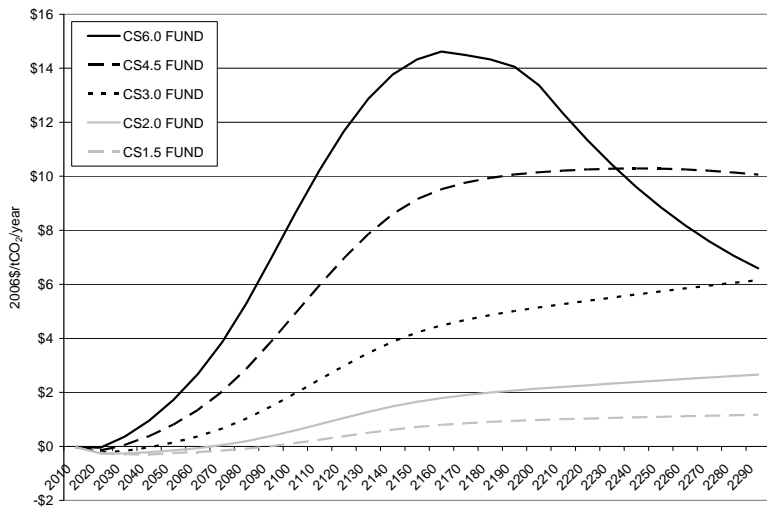

^{HHHHHHHHHHHHHHH} Undiscounted annual benefits are not available for the meta analysis estimates. The FUND default year for our runs is 2005. FUND marginal benefit estimates for subsequent years in Table 5.3-1 were computed by growing the 2005 values at 3%/year as discussed above.

^{IIIIIIIIII} A constant discount rate implies constant economic growth, which is unrealistic over long time horizons. Interest rates are a function of economic growth; and, increasing (declining) economic growth implies an increasing (declining) discount rate. Furthermore, increasing uncertainty in economic growth implies, among other things, increasing uncertainty in interest rates and declining certainty equivalent rates of returns to capital (Hansen, A.C., 2006. "Do declining discount rates lead to time inconsistent economic advice?" *Ecological Economics* 60(1), 138-144.)

Figure 5.3-3.
Undiscounted Global Annual Marginal Benefits from FUND Modeling for an Emissions Reduction in 2005 with the SRES A1b, A2, B2, and FUND Default Baselines and a Climate Sensitivity of 3.0

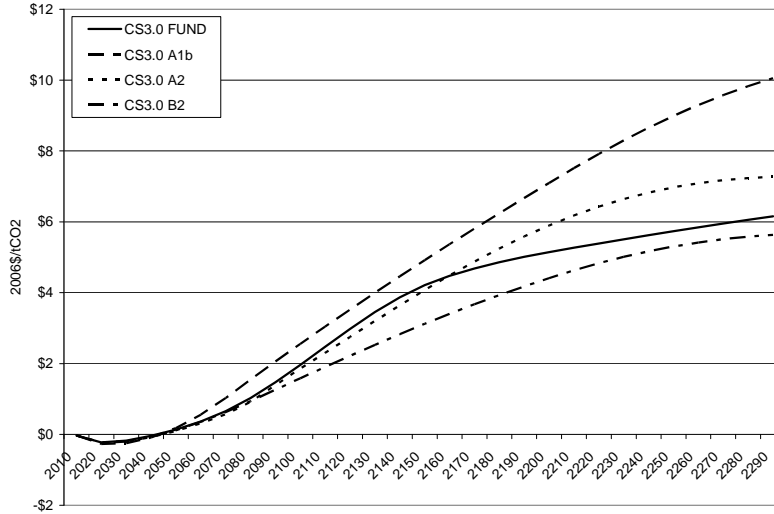

Figure 5.3-4.
Undiscounted U.S. Annual Marginal Benefits from FUND Modeling for an Emissions Reduction in 2005 with the FUND Default Baseline and Climate Sensitivities of 1.5, 2.0, 3.0, 4.5, and 6.0

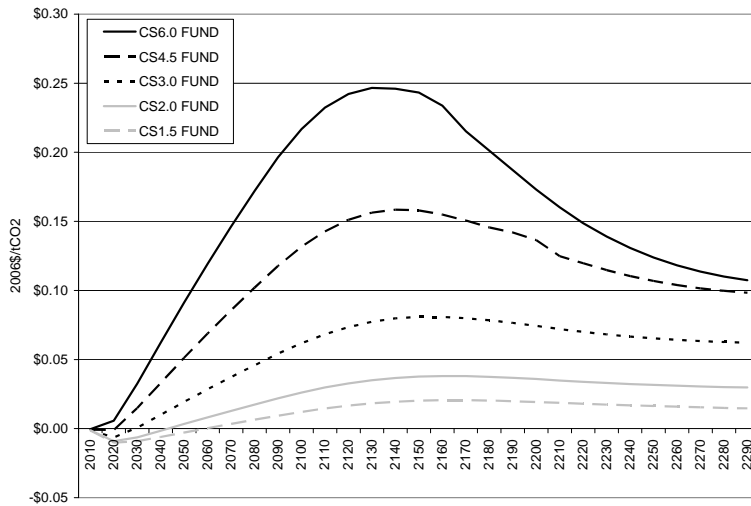
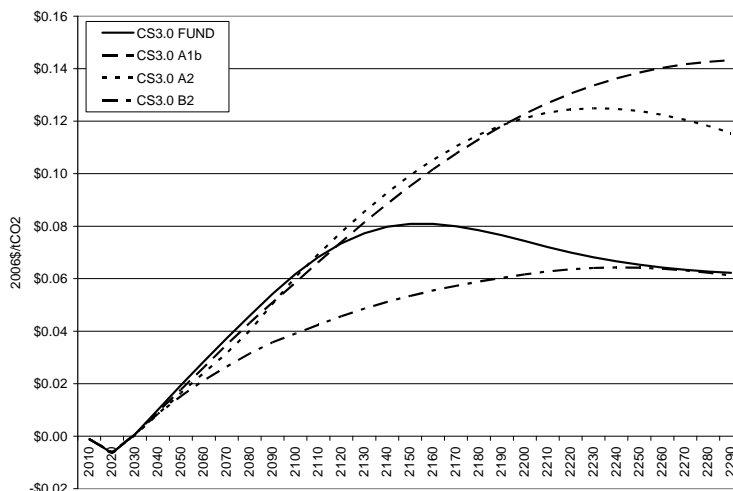

Figure 5.3-5.
Undiscounted U.S. Annual Marginal Benefits from FUND Modeling for an Emissions Reduction in 2005 with the SRES A1b, A2, B2, and FUND Default Baselines and a Climate Sensitivity of 3.0



From Tables 5.3-1 and 5.3-2, we see that the estimates are very sensitive to assumptions. The FUND sensitivity analysis shows that higher marginal benefits estimates are associated with higher climate sensitivities, lower economic growth per capita globally and regionally, and lower discount rates. In terms of the current monetized benefits, the domestic marginal benefits are a fraction of the global marginal benefits. Given uncertainties and omitted impacts, it is difficult to estimate the actual ratio of total domestic benefits to total global benefits. The estimates suggest that an emission reduction will have direct benefits for current and future U.S. populations and large benefits for global populations. The long-run and intergenerational impacts due to GHG emissions are evident in the difference in results across discount rates. In the current modeling, there are substantial long-run benefits (beyond the next two decades to over 100 years) and some near-term benefits as well as negative effects (e.g., agricultural productivity and heating demand). High discount rates give less weight to the future benefits in the net present value calculations, and more weight to near-term effects. Table 5.3-2 also illustrates that an additional unit of emissions is estimated to have a proportionally larger effect on the rest of the world compared to the U.S. if the climate and/or economic system turn out to be more sensitive (i.e., climate sensitivity of 6 degrees Celsius and A2 baseline respectively) to an increasing stock of GHGs in the atmosphere scenarios. Some of these points are discussed more below.

5.3.3 Discussion of Marginal GHG Benefits Estimates

This section briefly discusses important issues relevant to the marginal benefits estimates in Table 5.3-1. Because of the global nature of CO₂ and other greenhouse gases, estimating the marginal benefits required a global modeling framework with consistent integrated socioeconomics, emissions, climate change, and impacts. Given uncertainties in socio-economic futures (e.g., population growth, economic growth, and technology availability and diffusion), corresponding GHG emissions, climate responses to emissions changes, and the bio-physical and

economic impacts associated with changes in climate, the quantified (physical and monetized) estimates of climate change are inherently uncertain.

The broad range of estimates in Table 5.3-1 reflects some of the uncertainty associated with estimating monetized marginal benefits of climate change. The meta analysis range reflects differences in these assumptions as well as differences in the modeling of changes in climate and impacts considered and how they were modeled. EPA considers the meta analysis results to be more robust than the single model estimates in that the meta results reflect uncertainties in both models and assumptions.

The current state-of-the-art for estimating benefits is important to consider when evaluating policies. There are significant partially quantified and omitted impact categories not captured in the estimates provided above. The IPCC Working Group II (IPCC WGII; 2007) concluded that current estimates are “very likely” to be underestimated because they do not include significant impacts that have yet to be monetized.^{JJJJJJJJJJ} Current estimates do not capture many of the main reasons for concern about climate change, including non-market damages (e.g., species existence value and the value of having the option for future uses, such as for biomedical, tourism, or recreational purposes), the effects of climate variability, risks of potential extreme weather (e.g., droughts, heavy rains and wind), socially contingent effects (such as violent conflict or humanitarian crisis), and thresholds (or tipping points) associated with species, ecosystems, and potential long-term catastrophic events. Some scientists believe that effects on factors such as arctic summer ice, Himalayan-Tibetan Glaciers, and the Greenland ice sheet are more sensitive to near-term GHG emissions changes, implying that there are non-linearities in the effects attributable to GHG emissions.^{KKKKKKKKKKKK} Underestimation is even more likely when one considers that the current trajectory for GHG emissions is higher than what is being considered in current integrated assessment modeling (such as that reflected in the modeling represented in Tol, 2008, and Clarke et al., 2006). When combined with current regional population and income trajectories that are more asymmetric than what is currently modeled, this implies greater climate change and vulnerability to climate change.

In Table 5.3-3, we provide a list of the impacts categories currently modeled in the FUND model, and an initial, partial list of categories of impacts that are currently not modeled in the FUND model and are thus not reflected in the FUND estimates. Table 5.3-4 provides an initial list of some more specific types of impacts reported on by the IPCC but are not currently captured in FUND.^{LLLLLLLLLLLL} A key challenge for many impacts sectors is data limitations (primarily physical data). Note that most of the omitted impacts are likely to lead to additional benefits in response to reductions in GHG emissions, including international impacts that could affect domestic benefits (e.g., potential impact feedbacks to the United States, U.S. concern for international impacts, and international participation). EPA is planning to develop a full assessment of what is not currently being captured in FUND for the final rule. In addition, EPA

^{JJJJJJJJJJ} IPCC WGII, 2007. In the IPCC report, “very likely” was defined as a greater than 90% likelihood based on expert judgment.

^{KKKKKKKKKKKK} Ramanathan and Feng, 2008. On avoiding dangerous anthropogenic interference with the climate system: Formidable challenges ahead. *Proceedings of the National Academy of Sciences* 105:143245-14250.

^{LLLLLLLLLLLL} IPCC WGII (2007) Summary for Policy Makers and Chapter 14 North America.

plans to quantify omitted impacts and update impacts currently represented to the extent possible for the final rule.

**Table 5.3-3.
Lists of Impact Categories Modeled and Omitted from Current FUND Modeling
(see Table 5.3-4 for specific types of impacts omitted)**

Impacts currently modeled in FUND	Examples of impacts omitted from current FUND modeling
<ul style="list-style-type: none"> • Agricultural production • Forestry production • Water resources • Energy consumption for space cooling & heating • Sea level rise dry land loss, wetland loss, and coastal protection costs • Forced migration due to dry land loss • Changes in human health (mortality, morbidity) associated with diarrhea incidence, vector-borne diseases, cardiovascular disorders, and respiratory disorders • Hurricane damage • Loss of ecosystems/biodiversity 	<ul style="list-style-type: none"> • Catastrophic events (e.g., Antarctic ice sheet collapse) • Risks from extreme weather (e.g., death, disease and economic damage from droughts, floods, and fires) • Air quality degradation (e.g., increased ozone effects including premature mortality, forest damage) • Increased infrastructure costs (e.g., water management systems, roads, bridges) • Increased insurance costs • Social and political unrest abroad that affects U.S. national security • Damage to foreign economies that affects the U.S. economy • Domestic valuation of international impacts • Costs from uncertainty and changes in risk • Arctic sea ice melt and global transportation & trade

**Table 5.3-4.
Initial List of Specific Types of Impacts Not Current Captured in FUND**

Agriculture	Reduction in growing season (Sahel/southern Africa)
	Increase in growing season in moderate climates
	Impact of precipitation changes on agriculture
	Impact of weather variability on crop production
Biomes/ecosystems	Reverse of carbon uptake, amplification of climate change
	Earlier timing of spring events/ longer growing season
	Poleward and upward shift in habitats/species migration
	Shifts in ranges of ocean life
	Increases in algae and zooplankton
	Range changes/earlier migration of fish in rivers
	Increase in ocean acidification/ impacts on coral reefs
	Ecosystem service disruption (e.g. loss of cold water fish habitat in the U.S.)
Coral bleaching due to ocean warming	
Energy	Energy production/infrastructure
	Water temperature/supply impacts on energy production
Forest	Forest changes with longer fire seasons, longer burning fires, and increased burn area
	Disappearance of alpine habitat in the United States
	Tropical forest dieback in the Amazon
GDP/economy	National security/armed conflict
	Insurance costs with changes in extreme weather, flooding, and sea level rise
	Distributional effects within regions
	Societies that are highly dependent on climate-sensitive resources are highly vulnerable
Health	Extreme weather events
	Increased deaths, injuries, infectious diseases, stress-related disorders with more frequent extreme weather
	Increased heavy rainfall increased risks to human health associated with waterborne disease, increased bacterial counts
	Increases in malnutrition
Snow/ glacier	Health impacts due to interactions with air quality
	Changes in Arctic/Antarctic ecosystems
	Enlargement and increased numbers of glacial lakes/ increased flooding
Tourism	Snow pack in SE US
	Changes in tourism revenues due to changes in ecosystems and weather events (e.g., wildfires, droughts, hurricanes)
Water	Arctic hunting/travel/mountain sports
	River flooding
	Infrastructure, water supply
	Precipitation changes on water supply
	Increasing ground instability and avalanches
	Increased/earlier runoff in snow-fed rivers

The current estimates are also deterministic in that they do not account for the value people have for changes in risk associated with the lower likelihood of potential impacts associated with reductions in CO₂ and other GHG emissions (i.e., a risk premium). This is an issue that has concerned Weitzman and other economists.^{MMMMMMMMMMMMMM} We plan to conduct a formal uncertainty analysis for the final rule to attempt to account for, to the extent possible, these and other changes in uncertainty.

^{MMMMMMMMMMMMMM} See Webster et al., 2003; Weitzman, M., 2007.
<http://econweb.fas.harvard.edu/faculty/weitzman/papers/ValStatLifeClimate.pdf>.

In part because monetized benefit estimates reflect a subset of climate change impacts, it is important in evaluating policies for reducing GHGs to consider the available scientific and other qualitative information on climate change impacts as well. A summary of potential U.S. climate change impacts based on the existing literature is provided in a report by the U.S. Climate Change Science Program, “Scientific Assessment of the Impacts of Climate Change in the United States,” released in May 2008. A similar scientific overview that discusses international as well as domestic impacts is provided in an EPA technical support document that underwent interagency review and was finalized in June 2008.^{NNNNNNNNNNNN} These reports contain information relevant to some of the omitted impacts categories in the tables above (e.g., in the EPA document, section 6f discusses abrupt climate change; section 15(a) discusses national security), as well as on impacts that are monetized in this analysis.

There are two important points to keep in mind in applying the estimates in Table 5.3-1 and this kind of modeling. First, the estimates in Table 5.3-1 are not estimates of economically “optimal” marginal benefits (i.e., they are not associated with an emissions reduction level where marginal benefits equal marginal costs). The estimates in Table 5.3-1 are only relevant for incremental policies relative to the projected baselines (that do not reflect potential future climate policies) and there is substantial uncertainty associated with the estimates themselves both in terms of what is being modeled and what is not being modeled, with many uncertainties outside of observed variability.^{OOOOOOOOOOOO} Furthermore, the estimates only represent the value of a marginal emissions change in a specific year, they do not account for potential affects of current reductions on the value of reductions in the future. These points are important for non-marginal emissions changes and estimating total benefits. For example, current estimates of marginal emissions changes do not model threshold impacts, variability changes, or changes in the likelihood of these impacts.

Second, because current marginal benefits estimates are incomplete and highly uncertain (with many uncertainties outside of observed variability), we cannot use them to identify an *economically optimal (or economically efficient)* standard, even for incremental changes in global GHG emissions, and it creates issues in applying positive net benefit criteria. The uncertainty shifts attention to consideration of changes in risk and points to the importance of considering factors beyond monetized benefits and costs. In an uncertain situation such as that associated with climate, EPA typically recommends that analysis consider a range of benefit and cost estimates, and the potential implications of non-monetized and non-quantified benefits.

^{NNNNNNNNNNNN} “Technical Support Document for the Endangerment Analysis for Greenhouse Gas Emissions Under the Clean Air Act, Sixth Order Draft” Climate Change Division, Office of Atmospheric Programs, U.S. Environmental Protection Agency, Washington, D.D., June 21, 2008

^{OOOOOOOOOOOO} With projected increasing changes in climate, some types of potential climate change impacts may occur suddenly or begin to increase at a much faster rate, rather than increasing gradually or smoothly. In this case, there are likely to be jumps in the functioning of species and ecosystems, the frequency and intensity of extreme conditions (e.g., heavy rains, forest fires), and the occurrence of catastrophic events (e.g., collapse of the West Antarctic Ice Sheet). As a result, different approaches are necessary for quantifying the benefits of “small” (incremental) versus “large” (non-incremental) reductions in global GHGs. Marginal benefits estimates, like those presented above, can be useful for estimating benefits for small changes in emissions. However, for large changes in emissions, a more comprehensive assessment of impacts would be needed to capture changes in economic and biophysical dynamics and feedbacks in response to the policy. Even small reductions in global GHG emissions are expected to reduce climate change risks, including catastrophic risks.

Economic principles suggest that global benefits should also be considered when evaluating alternative GHG reduction policies. GHG emissions are different from most air pollutants, due to their global and intergenerational externality implications. A ton of GHG emitted from any location or source can result in impacts throughout the globe and across multiple generations. Climate change can therefore be characterized as a global and intergenerational public good. Typically, because the benefits and costs of most environmental regulations are predominantly domestic, EPA focuses on benefits that accrue to the U.S. population when quantifying the impacts of domestic regulation. However, OMB’s guidance for economic analysis of federal regulations also specifically allows for consideration of international effects.^{PPPPPPPPPPPP} GHG have global and very long-run implications for climate, a global public good, and economic principles suggest that the full costs to society of emissions should be considered in order to identify the policy that maximizes the net benefits to society, i.e., achieves an efficient outcome (Nordhaus, 2006).^{QQQQQQQQQQQQ} As such, estimates of global benefits more fully capture the value to society than domestic estimates and will result in higher global net benefits for GHG reductions when considered.^{RRRRRRRRRRRR}

Furthermore, international effects of climate change may also affect domestic benefits directly and indirectly to the extent that U.S. citizens value international impacts (e.g., for tourism reasons, concerns for the existence of ecosystems, and/or concern for others); U.S. international interests are affected (e.g., risks to U.S. national security or the U.S. economy from potential disruptions in other nations); and/or domestic mitigation decisions affect the level of mitigation and emissions changes in general in other countries (i.e., the benefits realized in the U.S. will depend on domestic and international emissions changes). The economics literature also suggests that policies based on direct domestic benefits will result in little appreciable reduction in global GHGs (e.g., Nordhaus, 1995).^{SSSSSSSSSSSS} While these marginal benefits estimates are not comprehensive or economically optimal, the global estimates in Table 5.3-1 can help guide policies towards more efficient levels of provision of the public good since they internalize a larger portion of the full costs to society a unit of emissions — the global and intergenerational externalities.

A key challenge facing EPA is the appropriate discount rate over the longer timeframe relevant for GHGs. When considering climate change investments, they should be compared to similar investments (via the discount rate). EPA typically discounts future costs or benefits back

^{PPPPPPPPPPPP} OMB (2003), page 15.

^{QQQQQQQQQQQQ} Nordhaus, W., 2006, "Paul Samuelson and Global Public Goods," in M. Szenberg, L. Ramrattan, and A.

Gottesman (eds), Samuelsonian Economics, Oxford.

^{RRRRRRRRRRRR} Both the United Kingdom and the European Commission followed these economic principles in consideration of the global social cost of carbon (SCC) for valuing the benefits of GHG emission reductions in regulatory impact assessments and cost-benefit analyses (Watkiss et al, 2006). Recently, the National Highway Traffic Safety Administration (NHTSA) issued the final Environmental Impact Statement for their proposed rulemaking for average fuel economy standards for passenger cars and light trucks in which the preferred alternative is based on domestic marginal benefit estimates for carbon dioxide reductions. See Average Fuel Economy Standards, Passenger Cars and Light Trucks, MY 2011-2015, Final Environmental Impact Statement <http://www.nhtsa.dot.gov/portal/site/nhtsa/menuitem.43ac99aefa80569eea57529cdba046a0/>

^{SSSSSSSSSSSS} Nordhaus, William D. (1995). "Locational Competition and the Environment: Should Countries Harmonize Their Environmental Policies?" in *Locational Competition in the World Economy*, Symposium 1994, ed., Horst Siebert, J. C. B. Mohr (Paul Siebeck), Tuebingen, 1995.

to the present using a discount rate, where the discount rate represents how society trades off current consumption for future consumption. With the benefits of GHG emissions reductions distributed over a very long time horizon, benefit and cost comparisons are likely to be very sensitive to the discount rate. For policies with relatively short time horizons, up to 30 years or so (i.e., that affect the current generation of people), the analytic approach used by EPA is to use discount rates of 3% and 7% percent at a minimum.^{TTTTTTTTTTTT} A 3% rate is consistent with what a typical consumer might expect in the way of a risk free market return. A 7% rate is an estimate of the average before-tax rate of return to private capital in the U.S. economy.

However, what discount rates are appropriate for discounting social benefits and costs over the longer timeframe relevant for climate change policies? Changes in GHG emissions — both increases and reductions — are essentially long-run investments in changes in climate and the potential impacts from climate change. Investments in climate change represent longer-term investments in infrastructure and technologies associated with mitigation, where there are annual returns of avoided impacts over a period of one hundred years and longer that affect multiple generations. Furthermore, there is a potential for significant impacts from climate change, where the exact timing and magnitude of these impacts are unknown. These factors imply an uncertain investment environment with uncertain economic growth that varies over time.

When there are important benefits or costs that affect multiple generations of the population, EPA and OMB allow for low but positive consumption discount rates (e.g., 0.5% to 3% noted by the U.S. EPA, 1% to 3% by the OMB).^{UUUUUUUUUUUU} In this multi-generation context, a three percent discount rate is consistent with observed interest rates from long-term investments available to current generations (net of risk premiums) as well as current estimates of the impacts of climate change that reflect potential impacts on consumers. A review of the literature indicates that rates of three percent or lower are more consistent with long-run uncertainty in economic growth and interest rates, considerations of issues associated with the transfer of wealth between generations, and the risk of high impact climate damages (which could reduce or reverse economic growth). Given the uncertain environment, analysis could also consider evaluating uncertainty in the discount rate (e.g., Newell and Pizer, 2001, 2003).^{VVVVVVVVVVVV WWWWWWWWWWWW}

For the final rulemaking, we will be developing and updating the FUND model to the extent possible based on the latest research and peer reviewing the estimates. To improve upon our estimates, we hope to evaluate several factors not currently captured in the proposed

^{TTTTTTTTTTTT} EPA (U.S. Environmental Protection Agency), 2000. Guidelines for Preparing Economic Analyses. EPA 240-R-00-003. See also OMB (U.S. Office of Management and Budget), 2003. Circular A-4. September 17, 2003.

^{UUUUUUUUUUUU} EPA (U.S. Environmental Protection Agency), 2000. Guidelines for Preparing Economic Analyses. EPA 240-R-00-003. See also OMB (U.S. Office of Management and Budget), 2003. Circular A-4. September 17, 2003. These documents are the guidance used when preparing economic analyses for all EPA rulemakings.

^{VVVVVVVVVVVV} Newell, R. and W. Pizer, 2001. Discounting the benefits of climate change mitigation: How much do

uncertain rates increase valuations? Pew Center on Global Climate Change, Washington, DC.

^{WWWWWWWWWWW} Newell, R. and W. Pizer, 2003. Discounting the distant future: how much do uncertain rates increase valuations? Journal of Environmental Economics and Management 46: 52–71.

estimates due to time constraints. For example, we will quantify additional impact categories where possible and provide a qualitative evaluation of the implications of what is not monetized. We also plan to conduct an uncertainty analysis, consider complementary bottom-up analyses, and develop estimates of the marginal benefits associated with non-CO₂ GHGs relevant to the RFS2 proposal (e.g., CH₄, N₂O, and HFC-134a).^{XXXXXXXXXXXX}

EPA solicits comment on the appropriateness of using U.S. and global values in quantifying the benefits of GHG reductions and the appropriate application of benefits estimates given the state of the art and overall uncertainties. We also seek comment on our estimates of the global and U.S. marginal benefits of GHG emissions reductions that EPA has developed, including the scientific and economic foundations, the methods employed in developing the estimates, the discount rates considered, current and proposed future consideration of uncertainty in the estimates, marginal benefits estimates for non-CO₂ GHG emissions reductions, and potential opportunities for improving the estimates. We are also interested in comments on methods for quantifying benefits for non-incremental reductions in global GHG emissions.

5.3.4 Total Monetized GHG Benefits Estimates

As described in Section 2.3, annualized equivalent GHG emissions reductions associated with the proposal in 2022 would be 160 million metric tons of CO₂ equivalent (MMT CO₂eq) in with a 2% discount rate, and 155 and 136 MM CO₂eq with discount rates of 3% and 7% respectively.

This section provides the monetized total GHG benefits estimates associated with the proposal in 2022. As discussed above in subsection three, these estimates do not include significant impacts that have yet to be monetized. Total monetized benefits in 2022 are calculated by multiplying the marginal benefits per metric ton of CO₂ in that year by the annualized equivalent emissions reductions. For the final rulemaking, we plan to separate the emissions reductions by gas and use CO₂ and non-CO₂ marginal benefits estimates. Non-CO₂ GHGs have different climate and atmospheric implications and therefore different marginal climate impacts.

Table 5.3-5 provides the estimated monetized GHG benefits of the proposal for 2022. The large range of values in the tables reflects some of the uncertainty captured in the range of monetized marginal benefits estimates presented in Table 5.3-1.^{YYYYYYYYYYYY} All values in this section are presented in 2006 real dollars.

^{XXXXXXXXXXXX} Due to differences in atmospheric lifetime and radiative forcing, the marginal benefit values of non-CO₂ GHG reductions and their growth rates over time will not be the same as the marginal benefits of CO₂ emissions reductions (IPCC WGII, 2007).

^{YYYYYYYYYYYY} EPA notes, however, that the Ninth Circuit recently rejected an approach of assigning no monetized value to greenhouse gas reductions resulting from vehicular fuel economy. Center for Biodiversity v. NHTSA, F. 3d, (9th Cir. 2007).

**Table 5.3-5.
Monetized GHG Benefits of the Proposed Rule in 2022
(Billions of 2006\$)**

Marginal Benefit		2%	3%	7%
Meta global	Low	-\$0.3	-\$0.3	n/a
	Central	\$16.8	\$9.6	n/a
	High	\$39.4	\$25.5	n/a
FUND global	Low	-\$0.6	-\$0.6	-\$0.3
	Central	\$21.7	\$4.0	-\$0.1
	High	\$172.8	\$31.9	\$1.2
FUND domestic	Low	\$0.0	\$0.0	\$0.0
	Central	\$1.1	\$0.3	\$0.0
	High	\$4.1	\$1.4	\$0.0

5.4 Quantified and Monetized Co-pollutant Health and Environmental Impacts

This section describes EPA’s analysis of the co-pollutant health and environmental impacts that can be expected to occur as a result of this renewable fuels proposal throughout the period from initial implementation through 2030. GHG emissions are predominantly the byproduct of fossil fuel combustion processes that also produce criteria and hazardous air pollutants. The fuels that are subject to the proposed standard are also significant sources of mobile source air pollution such as direct PM, NO_x, VOCs and air toxics. The proposed standard would affect exhaust and evaporative emissions of these pollutants from vehicles and equipment. The proposal would also affect emissions from upstream sources such as fuel production, storage, and distribution and agricultural emissions. Any decrease or increase in ambient ozone, PM_{2.5}, and air toxics associated with the proposal would impact human health in the form of avoided or incurred premature deaths and other serious human health effects, as well as other important public health and welfare effects.

As can be seen in Chapter 3, we estimate that the proposal would lead to both increases and decreases in criteria and air toxic pollutant emissions. Making predictions about human health and welfare impacts based solely on emissions changes, however, is extremely difficult. Full-scale photochemical modeling is necessary to provide the needed spatial and temporal detail to more completely and accurately estimate the changes in ambient levels of these pollutants. EPA typically quantifies and monetizes the PM- and ozone-related health and environmental impacts in its regulatory impact analyses (RIAs) when possible. However, we were unable to do so in time for this proposal. EPA attempts to make emissions and air quality modeling decisions early in the analytical process so that we can complete the photochemical air quality modeling and use that data to inform the health and environmental impacts analysis. Resource and time constraints precluded the Agency from completing this work in time for the proposal. EPA will, however, provide a complete characterization of the health and environmental impacts, both in terms of incidence and valuation, for the final rulemaking.

This section explains what PM- and ozone-related health and environmental impacts EPA will quantify and monetize in the analysis for the final rules. EPA will base its analysis on peer-

reviewed studies of air quality and health and welfare effects and peer-reviewed studies of the monetary values of public health and welfare improvements, and will be consistent with benefits analyses performed for the recent analysis of the proposed Ozone NAAQS and the final PM NAAQS analysis.^{ZZZZZZZZZZ,AAAAAAAAAAAAA} These methods will be described in detail in the RIA prepared for the final rule.

Though EPA is characterizing the changes in emissions associated with toxic pollutants, we will not be able to quantify or monetize the human health effects associated with air toxic pollutants for either the proposal or the final rule analyses. This is primarily because available tools and methods to assess air toxics risk from mobile sources at the national scale are not adequate for extrapolation to benefits assessment. In addition to inherent limitations in the tools for national-scale modeling of air quality and exposure, there is a lack of epidemiology data for air toxics in the general population. For a more comprehensive discussion of these limitations, please refer to the final Mobile Source Air Toxics rule.^{BBBBBBBBBBBBB} Please refer to Chapter 3 for more information about the air toxics emissions impacts associated with the proposed standard.

5.4.1 Human Health and Environmental Impacts

To model the ozone and PM air quality benefits of the final rules, EPA will use the Community Multiscale Air Quality (CMAQ) model (see Chapter 3 of the RIA for a description of the CMAQ model). The modeled ambient air quality data will serve as an input to the Environmental Benefits Mapping and Analysis Program (BenMAP).^{CCCCCCCCCCC} BenMAP is a computer program developed by EPA that integrates a number of the modeling elements used in previous RIAs (e.g., interpolation functions, population projections, health impact functions, valuation functions, analysis and pooling methods) to translate modeled air concentration estimates into health effects incidence estimates and monetized benefits estimates.

Table 5.4.1-1 lists the co-pollutant health effect exposure-response functions (PM_{2.5} and ozone) we will use to quantify the co-pollutant incidence impacts associated with the final standards.

^{ZZZZZZZZZZ} U.S. Environmental Protection Agency. July 2007. Regulatory Impact Analysis of the Proposed Revisions to the National Ambient Air Quality Standards for Ground-Level Ozone. Prepared by: Office of Air and Radiation. EPA-452/R-07-008.

^{AAAAAAAAAAAAA} U.S. Environmental Protection Agency. October 2006. Final Regulatory Impact Analysis (RIA) for the Proposed National Ambient Air Quality Standards for Particulate Matter. Prepared by: Office of Air and Radiation.

^{BBBBBBBBBBBBB} U.S. EPA. 2007. Control of Hazardous Air Pollutants from Mobile Sources – Regulatory Impact Analysis. Assessment and Standards Division. Office of Transportation and Air Quality. EPA420R-07-002. February.

^{CCCCCCCCCCC} Information on BenMAP, including downloads of the software, can be found at <http://www.epa.gov/ttn/ecas/benmodels.html>.

**Table 5.4.1-1.
Health Impact Functions Used in BenMAP to Estimate Impacts of PM_{2.5} and Ozone
Reductions**

Endpoint	Pollutant	Study	Study Population
Premature Mortality			
Premature mortality – daily time series	O ₃	Multi-city Bell et al (2004) – Non-accidental Huang et al (2005) - Cardiopulmonary Schwartz (2005) – Non-accidental Meta-analyses: Bell et al (2005) – All cause Ito et al (2005) – Non-accidental Levy et al (2005) – All cause	All ages
Premature mortality —cohort study, all-cause	PM _{2.5}	Pope et al. (2002) Laden et al. (2006)	>29 years >25 years
Premature mortality, total exposures	PM _{2.5}	Expert Elicitation (IEc, 2006)	>24 years
Premature mortality — all-cause	PM _{2.5}	Woodruff et al. (1997)	Infant (<1 year)
Chronic Illness			
Chronic Bronchitis	PM _{2.5}	Abbey et al. (1995)	>26 years
Nonfatal heart attacks	PM _{2.5}	Peters et al. (2001)	Adults (>18 years)
Hospital Admissions			
Respiratory	O ₃	Pooled estimate: Schwartz (1995) - ICD 460-519 (all resp) Schwartz (1994a; 1994b) - ICD 480-486 (pneumonia) Moolgavkar et al. (1997) - ICD 480-487 (pneumonia) Schwartz (1994b) - ICD 491-492, 494-496 (COPD) Moolgavkar et al. (1997) – ICD 490-496 (COPD)	>64 years
		Burnett et al. (2001)	<2 years
	PM _{2.5}	Pooled estimate: Moolgavkar (2003)—ICD 490-496 (COPD) Ito (2003)—ICD 490-496 (COPD)	>64 years
	PM _{2.5}	Moolgavkar (2000) – ICD 490-496 (COPD)	20-64 years
	PM _{2.5}	Ito (2003) – ICD 480-486 (pneumonia)	>64 years
	PM _{2.5}	Sheppard (2003) – ICD 493 (asthma)	<65 years
Cardiovascular	PM _{2.5}	Pooled estimate: Moolgavkar (2003)—ICD 390-429 (all Cardiovascular) Ito (2003)—ICD 410-414, 427-428 (ischemic heart disease, dysrhythmia, heart failure)	>64 years
	PM _{2.5}	Moolgavkar (2000)—ICD 390-429 (all Cardiovascular)	20-64 years
Asthma-related ER visits	O ₃	Pooled estimate: Jaffe et al (2003) Peel et al (2005)	5–34 years All ages All ages

Endpoint	Pollutant	Study	Study Population
		Wilson et al (2005)	
	PM _{2.5}	Norris et al. (1999)	0-18 years
Other Health Endpoints			
Acute bronchitis	PM _{2.5}	Dockery et al.(1996)	8-12 years
Upper respiratory symptoms	PM _{2.5}	Pope et al. (1991)	Asthmatics, 9-11 years
Lower respiratory symptoms	PM _{2.5}	Schwartz and Neas (2000)	7-14 years
Asthma exacerbations	PM _{2.5}	Pooled estimate: Ostro et al. (2001) (cough, wheeze and shortness of breath) Vedal et al. (1998) (cough)	6-18 years
Work loss days	PM _{2.5}	Ostro (1987)	18-65 years
School absence days	O ₃	Pooled estimate: Gilliland et al. (2001) Chen et al. (2000)	5-17 years
Minor Restricted Activity Days (MRADs)	O ₃	Ostro and Rothschild (1989)	18-65 years
	PM _{2.5}	Ostro and Rothschild (1989)	18-65 years

Endpoint	Pollutant	Study	Study Population
Premature Mortality			
Premature mortality – daily time series	O ₃	Multi-city Bell et al (2004) – Non-accidental Huang et al (2005) - Cardiopulmonary Schwartz (2005) – Non-accidental Meta-analyses: Bell et al (2005) – All cause Ito et al (2005) – Non-accidental Levy et al (2005) – All cause	All ages
Premature mortality —cohort study, all-cause	PM _{2.5}	Pope et al. (2002) Laden et al. (2006)	>29 years >25 years
Premature mortality, total exposures	PM _{2.5}	Expert Elicitation (IEc, 2006)	>24 years
Premature mortality — all-cause	PM _{2.5}	Woodruff et al. (1997)	Infant (<1 year)
Chronic Illness			
Chronic Bronchitis	PM _{2.5}	Abbey et al. (1995)	>26 years
Nonfatal heart attacks	PM _{2.5}	Peters et al. (2001)	Adults (>18 years)
Hospital Admissions			
Respiratory	O ₃	Pooled estimate: Schwartz (1995) - ICD 460-519 (all resp) Schwartz (1994a; 1994b) - ICD 480-486 (pneumonia) Moolgavkar et al. (1997) - ICD 480-487 (pneumonia) Schwartz (1994b) - ICD 491-492, 494-496 (COPD) Moolgavkar et al. (1997) – ICD 490-496 (COPD) Burnett et al. (2001)	>64 years <2 years
	PM _{2.5}	Pooled estimate: Moolgavkar (2003)—ICD 490-496 (COPD) Ito (2003)—ICD 490-496 (COPD)	>64 years

Endpoint	Pollutant	Study	Study Population
	PM _{2.5}	Moolgavkar (2000) – ICD 490-496 (COPD)	20-64 years
	PM _{2.5}	Ito (2003) – ICD 480-486 (pneumonia)	>64 years
	PM _{2.5}	Sheppard (2003) – ICD 493 (asthma)	<65 years
Cardiovascular	PM _{2.5}	Pooled estimate: Moolgavkar (2003)—ICD 390-429 (all Cardiovascular) Ito (2003)—ICD 410-414, 427-428 (ischemic heart disease, dysrhythmia, heart failure)	>64 years
	PM _{2.5}	Moolgavkar (2000)—ICD 390-429 (all Cardiovascular)	20-64 years
Asthma-related ER visits	O ₃	Pooled estimate: Jaffe et al (2003) Peel et al (2005) Wilson et al (2005)	5–34 years All ages All ages
	PM _{2.5}	Norris et al. (1999)	0-18 years
Other Health Endpoints			
Acute bronchitis	PM _{2.5}	Dockery et al.(1996)	8-12 years
Upper respiratory symptoms	PM _{2.5}	Pope et al. (1991)	Asthmatics, 9-11 years
Lower respiratory symptoms	PM _{2.5}	Schwartz and Neas (2000)	7-14 years
Asthma exacerbations	PM _{2.5}	Pooled estimate: Ostro et al. (2001) (cough, wheeze and shortness of breath) Vedal et al. (1998) (cough)	6-18 years ^a
Work loss days	PM _{2.5}	Ostro (1987)	18-65 years
School absence days	O ₃	Pooled estimate: Gilliland et al. (2001) Chen et al. (2000)	5-17 years ^b
Minor Restricted Activity Days (MRADs)	O ₃	Ostro and Rothschild (1989)	18-65 years
	PM _{2.5}	Ostro and Rothschild (1989)	18-65 years

^a The original study populations were 8 to 13 for the Ostro et al. (2001) study and 6 to 13 for the Vedal et al. (1998) study. Based on advice from the Science Advisory Board Health Effects Subcommittee (SAB-HES), we extended the applied population to 6 to 18, reflecting the common biological basis for the effect in children in the broader age group. See: U.S. Science Advisory Board. 2004. Advisory Plans for Health Effects Analysis in the Analytical Plan for EPA's Second Prospective Analysis –Benefits and Costs of the Clean Air Act, 1990—2020. EPA-SAB-COUNCIL-ADV-04-004. See also National Research Council (NRC). 2002. Estimating the Public Health Benefits of Proposed Air Pollution Regulations. Washington, DC: The National Academies Press.

^b Gilliland et al. (2001) studied children aged 9 and 10. Chen et al. (2000) studied children 6 to 11. Based on recent advice from the National Research Council and the EPA SAB-HES, we have calculated reductions in school absences for all school-aged children based on the biological similarity between children aged 5 to 17. **5.4.2**

5.4.2 Monetized Impacts

Table 5.4.2-1 presents the monetary values we will apply to changes in the incidence of health and welfare effects associated with the final standards.

Table 5.4.2-1. Valuation Metrics Used in BenMAP to Estimate Monetary Benefits

Endpoint	Valuation Method	Valuation (2000\$)
Premature mortality	Assumed Mean VSL	\$5,500,000
Chronic Illness		
Chronic Bronchitis	WTP: Average Severity	\$340,482
Myocardial Infarctions, Nonfatal	Medical Costs Over 5 Years. Varies by age and discount rate. Russell (1998)	---
	Medical Costs Over 5 Years. Varies by age and discount rate. Wittels (1990)	---
Hospital Admissions		
Respiratory, Age 65+	COI: Medical Costs + Wage Lost	\$18,353
Respiratory, Ages 0-2	COI: Medical Costs	\$7,741
Chronic Lung Disease (less Asthma)	COI: Medical Costs + Wage Lost	\$12,378
Pneumonia	COI: Medical Costs + Wage Lost	\$14,693
Asthma	COI: Medical Costs + Wage Lost	\$6,634
Cardiovascular	COI: Medical Costs + Wage Lost (20-64)	\$22,778
	COI: Medical Costs + Wage Lost (65-99)	\$21,191
ER Visits, Asthma	COI: Smith et al. (1997)	\$312
	COI: Standford et al. (1999)	\$261
Other Health Endpoints		
Acute Bronchitis	WTP: 6 Day Illness, CV Studies	\$356
Upper Respiratory Symptoms	WTP: 1 Day, CV Studies	\$25
Lower Respiratory Symptoms	WTP: 1 Day, CV Studies	\$16
Asthma Exacerbation	WTP: Bad Asthma Day, Rowe and Chestnut (1986)	\$43
Work Loss Days	Median Daily Wage, County-Specific	---
Minor Restricted Activity Days	WTP: 1 Day, CV Studies	\$51
School Absence Days	Median Daily Wage, Women 25+	\$75
Worker Productivity	Median Daily Wage, Outdoor Workers, County-Specific, Crocker and Horst (1981)	---
Environmental Endpoints		
Recreational Visibility	WTP: 86 Class I Areas	---

Source: Dollar amounts for each valuation method were extracted from BenMAP version 2.4.5.

5.4.3 Other Unquantified Health and Environmental Impacts

In addition to the co-pollutant health and environmental impacts we will quantify for the analysis of the final standards (listed in the preceding sections), there are a number of other health and human welfare endpoints that we will not be able to quantify because of current limitations in the methods or available data. These impacts are associated with emissions of air toxics (including benzene, 1,3-butadiene, formaldehyde, acetaldehyde, acrolein, and ethanol), ambient ozone, and ambient PM_{2.5} exposures. For example, we have not quantified a number of known or suspected health effects linked with ozone and PM for which appropriate health impact functions are not available or which do not provide easily interpretable outcomes (i.e., changes in heart rate variability). Additionally, we are currently unable to quantify a number of known welfare effects, including reduced acid and particulate deposition damage to cultural monuments

and other materials, and environmental benefits due to reductions of impacts of eutrophication in coastal areas. For air toxics, the available tools and methods to assess risk from mobile sources at the national scale are not adequate for extrapolation to benefits assessment. In addition to inherent limitations in the tools for national-scale modeling of air toxics and exposure, there is a lack of epidemiology data for air toxics in the general population. Table 5.4.3-1 lists these unquantified health and environmental impacts.

Table 5.4.3-1. Unquantified and Non-Monetized Potential Effects

Pollutant/Effects	Effects Not Included in Analysis - Changes in:
Ozone Health^a	Chronic respiratory damage Premature aging of the lungs Non-asthma respiratory emergency room visits Exposure to UVb (+/-) ^d
Ozone Welfare	Yields for -commercial forests -some fruits and vegetables -non-commercial crops Damage to urban ornamental plants Impacts on recreational demand from damaged forest aesthetics Ecosystem functions Exposure to UVb (+/-)
PM Health^b	Premature mortality - short term exposures ^c Low birth weight Pulmonary function Chronic respiratory diseases other than chronic bronchitis Non-asthma respiratory emergency room visits Exposure to UVb (+/-)
PM Welfare	Residential and recreational visibility in non-Class I areas Soiling and materials damage Damage to ecosystem functions Exposure to UVb (+/-)
Nitrogen and Sulfate Deposition Welfare	Commercial forests due to acidic sulfate and nitrate deposition Commercial freshwater fishing due to acidic deposition Recreation in terrestrial ecosystems due to acidic deposition Existence values for currently healthy ecosystems Commercial fishing, agriculture, and forests due to nitrogen deposition Recreation in estuarine ecosystems due to nitrogen deposition Ecosystem functions Passive fertilization
CO Health	Behavioral effects
Hydrocarbon (HC)/Toxics Health^e	Cancer (benzene, 1,3-butadiene, formaldehyde, acetaldehyde, ethanol) Anemia (benzene) Disruption of production of blood components (benzene) Reduction in the number of blood platelets (benzene) Excessive bone marrow formation (benzene) Depression of lymphocyte counts (benzene) Reproductive and developmental effects (1,3-butadiene, ethanol) Irritation of eyes and mucus membranes (formaldehyde) Respiratory irritation (formaldehyde) Asthma attacks in asthmatics (formaldehyde) Asthma-like symptoms in non-asthmatics (formaldehyde) Irritation of the eyes, skin, and respiratory tract (acetaldehyde) Upper respiratory tract irritation and congestion (acrolein)
HC/Toxics Welfare^e	Direct toxic effects to animals Bioaccumulation in the food chain Damage to ecosystem function Odor

^a In addition to primary economic endpoints, there are a number of biological responses that have been associated with ozone health effects including increased airway responsiveness to stimuli, inflammation in the lung, acute

inflammation and respiratory cell damage, and increased susceptibility to respiratory infection. The public health impact of these biological responses may be partly represented by our quantified endpoints.

^b In addition to primary economic endpoints, there are a number of biological responses that have been associated with PM health effects including morphological changes and altered host defense mechanisms. The public health impact of these biological responses may be partly represented by our quantified endpoints.

^c While some of the effects of short-term exposures are likely to be captured in the estimates, there may be premature mortality due to short-term exposure to PM not captured in the cohort studies used in this analysis. However, the PM mortality results derived from the expert elicitation do take into account premature mortality effects of short term exposures.

^d May result in benefits or disbenefits.

^e Many of the key hydrocarbons related to this rule are also hazardous air pollutants listed in the Clean Air Act. Please refer to Chapter 3 for more information about the health and welfare effects associated with air toxics.

While there will be impacts associated with air toxic pollutant emission changes that result from the final standards, we will not attempt to monetize those impacts. This is primarily because currently available tools and methods to assess air toxics risk from mobile sources at the national scale are not adequate for extrapolation to incidence estimations or benefits assessment. The best suite of tools and methods currently available for assessment at the national scale are those used in the National-Scale Air Toxics Assessment (NATA). The EPA Science Advisory Board specifically commented in their review of the 1996 NATA that these tools were not yet ready for use in a national-scale benefits analysis, because they did not consider the full distribution of exposure and risk, or address sub-chronic health effects.^{DDDDDDDDDDDDDD} While EPA has since improved the tools, there remain critical limitations for estimating incidence and assessing benefits of reducing mobile source air toxics. EPA continues to work to address these limitations; however, we do not anticipate having methods and tools available for national-scale application in time for the analysis of the final rules. Please refer to the final Mobile Source Air Toxics Rule RIA for more discussion.^{EEEEEEEEEEEEEE}

^{DDDDDDDDDDDDDD} Science Advisory Board. 2001. NATA – Evaluating the National-Scale Air Toxics Assessment for 1996 – an SAB Advisory. <http://www.epa.gov/ttn/atw/sab/sabrev.html>.

^{EEEEEEEEEEEEEE} U.S. EPA. 2007. Control of Hazardous Air Pollutants from Mobile Sources – Regulatory Impact Analysis. Assessment and Standards Division. Office of Transportation and Air Quality. EPA420R-07-002. February.

Chapter 6: Impacts on Water

6.1 Feedstock Production and Water Quality

As the production and price of corn and other biofuel feedstocks increase, there may be substantial impacts to both water quality and water quantity. To analyze the impact, EPA focused on corn production for several reasons. Corn acres have increased dramatically, 20 percent in 2007 from 2006, an increase of over 15 million additional corn acres for a total of 93.6 million acres. Over two-thirds of the new corn acres came from soybean production.⁹⁴⁴ Most of the remaining acres came from the conversion to corn from cotton. Although corn acres declined seven percent to 87.3 million acres in 2008 due to strong prices for other commodities including soybeans, total corn acres remained the second highest since 1946.⁹⁴⁵

There are three major pathways for contaminants to reach water from agricultural lands: runoff from the land's surface, subsurface tile drains, or leaching to ground water. A variety of management factors influence the potential for contaminants such as fertilizers, sediment, and pesticides to reach water from agricultural lands. These factors include nutrient and pesticide application rates and application methods, use of conservation practices and crop rotations by farmers, and acreage and intensity of tile drained lands. Additional factors outside an agricultural producers control include soil characteristics, climate, and proximity to waterbodies.

6.1.1 Corn Production and Water Quality

The rapid growth in corn acres may have major implications for water quality. Unlike soybeans and other legumes, corn needs large amounts of fertilizer, especially nitrogen fertilizers to produce economic yields. Of all current and potential feedstocks for biofuels, corn has the greatest application rates of both fertilizer and pesticides per acre and accounts for the largest share of nitrogen use among all crops.⁹⁴⁶ If fertilizers are applied at rates or times when the corn cannot use them, they are available to runoff or leach to water. Corn generally utilizes only 40 to 60 percent of applied nitrogen. The remaining nitrogen is available to leave the field and runoff to surface waters, leach into ground water, or volatilize to the air where it can return to water through depositional processes. Farmers were expected to apply an additional one million tons of nitrogen fertilizer to the 2007 corn crop.⁹⁴⁷

Historically, corn has been grown in rotation with other crops such as wheat, hay, oats, and especially soybeans. As corn prices increase relative to prices for other crops, farmers chose to grow corn every year (continuous corn). Much of the recent growth in corn acres has come from reductions in a corn-soybean rotation to continuous corn. Although the amount of losses of nitrogen fertilizers to ground and surface water vary, continuous corn loses significantly more nitrogen annually than a corn-soybean rotation.⁹⁴⁸ In 2005, the last year for which data is available, the U.S. average nitrogen fertilization rate for corn was 138 pounds per acre. For soybeans the average rate was 16 pounds per acre.⁹⁴⁹ Soybeans fix nitrogen, so they do not require as much fertilizer for adequate growth.

Continuous corn may have additional impacts on the rates of fertilizer and pesticide use. Continuous corn has lower yields per acre than corn grown in rotation. In response, farmers may add higher rates of nitrogen fertilizer to try to match yields of corn grown in rotation. Alternatively, if farmers maintain fertilization rates with these reduced yields, the amount of unused nutrients will increase and eventually be lost to the environment. Growing continuous corn also increases population densities of pests such as corn rootworm. Farmers may increase use of pesticides to control these pests. Total corn herbicide use may also increase due to the additional corn acres, especially for atrazine, the most commonly used herbicide on corn.

There are potential toxicity concerns with volatilization of pesticide active ingredients,⁹⁵⁰ in addition to concerns with contamination of foods and drinking water. Furthermore, raising acreage under corn production will increase the quantity of pesticide products in use. Further assessment is necessary to determine whether there is the potential for adverse human health effects from any increase in pesticide use associated with increased domestic corn production.

The most commonly used types of pesticides associated with corn production and storage largely belong to two broad use categories, herbicides and insecticides. The majority of the more common corn herbicide products presently on the market contain an organochlorine-type (OC) active ingredient (a.i.). For the most part, OC herbicides inhibit cell division and growth while a subgroup of these products, the atrazine-containing OC herbicides, inhibit plant photosynthesis. Another type of common corn herbicide, the phosphonoglycine or glyphosate-containing organophosphate (OP) herbicides, inhibit protein synthesis in plants. Several of the common corn herbicide compounds, such as acetochlor, carbaryl and alachlor, are classified by EPA as known or likely human carcinogens and oral exposure to some of these a.i. compounds at high enough levels has resulted in adverse health effects, on organs such as the liver or kidney in animals.^{951, 952, 953}

The majority of common corn insecticides are split fairly evenly between OP- and carbamate-type a.i. compounds, with the top selling corn insecticide products, by sales of a.i. by weight, generally contain methomyl. Methomyl is an N-methyl-carbamide compound which inhibits the acetylcholinesterase enzyme, causing neurotoxicity in both insects and humans.⁹⁵⁴ It is classified by EPA as an E/unlikely human carcinogen⁹⁵⁵ and its use is regulated as a compound highly toxic to most aquatic and land animals.

High corn prices may encourage farmers to grow corn on land where row crops are not currently grown. If land is not in row crop production, it generally is an indication that the land is marginal for row crop production though the land may still be used for agriculture, such as pasture land. Typically, agricultural producers apply far less fertilizer and pesticide on pasture land than land in row crops. Corn yield on these marginal lands will be lower, limiting nutrient uptake and causing a higher percentage of nutrients under standard fertilization rates to be underutilized and ultimately lost to the environment. However since nitrogen fertilizer prices are tied to natural gas prices, fertilizer costs have increased significantly. According to U. S. Department of Agriculture (USDA) Economic Research Service, nitrogen fertilizer prices increased 44.5 percent from July 2007 to July 2008.⁹⁵⁶ It is unclear how agricultural producers responded to these increases in both corn and fertilizer prices.

EPA does not have sufficient data to determine the impact of high corn prices on the fertilization rates of traditional corn acres or other agricultural land brought into corn production. Agricultural producers may increase nitrogen fertilizer application rates on all corn acres to increase yields or the higher cost and more efficient of the fertilizer may limit rate increases. The USDA National Agricultural Statistics Service has announced that it will discontinue its national Agriculture Chemical Use reports, collected since 1990, the only survey of its kind. Therefore, it will be very difficult to obtain future information on fertilizer and pesticide application rates.

Tile drains are another important factor in determining the losses of fertilizer from cropland. Tile drainage consists of subsurface tiles, pipes, or drainage ditches that move water from wet soils to surface waters quickly so crops can be planted. Tile drainage has allowed large expanses of historic wetland soils to become productive agriculture lands. However, the tile drains also move fertilizers and pesticides more quickly to surface waters without any of the attenuation that would occur if these contaminants moved through soils or wetlands. The highest proportion of tile drainage occurs in the Upper Mississippi and the Ohio-Tennessee River basins.⁹⁵⁷ Significantly increased use of conservation practices such as improved drainage management and constructed wetlands are necessary to reduce high nitrogen loadings from tile drained lands.

6.1.2 Impact on Farm Bill Conservation Programs

The increase in corn production and prices may also have significant impacts on conservation programs funded by the USDA. USDA funds a variety of voluntary programs to help agricultural producers implement conservation practices on their operations. These programs fall into two basic categories: land retirement and working lands.

USDA's largest land retirement program and its largest conservation program is the Conservation Reserve Program (CRP). Under CRP farmers receive annual rental payments under 10- to 15- year contracts to take land out of agricultural production and plant grasses or trees on those acres. Generally farmers put land into CRP because it is not as productive and has other characteristics that make the cropland more environmentally sensitive, such as high erosion rates. The 2008 Farm Bill (Food, Conservation and Energy Act of 2008) lowered the cap on CRP acres from 39.2 million acres to 32 million acres. Prior to the passage of the new farm bill, farmers had already not renewed their contracts on over two million acres of CRP in response to higher crop prices. USDA expects another 4.6 million acres to come out of CRP between 2007 and 2010, 1.4 million acres in major corn producing states.⁹⁵⁸

CRP acres provide valuable environmental benefits both for water quality and for wildlife habitat. CRP is an important component of rare grassland habitats in the Midwest and Great Plains.⁹⁵⁹ CRP payments are based on the average agricultural land rental rates in the area. As land values increase due to increase in crop prices, CRP payments are not keeping up with the higher land rental rates. Farmland in Iowa increased an average of 18 percent in 2007 from 2006 prices.⁹⁶⁰ Midwestern states, where much of the nation's corn is grown, tend to have reenrollment rates lower than the national average.

The largest USDA conservation program on working lands is the Environmental Quality Incentives Program (EQIP). About \$1 billion is given to farmers annually to implement conservation practices on their farms. Farmers are paid a percentage of the cost of installing the practices, generally ranging from 50 to 90 percent. Conservation practices encompass a wide range that can have a significant impact on pollutants reaching ground or surface water from crop production. EQIP cost-shares with farmers for important practices such as nutrient management, cover crops, livestock manure storage, and riparian buffers. Like CRP, high corn prices may have an impact on the willingness of agricultural producers to participate in EQIP. Producers may require higher payments to offset potential loss of profits through implementation of conservation practices.

The effectiveness of agricultural conservation practices in controlling runoff and/or leaching of nutrients, sediment, and pesticides at the field level has been established by numerous scientific studies across many geographic areas. However, the usefulness of these practices in achieving water quality goals is dependent on their placement within watersheds. To most effectively protect water quality, conservation practices should be targeted to the most vulnerable areas of watersheds. Conservation practices designed to meet wildlife goals will need different targeting mechanisms to ensure adequate habitat. USDA through the Conservation Effects Assessment Project (CEAP) is trying to evaluate the effectiveness of controlling pollution from agricultural lands at the watershed level.^{FFFFFFFFFFF} In order to ensure that Farm Bill conservation programs meet their environmental quality goals, the EPA's Science Advisory Board report to the Gulf of Mexico Task Force (SAB) also recommends implementing the practices through competitive bidding to ensure that the highest environmental benefit is achieved at the least cost.⁹⁶¹ It also warns that voluntary programs without economic incentives are unlikely to be effective to control nitrogen and phosphorus, except for a few practices.

The most cost-effective practices on working lands include: riparian buffers; crop rotation; appropriate rate, timing, and method of nutrient application; cover crops; and, on tile-drained lands, treatment wetlands and controlled drainage. These practices have significant water pollution reduction benefits that vary based on the site-specific conditions and on the implementation and operation and maintenance of the practice. For example, controlled drainage can reduce nitrogen loads by 30 percent; treatment wetlands by 40 percent to 90 percent; vegetative buffers by 12 percent to 90 percent.

6.1.3 Other Agricultural Biofuel Feedstocks

While corn is the most common feedstock for biofuel production by far, under this proposal, in later years other agricultural feedstocks will become increasingly important. These feedstocks will have dramatically different impacts on water quality. Biodiesel feedstocks, primarily soybeans, as well as cellulosic feedstock such as switchgrass or poplar trees are not expected to have significant water quality impacts. As noted previously, soybeans require little to no additional nitrogen fertilizer. However, soybeans have less residue compared to corn, so sediment runoff could be more of a concern, depending on how each crop is managed. Switchgrass may be a more favorable biofuels crop for reducing water impacts. It is a native plant which does not require high inputs of fertilizers or pesticides and since it is a perennial

^{FFFFFFFFFFF} See <http://www.nrcs.usda.gov/technical/nri/ceap/index.html>

crop, there is limited sediment runoff compared to annual crops. There is very minimal acreage of switchgrass grown commercially at the present time, so it is difficult to predict what inputs farmers will use to cultivate it. Some concern has been expressed about farmers increasing switchgrass fertilizer application rates to dramatically increase yields.

Corn stover, at the present time, appears to be one of the most viable feedstock for cellulosic ethanol, especially in the Corn Belt states. Corn stover is the above ground stalks, husks, and corn cobs that remain once the corn grain is harvested. Farmers keep the corn stover on their cropland to maintain the productivity of the soil. Corn stover maintains the soil organic carbon which has many benefits as a source of nutrients, preventing erosion by wind and water, and increasing soil aeration and water infiltration. Wilhelm, et al⁹⁶² looked at the amount of corn stover that could be harvested for biofuel production and still maintain soil carbon. In all the soils they evaluated more stover was needed to maintain the soil carbon than for controlling erosion. For a more general discussion of cellulosic ethanol production, see Chapter V, Section V.B.2. More research is needed to identify the amount of stover that can be removed and retain these important productivity and environmental benefits.

Different conservation systems and conservation practice standards will need to be developed and adopted for cellulosic feedstocks, such as corn stover, switchgrass, and trees for biofuels production. USDA will need to continue to adjust current standards and develop additional standards, where needed, to permit cellulosic feedstocks to be produced and utilized in a sustainable manner.

6.2 Ecological Impacts

6.2.1 Nutrients

Nitrogen and phosphorus enrichment due to human activities is one of the leading problems facing our nation's lakes, reservoirs, and estuaries. Nutrient enrichment is also a contributing factor to stream degradation. It has negative impacts on aquatic life in streams; adverse health effects on humans and domestic animals; aesthetic and recreational use impairment; and excessive nutrient input into downstream waterbodies, such as lakes. Excess nutrients in streams can lead to excessive growth of phytoplankton (free-floating algae) in slow-moving rivers, periphyton (algae attached to a surface) in shallow streams, and macrophytes (aquatic plants large enough to be visible to the naked eye) in all waters. Unsightly filamentous algae can impair the aesthetic enjoyment of streams. In more extreme situations, excessive growth of aquatic plants can slow water flow in flat streams and canals, interfere with swimming, and clog the screens on water intakes of water treatment plants and industries.

Nutrient enrichment in streams has also been demonstrated to affect animal communities in these waterbodies. For example, declines in invertebrate community structure have been correlated directly with increases in phosphorus concentration. High concentrations of nitrogen in the form of ammonia are known to be toxic to aquatic animals. Excessive levels of algae have also been shown to be damaging to invertebrates. Finally, fish and invertebrates will experience growth problems and can even die if either oxygen is depleted or pH increases are severe; both

of these conditions are symptomatic of eutrophication. As a biologic system becomes more enriched by nutrients, different species of algae may spread and species composition can shift; however, unless such species shifts cause clearly demonstrable symptoms of poor water-quality—such as fish kills, toxic algae, or very long streamers of filamentous algae—the general public is unlikely to be aware of this potential ecological concern.

Nutrient pollution is widespread. The most widely known examples of significant nutrient impacts include the Gulf of Mexico and the Chesapeake Bay. For these two areas alone, there are 35 states that contribute the nutrient loadings. There are also known impacts in over 80 estuaries/bays, and thousands of rivers, streams, and lakes. The significance of this impact has led EPA, States, and the public to come together to place an unprecedented priority on public partnerships, collaboration, better science, and improved tools to reduce nutrient pollution.

Virtually every state and territory is impacted by nutrient-related degradation of our waterways. All but one state and two territories have waterbodies that are polluted by nutrients. States have listed over 10,000 waterbodies that have nutrient and nutrient-related impairments. Fifteen states have more than 200 nutrient-related waterbodies each. Reducing nutrient pollution is a priority for EPA.

The Wadeable Streams Assessment provided the first statistically defensible summary of the condition of the nation's streams and small rivers.⁹⁶³ To perform the assessment, EPA, states, and tribes collected chemical, physical, and biological data at 1,392 perennial stream locations to determine the biological condition of these waters and the primary stressors affecting their quality. Research teams collected samples at sites chosen using a statistical design to ensure representative results. The results of the analysis provide a clear assessment of the biological quality of wadeable, perennial streams and rivers across the country.

The Wadeable Streams Assessment found that excess total nitrogen is the most pervasive biological stressor for the nation. Approximately 32 percent of the nation's stream length shows high concentrations of nitrogen compared to reference conditions. Phosphorus exhibits comparable patterns to nitrogen and is the second most-pervasive stressor for the nation's stream length. Streams with relatively high concentrations of nutrients or excess streambed sediments are two to four times more likely to exhibit poor biological conditions.

The *National Water Quality Inventory: Report to Congress*, prepared under section 305(b) of the Clean Water Act, summarizes water quality reports submitted by the states and territories to EPA. Historically, the National Water Quality Inventories have repeatedly shown that nutrients are a major cause of ambient water quality use impairments. In the most recent report summarizing the 2002 reports from state, nutrients are identified as the leading cause of water pollution in assessed lakes and the second leading cause of pollution in assessed estuaries and bays.⁹⁶⁴ Sediment is the leading cause of pollution in assessed rivers and streams. Agriculture is the largest known source of water quality impairment to both assessed rivers and streams and lakes and reservoirs.

6.2.2 Air Deposition of Nitrogen to Water

Nitrogen oxide (NO_x) emissions from fossil fuel combustion can add to the load of nitrogen to waterbodies around the country. Under the high pressure and temperature conditions in a vehicle engine, nitrogen and oxygen in the air react to form NO_x. Depending on climate and other variables, the atmospheric NO_x falls back to the ground as rain, snow, fog, or dry deposition. NO_x is deposited directly on waterbodies or falls on the land and can run off to waterbodies. NO_x from both stationary sources and vehicles results in significant loadings of nitrogen from air deposition to waterbodies around the country⁹⁶⁵, including the Chesapeake Bay⁹⁶⁶, Long Island Sound⁹⁶⁷, and Lake Tahoe⁹⁶⁸. Much of the nitrogen deposition from vehicles falls on impervious surfaces, such as roads and parking lots where it runs off into streams. Road drainage systems generally channel runoff quickly and accelerate the nitrogen loadings downstream. In the Chesapeake region, vehicle exhaust remains the single largest source of fossil-fuel derived nitrogen pollution.⁹⁶⁹ Air deposition of nitrogen accounts for more than half of all nitrogen loadings to Lake Tahoe.⁹⁷⁰

6.3 Gulf of Mexico

Production of corn for ethanol may exacerbate existing serious water quality problems in the Gulf of Mexico. Nitrogen fertilizer applications to corn are already the major source of total nitrogen loadings to the Mississippi River.⁹⁷¹ A large area of low oxygen, or hypoxia, forms in the Gulf of Mexico every year, often called the “dead zone”. Hypoxia threatens commercial and recreational fisheries in the Gulf because fish and other aquatic species cannot live in the low oxygen waters. The primary cause of the hypoxia is excess nutrients (nitrogen and phosphorus) from the Upper Midwest flowing into the Mississippi River to the Gulf. These nutrients trigger excessive algal growth (or eutrophication) resulting in reduced sunlight, loss of aquatic habitat, and a decrease in oxygen dissolved in the water.

The hypoxic zone in 2008 was the second largest since measurements began in 1985 -- 8,000 square miles, an area larger than the state of Massachusetts, and slightly larger than the 2007 measurement.⁹⁷² The average size of the hypoxic zone over the past five years has been 6,600 square miles.

The Mississippi River/Gulf of Mexico Watershed Nutrient Task Force’s “Gulf Hypoxia Action Plan 2008” lays out two major goals for reducing water quality problems in the Mississippi River/Atchafalaya River Basin: 1) reduce the five-year running average areal extent of the Gulf of Mexico hypoxic zone to 2,000 square miles by 2015 and 2) implement nutrient and sediment reductions to protect public health and aquatic life and reduce negative impacts of water pollution. The Gulf of Mexico Action Plan calls for an acceleration of actions to reduce the hypoxia in the Gulf. In order to meet these goals, the Action Plan calls for a 45 percent reduction in both nitrogen and phosphorus reaching the Gulf.⁹⁷³ EPA’s Science Advisory Board (SAB) report to the Task Force said that an additional reduction in nitrogen and phosphorus reduction will be necessary as a result of increased corn production for ethanol and climate change impacts.⁹⁷⁴ The SAB also found that the Gulf of Mexico ecosystem appeared to have undergone a shift so that now the system is more sensitive to nutrient inputs than in the past and inducing a larger response in hypoxia.

Under the Gulf Hypoxia Action Plan, “USDA will encourage the increased use of its nutrient management standard to minimize nutrient loss from fields to help alleviate the impact of increased biofuels production on nutrient loads to the Gulf”.⁹⁷⁵ The nutrient management standard requires farmers to account for all plant-available nutrient sources immediately available or rendered available throughout the crop production cycle.

6.3.1 Nutrient Loads to the Gulf of Mexico

The U.S. Geological Survey (USGS) has estimated that the spring delivery of nutrients to the Gulf of Mexico in 2008 was among the highest since the early 1980s. Spring nutrient delivery is one of the main factors that control the size of the hypoxic zone. In relation to the long-term spring average, total nitrogen was about 35 to 40 percent higher (817,000 tons) and total phosphorus was a record 60 to 85 percent higher (83,000 tons). The large nutrient contributions are primarily due to near record-breaking streamflows in spring 2008 in the Mississippi River Basin. Streamflows were about 50 percent higher this year compared to the long-term spring average flows since about 1980. Nutrient contributions for a given spring vary depending on the amount of flow in the Mississippi-Atchafalaya River Basin, as well as average stream water nutrient concentrations.

Alexander, et al. modeled the sources of nutrient loadings to the Gulf of Mexico using the USGS SPARROW (spatially referenced regression on watershed attributes) model.⁹⁷⁶ They estimated that agricultural sources contribute more than 70 percent of the delivered nitrogen and phosphorus. Corn and soybean production accounted for 52 percent of nitrogen delivery. Atmospheric deposition was the second largest nitrogen source at 16 percent. Animal manure on pasture and rangeland are the main sources of phosphorus loadings, contributing 37 percent. Corn and soybean contributed 25 percent of the phosphorus; other crops 18 percent, and urban areas, 12 percent.

6.3.2 Recent Analyses of Impact of Corn Ethanol Production on Nutrient Loadings to the Gulf

Since over 80 percent of corn grown in the U.S. is produced in the Gulf of Mexico watershed, concern has been expressed about the impact on Gulf hypoxia of increasing corn production for ethanol. Several recent scientific reports have estimated the water quality impact of that increase in corn production.

Donner and Kucharik modeled increases in nitrogen export to the Gulf as a result of corn ethanol volumes increasing from 2007 production levels to 15 billion gallons in 2022.⁹⁷⁷ They concluded that the expansion of corn-based ethanol production could make it almost impossible to meet the Gulf of Mexico nitrogen reduction goals without “radical shift” in feed production, livestock diet, and management of agricultural lands. The study estimated a mean dissolved inorganic nitrogen load increase of 10 to 18 percent from 2007 to 2022 to meet the 15 billion gallon corn ethanol goal, depending on the rate of corn yield increases and potential efficiency increases in the conversion of corn to ethanol.

EPA's Science Advisory Board (SAB) report to the Mississippi River/Gulf of Mexico Watershed Task Force estimated the additional annual nitrogen loadings to the Gulf due to the increase in corn acres from 78.3 million acres in 2006 to 93.7 million acres in 2013.⁹⁷⁸ The SAB estimated that this scenario will result in an additional national annual loading of almost 300 million pounds of nitrogen. An estimated 80 percent of that nitrogen loading or 238 million pounds will occur in the Mississippi-Atchafalaya River basin and contribute nitrogen to the "dead zone" in the Gulf of Mexico.

USGS is using SPARROW to model water quality impacts in the Upper Mississippi River Basin due to increased corn production for ethanol. EPA intends to compare the results of the analysis described in the next section with the SPARROW results for the final rule.

6.4 Upper Mississippi River Basin Analysis

To provide a quantitative estimate of the impact of this proposal and production of corn ethanol generally on water quality, EPA conducted an analysis that focused on agricultural production in the Upper Mississippi River Basin (UMRB). The UMRB drains approximately 189,000 square miles, including large parts of the states of Illinois, Iowa, Minnesota, Missouri, and Wisconsin. Small portions of Indiana, Michigan, and South Dakota are also within the basin. EPA selected the UMRB because it is representative of the many potential issues associated with ethanol production, including its connection to major water quality concerns such as Gulf of Mexico hypoxia, large corn production, and numerous ethanol production plants.

In 2005, there were approximately 23.6 million acres of corn in the UMRB. About 75 percent of ethanol production is expected to be in the states in the Corn Belt region.⁹⁷⁹ More discussion about corn production can be found in Section 1.5.1. On average the UMRB contributes about 39 percent of the total nitrogen loads and 26 percent of the phosphorus loads to the Gulf of Mexico.⁹⁸⁰ The Ohio/Tennessee River Basin is the highest contributor of nitrogen loads to the Gulf at 41 percent. The high percentage of nitrogen from these two basins is primarily due to the large inputs of fertilizer for agriculture and the extensive systems of tile drains. According to USGS, nitrogen loads to the Gulf ranged from 810,000 metric tons to 2.2 million metric tons between 1985 and 2005. Phosphorus loads to the Gulf ranged from 80,700 metric tons to 180,000 metric tons during that same 20- year period.⁹⁸¹ Although nitrogen inputs to the UMRB in recent years is fairly level, there is a 21 percent decline in loads. The Science Advisory Board report attributes this decline to higher amount of nitrogen removed during harvest, due to higher crop yields.⁹⁸² However, most of the reduction in the spring was from nitrogen forms other than nitrate, an important nitrogen form fueling the algal growth which leads to hypoxia.⁹⁸³ For the same period phosphorus inputs increased 12 percent.

In 2005, the U.S. produced approximately 3.9 billion gallons of ethanol, mostly from corn kernels. Corn-based ethanol production is expected to reach at least 15 billion gallons in order for industry to comply with the RFS2 standards. Of the potential crops for biofuels production, corn has the highest rates of fertilizer and pesticide application, leading to the concern that higher corn production will result in increased loading of nutrients, pesticides, and sediment to waterbodies, including major rivers and estuaries. This analysis examines the

impact of total production of corn-based ethanol in 2010, 2015, 2020, and 2022 from an ethanol production baseline of approximately four billion gallons in 2005.

6.4.1 SWAT Model

EPA selected the SWAT (Soil and Water Assessment Tool) model to assess nutrient loads from changes in agricultural production in the UMRB. Models are the primary tool that can be used to predict future impacts based on alternative scenarios. SWAT is a physical process model developed to quantify the impact of land management practices in large, complex watersheds. SWAT, primarily developed by USDA's Agricultural Research Service and the Texas A & M University Blackland Research and Extension Center, is a public domain model.

EPA determined that SWAT was the most appropriate model to use for this analysis because it has been widely used and validated in watersheds both nationally and internationally.⁹⁸⁴ SWAT has been applied extensively to support water quality and Total Maximum Daily Load (TMDL) planning throughout the United States. SWAT is a basin-scale continuous simulation model that operates on a daily time step and is designed to predict the nonpoint source loadings and resulting water quality impacts of water, sediment, and agricultural chemicals (nutrients and pesticides) from a watershed. The model can assess a wide variety of impacts of alternative management practices and land use changes. The model is physically based, computationally efficient, and capable of continuous simulations over long periods of time, ranging from days to years to decades. Major model components include weather, hydrology, erosion/sedimentation, soil temperature, plant growth, nutrients, pesticides, bacteria, agricultural management, stream routing and pond/reservoir routing.

SWAT has several very important strengths that enabled EPA to develop a robust representation of the hydrology and water quality of the UMRB:

- 1) Watersheds can be modeled to evaluate the relative impact of changes in management practices, climate, and vegetation on water quality or other variables of interest;
- 2) SWAT uses readily available inputs commonly available from various government agencies;
- 3) It can simulate crop and plant communities and provide crop yield and plant biomass, essential to estimate past trends and project accurately into the future;
- 4) Simulation of very large basins or a variety of management strategies can be performed expeditiously;
- 5) Long-term impacts spanning several decades can be studied. Time- and climate-variable pollutant contributions can be simulated along with the impact on downstream water bodies spanning several decades; and

6) The model code has been validated on hundreds of basins throughout the United States and abroad.

In addition, prior applications of SWAT for hydrology and nutrient simulation in the UMRB had been completed and were available as a starting foundation for the modeling efforts and focus of this study.^{985 986} Further technical information regarding SWAT can be found at: <http://www.brc.tamus.edu/swat>.

6.4.1.1 Baseline Model Scenario

In order to assess alternative potential future conditions within the UMRB, such as alternative levels of increased corn production, EPA developed a SWAT model of a baseline scenario for current conditions to which the results of future condition model runs can be compared. This analysis evaluated the impact of increased corn production for biofuels by establishing a baseline prior to the rapid increase in corn acres planted in 2007. EPA used a different baseline for this analysis than the reference case based on the AEO projections used in most of the other analyses in this proposal. EPA intends to conduct additional analyses for the final rule that will compare the reference case biofuel volumes to the RFS2 volumes.

For simplicity's sake, we refer to the baseline as 2005, but like most water quality modeling, we had to use a range of data sets for the baseline scenario inputs. As noted above corn acres did not increase significantly until the 2007 crop year. In developing the baseline scenario, it was necessary to select a target year, or window of years, that represent the conditions on the watershed. For this study the year 2005 was selected as the mid-point of the target period for baseline conditions. As with most models of this scale, it was not possible to have all of the data sources come from the exact same time period. It is a common modeling practice to combine the best available data sources for model development in an attempt to characterize the baseline condition within a short time window or period. The majority of the data sources were from the years 2000 through 2006. In addition, selected assumptions about the baseline scenario were made using 2005 as the reference year. In particular, the baseline values for average corn yield (150 bushels per acre) and the percentage of corn producing ethanol (12%, from the RFS1 preamble of May 2007) were based on the year 2005. In reality, the baseline scenario represents watershed conditions within a two to three year period centered on the target year of 2005.

Since one of the driving forces in the SWAT model is the water balance, climate data is key to accurately predicting the movement of nutrients and sediment. SWAT was applied (i.e. calibrated) to the UMRB using weather data from the NRCS climatic data center for a 40-year period from 1960 to 2001 and flow and water quality data from 13 USGS gauges on the mainstem of the Mississippi River, spatially distributed from the upper reaches in Minnesota and Wisconsin to the UMRB outlet below Grafton, Illinois. In addition, the weather data has been spatially interpolated to assign one weather station per subwatershed.

To establish the land use for the baseline scenario, SWAT was setup on 131 subwatersheds [8-digit Hydrologic Unit Code (HUC)] for the entire UMRB using the 2001 National Land Cover Data (NLCD)⁹⁸⁷ and Cropland Data Layer (CDL)⁹⁸⁸. The CDL contains

crop specific digital data layers, suitable for us in geographic information system applications. The CDL program focuses on classifying corn/soybean/rice/cotton agricultural regions in many of the Midwestern and Mississippi delta states using remote-sensing imagery and on-the-ground monitoring. The USDA-NRCS STATSGO provided the soils data for the entire analyses. The primary input data is the USDA 1997 National Resource Inventory (NRI), which provided land use, soil, and data on management practices on the land.⁹⁸⁹ 1997 is the most current year for which this data is available.

In addition, information from the Conservation Tillage Information Center and USDA-NASS Census of Agriculture 2002/1997 were used to identify the cropping rotation and management practices for the agricultural land areas by these same 131 subwatersheds. Based on the management information at this level, each sub-watershed was assigned appropriate management and tillage practices.

Drainage tiles are one of the critical man-made hydrology structures that changes the natural hydrological cycle significantly at both surface and subsurface (lateral flow) levels. There are no clear records of where the tiles are within the UMRB, other than a few research articles that attempted to estimate the location and extent of the tile drainage coverage. In this study, similar literature values were used to estimate and identify the areas that have the tile system to drain the excess water and nutrients in a timely manner. First, the STATSGO database was used to identify the very poorly drained soils, somewhat poorly drained soils, and poorly drained soils. Then, slope and land use maps were overlaid on these poorly drained soils to identify the potential tile drainage system. Only slopes <1% and agricultural land uses were identified as areas that may potentially be served with tile drainage system.

The tillage practice information in the UMRB was obtained at the county level from Conservation Technology Information Center⁹⁹⁰. There are five major tillage types. Three of them (no-tillage, ridge-tillage, and mulch-tillage) belong to conservation tillage, and the other two types of tillage (reduced-tillage and intensive-tillage) are non-conservation tillage. The county acreages of this tillage information were overlaid on 8-digit HUCs to estimate the percent of each tillage practices by crop within each HUC.

To estimate nutrient applications on cropland, we started by estimating the livestock and the amount of manure produced. The livestock numbers came from the agricultural statistics for each county based on the 2002 Census of Agriculture for each 8-digit HUC. (Only cattle and hogs numbers were used since they are the dominant livestock types in the UMRB.) Then, the manure production of each 8-digit HUC was obtained through multiplying the number of cattle and hogs and the manure production rates as outlined in ASABE, 2005.⁹⁹¹ If the total amount of the manure production exceeded 20 percent of the estimated total fertilizer application in one HUC, manure application and chemical fertilizer application was used as SWAT model input to simulate in that HUC. The manure was applied to only those areas that are agricultural land use, even during rotation. For example, only hay, corn, and row crops get manure application, not legume crops such as alfalfa or soybean. So, if an area had a corn and soybean rotation, then only during corn growing period the manure was applied. Even though manure was applied, chemical fertilizer was used to supplement the manure application where and when needed. In areas where the manure was not applied, chemical fertilizer was applied to grow the agricultural

crops. Chemical nitrogen fertilizer at applied at 1.3 times the amount of nitrogen taken off at harvest.

The 42-year SWAT model runs were performed and the results analyzed to establish runoff, sediment, nitrogen, and phosphorous loadings from each of the 131 8-digit HUC subwatersheds and the larger 4-digit subbasins, along with the total outflow from the UMRB and at the various USGS gage sites distributed along the Mississippi River mainstem. These results provided the Baseline Scenario model values to which the future alternatives are compared.

The current national average for corn yield of 150 bushels per acre (bu/ac) was used to establish baseline yield levels. The baseline average yield for the UMRB was established at 131 bushels per acre. This baseline yield is due to the significant amount of crop area in northern states where yield values are lower than the national average.

6.4.1.2 Alternative Scenarios

SWAT scenario analyses were performed for the years 2010, 2015, and 2022 with corn ethanol volumes of 12 billion gallons a year (BGY) for 2010, and 15 BGY for both 2015 and 2022. These volumes were adjusted for the UMRB based on a 42.3 percent ratio of ethanol production capacity within the UMRB compared to national capacity. This fraction was determined by overlaying a coverage of nationwide ethanol plants with a coverage of the UMRB. Production from ethanol plants within the study area were totaled and then divided by the nationwide production. Both current production and planned expansion were included in the totals. Ethanol location and production information were taken from the Renewable Fuels Association table of ethanol refinery locations in April 2008.⁹⁹² The resulting UMRB ethanol production goals were converted into the corresponding required corn production acreage, i.e. the extent of corn acreage needed to meet those ethanol production goals. More discussion about corn production can be found in Section 1.5.1

The SWAT model was run with the available input climate record, 1960-2001, with the model run under conditions of the increased corn production and yields noted above. Separate model runs were performed for each of the three projection years, and the model results were analyzed to provide loadings for comparison with the baseline loadings.

6.4.1.2.1 Corn

Increases in corn yield were built into the future scenarios, with an annual increase of 1.23 percent. This produced yield increases to 139 bushels per acre (bu/ac) (2010), 148 bu/ac (2015) and 162 bu/ac (2022). Thus, after the 2015 scenario, these yield increases translated into less corn acreage being needed to meet the ethanol production goals. Corn acres in the UMRB grew from 23.6 million acres in 2005 to 34.1 million acres in 2010 to 36.3 million acres in 2015, an increase of 54 percent. In 2022, corn dropped to 34.6 million acres.

6.4.1.2.2 Nitrogen

Total nitrogen loads increased by 5.5 percent from the baseline to the 2010 scenario. Scenarios beyond 2010 then showed decreasing total nitrogen loads with the 2022 scenario showing less than a one percent increase over the baseline. It is important to note that these results only estimate loadings from the Upper Mississippi River basin, not the entire Mississippi River watershed. As noted earlier, the UMRB contributes about 39 percent of the total nitrogen loads and 26 percent of total phosphorus loads to the Gulf of Mexico. This modeled decrease in nitrogen loads is likely attributed to the increased yield production of future scenarios, resulting in greater plant uptake of nitrogen. Additionally, less corn area was needed for the 2020 and 2022 scenarios due to the increased yield values.

Approximately 24-25 percent of nitrogen leaving agricultural fields was either taken up by aquatic plants or volatilized before reaching the outlet of the UMRB at Grafton, Illinois. Even though much of the nitrogen that is volatilized from streams and rivers and near-coastal waters is removed from the total loading to water, it is not necessarily eliminated as an environmental concern. Conversion of the nitrate to nitrogen gas through denitrification is generally an incomplete chemical process. Five percent or more of the nitrogen can be converted to nitrous gas, a powerful greenhouse gas that is 300 times the climate-warming potential of carbon dioxide, the major greenhouse gas of environmental concern. Thus, a water pollutant becomes an air pollutant until it is either captured through biological sequestration or converted fully to elemental nitrogen.

6.4.1.2.3 Phosphorus

The scenarios showed an increase in phosphorous loads at a slightly lower percentage than nitrogen

6.4.1.2.4 Sediment

Total sediment outflow showed very little change (less than one percent) over all scenarios. This is primarily due to the corn being modeled as a well-managed crop in terms of sediment loss, primarily due to the corn stover remaining on the fields following harvest.

Table 6.4-1.
Changes in nutrient loadings within the Upper Mississippi River Basin
(from the 2005 Baseline Scenario)

	2005 Baseline	2010	2015	2020	2022
Nitrogen million lbs	1897.0	+ 5.1%	+ 4.2%	+ 2.2%	+1.6%
Phosphorus million lbs	176.6	+ 2.3%	+ 1.1%	+ 0.6%	+ 0.4%

**Table 6.4-2.
Changes to the Mississippi River at Grafton, Illinois from the Upper Mississippi River Basin
(from the 2005 Baseline Scenario)**

	2005 Baseline	2010	2015	2020	2022
Average corn yield (bushels/acre)	141	150	158	168	171
Nitrogen million lbs	1433.5	+ 5.5%	+ 4.7%	+ 2.5%	+ 1.8%
Phosphorus million lbs	132.4	+ 2.8%	+ 1.7%	+ 0.98%	+ 0.8%
Sediment million tons	6.4	+ 0.5%	+ 0.3%	+ 0.2%	+ 0.1%

6.4.2.3 Potential Future Analysis

Due to time and resource constraints, other alternative scenarios have not been analyzed. After evaluating comments on this proposal, if time and resources permit, EPA may conduct additional water quality analyses using the SWAT model in the UMRB. Potential future analyses could include: 1) determination of the most sensitive assumptions in the model, 2) water quality impacts from the changes in ethanol volumes relative to other reference cases, 3) comparisons between the assumptions and results of the Forest and Agricultural Sector Optimization Model (FASOM) used to model the impacts of this proposal on the agriculture sector and SWAT, 4) removing higher percentages of corn stover for cellulosic ethanol, 5) a case study of a smaller watershed to evaluate local water quality impacts that are impossible to ascertain at the scale of the UMRB, and/or 6) changes in loadings of a widely used corn herbicide, atrazine.

6.5 Climate Change Impacts

Although climate change is expected to be an important factor in future crop production in the Upper Mississippi River Basin, EPA has not modeled the impact of climate change on corn yields for a variety of reasons. Climate change requires a long period of observation. Over the short time frame reflected in this proposal, precipitation and temperature increases will be small and indistinguishable from the natural variability of the climate.

Crop yield changes resulting from climate change depend on the atmospheric carbon dioxide level, the crop, and the base temperature. Yield also depends on the characteristics of the crop relative to the timing of precipitation and of extreme temperature events. All of these variables make an estimation of actual climate-induced yield loss very difficult to develop. Farmer adaptation may mitigate the effects of climate change on agriculture to some degree. Adaptations are influenced by many unpredictable factors, including government policy, prices, research and development, and technical assistance. Climate model simulations generally indicate that most locations in the upper Midwest will warm more than the global average and

will receive more precipitation than current – though estimates vary considerably depending on the model used and initial conditions.

6.6 Chesapeake Bay Watershed

The Chesapeake Bay Commission and others have expressed concerns about the water quality impact of increased corn production for ethanol may have on the Chesapeake Bay.^{993,994} The Chesapeake Bay watershed stretches across more than 64,000 square miles, encompassing parts of six states — Delaware, Maryland, New York, Pennsylvania, Virginia and West Virginia — and the entire District of Columbia. The Chesapeake's land-to-water ratio (14:1) is the largest of any coastal water body in the world. This is why land use and land management have such significant influences on the health of the Bay. In its annual State of the Bay report in 2007, the Chesapeake Bay Foundation gave the Bay a score of 28 on a scale where 70 means the Bay is “saved” and 100 is pristine. The Foundation said that “the health of the Chesapeake Bay is dangerously out of balance”.⁹⁹⁵

Agricultural lands account for nearly a quarter of the watershed, and contribute more nutrients to the Bay than any other land use. Agricultural operations produce about 41 percent of the nitrogen and 47 percent of the phosphorus loads going to the Bay. Agriculture also contributes about 63 percent of the Bay's sediment. Municipal and industrial wastewater treatment plants throughout the watershed are responsible for 21 percent of the total nitrogen pollution and 22 percent of the total phosphorus pollution delivered to the Bay.

In 2000, Chesapeake Bay Program partners (states, federal agencies, universities, non-governmental agencies) agreed to reduce nitrogen pollution from an estimated 285 million pounds per year to no more than 175 million pounds by 2010. Similarly they pledged to reduce phosphorus from about 19 million pounds per year to less than 13 million pounds. While there have been steady declines in nitrogen and phosphorus, they have not been adequate to meet the established goals. The watershed must essentially quadruple the pace of the Bay cleanup to meet the 2010 commitment. To restore water quality in the Bay, all of the basin's more than 87,000 farms will need to implement best management practices (BMPs) at levels never before seen in this country. The states have committed to implement close to 30 different agricultural BMPs as part of their restoration strategies.

At least 25 percent and possibly a third of the nitrogen entering the Bay comes from air deposition. The principal sources of emissions are power plants, cars and trucks, agriculture, and off-road sources such as construction equipment, lawn mowers and aircraft. While population increased about eight percent during the last decade, vehicle miles traveled rose 26 percent. More discussion about nitrogen oxides emission impacts can be found in Chapter 3.2.

The Bay watershed receives significant levels of nitrogen oxides and other airborne pollutants from its large airshed (which is about six and a half times the size of the watershed), as far west as Ohio and Indiana. Air deposition of nitrogen on the land adds to the burden that must be dealt with by farmers, local governments and other landowners.

6.6.1 Agricultural Production Effects

Due to the significant acreage within the Chesapeake Bay watershed that is devoted to agricultural production (approximately 22 percent), increases in corn acreage can potentially contribute to changes in nutrient loads to the Bay. High demand for corn reflected in record corn prices have played a substantial role in encouraging producers to alter their typical crop production rotations and crop acreage, contributing to noteworthy changes in crop acreages across the watershed. A technical review committee convened by the Chesapeake Bay Commission estimated that 300,000 new acres of corn could be added in the Bay watershed in the coming years.⁹⁹⁶ This new corn acreage could potentially contribute an additional five million pounds of nitrogen to the Bay. The Bay Program partners are trying to reach a 90 million pound reduction in nitrogen from all sources. However, it is estimated that 17 million pounds of nitrogen could be offset if all agriculture acres used cover crops as a conservation practice after harvest.

Strong market forces also encourage agricultural operators to increase grain production possibly by increasing the conversion of non-row crop acreage (hay, pasture and fallow or idle lands) to row crop production. Grain row crops can add more nutrients per acre to the Bay than hay and pasture due to production intensity, management systems, and nutrient efficiency of the crop.

6.6.1.1 Base Analysis Assumptions

The Chesapeake Bay Program Watershed Model Phase 4.3 (CBWM) and Vortex were utilized in the analysis of potential shifts in nutrient loading to the Bay based on reported changes to agricultural crop production from 2005 to 2008. These agricultural production changes are partially the result of the rapid expansion of biofuel production within the United States, supported by market-driven commodity price increases, government policies, or a combination of both. The CBWM is a dynamic watershed model used to characterize nutrient and sediment loads, and changes in these loads, due to management actions for decision support.^{GGGGGGGGGGGG}

In developing the agricultural production trend analysis within the Chesapeake Bay watershed, the USDA's National Agricultural Statistics Service's (NASS) 2007 and 2008 Projected Plantings report on reported crop acreages was modified to target only the Bay watershed.

6.6.1.2 Corn Production Analysis

Analyzing corn production acreage figures for the period from 2005 to 2008 from the NASS 2007 and 2008 Projected Planting reports, a measurable upward trend was evident for corn acreage plantings across the Bay watershed over the analysis period. This upward trend increased sharply between 2006 and 2007 and decreased for the 2007 and 2008 period. Despite the recent downward trend, total corn acreage increased over the analysis period by almost 66,000 acres.

^{GGGGGGGGGGGG} For more information on the CBWM see <http://www.chesapeakebay.net/model.htm>.

6.6.1.3 Corn Nutrient Load Analysis

Employing a modeled analysis of the USDA-NASS Prospective Plantings report using the Chesapeake Bay Watershed Model Version 4.3 and Vortex, considerable increases of potential nitrogen loads to the Bay are associated with increased corn acreage. The decrease of corn acreage in the 2007 to 2008 period does not offset the total increase in acreage and nitrogen yields between 2005 and 2008. Total nitrogen loads increased by almost 2.4 million pounds.

6.6.1.4 Land Use Conversion Analysis

The agricultural production trends between 2005 and the present not only indicate an overall increase in the number of acres under corn production, but also an increase in the total acres of land under row crop production by over 355,000 acres. Since agricultural land uses within the Chesapeake Bay watershed are continuously decreasing due to urban development, the increase in row crop acreage may come at the expense of other cropping systems, or agricultural land uses such as hay, pasture or idle lands.

6.6.1.5 Land Use Conversion Nitrogen Load Analysis

The USDA-NASS Prospective Plantings reports and the Chesapeake Bay Program Watershed Model indicate a continuous total conversion of non-row crop agricultural lands over the period from 2005 to 2008 to more intensive row crop production. The non-row crop land uses typically produce less nitrogen yields to the Bay, thus additional acres converted to grain production can also increase nitrogen loads significantly. This analysis estimates that nitrogen loads increase by 8.8 million pounds.

If time and resources allow, the Chesapeake Bay Program proposes to analyze the potential impacts within the Chesapeake Bay watershed of the implementation of the RFS2 for the FRM using available systems and models at our disposal. The models that would potentially be used in the analysis would include Phase 5.2 of the Chesapeake Bay Watershed Model (CBWM), the Nutrient and Sediment Scenario Builder (NSSB), the Chesapeake Bay Estuarine Water Quality Sediment Transport Model (CBEWQSTM) and the Chesapeake Bay Land Change Model (CBLCM). The CBWM is a dynamic watershed model used to characterize nutrient and sediment loads, and changes in these loads, due to management actions for decision support. The NSSB is being developed to determine nutrient and sediment loads under multiple land uses and crop types with variable organic and inorganic nutrient inputs. The CBEWQSTM determines the effects of nutrient and sediment load changes to the attainment of water quality standards. The CBLCM simulates changes in land use as a result of locally projected increases in population out to the year 2030.

The scope of the analysis is proposed to include incremental and delivered nitrogen, phosphorus and sediment to the Chesapeake Bay, and the effect of management changes to the attainment of water quality standards.

6.7 Ethanol Production

Under the Clean Water Act, all point sources of pollution, including ethanol plants, must have a permit to discharge to water bodies or to municipal wastewater treatment plants for both industrial process water and stormwater. The permit regulates the amount of pollutants that can be discharged. There are three principle sources of discharges to water from ethanol plants: reject water from water purification, cooling water blowdown, and off-batch ethanol.

6.7.1 Water Discharges

Water is required at ethanol facilities for processing and for the production of steam that is typically used in biomass pretreatment and ethanol distillation processes. An ethanol plant's wastewater is typically comprised of cooling tower blowdown, boiler blowdown, and water softener discharge. The majority of the process water is lost as steam in the distillation process. In addition, stormwater runoff from the facility may be contaminated from precipitation (rain or snow) coming in contact with plant operations (industrial plant yards, material and waste handling, storage areas, shipping and receiving areas, residuals sites) and requires adequate control and management.⁹⁹⁷

While some ethanol facilities get their process water from municipal water supplies, most use on-site wells to produce the process water for the ethanol process. Most groundwater sources are not suitable for process water because of their mineral content. Therefore, the water must be treated for use in ethanol production. The most common method of groundwater treatment is reverse osmosis. Reverse osmosis uses specialized filtration and pressure to produce pure water while concentrating the groundwater minerals into reject water. The minerals in the reject water are site-specific, but they can include: calcium carbonate, magnesium carbonate, sulfate, iron, and sodium. For every two gallons of pure water produced, about a gallon of brine is discharged as reject water. Most estimates of water consumption in ethanol production are based on the use of clean process water and neglect the water discharged as reject water.

The largest source of wastewater discharge is reverse osmosis reject water from process water purification. The reverse osmosis process concentrates groundwater minerals to levels where they can have water quality impacts. The concentrated minerals can show toxicity due to osmotic concentration and the presence of some ions such as sulfate or copper. There is really no means of "treating" these ions to reduce toxicity, other than further concentration and disposal, or use of instream dilution. Some facilities have had to construct long pipelines to get access to dilution so they can meet water quality standards.

Ethanol plants also discharge cooling water blowdown, where some cooling water is discharged to avoid the buildup of minerals in the cooling system. These brines are similar to the reject water described above. In addition, if off-batch ethanol product or process water is discharged, the waste stream can have high Biochemical Oxygen Demand (BOD) levels. BOD directly affects the amount of dissolved oxygen in rivers and streams. The greater the BOD, the more rapidly oxygen is depleted in the stream. This means less oxygen is available to higher forms of aquatic life. The consequences of high BOD are the same as those for low dissolved oxygen: aquatic organisms become stressed, suffocate, and die.

Ethanol production facilities are important transportation hubs. For instance, a facility in Iowa produces about 130 million gallons of ethanol in a year. On an average workday, 175 tractor-trailers bring in corn, ethanol goes out in 12 rail tankers, and 8 rail cars are filled with dried distillers grain to be used as animal feed. This intensity of vehicle travel can have local water impacts from stormwater runoff, spills, etc. similar to any other rail and trucking terminal.

6.7.2 Water Use

Older generation production facilities used 4-6 gallons of process water to produce a gallon of ethanol, but newer facilities use less than 3 gallons of water in the production process. Most of this water savings is gained through improved recycling of water and heat in the process: the conservation of heat energy and water go hand-in-hand. This energy savings is a key economic advantage for newer plants. A gallon of ethanol contains about 70,000 Kcal of energy. Older plants used 35-40,000 Kcal of energy to produce a gallon of ethanol, but newer facilities use only 25-28,000 Kcal per gallon.

The abundance or lack of water supply is a local issue, and there have been concerns with water consumption as new plants go online. Some facilities are tapping into deeper aquifers as a source of water. These deeper water resources tend to contain higher levels of minerals and this can further increase the concentration of minerals in reverse osmosis reject water.

6.7.3 Distillers Grain with Solubles

One important co-product of ethanol production is distillers grain with solubles (DGS). Due to the increase in ethanol production and the price of corn, DGS has become an increasing important feed component for confined livestock. About one-third of the corn processed into ethanol is converted into DGS. Therefore approximately 45 million tons of DGS will be produced for the 15 billion gallons of corn ethanol produced by 2015. Concerns have been raised about the relatively higher phosphorus content of DGS compared to traditional feeds.

Livestock producers may partially replace corn or other feeds with DGS for both economic and production reasons. Different livestock species can tolerate varying amounts of DGS in their diets. The majority of DGS are fed to beef and dairy cows. Current recommendations allow beef and dairy cows diets to include from 15-40 percent DGS. Recommendations for poultry and swine diets are generally less than 15 percent DGS. Although specific analysis of DGS can vary between ethanol plants, compared to corn, DGS are higher in crude protein (nitrogen) and three to four times higher in phosphorus.⁹⁹⁸

The increase in nitrogen and phosphorus from DGS in livestock feed has potential implications for water quality. When nitrogen and phosphorus are fed in excess of the animal's needs, these nutrients are excreted in the manure. Most livestock manure is applied to crops, especially corn, as a source of nutrients. When manure is applied at rates above the nutrient needs of the crop or at times the crop can not use the nutrients, the nitrogen and phosphorus can runoff to surface waters or leach to ground waters. Excess nutrients from manure nutrients have the same impact on water quality as excess nutrients from other sources.

Several recent studies have indicated that DGS may also have an impact on food safety. Cattle fed DGS have a higher prevalence of a major food-borne pathogen, *E. coli* O157, than cattle without DGS in their diets. More research is needed to confirm these studies and devise methods to eliminate the potential risks.⁹⁹⁹

Livestock producers can limit the potential pollution from manure applications to crops through a variety of techniques. USDA's Natural Resources Conservation Service (NRCS) has developed a standard for a comprehensive nutrient management plan (CNMP) to address the issue of proper use of livestock manure.¹⁰⁰⁰ Agricultural producers who use manure should test the nitrogen and phosphorus content before application of the manure. Due to the substantially higher phosphorus content of manure from livestock fed DGS, producers will potentially need significantly more acres to apply the manure so that phosphorus will not be applied at rates above the needs of the crops. This is a particularly important concern in areas where concentrated livestock production already produces more phosphorus in the manure than can be taken up by crops or pasture land in the vicinity.

6.7.4 Water Quality Impact from Ethanol Leaks and Spills

The potential for exposure to fuel components and/or additives can occur when underground fuel storage tanks leak fuel into ground water that is used for drinking water supplies or when spills occur that contaminate surface drinking water supplies. Ethanol biodegrades quickly and is not necessarily the pollutant of greatest concern in these occurrences. Instead, ethanol's high biodegradability can cause the plume of BTEX (benzene, toluene, ethylbenzene and xylenes) compounds in gasoline to extend farther (by as much as 70 percent¹⁰⁰¹) and persist longer in ground water, thereby increasing potential exposures to these compounds. Particularly large plumes of benzene can be expected when: there is a large area of the aquifer that is contaminated with liquid phase gasoline; the background concentration of sulfate-reducing bacteria (which biodegrade ethanol and benzene) in the ground water is low; the rate of ethanol biodegradation is low; and the flow velocity of the ground water is high. More detail on ethanol biodegradation and a summary of laboratory and field studies of ethanol spills will be forthcoming in the EPA's 2005 Report to Congress on Fuel Additive Replacements for MTBE in late 2008.

With the increasing use of ethanol in the fuel supply nationwide, it is important to understand the impact of ethanol on the existing tank infrastructure. Given the corrosivity and different material compatibility requirements of ethanol, there is concern regarding the increased potential for leaks from existing gas stations and subsequent impacts on drinking water supplies. In 2007, there were 7,500 reported releases from underground storage tanks. Since approximately 50 percent of the gasoline used in the U.S. contains ethanol, approximately 3,750 of those releases likely contained some amount of ethanol. Therefore, EPA is undertaking analyses designed to assess the potential impacts of ethanol blends on tank infrastructure and leak detection systems and determine the resulting water quality impacts.

An additional hazard from spills from fuels containing ethanol is risk of potential explosions. Laboratory and field studies have found biodegradation of ethanol can produce concentrations of methane in excess of the water solubility of methane (i.e., more methane was

produced than could be dissolved by the available water). This methane could bubble out of the ground water and enter the soil gas at explosive concentrations, although it is not possible to quantify the risk at this time. EPA is beginning development of modeling software for the assessment of fuels of varying composition on ground water, with simulation of methane production being one component of this work.

6.8 Water Use and Wastewater from Biodiesel Plants

Biodiesel plants use much less water than ethanol plants in production of biofuel. Water is not used in conversion of oil to biodiesel, but is used for washing impurities from the finished product. Water use is variable, but is usually less than one gallon of water for each gallon of biodiesel produced. Larger well-designed plants use water more sparingly, while smaller producers and hobbyists use more water. Some facilities recycle washwater, which reduces water consumption.

The strength of process wastewater from biodiesel plants is highly variable. Most production processes produce washwater that has very high BOD levels. Essentially the strength of the wastewater is based on glycerin and methanol content. Larger facilities are segregating glycerin as a side product and have efficient methanol recovery, while smaller plants are more likely to dispose of glycerin, excess methanol, and washwater as a single waste stream. Crude glycerin is an important side product from the biodiesel process and has many uses. It is about 10 percent of the final product. The rapid development of the biodiesel industry has caused a glut of glycerin production and many facilities dispose of glycerin.

The high strength of these wastes can overload and disrupt the biological processes in municipal treatment plants. The normal wastewater going into a municipal sewage treatment plant has a BOD 200mg/l. Washwater from the biodiesel process with efficient recovery of methanol, containing small amounts of glycerin, can have a BOD of 10,000 – 15,000 mg/L. Pure glycerin has a BOD of nearly 1,000,000 mg/L. There have been several cases of wastewater treatment plant upsets due to these shock loadings from releases of glycerin from biodiesel production facilities. Unfortunately, these have been due to slug loadings to small wastewater treatment plants. Other states such as Illinois and Alabama have also had problems with discharges from small biodiesel plants. In addition, there have been incidences of outright dumping of glycerin. One such event resulted in a large fish kill in Missouri.

Producers that choose to dispose of glycerin can be regulated under several EPA programs, depending on the practice. EPA strongly supports the beneficial use of glycerin as a product.

While the market for refined glycerin is glutted with an excess supply, there are many known uses for glycerin feedstock. As prices for glycerin go down, many of these known products will show a better profit margin and demand for glycerin will increase. Most larger facilities are segregating crude glycerin for refining into usable feedstock for other products. Refining can range from minimal processing up to creation of a food grade product. Nationally, there is a lot of research on the creation of new value added products (ethanol, propylene glycol,

etc.) using glycerin as a feedstock. Most of these projects are in university labs, but a few are up to pilot scale. These new technologies will go online at full scale within the next few years, and are an important part of the profit stream for the industry.

6.9 Potential Impacts to Drinking Water and Public Health

Under the Safe Drinking Water Act (SDWA), EPA establishes enforceable safety standards for drinking water provided by public water systems (PWS). For chemicals, the standard is typically called a maximum contaminant level (MCL). A PWS is “a system for the provision to the public of water for human consumption through pipes or other constructed conveyances, if such system has at least fifteen service connections or regularly serves at least twenty-five individuals.” If the source water for a PWS does not meet the MCL, the PWS must take measures to reduce the contamination to safe levels and that may entail installing expensive drinking water treatment technology e.g., ion exchange (IE), granulated activated carbon (GAC) or reverse osmosis (RO).

EPA anticipates that increased corn production for ethanol will increase the occurrence of nitrate, nitrite, and atrazine in sources of drinking water. New corn acreage may result in increase in the application of fertilizers and herbicides, especially on marginal lands that are not as productive. The ethanol production process may generate new or increased discharges, injection or infiltration of process waste water that could adversely affect the nation’s surface water and ground water used for drinking water.

In addition to potential additional contamination of sources of drinking water, surface and ground water supplies may be strained by increased production of irrigated corn for ethanol and the ethanol production process itself in local and regional areas. Increased pumping from agricultural aquifers to support ethanol production may accelerate the long running depletion of aquifers which has been documented by the USGS. According to U. S. Geological Survey (USGS) data, more than 72 billion gallons a day are already being pumped from the “thirty regional principle aquifers with the greatest amount of ground water use”, with irrigation accounting for slightly more than 75 percent of those withdrawals.¹⁰⁰² The water table of the Ogallala aquifer has declined by over 150 feet in some areas since the 1950s due to increasingly large withdrawals.¹⁰⁰³ Aquifers provide water for domestic and other uses, and contribute to the base flow of many streams and lakes that support aquatic habitats and other ecoservices such as fishing and swimming. Lower stream levels combined with the increased pollutant loadings may concentrate pollutants. Higher pollutant concentrations may require increased drinking water treatment. The accelerated depletion of agricultural aquifers and surface water supplies may be exacerbated by an increase in the incidence of droughts that are predicted under many climate change scenarios.

6.9.1 Nitrogen

The nitrogen fertilizers that are applied to corn and other agricultural crops can end up in drinking water sources where they can impact human health. The two nitrogen compounds of concern are nitrate and nitrite. Nitrate is the most stable form of nitrogen in water.

EPA has established the MCL for nitrate-nitrogen at 10 parts per million (ppm) and for nitrite at 1 ppm. Infants below six months who drink water containing nitrate and/or nitrite in excess of the MCL could become seriously ill and, if untreated, may die.¹⁰⁰⁴ Symptoms include shortness of breath and blue baby syndrome. This health effects language is not intended to catalog all possible health effects for nitrate. Rather, it is intended to inform people of the most significant and probable health effects, associated with nitrate and nitrite in drinking water.

Most nitrogen in water is converted to nitrates. Since nitrates are very soluble and do not bind to soils, they have a high potential to migrate to ground water. Because they do not evaporate, nitrates and nitrites are likely to remain in water until consumed by plants or other organisms. Primary sources of nitrate which may contaminate drinking water are human sewage, livestock manure, and fertilizers.

In 2007, there were 562 public water systems, serving 257, 558 people, reporting violations of the nitrate MCL.¹⁰⁰⁵ If a utility's routine compliance monitoring indicates that nitrate or nitrite concentrations are above the MCL, the water system must implement measures such as treatment or blending to reduce the concentration so that it is below the MCL (e.g., find a new source of water, adjust existing treatment or install new treatment). Also, utilities must monitor the finished water every quarter and provide notification to consumers of the MCL exceedance.

Since there is no nationally consistent sampling of ambient water used by public water systems, the relative contribution of nitrate detections from the various sources is generally unknown.

6.9.2 Atrazine

Atrazine is estimated to be the most widely used herbicide in the United States for control of weeds. Atrazine was the second most frequently detected pesticide in EPA's National Survey of Pesticides in Drinking Water Wells. EPA's Pesticides in Ground Water Database indicates numerous detections of atrazine at concentrations above the MCL in ground water in several states, including Delaware, Illinois, Indiana, Iowa, Kansas, Michigan, Minnesota, Missouri, Nebraska and New York.¹⁰⁰⁶ In 1993, EPA and the atrazine registrants initiated a monitoring program to focus on the most significant exposures associated with agricultural and residential uses -- exposures through drinking water. To this point, levels found in PWS have been low. Through the PWS monitoring program, EPA is ensuring that exposures to atrazine in drinking water do not reach levels that pose a risk to public health.

The MCL for atrazine is three parts per billion (ppb). MCL violations are not triggered by single measurement above the MCL but by the running annual average concentration from four quarterly samples in which at least one measurement during that period exceeds 3 ppb. Some people who drink water containing atrazine well in excess of the MCL over a period of many years could experience problems with their cardiovascular system or reproductive difficulties. This health effects language is not intended to catalog all possible health effects for atrazine. Rather, it is intended to inform people of the most significant and probable health effects, associated with atrazine in drinking water.

Atrazine may be released to the environment in wastewater from herbicide manufacturing facilities and through its use as an herbicide. Microbial activity and other chemicals may breakdown atrazine in soil and water, particularly in alkaline conditions. Sunlight and evaporation do not reduce its presence. It may bind to some soils, but generally tends to leach to ground water. Atrazine is not likely to be taken up in the tissues of plants or animals.¹⁰⁰⁷

In *A Review of Contaminant Occurrence in Public Water Systems*, published in 1999, EPA found atrazine in the finished water of 21 percent of the surface water systems.¹⁰⁰⁸ Atrazine was found at concentrations exceeding the MCL in 10.7 percent of the surface water systems and, in 83 percent of those systems, atrazine was found at concentrations that would have been in violation of the MCL. As noted above, MCL violations are not triggered by single excursions above the MCL but by the running annual average concentration from four quarterly samples in which the measurement of at least one of those samples exceeds three ppb. However in one of the states where atrazine is widely used e.g., for corn production, the percentage of single samples exceeding the MCL was as high as 77.8 percent for surface water systems serving less than 500 people; see Table 6.1.

**Table 6.9-1.
Percentage of Surface Water Systems with Detections of Atrazine
for a High Occurrence State, 1999**

POPULATION	<500	500 – 3,300	3,301 – 10,000	10,001 – 50,000	> 50,000
> MRL ^a	100%	100%	96.2%	96.3%	55.6%
> MCL ^b	77.8%	71.1%	57.7%	18.5%	22.2%

^a The MRL, or minimum reporting level, is the lowest concentration at which the contaminant can be consistently and reliably detected. U.S. Environmental Protection Agency, *A Review of Contaminant Occurrence in Public Water Systems*, EPA 816-R-99-006, 1999, Table V.A.2, page D-2.

^b U.S. Environmental Protection Agency, *ibid*, p. D-3.

In 2003, EPA estimated that single atrazine measurements greater than the MCL would be observed in 26 to 57 public water systems serving a range of 24,400 – 260,300 people.¹⁰⁰⁹

Because atrazine is used mostly as a pre-emergent herbicide on corn, the surface water concentrations typically spike during growing season then taper off for the rest of the year. Even though many surface water systems encounter concentrations above the MCL during the growing season, very few experience MCL violations based on the average concentration over four consecutive quarters. In 2007, only one water system serving 740 people officially reported a MCL violation.¹⁰¹⁰

From 1992 through 2001, the USGS observed atrazine in 90 percent of the samples it took from 83 stream sites in agricultural areas as part of its National Water Quality Assessment (NAWQA). Although it does not target exclusively drinking water intakes or wells, the NAWQA program “provides an understanding of water-quality conditions and how those

conditions may vary locally, regionally, and nationally...”.¹⁰¹¹ Atrazine was observed in 71 percent of the samples from 30 urban stream sites during the same period. For ground water, USGS observed atrazine in 42 percent of the samples it took from wells in agricultural areas and in 31 percent of the samples from urban wells. The detection limits for this study were very low and 95 percent of the sampling results from streams in agricultural areas, where the highest concentrations of atrazine were found, were below 2.4 ppb which is 80 percent of the MCL of 3 ppb.

6.9.3 Future availability of more recent occurrence data

EPA anticipates releasing the chemical occurrence data covering the years 1999 – 2006 from states for publication in 2009 as part of the six year review of drinking water standards. Once those data sets are publicly available, they will be useful in updating the occurrence data published here for nitrate and atrazine.

6.10 Water Quantity Concerns

Biofuel production based on current and projected approaches and processes, future alternative fuel development and production could markedly increase the demand for various fresh water resources. Two potential needs could increase water demand: quantities of water to produce biomass as a feedstock, and the additional water demand for refining of bio-ethanol and biodiesel fuels (by up to a factor of three relative to traditional refining). From a regional perspective, water demand for crop production would be relatively much larger than biorefinery demand; crop production needs would be approximately 200 times the water needed to refine biofuels.¹⁰¹²

With growth of ethanol production, water supply reliability related to crop demand for biomass feedstock will remain an issue. The amount of water needed to grow feedstocks for biofuels can be considerable – for example, the ratio of water consumed to produce the corn itself for ethanol is nearly one thousand gallons per gallon of corn ethanol. Large scale production of perennial energy crops involving tens of millions of acres, even when rain-fed, can have water resource impacts and unintended local consequences due to alterations of hydrologic flows. The timing of the water demand may also be critical; water is often plentiful in one season but scarce in another.

Growing crops for biofuel production is likely to have significant regional and local impacts, including the potential to change irrigation water use, and thus local water availability. The feasibility and sustainability of water diversions for biomass irrigation will vary depending on the region. Moreover, siting of some ethanol plants is already occurring where the water resource is already under duress, for example on the High Plains aquifer.

Biofuel refineries create additional local scale demand for water withdrawals and consumption. It is difficult to generalize about the impact on local water supplies, however, some community supplies have been stressed by the water requirements of ethanol facilities.

However, from a national and regional perspective, relative to the water incorporated in the feedstock, water use in biorefineries is quite small. A typical corn ethanol plant consumes slightly more than four gallons water per gallon of ethanol produced; biodiesel refining even less, about one gallon of water per gallon of biodiesel. (Petroleum refining consumes about 1.5 gallons water per gallon fuel produced.) Biodiesel refining requires much less water per unit of energy produced than bioethanol. Consumptive use is about one gallon water per gallon, but may be up to three gallons per gallons. However, biofuels crops may be irrigated with wastewater that is biologically and chemically unsuitable for use with food crops. On the other hand, cellulosic materials require a different process, and are thought to use 9.5 gallons water per gallon fuel produced -- but this would be expected to decline as efficiency increases (currently projected to be lowered to two to six gallons per gallon).

Geographic impacts of biofuel refining vary. Currently, the Midwest and Southeast have most of the production. In Iowa, water consumption alone from ethanol refining already accounts for about seven percent of all industrial water use, and is projected to be 14 percent by 2012 -- or about 50 million gallons per day. A typical ethanol plant now producing 50 million gallons per year means a minimum of 175 million gallons (nearly 480,000 per day) used in a year. In the Great Lakes-St. Lawrence region, newer facilities under construction will have capacities of 100 million gallons per year.¹⁰¹³ For a 100 million gallon per year corn ethanol plant, water consumption is one million gallons of water/day (equates to daily water consumption of a town of 20,000).

Research is needed to establish water use requirements across the entire biofuel production chain. Information needs related to biomass feedstock production include the assessment and quantification of impacts of increased irrigation of energy crops and resulting biofuel cost/benefit tradeoffs for both starch/sugar/oil biofuel crops, and the lignocellulosic biofuel crops. An assessment is also needed of the impacts on hydrologic flows of regional expansion of perennial energy crop production. These include the impacts and risks tradeoffs, e.g., altered flows due to deep extensive root systems and dense canopies, as well as a need for management practices/metrics, e.g. relatively large absolute water consumption, and additional irrigation necessary. Changing climate adds an additional element of uncertainty in making assessments of water use.

Many uncertainties exist regarding estimating water needs for irrigating cellulosic feedstocks in particular. Reasons include: water data is less available for proposed cellulosic feedstock than for common crops, evapotranspiration rates of marginal lands used for these crops are unknown, and water demand by heretofore unirrigated native grasses is unknown.

There are some mitigating factors on increased demand for water by biofuels. Both the impacts and regulatory opportunities for mitigation of water impacts are likely to be at the state and local levels. For example, rainfall harvesting, efficient irrigation water transport and use of reclaimed water can lead to more efficient agricultural water use for both corn and cellulosic ethanol crops. Also, biorefineries are increasingly incorporating water recycling.

The economics of the energy-water distribution linkage are important in biofuels production. At a macroscale, the high prices of energy driving the increased production of

biofuels will likely affect water availability and use, e.g., conveyance costs related to irrigation waters will also increase with energy costs, possibly leading to water conservation that may counter the expanded water use for crops. Also, the value of crops relative to their water demand matters: water rights can often be bought and sold if the value of the crop is sufficiently high.

Finally, there is the potential for a low water use alternative biomass feedstock to develop: oil-producing macro-algae. These algae can be grown without land, using nontraditional waters, and CO₂ waste streams as a nutrient source. Such fuels can have significantly higher energy density and are potentially more fungible within existing transportation fuel infrastructure than ethanol.

Chapter 7: Initial Regulatory Flexibility Analysis

This chapter discusses our Initial Regulatory Flexibility Analysis (IRFA) which evaluates the potential impacts of the proposed standards on small entities. The Regulatory Flexibility Act, as amended by the Small Business Regulatory Enforcement Fairness Act of 1996 (SBREFA), generally requires an agency to prepare a regulatory flexibility analysis of any rule subject to notice and comment rulemaking requirements under the Administrative Procedure Act or any other statute unless the agency certifies that the rule will not have a significant economic impact on a substantial number of small entities. Pursuant to this requirement, we have prepared an IRFA for the proposed rule. Throughout the process of developing the IRFA, we conducted outreach and held meetings with representatives from the various small entities that could be affected by the rulemaking to gain feedback, including recommendations, on how to reduce the impact of the rule on these entities. The small business recommendations stated here reflect the comments of the small entity representatives (SERs) and members of the Small Business Advocacy Review Panel (SBAR Panel, or ‘the Panel’).

7.1 Overview of the Regulatory Flexibility Act

In accordance with section 609(b) of the Regulatory Flexibility Act, we convened an SBAR Panel before conducting the IRFA. A summary of the Panel’s recommendations is presented in the preamble of this proposed rulemaking. Further, a detailed discussion of the Panel’s advice and recommendations is found in the Final Panel Report contained in the docket for this proposed rulemaking.

Section 609(b) of the Regulatory Flexibility Act further directs the Panel to report on the comments of small entity representatives and make findings on issues related to identified elements of the IRFA under section 603 of the Regulatory Flexibility Act. Key elements of an IRFA are:

- a description of and, where feasible, an estimate of the number of small entities to which the proposed rule will apply;
- projected reporting, record keeping, and other compliance requirements of the proposed rule, including an estimate of the classes of small entities which will be subject to the requirements and the type of professional skills necessary for preparation of the report or record;
- an identification, to the extent practicable, of all other relevant Federal rules which may duplicate, overlap, or conflict with the proposed rule;
- any significant alternatives to the proposed rule which accomplish the stated objectives of applicable statutes and which minimize any significant economic impact of the proposed rule on small entities.

The Regulatory Flexibility Act was amended by SBREFA to ensure that concerns regarding small entities are adequately considered during the development of new regulations that affect those entities. Although we are not required by the Clean Air Act to provide special treatment to small businesses, the Regulatory Flexibility Act requires us to carefully consider the economic impacts that our rules will have on small entities. The recommendations made by the Panel may serve to help lessen these economic impacts on small entities when consistent with Clean Air Act requirements.

7.2 Need for the Rulemaking and Rulemaking Objectives

A detailed discussion on the need for and objectives of this proposed rule are located in the preamble to the proposed rule. As previously stated, section 1501 of the Energy Policy Act of 2005 (EPAct) amended section 211 of the Clean Air Act (CAA) by adding section 211(o) which required the Environmental Protection Agency (EPA) to promulgate regulations implementing a renewable fuel program. The final Renewable Fuels Standard (RFS1) program, which began on September 1, 2007, created a specific annual level for minimum renewable fuel use that increases over time — resulting in a requirement that 7.5 billion gallons of renewable fuel be blended into gasoline (for highway use only) by 2012.

The Energy Independence and Security Act of 2007 (EISA) amended section 211(o), and the RFS program, by requiring higher volumes of renewable fuels, to result in 36 billion gallons of renewable fuel by 2022. EISA also expanded the purview of the RFS1 program by requiring that these renewable fuels be blended into diesel fuel (both highway and nonroad) in addition to gasoline. This expanded the pool of regulated entities, so the obligated parties under this RFS2 NPRM will now include certain refiners, importers, and blenders of these fuels that were not previously covered by the RFS1 program. In addition to the total renewable fuel standard required by EPAct, EISA added standards for three additional types of renewable fuels to the program (advanced biofuel, cellulosic biofuel, and biomass-based diesel) and requires compliance with all four standards.

7.3 Definition and Description of Small Entities

Small entities include small businesses, small organizations, and small governmental jurisdictions. For the purposes of assessing the impacts of the proposed rule on small entities, a small entity is defined as: (1) a small business that meets the definition for business based on the Small Business Administration's (SBA) size standards; (2) a small governmental jurisdiction that is a government of a city, county, town, school district or special district with a population of less than 50,000; and (3) a small organization that is any not-for-profit enterprise which is independently owned and operated and is not dominant in its field.

Small businesses (as well as large businesses) would be regulated by this rulemaking, but not small governmental jurisdictions or small organizations as described above. As set by SBA, the categories of small entities that will potentially be affected by this rulemaking are defined in

Table 7.3-1 provides an overview of the primary SBA small business categories potentially affected by this regulation.

Table 7.3-1. Small Business Definitions

Industry	Defined as small entity by SBA if less than or equal to:	NAICS ^a codes
Gasoline and diesel fuel refiners	1,500 employees ^b	324110

^a North American Industrial Classification System

^b EPA has included in past fuels rulemakings a provision that, in order to qualify for the small refiner flexibilities, a refiner must also produce no greater than 155,000 bpcd crude capacity

EPA used a variety of sources to identify which entities are appropriately considered “small.” EPA used the criteria for small entities developed by the Small Business Administration under the North American Industry Classification System (NAICS) as a guide. Information about the characteristics of refiners comes from sources including the Energy Information Administration (EIA) within the U.S. Department of Energy, oil industry literature, and previous rulemakings that have affected the refining industry. EPA then found employment information for these companies using the business information database Hoover’s Online (a subsidiary of Dun and Bradstreet). These refiners fall under the Petroleum Refineries category, 324110, as defined by NAICS.

7.4 Summary of Small Entities to Which the Rulemaking Will Apply

Small entities that will be subject to the renewable fuel standard include: domestic refiners that produce gasoline and/or diesel, and importers of gasoline and/or diesel into the U.S. Based on 2007 data, EPA believes that there are about 95 refiners of gasoline and diesel fuel. Of these, EPA believes that there are currently 21 refiners producing gasoline and/or diesel fuel that meet the SBA small entity definition of having 1,500 employees or less. Further, we believe that three of these refiners own refineries that do not meet the definition of a “small refinery” that Congress specified under section 211(o). It should be noted that because of the dynamics in the refining industry (i.e., mergers and acquisitions), the actual number of refiners that ultimately qualify for small refiner status under the RFS2 program could be different from this initial estimate.

7.5 Related Federal Rules

The primary federal rules that are related to the proposed RFS2 program are: the Mobile Source Air Toxics rule (*Federal Register Vol. 72, p. 8428, February 26, 2007*), the RFS1 rule (*Federal Register Vol. 72, p. 23900, May 1, 2007*), and the Technical Amendment Direct Final Rulemaking for RFS1 (*Federal Register Vol. 73, p. 71560, November 25, 2008*).

7.6 Projected Reporting, Recordkeeping, and Other Compliance Requirements

For any fuel control program, EPA must have assurance that any fuel produced meets all applicable standards and requirements, and that the fuel continues to meet those standards and requirements as it passes downstream through the distribution system to the ultimate end user. Registration, reporting, and recordkeeping are necessary to track compliance with the RFS2 requirements and transactions involving RINs. As discussed in Sections III.J and IV.E of the preamble to the proposed rule, the proposed compliance requirements under the RFS2 program are in many ways similar to those required under the RFS1 program, with some modifications to account for the new requirements of EISA.

7.7 Regulatory Alternatives

The Panel's findings and discussions are based on the information that was available during the term of the Panel and issues that were raised by the SERs during the outreach meetings and in their written comments. It was agreed that EPA should consider the issues raised by the SERs (and issues raised in the course of the Panel) and that EPA should consider the comments on flexibility alternatives that would help to mitigate any adverse impacts on small businesses. Alternatives discussed throughout the Panel process include those offered in the development of this rule. A summary of the Panel's recommendations, along with those provisions that are being proposed in this action, are detailed below. A full discussion of the regulatory alternatives and hardship provisions discussed and recommended by the Panel, all written comments received from SERs, and summaries of the outreach meetings that were held with the SERs can be found in the SBREFA Final Panel Report, located in the rulemaking docket. All of the flexibilities that were proposed in the rulemaking for small businesses are described in Section IV.B of the preamble to the proposed rule.

In general, SERs stated that they believed that small refiners would face challenges in meeting the new standards. More specifically, they voiced concerns with respect to the RIN program itself, uncertainty (with the required renewable fuel volumes, RIN availability, and cost), and the desire for a RIN system review.

One concern that was raised by EPA with regard to provisions for small refiners in the RFS2 rule is that this rule presents a very different situation than the small refinery versus small refiner concept from RFS1. This situation deals with whether EPA has the authority to provide small refineries that are operated by a small refiner with an extension of time that would be different from (and more than) the temporary exemption specified by Congress in section 211(o)(9) for small refineries. For those small refiners who are covered by the small refinery provisions, Congress has specifically adopted a relief provision aimed at their refineries. This provides a temporary extension through December 31, 2010 and allows for further extensions only if certain criteria are met. EPA believes that providing small refineries (and thus, small refiners who own small refineries) with an additional exemption different from that provided by section 211(o)(9) raises concerns about inconsistency with the intent of Congress. Congress spoke directly to the relief that EPA may provide for small refineries, including those small

refineries operated by small refiners, and limited it to a blanket exemption through December 31, 2010, with additional extensions if the criteria specified by Congress were met. An additional or different extension, relying on a more general provision in section 211(o)(3), would raise questions about consistency with the intent of Congress.

It was agreed that EPA should consider the issues raised by the SERs and discussions had by the Panel itself, and that EPA should consider comments on flexibility alternatives that would help to mitigate negative impacts on small businesses to the extent legally allowable by the Clean Air Act. Alternatives discussed throughout the Panel process included those offered in previous EPA rulemakings, as well as alternatives suggested by SERs and Panel members. A summary of these recommendations is detailed below, and a full discussion of the regulatory alternatives and hardship provisions discussed and recommended by the Panel can be found in the SBREFA Final Panel Report. A complete discussion of the provisions for which we are requesting comment and/or proposing in this action can be found in Section IV.B of this preamble. Also, the Panel Report includes all comments received from SERs (Appendix B of the Report) and summaries of the two outreach meetings that were held with the SERs. In accordance with the RFA/SBREFA requirements, the Panel evaluated the aforementioned materials and SER comments on issues related to the IRFA. The Panel's recommendations from the Final Panel Report are discussed below.

7.7.1 Panel Recommendations

7.7.1.1 Panel Process

The purpose of the Panel process is to solicit information as well as suggested flexibility options from the SERs, and the Panel recommended that EPA continue to do so during the development of the RFS2 rule. Recognizing the concerns about EPA's authority to provide extensions to a subset of small refineries (i.e., those that are owned by small refiners) different from that provided to small refineries in section 211(o)(9), the Panel recommended that EPA continue to evaluate this issue, and that EPA request comment on its authority and the appropriateness of providing extensions beyond those authorized by section 211(o)(9) for small refineries operated by a small refiner. The Panel also recommended that EPA propose to provide the same extension provision of 211(o)(9) to small refiners who do not own small refineries as is provided for small refiners who do own small refineries.

7.7.1.2 Delay in Standards

The RFS1 program regulations provide small refiners who operate small refineries as well as small refiners who do not operate small refineries with a temporary exemption from the standard through December 31, 2010. Small refiner SERs suggested that an additional temporary exemption for the RFS2 program would be beneficial to them in meeting the standards. EPA evaluated a temporary exemption for at least some of the four required RFS2 standards for small refiners. The Panel recommended that EPA propose a delay in the effective date of the standards until 2014 for small entities, to the maximum extent allowed by the statute. However, the Panel recognized that EPA has serious concerns about its authority to provide an extension of the temporary exemption for small refineries that is different from that provided in

CAA section 211(o)(9), since Congress specifically addressed an extension for small refineries in that provision.

The Panel did recommend that EPA propose other avenues through which small refineries and small refiners could receive extensions of the temporary exemption. These avenues, as discussed in greater detail in the preamble to the proposed rule (sections IV.B, and XII.C.6.c.v and vi), are a possible extension of the temporary exemption for an additional two years following a study of small refineries by the Department of Energy (DOE) and provisions for case-by-case economic hardship relief.

7.7.1.3 Phase-in

Small refiner SERs' suggested that a phase-in of the obligations applicable to small refiners would be beneficial for compliance, such that small refiners would comply by gradually meeting the standards on an incremental basis over a period of time, after which point they would comply fully with the RFS2 standards, EPA has serious concerns about its authority to allow for such a phase-in of the standards. CAA section 211(o)(3)(B) states that the renewable fuel obligation shall "consist of a single applicable percentage that applies to all categories of persons specified" as obligated parties. This kind of phase-in approach would result in different applicable percentages being applied to different obligated parties. Further, as discussed above, such a phase-in approach would provide more relief to small refineries operated by small refiners than that provided under the small refinery provision. Thus the Panel recommended that EPA should invite comment on a phase-in, but not propose such a provision.

7.7.1.4 RIN-related Flexibilities

The small refiner SERs requested that the proposed rule contain provisions for small refiners related to the RIN system, such as flexibilities in the RIN rollover cap percentage and allowing all small refiners to use RINs interchangeably. Currently in the RFS1 program, EPA allows for 20 percent of a previous year's RINs to be "rolled over" and used for compliance in the following year. A provision to allow for flexibilities in the rollover cap could include a higher RIN rollover cap for small refiners for some period of time or for at least some of the four standards. Since the concept of a rollover cap was not mandated by section 211(o), EPA believes that there may be an opportunity to provide appropriate flexibility in this area to small refiners under the RFS2 program but only if it is determined in the DOE small refinery study that there is a disproportionate effect warranting relief. The Panel recommended that EPA request comment on increasing the RIN rollover cap percentage for small refiners, and further that EPA should request comment on an appropriate level of that percentage.

The Panel recommended that EPA invite comment on allowing RINs to be used interchangeably for small refiners, but not propose this concept because under this approach small refiners would arguably be subject to a different applicable percentage than other obligated parties (similar to the phase-in approach discussed above). This concept would also fail to require the four different standards mandated by Congress (e.g., conventional biofuel could not be used instead of cellulosic biofuel or biomass-based diesel).

7.7.1.5 Program Review

With regard to the suggested program review, EPA raised the concern that this could lead to some redundancy since EPA is required to publish a notice of the applicable RFS standards in the Federal Register annually, and that this annual process will inevitably include an evaluation of the projected availability of renewable fuels. Nevertheless, the SBA and OMB Panel members stated that they believe that a program review could be helpful to small entities in providing them some insight to the RFS program's progress and alleviate some uncertainty regarding the RIN system. As EPA will be publishing a Federal Register notice annually, the Panel recommended that EPA include an update of RIN system progress (e.g., RIN trading, RIN availability, etc.) in this notice and that the results of this evaluation be considered in any request for case-by-case hardship relief.

7.7.1.6 Extensions of the Temporary Exemption Based on a Study of Small Refinery Impacts

The Panel recommended that EPA propose in the RFS2 program the provision at 40 CFR 80.1141(e) extending the RFS1 temporary exemption for at least two years for any small refinery that DOE determines would be subject to disproportionate economic hardship if required to comply with the RFS2 requirements.

Section 211(o)(9)(A)(ii) requires DOE to perform a study of the economic impacts of the RFS requirements on small refineries. The study, which is required to be completed by December 31, 2008, must assess and determine whether the RFS requirements would impose a disproportionate economic hardship on small refineries. Small refineries that are found to be in a disproportionate economic hardship situation will receive an extension of the temporary exemption for at least two years.

The Panel also recommended that EPA work with DOE in the development of the small refinery study, specifically to communicate the comments that SERs raised during the Panel process.

7.7.1.7 Extensions of the Temporary Exemption Based on Disproportionate Economic Hardship

While SERs did not specifically comment on the concept of hardship provisions for the upcoming proposal, the Panel noted that under CAA section 211(o)(9)(B) small refineries may petition EPA for case-by-case extensions of the small refinery temporary exemption on the basis of disproportionate economic hardship. Refiners may petition EPA for this case-by-case hardship relief at any time.

The Panel recommended that EPA propose in the RFS2 program a case-by-case hardship provision for small refineries similar to that provided at 40 CFR 80.1141(e)(1). The Panel also recommended that EPA propose a case-by-case hardship provision for small refiners that do not operate small refineries that is comparable to that provided for small refineries under section 211(o)(9)(B), using its discretion under CAA section 211(o)(3)(B). This would apply if EPA

does not adopt an automatic extension for small refiners, and would allow those small refiners that do not operate small refineries to apply for the same kind of extension as a small refinery. The Panel recommended that EPA take into consideration the results of the annual update of RIN system progress and the DOE small refinery study in assessing such hardship applications.

7.7.2 Provisions Proposed in the NPRM

This section describes the provisions being proposed in the preamble to the proposed rule related to small refiners.

7.7.2.1 Delay in Standards

As discussed in Section IV.B of the preamble to this proposed rule, the RFS1 program regulations provide small refiners who operate small refineries (and any refiner who operates a small refinery), as well as those small refiners who do not operate small refineries, with a temporary exemption from the standards through December 31, 2010. EPA has evaluated an additional temporary exemption for small refiners for the required RFS2 standards, and this exemption has also been evaluated with respect to EPA's concerns about the authority to provide an extension of the temporary exemption for small refineries that is different from that provided in CAA section 211(o)(9). EPA believes that the limitations of the statute do not necessarily allow the Agency the discretion to provide an exemption for small refiners only (i.e., small refiners but not small refineries) beyond that provided in section 211(o)(9). Thus, EPA is proposing to continue the RFS1 temporary exemption through December 31, 2010 for small refineries and all qualified small refiners; further, EPA is proposing provisions that address extensions of the small refinery/small refiner temporary exemption, as section 211(o)(9) does allow for extensions beyond December 31, 2010. We are also requesting comment on the interpretation of our authority under the CAA and the appropriateness of providing an extension to small refiners only beyond that authorized by section 211(o)(9).

7.7.2.2 Phase-in

As discussed above in Section 7.7.1.3, EPA also has concerns that section 211(o) does not give the Agency the discretion to allow for a phase-in approach to the standards as it would result in different applicable percentages being applied to different obligated parties, provide more relief to small refineries operated by small refiners than that provided under the small refinery provision. However, we are inviting comment on the concept of a phase-in provision for all small refiners.

7.7.2.3 RIN-related Flexibilities

With regard to the small refiner SERs' request that the proposed rule contain provisions for small refiners related to the RIN system, we do not believe it would be appropriate to propose a change to the RIN rollover cap for small refiners in this action, given the findings from the DOE small refinery study ("EPACT 2005 Section 1501 Small Refineries Exemption Study"). However, we are requesting comment on the concept of increasing the RIN rollover cap percentage for small refiners. We are also requesting comment on an appropriate level of that

percentage. Further, as recommended by the Panel, we are not proposing to allow RINs to be used interchangeably for small refiners; however we are inviting comment on such an approach.

7.7.2.4 Program Review

As noted above, we have slight concerns that such a review could lead to some redundancy since EPA is required to publish a notice of the applicable RFS standards in the Federal Register annually, and this annual process will inevitably include an evaluation of the projected availability of renewable fuels. Nevertheless, we agree with the Panel's recommendation on including an update of RIN system progress (e.g., RIN trading, publicly-available information on RIN availability, etc.) in the annual Federal Register notice. Thus, we are proposing to include elements of RIN system progress—such as RIN trading and availability—in the annual Federal Register RFS2 standards notice, and we are requesting comment on additional elements to include in this notice.

7.7.2.5 Extensions of the Temporary Exemption Based on a Study of Small Refinery Impacts

As previously noted, there are two provisions in section 211(o)(9) that allow for an extension of the temporary exemption beyond December 31, 2010. One involves the study by DOE, as mentioned above, concerning whether compliance with the renewable fuel requirements would impose disproportionate economic hardship on small refineries, and would grant an extension of at least two years for a small refinery that DOE determines would be subject to such disproportionate hardship. Another provision authorizes EPA to grant an extension for a small refinery based upon disproportionate economic hardship, on a case-by-case basis.

We believe that these avenues of relief should be utilized by those small refiners who are covered by the small refinery provision; and we believe that it is appropriate to consider allowing petitions to EPA for an extension of the temporary exemption based on disproportionate economic hardship for those small refiners who are not covered by the small refinery provision (again, per our discretion under section 211(o)(3)(B)); to ensure that all small refiners have the same relief available to them as small refineries do.

Thus, we are proposing hardship provisions for small refineries in the RFS2 program similar to those provided at 40 CFR 80.1141(e). First, we are proposing to extend the temporary exemption for at least two years for any small refinery that DOE's small refinery study determines would face disproportionate economic hardship in meeting the requirements of the RFS2 program (per CAA section 211(o)(9)(A)(ii)(I)). Second, we are proposing that any small refinery may apply for a case-by-case hardship at any time on the basis of disproportionate economic hardship per section 211(o)(9)(B).

As discussed in section IV.B.2.c of the preamble to the proposed rule, the findings from DOE's small refinery study indicate that no small refineries are subject to disproportionate economic hardship under the proposed RFS2 program and that the small refinery exemption should not be extended beyond December 31, 2010. However, DOE noted in the study that if circumstances were to change and/or the RIN market became non-competitive or illiquid,

individual small refineries have the ability to petition EPA for an extension of their small refinery exemption.

For those small refiners that do not operate small refineries, we are also proposing a case-by-case hardship provision using our discretion under CAA section 211(o)(3)(B). Such a provision would allow those small refiners that do not operate small refineries to apply for the same kind of case-by-case extension as a small refinery.

7.8 Conclusions

Based on our outreach, fact-finding, and analysis of the potential impacts of our regulations on small businesses, the Panel concluded that the proposed provisions for small refiners would be beneficial in minimizing the effects of the proposed rule on small refiners.

Of the 15 small entities with publicly available sales data, we were able to estimate annual costs, and thus use this information to complete a preliminary screening analysis. To perform this analysis, we used a cost-to-sales ratio test (a ratio of the estimated annualized compliance costs to the value of sales per company). Costs were analyzed using both a “Reference Case” crude oil cost of \$53 per barrel and a “High Case” crude oil cost of \$92 per barrel.

For the 14 small refiners with available data, we found that: 21 percent (3 refiners) of small refiners were affected at less than 1 percent of their sales (i.e., the estimated costs of compliance with the proposed rule would be less than 1 percent, of their sales) and 79 percent (11 refiners) were affected at greater than 3 percent of their sales using the Reference Case costs. Using the High Case costs, all small refiners were affected at less than 1 percent of their sales. Please note that these costs do not include the available subsidies for the blending of ethanol of 45 cents per gallon for ethanol and \$1.00 per gallon for biodiesel/renewable diesel. Thus, the actual compliance costs will be considerably lower.

For a complete discussion of the economic impacts of the proposed rulemaking, see Chapter 5, the economic impact analysis chapter, of this Draft Regulatory Impact Analysis.

Appendix A: Biodiesel Effects on Heavy-Duty Highway Engines and Vehicles

A.1 Executive Summary

Due to the continuing interest in the use of biodiesel fuels, the Environmental Protection Agency has conducted a comprehensive analysis of the emission impacts of biodiesel using publicly-available heavy-duty, in-use diesel chassis and engine exhaust emissions data.

We investigated the emission impacts on NO_x, PM, HC, and CO of 20 volume percent biodiesel fuels produced from various animal- and plant-based feedstock materials tested under several cycles in this analysis. Average NO_x emissions were found to increase 2.2%, while PM, HC, and CO were found to decrease 15.6%, 14.1%, and 13.8% respectively, for all test cycles run on 20 vol% soybean-based biodiesel fuel at a significance level of $P < 0.05$ (See Table A.1-1).

Table A.1-1.
Emission impacts for all cycles tested on 20 vol% soybean-based biodiesel fuel relative to an average base fuel

Emissions	Percent Change in Emissions
NO _x	+2.2%
PM	-15.6%
HC	-14.1%
CO	-13.8%

These results are consistent with the exhaust emission impacts for heavy-duty, in-use diesel engines found in our 2002 Draft Technical Report, entitled "*A Comprehensive Analysis of Biodiesel Impacts on Exhaust Emissions.*" This report can be found in the docket to this rulemaking, EPA-HQ-OAR-2005-0161.

The current analysis also found that heavy-duty engine dynamometer data was statistically indistinguishable from heavy-duty chassis dynamometer data for NO_x and HC at a significance level of $p < 0.05$. Likewise, results for Detroit Diesel Corporation (DDC) engines, used in many test programs, were found to be statistically similar to results for other engines for NO_x, CO, and HC at a significance level of $p < 0.05$.

The results of the current analysis also point to a load-dependence of NO_x emissions for heavy-duty highway engines and chassis. The difference in NO_x emissions between our results here and those of various other researchers appears to be attributable to an artifact of the selected test cycle profile. Analyzing the NO_x emissions data as a function of load, as we do here -- as opposed to a particular test cycle profile -- reconciles the difference and supports the NO_x emission-load-dependence hypothesis for heavy-duty highway engines and chassis posited by Sze *et al.* and corroborated by Eckerle *et al.*

A.2 Biodiesel Effects on Heavy-Duty Highway Engines and Vehicles

A.2.1 Introduction

We investigated the emission impacts on NO_x, PM, CO, and HC of 20 volume percent (vol%) biodiesel fuels produced from various feedstock materials tested under several vehicle and engine test cycles. The data used in this analysis is comprised of data used in EPA's 2002 Draft Technical Report, entitled "*A Comprehensive Analysis of Biodiesel Impacts on Exhaust Emissions Draft Technical Report*", hereafter referred to as the 2002 Draft Technical Report. Data from that report was supplemented with pertinent data sources published in the scientific and automotive literature between 2002 and 2007. The supplemental data was comprised of late model year engines, vehicles, and technology groups. A list of all data sources used in this analysis appears in the appendix.

The focus of the analysis proceeded from general to specific terms, through seven fuel-cycle combinations, summarized below. In Case 1, the most-general fuel-cycle combination, we examined all heavy-duty engine and chassis cycles run on plant- and animal-based biodiesel fuels; in Case 5a, 5b, and 5c, the most-specific fuel-cycle combinations, we examined heavy-duty engine and chassis data for light-, medium-, and heavy-duty cycles using soybean-based biodiesel. The latter analysis was designed to examine load-dependence of NO_x emissions for heavy-duty highway engines and chassis first posited by EPA in 2007 (see Sze *et al.*). This research was further elucidated by Eckerle *et al.* While feedstock materials varied for the seven fuel-cycle combinations presented here, all analyses were conducted using 20 vol% biodiesel fuels.

A summary of fuel-cycle combinations used in the analysis appears below.

- Case 1: All cycles tested on plant-based (soybean, rapeseed/canola, and coconut) and animal-based (tallow, lard, and grease) biodiesel fuels,
- Case 2: All cycles tested on soybean-based biodiesel fuel,
- Case 3: FTP and UDDS cycles tested on soybean-based biodiesel fuel,
- Case 4: Detroit Diesel Corporation (DDC) and non-DDC engines tested on soybean-based biodiesel fuel,
- Case 5a: Engines and chassis tested on soybean-based biodiesel fuel run on light-duty cycles,
- Case 5b: Engines and chassis tested on soybean-based biodiesel fuel run on medium-duty cycles, and
- Case 5c: Engines and chassis tested on soybean-based biodiesel fuel run on heavy-duty cycles.

The results of the analysis of the seven fuel-cycle combinations appear in Section A.2.3.2. The results of the analysis of the NO_x emissions load-dependence appear in Section A.2.3.3 and a discussion of the observed load-dependence impacts in the context of relevant literature and the 2002 Draft Technical Report appear in Section A.2.3.4.

In the 2002 Draft Technical Report, we focused our analysis on data from heavy-duty highway engines, since this data was the most abundant in our database and since it was unclear to what extent testing on a chassis dynamometer might differ from testing on an engine dynamometer. However, some researchers criticized the conclusions of the report for its disproportionate reliance on engine data. These researchers argued that these engines may not behave in a manner indicative of the actual, in-use fleet or that chassis-generated data may be better-suited for NO_x emissions testing.

Some researchers also criticized the conclusions of our 2002 Draft Technical Report, citing its disproportionate reliance on DDC engine data. These researchers argued that these engines may not behave in a manner indicative of the actual, in-use fleet as a whole. To help address these concerns, we supplemented the database for the 2002 Draft Technical Report with non-DDC engine data. In the current analysis, non-DDC engines represent 59.0% of all engines present in the supplemented database.

To investigate these concerns, we carried out an analysis to determine the compatibility of heavy-duty highway engine data with heavy-duty highway chassis data. Establishing compatibility between heavy-duty highway engine data and heavy-duty highway chassis data would allow us to make more-complete use of all emissions data in the database. In turn, this would allow us to perform more robust statistical analyses. The results of this engine and chassis data compatibility analysis are presented in Section A.2.3.1. Section A.2.2 contains a discussion of the data screening criteria and methodology used in this analysis.

A.2.2 Data screening and methodology

The data used in this analysis is comprised of data initially used in our 2002 Draft Technical Report, supplemented by pertinent data published between 2002 and 2007. The supplemental data included late model year engines, vehicles, and technology groups. A list of data sources used in this analysis appears in the appendix to this document.

A criticism raised by the 2002 Draft Technical report was that its analysis relied too heavily upon data from early model year engines and that these engines may not behave in a manner indicative of the actual, in-use fleet as a whole. To help address this concern, we supplemented the existing database of over 800 observations with approximately 560 additional observations comprised of late model year engines, vehicle, and technology groups.

Candidate data were first screened to verify that they met EPA data QC/QA requirements as well as criteria consistent with the goals of the analysis before inclusion into the database (See Section II of the 2002 Draft Technical Report for a discussion of EPA data QC/QA considerations). New data meeting these criteria were entered into the database developed for the 2002 Draft Technical Report. These criteria are described in Section A.2.2.1.

A.2.2.1 Criteria for selecting data

Candidate data were screened to verify that they met criteria consistent with the goals of the analysis before inclusion into the database. For instance, the analysis was limited to No. 1 and No. 2 diesel fuel and related blends that can be used in typical heavy-duty diesel engines without engine modifications. As a result, all emulsions and non-biodiesel oxygenated blends with more than 20 vol% oxygenate were excluded from the final database used in the analysis. Also, synthetic fuels, such as those produced using the Fischer-Tropsch process, rather than refinery streams, were excluded from the final database.

We also limited this study to vehicles and engines that had already been sold commercially or had a high probability of being sold in the future. Vehicles and engines with experimental technologies that had no immediate plans for commercialization, such as those with innovative combustion chamber geometries, were excluded from the database. Likewise, single-cylinder research engines were excluded from consideration, even though the associated full-size parent engine might have been appropriately included in the database, had it been tested. Single-cylinder engines do not appear in heavy-duty applications. By definition, such engines have lower total horsepower and displacement, both of which may influence the way in which biodiesel impacts emissions.

The pairing of diesel and biodiesel fuels used in a particular study also played a role in determining if data from that study would be included in our analysis. For example, we excluded data from all studies that did not test at least two different biodiesel concentrations on the same engine, one of which could be 0 vol% biodiesel.

There were a number of instances in which data from one study was repeated in other studies. This might occur if the authors published the same dataset in multiple scientific journals to maximize exposure, or if the authors presented a previously-published set of data in a new publication for the purposes of comparing the two datasets. Such duplicative data was also excluded from our database.

Also, each prospective data source was screened to verify that it contained raw, not aggregated, data. In cases where raw data was not published in a study, attempts were made to obtain it from the study author(s). Raw data obtained from author(s) were included in our database after successful screening.

A.2.2.2 Criteria for selecting test cycles

We selected cycles which were representative of actual, in-use operating conditions. While the Federal Test Procedure (FTP) transient cycle most-closely reflects actual, in-use operating conditions, we included data from a number of other studies that used atypical test cycles which were adequately comprehensive in their number, selection of modes, and/or in their transient speed-load traces, so that the resulting emission measurements may still be informative.

Data collected under test cycles that were unique, contained only a single steady-state mode, or used two- or three-nonstandard modes for testing, were typically excluded from the database. Non-FTP/UDDS test cycles represented about 24 percent of all data in the database.

A total of eight different cycles, with two variants, representing a variety of load levels were included in our database. A description of the test cycles included in our analysis appears below.

- AVL 8-Mode Test – An eight-mode steady-state engine test procedure, designed to correlate with FTP cycle exhaust emission results. Only NO_x emissions data generated by the AVL 8-Mode test was included in our database.
- Combined International Local Cycle and Commuter (CILCC) – A transient cycle developed by NREL for testing Class 4 to Class 6 vehicles. It is intended to simulate urban delivery driving conditions for heavy-duty vehicles.
- City-Suburban Heavy-Vehicle Cycle (CSHVC) – A transient cycle developed by West Virginia University. It is intended to simulate low-speed urban/ suburban driving conditions of heavy-duty vehicles and is punctuated with frequent stops.
- Freeway Cycle – A transient cycle intended to simulate four-lane highway driving conditions of heavy-duty vehicles, including entrance and exit ramps.
- Federal Test Procedure (FTP) – The heavy-duty transient cycle currently used by EPA for emission, certification, and other testing of heavy-duty on-road engines; the cycle most-closely reflects actual, in-use operating conditions and was developed to simulate a variety of heavy-duty truck and bus driving conditions in cities and on expressways.
- Highway Cycle (HWY) – A high-speed highway cruise cycle based on the Heavy Heavy-Duty Diesel Truck chassis cycle developed by the California Air Resources Board and previously used in the Coordinating Research Council E-55 program.
- Rowan University Composite School Bus Cycle (RUCSBC) – A school bus cycle developed by Rowan University.
- Urban Dynamometer Driving Schedule (UDDS) – A heavy-duty chassis dynamometer test. Our database includes data from the UDDS cycle and two variants simulating light (6,000 lbs) and heavy (28,000 lbs) test weight conditions.

The summary of the test cycles included in our analysis appears in Table A.2-1.

Table A.2-1. Test cycles included in this analysis

Test Cycle	Description	Duration
AVL 8	Eight-mode steady-state cycle	n/a
CILCC	Heavy-duty urban delivery cycle	53 min 12 sec
CSHVC	Heavy-duty city-suburb low-speed cycle	28 min 20 sec
Freeway	Heavy-duty highway cycle	27 min 20 sec
FTP	Heavy-duty engine certification cycle	20 min
HWY	High-speed cruise cycle from CRC E-55	12 min 40 sec
RUCSBC	School bus cycle	21 min 50 sec
UDDS	Heavy-duty chassis cycle	17 min 40 sec
UDDS 6k	UDDS variant based on EPA data	17 min 40 sec
UDDS 28k	UDDS variant based on CRC E-55 data	17 min 40 sec

A.2.2.3 Criteria for selecting feedstock materials

Biodiesel fuel can be produced from a wide variety of feedstock materials. While the studies that comprise our database included only a portion of the many feedstock materials possible, they do represent the most-common feedstock materials. The biodiesel feedstock materials found in our database and their percentages are listed in Table A.2-2.

Table A.2-2. Biodiesel feedstock materials in the database

Feedstock Materials	Number of Observations	Percentage of Observations
Soybean	556	77.1%
Rapeseed/Canola	95	13.2%
Grease ^a	42	5.8%
Tallow	19	2.6%
Coconut	6	0.8%
Lard	3	0.4%

^a Includes high free fatty acid (HFFA) and low free fatty acid (LFFA)

Given the limited data available for some feedstock materials, we aggregated all biodiesel feedstock materials into three general categories: plant-based biodiesel, soybean-based biodiesel (a subset of plant-based biodiesel), and animal-based biodiesel (See Table A.2-3 for a listing of biodiesel feedstock materials aggregated into the categories used in our database).

**Table A.2-3.
Biodiesel feedstock materials aggregated
into categories used in the database**

Aggregated Feedstock Material Category	Number of Observations in Category
Plant-based	657
Soybean-based	556
Animal-based	64

A.2.2.4 Overview of methodology

This section summarizes the statistical approach used in this analysis, which employed the SAS/STAT software procedure PROC MIXED. This procedure can treat some variables as fixed-effects and others as random-effects.

For instance, the NO_x fixed-effect was expressed as a function of percent biodiesel (0 or 20 vol%), vehicle class (Class 1-2a or Class 2b-8), the interaction of percent biodiesel and vehicle class, test cell type (chassis test cell or engine test cell), and the interaction between test cell type and percent biodiesel. Each fixed-effect term is tested and removed if found not

significant. Additional fixed-effect terms were added to the model when examining DDC and non-DDC engines. The random-effects examined were the test cell type and its interaction with percent biodiesel, test cycle, and the biodiesel source.

After creating the initial model, the distribution of mixed-model residuals are examined; residuals with absolute values greater than four standard deviations from a mean of 0 are considered outliers and removed from further consideration.

The final model evaluates the statistical significance of the difference between fuels containing 20 vol% biodiesel and the base fuel, containing no biodiesel. A significance criterion of $p < 0.05$ was used for all analysis. See Section II of the 2002 Draft Technical Report for additional discussion and derivations.

A.2.3 Results

This section contains the results of the biodiesel emissions impact analysis described in Section A.2.2. The results of the analysis of the compatibility of heavy-duty highway chassis and engine data appear in Section A.2.3.1. The results of the analysis of the seven fuel-cycle combinations appear in Section A.2.3.2, including the analysis of DDC engines versus non-DDC engines. The results of the analysis of the NO_x emissions load-dependence appear in Section A.2.3.3 and a discussion of the observed load-dependence impacts placed in the context of relevant literature and the 2002 Draft Technical Report appear in Section A.2.3.4.

A.2.3.1 Compatibility of heavy-duty highway chassis and engine data

The primary objective of the analysis was to quantify the impacts of biodiesel fuels. One aspect of the analysis was to determine if heavy-duty highway emissions engine data in our database was comparable to heavy-duty highway chassis data for purposes of our statistical analysis. Much of the database (66%) consisted of heavy-duty highway engine data, with the balance of the data comprising heavy-duty highway chassis data. Establishing compatibility between engine and chassis data would allow us to make more complete use of all emissions data in the database, which, in turn, would allow us to perform more robust statistical analyses.

Moreover, some researchers criticized the conclusions of our 2002 Draft Technical Report, citing its disproportionate reliance on engine data. These researchers argued that these engines may not behave in a manner indicative of the actual, in-use fleet as a whole or that chassis-generated data might be better-suited for purposes of biodiesel emissions testing. To investigate these claims, we undertook an analysis to determine the compatibility of heavy-duty highway engine data with heavy-duty highway vehicle data.

Using a significance level of $p < 0.05$ for all statistical analysis, engine data was found to be statistically comparable to chassis data for NO_x and PM emissions. This finding is supported by the research of NREL, whose examination of published data suggests that there exists no discrepancy between engine and vehicle testing data (See NREL Milestone 10.4). See Table A.2-4 for a summary of fuel-cycle combinations for which heavy-duty highway engine data was statistically comparable to heavy-duty highway chassis data for regulated pollutants.

**Table A.2-4.
Fuel-cycle combinations for which heavy-duty highway engine
data was statistically comparable to heavy-duty highway
chassis data for regulated pollutants**

		Regulated Pollutants			
		NO _x	PM	CO	HC
Fuel-Cycles	Case 1	x			X
	Case 2	x			X
	Case 3	x			X
	Case 4	x			X
	Case 5a	x			X
	Case 5b	x			X
	Case 5c	x			X

x denotes heavy-duty highway engine data that is statistically comparable to heavy-duty highway chassis data.

Emissions of PM and CO for heavy-duty highway engines and chasses were not found to be statistically comparable to each other for any of the seven fuel-cycle combinations. Based upon our experience with chassis test cells, it is difficult to accurately quantify PM exhaust emissions, as chassis-based testing is often deficient and non-standardized vis-à-vis 40CFR86-2007 and 40CFR1065 for test specification and test equipment, respectively. Deficiencies associated with non-standardized chassis test cells may produce high test-to-test variability. Likewise, CO emissions are difficult to accurately quantify on both heavy-duty engine and chassis test cells and may also produce high test-to-test variability.

High test-to-test variability curtails the ability to accurately capture and discern small differences in exhaust emissions, particularly PM and CO exhaust emissions. This variability may help to explain why engine and chassis data are not comparable in our analysis for CO and PM emissions.

In cases where heavy-duty highway engine data is statistically comparable to heavy-duty highway chassis data, engine and chassis data are pooled to produce the appropriate statistic. In other cases, we believe that the use of engine data alone results in a more-representative statistic, which we report here. The results for the following analysis reflect this approach.

A.2.3.2 Fuel-cycle results

Seven fuel-cycle combinations were identified for our statistical analysis, ranging from a general case, combining testing of all test cycles and all cycles and on all biodiesel fuel feedstock materials to cycles aggregated into light-, medium-, and heavy-duty test cycle categories, which were run exclusively on 20 vol% soybean-based biodiesel fuel. Heavy-duty highway engine and chassis emissions data were statistically comparable for NO_x and HC and were subsequently

pooled for our analysis. Heavy-duty highway engine and chassis emissions data were not statistically comparable for PM and CO, so only engine results are presented here. The results for each of the seven fuel-cycle combinations appears below. All results presented are statistically significant at a significance level of $p < 0.05$.

Case 1: All cycles tested on all biodiesel fuels

Our first fuel-cycle combination examined data collected on all cycles included in the database and from all vehicles and engines tested on both plant-based (soybean, rapeseed/canola and coconut) and animal-based (tallow, lard, and grease) biodiesel fuels (See Table A.2-1 for a listing of all cycles used in the Case 1, Case 2, and Case 4 analyses).

For plant-based and animal-based biodiesel fuels, NO_x emissions were found to increase a statistically-significant 2.0% relative to the base fuel, whereas, PM, CO, and HC emissions were found to decrease by 13.6%, 13.5%, and 18.7%, respectively, relative to the base fuel.

Case 2: All cycles tested on soybean-based biodiesel fuels

Our second fuel-cycle combination examined all cycles specified in Case 1, but only involved vehicles and engines tested on soybean-based biodiesel fuels.

For soybean-based biodiesel, NO_x emissions were found to increase by 2.2%, whereas PM, CO, and HC emissions were found to decrease by 15.6%, 13.8%, and 14.1%, respectively, relative to the base fuel. Case 1 and Case 2 differ in their fuel composition. The biodiesel tested in Case 1 is composed of 20 vol% animal- and plant-based biodiesel, whereas in Case 2, the fuel is composed of 20 vol% soybean-based biodiesel only. The results suggest that the removal of animal-based and/or rapeseed/canola/coconut-based biodiesel fuel feedstock materials may have a slight impact on some exhaust emissions. Increases in emissions of 0.2 %, 2.0%, and 0.3% are observed for NO_x, PM, and CO, respectively, relative to a soybean-based biodiesel discussed in Case 2. HC emissions decrease by 4.6% relative to a soybean-based biodiesel.

Several hypotheses have been advanced by researchers in an attempt to help explain the differences in exhaust emissions between plant-based and animal-based biodiesel feedstock materials; these are, however, outside the scope of the current analysis and are not discussed here.

Case 3: FTP and UDDS cycles tested on soybean-based biodiesel fuels

Our third fuel-cycle combination examined only engines and vehicles tested on soybean-based biodiesel fuel over only the FTP and UDDS cycles. Together, FTP and UDDS cycles comprise 76% of the database observations.

For soybean-based biodiesel, NO_x emissions were found to increase by 3.2%, whereas PM, CO, and HC emissions were found to decrease by 15.6%, 15.9%, and 13.7%, respectively, relative to the base fuel.

The results of this analysis suggest that the emission impacts associated with heavy-duty highway engines and chassis tested on 20 vol% soybean-based biodiesel and run on FTP/UDDS cycles produce an increase in exhaust emissions of 1.0% for NO_x and 2.1% for CO, relative to all engine and chassis cycles run on the same fuels. HC emissions decrease by 0.4% relative to

all engine and chassis cycles and PM emissions appear to be relatively unaffected. These results were statistically significant at a significance level of $p < 0.05$.

As the FTP and UDDS cycles may more-closely represent actual, in-use operating conditions encountered by heavy-duty highway engines and vehicles, it is possible that the Case 3 results may be a better indicator of actual, in-use biodiesel emissions impacts.

Case 4: DDC vs. non-DDC engines tested on soybean-based biodiesel fuels

Our fourth fuel-cycle combination separately examined DDC and non-DDC engines tested on the cycles specified in Case 1 and Case 2 using soybean-based biodiesel fuel.

Our analysis found that DDC heavy-duty engine data was statistically comparable to non-DDC heavy-duty engine data for NO_x, CO, and HC emissions at a significance level of $p < 0.05$. DDC heavy-duty engines and non-DDC heavy-duty engines did not behave in a statistically similar manner for PM emissions, however. In this regard, the results of our analysis suggest that DDC heavy-duty engines behave in the same manner in which non-DDC heavy-duty engines behave in our database for NO_x, CO, and HC emissions. As such, this finding should help alleviate earlier concerns that the disproportionate representation of DDC engines may produce results which are not indicative of the database as a whole or the in-use fleet.

Case 5a: Light-duty cycles tested on soybean-based biodiesel fuels

Our fifth fuel-cycle combination examined heavy-duty engine and chassis data for light-duty cycles specified in Table A.2-5 and tested on soybean-based biodiesel fuel.

For soybean-based biodiesel tested on light-duty cycles, NO_x, PM, CO, and HC emissions were found to decrease by 1.0%, 19.0%, 9.9%, and 14.2% respectively, relative to the base fuel.

Table A.2-5. Cycle composition by case

Case Number	Case Description	Individual Cycles
Case 5a	Light-duty cycles	CILCC CSHVC UDDS6k
Case 5b	Medium-duty cycles	AVL8 (NO _x) Freeway FTP RUCSBC UDDS UDDS28k
Case 5c	Heavy-duty cycles	HWY55

Case 5b: Medium-duty cycles tested on soybean-based biodiesel fuels

Our sixth fuel-cycle combination examined heavy-duty engine and chassis data for medium-duty cycles specified in Table A.2-5 and tested on soybean-based biodiesel fuel.

For soybean-based biodiesel tested on medium-duty cycles, NO_x emissions were found to increase by 2.5%, relative to the base fuel, whereas PM, CO, and HC emissions were found to decrease by 19.0%, 14.0%, and 14.2%, and respectively, relative to the base fuel.

Case 5c: Heavy-duty cycles tested on soybean-based biodiesel fuels

Our seventh fuel-cycle combination examined heavy-duty engine and chassis data for heavy-duty cycles specified in Table A.2-5 and tested on soybean-based biodiesel fuel.

For soybean-based biodiesel tested on heavy-duty cycles, NO_x emissions were found to increase by 5.1%, relative to the base fuel, whereas PM, CO, and HC emissions were found to decrease by 32.6%, 22.0%, and 14.2%, respectively, relative to the base fuel. Unlike Case 5a and 5b, the PM emissions results were significant and greater than those of the light-duty and medium-duty cases. A summary of these results appears in Table A.2-6.

Table A.2-6.
Summary of emissions results for seven fuel-cycle combinations
for heavy-duty highway engines and chasses

		Regulated Pollutants			
		NOx	PM ^a	CO ^a	HC
Fuel-Cycles	Case 1	+2.0%	-13.6%	-13.5% ^b	-18.7%
	Case 2	+2.2%	-15.6%	-13.8%	-14.1%
	Case 3	+3.2%	-15.6%	-15.9%	-13.7%
	Case 4	+2.4%	-16.9%	-13.9%	-14.3%
	Case 5a	-1.0%	-19.0%	-9.9%	-14.2%
	Case 5b	+2.5%		-14.0%	
	Case 5c	+5.1%	-32.6%	-22.0%	

^a Only engine data.

^b Not significant.

A.2.3.3 Load-dependant emissions impacts

We initially identified the load-dependence of NOx emissions in heavy-duty highway engines in 2007 (See Sze *et al.*) and these results were later corroborated by Eckerle *et al.* The results of Sze *et al.* and Eckerle *et al.* were based largely upon new engine and chassis studies (as well as modeling efforts), which were aimed specifically at examining the load-dependent NOx emissions phenomenon.

In the current research, however, our work is retrospective insofar as we examined data from a broad array of pre-existing studies, none of which were designed to examine the load-dependant NOx emissions impacts. As such, this analysis occasionally suffers from the experimental design limitations associated with the pre-existing studies. One such limitation is the use of test cycles which do not realistically reflect actual, in-use operating conditions. Such data can skew results and obscure evidence of the load-dependence of NOx emissions. Such a situation is discussed in Case 5a.

Case 5a, 5b, and 5c: Load-dependant emissions impact on NOx

The load-dependence of NOx emissions observed in this analysis is apparent when comparing Case 5a (light-load cycles) to Case 5b (medium-load cycles) to Case 5c (heavy-load cycles). However, results for the light-load conditions in Case 5a may not be representative of in-use vehicle operation.

Case 5a: Confounding effects of lightly-loaded conditions

The load-dependence of NOx emissions evident in the research of Sze *et al.* and Eckerle *et al.* was based upon medium- and heavy-duty cycles, not lightly-loaded cycles as in Case 5a.

We believe that our current findings for NOx emissions under lightly-loaded conditions may not be representative of the operating conditions typically encountered in actual, in-use fleet operations. As in-use heavy-duty highway engines and vehicles do not typically operate under the lightly-loaded conditions encountered in the cycles which comprise our light-duty category, the practical significance of the NOx emissions results for Case 5a is questionable.

Further, the NOx emissions results for Case 5a are also suspect when compared to Cases 1-4 and 5b-5c, all of which indicate that there is a statistically-significant increase in NOx emissions of between 2.0% and 5.1%.

As such, we place greater significance on the results obtained under medium- (Case 5b) and heavy-load (Case 5c) conditions, since they more-accurately mirror typical, in-use fleet operations and, as a result, provide a more realistic representation of operating conditions encountered in-use.

Case 5b vs. Case 5c: Load-dependant NOx emission impacts

Since the medium-loading conditions associated with these cycles are typical of actual, in-use fleet operations, these cycles provide a more realistic representation of operating conditions encountered by actual fleet usage. As such, we place greater significance on these results.

The difference in NOx emissions between our results here and those of other researchers appears to be attributable to an artifact of the selected test cycle profile. Analyzing the NOx emissions data as a function of load, as we do here -- as opposed to a particular test cycle profile -- reconciles the difference and supports the NOx emission-load-dependence hypothesis for heavy-duty highway engine and chassis posited by Sze *et al.* and corroborated by Eckerle *et al.* The discussion of load-dependant NOx emission impacts in the context of our research appears in Section A.2.3.4.

A.2.3.4 Relevant studies

We initially identified the load-dependence of NOx emissions in heavy-duty highway engines in 2007 (See Sze *et al.*) and these results were later corroborated by Eckerle *et al.* The results of Sze *et al.* and Eckerle *et al.* were based largely upon new engine and chassis studies (as well as modeling efforts), which were aimed specifically at examining the load-dependent NOx emissions phenomenon.

In the current research, however, our work is retrospective insofar as we examined data from a broad array of pre-existing studies, none of which were designed to examine the load-dependant NOx emissions impacts. As such, this analysis occasionally suffers from the experimental design limitations associated with the pre-existing studies. One such limitation is the use of test cycles which do not realistically reflect actual, in-use operating conditions. Such data can skew results and obscure evidence of the load-dependence of NOx emissions. Such a situation is discussed in Case 5a.

2002 Draft Technical Report

In 2002, the EPA conducted a comprehensive analysis of the emission impacts of biodiesel using publicly available data. Entitled "*A Comprehensive Analysis of Biodiesel Emissions Impacts on Exhaust Emissions*," the 2002 Draft Technical Report made use of statistical regression analysis to correlate the concentration of biodiesel in conventional diesel fuel with changes in regulated and unregulated pollutants for heavy-duty highway engines.

Figure A.2-1 presents basic emission correlations for NO_x, PM, CO, and HC developed in the 2002 Draft Technical Report as a function of soybean-based biodiesel concentration. Table A.2-7 presents results specifically for 20 vol% soybean-based biodiesel.

Figure A.2-1.
Emission impacts from the 2002 Draft Technical Report by percent biodiesel content for soybean-based biodiesel added to an average base fuel

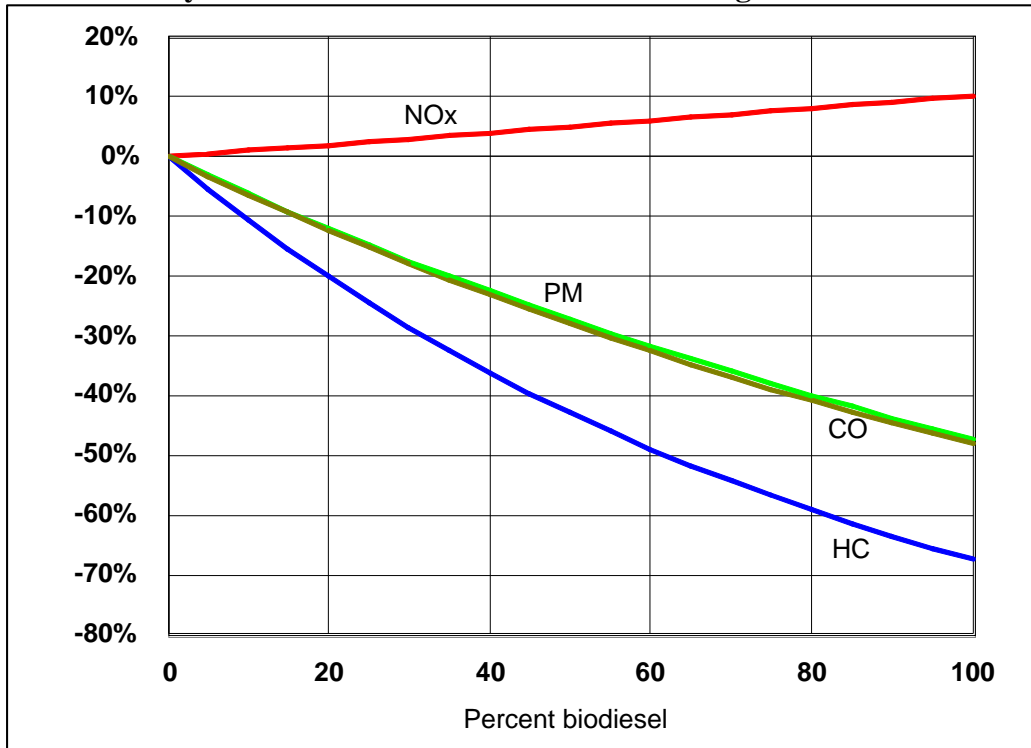
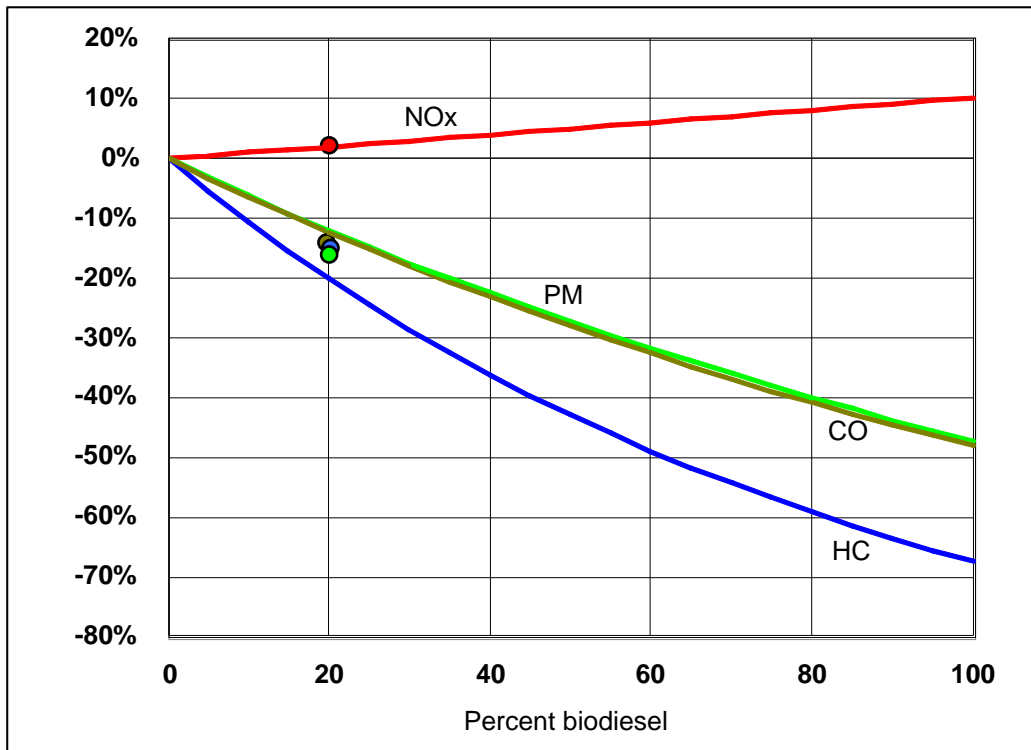

Table A.2-7.
Emission impacts from the 2002 Draft Technical Report for 20 vol% soybean-based biodiesel added to an average base fuel

Emissions	Percent Change in Emissions
NOx	+2.0%
PM	-10.1%
HC	-21.1%
CO	-11.0%

We found that the results of the current analysis, which examined heavy-duty highway engine and chassis data, are consistent with the findings of our 2002 Draft Technical Report, which examined heavy-duty highway engine data only. Compared to the 2002 Draft Technical Report, NOx emissions were found to increase 2.2% while PM, HC, and CO emissions were found to decrease by 15.6%, 14.1%, and 13.8%, respectively, in the current study. These are shown in Figure A.2-2 as points overlaid on the results of the 2002 Draft Technical Report.

Figure A.2-2.
Emission impacts from the 2002 Draft Technical Report by percent biodiesel content for soybean-based biodiesel added to an average base fuel with new results overlaid



SAE paper by Sze et al.

Sze et al. conducted a series of paired fuel tests comparing certification-grade highway diesel fuels with 5 to 50 vol% soybean-based biodiesel blends. Each fuel pair was tested for up to seven transient cycles representing various load conditions, using a 2006 model year Cummins ISB compression ignition engine.

The authors concluded that biodiesel NOx impact on the test engine is directly proportional to average cycle power or fuel consumption and biodiesel content (See Figure A.2-3).

Figure A.2-3.
NOx emissions for 20 vol% and 50 vol% soybean-based biodiesel fuel versus average cycle power for various heavy-duty highway engine and chassis cycles

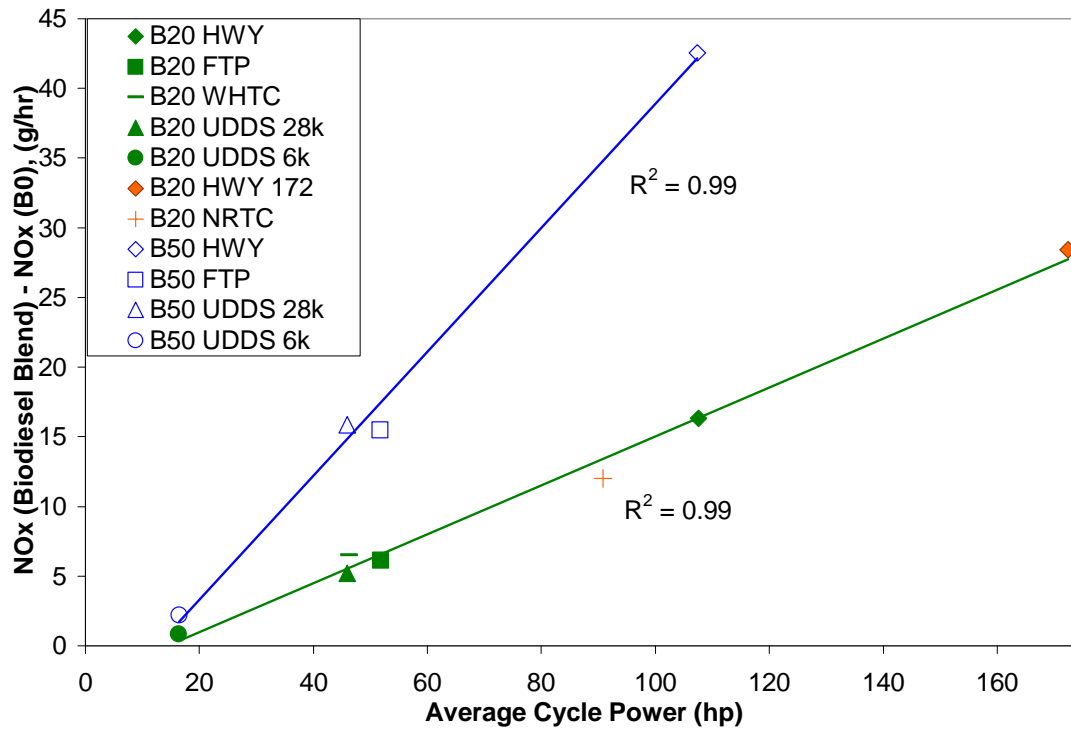

Except for the most lightly-loaded cycle, the results show statistically significant differences in NOx emissions for all fuel pairs. The average NOx emissions due to biodiesel were found to increase over each cycle, ranging from 0.9 to 6.6% for 20 vol% and 2.2 to 17.2% for 50 vol% biodiesel fuels. The load-dependence of NOx emissions observed by Sze *et al.* is consistent with the findings presented in this report for Cases 5a, 5b, and 5c as well as those of Eckerle *et al.*

To further elucidate the load-dependent nature of NOx emissions, Sze *et al.* reanalyzed chassis-generated NOx emissions data from NREL as a function of fuel consumption (a surrogate for average cycle power) and found it to be in close agreement with EPA engine test data. This is depicted in Figure A.2-4. Data from NREL using the same engines tested instead on a chassis dynamometer are also shown in the figure and follow the same trend, with an $R^2 = 0.99$ with and without the inclusion of the NREL dataset.

Figure A.2-4.
NOx emissions for 20 vol% soybean-based biodiesel fuel versus average cycle power for various heavy-duty highway engine and chassis cycles, including NREL chassis testing data

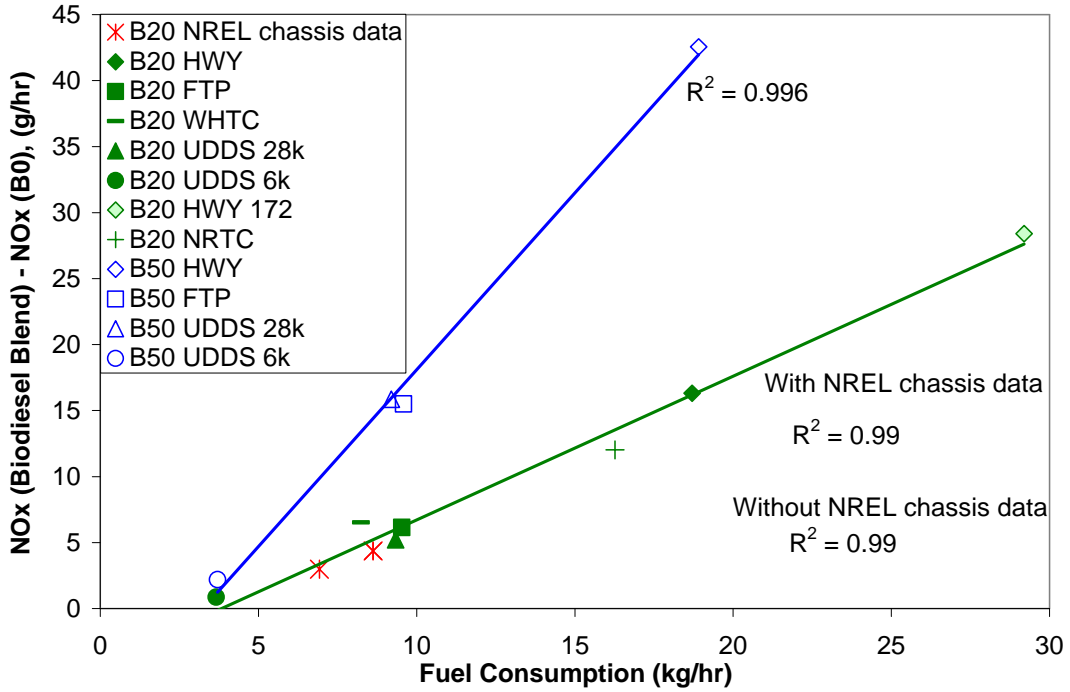

SAE paper by Eckerle *et al.*

The load-dependence of NOx emissions was also examined by Eckerle *et al.*, who generated engine data using 20 vol% soybean-based biodiesel to calibrate chemical kinetic models. These models were used to examine NOx production during the combustion process. The authors concluded that the NOx effect associated with burning biodiesel blends over a duty cycle depends, in part, on the duty cycle average power and that higher duty cycle average power corresponded to larger increases in NOx emissions.

Appendix to Biodiesel Effects on Heavy-Duty Highway Engines and Vehicles

Studies included in database

Aako P. *et al.*, "Emission Performance of Selected Biodiesel Fuels - VTT's Contribution" Research Report ENE/33/2000, October 2000

Alam M. *et al.*, "Combustion and Emissions Performance of Low Sulfur, Ultra Low Sulfur and Biodiesel Blends in a DI Diesel Engine," SAE paper no. 2004-01-3024

Bouché, T., M. Hinz, R. Pitterman, "Optimising Tractor CI Engines for Biodiesel Operation," SAE paper no. 2000-01-1969

Callahan, T.J., C.A. Sharp, "Evaluation of Methyl Soyate/Diesel Fuel Blends as a Fuel for Diesel Engines," Southwest Research Institute Final Report to the American Biofuels Association, December 1993

Clark N. N. *et al.*, "Class 8 Truck Emission Testing: Effects of Test Cycles and Data on Biodiesel Operation," ASAE, 1999, 42(5), 1211-1219

Clark, N.N., C.M. Atkinson, G.J. Thompson, R.D. Nine, "Transient Emissions Comparisons of Alternative Compression Ignition Fuels," SAE paper no. 1999-01-1117

Durbin T. D. *et al.*, "Effects of Biodiesel, Biodiesel Blends, and a Synthetic Diesel on

Emissions from Light Heavy-Duty Diesel Vehicles," *Environ. Sci. Technol.*, 2000, 34, 349-355

Durbin, T.D., *et al.*, "Evaluation of the Effects of Biodiesel and Biodiesel Blends on Exhaust Emission Rates and Reactivity - 2", Center for Environmental Research and Technology; College of Engineering; University of California, Riverside, August 2001

Durbin, T.D., J.M. Norbeck, "Effects of Biodiesel Blends and Arco EC-Diesel on Emissions from Light Heavy-Duty Diesel Vehicles," *Environ. Sci. Technol.*, 2002, 36, 1686-1691

Durbin, T.D., J.R. Collins, J.M. Norbeck, M.R. Smith, "Evaluation of the Effects of Alternative Diesel Fuel Formulations on Exhaust Emissions Rates and Reactivity," Final Report from the Center for Environmental Research and Technology, University of California, April 1999

Environment Canada, "Emissions Characterization of a Caterpillar 3126E Equipped with a Prototype SCRT System with Ultra Low Sulfur Diesel and a Biodiesel Blend," ERMD Report #2005-32, 2005

Fosseen, D., "DDC 6V-71N Emission Testing on Diesel and Biodiesel Blend," Fosseen Manufacturing and Development, Ltd., report no. NSDB4F15, July 14, 1994

Fosseen, D., "DDC 6V-92TA MU1 Coach Upgrade Emission Optimization on 20%/80% Soy/Diesel Blend," Fosseen Manufacturing & Development, Ltd., report no. 260-2 and 24 1-1, September 30, 1994

Frank B.P. *et al.*, "A Study of the Effects of Fuel Type and Emission Control Systems on Regulated Gaseous Emissions from Heavy-Duty Diesel Engines," SAE paper no. 2004-01-1085

Goetz, W., "Evaluation of a Tallow/Diesel Blend in a DDC 6V-92TA Engine," Ortech International report no. 93-E14-37, July 21, 1993

Goetz, W., "Evaluation of Methyl Soyate/Diesel Blend in a DDC 6V-92TA Engine: Optimization of NOx Emissions," Ortech International, Report No. 93-E14-36, July 20, 1993

Graboski, M.S., J.D. Ross, R.L. McCormick, "Transient Emissions from No. 2 Diesel and Biodiesel Blends in a DDC Series 60 Engine," SAE paper no. 961166

Graboski, M.S., R.L. McCormick, T.L. Alleman, A.M. Herring, "The Effect of Biodiesel Composition on Engine Emissions from a DDC Series 60 Diesel Engine," Colorado School of Mines, Final Report to National Renewable Energy Laboratory, June 8, 2000

Hansen, K.F., M.G. Jensen, "Chemical and Biological Characteristics of Exhaust Emissions from a DI Diesel Engine Fuelled with Rapeseed Oil Methyl Ester (RME)," SAE paper no. 971689

Holden, Bruce *et al.*, Final Report: "Effect of Biodiesel on Diesel Engine Nitrogen Oxide and Other Regulated Emissions," Naval Facilities Engineering Command (NAVFAC) Technical Report TR-2275-ENV, May 2006

Howes, P., G. Rideout, "Evaluation of Biodiesel in an Urban Transit Bus Powered by a 1988 DDECII6V92 TA Engine," National Biodiesel Board, MSED Report # 96-26743-1, June 1995

Howes, P., G. Rideout, "Evaluation of Biodiesel in an Urban Transit Bus Powered by a 1981 DDCC8V71 Engine," National Biodiesel Board, MSED Report # 95-26743-2

Liotta, F.J., D.M. Montalvo, "The Effect of Oxygenated Fuels on Emissions from a Modern Heavy-Duty Diesel Engine," SAE paper no. 932734

Lyons D. W., "Biodiesel Fuel Comparison Final Data Report for Washington Metropolitan Area Transit Authority," West Virginia University, August 2002

Manicom, B., C. Green, W. Goetz, "Methyl Soyate Evaluation of Various Diesel Blends in a DDC 6V-92 TA Engine," Ortech International, April 21, 1993

Marshall, W., L.G. Schumacher, S. Howell, "Engine Exhaust Emissions Evaluation of a Cummins L10E When Fueled With a Biodiesel Blend," University of Missouri

McCormick R.L. *et al.*, "Fuel Additive and Blending Approaches to Reducing NOx Emissions from Biodiesel," SAE paper no. 2002-01-1658

McCormick R.L. *et al.*, "Regulated Emissions from Biodiesel Tested in Heavy-Duty Engines Meeting 2004 Emission Standards," SAE paper no. 2005-01-2200

McCormick, R.L. *et al.*, "Effects of Biodiesel Blends on Vehicle Emissions, FY 2006 Annual Operating Plan Milestone 10.4," October 2006

McCormick, R.L., J.D. Ross, M.S. Graboski, "Effect of Several Oxygenates on Regulated Emissions from Heavy-Duty Diesel Engines," *Environ. Sci. Technol.*, 1997, 31, 1144-1150

McCormick, R.L., J.R. Alvarez, M.S. Graboski, "NOx Solutions for Biodiesel," Colorado School of Mines, August 31, 2001

McDonald, J.F., D.L. Purcell, B.T. McClure, D.B. Kittelson, "Emissions Characteristics of Soy Methyl Ester Fuels in an IDI Compression Ignition Engine," SAE paper no. 950400

McGill, R., Storey, J., Wagner, R., Irick, D., Aakko, P., Westerholm, M., Nylund, N., Lappi, M., "Emission Performance of Selected Biodiesel Fuels," SAE paper no. 2003-01-1866

National Institute for Petroleum and Energy Research, "Effects of Methyl Esters of Tallow and Grease on Exhaust Emissions and Performance of a Cummins L10 Engine," September 16, 1993

National Resources Canada, "National Resources Canada/Fiba Canning - Biodiesel Freightliners," National Resources Canada draft report, October 24, 2006

ORYXE Energy International, Inc., Biodiesel Emissions Test Summary, ORYXE presentation, 2006

Peterson C. L., *et al.*, "The Effect of Biodiesel Feedstock on Regulated Emissions in Chassis Dynamometer Tests of a Pickup Truck," *ASAE*, 2000, 43 (6), 1371-1381

Peterson, C., D. Reece, J. Thompson, S. Beck, C. Chase, "Development of Biodiesel for Use in High Speed Diesel Engines," University of Idaho, presentation at Sixth National Bioenergy Conference, Oct. 2-6, 1994

Peterson, C.L., "Truck-In-The-Park Biodiesel Demonstration with Yellowstone National Park," University of Idaho, August 1999

Peterson, C.L., D.L. Reece, "Emissions Testing with Blends of Esters of Rapeseed Oil Fuel With and Without a Catalytic Converter," SAE paper no. 961114

Peterson, C.L., D.L. Reece, "Emissions Tests with an On-Road Vehicle Fueled with Methyl and Ethyl Esters of Rapeseed Oil," *ASAE* paper no. 946532

Rantanen, L., S. Mikkonen, L. Nylund, P. Kociba, M. Lappi, N. Nylund, "Effect of Fuel on the Regulated, Unregulated and Mutagenic Emissions of DI Diesel Engines," SAE paper no. 932686

Schumacher, L., N.N. Clark, D.W. Lyons, W. Marshall, "Diesel Engine Exhaust Emissions Evaluation of Biodiesel Blends Using a Cummins L10E Engine," *ASAE*, 44(6), 1461-1464

Schumacher, L., S.C. Borgelt, W.G. Hires, W. Wetherell, A. Nevils, "100,000 Miles of Fueling 5.9L Cummins Engines with 100% biodiesel," SAE paper no. 962233

Schumacher, L.G., S.C. Borgelt, W.G. Hires, D. Fosseen, W. Goetz, "Fueling Diesel Engines with Blends of Methyl Ester Soybean Oil and Diesel Fuel," University of Missouri. See <http://web.missouri.edu/~pavt0689/ASAED94.htm>.

Sharp, C.A., "Characterization of Biodiesel Exhaust Emissions for EPA 211(b)," Southwest Research Institute report no. 08-1039A, January 1998

Sharp, C.A., "Emissions and Lubricity Evaluation of Rapeseed Derived Biodiesel Fuels," Southwest Research Institute, Final Report for Montana Department of Environmental Quality, November 1996

Sharp, C.A., "Transient Emissions Testing of Biodiesel and Other Additives in a DDC Series 60 Engine," Southwest Research Institute, Final Report to the National Biodiesel Board, December 1994

Sharp, C.A., "Transient Emissions Testing of Biodiesel in a DDC 6V-92TA DDEC Engine," Southwest Research Institute, Final Report to the National Biodiesel Board, October 1994

Sharp, C.A., S.A. Howell, J. Jobe, "The Effect of Biodiesel Fuels on transient Emissions from Modern Diesel Engines, Part I Regulated Emissions and Performance," SAE paper no. 2000-01-1967

Sirman, M.B., E.C. Owens, K.A. Whitney, "Emissions Comparison of Alternative Fuels in an Advanced Automotive Diesel Engine," Southwest Research Institute, AD A353968/PAA, November 1998

Smith, J.A., D.L. Endicott, R.R. Graze, "Biodiesel Engine Performance and Emissions Testing," Caterpillar Technical Center, May 1998

Souigny M. *et al.*, "Heavy-Duty Engine Performance and Comparative Emission Measurements for Different Biodiesel Blends Used in the Montreal Project," SAE paper no. 2004-01-1861

Spataru, A., C. Romig, "Emissions and Engine Performance from Blends of Soya and Canola Methyl Ester with ARB #2 Diesel in a DDC 6V92TA MUI Engine," SAE paper no. 952388

Starr, M.E., "Influence on Transient Emissions at Various Injection Timings, Using Cetane Improvers, Bio-Diesel, and Low Aromatic Fuels," SAE paper no. 972904

Stotler, R.W., D.M. Human, "Transient Emission Evaluation of Biodiesel Fuel Blend in a 1987 Cummins L10 and DDC 6V-92-TA," Engineering Test Services, report no. ETS-95-128, Nov. 30, 1995

Ullman, T.L., C.T. Hare, T.M. Baines, "Heavy-Duty Diesel Emissions as a Function of Alternate Fuels," SAE paper no. 830377

Wang, W.G., D.W. Lyons, N.N. Clark, M. Gautam, "Emissions from Nine Heavy Trucks Fueled by Diesel and Biodiesel Blend without Engine Modification," *Environ. Sci. Technol.*, 2000, 34, 933-939

Studies not included because data collected on single cylinder/experimental engine

Murayama, T., Y. Oh, A. Kido, T. Chikahisa, N. Miyamoto, K. Itow, "Effects of Super Heating of Heavy Fuels on Combustion and Performance in DI Diesel Engines," SAE paper no. 860306

Murayama, T., Y. Oh, N. Miyamoto, T. Chikahisa, N. Takagi, K. Itow, "Low Carbon Flower Buildup, Low Smoke, and Efficient Diesel Operation with Vegetable Oils by Conversion to Mono-Esters and Blending with Diesel Oil or Alcohols," SAE paper no. 841161

Shaheed, A., E. Swain, "Performance and Exhaust Emission Evaluation of a Small Diesel Engine Fuelled with Coconut Oil Methyl Esters," SAE paper no. 981156

Suda, K.J., "Vegetable Oil or Diesel Fuel - A Flexible Option," SAE paper no. 840004

Ziejewski, M., H.J. Goettler, "Comparative Analysis of the Exhaust Emissions for Vegetable Oil Based Alternative Fuels," SAE paper no. 920195

Studies not included because data not readily available

Alfuso, S., M. Auriemma, G. Police, M.V. Prati, "The Effect of Methyl-Ester of Rapeseed Oil on Combustion and Emissions of DI Diesel Engines," SAE paper no. 932801

Hemmerlain, N., V. Korte, H. Richter, G. Schröder, "Performance, Exhaust Emissions and Durability of Modern Diesel Engines Running on Rapeseed Oil," SAE paper no. 910848

Humke, A.L., N.J. Barsic, "Performance and Emissions Characteristics of a Naturally Aspirated Diesel Engine with Vegetable Oil Fuels - (Part 2)," SAE paper no. 810955

Knothe, G., C.A. Sharp, T.W. Ryan, "Exhaust Emissions of Biodiesel, Petrodiesel, Neat Methly Esters, and Alkanes in a New Technology Engine," *Energy and Fuels*, 2006, 20, 403-408

Lapuerta, M., Armas, O., Ballesteros, R., Fernandez, J., "Diesel Emissions from Biofuels Derived from Spanish Potential Vegetable Oils," *Fuel*, 2005, 84(6), 773-780

Last, R.J., M. Krüger, M. Dürnhholz, "Emissions and Performance Characteristics of a 4-Stroke, Direct Injected Diesel Engine Fueled with Blend of Biodiesel and Low Sulfur Diesel Fuel," SAE paper no. 950054

Ma, W., L.I. Leviticus, F.G. Ullman, "On-Line Measurement of Formaldehyde in Tailpipe Emissions by Tunable Diode Laser Spectroscopy," SAE paper no. 941702

Martin, B., P. Aakko, D. Beckman, N. D. Giacomo, F. Giavazzi, "Influence of Future Fuel Formulations on Diesel Engine Emissions - A Joint European Study," SAE paper no. 972966

McDonald, J.F., "Evaluation of a Yellow Grease Methyl Ester and Petroleum Diesel Fuel Blend," University of Minnesota Final Report to the Agricultural Utilization Research Institute, August 11, 1997

Montagne, X., "Introduction of Rapeseed Methyl Ester in Diesel Fuel - The French National Program," SAE paper no. 962065

Reece, D.L., C.L. Peterson, "Biodiesel Testing in Two On-Road Pickups," SAE paper no. 952757

Staat, F., P. Gateau, "The Effects of Rapeseed Oil Methyl Ester on Diesel Engine Performance, Exhaust Emissions and Long-Term Behavior - A Summary of Three Years of Experimentation," SAE paper no. 950053

Studies not included because test cycle nonstandard/unrepresentative

Adelman, A.J., "Emission Evaluation Test Report for a Comparative Analysis of Emissions Among Petroleum Diesel and Biodiesel Blends fired in a Large Diesel Engine," AirNova, Inc., January 1998

Akasaka, Y., T. Suzuki, Y. Sakurai, "Exhaust Emissions of a DI Diesel Engine Fueled with Blends of Biodiesel and Low Sulfur Diesel Fuel," SAE paper no. 972998

Bagley, S.T., L.D. Gratz, J.H. Johnson, J.F. McDonald, "Effects of an Oxidation Catalytic Converter and a Biodiesel Fuel on the Chemical, Biological, and Particulate Size Characteristics of Emissions from an IDI Diesel Engine," Michigan Technological University, December 1995

Chang, D.Y., J.H. Van Gerpen, "Determination of Particulate and Unburned Hydrocarbon Emissions from Diesel Engines Fueled with Biodiesel," SAE paper no. 982527

Chang, D.Y.Z., J.H. Van Gerpen, "Fuel Properties and Engine Performance for Biodiesel Prepared from Modified Feedstocks," SAE paper no. 971684

Choi, C.Y., G.R. Bower, R.D. Reitz, "Effects of Biodiesel Blended Fuels and Multiple Injections on D.I. Diesel Engines," SAE paper no. 970218

Czerwinski, J., "Performance of HD-DI-Diesel Engine with Addition of Ethanol and Rapeseed Oil," SAE paper no. 940545

Desantes, J.M., J. Arrègle, S. Ruiz, A. Delage, "Characterization of the Injection-Combustion Process in a D.I. Diesel Engine Running with Rape Oil Methyl Ester," SAE paper no. 1999-01-1497

Fort, E.F., P.N. Blumberg, H.E. Staph, J.J. Staudt, "Evaluation of Cottonseed Oil as Diesel Fuel," SAE paper no. 820317

Jacobus, M.J., S.M. Geyer, S.S. Lestz, W.D. Taylor, T.H. Risby, "Single-Cylinder Diesel Engine Study of Four Vegetable Oils," SAE paper no. 831743

Masjuki, H., M.Z. Abdulmuin, H.S. Sii, "Investigations on Pre-Heated Palm Oil Methyl Esters in the Diesel Engine," IMechE 1996, Part A: Journal of Power and Energy

Needham, J.R., D.M. Doyle, "The Combustion and Ignition Quality of Alternative Fuels in Light Duty Diesels," SAE paper no. 852101

Schmidt, K., J. Van Gerpen, "The Effect of Biodiesel Fuel Composition on Diesel Combustion and Emissions," SAE paper no. 961086

Scholl, K.W., S.C. Sorenson, "Combustion of Soybean Oil Methyl Ester in a Direct Injection Diesel Engine," SAE paper no. 930934

Schramm, J., I. Foldager, N. Olsen, L. Gratz, "Emissions from a Diesel Vehicle Operated on Alternative Fuels in Copenhagen," SAE paper no. 1999-01-3603

Schröder, O., J. Krahl, A. Munack, J. Krahl, J. Bünger, "Environmental and Health Effects Caused By the Use of Biodiesel," SAE paper no. 1999-01-3561

Senatore, A., M. Cardone, V. Rocco, M.V. Prati, "A Comparative Analysis of Combustion Process in D.I. Diesel Engine Fueled with Biodiesel and Diesel Fuel," SAE paper no. 2000-01-0691

Uchida, M., Y. Akasaka, "A Comparison of Emissions from Clean Diesel Fuels," SAE paper no. 1999-01-1121

Zhang, Y., J.H. Van Gerpen, "Combustion Analysis of Esters of Soybean Oil in a Diesel Engine," SAE paper no. 960765

Studies not included because they lack new emissions data for regulated pollutants

Culshaw, F.A., "The Potential of 'Biodiesel' from Oilseed Rape," IMechE 1993, Part A: Journal of Power and Energy

Durbin, T.D., J.R. Collins, H. Galdamez, J.M. Norbeck, M.R. Smith, R.D. Wilson, T. Younglove, "Evaluation of the Effects of Biodiesel Fuel on Emissions from Heavy-Duty Non-Road Engines," University of California Final Report submitted to South Coast Air Quality Management District, May 2000

Peterson, C.L., D.L. Auld, "Technical Overview of Vegetable Oil as a Transportation Fuel," University of Idaho, 1991

Sharp, C.A., S.A. Howell, J. Jobe, "The Effect of Biodiesel Fuels on Transient Emissions from Modern Diesel Engines, Part II Unregulated Emissions and Chemical Characterization," SAE paper no. 2000-01-1968

Exclusion of duplicate datasets

Colorado Institute for Fuels and High Altitude Engine Research, "Emissions from Biodiesel Blends and Neat Biodiesel from a 1991 Model Series 60 Engine Operating at High Altitude," Final Report to National Renewable Energy Laboratory, September 1994

Note: CO₂ values were not duplicative.

McCormick, R.L., M.S. Graboski, T.L. Alleman, A.M. Herring, "Impact of Biodiesel Source Material and Chemical Structure on Emissions of Criteria Pollutants from a Heavy-Duty Engine," Environ. Sci. Technol., 2001, 35, 1742-1747

Peterson, C.L., D.L. Reece, "Emissions Testing with Blends of Esters of Rapeseed Oil Fuel With and Without a Catalytic Converter," SAE paper no. 961114

Note: Only Table 6 data is duplicative.

Taberski, J.S., C.L. Peterson, "Dynamometer Emissions test Comparisons on a 5.9L Direct Injected Diesel Powered Pickup," BioEnergy '98: Expanding BioEnergy Partnerships

Taberski, J.S., C.L. Peterson, J. Thompson, H. Haines, "Using Biodiesel in Yellowstone National Park - Final Report of the Truck in the Park Project," SAE paper no. 1999-01-2798

Studies not included for other reasons

Durbin T. D. *et al.*, "Evaluation of the Effects of Biodiesel Fuel on Emissions from Heavy-Duty Non-Road Vehicles", Final Report for the SCAQMD under contract No. 99132 by the University of California, Riverside, May 2000

Reason: Non-road vehicles not considered here.

Frank B.P. *et al.*, "A Study of the Effects of Fuel Type and Emission Control Systems on Regulated Gaseous Emissions from Heavy-Duty Diesel Engines," SAE paper no. 2004-01-1085

Reason: Effect of oxycat & CRDPF greater than effect of B20.

Guerra S. A. *et al.*, "Comparison Study of NO_x and CO₂ Emissions from an Off-Road Diesel Compactor Running on Regular Diesel, Biodiesel and Ultra-Low Sulfur Diesel," University of Kansas draft report, March 17, 2006

Reason: Non-road equipment not considered here.

Watts, W.F., M. Spears, J Johnson, "Evaluation of Biodiesel Fuel and Oxidation Catalyst in an Underground Metal Mine," University of Minnesota, September 24, 1998

Reason: Emission measurements were made in the field with portable emission measurement devices

Yoshimoto, Y., M. Onodera, H. Tamaki, "Reduction of NO_x, Smoke, and BSFC in a Diesel Engine Fueled by Biodiesel Emulsion with Used Frying Oil," SAE paper no. 1999-01-3598

Reason: Biodiesel blend included water in an emulsion

Endnotes

¹ See the following documents: Iowa State University Center for Agricultural Research and Development, “Emerging Biofuels: Outlook of Effects on U.S. Grain, Oilseed, and Livestock Markets,” May 2007 (a revised version is available from July 2007); USDA Agricultural Projections to 2016, Report OCE-2007-1, February 2007 (a newer version was released in Feb 2008 with Projections to 2017); NCGA, “How Much Ethanol Can Come From Corn?” 2006; USDA, “An Analysis of the Effects of an Expansion in Biofuel Demand on U.S. Agriculture,” May 2007.

² Western Governors’ Association. “Transportation Fuels for the Future, Biofuels: Part I,” January 8, 2008.

³ U.S. Government Accountability Office. “DOE Lacks a Strategic Approach to Coordinate Increasing Production with Infrastructure Development and Vehicle Needs,” June 2007.

⁴ USDA/NASS. “Corn: Yield by year, US,”

http://www.nass.usda.gov/Charts_and_Maps/Field_Crops/cornyld.asp, August 12, 2008.

⁵ USDA Agricultural Projections to 2016, Report OCE-2007-1, February 2007, page 39.

⁶ USDA, National Agricultural Statistics Service, Crop Production and Grain Stocks; USDA, World Agricultural Outlook Board, World Supply and Demand Estimates; and U.S. Department of Commerce, Bureau of the Census.

⁷ USDA Agricultural Projections to 2016, Report OCE-2007-1, February 2007, page 22.

⁸ Shapouri, H., Gallagher, P., “USDA’s 2002 Ethanol Cost-of-Production Survey,” July 2005, p.11.

⁹ USDA, “The Economic Feasibility of Ethanol Production from Sugar in the United States,” July 2006.

¹⁰ Personal communication with Nathalie Hoffman, Managing Member of California Renewable Energies, LLC, August 27, 2008.

¹¹ Christiansen, Ryan, “Analysis: Sugarcane Ethanol Has 95% Less Emissions,” Ethanol Producer Magazine, March 2009.

¹² Voegelé, Erin, “Sugarcane Economics,” Ethanol Producer Magazine, March 2009.

¹³ F.O. Licht, “World Ethanol Markets: The Outlook to 2015,” 2006, page 45.

¹⁴ “Sugarcane Industry in Brazil: Ethanol, Sugar, Bioelectricity” brochure from UNICA

¹⁵ FAO Statistics, “Sugarcane selected as Commodity,”

<http://www.fao.org/es/ess/top/commodity.html?lang=en&item=156&year=2005>, August 12, 2008.

¹⁶ Agra FNP. “Sugar and Ethanol in Brazil: A Study of the Brazilian Sugar Cane, Sugar and Ethanol Industries,” 2007.

¹⁷ “Sugarcane Industry in Brazil: Ethanol, Sugar, Bioelectricity” brochure from UNICA

¹⁸ Scaramucci, Jose & Cunha, Marcelo, “Bioethanol as Basis for Regional Development in Brazil: An Input-Output Model with Mixed Technologies.”

¹⁹ CGEE, ABDI, Unicamp, and NIPE, “Scaling Up the Ethanol Program in Brazil,” n.d. cited in Rothkopf, Garten, “A Blueprint for Green Energy in America,” 2006.

²⁰ USDA, “The Economic Feasibility of Ethanol Production from Sugar in the United States,” July 2006.

²¹ Kline, K. et. al., “Biofuel Feedstock Assessment for Selected Countries,” Oak Ridge National Laboratory, February 2008.

-
- ²² Elbehri, Aziz. USDA, ERS, “An Evaluation of the Economics of Biomass Feedstocks: A Synthesis of the Literature,” Prepared for the Biomass Research and Development Board, 2007.
- ²³ Milbrandt, A., “Geographic Perspective on the Current Biomass Resource Availability in the United States,” NREL Report No. TP-560-39181, 2005.
- ²⁴ Gallagher, P. et. al., “Supply and Social Cost Estimates for Biomass from Crop Residues in the United States,” *Environmental and Resource Economics* 24: 335-358, 2003.
- ²⁵ Walsh, Marie, “U.S. Cellulosic Biomass Feedstock Supplies and Distribution,” Unpublished Manuscript, January 10, 2008.
- ²⁶ Graham, R.L. et. al., “Current and Potential U.S. Corn Stover Supplies,” *American Society of Agronomy* 99:1-11, 2007.
- ²⁷ W. W. Wilhelm, USDA-ARS, Univ. of Nebraska, Lincoln, NE 68583-0934, J. M. F. Johnson, USDA-ARS, Morris, MN 56267-1065, J. L. Hatfield, 108 Natl. Soil Tilth Lab., Ames, IA 50011-3120, W. B. Voorhees, USDA-ARS (retired), Morris, MN 56267-1065, and D. R. Linden, USDA-ARS (retired), St. Paul, MN 55108-0000, Crop and Soil Productivity Response to Corn Residue Removal A Literature Review; FORUM, © American Society of Agronomy, Madison, WI 53711 USA, Published in *Agron. J.* 96:1-17 (2004)
- ²⁸ Predicting Soil Erosion by Water. A Guide to Conservation Planning with the Revised Universal Soil Loss Equation (RUSLE). United States Department of Agriculture, Agricultural Research Service, Agricultural Handbook Number 703, 1997.
- ²⁹ Richard G. Nelson, Enersol Resources, Manhattan, KS 66502, USA, Resource Assessment and Removal Analysis for Corn Stover and Wheat Straw in the Eastern and Midwestern United States—Rainfall and Wind-induced Soil Erosion Methodology, *Biomass and Bioenergy* 22 (2002) 349 – 363, Published by Elsevier Science Ltd
- ³⁰ Linda Mann, Virginia Tolbert, Janet Cushman, Environmental Sciences Division, Oak Ridge National Laboratory, Oak Ridge, TN 37831-6038, Potential Environmental Effects of Corn Stover Removal With Emphasis on Soil Organic Matter and Erosion, *Agriculture, Ecosystems and Environment* 89: 149-166, ISSN 0167-8809 Elsevier Science, Amsterdam. June 2002.
- ³¹ <http://www.nrcs.usda.gov/technical/Standards/nhcp.html>
- ³² Richard G. Nelson, Enersol Resources, Manhattan, KS 66502, USA, Resource Assessment and Removal Analysis for Corn Stover and Wheat Straw in the Eastern and Midwestern United States—Rainfall and Wind-induced Soil Erosion Methodology, *Biomass and Bioenergy* 22 (2002) 349 – 363, Published by Elsevier Science Ltd.
- ³³ W.W. Wilhelm, USDA-ARS; J.M.F. Johnson, USDA-ARS; D.L. Karlen, USDA-ARS; D.T. Lightle, National Soil Survey; Corn Stover to Sustain Soil Organic Carbon Further Constrains Biomass Supply, Published in *Agron. J.* 99:1665–1667 (2007); American Society of Agronomy, Madison, WI 53711.
- ³⁴ Susan S. Andrews, Ph.D., Leader, Soil Quality National Technology Development Team USDA-Natural Resource Conservation Service Crop, White Paper: Residue Removal for Biomass Energy Production: Effects on Soils and Recommendations, Updated February 22, 2006
- ³⁵ Graham, R.L. et. al., “Current and Potential U.S. Corn Stover Supplies,” *American Society of Agronomy* 99:1-11, 2007.
- ³⁶ Perlack, Robert D.; Biomass as Feedstocks for a Bioenergy and Bioproducts Industry: The Technical Feasibility of a Billion Ton Annual Supply; Sponsored by the U.S. Department of Energy and the U.S. Department of Agriculture; April 2005.
- ³⁷ *Ibid.*

-
- ³⁸ Walsh, M.E. (2007) Sungrant Bioweb. Forest Resources.
<http://bioweb.sungrant.org/Technical/Biomass+Resources/Forest+Resources/Default.htm>
- ³⁹ *Ibid.*
- ⁴⁰ QUANTIFYING THE FLOW: TAKING INVENTORY OF WOODY RESIDUALS, David McKeever, Research Forester, USDA Forest Service's Forest Products Laboratory, Madison, Wisconsin. Published in *Biocycle*, July 2003, pp. 31-35.
- ⁴¹ Perlack, R.D., Wright, L.L., Turhollow, A.F, Graham, R.L., Environmental Sciences Division, Oak Ridge National Laboratory; Stokes, B.J., Forest Service, USDA.; Erbach, D.C., Agricultural Research Service, USDA, "Biomass as Feedstock for a Bioenergy & Bioproducts Industry: The Technical Feasibility of a Billion-Ton Annual Supply (A Joint Study Sponsored by DOE and USDA, Prepared by Oak Ridge National Laboratory)," 2005.
- ⁴² *Ibid.*
- ⁴³ Kerstetter, J. and Lyons, J., (2001) *Logging and Agricultural Residue Supply Curves for the Pacific Northwest*. Washington State University Energy Program for U.S. DOE.
- ⁴⁴ Rummer, B.; Len, D.; and O'Brien, O. (2004). *Forest Residues Bundling Project-New Technology for Residue Removal*. USDA Forest Service, Southern Research Station
- ⁴⁵ *Ibid.*
- ⁴⁶ Rawlings, C., et. al. (2004). *A Study of How to Decrease the Costs of Collecting, Processing and Transporting Slash*. USDA Forest Service.
- ⁴⁷ Dickerson, K., et. al. (revised November 2007). *Biomass and Biofuels in Maine: Estimating Supplies for Expanding the Forest Products Industry*. Margaret Chase Smith Policy Center.
- ⁴⁸ Puttock, G.D. (1995). Estimating cost for integrated harvesting and related forest management activities. *Biomass and Bioenergy* 8(2), 73-79.
- ⁴⁹ Perlack, R.D., Wright, L.L., Turhollow, A.F, Graham, R.L., Environmental Sciences Division, Oak Ridge National Laboratory; Stokes, B.J., Forest Service, USDA.; Erbach, D.C., Agricultural Research Service, USDA, "Biomass as Feedstock for a Bioenergy & Bioproducts Industry: The Technical Feasibility of a Billion-Ton Annual Supply (A Joint Study Sponsored by DOE and USDA, Prepared by Oak Ridge National Laboratory)," 2005.
- ⁵⁰ Dickerson, K., et. al. (revised November 2007). *Biomass and Biofuels in Maine: Estimating Supplies for Expanding the Forest Products Industry*. Margaret Chase Smith Policy Center.
- ⁵¹ *Ibid.*
- ⁵² Timko, B., 2003. USDA, Forest Service, personal communication as noted in the "Billion-ton Study" by Perlack, R.D., et. al.
- ⁵³ F. Bohlin and A. Roos, Wood fuel supply as a function of forest owner preferences and management styles, *Biomass & Bioenergy* 22 (2002), pp. 237-249.
- ⁵⁴ Jonsell, M. 2007. Effects on Biodiversity of Forest Fuel Extraction, Governed by Processes Working on a Large Scale. *Biomass and Bioenergy*, Issue 31 pg. 726-732.
- ⁵⁵ Kozlowski, T.T., 1999. Soil Compaction and Growth of Woody Plants. *Scandinavian Journal of Forest Research*, Volume 14, Number 6. Taylor and Francis Ltd.
- ⁵⁶ Rummer, B.; Len, D.; and O'Brien, O. (2004). *Forest Residues Bundling Project-New Technology for Residue Removal*. USDA Forest Service, Southern Research Station
- ⁵⁷ Energy content of hardwood; www.eere.energy.gov/biomass/progs/search3.cgi?8828; Biomass Feedstock Composition and Property Database; Energy Efficiency and Renewable Energy, U.S. Department of Energy.

-
- ⁵⁸ Perlack, Robert D.; Biomass as Feedstocks for a Bioenergy and Bioproducts Industry: The Technical Feasibility of a Billion Ton Annual Supply; Sponsored by the U.S. Department of Energy and the U.S. Department of Agriculture; April 2005.
- ⁵⁹ Walsh, Marie E., U.S. Cellulosic Biomass Feedstock Supplies and Distribution; January 10, 2008.
- ⁶⁰ Data provided by e-mail by Perlack, Robert D., May 2008.
- ⁶¹ EPA. "Municipal Solid Waste Generation, Recycling, and Disposal in the United States: Facts and Figures for 2006," November 2007.
- ⁶² USEPA. "Methodology for Estimating Municipal Solid Waste Recycling Benefits," November 2007; See 2006 MSW Characterization Tables.
- ⁶³ Biocycle, "The State of Garbage in America," Vol. 47, No. 4, 2006, page 26.
- ⁶⁴ Midwest Assistance Program, Inc. "The 2006-2007 Missouri Municipal Solid Waste Composition Study," October, 2007.
- ⁶⁵ R. W. Beck, "Georgia Statewide Characterization Study," June 2005.
- ⁶⁶ Engineering Solutions and Design, Inc., "State of Ohio Waste Characterization Study," April 2004.
- ⁶⁷ NYC Department of Sanitation, "2004-2005 NYC Waste Characterization Study."
- ⁶⁸ R.W. Beck, "Statewide MSW Composition Study: A Study of Discards in the State of Minnesota," 2000.
- ⁶⁹ R.W. Beck, "Statewide Waste Composition Study: Pennsylvania State-wide Waste Composition," April 2003.
- ⁷⁰ DSM Environmental Services, Inc, "Vermont Waste Composition Study," June 2002.
- ⁷¹ R. W. Beck, "1992 Washington State Waste Characterization Study."
- ⁷² R. W. Beck, "Wisconsin Statewide Waste Characterization Study," May 2003.
- ⁷³ Department of Environmental Quality, "Oregon 2002 Waste Composition Study," 2002.
- ⁷⁴ Williams, Robert and California Biomass Collaborative, "Biofuels from Municipal Wastes- Background Discussion Paper," March 28, 2007.
- ⁷⁵ *Ibid.*
- ⁷⁶ Walsh, Marie, "U.S. Cellulosic Biomass Feedstock Supplies and Distribution," Unpublished Manuscript, January 10, 2008.
- ⁷⁷ NEOS Corporation. (1994). Urban tree residues: Results of the first national inventory. (Final Report). International Society of Arboriculture Research Trust. Allegheny Power Service Corporation and National Arborist Foundation. As cited in Walsh, Marie. (2008) U.S. Cellulosic Biomass Feedstock Supplies and Distribution. Unpublished Manuscript.
- ⁷⁸ USEPA, Construction and Demolition (C&D) Materials.
<http://www.epa.gov/osw/nonhaz/industrial/cd/basic.htm> Accessed August 10, 2008.
- ⁷⁹ Fehrs, J., "Secondary Mill Residues and Urban Wood Waste Quantities in the United States- Final Report," Northeast Regional Biomass Program Washington, D.C., December 1999.
- ⁸⁰ Wiltsee, G., "Urban Wood Waste Resource Assessment," Appel Consultant, Inc. Valencia, CA. November, 1998.
- ⁸¹ U.S Department of Energy. "Breaking the Biological Barriers to Cellulosic Ethanol: A Joint Research Agenda." (2006).
- ⁸² Kumar, A., & Sokhansanj, S., "Switchgrass (*Panicum virgatum*, L.) delivery to a biorefinery using integrated biomass supply analysis and logistics (IBSAL) model." *Bioresource Technology*, (2006).

-
- ⁸³ McLaughlin, S.B. & Adams Kszos, L., “Development of switchgrass (*Panicum virgatum*) as a bioenergy feedstock in the United States,” *Biomass and Bioenergy*, 28: 515-535, 2005.
- ⁸⁴ Kumar, *op. cit.*
- ⁸⁵ McLaughlin, *op. cit.*
- ⁸⁶ Lewandowski, I., Clifton-Brown, J.C., Scurlock, J.M.O., & Huisman, W., “Miscanthus: European experience with a novel energy crop,” *Biomass and Bioenergy*, 19: 209-227, 2000.
- ⁸⁷ Pyter, R., Voigt, T., Heaton, H., Dohleman, F., & Long, S. Growing giant miscanthus in Illinois. University of Illinois. (2006).
- ⁸⁸ *Ibid.*
- ⁸⁹ *Ibid.*
- ⁹⁰ Lewandowski, *op. cit.*
- ⁹¹ Pyter, *op. cit.*
- ⁹² Pyter, *op. cit.*
- ⁹³ Lewandowski, *op. cit.*
- ⁹⁴ Pyter, *op. cit.*
- ⁹⁵ U.S Department of Energy. “Breaking the Biological Barriers to Cellulosic Ethanol: A Joint Research Agenda,” 2006.
- ⁹⁶ *Ibid.*
- ⁹⁷ *Ibid.*
- ⁹⁸ Campbell, J.E. at al., ”The Global Potential of Bioenergy on aAbandoned Agriculture Lands,” *Environ. Sci. Technology*, 2008.
- ⁹⁹ *Ibid.*
- ¹⁰⁰ Adapted from additional information received from J. Elliot Campbell. “The Global Potential of Bioenergy on Abandoned Agriculture Lands,” *Environ. Sci. Technology*, 2008.
- ¹⁰¹ USDA, Farm Services Agency, “Conservation Reserve Program Summary and Enrollment Statistics,” FY 2007.
- ¹⁰² USDA, Farm Services Agency, “Conservation Reserve Program Statistics: Monthly Summary July 2008.”
- ¹⁰³ Pyter, *op. cit.*
- ¹⁰⁴ Based on plant capacities reported by the National Biodiesel Board, and data reported by F.O. Licht.
- ¹⁰⁵ Mueller, Steffen. An analysis of the projected energy use of future dry mill corn ethanol plants (2010-2030). October 10, 2007. Available at <http://www.chpcentermw.org/pdfs/2007CornEthanolEnergySys.pdf>
- ¹⁰⁶ “Essential Rendering”, published by the National Renderer’s Association, edited by David Meeker. 2006. Available at http://nationalrenderers.org/assets/essential_rendering_book.pdf
- ¹⁰⁷ “Statewide Feasibility Study for a Potential New York State Biodiesel Industry”, prepared by LECG, LLC. Report number 04-02, April 2004. Available at <http://www.nyserda.org/publications/biodieselreport.pdf>
- ¹⁰⁸ A copy of this letter is available in the docket.
- ¹⁰⁹ Jongschaap, R.E.E, W.J. Corre, P.S Bindraban, and W.A. Brandenburg, “Claims and Facts on *Jatropha curcas* L,” *Plant Research International*, Vers. Report 158, Oct. 2007.
- ¹¹⁰ Euler, Hartlieb, and David Gorriz, “Case Study "Jatropha Curcas"" *Rep. No. Global Facilitation Unit for Underutilized Species*, Frankfurt, 2004.

-
- ¹¹¹ Kumar, Sujeet., "Jatropha harmful for kids, soil and aquatic life: scientist," *India eNews*, May 2008.
- ¹¹² Jongschaap, *op. sit.*
- ¹¹³ *Ibid.*
- ¹¹⁴ Fairless, Daemon. "The little shrub that could - maybe." *Nature* 449 (2007): 652-55.
- ¹¹⁵ Francis, G., R. Edinger, and K. Becker. "A concept for simultaneous wasteland reclamation, fuel production, and socio-economic development in degraded areas in India: need, potential and perspectives of Jatropha plantations." *Natural Resources Forum* 29 (2005): 12-24. As sited in Jongschaap, R.E.E, W.J. Corre, P.S Bindraban, and W.A. Brandenburg, "Claims and Facts on Jatropha curcas L," *Plant Research International*, Vers. Report 158, Oct. 2007.
- ¹¹⁶ Woltjer, Lyanne. Size does matter. Expertise Centrum voor Duurzame Ontwikkeling (ECDO). Dec. 2006.
- ¹¹⁷ Jongschaap, *op. sit.*
- ¹¹⁸ Li Guo, T. "The photosynthesis and water use efficiency of eight garden tree species." *Forest Research* 15 (2002): 291-96. As sited in Jongschaap, R.E.E, W.J. Corre, P.S Bindraban, and W.A. Brandenburg, "Claims and Facts on Jatropha curcas L," *Plant Research International*, Vers. Report 158, Oct. 2007.
- ¹¹⁹ Jongschaap, *op. sit.*
- ¹²⁰ Fairless, *op. sit.*
- ¹²¹ Jongschaap, *op. sit.*
- ¹²² Ghosh, A., J.S. Patolia, D.R. Chaudharry, J. Chikara, S.N. Rao D. Kumar, G.N. Boricha, and A. Zala. Response of Jatropha curcas under different spacing to Jatropha de-oiled cake. Discipline of Phytosalinity, Central Salt and Marine Chemicals Research Institute. 2007.
- ¹²³ Jongschaap, *op. sit.*
- ¹²⁴ *Ibid.*
- ¹²⁵ Chaudharry, D.R., J.S. Patolia, A. Ghosh, J. Chikara, G.N. Boricha, and A. Zala. Changes in soil characteristics and foliage nutrient content in Jatropha curcas plantations in relation to stand density in Indian wasteland. Expert seminar on Jatropha curcas L. Agronomy and Genetics. Mar. 2007. As sited in Jongschaap, R.E.E, W.J. Corre, P.S Bindraban, and W.A. Brandenburg, "Claims and Facts on Jatropha curcas L," *Plant Research International*, Vers. Report 158, Oct. 2007.
- ¹²⁶ Jongschaap, *op. sit.*
- ¹²⁷ *Ibid.*
- ¹²⁸ Francis, *op. sit.*
- ¹²⁹ Jongschaap, *op. sit.*
- ¹³⁰ *Ibid.*
- ¹³¹ Kumar, *op. sit.*
- ¹³² Jongschaap, *op. sit.*
- ¹³³ Sharma, N., and A. Sarraf. Plantation management: activities/labour costs. Expert seminar on Jatropha curcas L. Agronomy and Genetics. Mar. 2007. As sited in Jongschaap, R.E.E, W.J.

Corre, P.S Bindraban, and W.A. Brandenburg, "Claims and Facts on *Jatropha curcas* L.," *Plant Research International*, Vers. Report 158, Oct. 2007.

¹³⁴ Jongschaap, *op. sit.*

¹³⁵ Fairless, *op. sit.*

¹³⁶ Francis, *op. sit.*

¹³⁷ Jongschaap, *op. sit.*

¹³⁸ Euler, *op. sit.*

¹³⁹ Woltjer, Lyanne, "Size does matter," Expertise Centrum voor Duurzame Ontwikkeling (ECDO), December 2006.

¹⁴⁰ Jongschaap, *op. sit.*

¹⁴¹ Euler, *op. sit.*

¹⁴² Jongschaap, *op. sit.*

¹⁴³ Francis, *op. sit.*

¹⁴⁴ *Ibid.*

¹⁴⁵ Pant, K.S., V. Khosla, D. Kumar, and S. Gairola, "Seed oil content variation in *Jatropha curcas* Linn. in different altitudinal ranges and site conditions in H.P. India," *Lyonia* 11 (2006): 31-34.

¹⁴⁶ Pant, *op. sit.*

¹⁴⁷ Jongschaap, *op. sit.*

¹⁴⁸ *Ibid.*

¹⁴⁹ Woltjer, *op. sit.*

¹⁵⁰ Achten, W., E. Mathijs, L. Verchot, V.P. Singh, and B. Muys, "Bio-diesel from *Jatropha*: the life-cycle perspective," Expert seminar on *Jatropha curcas* L. *Agronomy and Genetics*. March 2007. As sited in Jongschaap, R.E.E, W.J. Corre, P.S Bindraban, and W.A. Brandenburg, "Claims and Facts on *Jatropha curcas* L.," *Plant Research International*, Vers. Report 158, Oct. 2007.

¹⁵¹ Muys, B., W. Achten, E. Mathijs, V.P. Singh, and L. Verchot, "Life cycle inventory of biodiesel production from *Jatropha*," Expert seminar on *Jatropha curcas* L. *Agronomy and Genetics*. March 2007. As sited in Jongschaap, R.E.E, W.J. Corre, P.S Bindraban, and W.A. Brandenburg, "Claims and Facts on *Jatropha curcas* L.," *Plant Research International*, Vers. Report 158, Oct. 2007.

¹⁵² Jongschaap, *op. sit.*

¹⁵³ Fairless, *op. sit.*

¹⁵⁴ Francis, *op. sit.*

¹⁵⁵ USDA, "PLANTS Profile for *Jatropha curcas* L." USDA Natural Resources Conservation Service. <http://plants.usda.gov/java/profile?symbol=jacu2>, November 3, 2008.

¹⁵⁶ Jongschaap, *op. sit.*

-
- ¹⁵⁷ Oregon Climate Service, "State Annual Precip Maps," <http://www.ocs.oregonstate.edu>., November 3, 2008.
- ¹⁵⁸ Carney, Dan. "Second-generation biodiesel." *Automotive Engineering*, May 2008: 20-22.
- ¹⁵⁹ Francis, *op. sit.*
- ¹⁶⁰ Euler, *op. sit.*
- ¹⁶¹ Sheehan, John, Terri Dunahay, John Benemann, and Paul Roessler, "A Look Back at the U.S. Department of Energy's Aquatic Species Program—Biodiesel from Algae," National Renewable Energy Laboratory. Office of Fuels Development. Golden, Colorado, 1998.
- ¹⁶² *Ibid.*
- ¹⁶³ Wagner, Leonard, "Biodiesel from Algae Oil," Mora Associates, July 2007.
- ¹⁶⁴ National Renewable Energy Laboratory, "Chevron and NREL to Collaborate on Research to Produce Transportation Fuels using Algae." Press release. Oct. 31 2007.
- ¹⁶⁵ Chisti, Yusuf, "Biodiesel from Microalgae." *Biotechnology Advances* 25, 294-306, 2007.
- ¹⁶⁶ Schenider, David, "Grow Your Own?" *American Scientist*, Sept.-Oct. 2006.
- ¹⁶⁷ Campbell, Matthew N., "Biodiesel: Algae as a Renewable Source for Liquid Fuel." *Guelph Engineering Journal*, 1, 2-7, 2008.
- ¹⁶⁸ Chisti, *op. sit.*
- ¹⁶⁹ Pienkos, Philip T., "The Potential for Biofuels from Algae," Algae Biomass Summit. San Francisco, CA. Nov. 15, 2007.
- ¹⁷⁰ Campbell, *op. sit.*
- ¹⁷¹ Pienkos, *op. sit.*
- ¹⁷² Campbell, *op. sit.*
- ¹⁷³ Sheehan, *op. sit.*
- ¹⁷⁴ Pienkos, *op. sit.*
- ¹⁷⁵ Campbell, *op. sit.*
- ¹⁷⁶ Putt, Ron. "Algae as a Biodiesel Feedstock," Nov. 20, 2007.
- ¹⁷⁷ Sheehan, *op. sit.*
- ¹⁷⁸ "Algae Bloom Again." *Nature*, 447, 520-21 2007.
- ¹⁷⁹ Deshayes, Pierre-Henry, "As planet swelters, are algae unlikely saviour?" *AFP*, July 10, 2008.
- ¹⁸⁰ Sheehan, *op. sit.*
- ¹⁸¹ Bullock, Cary, "Algae Corrals Carbon Dioxide," *EnergyBiz Magazine*, 68-70, Mar.-Apr. 2007.
- ¹⁸² Chisti, *op. sit.*
- ¹⁸³ Sheehan, *op. sit.*
- ¹⁸⁴ Chisti, *op. sit.*
- ¹⁸⁵ Schenider, *op. sit.*
- ¹⁸⁶ Campbell, *op. sit.*

-
- ¹⁸⁷ Pienkos, *op. sit.*
¹⁸⁸ Putt, *op. sit.*
¹⁸⁹ Chisti, *op. sit.*
¹⁹⁰ Campbell, *op. sit.*
¹⁹¹ Chisti, *op. sit.*
¹⁹² *Ibid.*
¹⁹³ Campbell, *op. sit.*
¹⁹⁴ Pienkos, *op. sit.*
¹⁹⁵ Chisti, Yusuf. *op. sit.*
¹⁹⁶ Wagner, *op. sit.*
¹⁹⁷ AlgaeLink, "Commercial Cultivation Plants," <http://www.algaelink.com>, November 3, 2008.
¹⁹⁸ Sapphire Energy, "Algae-Based Fuel Projected to Become Commercial-Ready in Three Years" http://www.sapphireenergy.com/press_release/11, April 16, 2009.
¹⁹⁹ Thurmond, Will, "Algae 2020: Biofuels Markets and Commercialization Outlook Webinar", Emerging Markets Online, March 10, 2009.
²⁰⁰ *Ibid.*
²⁰¹ "Low Cost Algae Production System Introduced." Energy-Arizona. <http://www.energy-arizona.org>., Aug. 28, 2007.
²⁰² Chisti, *op. sit.*
²⁰³ "Low Cost Algae Production System Introduced." Energy-Arizona. 28 Aug. 2007. <<http://www.energy-arizona.org>>.
²⁰⁴ Chisti, *op. sit.*
²⁰⁵ Pienkos, *op. sit.*
²⁰⁶ "PV Solar Radiation," Digital image. National Renewable Energy Laboratory. May 2004.
²⁰⁷ Bullock, *op. sit.*
²⁰⁸ Chisti, *op. sit.*
²⁰⁹ Schenider, *op. sit.*
²¹⁰ Campbell, *op. sit.*
²¹¹ Pienkos, *op. sit.*
²¹² Wagner, *op. sit.*
²¹³ Chisti, *op. sit.*
²¹⁴ Pienkos, *op. sit.*
²¹⁵ F.O. Licht's World Ethanol and Biofuels Report. Vol 6, No 11, p.203. Feb 15, 2008.
²¹⁶ *Ibid.*
²¹⁷ DTN Ethanol Center, "EU Biodiesel Feedstock Challenge," October 11, 2007, <http://www.dtnethanolcenter.com/index.cfm?show=10&mid=66&pid=27>
²¹⁸ World Biofuels: FAPRI 2008 Agricultural Outlook. <http://www.fapri.org/outlook2008/text/14Biofuels.pdf>, November 3, 2008.
²¹⁹ Biofuels Barometer. Geographic Information System: EurObserv'ER <http://www.eufores.org/index.php?id=29>, November 3, 2008.

-
- ²²⁰ EUROPA Press Release, “Stricter fuel standards to combat climate change and reduce air pollution,” Jan. 31, 2007.
- ²²¹ EU Press Release, “2782nd Council Meeting on Transport, Telecommunications, and Energy, February 15th, 2007, Brussels, Council of the European Union,”
<http://www.consilium.europa.eu/Newsroom>.
- ²²² Ministry of Mines and Energy, “The Brazilian Experience with Biofuels,” Presentation by Ricardo de Gusmao Dornelles, June 1, 2007.
- ²²³ EPE, “Plano Nacional de Energia 2030.” Presentation from Mauricio Tolmasquim, 2007.
- ²²⁴ Asian Palm Oil for Euro Biodiesel, 2005 as quoted in Ohga K. & Tatsuji K., “Biofuels Policies in Asia: Trade effects on World Agricultural and Biofuels Trade,” Presentation to USDA Agricultural Outlook Forum, March 2, 2007.
- ²²⁵ Ohga K. & Tatsuji K., “Biofuels Policies in Asia: Trade effects on World Agricultural and Biofuels Trade,” Presentation to USDA Agricultural Outlook Forum, March 2, 2007.
- ²²⁶ USDA FAS, “Gain Report. Indonesia Bio-Fuels Biofuels Annual 2007,” June 13, 2007.
- ²²⁷ USDA FAS, “Palm oil continues to dominate global consumption in 2006/2007,”
<http://www.fas.usda.gov/oilseeds/circular/2006/06-06/June06.pdf>
- ²²⁸ Dato’ Dr. Mohd. Basri Wahid, “Malaysian Palm Oil Board. Presentation: Technological Progress and Commercialization of Biodiesel in Malaysia.”
- ²²⁹ USDA FAS, “Gain Report. India Bio-fuels Annual 2007,” June 1, 2007.
- ²³⁰ Fairless, *op. sit.*
- ²³¹ Wright, M. and Brown, R. Comparative Economics of Biorefineries Based on the Biochemical and Thermochemical Platforms. *Biofuels, Bioprod. Bioref.* 1:49-56 (2007)
- ²³² Kline, K. et. al. Biofuel Feedstock Assessment for Selected Countries. Oak Ridge National Laboratory. February 2008.
- ²³³ National Renewable Energy Laboratory estimate based on biomass portion available at \$45-\$55/dry ton.. Using POLYSYS Policy Analysis System, Agricultural Policy Analysis Center, University of Tennessee. <http://www.agpolicy.org/polysys.html>. Accessed May 2008.
- ²³⁴ Milbrandt, A. (2005). “Geographic Perspective on the Current Biomass Resource Availability in the United States.” 70 pp.; NREL Report No. TP-560-39181
- ²³⁵ D. Montross, Associate Professor, Scott A. Shearer, Professor, Timothy S. Stombaugh, Associate Extension Professor, Stephen F. Higgins, Research Specialist, and Samuel G. McNeill, Associate Extension Professor, Department of Biosystems and Agricultural Engineering, University of Kentucky, Lexington, Kentucky; and Shahab Sokhansanj, Professor, Oak Ridge National Laboratory, Environmental Sciences Division, Oak Ridge, Tennessee, Corn Stover Availability and Collection Efficiency Using Typical Hay Equipment, This article is published with the approval of the Director of the Kentucky Agricultural Experiment Station and designated Paper No. 04-05-066. *Transactions of the ASABE*, Vol. 50(3): 705–711 – 2007 American Society of Agricultural and Biological Engineers, ISSN 0001–2351.
- ²³⁶ S. Sokhansanj, A. Turhollow, and R. Perlack, Oak Ridge National Laboratory, Tennessee, USA 37830, Stochastic Modeling of Costs of Corn Stover Costs Delivered to an Intermediate Storage Facility, Paper Number: 024190, Presented at: 2002 ASAE Annual International Meeting / CIGR XVth World Congress, Sponsored by ASAE and CIGR, Hyatt Regency Chicago, Chicago, Illinois, USA, July 28-July 31, 2002
- ²³⁷ Christopher T. Wright, Peter A. Pryfogle, Nathan A. Stevens, J. Richard Hess, Corey W. Radtke, Idaho National Laboratory, Idaho Falls, ID, USA, Value of Distributed Preprocessing of

Biomass Feedstocks to a Bioenergy Industry, Paper No: 066151, 2006 ASABE Annual International Meeting, Oregon Convention Center, Portland, Oregon, 9 - 12 July 2006

²³⁸ Kevin J. Shinnars, Professor of Agricultural Engineering, Ben N. Binversie, Graduate Research Assistant, Department of Biological Systems Engineering, University of Wisconsin, Madison, WI, Philippe Savoie, Research Scientist, Agriculture and Agri-Food Canada, Quebec, Canada; Harvest and Storage Of Wet and Dry Corn Stover As A Biomass Feedstock, Paper Number: 036088, 2003 ASAE Annual International Meeting
Riviera Hotel and Convention Center, Las Vegas, Nevada, USA, 27- 30 July 2003

²³⁹ ICM website, Ethanol Production Process,
http://www.icminc.com/ethanol/production_process (Supplemented with information provided by EPA's Region 7).

²⁴⁰ Renewable Fuels Association website, How Ethanol is Made: The Ethanol Production Process –Wet Milling, <http://www.ethanolrfa.org/resource/made>.

²⁴¹ POET website, Technology - BPX™, <http://www.poetenergy.com/learn/bpx.asp>.

²⁴² Kirkbride McElroy, Anduin , “Poet, ISU partner for BPX research,” *Ethanol Producer Magazine*, http://www.ethanol-producer.com/article.jsp?article_id=3770, March 2008.

²⁴³ Renewable Fuels Association, Annual Energy Outlook 2006
(http://www.ethanolrfa.org/objects/pdf/outlook/outlook_2006.pdf)

²⁴⁴ U.S. Environmental Protection Agency, Combined Heat & Power Partnership website, Basic Information, <http://www.epa.gov/chp/basic/index.html>.

²⁴⁵ Smeets, Edward, et. al. “Sustainability of Brazilian bio-ethanol”. August 2006

²⁴⁶ Saeman, J.F., *Kinetics of Wood Saccharification: Hydrolysis of Cellulose and Decomposition of Sugars in dilute Acid at High Temperature*, Industrial and Engineering Chemistry, 37(1): 43–52 (1945).

<http://pubs3.acs.org/acs/journals/toc.page?incoden=iechad&indecade=3&involume=37&inissue=1>

²⁴⁷ Harris, E.E., Beglinger, E., Hajny, G.J., and Sherrard, E.C., , Industrial and Engineering Chemistry, 37(1): 12–23 (1945)

<http://pubs3.acs.org/acs/journals/toc.page?incoden=iechad&indecade=3&involume=37&inissue=1>

²⁴⁸ DOE National Laboratories. “30x30 A Scenario for Supplying 30% of 2004 Motor Gasoline with Ethanol by 2030: A Production Scenario for Cellulosic Ethanol from Corn Stover,” June 23, 2006.

²⁴⁹ LaMonica, Martin. “Investor Vinod Khosla: Advanced biofuels are closer than you think”. Accessed at: http://www.news.com/8301-11128_3-9811702-54.html

²⁵⁰ DOE. “Biomass Program: ABC’s of Biofuels”. Accessed at:
http://www1.eere.energy.gov/biomass/abcs_biofuels.html#content

²⁵¹ Starch Hydrolysis; <http://www.bio-link.org/pdf/starch.pdf>

²⁵² Glossary of Biomass Terms, National Renewable Energy Laboratory, Golden, CO.
<http://www.nrel.gov/biomass/glossary.html>

²⁵³ Glossary of Biomass Terms, National Renewable Energy Laboratory, Golden, CO.
<http://www.nrel.gov/biomass/glossary.html>

²⁵⁴ Condensation and Hydrolysis; <http://www.biotopics.co.uk/as/disaccharideformation.html>

-
- ²⁵⁵ BlueFire Ethanol. "Review of Competing Processes," May 2006. Accessed at: http://www.bluefireethanol.com/images/Technology_Comparison_051206.ppt#295,1, 31 Musick Irvine, California 92618.
- ²⁵⁶ Stephanopoulos, Gregory, et. al., "Challenges in Engineering Microbes for Biofuels Production," *Science*, 315, 801, February 9, 2007.
- ²⁵⁷ Dipardo, Joseph, "Outlook for Biomass Ethanol Production and Demand," Energy Information Administration, 2002.
- ²⁵⁸ Aden, Andy, Ethanol Process Design and Economics Utilizing Co-current Dilute Acid Prehydrolysis and Enzymatic Hydrolysis for Corn Stover, Contract DE-AC36-99-GO10337, National Renewable Energy Laboratory, June 2002.
- ²⁵⁹ Kim S, Holtzapple MT., "Effect of Structural Features on Enzyme Digestibility of Corn Stover," *Bioresource Technology*, 97: 583-591, 2006. As cited in Gray, Kevin, et. al., "Bioethanol," *Current Opinion in Chemical Biology*, 10:141-146, 2006.
- ²⁶⁰ A. Aden, M. Ruth, K. Ibsen, J. Jechura, K. Neeves, J. Sheehan, and B. Wallace National Renewable Energy Laboratory (NREL); L. Montague, A. Slayton, and J. Lukas Harris Group, Seattle, Washington, Ethanol Process Design and Economics Utilizing Co-Current Dilute Acid Prehydrolysis and Enzymatic Hydrolysis for Corn Stover; June 2002; NREL is a U.S. Department of Energy Laboratory Operated by Midwest Research Institute • Battelle • Bechtel; Contract No. DE-AC36-99-GO10337
- ²⁶¹ Graf, Angela, et. al., "Oregon Cellulose-Ethanol Study: An evaluation of the potential for ethanol production in Oregon using cellulose-based feedstocks," Bryan & Bryan Inc and Oregon Office of Energy, 2000.
- ²⁶² Tim Eggeman, Neoterics International, Lakewood, CO 80228, USA, Richard T. Elander, National Renewable Energy Laboratory, Golden, CO 80401, USA, Process and economic analysis of pretreatment technologies, *Bioresource Technology* 96 (2005) 2019–2025
- ²⁶³ Gray, K., et. al., "Bioethanol," *Current Opinion in Chemical Biology*, 10:141-146, 2006.
- ²⁶⁴ Graf, *op. sit.*
- ²⁶⁵ DOE, "From Biomass to Biofuels: A Roadmap to the Energy Future." based on a workshop held in Rockville, MD, on December 7-9, 2005. As cited in Stephanopoulos, Gregory, et. al., "Challenges in Engineering Microbes for Biofuels Production," *Science*, 315, 801, February 9, 2007.
- ²⁶⁶ Presentations of K.C. McFarland (Novozymes) and G. Anderl (Genencor International) at the World Congress on Industrial Biotechnology and Bioprocessing, Orlando, FL, July 2006. As cited in Stephanopoulos, Gregory, et. al., "Challenges in Engineering Microbes for Biofuels Production," *Science*, 315, 801, February 9, 2007.
- ²⁶⁷ Genencor Launches First Ever Commercial Enzyme Product for Cellulosic Ethanol, Rochester, NY, World-Wire, October 22, 2007 Copyright © 2007,. All rights reserved. World-Wire is a resource provided by Environment News Service. <http://world-wire.com/news/0710220001.html>
- ²⁶⁸ Purdue yeast makes ethanol from agricultural waste more effectively, Purdue News, June 28, 2004 <http://www.purdue.edu/UNS/html4ever/2004/040628.Ho.ethanol.html>
- ²⁶⁹ Stephanopoulos, *op. sit.*
- ²⁷⁰ US. DOE. Technologies: Processing and Conversion. Accessed at: http://www1.eere.energy.gov/biomass/processing_conversion.html on October 28, 2008

²⁷¹ EERE, DOE, Thermochemical Conversion, & Biochemical Conversion, *Biomass Program Thermochemical R&D* .

http://www1.eere.energy.gov/biomass/thermochemical_conversion.html

http://www1.eere.energy.gov/biomass/biochemical_conversion.html

²⁷² Lin Wei, Graduate Research Assistant, Lester O. Pordesimo, Assistant Professor Willam D. Batchelor, Professor, Department of Agricultural and Biological Engineering, Mississippi State University, MS 39762, USA, Ethanol Production from Wood: Comparison of Hydrolysis Fermentation and Gasification Biosynthesis, Paper Number: 076036, Written for presentation at the 2007 ASABE Annual International Meeting. Minneapolis Convention Center, Minneapolis, MN, 17 - 20 June 2007

²⁷³ J. Phillips, "Different Types of Gasifiers and Their Integration with Gas Turbines," EPRI/Advanced Coal Generation,

<http://www.netl.doe.gov/technologies/coalpower/turbines/refshelf/handbook/1.2.1.pdf>, October 30, 2008.

²⁷⁴ Ciferno, Jared P., Benchmarking Biomass Gasification Technologies for Fuels, Chemicals and Hydrogen Production, National Energy Technology Laboratory, Department of Energy, June 2002.

²⁷⁵ S. Phillips, A. Aden, J. Jechura, and D. Dayton, National Renewable Energy Laboratory, Golden, Colorado 80401-3393, T. Eggeman, Neoterics International, Inc., Thermochemical Ethanol via Indirect Gasification and Mixed Alcohol Synthesis of Lignocellulosic Biomass, Technical Report, NREL/TP-510-41168, April 2007

²⁷⁶ BRI Energy Bioengineering Resources for Renewable Energy. "The Co-Production of Ethanol and Electricity From Carbon-based Wastes," A Report from BRI Energy, Inc. Regarding a New Technology That Addresses Multiple Energy and Waste Disposal Solutions, March 2006.

²⁷⁷ DOE EERE. "Biomass Program: Thermochemical Conversion of Corn Stover," April 2006. Accessed at: http://www1.eere.energy.gov/biomass/pdfs/thermochemical_stover.pdf.

²⁷⁸ S. Phillips, A. Aden, J. Jechura, and D. Dayton, National Renewable Energy Laboratory, Golden, Colorado 80401-3393, T. Eggeman, Neoterics International, Inc., Thermochemical Ethanol via Indirect Gasification and Mixed Alcohol Synthesis of Lignocellulosic Biomass, Technical Report, NREL/TP-510-41168, April 2007

²⁷⁹ DOE EERE Biomass Program. "Thermochemical Conversion Processes: Pyrolysis" http://www1.eere.energy.gov/biomass/thermochemical_processes.html, November 6, 2008.

²⁸⁰ Zeman, Nicholas, "Thermochemical Versus Biochemical," *Biomass Magazine*, June 2007.

²⁸¹ Information derived from staff-level communication with National Biodiesel Board personnel.

²⁸² "Tyson ConocoPhillips Venture in Jeopardy." The Morning News, article dated 9/26/08. <http://www.nwaonline.net/articles/2008/09/26/business/092708fuelcredits.txt>

²⁸³ October 6, 2008 article on Trading Markets website, "Groundbreaking Initiated for Unique Renewable Fuels Plant in Louisiana." Accessed October 6, 2008.

<http://www.tradingmarkets.com/.site/news/Stock%20News/1923604/>

²⁸⁴ "Tyson's Fats to Fuel Plant on Schedule." The Morning News, article dated 10/6/08.

<http://www.nwaonline.net/articles/2008/10/06/business/100708tysonfuelplant.txt>

²⁸⁵ Neste Oil website, accessed 10/10/2008.

<http://www.nesteoil.com/default.asp?path=1,41,539,7516,7522>

-
- ²⁸⁶ Renewable Fuels Association website, Historical U.S. Fuel Ethanol Production, <http://www.ethanolrfa.org/industry/statistics/#A>.
- ²⁸⁷ *Ibid*
- ²⁸⁸ Ethanol Producer Magazine website, Ethanol Plant Lists (Producing, Not Producing, Under Construction, Expansions), <http://www.ethanolproducer.com/plant-list.jsp>, Modified on April 14, 2008.
- ²⁸⁹ Renewable Fuels Association (RFA) website, Ethanol Biorefinery Locations, <http://www.ethanolrfa.org/industry/locations>, Updated on April 2, 2008.
- ²⁹⁰ *Ibid*.
- ²⁹¹ Ethanol Producer Magazine website, Ethanol Plant Lists (Producing, Not Producing, Under Construction, Expansions), <http://www.ethanolproducer.com/plant-list.jsp>, Modified on April 14, 2008.
- ²⁹² Renewable Fuels Association (RFA) website, Ethanol Biorefinery Locations, <http://www.ethanolrfa.org/industry/locations>, Updated on April 2, 2008.
- ²⁹³ Ministry of Agriculture in Brazil (MAPA), <http://www.agricultura.gov.br/> Accessed: April 3, 2009
- ²⁹⁴ F.O. Licht's, "World Ethanol Markets: The Outlook to 2015," pg. S-22 to S-23, 2006.
- ²⁹⁵ F.O. Licht's, "World Ethanol and Biofuels Report," Vol. 5, No. 22, July 23, 2007.
- ²⁹⁶ Agra FNP, "Sugar and Ethanol in Brazil: A Study of the Brazilian Sugar Cane, Sugar and Ethanol Industries," 2007.
- ²⁹⁷ Ministry of Mines and Energy, "The Brazilian Experience with Biofuels," Presentation by Ricardo de Gusmao Dornelles, June 1, 2007.
- ²⁹⁸ Agra FNP, *op. sit*.
- ²⁹⁹ ANFAVEA (Associação Nacional dos Fabricantes de Veículos Automotores Assessoria de Planejamento Econômico e Estatístico Indústria Automobilística Brasileira - Empresas Associadas). Internal Sales in Brazil 2008. <http://www.anfavea.com.br/tabelas2008.html>, April 9, 2009.
- ³⁰⁰ Ministerio da Agricultura, Pecuária E Abastecimento (MAPA), "Brazilian Ethanol Production," <http://www.agricultura.gov.br/pls/portal/docs/PAGE/MAPA/ESTATISTICAS/PRODUCAO/06-PROD.%20BR%20%20C1LCOOL.PDF>, April 9, 2009.
- ³⁰¹ Ewing, Elizabeth, "Pipeline Projects on Hold." *Ethanol Producer Magazine*, July 2008.
- ³⁰² Rothkopf, Garten, "A Blueprint for Green Energy in the Americas," 2006.
- ³⁰³ *Ibid*.
- ³⁰⁴ World Biofuels: FAPRI 2007 Agricultural Outlook; OECD-FAO Agricultural Outlook 2007-2016, 2007 (note: this was interpreted from a graph); Bioenergia: Liquid Biofuels, "18 Billion Liters a Year!" March 2007; Rothkopf, *op. sit*. (note: years 2007-2019 were interpreted from a graph); EPE, "Plano Nacional de Energia 2030," Presentation from Mauricio Tolmasquim, 2007 (note: years were interpreted from a graph); UNICA, "Sugarcane Industry in Brazil: Ethanol, Sugar, Bioelectricity" brochure, 2008.
- ³⁰⁵ Agra FNP, *op. sit*.
- ³⁰⁶ Carpenter, Claudia, "Sugar Gains Capped by Brazil Ethanol Expansion, Czarnikow Says," *Bloomberg*, June 19, 2008.
- ³⁰⁷ F.O. Licht GmbH, "89 New Ethanol Facilities to Come Online in 2007-11 – BNDES," *F.O. Licht's World Ethanol & Biofuels Report*, Vol. 5, No. 22, July 23, 2007.

-
- ³⁰⁸ AFP, “Brazil says biofuel production not to blame for food crisis,” June 1, 2008.
- ³⁰⁹ Business News Americas, “Odebrecht to invest US\$2.6 bn to Lead Ethanol Sector – Brazil,” June 28, 2007.
- ³¹⁰ The Wall Street Journal, “ADM Plans Entry Into Sugar-Cane Ethanol in Brazil,” June 22, 2007.
- ³¹¹ Agra FNP, *op. sit.*
- ³¹² Petrobras Magazine No. 122. “Ethanol: From Brazil to the World,” August 13, 2007.
- ³¹³ *Ibid.*
- ³¹⁴ World Energy: Global News Summary. Published June 13, 2008, <http://www.worldenergy.net>
- ³¹⁵ Ewing, *op. sit.*
- ³¹⁶ Rothkopf, *op. sit.*
- ³¹⁷ *Ibid.*
- ³¹⁸ F.O. Licht GmbH. “Ethanol Blend Rose to 25% on July 1, 2007,” *F.O. Licht’s World Ethanol & Biofuels Report*, Vol. 5, No. 21, July 9, 2007.
- ³¹⁹ Petrobras Magazine No. 122, *op. sit.*
- ³²⁰ Agra FNP, *op. sit.*
- ³²¹ F.O. Licht GmbH. “Sobering Times for Biofuels in Seville,” *F.O. Licht’s World Ethanol & Biofuels Report*, Vol. 5, No. 20, June 19, 2007. (note: only 2006, 2015 & 2025 values were reported, other values are interpolated); World Biofuels: FAPRI 2007 Agricultural Outlook; EPE, *op. sit.* (note: years were interpreted from a graph); UNICA, “Sugarcane Industry in Brazil: Ethanol, Sugar, Bioelectricity” brochure, 2008.
- ³²² Ewing, *op. sit.*
- ³²³ Walter, A. et. al., “Perspectives on Fuel Ethanol Consumption and Trade,” *Biomass and Bioenergy*, 32, 730-748, 2008.
- ³²⁴ AFP., “EU Deputies Seek to Limit Use of Biofuels,” September 11, 2008.
- ³²⁵ Energy Information Administration (EIA), “Reference Case Projections by End-Use Sector and Region Data Table F6,” *International Energy Outlook 2007*, <http://www.eia.doe.gov/oiaf/archive/ieo07/ieonuclear.html>
- ³²⁶ BP, “BP Statistical Review of World Energy 2007 (revised with 2008 statistics) Historical Data,” <http://www.bp.com/statisticalreview>.
- ³²⁷ Walter, A., *op. sit.*
- ³²⁸ Ayoub PM. Biofuels for Shell-biomass based blending components for transport fuels (gasoline and diesel). In: World biofuels symposium-China, Beijing, 2006. As sited in Walter, *op. sit.*
- ³²⁹ Ribeiro, F., “The New European Challenge for Brazilian Ethanol Exports,” *Frost & Sullivan Market Insight*, February 7, 2008.
- ³³⁰ European Bioethanol Fuel Association (eBio), “The EU market: Production and Consumption,” <http://www.ebio.org/EUmarket.php>, April 9, 2009.
- ³³¹ European Bioethanol Fuel Association (eBio), “Production Capacity Installed” and “Production Capacity Under Construction,” <http://www.ebio.org/statistics.php?id=5> and <http://www.ebio.org/statistics.php?id=6>, April 9, 2009.
- ³³² F.O. Licht GmbH. “Sobering Times for Biofuels in Seville,” *F.O. Licht’s World Ethanol & Biofuels Report*, Vol. 5, No. 20, June 19, 2007.
- ³³³ Fukuda, Hisao, et. al., “Japan Bio-fuels Production Report,” USDA, FAS, May 26, 2006. <http://www.fas.usda.gov/gainfiles/200605/146197881.pdf>

-
- ³³⁴ Rothkopf, *op. sit.*
- ³³⁵ Fukuda, *op. sit.*
- ³³⁶ *Ibid.*
- ³³⁷ Rothkopf, *op. sit.*
- ³³⁸ Jolly, Lindsay, “World Fuel Ethanol Outlook: Can ethanol be traded globally in a large proportion?,” International Sugar Organization, Presentation to 9th World Beet and Cane Growers Conference, 9-12 July 2007.
- ³³⁹ Rothkopf, *op. sit.*
- ³⁴⁰ *Ibid.*
- ³⁴¹ Ferreira, Lenilson, “Brazil Priming Ethanol Initiative to Supply Fuel-Thirsty Japan,” *The Japan Times*, August 22, 2007. <http://search.japantimes.co.jp/print/nb20070822a3.html>
- ³⁴² Ewing, *op. sit.*
- ³⁴³ Fukuda, *op. sit.*
- ³⁴⁴ Rothkopf, *op. sit.*
- ³⁴⁵ *Ibid.*
- ³⁴⁶ F.O. Licht GmbH. “2006/07 Fuel Ethanol Consumption Seen at Merely 250 Mln Litres – USDA Attaché,” *F.O. Licht’s World Ethanol & Biofuels Report*, Vol. 5, No. 20, June 19, 2007.
- ³⁴⁷ Nayak, D., “Weak Crude, Cane Shortage Hit India Ethanol Expansion” *Wall Street Journal*, April, 1, 2009.
- ³⁴⁸ Regaldo, Antonio, et. al., “Ethanol Giants Struggle to Crack Brazil Market,” *Wall Street Journal*, September 10, 2007.
- ³⁴⁹ *Ibid.*
- ³⁵⁰ Renewable Fuels Association (RFA), “2007 World Fuel Ethanol Production, ” <http://www.ethanolrfa.org/industry/statistics/#E>, November 10, 2008.
- ³⁵¹ Ohga K. & Tatsuji K. Biofuels Policies in Asia: Trade effects on World Agricultural and Biofuels Trade. Presentation to USDA Agricultural Outlook Forum, March 2, 2007.
- ³⁵² Interfax China, “Biofuel Increasing China’s Corn Imports,” December 1, 2006.
- ³⁵³ Ohga, *op. sit.*
- ³⁵⁴ F.O. Licht GmbH, “New Ethanol Plants Will Rely on Non-Grain Feedstocks,” *F.O. Licht’s World Ethanol & Biofuels Report*, Vol. 5, No. 22, July 23, 2007.
- ³⁵⁵ Rothkopf, *op. sit.*
- ³⁵⁶ AFX News Limited, Forbes, “China to Freeze Approvals for Corn Processing Projects for 3 Years,” September 21, 2007. <http://www.forbes.com/markets/feeds/afx/2007/09/21/afx4142281.html>
- ³⁵⁷ F.O. Licht GmbH, “New Ethanol Plants Will Rely on Non-Grain Feedstocks,” *F.O. Licht’s World Ethanol & Biofuels Report*, Vol. 5, No. 22, July 23, 2007.
- ³⁵⁸ Rothkopf, *op. sit.*
- ³⁵⁹ Ohga, *op. sit.* Note: Metric Tons are assumed to be of ethanol and values are converted to ethanol volumes based on the density of ethanol and other conversion factors.
- ³⁶⁰ Rothkopf, *op. sit.*
- ³⁶¹ *Ibid.*
- ³⁶² *Ibid.*
- ³⁶³ F.O. Licht GmbH, “New Ethanol Plants Will Rely on Non-Grain Feedstocks,” *F.O. Licht’s World Ethanol & Biofuels Report*, Vol. 5, No. 22, July 23, 2007.
- ³⁶⁴ Rothkopf, *op. sit.*

-
- ³⁶⁵ EIA, "U.S. Oxygenates: Fuel Ethanol Imports," Last updated on October 10, 2008.
http://tonto.eia.doe.gov/dnav/pet/pet_move_impcus_a2_nus_EPOOXE_im0_mbb1_m.htm
- ³⁶⁶ Joseph, Ken, "Argentina Bio-Fuels Argentine Bio-Fuels Report 2007," USDA, FAS, May 21, 2007. <http://www.fas.usda.gov/gainfiles/200706/146291490.pdf>
- ³⁶⁷ Deborah O'Connell, et. al., "Biofuels in Australia - Issues and Prospects. A Report for the Rural Industries Research and Development Corporation," CSIRO Australian Government Rural Industries Research and Development Corporation, May 2007.
- ³⁶⁸ Roberts, Greg, "Rees scraps biofuel mandates," *The Australian: Online Newspaper of the Year*, September 20, 2008. <http://www.theaustralian.news.com.au/story/0,25197,24373888-11949,00.html>
- ³⁶⁹ Sobolik, Jessica, "Canadian Government Passes Renewable Fuels Standard," *Ethanol Producer Magazine*, August 2008.
- ³⁷⁰ Pinzon, L., "Colombia Bio-fuels Annual 2007," USDA, FAS, June 1, 2007.
<http://www.fas.usda.gov/gainfiles/200706/146291386.pdf>
- ³⁷¹ Chavez, L., et. al., "Mexico Bio-fuels Annual Report 2007," USDA, FAS, June 12, 2007.
<http://www.fas.usda.gov/gainfiles/200706/146291366.pdf>
- ³⁷² F.O. Licht's, "World Ethanol Markets: The Outlook to 2015," pg. S-18 to S-20, 2006.
- ³⁷³ Office of the United States Trade Representative (USTR), "Caribbean Basin Initiative," November 12, 2008.
http://www.ustr.gov/Trade_Development/Preference_Programs/CBI/Section_Index.html
- ³⁷⁴ Bryan, Tom, "Entering Tariff-Free," *Ethanol Producer Magazine*, January 2004.
- ³⁷⁵ Office of the United States Trade Representative (USTR), "Ethanol Provisions in the CAFTA-DR," July 2007.
- ³⁷⁶ Bryan, *op. cit.*
- ³⁷⁷ Rapoza, Kenneth, "UPDATE: Tax Loophole Helps US Import Ethanol 'Duty Free' - ED&F," *INO News, Dow Jones Newswires*, March 2008. <http://news.ino.com/>
- ³⁷⁸ Peter Rhode, "Senate Finance May Take Up Drawback Loophole As Part of Energy Bill," *EnergyWashington Week*, April 18, 2007. As cited in Yacobucci, Brent, "Ethanol Imports and the Caribbean Basin Initiative," CRS Report for Congress, Order Code RS21930, Updated March 18, 2008.
- ³⁷⁹ Perkins, Jerry, "BRAZIL: Loophole Hurt U.S. Ethanol Prices," *DesMoinesRegister.com*, October 18, 2007.
- ³⁸⁰ Public Law Version 6124 of the Farm Bill. 2008.
http://www.usda.gov/documents/Bill_6124.pdf
- ³⁸¹ Lundell, Drake, "Brazilian Ethanol Export Surge to End; U.S. Customs Loophole Closed Oct. 1," *Ethanol and Biodiesel News*, Issue 45, November 4, 2008.
- ³⁸² MacDonald, T., et. al., "Ethanol Supply Outlook for California," California Energy Commission, October 2003. <http://www.ethanolrfa.org/objects/documents/100/castaffreport.pdf>
- ³⁸³ Petrojam Limited, "Official Opening of Petrojam Ethanol Limited," November 12, 2008.
http://www.pcj.com/petrojam/whats_new.htm
- ³⁸⁴ Petrojam Limited, "About Us," November 12, 2008.
http://www.petrojambunkering.com/petrojam_aboutb.htm
- ³⁸⁵ F.O. Licht GmbH, "Company News- JBG Commences Fuel Ethanol Production," *F.O. Licht's World Ethanol & Biofuels Report*, Vol. 5, No. 22, July 23, 2007.
- ³⁸⁶ Email Correspondence with Jeffrey Tuite, ED&F Man, September 6, 2007.

-
- ³⁸⁷ Yacobucci, Brent, “Ethanol Imports and the Caribbean Basin Initiative,” CRS Report for Congress, Order Code RS21930, Updated March 18, 2008.
- ³⁸⁸ Email Correspondence with Jeffrey Tuite, ED&F Man, September 6, 2007.
- ³⁸⁹ Ethanol Producer Magazine, “Ethanol Dehydration Facility to be Built in Trinidad,” December 2006.
- ³⁹⁰ Etter, Lauren, and Millman, Joel, “Ethanol Tariff Loophole Sparks a Boom in Caribbean Islands Build Plants To Process Brazil’s Fuel; Farm Belt Cries Foul,” *Wall Street Journal*, March 9, 2007.
- ³⁹¹ Homer, Louis, “Another Energy Sector Stimulus,” PetroleumWorld.com. November 22, 2006. <http://www.petroleumworldtrinidad.com/storytrini06112606.htm>
- ³⁹² Etter, *op. sit.*
- ³⁹³ Browne, J., “Angostura Launches US\$11m Ethanol Plant,” *The Trinidad Guardian*. August 6, 2004. <http://www.guardian.co.tt/archives/2004-08-06/business1.html>
- ³⁹⁴ Email Correspondence with Jeffrey Tuite, ED&F Man, September 6, 2007.
- ³⁹⁵ Ramjeet, Oscar, “Barbados to Build \$72 Million Ethanol Dehydration Plant,” Caribbean Net News, August 22, 2008.
- ³⁹⁶ Jamaica Gleaner News, “US\$36m Ethanol Plant for Barbados,” August 23, 2008. <http://www.jamaica-gleaner.com/gleaner/20080823/business/business1.html>
- ³⁹⁷ Email Correspondence with Jeffrey Tuite, ED&F Man, September 6, 2007.
- ³⁹⁸ Bryan, *op. sit.*
- ³⁹⁹ Etter, *op. sit.*
- ⁴⁰⁰ *Ibid.*
- ⁴⁰¹ Email Correspondence with Jeffrey Tuite, ED&F Man, September, 7, 2007.
- ⁴⁰² Etter, *op. sit.*
- ⁴⁰³ International Trade Commission 2005-2007 historical ethanol import data as reported by the Renewable Fuels Association, <http://www.ethanolrfa.org/industry/statistics/>
- ⁴⁰⁴ Communication from Douglas Newman, International Trade Commission to Doris Wu, EPA, May 20, 2008.
- ⁴⁰⁵ Energy Information Administration historical gasoline and ethanol import data: http://www.eia.doe.gov/oil_gas/petroleum/data_publications/company_level_imports/cli_historical.html
- ⁴⁰⁶ U.S. Department of Energy, “DOE Selects Six Cellulosic Ethanol Plants for Up to \$385 Million in Federal Funding” (Press Release & Attachments), <http://www.energy.gov/print/4827.htm>, February 28, 2007.
- ⁴⁰⁷ U.S. Department of Energy, “DOE Announces up to \$200 Million in Funding for Biorefineries” (Press Release), <http://www.energy.gov/print/5031.htm>, May 1, 2007.
- ⁴⁰⁸ U.S. Department of Energy, “U.S. Department of Energy Selects First Round of Small-Scale Biorefinery Projects for up to \$114 Million in Federal Funding” (Press Release & Attachments), <http://www.energy.gov/print/5903.htm>, January 29, 2008.
- ⁴⁰⁹ U.S. Department of Energy, “DOE Selects 3 Small-Scale Biorefinery Projects for up to \$86 Million of Federal Funding in Maine, Tennessee and Kentucky” (Press Release & Attachments), <http://www.energy.gov/print/6164.htm>, April 18, 2008.
- ⁴¹⁰ U.S. Department of Energy, “DOE to Provide up to \$40 Million in Funding for Small-Scale Biorefinery Projects in Wisconsin and Louisiana” (Press Release & Attachments), <http://www.energy.gov/print/6413.htm>, July 14, 2008.

-
- ⁴¹¹ U.S. Department of Energy, “DOE Announces Final Rule for Loan Guarantee Program” (Press Release), <http://www.energy.gov/print/5568.htm>, October 4, 2007.
- ⁴¹² U.S. Department of Energy, “DOE Selects Five Ethanol Conversion Projects for \$23 Million in Federal Funding” (Press Release), <http://www.energy.gov/print/4896.htm>, March 27, 2007.
- ⁴¹³ U.S. Department of Energy, “Energy and Agriculture Depts. Provide \$8.3 Million in Funding for Biofuels Research” (Press Release), <http://www.energy.gov/print/5115.htm>, June 7, 2007.
- ⁴¹⁴ U.S. Department of Energy, “Energy Department Selects Three Bioenergy Research Centers for \$375 Million in Federal Funding” (Press Release & Attachments), <http://www.energy.gov/print/5172.htm>, June 26, 2007.
- ⁴¹⁵ U.S. Department of Energy, “Department of Energy to Invest up to \$7.7 Million for Four Biofuels Projects” (Press Release), <http://www.energy.gov/print/5757.htm>, December 4, 2007.
- ⁴¹⁶ U.S. Department of Energy, “U.S. Department of Energy to Invest up to \$33.8 Million to Further Development of Commercially Viable Renewable Fuels” (Press Release), <http://www.energy.gov/print/6015.htm>, February 26, 2008.
- ⁴¹⁷ U.S. Department of Energy, “USDA, DOE to Invest up to \$18.4 Million for Biomass Research, Development and Demonstration Projects” (Press Release), <http://www.energy.gov/print/6035.htm>, March 4, 2008.
- ⁴¹⁸ U.S. Department of Energy, Energy Efficiency and Renewable Energy website, Ethanol Incentives & Laws, http://www.eere.energy.gov/afdc/ethanol/incentives_laws.html, State Data Downloaded in July 2008.
- ⁴¹⁹ Midwest Governors Association, “Energy Security and Climate Stewardship Platform for the Midwest 2007,” <http://www.midwesterngovernors.org/resolutions/Platform.pdf>, Published November 2007.
- ⁴²⁰ 110th Congress of the United States of America, Second Session, *The Food, Conservation, and Energy Act of 2008, House Rule 6124*, http://www.usda.gov/documents/Bill_6124.pdf, Introduced on January 3, 2008 and Enacted on June 18, 2008.
- ⁴²¹ Archer Daniels Midland, “Joint ADM and Purdue University Cellulosic Ethanol Project Selected for Funding by U.S. Department of Energy” (Press Release), http://www.admworld.com/naen/pressroom/newspopup.asp?id=454&name=Joint_Cellulosic_Ethanol_Project, April 16, 2007.
- ⁴²² Archer Daniels Midland, “ADM, Deere, Monsanto to Collaborate on Corn Stover Research” (Press Release), <http://www.admworld.com/naen/pressroom/newspopup.asp?id=517>, August 26, 2008.
- ⁴²³ POET, “Iowa finalizes cellulosic partnership with POET” (Press Release), <http://www.renewableenergyworld.com/rea/partner/poet-7042/news/article/2009/02/iowa-finalizes-cellulosic-partnership-with-poet>
- ⁴²⁴ Elbehri, Aziz. USDA, ERS. “An Evaluation of the Economics of Biomass Feedstocks: A Synthesis of the Literature. Prepared for the Biomass Research and Development Board,” 2007; Since 2007, a final report has been released. Biomass Research and Development Board., “The Economics of Biomass Feedstocks in the United States: A Review of the Literature,” October 2008.
- ⁴²⁵ Graham, R.L., “Current and Potential U.S. Corn Stover Supplies,” *American Society of Agronomy* 99:1-11, 2007.
- ⁴²⁶ Wilhelm, W.W. et. al., “Corn Stover to Sustain Soil Organic Carbon Further Constrains Biomass Supply,” *Agron. J.* 99:1665-1667, 2007.

-
- ⁴²⁷ NASS database. <http://www.nass.usda.gov/>
- ⁴²⁸ Smith, W. Brad et. al., "Forest Resources of the United States, 2002 General Technical Report NC-241," St. Paul, MN: U.S. Dept. of Agriculture, Forest Service, North Central Research Station, 2004.
- ⁴²⁹ USDA-Forest Service. "Timber Products Output Mapmaker Version 1.0." 2004.
- ⁴³⁰ NASS database. <http://www.nass.usda.gov/>
- ⁴³¹ USDA, WGA, Bioenergy Strategic Assessment project findings upcoming as noted in report WGA. Transportation Fuels for the Future Biofuels: Part I. 2008.
- ⁴³² Industry data for 2008 taken from National Biodiesel Board fact sheets at http://www.biodiesel.org/buyingbiodiesel/producers_mapmakers/Producers%20Map-Existing.pdf and http://www.biodiesel.org/pdf_files/fuelfactsheets/Production_graph_slide.pdf (both accessed April 27, 2009).
- ⁴³³ "Tyson ConocoPhillips Venture in Jeopardy." The Morning News, article dated 9/26/08. <http://www.nwaonline.net/articles/2008/09/26/business/092708fuelcredits.txt>
Press release and project timeline on Syntroleum website, updated January 13, 2009 (http://www.syntroleum.com/dynamic_fuels_plant09.aspx), accessed April 27, 2009. <http://www.tradingmarkets.com/.site/news/Stock%20News/1923604/>
- ⁴³⁵ "Tyson's Fats to Fuel Plant on Schedule." The Morning News, article dated 10/6/08. <http://www.nwaonline.net/articles/2008/10/06/business/100708tysonfuelplant.txt>
- ⁴³⁶ Syntroleum Investor Presentation, March 2008. Accessed October 6, 2008. <http://www.syntroleum.com/pdf/InvestorPresentation.pdf>
- ⁴³⁷ "Ethanol Transportation Backgrounder, Expansion of U.S. Corn-based Ethanol from the Agricultural Transportation Perspective", USDA, September 2007, <http://www.ams.usda.gov/tmd/TSB/EthanolTransportationBackgrounder09-17-07.pdf>
- ⁴³⁸ Association of Oil Pipelines: <http://aopl.org/go/searchresults/888/?q=ethanol&sd=&ed=>. "Hazardous Liquid Pipelines Transporting Ethanol, Ethanol Blends, and Other Biofuels", Notice of policy statement and request for comment, Pipeline and Hazardous Materials Safety Administration, Department of Transportation, August 10, 2007, 72 FR 45002.
- ⁴³⁹ Article on the initiation of Kinder Morgan ethanol pipeline service between Tampa and Orlando Florida: http://www.ethanolproducer.com/article.jsp?article_id=5163
- ⁴⁴⁰ Magellan and Poet joint assessment of dedicated ethanol pipeline: http://www.magellanlp.com/news/2009/20090316_5.htm
- ⁴⁴¹ "Ethanol Transportation Backgrounder", U.S. Department of Agriculture, September 2007, <http://www.ams.usda.gov/AMSV1.0/getfile?dDocName=STELPRDC5063605&acct=atpub>
- ⁴⁴² "Analysis of Fuel Ethanol Transportation Activity and Potential Distribution Constraints", prepared for EPA by Oak Ridge National Laboratory, March 2009.
- ⁴⁴³ "Ethanol Transportation Backgrounder", U.S. Department of Agriculture, September 2007, <http://www.ams.usda.gov/AMSV1.0/getfile?dDocName=STELPRDC5063605&acct=atpub>

⁴⁴⁴ “The Importance of Adequate Rail Investment”, Association of American Railroads, http://www.aar.org/GetFile.asp?File_ID=150

⁴⁴⁵ American Association of State Highway and Transportation Officials (AASHTO) Freight-Rail Bottom-Line Report, 2003.

⁴⁴⁶ Association of American Railroads (AAR), National Rail Freight Infrastructure Capacity and Investment Study, September 2007.

⁴⁴⁷ “Barge Transportation in the United States”. Timothy Casey, Presentation at the MARE Forum USA, 2006, http://www.mareforum.com/ENERGY_TRANSPORTATION_USA_2006_PRESENTATIONS_files/CASEY.pdf

⁴⁴⁸ Energy Information Administration (EIA) historical company level ethanol and gasoline import data: http://www.eia.doe.gov/oil_gas/petroleum/data_publications/company_level_imports/cli_historical.html

⁴⁴⁹ “The U.S. Truck Driver Shortage: Analysis and Forecasts”, Prepared by Global Insights for the American Trucking Association, May 2005. <http://www.truckline.com/NR/rdonlyres/E2E789CF-F308-463F-8831-0F7E283A0218/0/ATADriverShortageStudy05.pdf>

⁴⁵⁰ “Renewable Fuel Standard Challenges Faced by Terminals”, Andrea Grant, Independent Fuel Terminal Operators Association, May, 13, 2008, presentation at the 2008 Society of Automotive Engineers Government-Industry Meeting.

⁴⁵¹ “Infrastructure Requirements for an Expanded Fuel Ethanol Industry”, Downstream Alternative Incorporated, January 15, 2002.

⁴⁵² A discussion of the estimated number of terminals that carry diesel fuel is contained in Chapter V of the Regulatory Impact Analysis to the final highway diesel fuel rule <http://www.epa.gov/otaq/highway-diesel/regs/ria-v.pdf>, EPA Docket A-99-06.

⁴⁵³ “Renewable Fuel Standard Challenges Faced by Terminals”, Andrea Grant, Independent Fuel Terminal Operators Association, May, 13, 2008, presentation at the 2008 Society of Automotive Engineers Government-Industry Meeting.

⁴⁵⁴ “Renewable Fuel Standard Challenges Faced by Terminals”, Andrea Grant, Independent Fuel Terminal Operators Association, May, 13, 2008, presentation at the 2008 Society of Automotive Engineers Government-Industry Meeting.

⁴⁵⁵ “Summary Data on Diesel Fuel Retailers”, Memorandum to the Docket, Jeffery Herzog, U.S. EPA, March 23, 2000, EPA Docket A-99-06, Docket Item II-B-07.

⁴⁵⁶ 2007 National Association of Convenience Stores State of the Industry survey data www.nacsonline.com as reported in the National Petroleum News MarketFacts 2007, October 2007.

⁴⁵⁷ “Diesel Throughput Volume by Percentage of Diesel Fuel Retailers”, Memorandum to the Docket, Jeffery Herzog, U.S. EPA, May 05, 2000, EPA Docket A-99-06, Docket Item II-B-14.

⁴⁵⁸ The National Ethanol Vehicle Coalition estimate of E85 refueling facilities is located at <http://www.e85refueling.com/estimates> <http://www.e85refueling.com/>

⁴⁵⁹ The “NEAR85” estimate of E85 retail facilities is located at <http://www.neare85.com/>

⁴⁶⁰ National Petroleum News, MarketFacts 2007, Volume 99, Number 10, October 2007, www.npnweb.com

⁴⁶¹ A discussion of Underwriter Laboratories (UL) requirements for E85 retail dispenser equipment entitled “Power-Operated Dispensing Devices for Gasoline/Ethanol Blends other than Gasohol (E10)” can be found at <http://ulstandardsinfont.com/outscope/0087A.html>

⁴⁶² U.S. Environmental Protection Agency, *Regulatory Impact Analysis: Renewable Fuel Standard*, EPA420 R-04-004, <http://www.epa.gov/otaq/renewablefuels/420r07004chap2.pdf>, April 2007 (Chapter 2, Table 2.2-6).

⁴⁶³ U.S. Environmental Protection Agency, *Regulation of Fuels and Fuel Additives: Renewable Fuel Standard Program, Final Rule*, 72 FR 23900, <http://www.epa.gov/otaq/renewablefuels/rfs-finalrule.pdf>, May 1, 2007.

⁴⁶⁴ U.S. Department of Energy, Energy Information Administration, *Monthly Energy Review*, <http://tonto.eia.doe.gov/FTP/ROOT/multifuel/mer/00350809.pdf>, September 2008 (Table 10.2b).

⁴⁶⁵ *ibid*

⁴⁶⁶ 110th Congress of the United States of America, Second Session, *The Food, Conservation, and Energy Act of 2008, House Rule 6124*, http://www.usda.gov/documents/Bill_6124.pdf, Introduced on January 3, 2008 and Enacted on June 18, 2008.

⁴⁶⁷ Kauffman, Tim, “Miles to go for Alternative Fuel,” *Federal Times*, June 23, 2008 (pp. 11, 14).

⁴⁶⁸ DOE Energy Efficiency and Renewable Energy August 2008 estimate (worksheet available at www.eere.energy.gov/afdc/data/index.html)

⁴⁶⁹ U.S. Department of Energy, Energy Information Administration, *Annual Energy Outlook 2007*, Reference Case Tables, <http://www.eia.doe.gov/oiaf/archive/aeo07/pdf/yearbyyear.pdf>, February 2007 (Table 17).

⁴⁷⁰ U.S. Department of Energy, Energy Information Administration, *Annual Energy Outlook 2007*, Reference Case Tables, <http://www.eia.doe.gov/oiaf/archive/aeo07/pdf/yearbyyear.pdf>, February 2007 (Table 2).

⁴⁷¹ U.S. Department of Energy, Energy Information Administration, *Annual Energy Outlook 2008*, Reference Case Tables, <http://www.eia.doe.gov/oiaf/aeo/excel/yearbyyear.xls>, June 2008 (Table 2).

⁴⁷² *Ibid*

⁴⁷³ National Ethanol Vehicle Coalition, 2008 Purchasing Guide for Flexible Fuel Vehicles.

⁴⁷⁴ *Ibid*

-
- ⁴⁷⁵ U.S. Department of Energy, Energy Efficiency and Renewable Energy, *Transportation Energy Book: Edition 26*, Prepared by Oak Ridge National Laboratory, ORNL-6978, 2007 (Table 2.5).
- ⁴⁷⁶ National Ethanol Vehicle Coalition, 2008 Purchasing Guide for Flexible Fuel Vehicles.
- ⁴⁷⁷ 110th Congress of the United States of America, Second Session, *The Open Fuel Standard Act of 2008, Senate Bill 3303*, <http://thomas.loc.gov/cgi-bin/query/z?c110:S.3303>, Introduced on July 22, 2008.
- ⁴⁷⁸ 110th Congress of the United States of America, Second Session, *The Open Fuel Standard Act of 2008, House Rule 6559*, <http://thomas.loc.gov/cgi-bin/bdquery/z?d110:H.R.6559>, Introduced on July 22, 2008.
- ⁴⁷⁹ U.S. Department of Energy, Energy Efficiency and Renewable Energy website, Ethanol Incentives & Laws, http://www.eere.energy.gov/afdc/ethanol/incentives_laws.html, State Data Downloaded in July 2008.
- ⁴⁸⁰ NEVC FYI Newsletter: Volume 15, Issue 5: March 9, 2009.
- ⁴⁸¹ National Petroleum News, *Market Facts 2007*, 2007 NPN Station Count (a), October 2007 (page 92).
- ⁴⁸² National Ethanol Vehicle Coalition, , *FYI Newsletter: Volume 13, Issue 10*, <http://www.e85fuel.com/news/072307fyi.htm>, July 23, 2007
- ⁴⁸³ U.S. Department of Energy, Energy Efficiency and Renewable Energy website, Ethanol Incentives & Laws, http://www.eere.energy.gov/afdc/ethanol/incentives_laws.html, State Data Downloaded in July 2008.
- ⁴⁸⁴ Midwest Governors Association, “Energy Security and Climate Stewardship Platform for the Midwest 2007,” <http://www.midwesterngovernors.org/resolutions/Platform.pdf>, Published November 2007.
- ⁴⁸⁵ 110th Congress of the United States of America, Second Session, *The E85 and Biodiesel Access Act of 2008, House Rule 6734*, http://www.e85fuel.com/legislation/hr_6734.doc, Introduced on July 31, 2008.
- ⁴⁸⁶ National Ethanol Vehicle Coalition, 2008 Purchasing Guide for Flexible Fuel Vehicles.
- ⁴⁸⁷ Based on average E85 and regular unleaded gasoline prices reported at <http://www.fuelgaugereport.com/> on April 23, 2009.
- ⁴⁸⁸ U.S. Department of Energy, Energy Information Administration, *Petroleum Marketing Annual 2006*, <http://tonto.eia.doe.gov/FTPROOT/petroleum/048706.pdf>, August 2007 (Table 31).
- ⁴⁸⁹ American Petroleum Institute, Gasoline Tax Report, http://www.api.org/statistics/fueltaxes/upload/October_2006_gasoline_and_diesel_summary_pages.pdf, October 2006.
- ⁴⁹⁰ Brownstone, D., Small, K.A., Valuing Time and Reliability: Assessing the Evidence from Road Pricing Demonstrations, Transportation Research Part A 39, 2005 (pages 293-279).
- ⁴⁹¹ Greene, David, Survey Evidence on the Importance of Fuel Availability to Choice of Alternative Fuels and Vehicles, Prepared by Oak Ridge National Laboratory, <http://ntl.bts.gov/lib/000/700/723/survey.pdf>, November 11, 1997.
- ⁴⁹² Based on May 2008 meeting with SIGMA/NACS.
- ⁴⁹³ National Petroleum News, *Market Facts 2007*, Branded Retail Outlets by Rank 2006, October 2007 (page 93).
- ⁴⁹⁴ Based on May 2008 meeting with SIGMA/NACS.

-
- ⁴⁹⁵ U.S. Department of Energy, Energy Information Administration, *Petroleum Marketing Annual 2006*, <http://tonto.eia.doe.gov/FTPROOT/petroleum/048706.pdf>, August 2007 (Table 48).
- ⁴⁹⁶ U.S. Department of Energy, Energy Information Administration, *Petroleum Marketing Annual 2006*, <http://tonto.eia.doe.gov/FTPROOT/petroleum/048706.pdf>, August 2007 (Tables 31, 34 & 48).
- ⁴⁹⁷ U.S. Environmental Protection Agency, *Draft Regulatory Impact Analysis: Control of Hazardous Air Pollutants from Mobile Sources*, EPA420 D-06-004, <http://www.epa.gov/otaq/regs/toxics/chapter9.pdf>, February 2006 (Chapter 9).
- ⁴⁹⁸ American Petroleum Institute, Gasoline Tax Report, http://www.api.org/statistics/fueltaxes/upload/January_2008_gasoline_and_diesel_summary_pages-2.pdf, January 2008.
- ⁴⁹⁹ Department of Energy, Alternative Fuels & Advanced Vehicles Data Center, Biodiesel Incentives and Laws. Accessed July 2008. http://www.afdc.energy.gov/afdc/fuels/biodiesel_laws.html
- ⁵⁰⁰ Energy Information Administration, 2005 Prime Supplier Sales Volumes for No. 2 Diesel. Accessed 10/7/2008. http://tonto.eia.doe.gov/dnav/pet/pet_cons_prim_a_EPD2D_P00_Mgalpd_a.htm
- ⁵⁰¹ Energy Information Administration, Fuel Oil and Kerosene Sales 2006, Table 16. 2005 data column used. http://www.eia.doe.gov/pub/oil_gas/petroleum/data_publications/fuel_oil_and_kerosene_sales/current/pdf/table16.pdf
- ⁵⁰² Clean Air Act Section 211(o)(1)
- ⁵⁰³ 2006 IPCC Guidelines for National Greenhouse Gas Inventories. 2006. Agriculture, Forestry and Other Land Uses. Volume 4. <http://www.ipcc-nggip.iges.or.jp/public/2006gl/vol4.html>
- ⁵⁰⁴ Curran MA, Mann M, Norris G, 2001, Report on the International Workshop on Electricity Data for Life Cycle Inventories, US Environmental Protection Agency, Cincinnati, USA
- ⁵⁰⁵ Ekvall T, Weidema BP, 2004, System boundaries and input data in consequential life cycle inventory analysis. *International Journal of Life Cycle Assessment*, 9, 161-171
- ⁵⁰⁶ Kloverpris et al., 2008, Conference and Workshop on Modeling Global Land Use Implications in the Environmental Assessment of Biofuels, *International Journal of Life Cycle Assessment*, 13(3) 178-183
- ⁵⁰⁷ Kloverpris, Wenzel and Nielsen, 2008, Life Cycle Inventory Modelling of Land Use Induced by Crop Consumption, *International Journal of Life Cycle Assessment*, 13(1): 13-21
- ⁵⁰⁸ Ekvall and Weidema 2004
- ⁵⁰⁹ Schmidt, 2008, System delimitation in agricultural consequential LCA, *International Journal of Life Cycle Assessment*, 13: 350-364
- ⁵¹⁰ Delucchi, M. 2005. Incorporating the Effect of Price Changes on CO₂-Equivalent Emissions from Alternative Fuel Lifecycles: Scoping the Issues. Working Paper UCD—ITS—RR—05—19. http://pubs.its.ucdavis.edu/publication_detail.php?id=62
- ⁵¹¹ Fargione, J., J. Hill, D. Tilman, S. Polasky, and P. Hawthorne. 2008. Land clearing and the biofuel carbon debt. *Science* 319 :1235–1238.
- ⁵¹² Searchinger, T., R. Heimlich, R.A. Houghton, F. Dong, A. Elobeid, J. Fabiosa, S. Tokgoz, D. Hayes, and T.-H. Yu. 2008. Use of U.S. croplands for biofuels increases greenhouse gases through emissions from land-use change. *Science* 319 :1238–1240.
- ⁵¹³ http://www.epa.gov/sequestration/greenhouse_gas.html
- ⁵¹⁴ Crutzen, P. J., Mosier, A. R., Smith, K. A., and Winiwarter, W.: N₂O release from agro-biofuel production negates global warming reduction by replacing fossil fuels, *Atmos. Chem. Phys.*, 8, 389-395, 2008.
- ⁵¹⁵ McCann, T., and Magee, P., Crude Oil Greenhouse Gas Life Cycle Analysis Helps Assign Values For CO₂ Emissions Trading. *Oil and Gas Journal*. Vol. 97, no. 8, pp. 38-44. Feb 1999.

- ⁵¹⁶ USGS (November 2006), "Natural Assessment of Oil and Gas Fact Sheet: Natural Bitumen Resources of the United States," Fact Sheet 2006-3133; USGS (August 2003), "Heavy Oil and Natural Bitumen – Strategic Petroleum Resources," Fact Sheet 70-03.
- ⁵¹⁷ EIA Form 814.
- ⁵¹⁸ International Energy Agency (March 14, 2006), *Oil Market Report: A Monthly Oil Market and Stocks Assessment*, www.oilmarketreport.org. pp. 18.
- ⁵¹⁹ Energy Information Administration, "Country Analysis Briefs," Venezuela Oil. <http://www.eia.doe.gov/emeu/cabs/Venezuela/Oil.html> (last viewed 6/18/2008).
- ⁵²⁰ Canadian Association of Petroleum Producers (May 2008), *Statistical Handbook for Canada's Upstream Petroleum Industry*.
- ⁵²¹ National Petroleum Council (2007), "Working Document of the NPC Global Oil & Gas Study" July 18, 2007, Topic Paper #22 Heavy Oil; California Annual Reports of the State Oil & Gas Supervisor, 2006, http://www.conservation.ca.gov/dog/pubs_stats/annual_reports/Pages/annual_reports.aspx (last viewed 6/18/2008).
- ⁵²² Energy Information Administration, 2005 data. http://tonto.eia.doe.gov/dnav/pet/pet_move_impcus_a2_nus_epc0_im0_mbb1_a.htm (last viewed 6/18/2008)
- ⁵²³ "N₂O release from agro-biofuel production negates global warming reduction by replacing fossil fuels" P.J. Crutzen, A.R. Mosier, K.A. Smith, and W. Winiwarter, *Atmospheric Chemistry and Physics*, 8, 389–395, 2008.
- ⁵²⁴ U.S. Environmental Protection Agency. 2005. *Inventory of U.S. Greenhouse Gas Emissions and Sinks: 1990–2003*. EPA 430-R-05-003. Available at <http://www.epa.gov/climatechange/emissions/downloads06/05CR.pdf>.
- ⁵²⁵ U.S. Environmental Protection Agency. 2005. *Inventory of U.S. Greenhouse Gas Emissions and Sinks: 1990–2003*. EPA 430-R-05-003. Available at <http://www.epa.gov/climatechange/emissions/downloads06/05CR.pdf>.
- ⁵²⁶ U.S. Environmental Protection Agency. 2005. *Inventory of U.S. Greenhouse Gas Emissions and Sinks: 1990–2003*. EPA 430-R-05-003. Available at <http://www.epa.gov/climatechange/emissions/downloads06/05CR.pdf>.
- ⁵²⁷ www.fao.org/ag/agl/fertistat/
- ⁵²⁸ <http://wds.iea.org/wds/default.aspx>
- ⁵²⁹ 2006 IPCC Guidelines for National Inventories, Chapter 11: N₂ Emissions from Managed Soils, and CO₂ Emissions from Lime and Urea Applications
- ⁵³⁰ International Rice Research Institute. www.iri.org. Last accessed: October 15, 2008.
- ⁵³¹ Ethanol Expansion in the United States How Will the Agricultural Sector Adjust? Paul C. Westcott, USDA ERS FDS-07D-01 May 2007.
- ⁵³² Technical Report, An Analysis of EPA Biofuel Scenarios with the CARD International Models, CARD Staff, October 2008.
- ⁵³³ Salil Arora, May Wu, and Michael Wang, "Update of Distillers Grains Displacement Ratios for Corn Ethanol Life-Cycle Analysis," September 2008. See <http://www.transportation.anl.gov/pdfs/AF/527.pdf>
- ⁵³⁴ The 2005 Food and Agriculture Organization (FAO) Global Forest Resources Assessment (FRA) is available at <http://www.fao.org/forestry/fra2005/en/>
- ⁵³⁵ <https://www.gtap.agecon.purdue.edu>
- ⁵³⁶ See Hertel, Thomas, Steven Rose, Richard Tol (eds.), (in press). *Economic Analysis of Land Use in Global Climate Change Policy*, Routledge Publishing.
- ⁵³⁷ USDA/FAO soil carbon map of the world is available for download at ftp://www.daac.ornl.gov/data/global_soil/IsricWiseGrids/State
- ⁵³⁸ Luyassert, S et al., 2008. Old-growth forests as global carbon sinks. *Nature* 455: 213-215. Link: <http://www.nature.com/nature/journal/v455/n7210/abs/nature07276.html>
- ⁵³⁹ The digital soil carbon map of the world is available at ftp://www.daac.ornl.gov/data/global_soil/IsricWiseGrids/State
- ⁵⁴⁰ International Energy Outlook 2007, Report #:DOE/EIA-0484(2007), Release Date: May 2007, Tables G1 and G3.
- ⁵⁴¹ U.S. EPA 2008, Inventory of U.S. Greenhouse Gas Emissions and Sinks (EPA 430-R-08-005), Tables 3-23 and 3-24 <http://www.epa.gov/climatechange/emissions/usinventoryreport.html>
- ⁵⁴² U.S. EPA 2008, Inventory of U.S. Greenhouse Gas Emissions and Sinks (EPA 430-R-08-005), Table ES-1 <http://www.epa.gov/climatechange/emissions/usinventoryreport.html>
- ⁵⁴³ Overview Presentation to CRC on EPACT Testing (September 2008)
- ⁵⁴⁴ U. S. EPA. 2007. Final Regulatory Impact Analysis: Control of Hazardous Air Pollutants from Mobile Sources; EPA420-R-07-002; Office of Transportation and Air Quality, Ann Arbor, MI. <http://www.epa.gov/otaq/toxics.htm>

- ⁵⁴⁵ Reddy, Sam R. 2007. "A Model for Estimating Vapor Pressures of Commingled Ethanol Fuels." SAE 2007-01-4006.
- ⁵⁴⁶ U. S. EPA. 2007. Regulatory Impact Analysis: Renewable Fuel Standard Program; EPA420-R-07-004; Office of Transportation and Air Quality, Ann Arbor, MI. <http://www.epa.gov/otaq/renewablefuels/index.htm>
- ⁵⁴⁷ Overview Presentation to CRC on EPACT Testing (September 2008)
- ⁵⁴⁸ Haskew, Harold M., Thomas F. Liberty and Dennis McClement, "Fuel Permeation from Automotive Systems," Final Report, for the Coordinating Research Council and the California Air Resources Board, CRC Project E-65, September 2004. Available in Docket EPA-HQ-OAR-2005-0161.
- ⁵⁴⁹ Southwest Research Institute. 2007. Flex Fuel Vehicles (FFVs) VOC/PM Cold Temperature Characterization When Operating on Ethanol (E10, E70, E85). Prepared for U. S. Environmental Protection Agency. Available in Docket EPA-HQ-OAR-2005-0161.
- ⁵⁵⁰ Environment Canada. 2007. Comparison of Emissions from Conventional and Flexible Fuel Vehicles Operating on Gasoline and E85 Fuels. ERM Report No. 05-039, Emissions Research Division. Available in Docket EPA-HQ-OAR-2005-0161.
- ⁵⁵¹ EPA Certification and Fuel Economy Information System. <http://www.epa.gov/otaq/cfeis.htm>
- ⁵⁵² Southwest Research Institute. 2007. Flex Fuel Vehicles (FFVs) VOC/PM Cold Temperature Characterization When Operating on Ethanol (E10, E70, E85). Prepared for U. S. Environmental Protection Agency. Available in Docket EPA-HQ-OAR-2005-0161.
- ⁵⁵³ Graham, L. A.; Belisle, S. L. and C. Baas. 2008. Emissions from light duty gasoline vehicles operating on low blend ethanol gasoline and E85. Atmos. Environ. 42: 4498-4516.
- ⁵⁵⁴ Environment Canada. 2007. Comparison of Emissions from Conventional and Flexible Fuel Vehicles Operating on Gasoline and E85 Fuels. ERM Report No. 05-039, Emissions Research Division. Available in Docket EPA-HQ-OAR-2005-0161.
- ⁵⁵⁵ Auto/Oil Air Quality Improvement Research Program. 1996. Phase I and II Test Data. Prepared by Systems Applications International, Inc.
- ⁵⁵⁶ U.S. EPA, 2007. Modeling of Ethanol Blend Effects on Nonroad Fuel Hose and Tank Permeation. Memorandum from Craig Harvey, U. S. EPA, March 26, 2007.
- ⁵⁵⁷ U.S. EPA, 2008. Biodiesel Effects on Heavy-Duty Highway Engines and Vehicles; Office of Transportation and Air Quality, Ann Arbor, MI.
- ⁵⁵⁸ U.S. EPA 2002 A Comprehensive Analysis of Biodiesel Impacts on Exhaust Emissions: Draft Technical Report (EPA420-P-02-001)
- ⁵⁵⁹ U.S. EPA, 2008. Development of MOVES Rates for HC, CO and NO_x Exhaust Emissions from Light-duty Vehicles for use in the RFS2 NRPM, Memorandum from James Warila, U. S. EPA, November 2008.
- ⁵⁶⁰ U.S. EPA. 2008. Kansas City Characterization Study: Final Report (EPA420-R-08-009) <http://www.epa.gov/otaq/emission-factors-research/420r08009.pdf>
- ⁵⁶¹ U.S. EPA. 2008. Analysis of Particulate Matter Emissions from Light-Duty Vehicles in Kansas City (EPA420-R-08-010) <http://www.epa.gov/otaq/emission-factors-research/420r08010.pdf>
- ⁵⁶² U.S. EPA, 2008. Modeling Evaporative Emissions in MOVES for the RFS2 NPRM. Memorandum from Prashanth Gururaja, U.S. EPA, November 2008.
- ⁵⁶³ U.S. EPA. 2002. Technical Description of the Toxics Module for MOBILE6.2 and Guidance on Its Use for Emission Inventory Preparation. (EPA420-R-02-029) <http://www.epa.gov/otaq/models/mobile6/r02029.pdf>
- ⁵⁶⁴ U.S. EPA, 2008. Using MOVES to Generate Inventories for the RFS2 NPRM, Memorandum from Amanda Valente and Megan Beardsley, November 2008.
- ⁵⁶⁵ See <http://www.epa.gov/ttn/chief/emch/index.html>.
- ⁵⁶⁶ Final Rule: Control of Emissions of Air Pollution from Locomotives and Marine Compression-Ignition Engines Less Than 30 Liters per Cylinder (published May 6, 2008 and republished June 30, 2008). For details, see <http://www.epa.gov/OMS/locomotiv.htm#2008final>
- ⁵⁶⁷ Details about NMIM are available at <http://www.epa.gov/otaq/nmim.htm>.
- ⁵⁶⁸ Information about the 2005 NEI may be found at <http://www.epa.gov/ttn/chief/net/2005inventory.html>.
- ⁵⁶⁹ Details concerning the Final Rule: Control of Emissions of Air Pollution from New Nonroad Spark-Ignition Engines, Equipment, and Vessels may be found at <http://www.epa.gov/otaq/equip-ld.htm#>.
- ⁵⁷⁰ Sze, C., Whinihan, J., Olson, B., Schenk, C., Sobotowski, R. Impact of Test Cycle and Biodiesel Concentration of Emissions, SAE report 2007-01-4040 (2007).

- ⁵⁷¹ U. S. EPA. 2007. Final Regulatory Impact Analysis: Control of Hazardous Air Pollutants from Mobile Sources; EPA420-R-07-002; Office of Transportation and Air Quality, Ann Arbor, MI. <http://www.epa.gov/otaq/toxics.htm>
- ⁵⁷² Landman, L. C. (2007) Estimating Emissions Associated with Portable Fuel Containers (PFCs). U. S. EPA, Assessment and Standards Division, National Vehicle and Fuel Emissions Laboratory, Ann Arbor, MI, Report No. EPA420-R-07-001. <http://www.epa.gov/otaq/toxics.htm>
- ⁵⁷³ U. S. EPA. 2007. Regulatory Impact Analysis: Renewable Fuel Standard Program; EPA420-R-07-004; Office of Transportation and Air Quality, Ann Arbor, MI. <http://www.epa.gov/otaq/renewablefuels/index.htm>
- ⁵⁷⁴ U. S. EPA. 1993. Final Regulatory Impact Analysis for Reformulated Gasoline. December 13, 1993. <http://www.epa.gov/otaq/regs/fuels/rfg/>
- ⁵⁷⁵ Haskeew, H. M.; Liberty, T. F.; McClement, D. 2004. Fuel Permeation from Automotive Systems. Prepared for the Coordinating Research Council by Harold Haskeew and Associates and Automotive Testing Laboratories, Inc. September 2004. CRC Project No. E-65. <http://www.crao.com>. This document is available in Docket EPA-HQ-OAR-2005-0036.
- ⁵⁷⁶ Hester, Charles. 2006. Review of Data on HAP Content in Gasoline. Memorandum from MACTEC to Steve Shedd, U. S. EPA, March 23, 2006. This document is available in Docket EPA-HQ-OAR-2003-0053.
- ⁵⁷⁷ U. S. EPA. 2006. Determination that Gasoline Distribution Stage 1 Area Source (GD AS) Category Does Not Need to Be Regulated Under Section 112(c)6. Memorandum from Stephen Shedd to Kent Hustvedt, May 9, 2006. This document is available in Docket EPA-HQ-OAR-2005-0036.
- ⁵⁷⁸ U. S. EPA. SPECIATE Version 4.0. <http://www.epa.gov/ttn/chief/software/speciate/index.html>
- ⁵⁷⁹ Haskeew, H. M., Liberty, T. F., McClement, D. 2004. Fuel Permeation from Automotive Systems. Report No. CRC E-65, Prepared for California Air Resources Board and Coordinating Research Council. <http://www.crao.org/>
- ⁵⁸⁰ United States Department of Agriculture, Amber Waves, February 2004, page 9, U.S. Increasingly Imports Nitrogen and Potash Fertilizer. <http://www.ers.usda.gov/amberwaves/February04/>
- ⁵⁸¹ Wen Huang, United States Department of Agriculture, Economic Research Service, personal communication to Craig Harvey, US EPA, November 9, 2007.
- ⁵⁸² 40 CFR Part 63 National Emission Standards for Hazardous Air Pollutants for Source Categories: Gasoline Distribution Bulk Terminals, Bulk Plants, Pipeline Facilities, and Gasoline Dispensing Facilities; Proposed Rule, Thursday, November 9, 2006, 66064-66092.
- ⁵⁸³ E. H. Pechan. Documentation For The Final 2002 Nonpoint Sector (Feb 06 Version) National Emission Inventory For Criteria And Hazardous Air Pollutants, Appendix A, pp. A-89 to A-105. Prepared for Emissions Inventory and Analysis Group (C339-02) Air Quality Assessment Division Office of Air Quality Planning and Standards U.S. Environmental Protection Agency Research Triangle Park, NC 27711, Report No. 05.10.001/9014.401 Jul-06. Available at ftp://ftp.epa.gov/EmisInventory/2002finalnei/documentation/nonpoint/2002nei_final_nonpoint_documentation0206version.pdf.
- ⁵⁸⁴ Energy Information Administration. 2007. Product Supplied, Petroleum Supply Reporting System. http://tonto.eia.doe.gov/dnav/pet/pet_cons_psup_dc_nus_mbbbl_a.htm
- ⁵⁸⁵ EPA. 1994. Final Regulatory Impact Analysis: Refueling Emission Regulations for Light Duty Vehicles and Trucks and Heavy Duty Vehicles. Office of Mobile Sources, Ann Arbor, MI. Available at <http://www.epa.gov/otaq/orvr.htm>.
- ⁵⁸⁶ U. S. EPA. 2001. Final Rule: Control of Air Pollution From New Motor Vehicles: Heavy-Duty Engine and Vehicle Standards and Highway Diesel Fuel Sulfur Control Requirements, January 18, 2001.
- ⁵⁸⁷ U. S. EPA. 2008. Final Rule: Control of Emissions of Air Pollution from Locomotives and Marine Compression-Ignition Engines Less than 30 Liters per Cylinder, Regulatory Impact Analysis, June 30, 2008. <http://www.epa.gov/otaq/locomotv.htm>
- ⁵⁸⁸ U.S. EPA. 2008. RFS2 Modified version of GREET1.7 Upstream Emissions Spreadsheet, October 31, 2008.
- ⁵⁸⁹ Emission Inventories for Ocean-Going Vessels Using Category 3 Propulsion Engines In or Near the United States, Draft Technical Support Document, EPA420-D-07-007, December 2007. This is available in Docket OAR-2007-0121 at <http://www.regulations.gov/>.
- ⁵⁹⁰ U. S. EPA. 2006. National-Scale Air Toxics Assessment for 1999. <http://www.epa.gov/ttn/atw/nata1999>.
- ⁵⁹¹ U. S. EPA. 2007. Approach for Developing 2002 and Future Emission Summaries. Memorandum from Madeleine Strum to Docket, November 26, 2007. This document is available in Docket EPA-HQ-OAR-2007-0491.
- ⁵⁹² Federal Register. 2007. National Emission Standards for Hazardous Air Pollutants From Petroleum Refineries. 72(170): 50715-50742. <http://www.epa.gov/EPA-AIR/2007/September/Day-04/a17009.htm>.

-
- ⁵⁹³ Energy Information Administration. 2007. Product Supplied, Petroleum Supply Reporting System. http://tonto.eia.doe.gov/dnav/pet/pet_cons_psup_dc_nus_mbbbl_a.htm
- ⁵⁹⁴ Brady, D. and Pratt, G. C. 2007. Volatile Organic Compound Emissions from Dry Mill Fuel Ethanol Production. *J. Air & Waste Manage. Assoc.* 57: 1091-1102.
- ⁵⁹⁵ Prevention of Significant Deterioration Construction Permit Application. Prepared for Verasun Fort Dodge, LLC, Fort Dodge Iowa, by Barr, Minneapolis, MN, December, 2007.
- ⁵⁹⁶ See Chapter 1.5 of the Draft Regulatory Impact Assessment of this rulemaking.
- ⁵⁹⁷ U. S. EPA. 2007. Control of Hazardous Air Pollutants from Mobile Sources; Final Rule. *Federal Register*, 72: 8428-8570.
- ⁵⁹⁸ U. S. EPA. 2007. Regulation of Fuels and Fuel Additives: Renewable Fuel Standard Program; Final Rule. *Federal Register*, 72: 23900-24014.
- ⁵⁹⁹ U. S. EPA. 2007. Final Regulatory Impact Analysis: Control of Hazardous Air Pollutants from Mobile Sources; EPA420-R-07-002; Office of Transportation and Air Quality, Ann Arbor, MI. <http://www.epa.gov/otaq/toxics.htm>
- ⁶⁰⁰ Energy Information Administration. 1999. Petroleum Marketing Annual. Report No. DOE/EIA-0487(99). http://www.eia.doe.gov/pub/oil_gas/petroleum/data_publications/petroleum_marketing_annual/historical/1999/pma_1999.html
- ⁶⁰¹ Energy Information Administration. 2007. Annual Energy Outlook 2007 with Projections to 2030. U.S. Department of Energy, Report # DOE/EIA-0383. <http://www.eia.doe.gov/oiaf/aeo/index.html>
- ⁶⁰² U. S. EPA. SPECIATE Version 4.0. <http://www.epa.gov/ttn/chief/software/speciate/index.html>
- ⁶⁰³ ⁶⁰³ Auto/Oil Air Quality Improvement Research Program. 1996. Phase I and II Test Data. Prepared by Systems Applications International, Inc.
- ⁶⁰⁴ Diesel Locomotives, Marine Distillate, Residual Boiler -- E. H. Pechan. 2005. Documentation For Aircraft, Commercial Marine Vessel, Locomotive, And Other Nonroad Components Of The National Emissions Inventory, Volume I - Methodology. Prepared for U. S. Environmental Protection Agency, Office of Air Quality Planning and Standards, Research Triangle Park, NC. <http://www.epa.gov/ttn/chief/net/2002inventory.html>
- ⁶⁰⁵ HDD Trucks -- R. Cook, E. Glover. 2002. Technical Description of the Toxics Module for MOBILE6.2 and Guidance on Its Use for Emission Inventory Preparation. U. S. Environmental Protection Agency, Office of Transportation and Air Quality. Report No. EPA420-R-02-011. <http://www.epa.gov/otaq/m6.htm>
- ⁶⁰⁶ Natural Gas Turbines -- U. S. EPA. 2000. AP-42, 5th Edition, Volume 1. Chapter 3: Stationary Internal Combustion Sources. <http://www.epa.gov/ttn/chief/ap42/ch03/index.html>
- ⁶⁰⁷ Control of Hazardous Air Pollutants From Mobile Sources (72 FR 8428; February 26, 2007).
- ⁶⁰⁸ U.S. Environmental Protection Agency, Byun, D.W., Ching, J.K.S., Eds (1999) Science algorithms of EPA Models-3 Community Multiscale Air Quality (CMAQ modeling system, EPA/600/R-99/030, Office of Research and Development).
- ⁶⁰⁹ Byun, D.W., Schere, K.L. (2006) Review of the Governing Equations, Computational Algorithms, and Other Components of the Models-3 Community Multiscale Air Quality (CMAQ) Modeling System, *J. Applied Mechanics Reviews* 59 (2): 51-77.
- ⁶¹⁰ Dennis, R.L., Byun, D.W., Novak, J.H., Galluppi, K.J., Coats, C.J., Vouk, M.A. (1996) The next generation of integrated air quality modeling: EPA's Models-3, *Atmos Environ* 30:1925-1938.
- ⁶¹¹ US EPA (2007) Regulatory Impact Analysis of the Proposed Revisions to the National Ambient Air Quality Standards for Ground-Level Ozone. EPA document number 442/R-07-008, July 2007.
- ⁶¹² Aiyyer, A, Cohan, D., Russell, A., Stockwell, W., Tanrikulu, S., Vizuete, W., Wilczak, J. (2007) Final Report: Third Peer Review of the CMAQ Model. p. 23.
- ⁶¹³ Grell, G., J. Dudhia, D. Stauffer (1994) A Description of the Fifth-Generation Penn State/NCAR Mesoscale Model (MM5), NCAR/TN-398+STR., 138 pp, National Center for Atmospheric Research, Boulder CO.
- ⁶¹⁴ final LocoMarine AQM TSD
- ⁶¹⁵ U.S. Environmental Protection Agency, Byun, D.W., Ching, J.K.S., Eds (1999) Science algorithms of EPA Models-3 Community Multiscale Air Quality (CMAQ modeling system, EPA/600/R-99/030, Office of Research and Development). Please also see: <http://www.cmascenter.org/>
- ⁶¹⁶ Yantosca, B. (2004) GEOS-CHEMv7-01-02 User's Guide, Atmospheric Chemistry Modeling Group, Harvard University, Cambridge, MA, October 15, 2004.
- ⁶¹⁷ Finlayson-Pitts BJ, Pitts JN Jr. (1986) *Atmospheric Chemistry: Fundamentals and Experimental Techniques*, Wiley, New York.

-
- ⁶¹⁸ Atkinson R, Arey J (2003) Atmospheric Degradation of Volatile Organic Compounds. *Chem Rev* 103: 4605-4638.
- ⁶¹⁹ Atkinson, R., Baulch, D.L., Cox, R.A., Crowley, J.N., Hampson, R.F. Jr., Hynes, R.G., Jenkin, M.E., Kerr, J.A., Rossi, M.J., Troe, J. (2005) Evaluated Kinetic and Photochemical Data for Atmospheric Chemistry - IUPAC Subcommittee on Gas Kinetic Data Evaluation for Atmospheric Chemistry. July 2005 web version. <http://www.iupac-kinetic.ch.cam.ac.uk/index.html>.
- ⁶²⁰ Atkinson, R., Baulch, D.L., Cox, R.A., Crowley, J.N., Hampson, R.F. Jr., Hynes, R.G., Jenkin, M.E., Kerr, J.A., Rossi, M.J., Troe, J. (2005) Evaluated Kinetic and Photochemical Data for Atmospheric Chemistry - IUPAC Subcommittee on Gas Kinetic Data Evaluation for Atmospheric Chemistry. July 2005 web version. <http://www.iupac-kinetic.ch.cam.ac.uk/index.html>.
- ⁶²¹ Atkinson, R., Baulch, D.L., Cox, R.A., Crowley, J.N., Hampson, R.F. Jr., Hynes, R.G., Jenkin, M.E., Kerr, J.A., Rossi, M.J., Troe, J. (2005) Evaluated Kinetic and Photochemical Data for Atmospheric Chemistry - IUPAC Subcommittee on Gas Kinetic Data Evaluation for Atmospheric Chemistry. July 2005 web version. <http://www.iupac-kinetic.ch.cam.ac.uk/index.html>.
- ⁶²² Atkinson, R., Baulch, D.L., Cox, R.A., Crowley, J.N., Hampson, R.F. Jr., Hynes, R.G., Jenkin, M.E., Kerr, J.A., Rossi, M.J., Troe, J. (2005) Evaluated Kinetic and Photochemical Data for Atmospheric Chemistry - IUPAC Subcommittee on Gas Kinetic Data Evaluation for Atmospheric Chemistry. July 2005 web version. <http://www.iupac-kinetic.ch.cam.ac.uk/index.html>.
- ⁶²³ Atkinson, R., Baulch, D.L., Cox, R.A., Crowley, J.N., Hampson, R.F. Jr., Hynes, R.G., Jenkin, M.E., Kerr, J.A., Rossi, M.J., Troe, J. (2005) Evaluated Kinetic and Photochemical Data for Atmospheric Chemistry - IUPAC Subcommittee on Gas Kinetic Data Evaluation for Atmospheric Chemistry. July 2005 web version. <http://www.iupac-kinetic.ch.cam.ac.uk/index.html>.
- ⁶²⁴ Sander, S.P., Friedl, R.R., Golden, D.M., Kurylo, M.J., Huie, R.E., Orkin, V.L., Moortgat, G.K., Ravishankara, A.R., Kolb, C.E., Molina, M.J., Finlayson-Pitts, B.J. (2003) Chemical Kinetics and Photochemical Data for use in Atmospheric Studies, Evaluation Number 14. NASA Jet Propulsion Laboratory <http://jpldataeval.jpl.nasa.gov/index.html>.
- ⁶²⁵ Sander, S.P., Friedl, R.R., Golden, D.M., Kurylo, M.J., Huie, R.E., Orkin, V.L., Moortgat, G.K., Ravishankara, A.R., Kolb, C.E., Molina, M.J., Finlayson-Pitts, B.J. (2003) Chemical Kinetics and Photochemical Data for use in Atmospheric Studies, Evaluation Number 14. NASA Jet Propulsion Laboratory <http://jpldataeval.jpl.nasa.gov/index.html>.
- ⁶²⁶ Atkinson, R., Baulch, D.L., Cox, R.A., Crowley, J.N., Hampson, R.F. Jr., Hynes, R.G., Jenkin, M.E., Kerr, J.A., Rossi, M.J., Troe, J. (2005) Evaluated Kinetic and Photochemical Data for Atmospheric Chemistry - IUPAC Subcommittee on Gas Kinetic Data Evaluation for Atmospheric Chemistry. July 2005 web version. <http://www.iupac-kinetic.ch.cam.ac.uk/index.html>.
- ⁶²⁷ Finlayson-Pitts BJ, Pitts JN Jr. (1986) *Atmospheric Chemistry: Fundamentals and Experimental Techniques*, Wiley, New York.
- ⁶²⁸ Sander, S.P., Friedl, R.R., Golden, D.M., Kurylo, M.J., Huie, R.E., Orkin, V.L., Moortgat, G.K., Ravishankara, A.R., Kolb, C.E., Molina, M.J., Finlayson-Pitts, B.J. (2003) Chemical Kinetics and Photochemical Data for use in Atmospheric Studies, Evaluation Number 14. NASA Jet Propulsion Laboratory. <http://jpldataeval.jpl.nasa.gov/index.html>.
- ⁶²⁹ Yarwood G, Rao S, Yocke M, Whitten GZ (2005) Updates to the Carbon Bond Chemical Mechanism: CB05. Final Report to the US EPA, RT-0400675, December 8, 2005. http://www.camx.com/publ/pdfs/CB05_Final_Report_120805.pdf.
- ⁶³⁰ Atkinson, R., Baulch, D.L., Cox, R.A., Crowley, J.N., Hampson, R.F. Jr., Hynes, R.G., Jenkin, M.E., Kerr, J.A., Rossi, M.J., Troe, J. (2005) Evaluated Kinetic and Photochemical Data for Atmospheric Chemistry - IUPAC Subcommittee on Gas Kinetic Data Evaluation for Atmospheric Chemistry. July 2005 web version. <http://www.iupac-kinetic.ch.cam.ac.uk/index.html>.
- ⁶³¹ Anderson LG, Lanning JA, Wilkes E, Wolfe P, Jones RH (1997) Effects of Using Oxygenated Fuels on Carbon Monoxide, Formaldehyde and Acetaldehyde Concentrations in Denver. Paper 97-RP139.05, Air & Waste Management Association 90th Annual Meeting & Exhibition, June 8-13, 1997, Toronto, Ontario, Canada.
- ⁶³² Jeffrey S. Gaffney, Nancy A. Marley, Randal S. Martin, Roy W. Dixon, Luis G. Reyes, and Carl J. Popp (1997) Potential Air Quality Effects of Using Ethanol-Gasoline Fuel Blends: A Field Study in Albuquerque, New Mexico. *Environ Sci Technol* 31(11): 3053 - 3061; DOI: [10.1021/es9610388](https://doi.org/10.1021/es9610388).
- ⁶³³ Grosjean D (1999) Ambient levels of peroxyacetyl nitrate in southern California, Report from DGA, Inc., Ventura, CA to California Air Resources Board, Sacramento, CA, Agreement 99-703, Draft, August 31.

- ⁶³⁴ Allen P, R Bradley, BE Croes, J DaMassa, R Effa, M Fuentes, A Hebert, D Luo, R Vincent, L Woodhouse, E Yang (1999) Analysis of the Air Quality Impacts of the Use of Ethanol in Gasoline. California Air Resources Board, September 28, 1999.
- ⁶³⁵ Jacobson M (2007) Effects of ethanol (E85) versus gasoline vehicles on cancer and mortality in the United States, *Environ Sci Technol* 41: 4150-4157.
- ⁶³⁶ Grosjean D (1997) Atmospheric Chemistry of Alcohols. *J Braz Chem Soc* 8(4): 433-442.
- ⁶³⁷ Andrade JB de, Andrade MV, Pinheiro HLC (1998) Atmospheric levels of formaldehyde and acetaldehyde and their relationship with the vehicular fleet composition in Salvador, Bahia, Brazil. *J Braz Chem Soc* 9(3): 219-223.
- ⁶³⁸ Montero L, Vasconcellos PC, Souza SR, Pires MAF, Sanchez-Ccoyllo OR, Andrade MF, Carvalho LRF (2001) Measurements of Atmospheric Carboxylic Acids and Carbonyl Compounds in Sao Paulo City, Brazil. *Environ Sci Technol* 35: 3071-3081.
- ⁶³⁹ Colon M, Pleil JD, Hartlage TA, Guardani ML, Martins MH (2001) Survey of volatile organic compounds associated with automotive emissions in the urban airshed of Sao Paulo, Brazil. *Atmos Environ* 35: 4017-4031.
- ⁶⁴⁰ Tanner R, Miguel A, deAndrade J, Gaffney J, Streit G (1988) Atmospheric Chemistry of Aldehydes, Enhanced Peroxyacetyl Nitrate Formation from Ethanol-Fueled Vehicles. *Environ Sci Technol* 22(9): 1026-1037.
- ⁶⁴¹ Grosjean E, Grosjean D, Woodhouse L, Yang Y, (2002) Peroxyacetyl nitrate and peroxypropionyl nitrate in Porto Alegre, Brazil, *Atmos Environ* 36: 2405-2419.
- ⁶⁴² Grosjean D, Grosjean E, Moreira LFR (2002) Speciated Ambient Carbonyls in Rio de Janeiro, Brazil. *Environ Sci Technol* 36: 1389-1395.
- ⁶⁴³ EM Martins, G Arbilla (2003) Computer modeling study of ethanol and aldehyde reactivities in Rio de Janeiro urban air. *Atmos Environ* 37: 1715-1722.
- ⁶⁴⁴ Hannigan, Michael P., William F. Busby, Jr., Glen R. Cass (2005) Source Contributions to the Mutagenicity of Urban Particulate Air Pollution. *J Air Waste Mgmt* 55: 399-410.
- ⁶⁴⁵ Zheng M, GR Cass, JJ Schauer, ES Edgerton (2002) Source Apportionment of PM_{2.5} in the Southeastern United States Using Solvent-Extractable Organic Compounds as Tracers. *Environ Sci Technol* 36: 2631-2371.
- ⁶⁴⁶ EPA (2002) National Air Quality and Emission Trends Report, 2001. EPA 454/K-02-001, September 2002. <http://www.epa.gov/air/airtrends/aqtrnd01/summary.pdf>
- ⁶⁴⁷ Schauer JJ, GR Cass (2000) Source Apportionment of Wintertime Gas-Phase and Particle-Phase Air Pollutants Using Organic Compounds as Tracers, *Environ Sci Technol* 34(9): 1821-1832. <http://pubs.acs.org/cgi-bin/article.cgi/esthag/2000/34/i09/pdf/es981312t.pdf>
- ⁶⁴⁸ Kleeman MJ, GR Cass (1999) Identifying the Effect of Individual Emission Sources on Particulate Air Quality Within a Photochemical Aerosol Processes Trajectory Model. *Atmos Environ* 33: 4597-4613.
- ⁶⁴⁹ Watson J, Fujita E, Chow J, Zielinska B, Richards L, Neff W, Dietrich D (1998) Northern Front Range Air Quality Study Final Report: Volume 1. June 30, 1998. For Colorado State University, Cooperative Institute for Research in the Atmosphere, by Desert Research Institute, Reno, NV. This document is available in EPA Docket EPA-HQ-OAR-2005-0161.
- ⁶⁵⁰ Schauer JJ, WF Rogge, LM Hildemann, MA Mazurek, GR Cass, B Simoneit (1996) Source Apportionment of Airborne Particulate Matter Using Organic Compounds as Tracers. *Atmos Environ* 30: 3837-3855.
- ⁶⁵¹ Lewandowski M, M Jaoui, JH Offenberg, TE Kleindienst, EO Edney, RJ Sheesley, JJ Schauer (2008) Primary and secondary contributions to ambient PM in the midwestern United States, *Environ Sci Technol* 42(9):3303-3309. <http://pubs.acs.org/cgi-bin/article.cgi/esthag/2008/42/i09/html/es0720412.html>
- ⁶⁵² Kleindienst TE, M Jaoui, M Lewandowski, JH Offenberg, EO Edney (2007) Estimates of the contributions of biogenic and anthropogenic hydrocarbons to secondary organic aerosol at a southeastern U.S. location, *Atmos Environ* 41(37):8288-8300.
- ⁶⁵³ Offenberg JH, CW Lewis, M Lewandowski, M Jaoui, TE Kleindienst, EO Edney (2007) Contributions of Toluene and α -pinene to SOA Formed in an Irradiated Toluene/ α -pinene,NO_x/Air Mixture: Comparison of Results Using ¹⁴C Content and SOA Organic Tracer Methods, *Environ Sci Technol* 41: 3972-3976.
- ⁶⁵⁴ Byun DW, Schere, KL (2006) Review of the Governing Equations, Computational Algorithms, and Other Components of the Models-3 Community Multiscale Air Quality (CMAQ) Modeling System, *J Applied Mechanics Reviews* 59: 51-76.
- ⁶⁵⁵ Pandis, S.N., Harley, R.A., Cass, G.R., Seinfeld, J.H. (1992) Secondary organic aerosol formation and transport. *Atmos Environ* 13, 2269-2282.
- ⁶⁵⁶ H Takekawa, H Minoura, S Yamazaki (2003) Temperature dependence of secondary organic aerosol formation by photo-oxidation of hydrocarbons. *Atmos Environ* 37: 3413-3424.

- ⁶⁵⁷ M J. Kleeman, Q Ying, Jin Lu, M J. Mysliwiec, R J. Griffin, Jianjun Chen, Simon Clegg (2007) Source apportionment of secondary organic aerosol during a severe photochemical smog episode. *Atmos Environ* 41: 576–591.
- ⁶⁵⁸ Robinson, A. L.; Donahue, N. M.; Shrivastava, M.; Weitkamp, E. A.; Sage, A. M.; Grieshop, A. P.; Lane, T. E.; Pierce, J. R.; Pandis, S. N. (2007) Rethinking organic aerosol: Semivolatile emissions and photochemical aging. *Science* 315: 1259-1262.
- ⁶⁵⁹ U. S. EPA (2002) National Air Quality and Emissions Trends Report, 2001. EPA 454/K-02-001, September 2002. <http://www.epa.gov/air/airtrends/aqtrnd01/summary.pdf>
- ⁶⁶⁰ U. S. EPA (2006) National-Scale Air Toxics Assessment for 1999. <http://www.epa.gov/ttn/atw/nata1999>
- ⁶⁶¹ U. S. EPA (2007) Regulatory Impact Analysis for the Control of Hazardous Air Pollutants from Mobile Sources Rule, Chapter 3, Air Quality and Resulting Health and Welfare Effects of Air Pollution from Mobile Sources. 72 FR 8428, February 26, 2007. <http://www.epa.gov/otaq/regs/toxics/420r07002.pdf>
- ⁶⁶² TE Kleindienst (2008) Hypothetical SOA Production from Ethanol Photooxidation. Memo to the Docket EPA-HQ-OAR-2005-0161.
- ⁶⁶³ BJ Turpin, JJ Huntzicker, SM Larson, GR Cass (1991) Los Angeles Summer Midday Particulate Carbon: Primary and Secondary Aerosol. *Environ Sci Technol* 25: 1788-1793.
- ⁶⁶⁴ BJ Turpin, JJ Huntzicker (1995) Identification of Secondary Organic Aerosol Episodes and Quantitation of Primary and Secondary Organic Aerosol Concentrations During SCAQS. *Atmos Environ* 29(23): 3527-3544.
- ⁶⁶⁵ Bae M-S, Schauer JJ, Turner JR (2006) Estimation of the Monthly Average Ratios of Organic Mass to Organic Carbon for Fine Particulate Matter at an Urban Site, *Aerosol Sci Technol* 40(12): 1123-1139. <http://dx.doi.org/10.1080/02786820601004085>.
- ⁶⁶⁶ Kleindienst TE, M Jaoui, M Lewandowski, JH Offenberg, EO Edney (2007) Estimates of the contributions of biogenic and anthropogenic hydrocarbons to secondary organic aerosol at a southeastern U.S. location. *Atmos Environ* 41(37):8288-8300.
- ⁶⁶⁷ Offenberg JH, CW Lewis, M Lewandowski, M Jaoui, TE Kleindienst, EO Edney (2007) Contributions of Toluene and α -pinene to SOA Formed in an Irradiated Toluene/ α -pinene, NO_x /Air Mixture: Comparison of Results Using ^{14}C Content and SOA Organic Tracer Methods, *Environ Sci Technol* 41: 3972-3976.
- ⁶⁶⁸ Claey s M, R Szmigielski, I Kourtchev, P Van der Veken, R Vermeylen, W Maenhaut, M Jaoui, TE Kleindienst, M Lewandowski, JH Offenberg, EO Edney (2007) Hydroxydicarboxylic acids: Markers for secondary organic aerosol from the photooxidation of α -pinene. *Environ Sci Technol* 41(5): 1628-1634.
- ⁶⁶⁹ Edney EO, TE Kleindienst, M Jaoui, M Lewandowski, JH Offenberg, W Wang, M Claey s (2005) Formation of 2-methyl tetrols and 2-methylglyceric acid in secondary organic aerosol from laboratory irradiated isoprene/ NO_x / SO_2 /air mixtures and their detection in ambient $\text{PM}_{2.5}$ samples collected in the Eastern United States. *Atmos Environ* 39: 5281-5289.
- ⁶⁷⁰ Jaoui M, TE Kleindienst, M Lewandowski, JH Offenberg, EO Edney (2005) Identification and quantification of aerosol polar oxygenated compounds bearing carboxylic or hydroxyl groups. 2. Organic tracer compounds from monoterpenes. *Environ Sci Technol* 39: 5661-5673.
- ⁶⁷¹ Kleindienst TE, TS Conner, CD McIver, EO Edney (2004) Determination of secondary organic aerosol products from the photooxidation of toluene and their implications in ambient $\text{PM}_{2.5}$. *J Atmos Chem* 47: 70-100.
- ⁶⁷² Kleindienst TE, TS Conner, CD McIver, EO Edney (2004) Determination of secondary organic aerosol products from the photooxidation of toluene and their implication in ambient $\text{PM}_{2.5}$. *J Atmos Chem* 47: 70-100.
- ⁶⁷³ Izumi L, T Fukuyama (1990) Photochemical aerosol formation from aromatic hydrocarbons in the presence of NO_x . *Atmos Environ* 24A: 1433.
- ⁶⁷⁴ Martin-Revi ego M, K Wirtz (2005) Is benzene a precursor for secondary organic aerosol? *Environ Sci Technol* 39: 1045-1054.
- ⁶⁷⁵ Lewandowski M, M Jaoui, JH Offenberg, TE Kleindienst, EO Edney, RJ Sheesley, JJ Schauer (2008) Primary and secondary contributions to ambient PM in the midwestern United States, *Environ Sci Technol* 42(9):3303-3309. <http://pubs.acs.org/cgi-bin/article.cgi/esthag/2008/42/i09/html/es0720412.html>.
- ⁶⁷⁶ Kleindienst TE, M Jaoui, M Lewandowski, JH Offenberg, EO Edney (2007) Estimates of the contributions of biogenic and anthropogenic hydrocarbons to secondary organic aerosol at a southeastern U.S. location. *Atmos Environ* 41(37):8288-8300.
- ⁶⁷⁷ Henze DK, JH Seinfeld (2006) Global secondary organic aerosol from isoprene oxidation. *Geophys Res Lett* 33: L09812. doi:10.1029/2006GL025976.

⁶⁷⁸ Jaoui M, M Lewandowski, TE Kleindienst, JH Offenberg, EO Edney (2007) β -Caryophyllinic acid: An atmospheric tracer for β -caryophyllene secondary organic aerosol. *Geophys Res Lett* 34: L05816. doi:10.1029/2006GL028827.

⁶⁷⁹ Griffin RJ, DR Cocker III, RC Flagan, JH Seinfeld (1999) Organic aerosol formation from oxidation of biogenic hydrocarbons, *J Geophys Res* 104: 3555-3567.

⁶⁸⁰ Ng NL, JH Kroll, AWH Chan, PS Chabra, RC Flagan, JH Seinfeld (2007) Secondary organic aerosol formation from m-xylene, toluene, and benzene. *Atmos Chem Phys* 7: 3909-3922.

681 U.S. EPA (2004) Air Quality Criteria for Particulate Matter (Oct 2004), Volume I Document No. EPA600/P-99/002aF and Volume II Document No. EPA600/P-99/002bF.

This document is available in Docket EPA-HQ-OAR-2005-0161.

682 U.S. EPA (2005) Review of the National Ambient Air Quality Standard for Particulate Matter: Policy Assessment of Scientific and Technical Information, OAQPS Staff Paper. EPA-452/R-05-005. This document is available in Docket EPA-HQ-OAR-2005-0161.

683 U.S. EPA 2006. Provisional Assessment of Recent Studies on Health Effects of Particulate Matter Exposure. EPA/600/R-06/063. This document is available in Docket EPA-HQ-OAR-2005-0161.

684 Laden F; Neas LM; Dockery DW; et al. 2000. "Association of fine particulate matter from different sources with daily mortality in six U.S. cities." *Environ Health Perspectives* 108(10):941-947.

685 Schwartz J; Laden F; Zanobetti A. 2002. "The concentration-response relation between PM(2.5) and daily deaths." *Environ Health Perspect* 110(10): 1025-1029.

686 Janssen NA; Schwartz J; Zanobetti A.; et al. 2002. "Air conditioning and source-specific particles as modifiers of the effect of PM10 on hospital admissions for heart and lung disease." *Environ Health Perspect* 110(1):43-49.

687 Dockery, DW; Pope, CA, III; Xu, X; et al. 1993. "An association between air pollution and mortality in six U.S. cities." *N Engl J Med* 329:1753-1759.

688 Pope, CA, III; Burnett, RT; Thun, MJ; Calle, EE; et al. 2002. "Lung cancer, cardiopulmonary mortality, and long-term exposure to fine particulate air pollution." *J Am Med Assoc* 287: 1132-1141.

689 Krewski, D; Burnett, RT; Goldberg, M S; et al. 2000. "Reanalysis of the Harvard Six Cities study and the American Cancer Society study of particulate air pollution and mortality. A special report of the Institute's Particle Epidemiology Reanalysis Project." Cambridge, MA: Health Effects Institute.

690 Jerrett, M; Burnett, RT; Ma, R; et al. 2005. "Spatial Analysis of Air Pollution and Mortality in Los Angeles." *Epidemiology*. 16(6):727-736.

691 Künzli, N.; Jerrett, M.; Mack, W.J.; et al.(2004) Ambient air pollution and atherosclerosis in Los Angeles. *Environ Health Perspect* doi:10.1289/ehp.7523 [Available at <http://dx.doi.org/>].

⁶⁹² Riediker, M.; Cascio, W.E.; Griggs, T.R.; et al. 2004. "Particulate matter exposure in cars is associated with cardiovascular effects in healthy young men." *Am J Respir Crit Care Med* 169: 934-940.

⁶⁹³ Maynard, D.; Coull, B.A.; Gryparis, A.; Schwartz, J. (2007) Mortality risk associated with short-term exposure to traffic particles and sulfates. *Environmental Health Perspectives* 115: 751-755.

⁶⁹⁴ Ryan, P.H.; LeMasters, G.K.; Biswas, P.; Levin, L.; Hu, S.; Lindsey, M.; Bernstein, D.I.; Lockey, J.; Villareal, M.; Khurana Hershey, G.K.; Grinshpun, S.A. (2007) A comparison of proximity and land use regression traffic exposure models and wheezing in infants. *Environ Health Perspect* 115: 278-84.

⁶⁹⁵ Morgenstern, V.; Zutavern, A.; Cyrus, J.; Brockow, I.; Gehring, U.; Koletzko, S.; Bauer, C.P.; Reinhard, D.; Wichmann, H-E.; Heinrich, J. (2007) Respiratory health and individual estimated exposure to traffic-related air pollutant in a cohort of young children. *Occupational and Environmental Medicine* 64: 8-16.

⁶⁹⁶ Franco Suglia, S.; Gryparis, A.; Wright, R.O.; Schwartz, J.; Wright, R.J. (2007) Association of black carbon with cognition among children in a prospective birth cohort study. *American Journal of Epidemiology* 167: 280-286.

697 U.S. EPA. Air Quality Criteria for Ozone and Related Photochemical Oxidants (Final). U.S. EPA, Washington, DC, EPA/600/R-05/004aF-cF, 2006. This document is contained in Docket EPA-HQ-OAR-2005-0161.

698 U.S. EPA. Review of the National Ambient Air Quality Standards for Ozone: Policy Assessment of Scientific and Technical Information, OAQPS Staff Paper. Washington, DC, EPA-452/R-07-003, January 2007. This document is available in Docket EPA-HQ-OAR-2005-0161.

⁶⁹⁹ National Research Council (NRC), 2008. Estimating Mortality Risk Reduction and Economic Benefits from Controlling Ozone Air Pollution. The National Academies Press: Washington, D.C.

700 Bates, D.V.; Baker-Anderson, M.; Sizto, R. (1990) Asthma attack periodicity: a study of hospital emergency visits in Vancouver. *Environ. Res.* 51: 51-70.

701 Thurston, G.D.; Ito, K.; Kinney, P.L.; Lippmann, M. (1992) A multi-year study of air pollution and respiratory hospital admissions in three New York State metropolitan areas: results for 1988 and 1989 summers. *J. Exposure Anal. Environ. Epidemiol.* 2:429-450.

702 Thurston, G.D.; Ito, K.; Hayes, C.G.; Bates, D.V.; Lippmann, M. (1994) Respiratory hospital admissions and summertime haze air pollution in Toronto, Ontario: consideration of the role of acid aerosols. *Environ. Res.* 65: 271-290.

703 Lipfert, F.W.; Hammerstrom, T. (1992) Temporal patterns in air pollution and hospital admissions. *Environ. Res.* 59: 374-399.

704 Burnett, R.T.; Dales, R.E.; Raizenne, M.E.; Krewski, D.; Summers, P.W.; Roberts, G.R.; Raad-Young, M.; Dann, T.; Brook, J. (1994) Effects of low ambient levels of ozone and sulfates on the frequency of respiratory admissions to Ontario hospitals. *Environ. Res.* 65: 172-194.

705 U.S. EPA. Air Quality Criteria for Ozone and Related Photochemical Oxidants (Final). U.S. EPA, Washington, DC, EPA/600/R-05/004aF-cF, 2006. This document is contained in Docket EPA-HQ-OAR-2005-0161.

- 706 U.S. EPA. Air Quality Criteria for Ozone and Related Photochemical Oxidants (Final). U.S. EPA, Washington, DC, EPA/600/R-05/004aF-cF, 2006. **This document is contained in Docket EPA-HQ-OAR-2005-0161.**
- 707 Devlin, R. B.; McDonnell, W. F.; Mann, R.; Becker, S.; House, D. E.; Schreinemachers, D.; Koren, H. S. (1991) Exposure of humans to ambient levels of ozone for 6.6 hours causes cellular and biochemical changes in the lung. *Am. J. Respir. Cell Mol. Biol.* 4: 72-81.
- 708 Koren, H. S.; Devlin, R. B.; Becker, S.; Perez, R.; McDonnell, W. F. (1991) Time-dependent changes of markers associated with inflammation in the lungs of humans exposed to ambient levels of ozone. *Toxicol. Pathol.* 19: 406-411.
- 709 Koren, H. S.; Devlin, R. B.; Graham, D. E.; Mann, R.; McGee, M. P.; Horstman, D. H.; Kozumbo, W. J.; Becker, S.; House, D. E.; McDonnell, W. F.; Bromberg, P. A. (1989a) Ozone-induced inflammation in the lower airways of human subjects. *Am. Rev. Respir. Dis.* 139: 407-415.
- 710 Schelegle, E.S.; Siefkin, A.D.; McDonald, R.J. (1991) Time course of ozone-induced neutrophilia in normal humans. *Am. Rev. Respir. Dis.* 143:1353-1358.
- 711 U.S. EPA (1996). Air Quality Criteria for Ozone and Related Photochemical Oxidants, EPA600-P-93-004aF; (See page 7-171). **This document is contained in Docket EPA-HQ-OAR-2005-0161.**
- 712 Hodgkin, J.E.; Abbey, D.E.; Euler, G.L.; Magie, A.R. (1984) COPD prevalence in nonsmokers in high and low photochemical air pollution areas. *Chest* 86: 830-838.
- 713 Euler, G.L.; Abbey, D.E.; Hodgkin, J.E.; Magie, A.R. (1988) Chronic obstructive pulmonary disease symptom effects of long-term cumulative exposure to ambient levels of total oxidants and nitrogen dioxide in California Seventh-day Adventist residents. *Arch. Environ. Health* 43: 279-285.
- 714 Abbey, D.E.; Petersen, F.; Mills, P.K.; Beeson, W.L. (1993) Long-term ambient concentrations of total suspended particulates, ozone, and sulfur dioxide and respiratory symptoms in a nonsmoking population. *Arch. Environ. Health* 48: 33-46.
- 715 U.S. EPA, Review of the National Ambient Air Quality Standards for Ozone: Policy Assessment of Scientific and Technical Information, OAQPS Staff Paper, Washington, DC, EPA-452/R-07-003, January 2007. **This document is available in Docket EPA-HQ-OAR-2005-0161.**
- 716 U.S. EPA. Air Quality Criteria for Ozone and Related Photochemical Oxidants (Final). U.S. EPA, Washington, DC, EPA/600/R-05/004aF-cF, 2006. **This document is contained in Docket EPA-HQ-OAR-2005-0161.**
- 717 U.S. EPA. Air Quality Criteria for Ozone and Related Photochemical Oxidants (Final). U.S. EPA, Washington, DC, EPA/600/R-05/004aF-cF, 2006. **This document is contained in Docket EPA-HQ-OAR-2005-0161.**
- 718 Avol, E. L.; Trim, S. C.; Little, D. E.; Spier, C. E.; Smith, M. N.; Peng, R.-C.; Linn, W. S.; Hackney, J. D.; Gross, K. B.; D'Arcy, J. B.; Gibbons, D.; Higgins, I. T. T. (1990) Ozone exposure and lung function in children attending a southern California summer camp. Presented at: 83rd annual meeting and exhibition of the Air & Waste Management Association; June; Pittsburgh, PA. Pittsburgh, PA: Air & Waste Management Association; paper no. 90-150.3.
- 719 Higgins, I. T. T.; D'Arcy, J. B.; Gibbons, D. I.; Avol, E. L.; Gross, K. B. (1990) Effect of exposures to ambient ozone on ventilatory lung function in children. *Am. Rev. Respir. Dis.* 141: 1136-1146.
- 720 Raizenne, M. E.; Burnett, R. T.; Stern, B.; Franklin, C. A.; Spengler, J. D. (1989) Acute lung function responses to ambient acid aerosol exposures in children. *Environ. Health Perspect.* 79: 179-185.
- 721 Raizenne, M.; Stern, B.; Burnett, R.; Spengler, J. (1987) Acute respiratory function and transported air pollutants: observational studies. Presented at: 80th annual meeting of the Air Pollution Control Association; June; New York, NY. Pittsburgh, PA: Air Pollution Control Association; paper no. 87-32.6.
- 722 Spektor, D. M.; Lippmann, M. (1991) Health effects of ambient ozone on healthy children at a summer camp. In: Berglund, R. L.; Lawson, D. R.; McKee, D. J., eds. *Tropospheric ozone and the environment: papers from an international conference*; March 1990; Los Angeles, CA. Pittsburgh, PA: Air & Waste Management Association; pp. 83-89. (A&WMA transaction series no. TR-19).
- 723 Spektor, D. M.; Thurston, G. D.; Mao, J.; He, D.; Hayes, C.; Lippmann, M. (1991) Effects of single- and multiday ozone exposures on respiratory function in active normal children. *Environ. Res.* 55: 107-122.
- 724 Spektor, D. M.; Lippmann, M.; Liou, P. J.; Thurston, G. D.; Citak, K.; James, D. J.; Bock, N.; Speizer, F. E.; Hayes, C. (1988a) Effects of ambient ozone on respiratory function in active, normal children. *Am. Rev. Respir. Dis.* 137: 313-320.
- 725 U.S. EPA. Air Quality Criteria for Ozone and Related Photochemical Oxidants (Final). U.S. EPA, Washington, DC, EPA/600/R-05/004aF-cF, 2006. **This document is contained in Docket EPA-HQ-OAR-2005-0161.**
- 726 Hazucha, M. J.; Folinsee, L. J.; Seal, E., Jr. (1992) Effects of steady-state and variable ozone concentration profiles on pulmonary function. *Am. Rev. Respir. Dis.* 146: 1487-1493.
- 727 Horstman, D.H.; Ball, B.A.; Folinsee, L.J.; Brown, J.; Gerrity, T. (1995) Comparison of pulmonary responses of asthmatic and nonasthmatic subjects performing light exercise while exposed to a low level of ozone. *Toxicol. Ind. Health.*
- 728 Horstman, D.H.; Folinsee, L.J.; Ives, P.J.; Abdul-Salaam, S.; McDonnell, W.F. (1990) Ozone concentration and pulmonary response relationships for 6.6-hour exposures with five hours of moderate exercise to 0.08, 0.10, and 0.12 ppm. *Am. Rev. Respir. Dis.* 142: 1158-1163.
- ⁷²⁹ U.S. EPA (2000). Air Quality Criteria for Carbon Monoxide. EPA600-P-99-001F. June 1, 2000. U.S. Environmental Protection Agency, Office of Research and Development, National Center for Environmental Assessment, Washington, D.C. This document is available online at <http://www.epa.gov/ncea/pdfs/coaqcd.pdf>. A copy of this document is available in Docket EPA-HQ-OAR-2005-0161.
- ⁷³⁰ U.S. EPA (2000). Air Quality Criteria for Carbon Monoxide. EPA600-P-99-001F. June 1, 2000. U.S. Environmental Protection Agency, Office of Research and Development, National Center for Environmental Assessment, Washington, D.C. This document is available online at <http://www.epa.gov/ncea/pdfs/coaqcd.pdf>. A copy of this document is available in Docket EPA-HQ-OAR-2005-0161.
- ⁷³¹ Coburn, R.F. (1979) Mechanisms of carbon monoxide toxicity. *Prev. Med.* 8:310-322.

- ⁷³² Helfaer, M.A., and Traystman, R.J. (1996) Cerebrovascular effects of carbon monoxide. In: Carbon Monoxide (Penney, D.G., ed). Boca Raton, CRC Press, 69-86.
- ⁷³³ Benignus, V.A. (1994) Behavioral effects of carbon monoxide: meta analyses and extrapolations. *J. Appl. Physiol.* 76:1310-1316.
- ⁷³⁴ U.S. EPA (2000). Air Quality Criteria for Carbon Monoxide. EPA600-P-99-001F. June 1, 2000. U.S. Environmental Protection Agency, Office of Research and Development, National Center for Environmental Assessment, Washington, D.C. This document is available online at <http://www.epa.gov/ncea/pdfs/coaqcd.pdf>. A copy of this document is available in Docket EPA-HQ-OAR-2005-0161.
- ⁷³⁵ U.S. EPA (2000). Air Quality Criteria for Carbon Monoxide. EPA600-P-99-001F. June 1, 2000. U.S. Environmental Protection Agency, Office of Research and Development, National Center for Environmental Assessment, Washington, D.C. This document is available online at <http://www.epa.gov/ncea/pdfs/coaqcd.pdf>. A copy of this document is available in Docket EPA-HQ-OAR-2005-0161.
- ⁷³⁶ U.S. EPA (2000). Air Quality Criteria for Carbon Monoxide. EPA600-P-99-001F. June 1, 2000. U.S. Environmental Protection Agency, Office of Research and Development, National Center for Environmental Assessment, Washington, D.C. This document is available online at <http://www.epa.gov/ncea/pdfs/coaqcd.pdf>. A copy of this document is available in Docket EPA-HQ-OAR-2005-0161.
- ⁷³⁷ U.S. EPA (2000). Air Quality Criteria for Carbon Monoxide. EPA600-P-99-001F. June 1, 2000. U.S. Environmental Protection Agency, Office of Research and Development, National Center for Environmental Assessment, Washington, D.C. This document is available online at <http://www.epa.gov/ncea/pdfs/coaqcd.pdf>. A copy of this document is available in Docket EPA-HQ-OAR-2005-0161.
- ⁷³⁸ National Research Council, 1993. Protecting Visibility in National Parks and Wilderness Areas. National Academy of Sciences Committee on Haze in National Parks and Wilderness Areas. National Academy Press, Washington, DC. This book is available electronically at <http://www.nap.edu/books/0309048443/html/> and is available in Docket EPA-HQ-OAR-2005-0161.
- ⁷³⁹ U.S. EPA, National Ambient Air Quality Standards for Particulate Matter; Proposed Rule; January 17, 2006, Vol71 p 2676. This document is available in Docket EPA-HQ-OAR-2005-0161. This information is available electronically at <http://epa.gov/fedrgrstr/EPA-AIR/2006/January/Day-17/a177.pdf>
- ⁷⁴⁰ U.S. EPA (2004) Air Quality Criteria for Particulate Matter (Oct 2004), Volume I Document No. EPA600/P-99/002aF and Volume II Document No. EPA600/P-99/002bF. This document is available in Docket EPA-HQ-OAR-2005-0161.
- ⁷⁴¹ U.S. EPA (2005) Review of the National Ambient Air Quality Standard for Particulate Matter: Policy Assessment of Scientific and Technical Information, OAQPS Staff Paper. EPA-452/R-05-005. This document is available in Docket EPA-HQ-OAR-2005-0161.
- ⁷⁴² U.S. EPA, 2008. Integrated Science Assessment for Oxides of Nitrogen and Sulfur- Ecological Criteria (Final). U.S. EPA, Washington D.C., EPA/600/R-08/082F.
- ⁷⁴³ Environmental Protection Agency (2003). Response Of Surface Water Chemistry to the Clean Air Act Amendments of 1990. National Health and Environmental Effects Research Laboratory, Office of Research and Development, U.S. Environmental Protection Agency. Research Triangle Park, NC. EPA 620/R-03/001.
- ⁷⁴⁴ Fenn, M.E. and Blubaugh, T.J. (2005) Winter Deposition of Nitrogen and Sulfur in the Eastern Columbia River Gorge National Scenic Area, USDA Forest Service.
- ⁷⁴⁵ Galloway, J. N.; Cowling, E. B. (2002). Reactive nitrogen and the world: 200 years of change. *Ambio* 31: 64–71.
- ⁷⁴⁶ Bricker, Suzanne B., et al., National Estuarine Eutrophication Assessment, Effects of Nutrient Enrichment in the Nation's Estuaries, National Ocean Service, National Oceanic and Atmospheric Administration, September, 1999.
- ⁷⁴⁷ Winner, W.E., and C.J. Atkinson. 1986. "Absorption of air pollution by plants, and consequences for growth." *Trends in Ecology and Evolution* 1:15-18.
- ⁷⁴⁸ U.S. EPA. Air Quality Criteria for Ozone and Related Photochemical Oxidants (Final). U.S. EPA, Washington, DC, EPA/600/R-05/004aF-cF, 2006. This document is contained in Docket EPA-HQ-OAR-2005-0161.
- ⁷⁴⁹ Tingey, D.T., and Taylor, G.E. 1982. "Variation in plant response to ozone: a conceptual model of physiological events." In: *Effects of Gaseous Air Pollution in Agriculture and Horticulture* (Unsworth, M.H., Omrod, D.P., eds.) London, UK: Butterworth Scientific, pp.113-138.
- ⁷⁵⁰ U.S. EPA. Air Quality Criteria for Ozone and Related Photochemical Oxidants (Final). U.S. EPA, Washington, DC, EPA/600/R-05/004aF-cF, 2006. This document is contained in Docket EPA-HQ-OAR-2005-0161.
- ⁷⁵¹ U.S. EPA. Air Quality Criteria for Ozone and Related Photochemical Oxidants (Final). U.S. EPA, Washington, DC, EPA/600/R-05/004aF-cF, 2006. This document is contained in Docket EPA-HQ-OAR-2005-0161.
- ⁷⁵² U.S. EPA. Air Quality Criteria for Ozone and Related Photochemical Oxidants (Final). U.S. EPA, Washington, DC, EPA/600/R-05/004aF-cF, 2006. This document is contained in Docket EPA-HQ-OAR-2005-0161.
- ⁷⁵³ U.S. EPA. Air Quality Criteria for Ozone and Related Photochemical Oxidants (Final). U.S. EPA, Washington, DC, EPA/600/R-05/004aF-cF, 2006. This document is contained in Docket EPA-HQ-OAR-2005-0161.
- ⁷⁵⁴ Ollinger, S.V., J.D. Aber and P.B. Reich. 1997. "Simulating ozone effects on forest productivity: interactions between leaf canopy and stand level processes." *Ecological Applications* 7:1237-1251.

- 755 Winner, W.E., 1994. "Mechanistic analysis of plant responses to air pollution." *Ecological Applications*, 4(4):651-661.
- 756 U.S. EPA. Air Quality Criteria for Ozone and Related Photochemical Oxidants (Final). U.S. EPA, Washington, DC, EPA/600/R-05/004aF-cF, 2006. **This document is contained in Docket EPA-HQ-OAR-2005-0161.**
- 757 U.S. EPA. Air Quality Criteria for Ozone and Related Photochemical Oxidants (Final). U.S. EPA, Washington, DC, EPA/600/R-05/004aF-cF, 2006. **This document is contained in Docket EPA-HQ-OAR-2005-0161.**
- 758 Fox, S., and R. A. Mickler, eds. 1996. *Impact of Air Pollutants on Southern Pine Forests*. Springer-Verlag, NY, Ecol. Studies, Vol. 118, 513 pp.
- 759 De Steiguer, J., J. Pye, C. Love. 1990. "Air Pollution Damage to U.S. Forests." *Journal of Forestry*, Vol 88 (8) pp. 17-22.
- 760 Pye, J.M. 1988. "Impact of ozone on the growth and yield of trees: A review." *Journal of Environmental Quality* 17 pp.347-360.
- 761 U.S. EPA. Air Quality Criteria for Ozone and Related Photochemical Oxidants (Final). U.S. EPA, Washington, DC, EPA/600/R-05/004aF-cF, 2006. **This document is contained in Docket EPA-HQ-OAR-2005-0161.**
- 762 U.S. EPA. Air Quality Criteria for Ozone and Related Photochemical Oxidants (Final). U.S. EPA, Washington, DC, EPA/600/R-05/004aF-cF, 2006. **This document is contained in Docket EPA-HQ-OAR-2005-0161.**
- 763 McBride, J.R., P.R. Miller, and R.D. Laven. 1985. "Effects of oxidant air pollutants on forest succession in the mixed conifer forest type of southern California." In: *Air Pollutants Effects On Forest Ecosystems, Symposium Proceedings*, St. P, 1985, p. 157-167.
- 764 Miller, P.R., O.C. Taylor, R.G. Wilhour. 1982. Oxidant air pollution effects on a western coniferous forest ecosystem. Corvallis, OR: U.S. Environmental Protection Agency, Environmental Research Laboratory (EPA600-D-82-276).
- 765 U.S. EPA. Air Quality Criteria for Ozone and Related Photochemical Oxidants (Final). U.S. EPA, Washington, DC, EPA/600/R-05/004aF-cF, 2006. **This document is contained in Docket EPA-HQ-OAR-2005-0161.**
- 766 Kopp, R. J.; Vaughn, W. J.; Hazilla, M.; Carson, R. 1985. "Implications of environmental policy for U.S. agriculture: the case of ambient ozone standards." *J. Environ. Manage.* 20:321-331.
- 767 Adams, R. M.; Hamilton, S. A.; McCarl, B. A. 1986. "The benefits of pollution control: the case of ozone and U.S. agriculture." *Am. J. Agric. Econ.* 34: 3-19.
- 768 Adams, R. M.; Glycer, J. D.; Johnson, S. L.; McCarl, B. A. 1989. "A reassessment of the economic effects of ozone on U.S. agriculture." *JAPCA* 39:960-968.
- 769 Abt Associates, Inc. 1995. Urban ornamental plants: sensitivity to ozone and potential economic losses. U.S. EPA, Office of Air Quality Planning and Standards, Research Triangle Park. Under contract to RADIANT Corporation, contract no. 68-D3-0033, WA no. 6. pp. 9-10.
- 770 U. S. EPA. 1999 National-Scale Air Toxics Assessment. <http://www.epa.gov/ttn/atw/nata1999/risksum.html>
- 771 U.S. EPA (2007) Control of Hazardous Air Pollutants from Mobile Sources. 72 FR 8428; February 26, 2007.
- 772 U.S. EPA (2003) Integrated Risk Information System File of Acrolein. National Center for Environmental Assessment, Office of Research and Development, Washington, D.C. 2003. This material is available electronically at <http://www.epa.gov/iris/subst/0364.htm>.
- 773 U.S. EPA (2006) National-Scale Air Toxics Assessment for 1999. This material is available electronically at <http://www.epa.gov/ttn/atw/nata1999/risksum.html>.
- 774 U.S. EPA (2006) National-Scale Air Toxics Assessment for 1999. <http://www.epa.gov/ttn/atw/nata1999>.
- 775 U.S. EPA. 2000. Integrated Risk Information System File for Benzene. This material is available electronically at, <http://www.epa.gov/iris/subst/0276.htm>
- 776 International Agency for Research on Cancer, IARC monographs on the evaluation of carcinogenic risk of chemicals to humans, Volume 29, Some industrial chemicals and dyestuffs, International Agency for Research on Cancer, World Health Organization, Lyon, France, p. 345-389, 1982.
- 777 Irons, R.D.; Stillman, W.S.; Colagiovanni, D.B.; Henry, V.A. (1992) Synergistic action of the benzene metabolite hydroquinone on myelopoietic stimulating activity of granulocyte/macrophage colony-stimulating factor in vitro, *Proc. Natl. Acad. Sci.* 89:3691-3695.
- 778 International Agency for Research on Cancer (IARC), 1987. Monographs on the evaluation of carcinogenic risk of chemicals to humans, Volume 29: Supplement 7, Some industrial chemicals and dyestuffs, World Health Organization, Lyon, France.
- 779 U.S. Department of Health and Human Services National Toxicology Program 11th Report on Carcinogens available at: <http://ntp.niehs.nih.gov/go/16183>.
- 780 Aksoy, M. (1989). Hematotoxicity and carcinogenicity of benzene. *Environ. Health Perspect.* 82: 193-197.
- 781 Goldstein, B.D. (1988). Benzene toxicity. *Occupational medicine. State of the Art Reviews.* 3: 541-554.
- 782 Rothman, N., G.L. Li, M. Dosemeci, W.E. Bechtold, G.E. Marti, Y.Z. Wang, M. Linet, L.Q. Xi, W. Lu, M.T. Smith, N. Titenko-Holland, L.P. Zhang, W. Blot, S.N. Yin, and R.B. Hayes (1996) Hematototoxicity among Chinese workers heavily exposed to benzene. *Am. J. Ind. Med.* 29: 236-246.
- 783 U.S. EPA 2002 Toxicological Review of Benzene (Noncancer Effects). Environmental Protection Agency, Integrated Risk Information System (IRIS), Research and Development, National Center for Environmental Assessment, Washington DC. This material is available electronically at <http://www.epa.gov/iris/subst/0276.htm>.
- 784 Qu, O.; Shore, R.; Li, G.; Jin, X.; Chen, C.L.; Cohen, B.; Melikian, A.; Eastmond, D.; Rappaport, S.; Li, H.; Rupa, D.; Suramaya, R.; Songnian, W.; Huifant, Y.; Meng, M.; Winnik, M.; Kwok, E.; Li, Y.; Mu, R.; Xu, B.; Zhang, X.; Li, K. (2003). HEI Report 115, Validation & Evaluation of Biomarkers in Workers Exposed to Benzene in China.
- 785 Qu, Q., R. Shore, G. Li, X. Jin, L.C. Chen, B. Cohen, et al. (2002). Hematological changes among Chinese workers with a broad range of benzene exposures. *Am. J. Industr. Med.* 42: 275-285.
- 786 Lan, Qing, Zhang, L., Li, G., Vermeulen, R., et al. (2004). Hematotoxically in Workers Exposed to Low Levels of Benzene. *Science* 306: 1774-1776.
- 787 Turtletaub, K.W. and Mani, C. (2003). Benzene metabolism in rodents at doses relevant to human exposure from Urban Air. *Research Reports Health Effect Inst. Report No.113*.

788 U.S. EPA. 2002. Health Assessment of 1,3-Butadiene. Office of Research and Development, National Center for Environmental Assessment, Washington Office, Washington, DC. Report No. EPA600-P-98-001F. This document is available electronically at <http://www.epa.gov/iris/supdocs/buta-sup.pdf>.

⁷⁸⁹ U.S. EPA. 2002 "Full IRIS Summary for 1,3-butadiene (CASRN 106-99-0)" Environmental Protection Agency, Integrated Risk Information System (IRIS), Research and Development, National Center for Environmental Assessment, Washington, DC <http://www.epa.gov/iris/subst/0139.htm>.

⁷⁹⁰ International Agency for Research on Cancer (IARC) (1999) Monographs on the evaluation of carcinogenic risk of chemicals to humans, Volume 71, Re-evaluation of some organic chemicals, hydrazine and hydrogen peroxide and Volume 97 (in preparation) World Health Organization, Lyon, France.

⁷⁹¹ U.S. Department of Health and Human Services National Toxicology Program 11th Report on Carcinogens available at: <http://ntp.niehs.nih.gov/go/16183>.

⁷⁹² Bevan, C.; Stadler, J.C.; Elliot, G.S.; et al. (1996) Subchronic toxicity of 4-vinylcyclohexene in rats and mice by inhalation. *Fundam. Appl. Toxicol.* 32:1-10.

⁷⁹³ U.S. EPA. 1987. Assessment of Health Risks to Garment Workers and Certain Home Residents from Exposure to Formaldehyde, Office of Pesticides and Toxic Substances, April 1987.

⁷⁹⁴ Hauptmann, M.; Lubin, J. H.; Stewart, P. A.; Hayes, R. B.; Blair, A. 2003. Mortality from lymphohematopoietic malignancies among workers in formaldehyde industries. *Journal of the National Cancer Institute* 95: 1615-1623.

⁷⁹⁵ Hauptmann, M.; Lubin, J. H.; Stewart, P. A.; Hayes, R. B.; Blair, A. 2004. Mortality from solid cancers among workers in formaldehyde industries. *American Journal of Epidemiology* 159: 1117-1130.

⁷⁹⁶ Pinkerton, L. E. 2004. Mortality among a cohort of garment workers exposed to formaldehyde: an update. *Occup. Environ. Med.* 61: 193-200.

⁷⁹⁷ Coggon, D, EC Harris, J Poole, KT Palmer. 2003. Extended follow-up of a cohort of British chemical workers exposed to formaldehyde. *J National Cancer Inst.* 95:1608-1615.

⁷⁹⁸ Conolly, RB, JS Kimbell, D Janszen, PM Schlosser, D Kalisak, J Preston, and FJ Miller. 2003. Biologically motivated computational modeling of formaldehyde carcinogenicity in the F344 rat. *Tox Sci* 75: 432-447.

⁷⁹⁹ Conolly, RB, JS Kimbell, D Janszen, PM Schlosser, D Kalisak, J Preston, and FJ Miller. 2004. Human respiratory tract cancer risks of inhaled formaldehyde: Dose-response predictions derived from biologically-motivated computational modeling of a combined rodent and human dataset. *Tox Sci* 82: 279-296.

⁸⁰⁰ Chemical Industry Institute of Toxicology (CIIT).1999. Formaldehyde: Hazard characterization and dose-response assessment for carcinogenicity by the route of inhalation. CIIT, September 28, 1999. Research Triangle Park, NC.

⁸⁰¹ International Agency for Research on Cancer (2006) Formaldehyde, 2-Butoxyethanol and 1-tert-Butoxypropan-2-ol. Monographs Volume 88. World Health Organization, Lyon, France.

⁸⁰² Agency for Toxic Substances and Disease Registry (ATSDR). 1999. Toxicological profile for Formaldehyde. Atlanta, GA: U.S. Department of Health and Human Services, Public Health Service. <http://www.atsdr.cdc.gov/toxprofiles/tp111.html>

⁸⁰³ WHO (2002) Concise International Chemical Assessment Document 40: Formaldehyde. Published under the joint sponsorship of the United Nations Environment Programme, the International Labour Organization, and the World Health Organization, and produced within the framework of the Inter-Organization Programme for the Sound Management of Chemicals. Geneva.

⁸⁰⁴ U.S. EPA (1988). Integrated Risk Information System File of Acetaldehyde. Research and Development, National Center for Environmental Assessment, Washington, DC. This material is available electronically at <http://www.epa.gov/iris/subst/0290.htm>.

⁸⁰⁵ U.S. Department of Health and Human Services National Toxicology Program 11th Report on Carcinogens available at: <http://ntp.niehs.nih.gov/go/16183>.

⁸⁰⁶ International Agency for Research on Cancer (IARC). 1999. Re-evaluation of some organic chemicals, hydrazine, and hydrogen peroxide. IARC Monographs on the Evaluation of Carcinogenic Risk of Chemical to Humans, Vol 71. Lyon, France.

⁸⁰⁷ U.S. EPA (1988). Integrated Risk Information System File of Acetaldehyde. This material is available electronically at <http://www.epa.gov/iris/subst/0290.htm>.

⁸⁰⁸ U.S. EPA. 2003. Integrated Risk Information System File of Acrolein. Research and Development, National Center for Environmental Assessment, Washington, DC. This material is available electronically at <http://www.epa.gov/iris/subst/0364.htm>.

⁸⁰⁹ Appleman, L.M., R.A. Woutersen, and V.J. Feron. (1982). Inhalation toxicity of acetaldehyde in rats. I. Acute and subacute studies. *Toxicology.* 23: 293-297.

⁸¹⁰ Myou, S.; Fujimura, M.; Nishi K.; Ohka, T.; and Matsuda, T. (1993) Aerosolized acetaldehyde induces histamine-mediated bronchoconstriction in asthmatics. *Am. Rev. Respir. Dis.* 148(4 Pt 1): 940-943.

⁸¹¹ Integrated Risk Information System File of Acrolein. Research and Development, National Center for Environmental Assessment, Washington, DC. This material is available at <http://www.epa.gov/iris/subst/0364.htm>

- 812 International Agency for Research on Cancer (IARC). 1995. Monographs on the evaluation of carcinogenic risk of chemicals to humans, Volume 63: Dry cleaning, some chlorinated solvents and other industrial chemicals. World Health Organization, Lyon, France.
- 813 Weber-Tschopp, A; Fischer, T; Gierer, R; et al. (1977) Experimentelle reizwirkungen von Acrolein auf den Menschen. *Int Arch Occup Environ Hlth* 40(2):117-130. In German
- 814 Sim, VM; Pattle, RE. (1957) Effect of possible smog irritants on human subjects. *J Am Med Assoc* 165(15):1908-1913.
- 815 Morris JB, Symanowicz PT, Olsen JE, et al. 2003. Immediate sensory nerve-mediated respiratory responses to irritants in healthy and allergic airway-diseased mice. *J Appl Physiol* 94(4):1563-1571.
- 816 Sim VM, Pattle RE. Effect of possible smog irritants on human subjects *JAMA* 165: 1980-2010, 1957.
- 817 U. S. EPA. 2004. Toxicological Review of Naphthalene (Reassessment of the Inhalation Cancer Risk), Environmental Protection Agency, Integrated Risk Information System, Research and Development, National Center for Environmental Assessment, Washington, DC. This material is available electronically at <http://www.epa.gov/iris/subst/0436.htm>.
- 818 Oak Ridge Institute for Science and Education. (2004). External Peer Review for the IRIS Reassessment of the Inhalation Carcinogenicity of Naphthalene. August 2004. <http://cfpub.epa.gov/ncea/cfm/recorddisplay.cfm?deid=84403>
- 819 National Toxicology Program (NTP). (2004). 11th Report on Carcinogens. Public Health Service, U.S. Department of Health and Human Services, Research Triangle Park, NC. Available from: <http://ntp-server.niehs.nih.gov>.
- 820 International Agency for Research on Cancer (IARC). (2002). Monographs on the Evaluation of the Carcinogenic Risk of Chemicals for Humans. Vol. 82. Lyon, France.
- 821 U. S. EPA. 1998. Toxicological Review of Naphthalene, Environmental Protection Agency, Integrated Risk Information System, Research and Development, National Center for Environmental Assessment, Washington, DC. This material is available electronically at <http://www.epa.gov/iris/subst/0436.htm>
- 822 International Agency for Research on Cancer (IARC). 1988. Monographs on the evaluation of carcinogenic risk of chemicals to humans, Volume 44: Alcohol Drinking. World Health Organization, Lyon, France.
- 823 U.S. Department of Health and Human Services. 2005. National Toxicology Program 11th Report on Carcinogens available at: ntp.niehs.nih.gov/index.cfm?objectid=32BA9724-F1F6-975E-7FCE50709CB4C932.
- 824 U.S. Department of Health and Human Services. 2000. 10th Special Report to the U.S. Congress on Alcohol and Health. June. 2000.
- 825 Goodlett CR, KH Horn, F Zhou. 2005. Alcohol teratogenesis: mechanisms of damage and strategies for intervention. *Exp. Biol. Med.* 230:394-406.
- 826 Riley EP, CL McGee. 2005. Fetal alcohol spectrum disorders: an overview with emphasis on changes in brain and behavior. *Exp. Biol. Med.* 230:357-365.
- 827 Zhang X, JH Sliwowska, J Weinberg. 2005. Prenatal alcohol exposure and fetal programming: effects on neuroendocrine and immune function. *Exp. Biol. Med.* 230:376-388.
- 828 Riley EP, CL McGee, ER Sowell. 2004. Teratogenic effects of alcohol: a decade of brain imaging. *Am. J. Med. Genet. Part C: Semin. Med. Genet.* 127:35-41.
- 829 Gunzerath L, V Faden, S Zakhari, K Warren. 2004. National Institute on Alcohol Abuse and Alcoholism report on moderate drinking. *Alcohol. Clin. Exp. Res.* 28:829-847.
- 830 World Health Organization (WHO). 2004. Global status report on alcohol 2004. Geneva, Switzerland: Department of Mental Health and Substance Abuse. Available: http://www.who.int/substance_abuse/publications/global_status_report_2004_overview.pdf
- 831 Chen W-JA, SE Maier, SE Parnell, FR West. 2003. Alcohol and the developing brain: neuroanatomical studies. *Alcohol Res. Health* 27:174-180.
- 832 Driscoll CD, AP Streissguth, EP Riley. 1990. Prenatal alcohol exposure comparability of effects in humans and animal models. *Neurotoxicol. Teratol.* 12:231-238.
- 833 EPA. 2005. Full IRIS Summary for n-Hexane (CASRN 11054-3). Integrated Risk Information System (IRIS), Office of Research and Development, National Center for Environmental Assessment, Washington, DC. Available at www.epa.gov/iris/subst/0486.htm.
- 834 U.S. EPA. 2006. Air quality criteria for ozone and related photochemical oxidants (Ozone CD). Research Triangle Park, NC: National Center for Environmental Assessment; report no. EPA/600/R-05/004aF-cF.3v. page 5-78 Available at <http://cfpub.epa.gov/ncea/>.
- 835 U.S. EPA Air Quality Criteria for Ozone and Related Photochemical Oxidants (Final). U.S. Environmental Protection Agency, Washington, D.C., EPA 600/R-05/004aF-cF, 2006. page 5-63. This document is available in

Docket EPA-HQ-OAR-2005-0161. This document may be accessed electronically at:

http://www.epa.gov/ttn/naaqs/standards/ozone/s_o3_cr_cd.html

⁸³⁶ U.S. EPA Air Quality Criteria for Ozone and Related Photochemical Oxidants (Final). U.S. Environmental Protection Agency, Washington, D.C., EPA 600/R-05/004aF-cF, 2006. page 5-78. This document is available in Docket EPA-HQ-OAR-2005-0161. This document may be accessed electronically at:

http://www.epa.gov/ttn/naaqs/standards/ozone/s_o3_cr_cd.html

⁸³⁷ Inhalation health effect concerns for volatilized a.i. compounds are discussed for individual products, e.g., oxydimeton-methyl, carbaryl (and carbamates, generally), diazinon, at

<http://www.epa.gov/pesticides/reregistration/status.htm> . A.I. vapor pressure and a discussion of product volatilization can be found at <http://www.epa.gov/ttn/chief/ap42/ch09/final/c9s02-2.pdf>

⁸³⁸ U.S. EPA Integrated Risk Information System (IRIS) database is available at: www.epa.gov/iris

⁸³⁹ Nouchi I, S Toyama. 1998. Effects of ozone and peroxyacetyl nitrate on polar lipids and fatty acids in leaves of morning glory and kidney bean. *Plant Physiol.* 87:638-646.

⁸⁴⁰ Oka E, Y Tagami, T Oohashi, N Kondo. 2004. A physiological and morphological study on the injury caused by exposure to the air pollutant, peroxyacetyl nitrate (PAN), based on the quantitative assessment of the injury. *J Plant Res.* 117:27-36.

⁸⁴¹ Sun E-J, M-H Huang. 1995. Detection of peroxyacetyl nitrate at phytotoxic level and its effects on vegetation in Taiwan. *Atmos. Env.* 29:2899-2904.

⁸⁴² Koukol J, WM Dugger, Jr., RL Palmer. 1967. Inhibitory effect of peroxyacetyl nitrate on cyclic photophosphorylation by chloroplasts from black valentine bean leaves. *Plant Physiol.* 42:1419-1422.

⁸⁴³ Thompson CR, G Kats. 1975. Effects of ambient concentrations of peroxyacetyl nitrate on navel orange trees. *Env. Sci. Technol.* 9:35-38.

⁸⁴⁴ Bytnerowicz A, ME Fenn. 1995. Nitrogen deposition in California forests: A Review. *Environ. Pollut.* 92:127-146.

⁸⁴⁵ US EPA. 1991. Effects of organic chemicals in the atmosphere on terrestrial plants. EPA/600/3-91/001.

⁸⁴⁶ Cape JN, ID Leith, J Binnie, J Content, M Donkin, M Skewes, DN Price AR Brown, AD Sharpe. 2003. Effects of VOCs on herbaceous plants in an open-top chamber experiment. *Environ. Pollut.* 124:341-343.

⁸⁴⁷ Cape JN, ID Leith, J Binnie, J Content, M Donkin, M Skewes, DN Price AR Brown, AD Sharpe. 2003. Effects of VOCs on herbaceous plants in an open-top chamber experiment. *Environ. Pollut.* 124:341-343.

⁸⁴⁸ Viskari E-L. 2000. Epicuticular wax of Norway spruce needles as indicator of traffic pollutant deposition. *Water, Air, and Soil Pollut.* 121:327-337.

⁸⁴⁹ Ugrekhelidze D, F Korte, G Kvesitadze. 1997. Uptake and transformation of benzene and toluene by plant leaves. *Ecotox. Environ. Safety* 37:24-29.

⁸⁵⁰ Kammerbauer H, H Selinger, R Rommelt, A Ziegler-Jons, D Knoppik, B Hock. 1987. Toxic components of motor vehicle emissions for the spruce *Pinus abies*. *Environ. Pollut.* 48:235-243.

⁸⁵¹ Kwitkowski, J.R., McAloon, A., Taylor, F., Johnston, D.B., Modeling the process and costs of fuel ethanol production by the corn dry-grind process. *Industrial Crops and Products* 23 (2006) 288-296. A copy of the current USDA model can be obtained by contacting the corresponding author.

⁸⁵² Gallagher, P.W., Brubaker, H., and Shapouri, H. "Plant Size: Capital Cost Relationships in the Dry Mill Ethanol Industry," *Biomass and Bioenergy* Vol. 28. 2005. Pp. 565-7.

⁸⁵³ See Tables 4.1-21 and 4.1-22 of this section for biomass costs. Coal costs taken from EIA Annual Energy Outlook 2008 Table 15.

⁸⁵⁴ Bioenergy Feedstock Characteristics from Jonathan Scurlock, Oak Ridge National Laboratories, available at http://bioenergy.ornl.gov/papers/misc/biochar_factsheet.html (accessed October 1, 2008)

⁸⁵⁵ EIA Annual Energy Outlook 2008, Tables 8 and 13. Available at http://www.eia.doe.gov/oiaf/aeo/aeoref_tab.html

⁸⁵⁶ Corn Stover Collection Project, David A. Glassner, National Renewable Energy Laboratory, 1617 Cole Blvd., Golden, CO 80401, James R. Hettenhaus, Chief Executive Assistance, 3211

Trefoil Ave, Charlotte, NC 28226, and Thomas M. Schechinger, Iron Horse Custom Farming, 816 Iron Horse Rd, Harlan, IA 51537; in BioEnergy '98: Expanding BioEnergy Partnerships⁸⁵⁷ Abhijith Mukunda, Graduate Student School of Industrial Engineering, Purdue University, West Lafayette IN 47907, Klein E Ileleji, Assistant Professor, School of Agricultural & Biological Engineering, Purdue University, West Lafayette IN 47907, Hong Wan, Assistant Professor, School of Industrial Engineering, Purdue University, West Lafayette IN 47906, Simulation of Corn Stover Logistics from On-farm Storage to an Ethanol Plant, Paper Number: 0661772006, ASABE Annual International Meeting, Portland Convention Center, Portland, Oregon, 9 - 12 July 2006

⁸⁵⁸ Shahab Sokhansanj, , Anthony Turhollow, Oak Ridge National Laboratory, North Logan, UT 84341-8804, Janet Cushman, Oak Ridge National Laboratory, Oak Ridge, TN 37831-6422, John Cundiff, Biological Systems Engineering, Virginia Technical University, Blacksburg, VA 24061-0303, Engineering aspects of collecting corn stover for bioenergy, Biomass and Bioenergy 23 (2002) 347 – 355; Received 15 October 2001; received in revised form 15 April 2002; accepted 3 May 2002; 2002 Published by Elsevier Science Ltd.

⁸⁵⁹ David A. Glassner, National Renewable Energy Laboratory, Golden, CO 80401, James R. Hettenhaus, Chief Executive Assistance, Charlotte, NC 28226, and Thomas M. Schechinger, Iron Horse Custom Farming, Harlan, IA 51537; Corn Stover Collection Project, in BioEnergy '98: Expanding BioEnergy Partnerships

⁸⁶⁰ J.E. Atchison, Atchison Consultants, Inc., J. R. Hettenhaus, Chief Executive Assistance, Inc. Charlotte, North Carolina, National Renewable Energy Laboratory Golden, Colorado, .Innovative Methods for Corn Stover Collecting, Handling, Storing and Transporting, March 2003.

⁸⁶¹ Daniel R. Petrolia, Department of Applied Economics, College of Food, Agriculture, and Natural Resources Sciences, University of Minnesota, The Economics of Harvesting and Transporting Corn Stover for Conversion to Fuel Ethanol: A Case Study for Minnesota, Staff Paper P06-12 August 2006

⁸⁶² Renee Saylor & Kenneth Von Bargen, Principal Investigators, Feasibility of Corn Residue Collection in Kearney, Nebraska Area, for Western Regional Biomass Energy Program, Report of findings, by University of Nebraska-Lincoln, Industrial Agricultural Products Center, Lincoln, NE 68583, September 1993.

⁸⁶³ John S. Cundiff, Professor, Robert D. Grisso, Professor, Biological Systems Engineering Dept(MS 0303), Virginia Tech, Blacksburg, VA 24061, Hosein Shapouri, Senior Agricultural Economist, U.S.D.A., Office of Energy Policy and New Uses, Washington DC 20250-3815, Economic Analysis of two Receiving Facility Designs for a Bioenergy Plant, Paper Number: 076051, 2007 ASABE Annual International Meeting, Sponsored by ASABE, Minneapolis Convention Center, Minneapolis, Minnesota, 17 - 20 June 2007

⁸⁶⁴ Kevin J. Shinnars – Professor of Agricultural Engineering, Ben N. Binversie – Graduate Research Assistant, Department of Biological Systems Engineering, University of Wisconsin, Madison, WI, Philippe Savoie – Research Scientist, Agriculture and Agri-Food Canada, Quebec, Canada, Whole-Plant Corn Harvesting for Biomass: Comparison of Single-Pass and Multiple-Pass Harvest Systems, Paper Number: 036089 2003 ASAE Annual International Meeting, Sponsored by ASAE, Riviera Hotel and Convention Center, Las Vegas, Nevada, USA, 27- 30 July 2003.

⁸⁶⁵ S. Sokhansanj, A. Turhollow, and R. Perlack, Oak Ridge National Laboratory, Tennessee, USA 37830, Stochastic Modeling of Costs of Corn Stover Costs Delivered to an Intermediate Storage Facility, Paper Number: 024190, Presented at: 2002 ASAE Annual International Meeting / CIGR XVth World Congress, Sponsored by ASAE and CIGR, Hyatt Regency Chicago, Chicago, Illinois, USA, July 28-July 31, 2002

⁸⁶⁶ D. Montross, Associate Professor, Scott A. Shearer, Professor, Timothy S. Stombaugh, Associate Extension Professor, Stephen F. Higgins, Research Specialist, and Samuel G. McNeill, Associate Extension Professor, Department of Biosystems and Agricultural Engineering, University of Kentucky, Lexington, Kentucky; and Shahab Sokhansanj, Professor, Oak Ridge National Laboratory, Environmental Sciences Division, Oak Ridge, Tennessee, Corn Stover Availability and Collection Efficiency Using Typical Hay Equipment, This article is published with the approval of the Director of the Kentucky Agricultural Experiment Station and designated Paper No. 04-05-066. Transactions of the ASABE, Vol. 50(3): 705–711 – 2007 American Society of Agricultural and Biological Engineers, ISSN 0001–2351.

⁸⁶⁷ American Society of Agricultural and Biological Engineers (ASABE), ASABE Standards, 2007, 54th Edition, Standards, Engineering Practices, Data, 2950 Niles Road, St. Joseph, MI 49085-9659.

⁸⁶⁸ William Edwards, extension economist, Machinery Management: Estimating Farm Machinery Costs, PM 710 Paper version, Revised November 2001; Electronic version Revised August 2005, University Extension, Iowa State University.

⁸⁶⁹ Mark Hanna, Extension Engineer, University Extension, Iowa State University, Ames Iowa, Estimating the Field Capacity of Farm Machines, File A3-24, April 2002.

⁸⁷⁰ Terry Kastens, Extension Agricultural Economist, Kansas State University Agricultural Experiment Station and Cooperative Extension Service, Farm Machinery Operation Cost Calculations, MF-2244 May 1997

⁸⁷¹ Machinery Cost Estimates: Forage Field Operations, University of Illinois Farm Business Management Handbook, University of Illinois Extension FBM 0203 Department of Agricultural and Consumer Economics • College of Agricultural, Consumer and Environmental Sciences, University of Illinois at Urbana-Champaign

⁸⁷² Tim Cross, Agricultural Economics, Agriculture Machinery Cost Calculation Methods, E12-2015-00-032-98, Agricultural Extension Service, The University of Tennessee Institute of Agriculture.

⁸⁷³ Agricultural Prices 2006 Summary, July 2007 United States, Department of Agriculture National Agricultural Statistics Service, Pr 1-3 (07)

⁸⁷⁴ National Agricultural Statistics Service, Quick Stats (Agricultural Statistics Data Base, State and County Data), USDA, <http://www.nass.usda.gov/>

⁸⁷⁵ L. O. Pordesimo, W. C. Edens, The University of Tennessee, Dept. of Biosystems Engineering and Environmental Science, Knoxville, TN, U.S.A., S. Sokhansanj Oak Ridge National Laboratory, Environmental Sciences Division, Oak Ridge, TN, U.S.A., Distribution of Above Ground Biomass in Corn , Stover, Paper Number: 02-6059; 2002 ASAE Annual International Meeting/CIGR XVth World Congress, Hyatt Regency Chicago, Chicago, Illinois, USA,; July 29-31, 2002.

⁸⁷⁶ Kevin J. Shinnars, Professor of Agricultural Engineering, Ben N. Binversie, Graduate Research Assistant, Department of Biological Systems Engineering, University of Wisconsin, Madison, WI, Philippe Savoie, Research Scientist, Agriculture and Agri-Food Canada, Quebec,

Canada; Harvest and Storage Of Wet and Dry Corn Stover As A Biomass Feedstock, Paper Number: 036088, 2003 ASAE Annual International Meeting Riviera Hotel and Convention Center, Las Vegas, Nevada, USA, 27- 30 July 2003

⁸⁷⁷ R.L. Graham, R.D. Perlack, and L.L. Wright, Environ. Sci. Div., Oak Ridge National Lab., Oak Ridge, TN 37831-6407; R. Nelson, Engineering Extension Programs, Kansas State Univ., Manhattan, KS 66506, and J. Sheehan, National Renewable Energy Lab., Golden, CO 80401. Current and Potential U.S. Corn Stover Supplies, Agronomy Journal 99:1–11, American Society of Agronomy, Madison, WI 53711 USA; doi:10.2134/agronj2005.0222 prepared 2005; published online 1 January 2007

⁸⁷⁸ Ron Kotrba, Ethanol Producer Magazine staff writer, The Great Biomass Inquisition, Ethanol Producer Magazine, January 2007.
http://ethanolproducer.com/article.jsp?article_id=2621&q=&page=all

⁸⁷⁹ Kevin J. Shinnars, Professor of Agricultural Engineering, Ben N. Binversie, Graduate Research Assistant, Department of Biological Systems Engineering, University of Wisconsin, Madison, WI, Philippe Savoie, Research Scientist, Agriculture and Agri-Food Canada, Quebec, Canada; Harvest and Storage Of Wet and Dry Corn Stover As A Biomass Feedstock, Paper Number: 036088, 2003 ASAE Annual International Meeting Riviera Hotel and Convention Center, Las Vegas, Nevada, USA, 27- 30 July 2003.

⁸⁸⁰ William Edwards, Extension Economist, Estimating Farm Machinery Costs, PM710, Machinery Management, University Extension, Iowa State University, revised November 2001

⁸⁸¹ Renee Sayler & Kenneth Von Barga, Principal Investigators, Feasibility of Corn Residue Collection in Kearney, Nebraska Area, for Western Regional Biomass Energy Program, Report of findings, by University of Nebraska-Lincoln, Industrial Agricultural Products Center, Lincoln, NE 68583, September 1993.

⁸⁸² Robert D. Grisso , Professor, Virginia Tech, Department of Biological Systems Engineering, Blacksburg, Virginia; Paul J. Jasa , Extension Engineer, Biological Systems Engineering Department, University of Nebraska, Lincoln, Nebraska; and Dale E. Rolofson , Farm Manager, Agri-Cross Farms, Inc. Greenwood, Nebraska. Corresponding author : Paul J. Jasa, Biological Systems Engineering Dept., University of Nebraska, Lincoln, Analysis of Traffic Patterns and Yield Monitor Data for Field Efficiency Determination, Paper No. 011013, Presented at the 2000 ASAE Annual Meeting, Applied Engineering in Agriculture Vol. 18(2): 171-178 (© 2002 American Society of Agricultural Engineers). A contribution of the University of Nebraska Agricultural Research Division, Lincoln, Nebraska. Journal Series No. 13335. Mention of trade and company names are for the reader and do not infer endorsement or preferential treatment of the products by the University of Nebraska, Lincoln.

⁸⁸³ Robert “Bobby” Grisso, Professor, and John C. Cundiff, Professor; and David H. Vaughan, Professor, Department of Biological Systems Engineering, Virginia Tech, Blacksburg, VA., Investigating Machinery Management Parameters with Computer Tools, Paper Number: 071030, Presented at 2007 ASABE Annual International Meeting, Minneapolis Convention Center, Minneapolis, Minnesota, 17 - 20 June 2007. Mention of trade and company names are for the reader and do not infer endorsement or preferential treatment of the products by Virginia Tech.

⁸⁸⁴ Poorna P. Ravula, Robert D. Grisso and John S. Cundiff, Biological Systems Engineering Department, Virginia Tech, Blacksburg, VA 24061-0303, Comparison between Two Policy Strategies for Scheduling in a Biomass Logistic System, Paper Number: 071095, Presented at the

2007 ASABE Annual International Meeting, Sponsored by ASABE, Minneapolis Convention Center

⁸⁸⁵ International Fire Code 2903.4: Agricultural Products. Hay, straw or similar agricultural products shall not be stored adjacent to structures of combustible materials. Storage shall be limited to stacks of 100 tons (91 metric tons) each. Stacks shall be separated by a minimum of 20 feet (6096 mm) of clear space. Quantities of hay, straw and other agricultural products shall not be limited where stored in or near farm structures located outside closely built areas. A permit shall not be required for agricultural storage.

⁸⁸⁶ Daniel R. Petrolia, Department of Applied Economics, College of Food, Agriculture, and Natural Resources Sciences, University of Minnesota, The Economics of Harvesting and Transporting Corn Stover for Conversion to Fuel Ethanol: A Case Study for Minnesota, Staff Paper P06-12 August 2006

⁸⁸⁷ Robert D. Perlack, Anthony F. Turhollow, Oak Ridge National Laboratory, Office of Scientific and Technical Information, Oak Ridge, TN 37831, Assessment of Options For The Collection, Handling, and Transport of Corn Stover, ORNL/TM-2002/44, September 2002, Office of Energy Efficiency and Renewable Energy, Biomass Program, U.S. Department of Energy.

⁸⁸⁸ Dr. R.L. (Bob) Nielsen, Agronomy Department, Purdue University, West Lafayette, IN 47907-1150; Questions Relative to Harvesting & Storing Corn Stover; Prepared September 1995. Originally published as Agronomy Extension publication AGRY-95-09.

⁸⁸⁹ Ron Kotrba, staff writer, The Great Biomass Inquisition, Ethanol Producer Magazine. January 2007 Issue. Reach him at rkotrba@bbibiofuels.com, © 2007 BBI International http://ethanolproducer.com/article.jsp?article_id=2621&q=&page=all

⁸⁹⁰ Ron Kotrba, staff writer, The Great Biomass Inquisition, Ethanol Producer Magazine. January 2007 Issue. Reach him at rkotrba@bbibiofuels.com, © 2007 BBI International http://ethanolproducer.com/article.jsp?article_id=2621&q=&page=all

⁸⁹¹ Graeme R Quick, Single-pass Corn and Stover Harvesters: Development and Performance. Proceedings of the International Conference on Crop Harvesting and Processing, 9-11 February 2003, Louisville, Kentucky USA, ASABE, St. Joseph, Mich.; ASAE Publication Number 701P1103e

⁸⁹² A. Aden, M. Ruth, K. Ibsen, J. Jechura, K. Neeves, J. Sheehan, and B. Wallace National Renewable Energy Laboratory (NREL); L. Montague, A. Slayton, and J. Lukas Harris Group, Seattle, Washington, Ethanol Process Design and Economics Utilizing Co-Current Dilute Acid Prehydrolysis and Enzymatic Hydrolysis for Corn Stover; June 2002; NREL is a U.S. Department of Energy Laboratory Operated by Midwest Research Institute • Battelle • Bechtel; Contract No. DE-AC36-99-GO10337

⁸⁹³ Robert M. Prewitt, Graduate Research Assistant, Michael D. Montross, Associate Professor, Scott A. Shearer, Professor, Timothy S. Stombaugh, Associate Extension Professor, Stephen F. Higgins, Research Specialist, Samuel G. McNeill, Associate Extension Professor, Department of Biosystems and Agricultural Engineering, University of Kentucky, Lexington, KY; Shahab Sokhansanj, Professor, Oak Ridge National Laboratory, Environmental Sciences Division, Oak Ridge, TN, Corn Stover Availability and Collection Efficiency Using Typical Hay Equipment, Transactions of the American Society of Agricultural and Biological Engineers (ASABE), Vol. 50(3): 705–711, 2007, ISSN 0001–2351; Publication of this article approved by the Director of the Kentucky Agricultural Experiment Station and designated Paper No. 04-05-066.

⁸⁹⁴ Graeme R Quick, Single-pass Corn and Stover Harvesters: Development and Performance. Proceedings of the International Conference on Crop Harvesting and Processing, 9-11 February 2003, Louisville, Kentucky USA, ASABE, St. Joseph, Mich.; ASAE Publication Number 701P1103e

⁸⁹⁵ Kevin J. Shinnors, Professor of Agricultural Engineering, Graham S. Adsit, Graduate Research Assistant, Benjamin N. Binversie, Graduate Research Assistant, Matthew F. Digman, Graduate Research Assistant, Department of Biological Systems Engineering, University of Wisconsin, Richard E. Muck, Research Scientist, Paul. J. Weimer, Research Scientist, US Dairy Forage Research Center – USDA-ARS, Madison, WI, Characteristic Performance and Yields using a Single-Pass, Split- Stream Maize Grain and Stover Harvester, Paper Number: 056051, presented at the 2004 ASAE/CSAE Annual International and the 2005 ASAE Annual International Meeting, Sponsored by ASAE, Tampa Convention Center, Tampa, Florida 17 - 20 July 2005

⁸⁹⁶ Shahab Sokhansanj, , Anthony Turhollow, Oak Ridge National Laboratory, North Logan, UT 84341-8804, Janet Cushman, Oak Ridge National Laboratory, Oak Ridge, TN 37831-6422, John Cundiff, Biological Systems Engineering, Virginia Technical University, Blacksburg, VA 24061-0303, Engineering aspects of collecting corn stover for bioenergy, Biomass and Bioenergy 23 (2002) 347 – 355; Received 15 October 2001; received in revised form 15 April 2002; accepted 3 May 2002; 2002 Published by Elsevier Science Ltd.

⁸⁹⁷ Kevin J. Shinnors, Professor of Agricultural Engineering, Garrit C. Boettcher, Graduate Research Assistant, Jesse T. Munk, Graduate Research Assistant, Matthew F. Digman, Graduate Research Assistant, Department of Biological Systems Engineering, University of Wisconsin; Richard E. Muck, Research Engineer, Paul. J. Weimer, Research Scientist, US Dairy Forage Research Center, USDA-ARS, Madison, WI, Single-Pass, Split-Stream of Corn Grain and Stover: Characteristic Performance of Three Harvester Configurations, Presented at: ASABE Annual International Meeting, 2006; Oregon Convention Center, Portland, Oregon, 9 – 12 July 2006.

⁸⁹⁸ W. C. Edens, L. O. Pordesimo, The University of Tennessee, Dept. of Biosystems Engineering and Environmental Science, Knoxville, TN, S. Sokhansanj, Oak Ridge National Laboratory, Environmental Sciences Division, Oak Ridge, TN, Field Drying Characteristics and Mass Relationships of Corn Stover Fractions, Presented at the ASAE Annual International Meeting/ CIGR XVth World Congress, 2002, Hyatt Regency Chicago, Chicago, Illinois, USA, July 28-31, 2002.

⁸⁹⁹ Richard Hess, Idaho National Laboratory, Uniform Format Feedstock Supply System Design for Lignocellulosic Biomass, Western Region Biomass Workshop August 27, 2007 http://sungrant.oregonstate.edu/workshop/HESS_Western_RP_workshop.pdf

⁹⁰⁰ Kevin J. Shinnors, Professor of Agricultural Engineering, Ben N. Binversie, Graduate Research Assistant, Department of Biological Systems Engineering, University of Wisconsin, Madison, WI, Philippe Savoie, Research Scientist, Agriculture and Agri-Food Canada, Quebec, Canada; Harvest and Storage Of Wet and Dry Corn Stover As A Biomass Feedstock, Paper Number: 036088, 2003 ASAE Annual International Meeting Riviera Hotel and Convention Center, Las Vegas, Nevada, USA, 27- 30 July 2003.

⁹⁰¹ Shahab Sokhansanj and Janet Cushman, Bioenergy Feedstock Development Program Oak Ridge National Laboratory (ORNL), Feedstock Engineering, Presentation, Lincoln, NB, December 12, 2001 ORNL, Energy Efficiency and Renewable Energy, US DOE, USA

-
- ⁹⁰² Sudhagar Mani, Ph.D. Candidate, Shahab Sokhansanj, Adjunct Professor, Xiaotao Bi, Associate Professor, Department of Chemical & Biological Engineering, University of British Columbia, Vancouver, BC CANADA V6T 1Z4, Modeling of Forage Drying in Single and Triple Pass Rotary Drum Dryers, Paper Number: 056082, 2005 ASAE Annual International Meeting, Tampa Convention Center, Tampa, Florida, 17 - 20 July 2005
- ⁹⁰³ Xianzhe Zheng, Professor, Yiyuan Jiang, Professor, College of Engineering, North East Agricultural University, Harbin, China; Yubin Lan, Associate Professor, Agricultural Engineering Technology, Fort Valley State University, University Systems of Georgia, Fort Valley, GA 31030, Determination of Parameters for an Alfalfa Rotary Dryer, Paper Number: 056186, 2005 ASAE Annual International Meeting, Tampa Convention Center, Tampa, Florida, 17 - 20 July 2005
- ⁹⁰⁴ This information came in a confidential, personal communication.
- ⁹⁰⁵ Christopher T. Wright , Peter A. Pryfogle, Nathan A. Stevens , J. Richard Hess , Corey W. Radtke , Idaho National Laboratory , Idaho Falls, ID, Value of Distributed Preprocessing of Biomass Feedstocks to a Bioenergy Industry, Paper No: 066151 Presented at the ASABE Annual International Meeting, 2006, Oregon Convention Center Portland, Oregon, 9 - 12 July 2006
- ⁹⁰⁶ Roger G. Ginder, Professor of Economics, Department of Economics, Iowa State University, Ames, Iowa 50011, Potential Infrastructure Constraints on Current Corn Based and Future Biomass Based U.S. Ethanol Production, Working Paper # 07018 , July 2007
- ⁹⁰⁷ E-mailed file from Robert Perlack, U.S. Department of Agriculture, May 2008.
- ⁹⁰⁸ Conversation with Bryce Stokes, U.S. Forestry Service, May 2008.
- ⁹⁰⁹ OECD, “Biofuels: Linking Support to Performance,” ITF Round Tables No. 138, March 2008.
- ⁹¹⁰ International Energy Agency (IEA), “Biofuels for Transport: An International Perspective,” 2004.
- ⁹¹¹ Goldemberg, J. as cited in Rothkopf, Garten, “A Blueprint for Green Energy in the Americas,” 2006.
- ⁹¹² Unicamp, “A Expansão do Proalcool como Programa de Desenvolvimento Nacional,” Powerpoint presentation at *Ethanol Seminar* in BNDES, 2006. As quoted in OECD, “Biofuels: Linking Support to Performance,” ITF Round Tables No. 138, March 2008.
- ⁹¹³ *Ibid.*
- ⁹¹⁴ *Ibid.*
- ⁹¹⁵ *Ibid.*
- ⁹¹⁶ Macedo. I.C., “Green house gases emissions in the production and use of ethanol from sugarcane in Brazil: The 2005/2006 Averages and a Prediction for 2020,” *Biomass and Bioenergy*, 2008.
- ⁹¹⁷ *Ibid.*
- ⁹¹⁸ Smeets E, Junginger M, Faaij A, Walter A, Dolzan P, Turkenburg W, “The sustainability of Brazilian ethanol-An Assessment of the possibilities of certified production,” *Biomass and Bioenergy*, 2008.
- ⁹¹⁹ Official Statistics of the U.S. Department of Commerce, USITC
- ⁹²⁰ Haas, M.J, A process model to estimate biodiesel production costs, *Bioresource Technology* 97 (2006) 671-678.

-
- ⁹²¹ Wright, Mark M; Brown, Robert C.; Comparative Economics of Biorefineries based on the Biochemical and Thermochemical Platforms, May 17, 2007.
- ⁹²² RFS1 final rule regulatory impact analysis, EPA420-R-07-004, April 2007, <http://epa.gov/otaq/renewablefuels/420r07004.pdf>
- ⁹²³ Infrastructure Requirements for an Expanded Fuel Ethanol Industry, Downstream Alternatives Inc., January 15, 2002.
- ⁹²⁴ RFS1 final rule regulatory impact analysis, EPA420-R-07-004, April 2007, <http://epa.gov/otaq/renewablefuels/420r07004.pdf>
- ⁹²⁵ Tables ES-9 and ES 10, Infrastructure Requirements for an Expanded Fuel Ethanol Industry, Downstream Alternatives Inc, January 15, 2002.
- ⁹²⁶ Petroleum Market Model of the National Energy Modeling System, Part 2, March 2006, DOE/EIA-059 (2006), [http://tonto.eia.doe.gov/FTPROOT/modeldoc/m059\(2006\)-2.pdf](http://tonto.eia.doe.gov/FTPROOT/modeldoc/m059(2006)-2.pdf) .
- ⁹²⁷ BNSF railway biodiesel freight cost information can be found at <http://www.bnsf.com/markets/agricultural/bnsf4024/cur/itm31001.txt>
- ⁹²⁸ National Petroleum News, Market Facts 2007, October 2007, www.npn.web.
- ⁹²⁹ National Petroleum News, Market Facts 2007, October 2007, www.npn.web.
- ⁹³⁰ Modeling the Effect of Renewable Fuels Standards 2, Prepared for the Environmental Protection Agency by Jacobs Consultancy under contract with Southwest Research Associates, August 2008.
- ⁹³¹ Table 12, Reference and High Price Cases, Annual Energy Outlook 2008; Energy Information Administration, Department of Energy, June 2008.
- ⁹³² Table 2, Reference Case, Annual Energy Outlook 2007; Energy Information Administration, Department of Energy, February 2007.
- ⁹³³ Table 2, Reference Case, Annual Energy Outlook 2008; Energy Information Administration, Department of Energy, June 2008.
- ⁹³⁴ D5798-99 (Reapproved 2004), ASTM International.
- ⁹³⁵ National Association of Convenience Stores (NACS) online annual price resource kit, NACS, February 2, 2006.
- ⁹³⁶ Combined local, state and federal gasoline taxes, American Petroleum Institute, January 2008.
- ⁹³⁷ Greene, David L.; Alternative Fuel Market Share as a Function of Fuel Availability and Price Advantage, 1997.
- ⁹³⁸ Brownstone, D., Small, K., 2005. Valuing time and reliability: assessing the evidence from road pricing demonstrations. *Trans. Res. Part A* 39, 279-293.
- ⁹³⁹ Brownstone, D., Ghose, D., Golob, T., Kazimi, C., Van Amelsfort, D., 2003. Driver's willingness-to-pay to reduce travel time: evidence from the San Diego I-15 Congestion Pricing Project. *Trans. Res. Part A* 37, 373-387.
- ⁹⁴⁰ Lam, T., Small, K., 2001. The value of time and reliability: measurement from a value pricing experiment. *Trans. Res. Part E* 37 (2-3), 231-251.
- ⁹⁴¹ Steimetz, S., Brownstone, D., 2005. Estimating consumers' 'Value of time' with noisy data: a multiple imputation approach. *Trans. Res. Part B* 39, 865-889.
- ⁹⁴² Spot Annual Crude Oil Prices for Western Texas Intermediate (WTI), Cushing Oklahoma; <http://tonto.eia.doe.gov/dnav/pet/hist/rwtca.htm>; Energy Information Administration, 2008.
- ⁹⁴³ National Annual Average Gasoline and Diesel Fuel Prices (all grades); http://tonto.eia.doe.gov/dnav/pet/pet_pri_gnd_dcus_nus_a.htm; Energy Information Administration, 2008.
- ⁹⁴⁴ U.S. Department of Agriculture, National Agricultural Statistics Service, "Crop and Plants, Field Corn", <http://www.nass.usda.gov>.
- ⁹⁴⁵ U.S. Department of Agriculture, "Acreage report", 2008, <http://usda.mannlib.cornell.edu/usda/current/Acre/Acre-06-30-2008.pdf>
- ⁹⁴⁶ Committee on Water Implications of Biofuels Production in the United States, National Research Council, *Water Implications of Biofuels Production in the United States*, The National Academies Press, 2008, page 3.

-
- ⁹⁴⁷ Huang , Wen-yuan, “Tight Supply and Strong Demand May Raise U.S. Nitrogen Fertilizer Prices”, *Amber Waves*, November 2007, page 7, available online at: <http://www.ers.usda.gov/AmberWaves/November07/PDF/TightSupply.pdf>.
- ⁹⁴⁸ U. S. Environmental Protection Agency, EPA Science Advisory Board, “Hypoxia in the Northern Gulf of Mexico”, EPA-SAB-08-003, December 2007, available on line at: [http://yosemite.epa.gov/sab/sabproduct.nsf/C3D2F27094E03F90852573B800601D93/\\$File/EPA-SAB-08-003complete.unsigned.pdf](http://yosemite.epa.gov/sab/sabproduct.nsf/C3D2F27094E03F90852573B800601D93/$File/EPA-SAB-08-003complete.unsigned.pdf).
- ⁹⁴⁹U. S. Department of Agriculture, Economic Research Service, “U.S. Fertilizer Use and Price”, <http://www.ers.usda.gov/Data/FertilizerUse>, April 2008.
- ⁹⁵⁰ Inhalation health effect concerns for volatilized a.i. compounds are discussed for individual products, e.g., oxydimeton-methyl, carbaryl (and carbamates,generally), diazinon, at <http://www.epa.gov/pesticides/reregistration/status.htm> . A.I. vapor pressure and a discussion of product volatilization can be found at <http://www.epa.gov/ttn/chief/ap42/ch09/final/c9s02-2.pdf>
- ⁹⁵¹ A discussion of acetochlor toxicity can be found in EPA’s Re-registration Eligibility Document (RED) for this product at <http://www.epa.gov/IRIS/subst/0521.htm>.
- ⁹⁵² A discussion of carbaryl toxicity can be found in EPA’s Re-registration Eligibility Document (RED) for this product at <http://www.epa.gov/IRIS/subst/0019.htm>.
- ⁹⁵³ A discussion of alachlor toxicity can be found in EPA’s Re-registration Eligibility Document (RED) for this product at <http://www.epa.gov/IRIS/subst/0129.htm>
- ⁹⁵⁴ See <http://www.irac-online.org/> , Insecticide Resistance Action Committee, for toxicity classifications and toxicity mode of action definitions used.
- ⁹⁵⁵ See carcinogen weight of evidence (WoE) determination and description of toxicity for methomyl at <http://www.epa.gov/pesticides/reregistration/REDS/0028red.pdf>
- ⁹⁵⁶ U. S. Department of Agriculture, Economic Research Service, “Farm Income and Costs: 2008 Farm Sector Income Forecast”, <http://www.ers.usda.gov/Briefing/FarmIncome/nationalestimates.htm> , August 2008.
- ⁹⁵⁷U. S. Environmental Protection Agency, EPA Science Advisory Board, op. cit., p. 7.
- ⁹⁵⁸ Secchi, S., J. Tyndall, L. Schulte, and H. Asbjornsen. “Raising the Stakes”, *Journal of Soil and Water Conservation*, Volume 63, Number. 3, 2008, pages 68A-73A.
- ⁹⁵⁹ McLachlan, M., M. Carter, C. Rustay, *Effects of the Conservation Reserve Program on Priority Mixed-grass Prairie Birds: A Conservation Effects Assessment Project, 2007*, available online at: <ftp://ftp-fc.sc.egov.usda.gov/NHQ/nri/ceap/Final%20BCR19%20CRP%20Report.pdf> .

⁹⁶⁰ Iowa State University Extension, *2007 Iowa Land Value Survey*, 2008, available online at: <http://www.extension.iastate.edu/Publications/FM1825.pdf>.

⁹⁶¹ U. S. Environmental Protection Agency, EPA Science Advisory Board, op. cit., p. 177.

⁹⁶² Wilhelm, W. W., J. M. F. Johnson, D. L. Karlen, and D. T. Lightle, “Corn Stover to Sustain Soil Organic Carbon Further Constrains Biomass Supply”, *Agronomy Journal*, Volume 99, 2007, pages 1665–1667.

⁹⁶³ U.S. Environmental Protection Agency, Office of Water, *Wadeable Streams Assessment: A Collaborative Survey of the Nation's Streams*, EPA 841-B-06-002, 2006, available online at: <http://www.epa.gov/owow/streamsurvey>.

⁹⁶⁴ U. S. Environmental Protection Agency, Office of Water, *National Water Quality Inventory: Report to Congress 2002 Reporting Cycle*, U.S. EPA 841-R-07-001, 2007, available online at <http://www.epa.gov/305b/2002report/>.

⁹⁶⁵ Paerl, H.W., D. Robin, D. R. Whitall , “Atmospheric Deposition of Nitrogen: Implications for Nutrient Over-Enrichment of Coastal Waters”, *Estuaries*, Volume 25, Number 4B, 2002, pages 677-693.

⁹⁶⁶ Chesapeake Bay Program, *Sources of Nitrogen Loads to the Bay*, available online at: http://www.chesapeakebay.net/status_nitrogensources.aspx?menuitem=19797

⁹⁶⁷ New York State Department of Environmental Conservation and Connecticut Department of Environmental Protection, *A Total Maximum Daily Load Analysis to Achieve Water Quality Standards for Dissolved Oxygen in Long Island Sound*, December 2000, available online at: <http://www.longislandsoundstudy.net/pubs/reports/Tmdl.pdf> .

⁹⁶⁸ Roberts, D. M., and J. E. Reuter, *DRAFT Lake Tahoe Total Maximum Daily Load Technical Report: California and Nevada*, California Regional Water Quality Control Board, Lahontan Region and Nevada Division of Environmental Protection, September 2007, available online at: http://www.waterboards.ca.gov/lahontan/water_issues/programs/tmdl/lake_tahoe/docs/laketahoe_tmdl_tchrpt.pdf .

⁹⁶⁹ Chesapeake Bay Program, Science and Technical Advisory Committee, *Workshop on Atmospheric Deposition of Nitrogen: Media Brief*, May 30, 2007, available online at: <http://www.chesapeake.org/stac/Press/AtmoNmediabrief.pdf>

⁹⁷⁰ Roberts, D. M., op.cit., page 4-164.

⁹⁷¹ Committee on Water Implications of Biofuels Production in the United States, National Research Council, op. cit.

-
- ⁹⁷² Louisiana Universities Marine Consortium, ‘Dead Zone’ Again Rivals Record Size, July 28, 2008, available online at:
<http://www.gulfhypoxia.net/research/shelfwidecruises/2008/PressRelease08.pdf>
- ⁹⁷³ Mississippi River/Gulf of Mexico Watershed Nutrient Task Force, “Gulf Hypoxia Action Plan 2008 for Reducing, Mitigating, and Controlling Hypoxia in the Northern Gulf of Mexico and Improving Water Quality in the Mississippi River Basin”, 2008, page 22, available online at: <http://www.epa.gov/msbasin/actionplan.htm>.
- ⁹⁷⁴ U. S. Environmental Protection Agency, EPA Science Advisory Board, op. cit.
- ⁹⁷⁵ Mississippi River/Gulf of Mexico Watershed Nutrient Task Force, op.cit., page 37.
- ⁹⁷⁶ Alexander, R.B., Smith, R.A., Schwarz, G.E., Boyer, E.W., Nolan, J.V., and Brakebill, J.W., “Differences in Phosphorus and Nitrogen Delivery to the Gulf of Mexico from the Mississippi River Basin”, *Environmental Science and Technology*, Volume 42, Number 3, 2008, pages 822–830, available online at:
<http://pubs.acs.org/cgi-bin/abstract.cgi/esthag/2008/42/i03/abs/es0716103.html>.
- ⁹⁷⁷ Donner, S. D. and Kucharik, C. J., 2008, “Corn-based Ethanol Production Compromises Goal of Reducing Nitrogen Export by the Mississippi River”, *PNAS*, Volume 105, Number 11, 2008, pages 4513–4518, available online at: <http://www.pnas.org/content/105/11/4513.full>.
- ⁹⁷⁸ U. S. Environmental Protection Agency, EPA Science Advisory Board, op.cit. page 205.
- ⁹⁷⁹ Institute for Agriculture and Trade Policy, *Staying home: How ethanol will change U.S. corn exports, 2006*, Minneapolis, MN, 26 pages, available online at:
<http://www.agobservatory.org/library.cfm?refid=96658> .
- ⁹⁸⁰ Mississippi River/Gulf of Mexico Watershed Nutrient Task Force, op.cit., page 15.
- ⁹⁸¹ Aulenbach, B.T., Buxton, H.T., Battaglin, W.A., and Coupe, R.H., *Streamflow and Nutrient Fluxes of the Mississippi-Atchafalaya River Basin and Subbasins for the Period of Record Through 2005: U.S. Geological Survey Open-File Report 2007-1080*, 2007, available online at: <http://toxics.usgs.gov/pubs/of-2007-1080/index.html>.
- ⁹⁸² U. S. Environmental Protection Agency, EPA Science Advisory Board, op. cit., p. 89.
- ⁹⁸³ Mississippi River/Gulf of Mexico Watershed Nutrient Task Force, op. cit., page 16.
- ⁹⁸⁴ Gassman, P.W., Reyes, M. R., Green, C. H. , Arnold, J. G. , “The Soil and Water Assessment Tool: Historical Development, Applications, and Future Research Directions”, *Transactions of the American Society of Agricultural and Biological Engineers*, Volume 50, Number 4, 2007, pages 1211-1240, available online at:
http://www.card.iastate.edu/environment/items/asabe_swat.pdf.

-
- ⁹⁸⁵ Arnold, J. G., R. S. Muttiah, R. Srinivasan, and P. M. Allen, “Regional Estimation of Base Flow and Groundwater Recharge in the Upper Mississippi Basin”, *Journal of Hydrology*, Volume 227, 2000, pages 21-40, available online at:
http://www.sciencedirect.com/science?_ob=ArticleURL&_udi=B6V6C-3YRVDK7-2&_user=14684&_rdoc=1&_fmt=&_orig=search&_sort=d&view=c&_version=1&_urlVersion=0&_userid=14684&md5=ede76b4f1132783167d829c06196e66d .
- ⁹⁸⁶ Jha, M., P. W. Gassman, S. Secchi, and J. Arnold, “Upper Mississippi River Basin Modeling System Part 2: Baseline Simulation Results”, in: *Coastal Hydrology and Processes* (Eds. V.P. Singh and Y.J. Xu), Water Resources Publications, Highland Ranch, CO, 2006, pages. 117-126.
- ⁹⁸⁷ Homer, C. C. Huang, L. Yang, B. Wylie and M. Coan. “[Development of a 2001 National Landcover Database for the United States](#)”, *Photogrammetric Engineering and Remote Sensing*, Volume 70, Number 7, 2004, pages 829-840, available online at
http://www.mrlc.gov/pdf/July_PERS.pdf .
- ⁹⁸⁸ U.S. Department of Agriculture, National Agricultural Statistic Service,
<http://www.nass.usda.gov/research/Cropland/SARS1a.htm>.
- ⁹⁸⁹ U.S. Department of Agriculture, Natural Resources Conservation Service,
<http://www.nrcs.usda.gov/technical/NRI> .
- ⁹⁹⁰ Conservation Technology Information Center, <http://www.ctic.purdue.edu/>.
- ⁹⁹¹ American Society of Agricultural and Biological Engineers, *Manure Production and Characteristics*. ASAE D384.2 MAR2005. available online at:
<http://asae.frymulti.com/abstract.asp?aid=19432&t=1>.
- ⁹⁹² Renewable Fuels Association, “Ethanol Biorefinery Locations,”
<http://www.ethanolrfa.org/industry/locations>, April 2008.
- ⁹⁹³ Chesapeake Bay Commission, *Biofuels and the Bay: Getting It Right to Benefit Farms, Forests and the Chesapeake*, Chesapeake Bay Commission, Annapolis, Maryland, 2007, 32 pages, available online at:
<http://www.chesbay.state.va.us/Publications/BiofuelsAndTheBay1.pdf>
- ⁹⁹⁴ Simpson, T. W., A. N. Sharpley, R.W. Howarth, H.W. Paerl, and K. R. Mankin, “The New Gold Rush: Fueling Ethanol Production while Protecting Water Quality”, *Journal of Environmental Quality*, Volume 37, 2008, pages 318-324.
- ⁹⁹⁵ Chesapeake Bay Foundation, 2007 State of the Bay, 2007, available online at:
<http://www.cbf.org/site/DocServer/2007SOTBReport.pdf?docID=10923>.
- ⁹⁹⁶ Chesapeake Bay Commission, op. cit., page 11.

-
- ⁹⁹⁷ U.S. Environmental Protection Agency, Region 7, *Environmental Laws Applicable to Construction and Operation of Ethanol Plants*, EPA-907-B-07-001, November 2007, 104 pages, available online at: http://www.epa.gov/region07/priorities/agriculture/ethanol_plants_manual.pdf
- ⁹⁹⁸ Regassa, T., Koelsch, R., Erickson, G., *Impact of Feeding Distillers Grains on Nutrient Planning for Beef Cattle Systems*, University of Nebraska-Lincoln Extension—RP190, 2008, 8 pages, available online at: <http://www.ianrpubs.unl.edu/epublic/live/rp190/build/rp190.pdf>
- ⁹⁹⁹ Jacob, M. D., Fox, J. T., Drouillard, J. S., Renter, D. G., Nagaraja, T. G., “Effects of Dried Distillers’ grain on Fecal Prevalence and Growth of *Escherichia Coli* O157 in Batch Culture Fermentations from Cattle”, *Applied and Environmental Microbiology*, Volume 74, Number 1, 2008, p. 38-43, available online at: <http://aem.asm.org/cgi/content/abstract/74/1/38>
- ¹⁰⁰⁰ U.S. Department of Agriculture, Natural Resources Conservation Service, “Comprehensive Nutrient Management Planning Technical Guidance”, *National Planning Procedures Handbook*, Part 600.5, available online at: <http://policy.nrcs.usda.gov/17088.wba>.
- ¹⁰⁰¹ Ruiz-Aguilar, G. M. L.; O’Reilly, K.; Alvarez, P. J. J., “Forum: A Comparison of Benzene and Toluene Plume Lengths for Sites Contaminated with Regular vs. Ethanol-amended Gasoline”, *Ground Water Monitoring and Remediation*, Volume 23, 2003, pages 48-53.
- ¹⁰⁰² Reilly, T.E., Dennehy, K.F., Alley, W.M., and Cunningham, W.L., *Ground-Water Availability in the United States: U.S. Geological Survey Circular 1323*, 2008, page 33, available online at <http://pubs.usgs.gov/circ/1323/>
- ¹⁰⁰³ McGuire, V.L, *Changes in Water Level and Storage in the High Plains Aquifer, Predevelopment to 2005: U.S. Geological Survey Fact Sheet 2007-3029*, 2007, available online at <http://pubs.usgs.gov/fs/2007/3029/> .
- ¹⁰⁰⁴ U.S. Environmental Protection Agency, *Consumer Fact Sheet on Nitrates/Nitrites*, available online at: <http://www.epa.gov/safewater/dwh/c-ioc/nitrates.html>
- ¹⁰⁰⁵ U.S. Environmental Protection Agency, Office of Water, *FACTOIDS: Drinking Water and Ground Water Statistics for 2007*, EPA 816-K-07-004, 2008, available online at: http://www.epa.gov/safewater/data/pdfs/data_factoids_2007.pdf
- ¹⁰⁰⁶ U.S. Environmental Protection Agency, *Consumer Fact Sheet on Atrazine*, available online at: http://www.epa.gov/safewater/contaminants/dw_contamfs/atrazine.html
- ¹⁰⁰⁷ See 40 CFR, Part 141, Subpart O, App. A.
- ¹⁰⁰⁸ U.S. Environmental Protection Agency, *A Review of Contaminant Occurrence in Public Water Systems*, EPA 816-R-99-006, 1999, available online at: http://www.epa.gov/OGWDW/occur/nov99_lo.pdf

¹⁰⁰⁹ U.S. Environmental Protection Agency, of *Occurrence Estimation Methodology and Occurrence Findings Report for the Six-Year Review of Existing National Primary Drinking Water Regulations*, Office of Water, EPA-815-R-03-006, 2003, pages 38 and 40, available online at http://epa.gov/OGWDW/standard/review/pdfs/support_6yr_occurrencemethods_final.pdf.

¹⁰¹⁰ U.S. Environmental Protection Agency, *Safe Drinking Water Information System (SDWIS) End of Year data for FY 2007*, 2007.

¹⁰¹¹ Gilliom, R. J., *The Quality of Our Nation's Waters Pesticides in the Nation's Streams and Ground Water, 1992-2001*: U.S. Geological Survey Circular 129, 2006, Tables 7A-1 to 7A-4, available online at: <http://water.usgs.gov/nawqa/pnsp/pubs/circ1291/appendix7/7a.html>

¹⁰¹² Committee on Water Implications of Biofuels Production in the United States, op. cit.

¹⁰¹³ Great Lakes Commission, *The Potential Impacts of Increased Corn Production for Ethanol in the Great Lakes-St. Lawrence River Region*, 2007, available online at: <http://www.glc.org/tributary/pubs/documents/EthanolPaper121807FINAL.pdf>.