



United States
Department of
Agriculture

Forest Service

Forest
Products
Laboratory

General
Technical
Report
FPL-GTR-190



Wood Handbook

Wood as an Engineering Material



Centennial Edition

Centennial Edition

Wood Handbook

Wood as an Engineering Material

Abstract

Summarizes information on wood as an engineering material. Presents properties of wood and wood-based products of particular concern to the architect and engineer. Includes discussion of designing with wood and wood-based products along with some pertinent uses.

Keywords: wood structure, physical properties (wood), mechanical properties (wood), lumber, wood-based composites, plywood, panel products, design, fastenings, wood moisture, drying, gluing, fire resistance, finishing, decay, preservation, wood-based products, heat sterilization, sustainable use

April 2010

Forest Products Laboratory. 2010. Wood handbook—Wood as an engineering material. General Technical Report FPL-GTR-190. Madison, WI: U.S. Department of Agriculture, Forest Service, Forest Products Laboratory. 508 p.

A limited number of free copies of this publication are available to the public from the Forest Products Laboratory, One Gifford Pinchot Drive, Madison, WI 53726–2398. This publication is also available online at www.fpl.fs.fed.us. Laboratory publications are sent to hundreds of libraries in the United States and elsewhere.

The Forest Products Laboratory is maintained in cooperation with the University of Wisconsin.

The use of trade or firm names in this publication is for reader information and does not imply endorsement by the United States Department of Agriculture (USDA) of any product or service.

The USDA prohibits discrimination in all its programs and activities on the basis of race, color, national origin, age, disability, and where applicable, sex, marital status, familial status, parental status, religion, sexual orientation, genetic information, political beliefs, reprisal, or because all or a part of an individual's income is derived from any public assistance program. (Not all prohibited bases apply to all programs.) Persons with disabilities who require alternative means for communication of program information (Braille, large print, audiotape, etc.) should contact USDA's TARGET Center at (202) 720–2600 (voice and TDD). To file a complaint of discrimination, write to USDA, Director, Office of Civil Rights, 1400 Independence Avenue, S.W., Washington, D.C. 20250–9410, or call (800) 795–3272 (voice) or (202) 720–6382 (TDD). USDA is an equal opportunity provider and employer.

Pesticide Precautionary Statement

This publication reports research involving pesticides. It does not contain recommendations for their use, nor does it imply that the uses discussed here have been registered. All uses of pesticides must be registered by appropriate State and/or Federal agencies before they can be recommended.

Caution: Pesticides can be injurious to humans, domestic animals, desirable plants, and fish or other wildlife, if they are not handled or applied properly. Use all pesticides selectively and carefully. Follow recommended practices for the disposal of surplus pesticides and pesticide containers.

Chapter 1 *Wood as a Sustainable Building Material*

Wood as a Green Building Material 1–1
 Forest Certification Programs 1–3
 Literature Cited 1–5

Chapter 2 *Characteristics and Availability of Commercially Important Woods*

Timber Resources and Uses 2–2
 Species Descriptions 2–3
 Imported Woods 2–18
 Scientific Name Index 2–41
 Literature Cited 2–45
 Additional References 2–45

Chapter 3 *Structure and Function of Wood*

Biological Structure of Wood at Decreasing Scales 3–2
 Microscopic Structure of Softwoods and Hardwoods 3–9
 Wood Technology 3–12
 Juvenile Wood and Reaction Wood 3–13
 Appearance of Wood as Sawn Lumber 3–13
 Wood Identification 3–16
 Literature Cited 3–16

Chapter 4 *Moisture Relations and Physical Properties of Wood*

Wood–Moisture Relationships 4–1
 Thermal Properties 4–10
 Electrical Properties 4–15
 Friction Properties 4–17
 Nuclear Radiation Properties 4–17
 Literature Cited 4–18
 Additional Reference 4–19

Chapter 5 *Mechanical Properties of Wood*

Orthotropic Nature of Wood 5–1
 Elastic Properties 5–2
 Strength Properties 5–3
 Vibration Properties 5–17
 Mechanical Properties of Clear Straight-Grained Wood 5–21
 Natural Characteristics Affecting Mechanical Properties 5–26
 Literature Cited 5–44
 Additional References 5–44

Chapter 6 *Commercial Lumber, Round Timbers, and Ties*

Hardwood Lumber 6–2
 Softwood Lumber 6–6
 Purchase of Lumber 6–12
 Round Timbers and Ties 6–18
 Commonly Used Lumber, Round Timber, and Tie Abbreviations 6–23
 References 6–25

Chapter 7 *Stress Grades and Design Properties for Lumber, Round Timber, and Ties*

Lumber 7–1
 Round Timbers and Ties 7–13
 Literature Cited 7–14
 Additional References 7–15

Chapter 8 *Fastenings*

Nails 8–1
 Spikes 8–9
 Staples 8–9
 Drift Bolts 8–10
 Wood Screws 8–10
 Lag Screws 8–12
 Bolts 8–14
 Connector Joints 8–19
 Metal Plate Connectors 8–25
 Joist Hangers 8–25
 Fastener Head Embedment 8–26
 Literature Cited 8–27
 Additional References 8–27

Chapter 9 *Structural Analysis Equations*

Deformation Equations 9–1
 Stress Equations 9–4
 Stability Equations 9–7
 Literature Cited 9–10
 Additional References 9–10

Chapter 10 *Adhesives with Wood Materials Bond Formation and Performance*

Surface Properties of Wood for Bonding 10–2
 Physical Properties of Wood for Bonding 10–5
 Adhesives 10–8
 Bonding Process 10–14
 Bonded Joints 10–18
 Testing and Performance 10–19
 Standards 10–22
 References 10–23

Chapter 11 *Wood-Based Composite Materials Panel Products, Glued-Laminated Timber, Structural Composite Lumber, and Wood–Nonwood Composite Materials*

- Scope 11–2
- Conventional Wood-Based Composite Panels 11–2
- Glulam Timber 11–17
- Structural Composite Lumber 11–20
- Wood–Nonwood Composite Materials 11–22
- Literature Cited 11–26

Chapter 12 *Mechanical Properties of Wood-Based Composite Materials*

- Elastic Properties 12–2
- Strength Properties 12–3
- Panel Products 12–3
- Timber Elements/Structural Composite Lumber 12–5
- Wood–Nonwood Composites 12–7
- Testing Standards 12–9
- Literature Cited 12–10

Chapter 13 *Drying and Control of Moisture Content and Dimensional Changes*

- Determination of Moisture Content 13–1
- Recommended Moisture Content 13–3
- Drying of Wood 13–5
- Moisture Control during Transit and Storage 13–13
- Dimensional Changes in Wood 13–15
- Design Factors Affecting Dimensional Change 13–17
- Wood Care and Installation during Construction 13–18
- Literature Cited 13–19

Chapter 14 *Biodeterioration of Wood*

- Fungus Damage and Control 14–1
- Bacteria 14–9
- Insect Damage and Control 14–9
- Marine Borer Damage and Control 14–13
- References 14–15

Chapter 15 *Wood Preservation*

- Wood Preservatives 15–1
- Selecting Preservatives 15–13
- Evaluating New Preservatives 15–13
- Preservative Effectiveness 15–13
- Effect of Species on Penetration 15–15
- Preparation of Wood for Treatment 15–15
- Application of Preservatives 15–18
- Quality Assurance for Treated Wood 15–25
- Effects on the Environment 15–26
- Recycling and Disposal of Treated Wood 15–26
- References 15–27

Chapter 16 *Finishing of Wood*

- Factors Affecting Finish Performance 16–2
- Exterior Wood Finishes 16–16
- Application of Finishes, Special Uses 16–24
- Finish Failure or Discoloration 16–25
- Finishing Interior Wood 16–32
- Wood Cleaners and Brighteners 16–34
- Paint Strippers 16–35
- Lead-Based Paint 16–36
- Literature Cited 16–37
- Additional References 16–37

Chapter 17 *Use of Wood in Buildings and Bridges*

- Light-Frame Buildings 17–1
- Post-Frame and Pole Buildings 17–4
- Log Buildings 17–6
- Heavy Timber Buildings 17–6
- Considerations for Wood Buildings 17–9
- Literature Cited 17–12

Chapter 18 *Fire Safety of Wood Construction*

- Fire Safety Design and Evaluation 18–1
- Fire-Performance Characteristics of Wood 18–8
- Fire-Retardant-Treated Wood 18–15
- Literature Cited 18–18
- Additional References 18–18

Chapter 19 *Specialty Treatments*

- Plasticizing Wood 19–1
- Modified Woods 19–4
- Paper-Based Plastic Laminates 19–12
- References 19–14

Chapter 20 *Heat Sterilization of Wood*

- Heat Treatment Standards 20–1
- Factors Affecting Heating Times 20–2
- Methods for Estimating Heating Times 20–5
- American Lumber Standard Committee (ALSC) Enforcement Regulations 20–9
- Quality Mark 20–11
- Other Considerations 20–11
- Literature Cited 20–13

Glossary

Index

We are proud to present this edition of the *Wood Handbook—Wood as an Engineering Material*, prepared and updated to include fascinating new developments in the field of wood utilization and released as part of the celebration of the Forest Products Laboratory's first 100 years of service to the public.

Efficient use of our nation's timber is of critical importance. This handbook is intended to serve as a primary reference on the use of wood in a variety of applications—from general construction to use of wood for decorative purposes. It provides engineers, architects, and others who use wood with a source of information on the various properties of wood, its relationship with moisture, and characteristics of various wood-based materials. Continuing research holds promise for wider and more efficient utilization of wood in an increasing number of applications.

This handbook was prepared by the Forest Products Laboratory (FPL), a research unit within the USDA Forest Service. The FPL, first established in 1910 in Madison, Wisconsin, was the first institution in the world to conduct general research on wood and its utilization. The information that resulted from many of its scientific investigations of wood and wood products over the past century is the primary basis for this handbook.

The *Wood Handbook* was first issued in 1935, and slightly revised in 1939, as an unnumbered publication. Further revisions in 1955, 1974, and 1987 were published by the U.S. Department of Agriculture as Agriculture Handbook No. 72. The 1999 revision was published by the FPL as General Technical Report FPL–GTR–113 and reprinted for broader distribution by the Forest Products Society.

The audience for the *Wood Handbook* is broad. Consequently, the coverage of each chapter is aimed at providing a general discussion of the topic, with references included for additional information. Thousands more publications are available on the FPL website (www.fpl.fs.fed.us).

Wood resources continue to play an important role in the world, from packaging materials to buildings to transportation structures. Wood has been useful to human societies for thousands of years; archeological discoveries have shown wood was used by ancient civilizations as a construction material, as a substrate for ornate decorative objects, and for providing the final resting place for royalty. These discoveries highlight the unique, long-lasting performance characteristics of wood, as many of these artifacts have survived for thousands of years. FPL continues on its journey of discovery and public service; working with cooperators from around the world, we are discovering information that covers the entire spectrum of wood science—from the use of wood in ancient societies to developing new theories that describe the fundamental structure of wood based on the emerging field of nanoscience. If our forests are managed wisely, and if we continue to build our intellectual capacity to meet the challenges of evolving human needs and changing wood characteristics, this amazing material that is wood will serve the public well for years to come.

Christopher D. Risbrudt, Director

Michael A. Ritter, Assistant Director

Theodore H. Wegner, Assistant Director

USDA Forest Service

Forest Products Laboratory

This edition of the *Wood Handbook—Wood as an Engineering Material* builds upon past editions, in particular the 1999 version, with some important additions and modifications:

- A chapter has been added that highlights the importance of wood as an environmentally responsible, sustainable material (Chapter 1).
- Low-magnification micrographs of cross sections of commercial wood species have been added (Chapter 2).
- An extensive discussion on the microscopic structure of wood and its foundational elements are presented (Chapter 3).
- Reference to the most recent research on properties of the wood cell wall, at the nanoscale, has been included (Chapter 5).
- To address the need to find uses for wood obtained from trees killed by invasive insect species as they propagate through various regions of the United States, a chapter has been added on heat-treating and sterilization procedures for wood products (Chapter 20).
- Important updates are included on wood–moisture interactions and wood preservation practices (Chapters 4 and 15).

The *Wood Handbook* originally focused on construction practices that utilized solid-sawn wood. Since its first printing, the state-of-the-art in wood construction practices and the range of wood-based products available to the consumer have changed considerably. Excellent printed reference and websites have been developed by various trade associations and wood products manufacturers that document, in detail, current design information for the ever-changing range of products available. We have made a concerted effort

to include the most current references, in addition to many historic ones, to help guide the reader to appropriate sources of information.

This 2010 edition was reviewed by numerous individuals from industry, academia, and government. Several dozen industry, university, and government colleagues reviewed various sections and chapters of this edition during various stages of revision. We gratefully acknowledge their contributions.

The following individuals provided in-depth technical reviews of this edition in its entirety: Donald Bender (Washington State University), David Green (USDA Forest Products Laboratory, retired), John Erickson (USDA Forest Products Laboratory, retired), Howard Rosen (USDA Forest Service, retired), World Nieh (USDA Forest Service), Robert White (USDA Forest Products Laboratory), and staff of the American Wood Council, American Forest & Paper Association. We gratefully acknowledge their contributions.

Although listing every technical author and contributor to the *Wood Handbook* would be nearly impossible—early editions did not even list individual contributors by name—we do acknowledge the authors of previous editions; they all made significant, noteworthy contributions.

Finally, we thank our many research cooperators from industry, academia, and other government agencies. By working with you we are able to continue developing the technical base for using wood, wood-based materials, and wood structural systems in a technically sound manner.

Robert J. Ross, Editor

*USDA Forest Service
Forest Products Laboratory*

Wood as a Sustainable Building Material

Robert H. Falk, Research General Engineer

Contents

Wood as a Green Building Material	1–1
Embodied Energy	1–1
Carbon Impact	1–2
Sustainability	1–3
Forest Certification Programs	1–3
Forest Stewardship Council (FSC)	1–4
Sustainable Forestry Initiative (SFI)	1–4
American Tree Farm System (ATFS)	1–4
Canadian Standards Association (CSA)	1–5
Programme for the Endorsement of Forest Certification (PEFC) Schemes	1–5
Additional Information	1–5
Literature Cited	1–5

Few building materials possess the environmental benefits of wood. It is not only our most widely used building material but also one with characteristics that make it suitable for a wide range of applications. As described in the many chapters of this handbook, efficient, durable, and useful wood products produced from trees can range from a minimally processed log at a log-home building site to a highly processed and highly engineered wood composite manufactured in a large production facility.

As with any resource, we want to ensure that our raw materials are produced and used in a sustainable fashion. One of the greatest attributes of wood is that it is a renewable resource. If sustainable forest management and harvesting practices are followed, our wood resource will be available indefinitely.

Wood as a Green Building Material

Over the past decade, the concept of green building¹ has become more mainstream and the public is becoming aware of the potential environmental benefits of this alternative to conventional construction. Much of the focus of green building is on reducing a building's energy consumption (such as better insulation, more efficient appliances and heating, ventilation, and air-conditioning (HVAC) systems) and reducing negative human health impacts (such as controlled ventilation and humidity to reduce mold growth). However, choosing building materials that exhibit positive environmental attributes is also a major area of focus. Wood has many positive characteristics, including low embodied energy, low carbon impact, and sustainability. These characteristics are important because in the United States, a little more than half the wood harvested in the forest ends up as building material used in construction.

Embodied Energy

Embodied energy refers to the quantity of energy required to harvest, mine, manufacture, and transport to the point of use a material or product. Wood, a material that requires a minimal amount of energy-based processing, has a low level

¹Green building is defined as the practice of increasing the efficiency with which buildings use resources while reducing building impacts on human health and the environment—through better siting, design, material selection, construction, operation, maintenance, and removal—over the complete building life cycle.

Table 1–1. Wood products industry fuel sources^a

Fuel source	Proportion used (%)
Net electricity	19
Natural gas	16
Fuel oil	3
Other (primarily biomass)	61

^aEPA (2007).

of embodied energy relative to many other materials used in construction (such as steel, concrete, aluminum, or plastic). The sun provides the energy to grow the trees from which we produce wood products; fossil fuels are the primary energy source in steel and concrete manufacture. Also, over half the energy consumed in manufacturing wood products in the United States is from biomass (or bioenergy) and is typically produced from tree bark, sawdust, and by-products of pulping in papermaking processes. The U.S. wood products industry is the nation's leading producer and consumer of bioenergy, accounting for about 60% of its energy needs (Table 1–1) (Murray and others 2006, EPA 2007). Solid-sawn wood products have the lowest level of embodied energy; wood products requiring more processing steps (for example, plywood, engineered wood products, flake-based products) require more energy to produce but still require significantly less energy than their non-wood counterparts.

In some plantation forest operations, added energy costs may be associated with the use of fertilizer, pesticides, and greenhouses to grow tree seedlings. During the harvesting operation, energy is used to power harvesting equipment and for transporting logs to the mill. Lumber milling processes that consume energy include log and lumber transport, sawing, planing, and wood drying. Kiln drying is the most energy-consuming process of lumber manufacture; however, bioenergy from a mill's waste wood is often used to heat the kilns. Unlike burning fossil fuels, using bioenergy for fuel is considered to be carbon neutral. Also, advances in kiln technologies over the past few decades have significantly reduced the amount of energy required in wood drying. Overall, the production of dry lumber requires about twice the energy of producing green (undried) lumber.

The Consortium for Research on Renewable Industrial Materials (CORRIM) found that different methods of forest management affect the level of carbon sequestration in trees (Perez-Garcia and others 2005). They found that shorter rotation harvests can sequester more total carbon than longer rotation harvests.

CORRIM also calculated differences in energy consumed and environmental impacts associated with resource extraction, materials production, transportation, and disposal of homes built using different materials and processes.

Their calculations show that the energy consumed in the manufacture of building materials (mining iron and coal for steel or harvesting wood for lumber) and the construction of a steel-framed house in Minneapolis is 17% greater than for a wood-framed house (Lippke and others 2004). The difference is even more dramatic if one considers the use of bioenergy in the manufacture of wood products. By this comparison, the steel-framed house uses 281% more non-bioenergy than the wood-framed house (Perez-Garcia and others 2005). Global warming potential, air emission index, and water emission index are all higher for steel construction than for wood construction (Table 1–2).

These analyses indicate that the amount of energy necessary to produce wood products is much less than comparable products made from other materials. If wood is substituted for these other materials (assuming similar durability allows equal substitution), energy is saved and emissions avoided each time wood is used, giving it a distinct environmental advantage over these other materials (Bowyer and others 2008).

Carbon Impact

The role of carbon in global climate change and its projected negative impact on ecosystem sustainability and the general health of our planet have never been more elevated in the public's consciousness.

Forests play a major role in the Earth's carbon cycle. The biomass contained in our forests and other green vegetation affects the carbon cycle by removing carbon from the atmosphere through the photosynthesis process. This process converts carbon dioxide and water into sugars for tree growth and releases oxygen into the atmosphere:

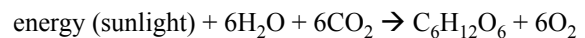

A substantial amount of carbon can be sequestered in forest trees, forest litter, and forest soils. Approximately 26 billion metric tonnes of carbon is sequestered within standing trees, forest litter, and other woody debris in domestic forests, and another 28.7 billion tonnes in forest soils (Birdsey and Lewis 2002). According to Negra and others (2008), between 1995 and 2005 the rate of carbon sequestration in U.S. forests was about 150 million tonnes annually (not including soils), a quantity of carbon equivalent to about 10% of total carbon emissions nationally.

Unfortunately, deforestation in tropical areas of the world is responsible for the release of stored carbon, and these forests are net contributors of carbon to the atmosphere. Tropical deforestation is responsible for an estimated 20% of total human-caused carbon dioxide emissions each year (Schimel and others 2001).

Carbon in wood remains stored until the wood deteriorates or is burned. A tree that remains in the forest and dies releases a portion of its carbon back into the atmosphere as the woody material decomposes. On the other hand, if the tree

Table 1–2. Environmental performance indices for above-grade wall designs in residential construction^a

	Wood frame	Steel frame	Difference	Change ^b (%)
Minneapolis design				
Embodied energy (GJ)	250	296	46	+18
Global warming potential (CO ₂ kg)	13,009	17,262	4,253	+33
Air emission index (index scale)	3,820	4,222	402	+11
Water emission index (index scale)	3	29	26	+867
Solid waste (total kg)	3,496	3,181	–315	–0.9
Atlanta design				
Embodied energy (GJ)	168	231	63	+38
Global warming potential (CO ₂ kg)	8,345	14,982	6,637	+80
Air emission index (index scale)	2,313	3,373	1,060	+46
Water emission index (index scale)	2	2	0	0
Solid waste (total kg)	2,325	6,152	3,827	+164

^aLippke and others (2004).

^b% change = [(Steel frame – Wood frame)/(Wood frame)] × 100.

is used to produce a wood or paper product, these products store carbon while in use. For example, solid wood lumber, a common wood product used in building construction (the building industry is the largest user of sawn wood in the United States), sequesters carbon for the life of the building. At the end of a building’s life, wood can be recovered for re-use in another structure, chipped for use as fuel or mulch, or sent to a landfill (usual fate). If burned or mulched, stored carbon is released when the wood decomposes, essentially the reverse process of photosynthesis:

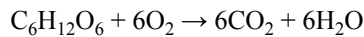

Carbon contained in wood products currently in-use and as wood debris in landfills is estimated at 2.5 billion tonnes and accumulates at a rate of about 28 million tonnes per year (Skog 2008). Much of the carbon contained within wood products resides in the nation’s housing stock, estimated at 116 million units in 2000. Skog (2008) estimated that in 2001, about 680 million tonnes of carbon was stored in the nation’s housing stock, nearly a third of the total carbon (2.5 billion tonnes) cited above.

As indicated in Table 1–3, carbon emitted to produce a tonne of concrete is about eight times that emitted to produce a tonne of framing lumber. A similar comparison for steel indicates that its production emits about 21 times as much carbon as an equal weight of framing lumber. Wood products also mitigate carbon emissions to the degree that they substitute for steel or concrete, which emit more greenhouse gases in their production.

Also, because wood products have this low level of embodied energy compared with other building products and because wood is one-half carbon by weight, wood products can actually be carbon negative (Bowyer and others 2008).

Comparisons of the environmental impact of various wood products have also been made using life cycle analysis software (Calkins 2009). The more processing involved in the manufacture of wood products (such as flaking, veneer cutting, added heat for pressing, gluing, kiln drying), the more impact on energy use, solid waste production, pollution production, and global warming potential (carbon).

Sustainability

Unlike metals and fossil-fuel-based products (such as plastics), our forest resource is renewable and with proper management a flow of wood products can be maintained indefinitely. The importance of forest-based products to our economy and standard of living is hard to overemphasize—half of all major industrial raw materials we use in the United States come from forests. However, the sustainability of this resource requires forestry and harvesting practices that ensure the long-term health and diversity of our forests. Unfortunately, sustainable practices have not always been applied in the past, nor are they universally applied around the world today. Architects, product designers, material specifiers, and homeowners are increasingly asking for building products that are certified to be from a sustainable source. For the forest products sector, the result of this demand has been the formation of forest certification programs. These programs not only ensure that the forest resource is harvested in a sustainable fashion but also that issues of biodiversity, habitat protection, and indigenous peoples’ rights are included in land management plans.

Forest Certification Programs

More than 50 different forest certification systems in the world today represent nearly 700 million acres of forestland and 15,000 companies involved in producing and

Table 1–3. Net carbon emissions in producing a tonne of various materials

Material	Net carbon emissions (kg C/t) ^{a,b}	Near-term net carbon emissions including carbon storage within material (kg C/t) ^{c,d}
Framing lumber	33	–457
Medium-density fiberboard (virgin fiber)	60	–382
Brick	88	88
Glass	154	154
Recycled steel (100% from scrap)	220	220
Concrete	265	265
Concrete ^e	291	291
Recycled aluminum (100% recycled content)	309	309
Steel (virgin)	694	694
Plastic	2,502	2,502
Aluminum (virgin)	4,532	4,532

^aValues are based on life-cycle assessment and include gathering and processing of raw materials, primary and secondary processing, and transportation.

^bSource: EPA (2006).

^cFrom Bowyer and others (2008); a carbon content of 49% is assumed for wood.

^dThe carbon stored within wood will eventually be emitted back to the atmosphere at the end of the useful life of the wood product.

^eDerived based on EPA value for concrete and consideration of additional steps involved in making blocks.

marketing certified products. These programs represent about 8% of the global forest area and 13% of managed forests. From 2007 to 2008, the world’s certified forest area grew by nearly 9%. North America has certified more than one-third of its forests and Europe more than 50% of its forests; however, Africa and Asia have certified less than 0.1%.

Approximately 80% to 90% of the world’s certified forests are located in the northern hemisphere, where two thirds of the world’s roundwood is produced (UNECE 2008). In North America, five major certification systems are used:

- Forest Stewardship Council (FSC)
- Sustainable Forestry Initiative (SFI)
- American Tree Farm System (ATFS)
- Canadian Standards Association (CSA)
- Programme for the Endorsement of Forest Certification (PEFC) schemes

In terms of forest acreage under certification, the Forest Stewardship Council and the Sustainable Forestry Initiative dominate in the United States. These two systems evolved from different perspectives of sustainability. The FSC’s guidelines are geared more to preserve natural systems while allowing for careful harvest, whereas the SFI’s guidelines are aimed at encouraging fiber

productivity while allowing for conservation of resources (Howe and others 2004). The growing trends in green building are helping drive certification in the construction market in the United States.

Forest Stewardship Council (FSC)



FSC is an independent, non-governmental organization established to promote responsible management of the world’s forests and is probably the most well-known forest certification program worldwide. More than 280 million acres of forest worldwide are certified to FSC standards and are distributed over 79 countries. The FSC program includes two types of certifications. The Forest Management Certification applies FSC standards of responsible forestry to management of the forest land. A Chain-of-Custody (COC) certification ensures that forest products that carry the FSC label can be tracked back to the certified forest from which they came. More than 9,000 COC certifications are in use by FSC members. The FSC has certified 18 certification bodies around the world. Four are located in the United States, including the non-profit Rainforest Alliance’s SmartWood program and the for-profit Scientific Certification Systems. Both organizations provide up-to-date lists of FSC-certified wood suppliers across the country.

Sustainable Forestry Initiative (SFI)



The SFI program was established in 1994 and currently certifies over 152 million acres in the United States and Canada. This program has a strong wood industry focus and has been adopted by most of the major industrial forest landowners in the United States. It is based on the premise that responsible forest practices and sound business decisions can co-exist. The SFI program includes third-party certification, which verifies the requirements of the SFI 2010–2014 Standard. Independent certification bodies evaluate planning, procedures, and processes in the forest and in wood processing operations. Annual surveillance audits are mandatory on all certified operations, and a full recertification audit is required for forest operations every 3 years.

American Tree Farm System (ATFS)



The American Tree Farm System, a program of the American Forest Foundation’s Center for Family Forests, is the oldest of forest certification programs and was established in 1941. The ATFS focuses its program on private family forest landowners in the United States. Currently, ATFS has certified 24 million acres of privately owned forestland and more than 90,000 family forest owners. The ATFS forest certification standard requires forest owners to develop

Chapter 1 Wood as a Sustainable Building Material

a management plan based on strict environmental standards and pass an inspection by an ATFS inspecting forester. Third-party certification audits, conducted by firms accredited by the ANSI–ASQ National Accreditation Board (ANAB) or the Standards Council of Canada (SCC), are required for all certifications of the ATFS.

Canadian Standards Association (CSA)



The Canadian Standards Association is a non-profit organization and has developed over 2,000 different standards for a variety of industries. The CSA first published Canada's National Standard for Sustainable Forest Management (SFM) CAN/CSA-Z809 in 1996. The SFM program has four components: the SFM Standard itself, a Chain-of-Custody program, product marking, and the CSA International Forest Products Group, which promotes the program. The CSA Standard has been adopted by the major industrial forestland managers in Canada. As of June 2007, about 60% (198 million acres) of Canadian forests were certified under the CAN/CSA-Z809 SFM Standard.

Programme for the Endorsement of Forest Certification (PEFC) Schemes



The multitude of certification programs with competing standards and claims has made it difficult for land managers, members of the wood industry, and consumers to determine which certification program fits their needs (Fernholz and others 2004).

The Programme for the Endorsement of Forest Certification schemes was developed to address this issue and serves as an umbrella endorsement system that provides international recognition for national forest certification programs. Founded in 1999, the PEFC represents most of the world's certified forest programs and the production of millions of tons of certified timber. The FSC, SFI, and ATFS programs have received official PEFC endorsement.

Additional Information

Helpful online tools provide more information and data on forest certification, including the Forest Certification Resource Center (www.metafore.org), which identifies forests, manufacturers, distributors, importers, and retailers certified under FSC, SFI, and CSA programs. The database is searchable by product, location, and certification system. Another helpful resource is the Forest Products Annual Market Review (www.unece.org), which provides general and statistical information on forest products markets in the United Nations Economic Commission for Europe (UNECE) and covers the regions of Europe, North America, and the Commonwealth of Independent States.

Literature Cited

- Birdsey, R.; Lewis, G. 2002. Carbon in U.S. forests and wood products, 1987–1997: state by state estimates. Gen. Tech. Rep. GTR–NE–310. Washington, DC: U.S. Department of Agriculture, Forest Service.
- Bowyer, J.; Bratkovich, S.; Lindberg, A.; Fernholz, K. 2008. Wood products and carbon protocols: carbon storage and low energy intensity should be considered. Minneapolis, MN: Dovetail Partners, Inc. www.dovetailinc.org. (28 April 2008). 13 p.
- Calkins, M. 2009. Materials for sustainable sites: a complete guide to the evaluation, selection, and use of sustainable construction materials. Hoboken, NJ: John Wiley & Sons. 457 p.
- EPA. 2006. Solid waste management and greenhouse gases—a life cycle assessment of emissions and sinks. 3rd Ed. Washington, DC: U.S. Environmental Protection Agency.
- EPA. 2007. Energy trends in selected manufacturing sectors: opportunities and challenges for environmentally preferable energy outcomes. Washington, DC: U.S. Environmental Protection Agency, Office of Policy, Economics and Innovation. (March 2007).
- Fernholz, K.; Howe, J.; Guillery, P.; Bowyer, J. 2004. Beginner's guide to third-party forest certification: shining a light on the programme for the endorsement of forest certification schemes (PEFC). Minneapolis, MN: Dovetail Partners, Inc. www.dovetailinc.org.
- Fernholz, K.; Howe, J.; Guillery, P.; Bowyer, J. 2005. Beginner's guide to third-party forest certification: shining a light on the Canadian Standards Association (CSA). Minneapolis, MN: Dovetail Partners, Inc. www.dovetailinc.org. (18 January 2005). 10 p.
- Howe, J.; Fernholz, K.; Guillery, P.; Bowyer, J. 2004. A land manager's guide to FSC & SFI—to certify or not to certify: is that a question? Minneapolis, MN: Dovetail Partners, Inc. www.dovetailinc.org. (15 September 2004). 13 p.
- Lippke, B.; Wilson, J.; Perez-Garcia, J.; Bowyer, J.; Meil, J. 2004. CORRIM: life-cycle environmental performance of renewable building materials. *Forest Products Journal*. 54(6): 13. (June 2004).
- Murray, B.; Nicholson, R.; Ross, M.; Holloway, T.; Patil, S. 2006. Biomass energy consumption in the forest products industry. Washington, DC: U.S. Department of Energy; Research Triangle Park, NC: RTI International. 81 p.
- Negra, C.; Sweedo, C.; Cavender-Bares, K.; O'Malley, R. 2008. Indicators of carbon storage in U.S. ecosystems: baseline for terrestrial carbon accounting. *Journal of Environmental Quality*. 37: 1376–1382.

Perez-Garcia, J.; Lippke, B.; Briggs, D.; Wilson, J.; Bowyer, J.; Meil, J. 2005. The environmental performance of renewable building materials in the context of residential construction. *Wood and Fiber Science*. (37)12: 3–17.

Schimel, D.S.; House, J.I.; Hibbard, K.A.; Bousquet, P.; Ciais, P.; Peylin, P.; Braswell, B.H.; Apps, M.J.; Baker, D.; Bondeau, A.; Canadell, J.; Churkina, G.; Cramer, W.; Denning, A.S.; Field, C.B.; Friedlingstein, P.; Goodale, C.; Heimann, M.; Houghton, R.A.; Melillo, J.M.; Moore, B., III; Murdiyarso, D.; Noble, I.; Pacala, S.W.; Prentice, I.C.; Raupach, M.R.; Rayner, P.J.; Scholes, R.J.; Steffen, W.L.; Wirth, C. 2001. Recent patterns and mechanisms of carbon exchange by terrestrial ecosystems. *Nature*. 414: 169–172.

Skog, K. 2008. Sequestration of carbon in harvested wood products for the United States. *Forest Products Journal*. 58(6): 56–72.

UNECE / FAO. 2008. Forest products annual market review 2007–2008. Geneva, Switzerland: United Nations Economic Commission for Europe / Food and Agriculture Organization. www.unece.org/trade/timber.

Characteristics and Availability of Commercially Important Woods

Michael C. Wiemann, Research Botanist

Contents

Timber Resources and Uses 2–2
Hardwoods and Softwoods 2–2
Commercial Sources of Wood Products 2–2
Use Classes and Trends 2–2
Species Descriptions 2–3
U.S. Hardwoods 2–3
U.S. Softwoods 2–11
Imported Woods 2–18
Imported Hardwoods 2–19
Imported Softwoods 2–38
Scientific Name Index 2–41
U.S. Wood Species—Hardwoods 2–41
U.S. Wood Species—Softwoods 2–42
Imported Woods—Hardwoods 2–43
Imported Woods—Softwoods 2–44
Literature Cited 2–45
Additional References 2–45

Throughout history, the unique characteristics and abundance of wood have made it a natural material for homes and other structures, furniture, tools, vehicles, and decorative objects. Today, for the same reasons, wood is prized for a multitude of uses.

All wood is composed of cellulose, lignin, hemicelluloses, and minor amounts (usually less than 10%) of extraneous materials contained in a cellular structure. Variations in the characteristics and proportions of these components and differences in cellular structure make woods heavy or light, stiff or flexible, and hard or soft. The properties of a single species are relatively constant within limits; therefore, selection of wood by species alone may sometimes be adequate. However, to use wood to its best advantage and most effectively in engineering applications, specific characteristics or physical properties must be considered.

Historically, some species filled many purposes, whereas other less available or less desirable species served only one or two needs. For example, because white oak is tough, strong, and durable, it was highly prized for shipbuilding, bridges, cooperage, barn timbers, farm implements, railroad crossties, fence posts, and flooring. Woods such as black walnut and cherry were used primarily for furniture and cabinets. Hickory was manufactured into tough, hard, and resilient striking-tool handles, and black locust was prized for barn timbers. It was commonly accepted that wood from trees grown in certain locations under certain conditions was stronger, more durable, more easily worked with tools, or finer grained than wood from trees in other locations. Modern research on wood has substantiated that location and growth conditions do significantly affect wood properties.

This chapter presents brief descriptions of many species; current and, in many cases, historic uses are cited to illustrate the utility of the wood.

Gradual reductions in use of old-growth forests in the United States have reduced the supply of large clear logs for lumber and veneer. However, the importance of high-quality logs has diminished as new concepts of wood use have been introduced. Second-growth wood, the remaining old-growth forests, and imports continue to fill the needs for wood in the quality required. Wood is as valuable an engineering material as ever, and in many cases, technological advances have made it even more useful.

Inherent factors that keep wood in the forefront of raw materials are many and varied, but a chief attribute is its

availability in many species, sizes, shapes, and conditions to suit almost every demand. Wood has a high ratio of strength to weight and a remarkable record for durability and performance as a structural material. Dry wood has good insulating properties against heat, sound, and electricity. It tends to absorb and dissipate vibrations under some conditions of use, and yet it is an incomparable material for musical instruments. The grain patterns and colors of wood make it an esthetically pleasing material, and its appearance may be easily enhanced by stains, varnishes, lacquers, and other finishes. It is easily shaped with tools and fastened with adhesives, nails, screws, bolts, and dowels. Damaged wood is easily repaired, and wood structures are easily remodeled or altered. In addition, wood resists oxidation, acid, saltwater, and other corrosive agents, has high salvage value, has good shock resistance, can be treated with preservatives and fire retardants, and can be combined with almost any other material for both functional and aesthetic uses.

Timber Resources and Uses

In the United States, more than 100 wood species are available to the prospective user; about 60% of these are of major commercial importance. Another 30 species are commonly imported in the form of logs, cants, lumber, and veneer for industrial uses, the building trade, and crafts.

A continuing program of timber inventory is in effect in the United States through the cooperation of Federal and State agencies, and new information on wood resources is published in State and Federal reports. Two of the most valuable sourcebooks are *An Analysis of the Timber Situation in the United States: 1952 to 2050* (Haynes 2003) and *The 2005 RPA Timber Assessment Update* (Haynes and others 2007). Current information on wood consumption, production, imports, and supply and demand is published periodically by the Forest Products Laboratory (Howard 2007).

Hardwoods and Softwoods

Trees are divided into two broad classes, usually referred to as hardwoods and softwoods. These names can be confusing because some softwoods are actually harder than some hardwoods, and conversely some hardwoods are softer than some softwoods. For example, softwoods such as longleaf pine and Douglas-fir are typically harder than the hardwoods basswood and aspen. Botanically, hardwoods are angiosperms; their seeds are enclosed in the ovary of the flower. Anatomically, hardwoods are porous; that is, they contain vessel elements. A vessel element is a wood cell with open ends; when vessel elements are set one above another, they form a continuous tube (vessel), which serves as a conduit for transporting water or sap in the tree. Typically, hardwoods are plants with broad leaves that, with few exceptions in the temperate region, lose their leaves in autumn or winter. Most imported tropical woods are hardwoods.

Botanically, softwoods are gymnosperms or conifers; their seeds are not enclosed in the ovary of the flower. Anatomically, softwoods are nonporous (they do not contain vessels). Softwoods are usually cone-bearing plants with needle- or scale-like evergreen leaves. Some softwoods, such as larches and baldcypress, lose their needles during autumn or winter.

Major resources of softwood species are spread across the United States, except for the Great Plains, where only small areas are forested. The hardwood resource is concentrated in the eastern United States, with only a few commercial species found in Washington, Oregon, and California. Softwood and hardwood species of the continental United States are often loosely grouped in three general regions, as shown in Table 2–1.

Commercial Sources of Wood Products

Softwoods are available directly from sawmills, wholesale and retail yards, or lumber brokers. Softwood lumber and plywood are used in construction for forms, scaffolding, framing, sheathing, flooring, moulding, paneling, cabinets, poles and piles, and many other building components. Softwoods may also appear in the form of shingles, sashes, doors, and other millwork, in addition to some rough products such as timber and round posts.

Hardwoods are used in construction for flooring, architectural woodwork, interior woodwork, and paneling. These items are usually available from lumberyards and building supply dealers. Most hardwood lumber and dimension stock are remanufactured into furniture, flooring, pallets, containers, dunnage, and blocking. Hardwood lumber and dimension stock are available directly from manufacturers, through wholesalers and brokers, and from some retail yards. Both softwood and hardwood products are distributed throughout the United States. Local preferences and the availability of certain species may influence choice, but a wide selection of woods is generally available for building construction, industrial uses, remanufacturing, and home use.

Use Classes and Trends

Major wood-based industries include those that convert wood to thin slices (veneer), particles (chips, flakes), or fiber pulps and reassemble the elements to produce various types of engineered panels such as plywood, particleboard, oriented strandboard, laminated veneer lumber, paper, paperboard, and fiberboard products. Another newer wood industry is the production of laminated wood products. The lumber industry has also produced smaller amounts of railroad crossties, cooperage, shingles, and shakes.

Table 2–1. Major resources of U.S. woods according to region

Western	Northern and Appalachian	Southern
Hardwoods		
Alder, red	Ash	Ash
Ash, Oregon	Aspen	Basswood
Aspen	Basswood	Beech
Birch, paper	Beech	Butternut
Cottonwood	Birch	Cottonwood
Maple, bigleaf	Buckeye	Elm
Oak, California black	Butternut	Hackberry
Oak, Oregon white	Cherry	Hickory
Tanoak	Cottonwood	Honeylocust
	Elm	Locust, black
	Hackberry	Magnolia
	Hickory	Maple, soft
	Honeylocust	Oak, red and white
	Locust, black	Sassafras
	Maple, hard	Sweetgum
	Maple, soft	Sycamore
	Oak, red and white	Tupelo
	Sycamore	Walnut
	Walnut	Willow
	Yellow-poplar	Yellow-poplar
Softwoods		
Douglas-fir	Cedar, northern white	Baldcypress
Fir, western	Fir, balsam	Cedar, Atlantic white
Hemlock, western and mountain	Hemlock, eastern	Fir, Fraser
Incense-cedar	Pine, eastern white	Pine, southern
Larch, western	Pine, Jack	Redcedar, eastern
Pine, lodgepole	Pine, red	
Pine, ponderosa	Redcedar, eastern	
Pine, sugar	Spruce, eastern	
Pine, western white	Tamarack	
Port-Orford-cedar		
Redcedar, western		
Redwood		
Spruce, Engelmann		
Spruce, Sitka		
Yellow-cedar		

Species Descriptions

In this chapter, each species or group of species is described in terms of its principal location, characteristics, and uses. More detailed information on the properties of these and other species is given in various tables throughout this handbook. Information on historical and traditional uses is provided for some species to illustrate their utility. A low-magnification micrograph of a representative cross-section of each species or species group accompanies each description. The slides for these micrographs are from the Forest Products Laboratory collection. The micrographs are printed at magnifications of approximately 15×. Their color is a consequence of the stains used to accentuate anatomical features and is not indicative of the actual wood color.

U.S. Hardwoods

Alder, Red



Red alder (*Alnus rubra*) grows along the Pacific coast between Alaska and California. It is the principal hardwood for commercial manufacture of wood products in Oregon and Washington and the most

abundant commercial hardwood species in these two states.

The wood of red alder varies from almost white to pale pinkish brown, and there is no visible boundary between heartwood and sapwood. Red alder is moderately light in weight and intermediate in most strength properties but low in shock resistance. It has relatively low shrinkage.

The principal use of red alder is for furniture, but it is also used for sash and door panel stock and other millwork.

Ash (Black Ash Group)

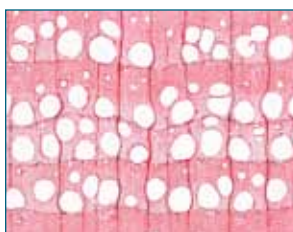

The black ash group includes black ash (*Fraxinus nigra*) and pumpkin ash (*F. profunda*). Black ash grows in the Northeast and Midwest, and pumpkin ash in the South.

The heartwood of black ash is a darker brown than that of

American white ash; the sapwood is light-colored or nearly white. The wood of the black ash group is lighter in weight (basic specific gravity of 0.45 to 0.48) than that of the white ash group (basic specific gravity greater than 0.50).

Principal uses for the black ash group are decorative veneer, cabinets, millwork, furniture, cooperage, and crates.

Ash (White Ash Group)

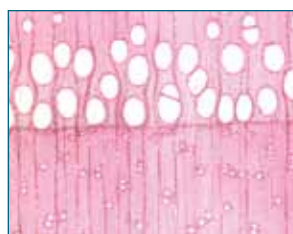

Important species of the white ash group are American white ash (*Fraxinus americana*), green ash (*F. pennsylvanica*), blue ash (*F. quadrangulata*), and Oregon ash (*F. latifolia*).

The first three species grow in the eastern half of the United States. Oregon ash grows along the Pacific Coast.

The heartwood of the white ash group is brown, and the sapwood is light-colored or nearly white. Second-growth trees are particularly sought after because of the inherent qualities of the wood from these trees: it is heavy, strong, hard, and stiff, and it has high resistance to shock. Oregon ash has somewhat lower strength properties than American

white ash, but it is used for similar purposes on the West Coast.

American white ash (*F. americana*) and green ash (*F. pennsylvanica*) that grow in southern river bottoms, especially in areas frequently flooded for long periods, produce buttresses that contain relatively lightweight and brash wood.

American white ash is used principally for nonstriking tool handles, oars, baseball bats, and other sporting and athletic goods. For handles of the best grade, some handle specifications call for not less than 2 nor more than 7 growth rings per centimeter (not less than 5 nor more than 17 growth rings per inch). The additional weight requirement of 690 kg m⁻³ (43 lb ft⁻³) or more at 12% moisture content ensures high-quality material. Principal uses for the white ash group are decorative veneer, cabinets, furniture, flooring, millwork, and crates.

Aspen

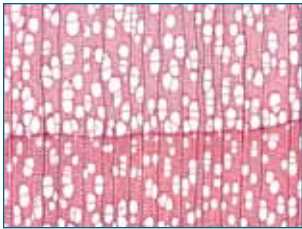

Aspen is a generally recognized name that is applied to bigtooth (*Populus grandidentata*) and quaking (*P. tremuloides*) aspen. Aspen lumber is produced principally in the northeastern and Lake States, with some production in the Rocky Mountain States.

The heartwood of aspen is grayish white to light grayish brown. The sapwood is lighter colored and generally merges gradually into the heartwood without being clearly marked. Aspen wood is usually straight grained with a fine, uniform texture. It is easily worked. Well-dried aspen lumber does not impart odor or flavor to foodstuffs. The wood of aspen is lightweight and soft. It is low in strength, moderately stiff, and moderately low in resistance to shock and has moderately high shrinkage.

Aspen is cut for lumber, pallets, boxes and crating, pulpwood, particleboard, strand panels, excelsior, matches, veneer, and miscellaneous turned articles. Today, aspen is one of the preferred species for use in oriented strandboard, a panel product that dominates the sheathing market.

Basswood

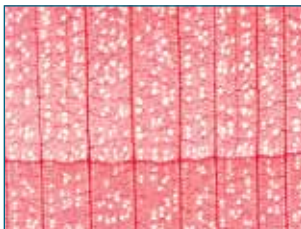

American basswood (*Tilia americana*) is the most important of the native basswood species; next in importance is white basswood (*T. heterophylla*), and no attempt is made to distinguish between

these species in lumber form. In commercial usage, "white basswood" is used to specify the white wood or sapwood

of either species. Basswood grows in the eastern half of North America from the Canadian provinces southward. Most basswood lumber comes from the Lake, Middle Atlantic, and Central States.

The heartwood of basswood is pale yellowish brown with occasional darker streaks. Basswood has wide, creamy white or pale brown sapwood that merges gradually into heartwood. When dry, the wood is without odor or taste. It is soft and light in weight, has fine, even texture, and is straight grained and easy to work with tools. Shrinkage in width and thickness during drying is rated as high; however, basswood seldom warps in use.

Basswood lumber is used mainly in venetian blinds, sashes and door frames, moulding, apiary supplies, wooden ware, and boxes. Some basswood is cut for veneer, cooperage, excelsior, and pulpwood, and it is a favorite of wood carvers.

Beech, American

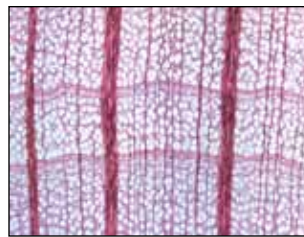

Only one species of beech, American beech (*Fagus grandifolia*), is native to the United States. It grows in the eastern one-third of the United States and adjacent Canadian provinces.

The greatest production of beech lumber is in the Central and Middle Atlantic States.

In some beech trees, color varies from nearly white sapwood to reddish-brown heartwood. Sometimes there is no clear line of demarcation between heartwood and sapwood. Sapwood may be roughly 7 to 13 cm (3 to 5 in.) wide. The wood has little figure and is of close, uniform texture. It has no characteristic taste or odor. The wood of beech is classed as heavy, hard, strong, high in resistance to shock, and highly suitable for steam bending. Beech shrinks substantially and therefore requires careful drying. It machines smoothly, is an excellent wood for turning, wears well, and is rather easily treated with preservatives.

Most beech is used for flooring, furniture, brush blocks, handles, veneer, woodenware, containers, and cooperage. When treated with preservative, beech is suitable for railway ties.

Birch

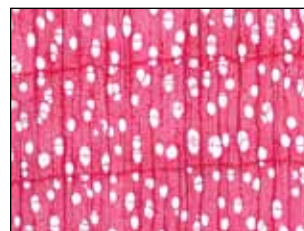

The three most important species are yellow birch (*Betula alleghaniensis*), sweet birch (*B. lenta*), and paper birch (*B. papyrifera*). These three species are the source of most birch lumber and veneer. Other birch species of some commercial

Chapter 2 Characteristics and Availability of Commercially Important Woods

importance are river birch (*B. nigra*), and gray birch (*B. populifolia*). Paper birch is transcontinental, whereas yellow and sweet birch grow principally in the Northeast and the Lake States; yellow and sweet birch also grow along the Appalachian Mountains to northern Georgia.

Yellow birch has white sapwood and light reddish-brown heartwood. Sweet birch has light-colored sapwood and dark brown heartwood tinged with red. For both yellow and sweet birch, the wood is heavy, hard, and strong, and has good shock-resisting ability. The wood is fine and uniform in texture. Paper birch is lower in weight, softer, and lower in strength than yellow and sweet birch. Birch shrinks considerably during drying.

Yellow and sweet birch lumber is used primarily for the manufacture of furniture, boxes, baskets, crates, wooden ware, cooperage, interior woodworking, and doors; veneer plywood is used for doors, furniture, paneling, cabinets, aircraft, and other specialty uses. Paper birch is used for toothpicks, tongue depressors, ice cream sticks, and turned products, including spools, bobbins, small handles, and toys.

Buckeye

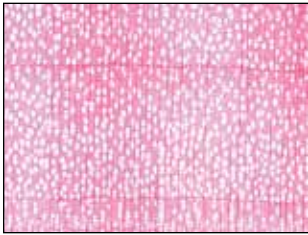

Buckeye consists of two species, yellow buckeye (*Aesculus octandra*) and Ohio buckeye (*A. glabra*). These species range from the Appalachians of Pennsylvania, Virginia, and North Carolina westward to Kansas, Oklahoma, and Texas. Buckeye is

not customarily separated from other species when manufactured into lumber and can be used for the same purposes as aspen (*Populus*), basswood (*Tilia*), and sapwood of yellow-poplar (*Liriodendron tulipifera*).

The white sapwood of buckeye merges gradually into the creamy or yellowish white heartwood. The wood is uniform in texture, generally straight grained, light in weight, soft, and low in shock resistance. It is rated low on machinability such as shaping, mortising, boring, and turning.

Buckeye is suitable for pulping for paper; in lumber form, it has been used principally for furniture, boxes and crates, food containers, wooden ware, novelties, and planing mill products.

Butternut

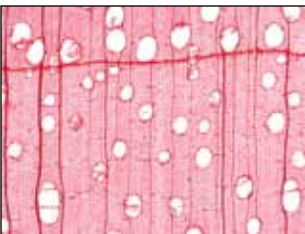

Also called white walnut, butternut (*Juglans cinerea*) grows from southern New Brunswick and Maine west to Minnesota. Its southern range extends into northeastern Arkansas and eastward to western North Carolina.

The narrow sapwood is nearly white and the heartwood is light brown, frequently modified by pinkish tones or darker brown streaks. The wood is moderately light in weight, rather coarse textured, moderately weak in bending and endwise compression, relatively low in stiffness, moderately soft, and moderately high in shock resistance. Butternut machines easily and finishes well. In many ways, butternut resembles black walnut, especially when stained, but it does not have the same strength or hardness.

Principal uses are for lumber and veneer, which are further manufactured into furniture, cabinets, paneling, interior woodwork, and miscellaneous rough items.

Cherry, Black

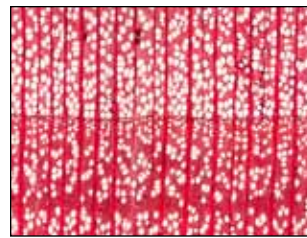

Black cherry (*Prunus serotina*) is sometimes known as cherry, wild black cherry, and wild cherry. It is the only native species of the genus *Prunus* that produces commercial lumber. Black cherry is found from south-

eastern Canada throughout the eastern half of the United States. Production is centered chiefly in the Middle Atlantic States.

The heartwood of black cherry varies from light to dark reddish brown and has a distinctive luster. The nearly white sapwood is narrow in old-growth trees and wider in second-growth trees. The wood has a fairly uniform texture and very good machining properties. It is moderately heavy, strong, stiff, and moderately hard, with high shock resistance. Although it has moderately high shrinkage, it is very dimensionally stable after drying.

Black cherry is used principally for furniture, fine veneer panels, and architectural woodwork. Other uses include burial caskets, wooden ware, novelties, patterns, and paneling.

Chestnut, American

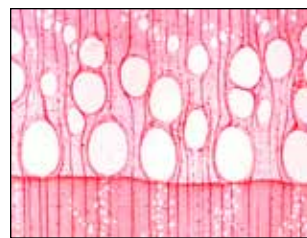

American chestnut (*Castanea dentata*) is also known as sweet chestnut. Before this species was attacked by a blight in the 1920s, it grew in commercial quantities from New England to northern Georgia. Practically all

standing chestnut has been killed by blight, and most supplies of the lumber come from salvaged timbers. Because of the species' natural resistance to decay, standing dead trees in the Appalachian Mountains continued to provide substantial quantities of lumber for several decades after the blight, but this source is now exhausted.

The heartwood of chestnut is grayish brown or brown and darkens with age. The sapwood is very narrow and almost

white. The wood is coarse in texture; growth rings are made conspicuous by several rows of large, distinct pores at the beginning of each year's growth. Chestnut wood is moderately light in weight, moderately hard, moderately low in strength, moderately low in resistance to shock, and low in stiffness. It dries well and is easy to work with tools.

Chestnut was once used for flooring, poles, railroad cross-ties, furniture, caskets, boxes, shingles, crates, and core-stock for veneer panels. At present, it appears most frequently as wormy chestnut for paneling, interior woodwork, and picture frames.

Cottonwood

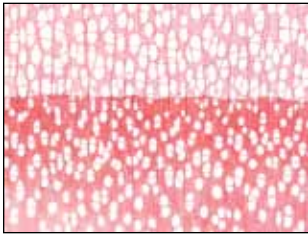

Cottonwood includes several species of the genus *Populus*. Most important are eastern cottonwood (*P. deltoides* and its varieties), also known as Carolina poplar and whitewood; swamp cottonwood (*P. heterophylla*),

also known as river cottonwood and swamp poplar; black cottonwood (*P. trichocarpa*); and balsam poplar (*P. balsamifera*). Eastern and swamp cottonwood grow throughout the eastern half of the United States. Greatest production of lumber is in the Southern and Central States. Black cottonwood grows on the West Coast and in western Montana, northern Idaho, and western Nevada. Balsam poplar grows from Alaska across Canada and in the northern Great Lakes States.

The heartwood of cottonwood is grayish white to light brown. The sapwood is whitish and merges gradually with the heartwood. The wood is comparatively uniform in texture and generally straight grained. It is odorless when well dried. Eastern cottonwood is moderately low in bending and compressive strength, moderately stiff, moderately soft, and moderately low in ability to resist shock. Most strength properties of black cottonwood are slightly lower than those of eastern cottonwood. Both eastern and black cottonwood have moderately high shrinkage. Some cottonwood is difficult to work with tools because of its fuzzy surface, which is mainly the result of tension wood.

Cottonwood is used principally for lumber, veneer, pulpwood, excelsior, and fuel. Lumber and veneer are used primarily for boxes, crates, baskets, and pallets.

Elm

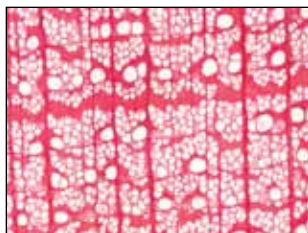

Six species of elm grow in the eastern United States: American (*Ulmus americana*), slippery (*U. rubra*), rock (*U. thomasii*), winged (*U. alata*), and cedar (*U. crassifolia*), and

September (*U. serotina*) elm. American elm is also known as white elm, slippery elm as red elm, rock elm as cork elm, and winged elm as wahoo. American elm is threatened by two diseases, Dutch Elm disease and phloem necrosis, which have killed hundreds of thousands of trees.

Sapwood of elm is nearly white and heartwood light brown, often tinged with red. Elm may be divided into two general classes, soft and hard, based on the weight and strength of the wood. Soft elm includes American and slippery elm. It is moderately heavy, has high shock resistance, and is moderately hard and stiff. Hard elm includes rock, winged, cedar, and September elm. These species are somewhat heavier than soft elm. Elm has excellent bending qualities.

Historically, elm lumber was used for boxes, baskets, crates, slack cooperage, furniture, agricultural supplies and implements, caskets and burial boxes, and wood components in vehicles. Today, elm lumber and veneer are used mostly for furniture and decorative panels. Hard elm is preferred for uses that require strength.

Hackberry

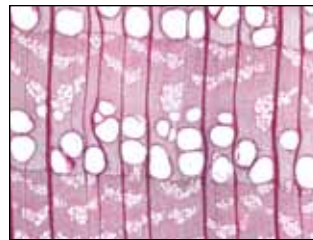

Hackberry (*Celtis occidentalis*) and sugarberry (*C. laevigata*) supply the lumber known in the trade as hackberry. Hackberry grows east of the Great Plains from Alabama, Georgia, Arkansas, and Oklahoma northward, except along the Canadian boundary. Sugarberry overlaps the southern part of the hackberry range and grows throughout the Southern and South Atlantic States.

Sapwood of both species varies from pale yellow to greenish or grayish yellow. The heartwood is commonly darker. The wood resembles elm in structure. Hackberry lumber is moderately heavy. It is moderately strong in bending, moderately weak in compression parallel to grain, moderately hard to very hard, and high in shock resistance, but low in stiffness. Hackberry has high shrinkage but keeps its shape well during drying.

Most hackberry is cut into lumber; small amounts are used for furniture parts, dimension stock, and veneer.

Most hackberry is cut into lumber; small amounts are used for furniture parts, dimension stock, and veneer.

Hickory (Pecan Hickory Group)

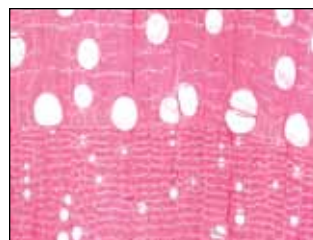

Species of the pecan hickory group include bitternut hickory (*Carya cordiformis*), pecan hickory (*C. illinoensis*), water hickory (*C. aquatica*), and nutmeg hickory (*C. myristiciformis*). Bitternut hickory grows through-

out the eastern half of the United States; pecan hickory, from central Texas and Louisiana to Missouri and Indiana;

Chapter 2 Characteristics and Availability of Commercially Important Woods

water hickory, from Texas to South Carolina; and nutmeg hickory, in Texas and Louisiana.

The sapwood of this group is white or nearly white and relatively wide. The heartwood is somewhat darker. The wood is heavy and sometimes has very high shrinkage.

Heavy pecan hickory is used for tool and implement handles and flooring. The lower grades are used for pallets. Many higher grade logs are sliced to provide veneer for furniture and decorative paneling.

Hickory (True Hickory Group)

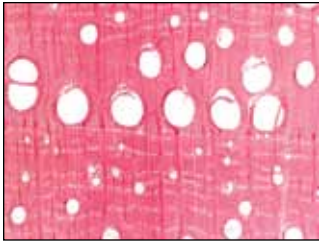

True hickories are found throughout the eastern half of the United States. The species most important commercially are shagbark (*Carya ovata*), pignut (*C. glabra*), shellbark (*C. laciniosa*), and mock-

ernut (*C. tomentosa*). The greatest commercial production of the true hickories for all uses is in the Middle Atlantic and Central States, with the Southern and South Atlantic States rapidly expanding to handle nearly half of all hickory lumber.

The sapwood of the true hickory group is white and usually quite wide, except in old, slow-growing trees. The heartwood is reddish. The wood is exceptionally tough, heavy, hard, and strong, and shrinks considerably in drying. For some purposes, both rings per centimeter (or inch) and weight are limiting factors where strength is important.

The major use for high quality hickory is for tool handles that require high shock resistance. It is also used for ladder rungs, athletic goods, agricultural implements, dowels, gymnasium apparatuses, poles, and furniture. Lower grade hickory is not suitable for the special uses of high quality hickory because of knottiness or other growth features and low density. However, the lower grade is useful for pallets and similar items. Hickory sawdust, chips, and some solid wood are used to flavor meat by smoking.

Honeylocust

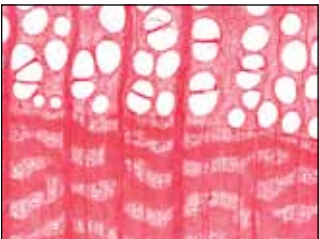

The wood of honeylocust (*Gleditsia triacanthos*) has many desirable qualities, such as attractive figure and color, hardness, and strength, but it is little used because of its scarcity. This species is found most commonly in the eastern United States, except for New England and the South Atlantic and Gulf Coastal Plains.

Sapwood is generally wide and yellowish, in contrast to the light red to reddish-brown heartwood. The wood is very

heavy, very hard, strong in bending, stiff, resistant to shock, and durable when in contact with the ground.

When available, honeylocust is primarily used locally for fence posts and general construction. It is occasionally used with other species in lumber for pallets and crating.

Locust, Black



Black locust (*Robinia pseudoacacia*) is sometimes called yellow locust. This species grows from Pennsylvania along the Appalachian Mountains to northern Georgia and Alabama. It is also native to western Arkansas and

southern Missouri. The greatest production of black locust timber is in Tennessee, Kentucky, West Virginia, and Virginia.

Locust has narrow, creamy white sapwood. The heartwood, when freshly cut, varies from greenish yellow to dark brown. Black locust is very heavy, very hard, very resistant to shock, and very strong and stiff. It has moderately low shrinkage. The heartwood has high decay resistance.

Black locust is used for round, hewn, or split mine timbers as well as fence posts, poles, railroad crosssties, stakes, and fuel. Other uses are for rough construction and crating. Historically, black locust was important for the manufacture of insulator pins and wooden pegs used in the construction of ships, for which the wood was well adapted because of its strength, decay resistance, and moderate shrinkage and swelling.

Magnolia

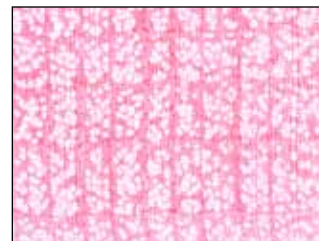

Commercial magnolia consists of three species: southern magnolia (*Magnolia grandiflora*), sweetbay (*M. virginiana*), and cucumbertree (*M. acuminata*). Other names for southern magnolia are evergreen

magnolia, big laurel, and bull bay. Sweetbay is sometimes called swamp magnolia. The lumber produced by all three species is simply called magnolia. The natural range of sweetbay extends along the Atlantic and Gulf Coasts from Long Island to Texas, and that of southern magnolia extends from North Carolina to Texas. Cucumbertree grows from the Appalachians to the Ozarks northward to Ohio. Louisiana leads in the production of magnolia lumber.

Sapwood of southern magnolia is yellowish white, and heartwood is light to dark brown with a tinge of yellow or green. The wood, which has close, uniform texture and is

generally straight grained, closely resembles yellow-poplar (*Liriodendron tulipifera*). It is moderately heavy, moderately low in shrinkage, moderately low in bending and compressive strength, moderately hard and stiff, and moderately high in shock resistance. Sweetbay is much like southern magnolia. The wood of cucumbertree is similar to that of yellow-poplar (*L. tulipifera*). Cucumbertree that grows in the yellow-poplar range is not separated from that species on the market.

Magnolia lumber is used principally in the manufacture of furniture, boxes, pallets, venetian blinds, sashes, doors, veneer, and millwork.

Maple (Hard Maple Group)

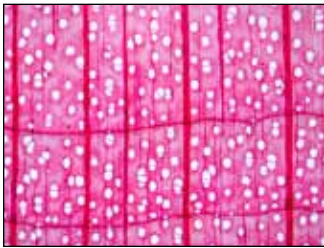

Hard maple includes sugar maple (*Acer saccharum*) and black maple (*A. nigrum*). Sugar maple is also known as rock maple, and black maple as black sugar maple. Maple lumber is manufactured principally in

the Middle Atlantic and Great Lake States, which together account for about two-thirds of production.

The heartwood is usually light reddish brown but sometimes considerably darker. The sapwood is commonly white with a slight reddish-brown tinge. It is usually 8 to 12 cm (3 to 5 in.) wide. Hard maple has a fine, uniform texture. It is heavy, strong, stiff, hard, and resistant to shock and has high shrinkage. The grain of sugar maple is generally straight, but birdseye, curly, or fiddleback grain is often selected for furniture or novelty items.

Hard maple is used principally for lumber and veneer. A large proportion is manufactured into flooring, furniture, cabinets, cutting boards and blocks, pianos, billiard cues, handles, novelties, bowling alleys, dance and gymnasium floors, spools, and bobbins.

Maple (Soft Maple Group)

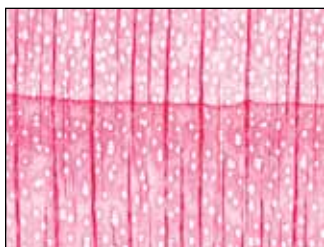

Soft maple includes silver maple (*Acer saccharinum*), red maple (*A. rubrum*), boxelder (*A. negundo*), and bigleaf maple (*A. macrophyllum*). Silver maple is also known as white, river, water, and swamp maple;

red maple as soft, water, scarlet, white, and swamp maple; boxelder as ash-leaved, three-leaved, and cut-leaved maple; and bigleaf maple as Oregon maple. Soft maple is found in the eastern United States except for bigleaf maple, which comes from the Pacific Coast.

Heartwood and sapwood are similar in appearance to hard maple. Heartwood of soft maple is somewhat lighter in color than the sapwood and somewhat wider. The wood of soft maple, primarily silver and red maple, resembles that of hard maple but is not as heavy, hard, and strong.

Soft maple is used for railroad cross-ties, boxes, pallets, crates, furniture, veneer, wooden ware, and novelties.

Oak, Live

See Oak (Tropical)

Oak (Red Oak Group)

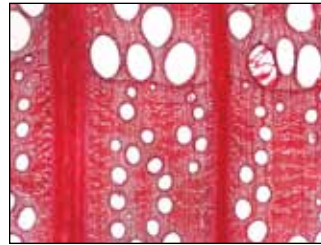

Most red oak comes from the Eastern States. The principal species are northern red (*Quercus rubra*), scarlet (*Q. coccinea*), Shumard (*Q. shumardii*), pin (*Q. palustris*), Nuttall (*Q. nuttallii*), black (*Q. velutina*), southern red (*Q. falcata*), cherrybark (*Q. falcata* var. *pagodaefolia*), water (*Q. nigra*), laurel (*Q. laurifolia*), and willow (*Q. phellos*) oak.

The sapwood is nearly white and roughly 2 to 5 cm (1 to 2 in.) wide. The heartwood is brown with a tinge of red. Sawn lumber of the red oak group cannot be separated by species on the basis of wood characteristics alone. Red oak lumber can be separated from white oak by the size and arrangement of pores in latewood and because it generally lacks tyloses in the pores. The open pores of red oak make this species group unsuitable for tight cooperage, unless the barrels are lined with sealer or plastic. Quartersawn lumber of the oaks is distinguished by its broad and conspicuous rays. Wood of the red oaks is heavy. Rapidly grown second-growth wood is generally harder and tougher than finer textured old-growth wood. The red oaks have fairly high shrinkage upon drying.

The red oaks are primarily cut into lumber, railroad cross-ties, mine timbers, fence posts, veneer, pulpwood, and fuelwood. Ties, mine timbers, and fence posts require preservative treatment for satisfactory service. Red oak lumber is remanufactured into flooring, furniture, general millwork, boxes, pallets and crates, agricultural implements, caskets, wooden ware, and handles. It is also used in railroad cars and boats.

Oak (White Oak Group)

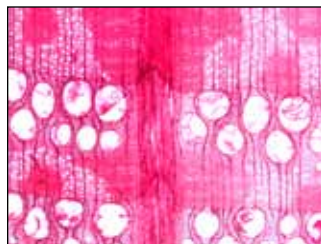

White oak lumber comes chiefly from the South, South Atlantic, and Central States, including the southern Appalachian area. Principal species are white (*Quercus alba*),

Chapter 2 Characteristics and Availability of Commercially Important Woods

chestnut (*Q. prinus*), post (*Q. stellata*), overcup (*Q. lyrata*), swamp chestnut (*Q. michauxii*), bur (*Q. macrocarpa*), chinkapin (*Q. muehlenbergii*), and swamp white (*Q. bicolor*). The most important western oak species, Oregon white oak (*Q. garryana*), is a member of this group.

The sapwood of the white oaks is nearly white and roughly 2 to 5 cm (1 to 2 in.) wide. The heartwood is generally grayish brown. Heartwood pores are usually plugged with tyloses, which tend to make the wood impenetrable to liquids. Consequently, most white oaks are suitable for tight cooperage, although many heartwood pores of chestnut oak lack tyloses. The wood of white oak is somewhat heavier than the wood of red oak. Its heartwood has good decay resistance.

White oaks are usually cut into lumber, railroad crossties, cooperage, mine timbers, fence posts, veneer, fuelwood, and many other products. High-quality white oak is especially sought for tight cooperage. An important use of white oak is for planking and bent parts of ships and boats; heartwood is often specified because of its decay resistance. White oak is also used for furniture, flooring, pallets, agricultural implements, railroad cars, truck floors, furniture, doors, and millwork.

Sassafras

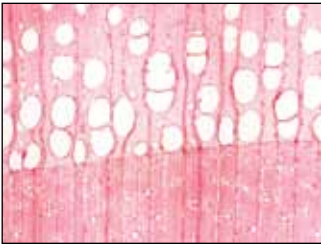

Sassafras (*Sassafras albidum*) ranges from southeastern Iowa and eastern Texas eastward. Sassafras is easily confused with black ash, which it resembles in color, grain, and texture. Sapwood is

light yellow, and heartwood varies from dull grayish brown to dark brown, sometimes with a reddish tinge. Freshly cut surfaces have a characteristic odor. The wood is moderately heavy, moderately hard, moderately weak in bending and endwise compression, quite high in shock resistance, and resistant to decay.

Sassafras was highly prized by the native Americans for dugout canoes, and some sassafras lumber is still used for small boats. Locally, sassafras is used for fence posts and rails and for general millwork.

Sweetgum

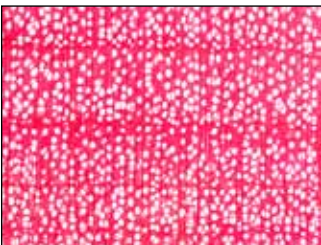

Sweetgum (*Liquidambar styraciflua*) grows from southwestern Connecticut westward into Missouri and southward to the Gulf Coast. Almost all lumber is produced in the Southern and South Atlantic States.

The lumber from sweetgum is usually separated into sap gum (the light-colored sapwood) or redgum (the reddish-

brown heartwood). Sweetgum often has a form of cross grain called interlocked grain, and it must be dried slowly. When quartersawn, interlocked grain produces a ribbon-type stripe that is desirable for interior woodwork and furniture. The wood is moderately heavy and hard. It is moderately strong, moderately stiff, and moderately high in shock resistance.

Sweetgum is used principally for lumber, veneer, plywood, slack cooperage, railroad crossties, fuel, pulpwood, boxes and crates, furniture, interior moulding, and millwork.

Sycamore, American

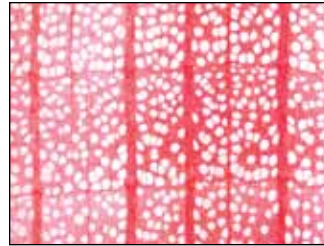

American sycamore (*Platanus occidentalis*) is sometimes called buttonwood or buttonball-tree. Sycamore grows from Maine to Nebraska, southward to Texas, and eastward to Florida.

The heartwood of sycamore is reddish brown; the sapwood is light in color and from 4 to 8 cm (2 to 3 in.) wide. The wood has a fine texture and interlocked grain. It has high shrinkage in drying. It is moderately heavy, moderately hard, moderately stiff, moderately strong, and it has good shock resistance.

Sycamore is used principally for lumber, veneer, railroad crossties, slack cooperage, fence posts, and fuel. The lumber is used for furniture, boxes (particularly small food containers), pallets, flooring, handles, and butcher blocks. Veneer is used for fruit and vegetable baskets and some decorative panels and door skins.

Tanoak

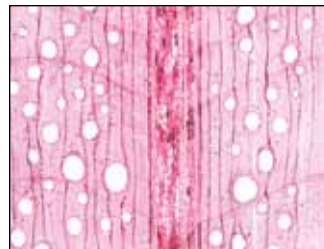

Tanoak (*Lithocarpus densiflorus*) is also known as tanbark-oak because high-grade tannin was once obtained in commercial quantities from its bark. This species is found from southwestern Oregon to

southern California, mostly near the coast but also in the Sierra Nevadas.

Sapwood of tanoak is light reddish brown when first cut and turns darker with age to become almost indistinguishable from heartwood, which also ages to dark reddish brown. The wood is heavy and hard. Except for compression perpendicular to grain, the wood has roughly the same strength properties as those of eastern white oak. Tanoak has higher shrinkage during drying than does white oak, and it has a tendency to collapse during drying. Tanoak is quite susceptible to decay, but the sapwood takes preservatives easily.

Tanoak has straight grain, machines and glues well, and takes stains readily.

Because of its hardness and abrasion resistance, tanoak is excellent for flooring in homes or commercial buildings. It is also suitable for industrial applications such as truck flooring. Tanoak treated with preservative has been used for railroad cross-ties. The wood has been manufactured into baseball bats with good results, and it is also suitable for veneer, both decorative and industrial, and for high quality furniture.

Tupelo

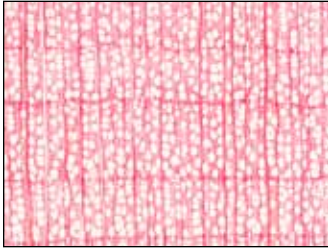

The tupelo group includes water (*Nyssa aquatica*), black (*N. sylvatica*), swamp (*N. sylvatica* var. *biflora*), and Ogeechee (*N. ogeche*) tupelo. Water tupelo is also known as tupelo gum, swamp tupelo, and

sourgum; black tupelo, as blackgum and sourgum; swamp tupelo, as swamp blackgum, blackgum, and sourgum; and Ogeechee tupelo, as sour tupelo, gopher plum, and Ogeechee plum. All except black tupelo grow principally in the southeastern United States. Black tupelo grows in the eastern United States from Maine to Texas and Missouri. About two-thirds of the production of tupelo lumber is from Southern States.

Wood of the different tupelo species is quite similar in appearance and properties. The heartwood is light brownish gray and merges gradually into the lighter-colored sapwood, which is generally many centimeters wide. The wood has fine, uniform texture and interlocked grain. Tupelo wood is moderately heavy, moderately strong, moderately hard and stiff, and moderately high in shock resistance. Buttresses of trees growing in swamps or flooded areas contain wood that is much lighter in weight than that from upper portions of the same trees. Because of interlocked grain, tupelo lumber requires care in drying.

Tupelo is cut principally for lumber, veneer, pulpwood, and some railroad cross-ties and slack cooperage. Lumber goes into boxes, pallets, crates, baskets, and furniture.

Walnut, Black



Black walnut (*Juglans nigra*) ranges from Vermont to the Great Plains and southward into Louisiana and Texas. About three-quarters of walnut wood is grown in the Central States.

The heartwood of black walnut varies from light to dark brown; the sapwood is nearly white and up to 8 cm (3 in.) wide in open-grown trees. Black walnut is normally straight grained, easily worked with tools, and stable in use. It is heavy, hard, strong, and stiff, and has good resistance to shock. Black walnut is well suited for natural finishes.

Because of its good properties and interesting grain pattern, black walnut is much valued for furniture, architectural woodwork, and decorative panels. Other important uses are gunstocks, cabinets, and interior woodwork.

Willow, Black

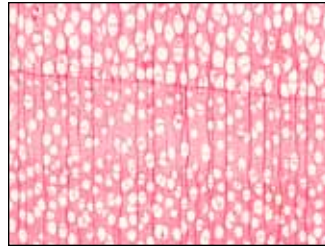

Black willow (*Salix nigra*) is the most important of the many willows that grow in the United States. It is the only willow marketed under its own name. Most black willow comes from the Missis-

sippi Valley, from Louisiana to southern Missouri and Illinois.

The heartwood of black willow is grayish brown or light reddish brown and frequently contains darker streaks. The sapwood is whitish to creamy yellow. The wood is uniform in texture, with somewhat interlocked grain, and is light in weight. It has exceedingly low strength as a beam or post, is moderately soft, and is moderately high in shock resistance. It has moderately high shrinkage.

Black willow is principally cut into lumber, which is then remanufactured into boxes, pallets, crates, caskets, and furniture. Small amounts have been used for slack cooperage, veneer, excelsior, charcoal, pulpwood, artificial limbs, and fence posts.

Yellow-Poplar

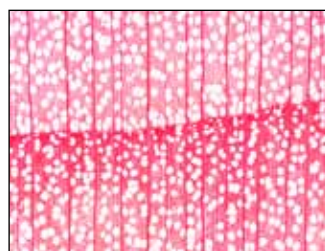

Yellow-poplar (*Liriodendron tulipifera*) is also known as poplar, tulip-poplar, and tulipwood. Sapwood from yellow-poplar is sometimes called white poplar or whitewood. Yellow-poplar grows from Connecticut and New York southward to Florida and westward to Missouri.

The greatest commercial production of yellow-poplar lumber is in the South and Southeast.

Yellow-poplar sapwood is white and frequently several centimeters wide. The heartwood is yellowish brown, sometimes streaked with purple, green, black, blue, or red. These colorations do not affect the physical properties of the

wood. The wood is generally straight grained and comparatively uniform in texture. Slow-grown wood is moderately light in weight and moderately low in bending strength, moderately soft, and moderately low in shock resistance. The wood has moderately high shrinkage when dried from a green condition, but it is not difficult to dry and is stable after drying.

The lumber is used primarily for furniture, interior moulding, siding, cabinets, musical instruments, and engineered wood composites. Boxes, pallets, and crates are made from lower-grade stock. Yellow-poplar is also made into plywood for paneling, furniture, piano cases, and various other special products.

U.S. Softwoods

Baldcypress



Baldcypress or cypress (*Taxodium distichum*) is also known as southern-cypress, red-cypress, yellow-cypress, and white-cypress. Commercially, the terms tidewater red-cypress, gulf-cypress, red-cypress

(coast type), and yellow-cypress (inland type) are frequently used. About half of the cypress lumber comes from the Southern States and about a fourth from the South Atlantic States. Old-growth baldcypress is difficult to find, but second-growth wood is available.

Sapwood of baldcypress is narrow and nearly white. The color of heartwood varies widely, ranging from light yellowish brown to dark brownish red, brown, or chocolate. The wood is moderately heavy, moderately strong, and moderately hard. The heartwood of old-growth baldcypress is one of the most decay resistant of U.S. species, but second-growth wood is only moderately resistant to decay. Shrinkage is moderately low but somewhat higher than that of the cedars and lower than that of Southern Pine. The wood of certain baldcypress trees frequently contains pockets or localized areas that have been attacked by a fungus. Such wood is known as pecky cypress. The decay caused by this fungus is stopped when the wood is cut into lumber and dried. Pecky cypress is therefore durable and useful where water tightness is unnecessary, appearance is not important, or a novel effect is desired.

When old-growth wood was available, baldcypress was used principally for building construction, especially where resistance to decay was required. It was also used for caskets, sashes, doors, blinds, tanks, vats, ship and boat building, and cooling towers. Second-growth wood is used for siding and millwork, including interior woodwork and

paneling. Pecky cypress is used for paneling in restaurants, stores, and other buildings.

Douglas-Fir

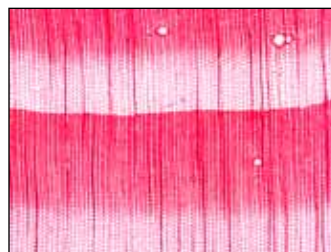

Douglas-fir (*Pseudotsuga menziesii*) is also known locally as red-fir, Douglas-spruce, and yellow-fir. Its range extends from the Rocky Mountains to the Pacific Coast and from Mexico to central British Columbia.

Sapwood of Douglas-fir is narrow in old-growth trees but may be as much as 7 cm (3 in.) wide in second-growth trees of commercial size. Young trees of moderate to rapid growth have reddish heartwood and are called red-fir. Very narrow-ringed heartwood of old-growth trees may be yellowish brown and is known on the market as yellow-fir. The wood of Douglas-fir varies widely in weight and strength.

Douglas-fir is used mostly for building and construction purposes in the form of lumber, marine fendering, piles, plywood, and engineered wood composites. Considerable quantities are used for railroad crossties, cooperage stock, mine timbers, poles, and fencing. Douglas-fir lumber is used in the manufacture of sashes, doors, laminated beams, general millwork, railroad-car construction, boxes, pallets, and crates. Small amounts are used for flooring, furniture, ship and boat construction, and tanks.

Fir, True (Eastern Species)

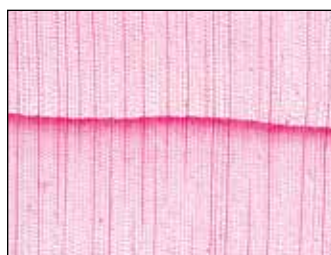

Balsam fir (*Abies balsamea*) grows principally in New England, New York, Pennsylvania, and the Great Lake States. Fraser fir (*A. fraseri*) grows in the Appalachian Mountains of Virginia, North Carolina, and Tennessee.

The wood of the eastern true firs is creamy white to pale brown. The heartwood and sapwood are generally indistinguishable. The similarity of wood structure in the true firs makes it impossible to distinguish the species by examination of the wood alone. Balsam and Fraser firs are lightweight, have low bending and compressive strength, are moderately low in stiffness, are soft, and have low resistance to shock.

The eastern firs are used mainly for pulpwood, although some lumber is produced for structural products, especially in New England and the Great Lake States.

Fir, True (Western Species)

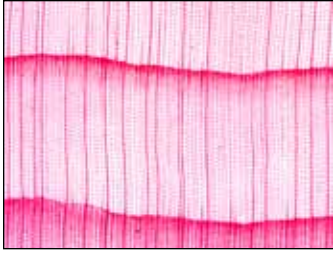

Six commercial species make up the western true firs: subalpine fir (*Abies lasiocarpa*), California red fir (*A. magnifica*), grand fir (*A. grandis*), noble fir (*A. procera*), Pacific silver fir (*A. amabilis*), and white fir

(*A. concolor*). The western true firs are cut for lumber primarily in Washington, Oregon, California, western Montana, and northern Idaho, and they are marketed as white fir throughout the United States.

The wood of the western true firs is similar to that of the eastern true firs, and it is not possible to distinguish among the true fir species by examination of the wood alone.

Western true firs are light in weight and, with the exception of subalpine fir, have somewhat higher strength properties than does balsam fir. Shrinkage of the wood is low to moderately high.

Lumber of the western true firs is primarily used for building construction, boxes and crates, planing-mill products, sashes, doors, and general millwork. Some western true fir lumber is manufactured into boxes and crates. High-grade lumber from noble fir is used mainly for interior woodwork, moulding, siding, and sash and door stock. Some of the highest quality material has been used for aircraft construction. Other special uses of noble fir are venetian blinds and ladder rails.

Hemlock, Eastern

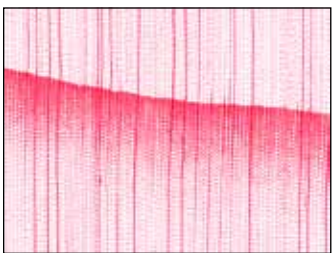

Eastern hemlock (*Tsuga canadensis*) grows from New England to northern Alabama and Georgia, and in the Great Lake States. Other names are Canadian hemlock and hemlock-spruce. The production of hemlock lum-

ber is divided fairly evenly among the New England States, Middle Atlantic States, and Great Lake States.

The heartwood of eastern hemlock is pale brown with a reddish hue. The sapwood is not distinctly separated from the heartwood but may be lighter in color. The wood is coarse and uneven in texture, and old trees tend to have considerable shake. The wood is moderately lightweight, moderately hard, moderately low in strength, moderately stiff, and moderately low in shock resistance.

Eastern hemlock is used principally for lumber and pulpwood. The lumber is used primarily in building

construction and in the manufacture of boxes, pallets, and crates.

Hemlock, Western and Mountain

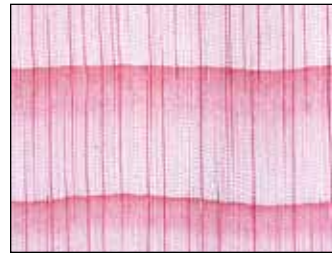

Western hemlock (*Tsuga heterophylla*) is also known as West Coast hemlock, Pacific hemlock, British Columbia hemlock, hemlock-spruce, and western hemlock-fir. It grows along the Pacific coast

of Oregon and Washington and in the northern Rocky Mountains north to Canada and Alaska. A relative of western hemlock, mountain hemlock (*T. mertensiana*) grows in mountainous country from central California to Alaska. It is treated as a separate species in assigning lumber properties.

The heartwood and sapwood of western hemlock are almost white with a purplish tinge. The sapwood, which is sometimes lighter in color than the heartwood, is generally not more than 2.5 cm (1 in.) wide. The wood often contains small, sound, black knots that are usually tight and dimensionally stable. Dark streaks are often found in the lumber; these are caused by hemlock bark maggots and generally do not reduce strength. Western hemlock is moderately light in weight and moderate in strength. It is also moderate in hardness, stiffness, and shock resistance. Shrinkage of western hemlock is moderately high, about the same as that of Douglas-fir (*Pseudotsuga menziesii*). Green hemlock lumber contains considerably more water than does Douglas-fir and requires longer kiln-drying time. Mountain hemlock has approximately the same density as that of western hemlock but is somewhat lower in bending strength and stiffness.

Western hemlock and mountain hemlock are used principally for pulpwood, lumber, and plywood. The lumber is used primarily for building material, as well as in the manufacture of boxes, pallets, crates, flooring, furniture, and ladders.

Incense-Cedar

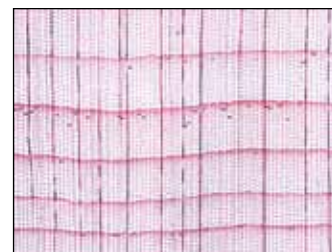

Incense-cedar (*Calocedrus decurrens*) grows in California, southwestern Oregon, and extreme western Nevada. Most incense-cedar lumber comes from the northern half of California.

Sapwood of incense-cedar is white or cream colored, and heartwood is light brown, often tinged with red. The wood

has a fine, uniform texture and a spicy odor. Incense-cedar is light in weight, moderately low in strength, soft, low in shock resistance, and low in stiffness. It has low shrinkage and is easy to dry, with little checking or warping.

Incense-cedar is used principally for lumber and fence posts. Nearly all the high-grade lumber is used for pencils and venetian blinds; some is used for chests and toys. Much incense-cedar wood is more or less pecky; that is, it contains pockets or areas of disintegrated wood caused by advanced stages of localized decay in the living tree. There is no further development of decay once the lumber is dried. Other uses are railroad cross ties, poles, split shingles, pencils, and composite fireplace logs.

Larch, Western

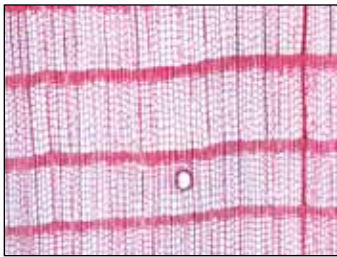

Western larch (*Larix occidentalis*) grows in western Montana, northern Idaho, northeastern Oregon, and on the eastern slope of the Cascade Mountains in Washington. About two-thirds of the lumber of this

species is produced in Idaho and Montana and one-third in Oregon and Washington.

The heartwood of western larch is yellowish brown and the sapwood is yellowish white. The sapwood is generally not more than 2.5 cm (1 in.) wide. The wood is stiff, moderately strong and hard, moderately high in shock resistance, and moderately heavy. It has moderately high shrinkage. The wood is usually straight grained, splits easily, and is subject to ring shake. Knots are common but generally small and tight.

Western larch is used mainly for rough dimension wood in building construction, small timbers, planks and boards, and railroad cross ties and mine timbers. It is used also for piles, poles, and posts. Some high-grade material is manufactured into interior woodwork, flooring, sashes, doors, and ladder stock. The properties of western larch are similar to those of Douglas-fir (*Pseudotsuga menziesii*), and these species are sometimes sold mixed.

Pine, Eastern White



Eastern white pine (*Pinus strobus*) grows from Maine to northern Georgia and in the Great Lake States. It is also known as white pine, northern white pine, Weymouth pine, and soft pine. About

one-half the production of eastern white pine lumber occurs in New England, about one-third in the Great Lake States, and most of the remainder in the middle Atlantic and south Atlantic States.

The heartwood of eastern white pine is light brown, often with a reddish tinge. It turns darker on exposure to air. The wood has comparatively uniform texture and is straight grained. It is easily kiln dried, has low shrinkage, and ranks high in stability. It is also easy to work and can be readily glued. Eastern white pine is lightweight, moderately soft, moderately low in strength, low in shock resistance, and low in stiffness.

Practically all eastern white pine is converted into lumber, which is used in a great variety of ways. A large proportion, mostly second-growth knotty wood or lower grades, is used for structural lumber. High-grade lumber is used for patterns. Other important uses are sashes, doors, furniture, interior woodwork, knotty paneling, caskets, shade and map rollers, and toys.

Pine, Jack

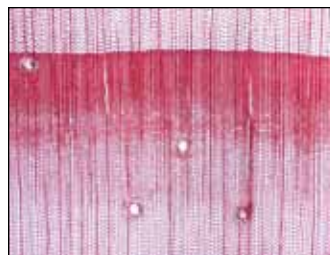

Jack pine (*Pinus banksiana*), sometimes known as scrub, gray, and black pine in the United States, grows naturally in the Great Lake States and in a few scattered areas in New England and northern New York. Sapwood

of jack pine is nearly white; heartwood is light brown to orange. Sapwood may constitute one-half or more of the volume of a tree. The wood has a rather coarse texture and is somewhat resinous. It is moderately lightweight, moderately low in bending strength and compressive strength, moderately low in shock resistance, and low in stiffness. It also has moderately low shrinkage. Lumber from jack pine is generally knotty.

Jack pine is used for pulpwood, box lumber, and pallets. Less important uses include railroad cross ties, mine timber, slack cooperage, poles, posts, and fuel.

Pine, Lodgepole

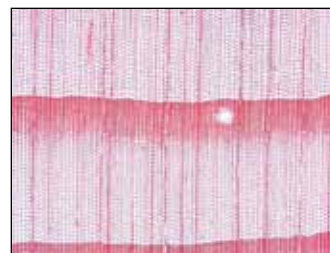

Lodgepole pine (*Pinus contorta*), also known as knotty, black, and spruce pine, grows in the Rocky Mountain and Pacific Coast regions as far northward as Alaska. Wood for lumber and other products is

produced primarily in the central Rocky Mountain States; other producing regions are Idaho, Montana, Oregon, and Washington.

The heartwood of lodgepole pine varies from light yellow to light yellow-brown. The sapwood is yellow or nearly white. The wood is generally straight grained with narrow growth rings. The wood is moderately lightweight, is fairly easy to work, and has moderately high shrinkage. It is moderately low in strength, moderately soft, moderately stiff, and moderately low in shock resistance.

Lodgepole pine has been used for lumber, mine timbers, railroad crossties, and poles. Less important uses include posts and fuel. Lodgepole pine is being used increasingly for structural lumber, millwork, cabinet logs, and engineered wood composites.

Pine, Pitch and Pond

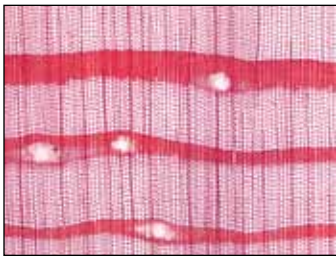

Pitch pine (*Pinus rigida*) grows from Maine along the mountains to eastern Tennessee and northern Georgia. A relative of pitch pine (considered by some to be a subspecies), pond

pine (*P. serotina*) grows in the coastal region from New Jersey to Florida.

The heartwood is brownish red or dark orange and resinous; the sapwood is wide and light yellow. The wood is moderately heavy to heavy, moderately strong, stiff, and hard, and moderately high in shock resistance. Shrinkage ranges from moderately low to moderately high.

Pitch and pond pine are used for general construction, lumber, posts, poles, fuel, and pulpwood.

Pine, Ponderosa



Ponderosa pine (*Pinus ponderosa*) is also known as western yellow, bull, and blackjack pine. Jeffrey pine (*P. jeffreyi*), which grows in close association with ponderosa pine in California and Oregon, is usually marketed with

ponderosa pine and sold under that name. Major ponderosa pine producing areas are in Oregon, Washington, and California. Other important producing areas are in Idaho and Montana; lesser amounts come from the southern Rocky Mountain region, the Black Hills of South Dakota, and Wyoming.

The heartwood of ponderosa pine is light reddish brown, and the wide sapwood is nearly white to pale yellow. The wood of the outer portions of ponderosa pine of sawtimber size is generally moderately light in weight, moderately low in strength, moderately soft, moderately stiff, and moderately low in shock resistance. It is generally straight grained and has moderately low shrinkage. It is quite uniform in texture and has little tendency to warp and twist.

Ponderosa pine has been used mainly for lumber and to a lesser extent for piles, poles, posts, mine timbers, veneer, and railroad crossties. The clear wood is used for sashes, doors, blinds, moulding, paneling, interior woodwork, and built-in cases and cabinets. Low-grade lumber is used for boxes and crates. Knotty ponderosa pine is used for interior woodwork.

Pine, Red



Red pine (*Pinus resinosa*) is frequently called Norway pine. This species grows in New England, New York, Pennsylvania, and the Great Lake States.

The heartwood of red pine varies from pale red to reddish brown. The sapwood is nearly white with a yellowish tinge and is generally from 5 to 10 cm (2 to 4 in.) wide. The wood resembles the lighter weight wood of the Southern Pine species group. Red pine is moderately heavy, moderately strong and stiff, moderately soft, and moderately high in shock resistance. It is generally straight grained, not as uniform in texture as eastern white pine (*P. strobus*), and somewhat resinous. The wood has moderately high shrinkage, but it is not difficult to dry and is dimensionally stable when dried.

Red pine is used principally for lumber, cabin logs, and pulpwood, and to a lesser extent for piles, poles, posts, and fuel. The lumber is used for many of the same purposes as for eastern white pine (*P. strobus*). Red pine lumber is used primarily for building construction, including treated lumber for decking, siding, flooring, sashes, doors, general millwork, and boxes, pallets, and crates.

Pine, Southern Group

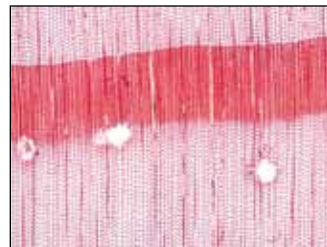

A number of species are included in the group marketed as Southern Pine lumber. The four major Southern Pine species and their growth ranges are as follows: (a) longleaf pine (*Pinus palustris*), eastern North

Carolina southward into Florida and westward into eastern Texas; (b) shortleaf pine (*P. echinata*), southeastern New York southward to northern Florida and westward into eastern Texas and Oklahoma; (c) loblolly pine (*P. taeda*), Maryland southward through the Atlantic Coastal Plain and Piedmont Plateau into Florida and westward into eastern Texas; (d) slash pine (*P. elliotii*), Florida and southern South Carolina, Georgia, Alabama, Mississippi, and Louisiana east of the Mississippi River. Lumber from these four species is classified as Southern Pine by the grading standards of the industry. Southern Pine lumber is produced principally in the Southern and South Atlantic States. Georgia, Alabama, North Carolina, Arkansas, and Louisiana lead in Southern Pine lumber production.

The wood of these southern pines is quite similar in appearance. Sapwood is yellowish white and heartwood is reddish brown. The sapwood is usually wide in second-growth stands. The heartwood begins to form when the tree is about 20 years old. In old, slow-growth trees, sapwood may be only 2 to 5 cm (1 to 2 in.) wide.

Longleaf and slash pine are classified as heavy, strong, stiff, hard, and moderately high in shock resistance. Shortleaf and loblolly pine are usually somewhat lighter in weight than is longleaf. All the southern pines have moderately high shrinkage but are dimensionally stable when properly dried.

The denser and higher strength southern pines have been extensively used in the form of stringers in the construction of factories, warehouses, bridges, trestles, and docks, and also for roof trusses, beams, posts, joists, and piles. Southern Pine is also used for tight and slack cooperage. When used for railroad cross-ties, piles, poles, mine timbers, and exterior decking, it is usually treated with preservatives. The manufacture of engineered wood composites from Southern Pine is a major wood-using industry, as is the production of preservative-treated lumber.

Pine, Spruce

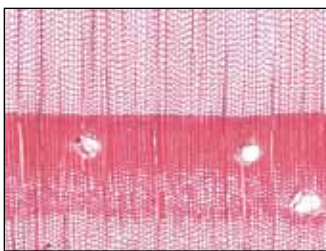

Spruce pine (*Pinus glabra*), is also known as cedar pine and Walter pine. Spruce pine grows most commonly on low moist lands of the coastal regions of southeastern South Carolina, Georgia, Alabama, Mississippi,

and Louisiana, and northern and northwestern Florida.

The heartwood of spruce pine is light brown, and the wide sapwood is nearly white. Spruce pine wood is lower in most

strength values than the wood of the major Southern Pine species group. Spruce pine compares favorably with the western true firs in important bending properties, crushing strength (perpendicular and parallel to grain), and hardness. It is similar to denser species such as coast Douglas-fir (*Pseudotsuga menziesii*) and loblolly pine (*Pinus taeda*) in shear parallel to grain.

In the past, spruce pine was principally used locally for lumber, pulpwood, and fuelwood. The lumber reportedly was used for sashes, doors, and interior woodwork because of its low specific gravity and similarity of earlywood and latewood.

Pine, Sugar

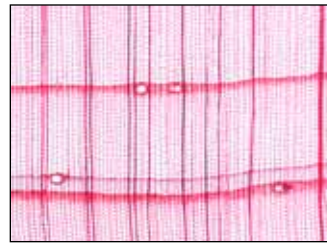

Sugar pine (*Pinus lambertiana*), the world's largest species of pine, is sometimes called California sugar pine. Most sugar pine lumber grows in California and southwestern Oregon.

The heartwood of sugar pine is buff or light brown, sometimes tinged with red. The sapwood is creamy white. The wood is straight grained, fairly uniform in texture, and easy to work with tools. It has very low shrinkage, is readily dried without warping or checking, and is dimensionally stable. Sugar pine is lightweight, moderately low in strength, moderately soft, low in shock resistance, and low in stiffness.

Sugar pine is used almost exclusively for lumber products. The largest volume is used for boxes and crates, sashes, doors, frames, blinds, general millwork, building construction, and foundry patterns.

Pine, Virginia



Virginia pine (*Pinus virginiana*), also known as Jersey and scrub pine, grows from New Jersey and Virginia throughout the Appalachian region to Georgia and the Ohio Valley. It is classified as a minor species in the grading

rules for the Southern Pine species group.

The heartwood is orange, and the sapwood is nearly white and relatively wide. The wood is moderately heavy, moderately strong, moderately hard, and moderately stiff and has moderately high shrinkage and high shock resistance.

Virginia pine is used for lumber, railroad cross-ties, mine timbers, and pulpwood.

Pine, Western White

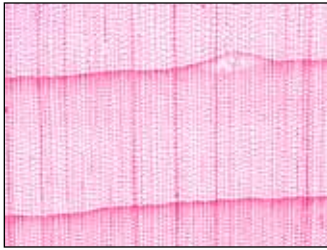

Western white pine (*Pinus monticola*) is also known as Idaho white pine or white pine.

The heartwood of western white pine is cream colored to light reddish brown and darkens on exposure to air. The sap-

wood is yellowish white and generally from 2 to 8 cm (1 to 3 in.) wide. The wood is straight grained, easy to work, easily kiln-dried, and stable after drying. This species is moderately lightweight, moderately low in strength, moderately soft, moderately stiff, and moderately low in shock resistance and has moderately high shrinkage.

Practically all western white pine is sawn into lumber, which is used mainly for millwork products, such as sashes and door frames. In building construction, lower-grade boards are used for knotty paneling. High-grade material is made into siding of various kinds, exterior and interior woodwork, and millwork. Western white pine has practically the same uses as eastern white pine (*P. strobus*) and sugar pine (*P. lambertiana*).

Port-Orford-Cedar

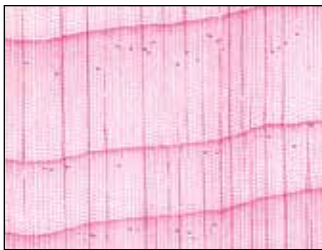

Port-Orford-cedar (*Chamaecyparis lawsoniana*) is also known as Lawson-cypress or Oregon-cedar. It grows along the Pacific Coast from Coos Bay, Oregon, southward to California. It does not extend more than 65 km (40 mi) inland.

The heartwood of Port-Orford-cedar is light yellow to pale brown. The sapwood is narrow and hard to distinguish from the heartwood. The wood has fine texture, generally straight grain, and a pleasant spicy odor. It is moderately lightweight, stiff, moderately strong and hard, and moderately resistant to shock. Port-Orford-cedar heartwood is highly resistant to decay. The wood shrinks moderately, has little tendency to warp, and is stable after drying.

Some high-grade Port-Orford-cedar was once used in the manufacture of storage battery separators, matchsticks, and specialty millwork. Today, other uses are archery supplies, sash and door construction, flooring, interior woodwork, furniture, and boats.

Redcedar, Eastern



Eastern redcedar (*Juniperus virginiana*) grows throughout the eastern half of the United States, except in Maine, Florida, and a narrow strip along the Gulf Coast, and at the higher elevations in the Appalachian Mountains.

Commercial production is principally in the southern Appalachian and Cumberland Mountain regions. Another species, southern redcedar (*J. silicicola*), grows over a limited area in the South Atlantic and Gulf Coastal Plains.

The heartwood of redcedar is bright or dull red, and the narrow sapwood is nearly white. The wood is moderately heavy, moderately low in strength, hard, and high in shock resistance, but low in stiffness. It has very low shrinkage and is dimensionally stable after drying. The texture is fine and uniform, and the wood commonly has numerous small knots. Eastern redcedar heartwood is very resistant to decay.

The greatest quantity of eastern and southern redcedar is used for fence posts. Lumber is manufactured into chests, wardrobes, and closet lining. Other uses include flooring, novelties, pencils, scientific instruments, and small boats.

Redcedar, Western

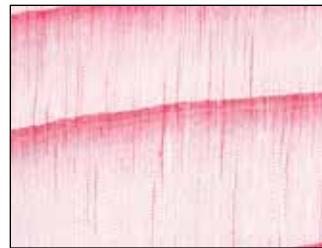

Western redcedar (*Thuja plicata*) grows in the Pacific Northwest and along the Pacific Coast to Alaska. It is also called canoe-cedar, giant arbovitae, shinglewood, and Pacific redcedar. Western redcedar lumber is

produced principally in Washington, followed by Oregon, Idaho, and Montana.

The heartwood of western redcedar is reddish or pinkish brown to dull brown, and the sapwood is nearly white. The sapwood is narrow, often not more than 3 cm (1 in.) wide. The wood is generally straight grained and has a uniform but rather coarse texture. It has very low shrinkage. This species is lightweight, moderately soft, low in strength when used as a beam or post, and low in shock resistance. The heartwood is very resistant to decay.

Western redcedar is used principally for shingles, lumber, poles, posts, and piles. The lumber is used for exterior siding, decking, interior woodwork, ship and boat building, boxes and crates, sashes, and doors.

Redwood



Redwood (*Sequoia sempervirens*) grows on the coast of California and some trees are among the tallest in the world. A closely related species, giant sequoia (*Sequoiadendron giganteum*), is volumetrically larger and

grows in a limited area in the Sierra Nevadas of California, but its wood is used in very limited quantities. Other names for redwood are coast redwood, California redwood, and sequoia. Production of redwood lumber is limited to California, but the market is nationwide.

The heartwood of redwood varies from light “cherry” red to dark mahogany. The narrow sapwood is almost white. Typical old-growth redwood is moderately lightweight, moderately strong and stiff, and moderately hard. The wood is easy to work, generally straight grained, and shrinks and swells comparatively little. The heartwood from old-growth trees has high decay resistance; heartwood from second-growth trees generally has low to moderate decay resistance.

Most redwood lumber is used for building. It is remanufactured extensively into siding, sashes, doors, blinds, millwork, casket stock, and containers. Because of its durability, redwood is useful for cooling towers, decking, tanks, silos, wood-stave pipe, and outdoor furniture. It is used in agriculture for buildings and equipment. Its use as timbers and large dimension in bridges and trestles is relatively minor. Redwood splits readily and plays an important role in the manufacture of split products, such as posts and fence material. Some redwood veneer is produced for decorative plywood.

Spruce, Eastern

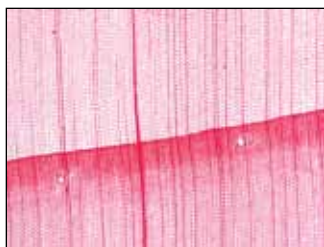

The term eastern spruce includes three species: red (*Picea rubens*), white (*P. glauca*), and black (*P. mariana*). White and black spruce grow principally in the Great Lake States and New England, and

red spruce grows in New England and the Appalachian Mountains.

The wood is light in color, and there is little difference between heartwood and sapwood. All three species have about the same properties, and they are not distinguished from each other in commerce. The wood dries easily and is stable

after drying, is moderately lightweight and easily worked, has moderate shrinkage, and is moderately strong, stiff, tough, and hard.

The greatest use of eastern spruce is for pulpwood. Eastern spruce lumber is used for framing material, general millwork, boxes and crates, and piano sounding boards.

Spruce, Engelmann

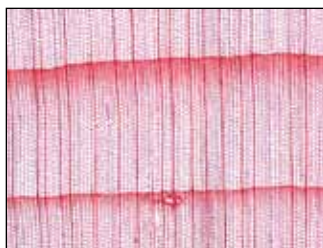

Engelmann spruce (*Picea engelmannii*) grows at high elevations in the Rocky Mountain region of the United States. This species is also known as white spruce, mountain spruce, Arizona spruce, silver spruce, and balsam.

About two-thirds of the lumber is produced in the southern Rocky Mountain States and most of the remainder in the northern Rocky Mountain States and Oregon.

The heartwood of Engelmann spruce is nearly white, with a slight tinge of red. The sapwood varies from 2 to 5 cm (1 to 2 in.) in width and is often difficult to distinguish from the heartwood. The wood has medium to fine texture and is without characteristic odor. Engelmann spruce is rated as lightweight, and it is low in strength as a beam or post. It is also soft and low in stiffness, shock resistance, and shrinkage. The lumber typically contains many small knots.

Engelmann spruce is used principally for lumber and for mine timbers, railroad cross ties, and poles. It is used also in building construction in the form of dimension lumber, flooring, and sheathing. It has excellent properties for pulp and papermaking.

Spruce, Sitka

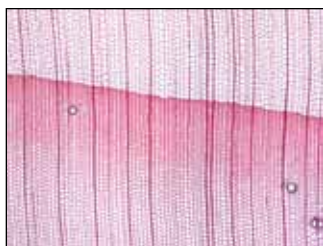

Sitka spruce (*Picea sitchensis*) is a large tree that grows along the northwestern coast of North America from California to Alaska. It is also known as yellow, tideland, western, silver, and west coast spruce.

Much Sitka spruce timber is grown in Alaska, but most logs are sawn into cants for export to Pacific Rim countries. Material for U.S. consumption is produced primarily in Washington and Oregon.

The heartwood of Sitka spruce is a light pinkish brown. The sapwood is creamy white and shades gradually into the heartwood; the sapwood may be 7 to 15 cm (3 to 6 in.) wide or even wider in young trees. The wood has a comparatively fine, uniform texture, generally straight grain, and no

distinct taste or odor. It is moderately lightweight, moderately low in bending and compressive strength, moderately stiff, moderately soft, and moderately low in resistance to shock. It has moderately low shrinkage. On the basis of weight, Sitka spruce rates high in strength properties and can be obtained in long, clear, straight-grained pieces.

Sitka spruce is used principally for lumber, pulpwood, and cooperage. Boxes and crates account for a considerable amount of the remanufactured lumber. Other important uses are furniture, planing-mill products, sashes, doors, blinds, millwork, and boats. Sitka spruce has been by far the most important wood for aircraft construction. Other specialty uses are ladder rails and sounding boards for pianos.

Tamarack

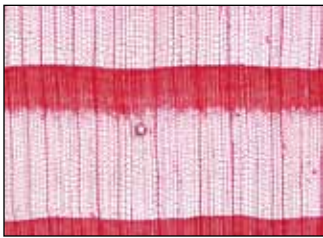

Tamarack (*Larix laricina*), also known as eastern larch and locally as hackmatack, is a small to medium tree with a straight, round, slightly tapered trunk. It grows from Maine to

Minnesota, with the bulk of the stand in the Great Lake States.

The heartwood of tamarack is yellowish brown to russet brown. The sapwood is whitish, generally less than 3 cm (1 in.) wide. The wood is coarse in texture, without odor or taste, and the transition from earlywood to latewood is abrupt. The wood is intermediate in weight and in most mechanical properties.

Tamarack is used principally for pulpwood, lumber, railroad crossties, mine timbers, fuel, fence posts, and poles. Lumber is used for framing material, tank construction, and boxes, pallets, and crates. The production of tamarack lumber has declined in recent years.

White-Cedar, Atlantic



Atlantic white-cedar (*Chamaecyparis thuyoides*), also known as southern white-cedar, swamp-cedar and boat-cedar, grows near the Atlantic Coast from Maine to northern Florida and westward along the Gulf

Coast to Louisiana. It is strictly a swamp tree. Production of Atlantic white-cedar centers in North Carolina and along the Gulf Coast.

The heartwood of Atlantic white-cedar is light brown, and the sapwood is white or nearly so. The sapwood is usually narrow. The wood is lightweight, rather soft, and low in strength and shock resistance. It shrinks little in drying. It

is easily worked and holds paint well, and the heartwood is highly resistant to decay. Because of its high durability it is used for poles, posts, cabin logs, railroad crossties, lumber, shingles, decorative fencing, boats, and water tanks.

White-Cedar, Northern

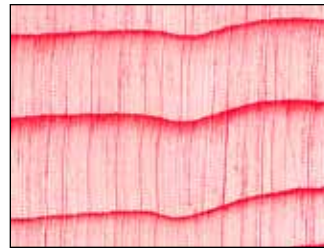

Northern white-cedar (*Thuja occidentalis*) is also known as eastern white-cedar or arborvitae. It grows from Maine along the Appalachians and westward through the northern part of the Great Lake States. Production

of northern white-cedar lumber is greatest in Maine and the Great Lake States.

The heartwood of Northern white-cedar is light brown, and the sapwood is nearly white and is usually narrow. The wood is lightweight, rather soft, low in strength and shock resistance, and with low shrinkage upon drying. It is easily worked and the heartwood is very decay resistant. Northern white-cedar is used for poles and posts, outdoor furniture, shingles, cabin logs, lumber, water tanks, boats and for wooden ware.

Yellow-Cedar

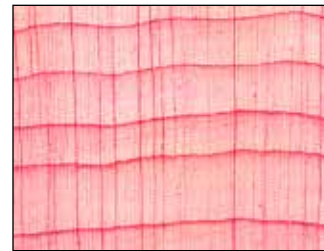

Yellow-cedar (*Chamaecyparis nootkatensis*) grows in the Pacific Coast region of North America from southeastern Alaska southward through Washington to southern Oregon.

The heartwood of yellow-cedar is bright, clear yellow. The sapwood is narrow, white to yellowish, and hardly distinguishable from the heartwood. The wood is fine textured and generally straight grained. It is moderately heavy, moderately strong and stiff, moderately hard, and moderately high in shock resistance. Yellow-cedar shrinks little in drying and is stable after drying, and the heartwood is very resistant to decay. The wood has a mild, distinctive odor.

Yellow-cedar is used for interior woodwork, furniture, small boats, cabinetwork, and novelties.

Imported Woods

This section includes many of the species that at present are considered to be commercially important, but by no means can it be considered all-inclusive. The import timber market is constantly changing, with some species no longer available but with new species entering the market. The same species may be marketed in the United States under other common names. Because of the variation in common

names, many cross-references are included. Text information is necessarily brief, but when used in conjunction with the shrinkage and strength data tables, a reasonably good picture may be obtained of a particular wood. The references at the end of this chapter contain information on many species not described in this section.

Imported Hardwoods

Afara

(see Limba)

Afromosia

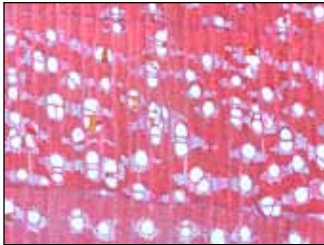

Afromosia or kokrodua (*Pericopsis elata*), a large West African tree, is sometimes used as a substitute for teak (*Tectona grandis*).

The heartwood is fine textured, with straight to

interlocked grain. The wood is brownish yellow with darker streaks and moderately hard and heavy, weighing about 700 kg m^{-3} (43 lb ft^{-3}) at 15% moisture content. The wood strongly resembles teak in appearance but lacks its oily nature and has a different texture. The wood dries readily with little degrade and has good dimensional stability. It is somewhat heavier and stronger than teak. The heartwood is highly resistant to decay fungi and termite attack and is extremely durable under adverse conditions.

Afromosia is often used for the same purposes as teak, such as boat construction, joinery, flooring, furniture, interior woodworking, and decorative veneer.

Albarco

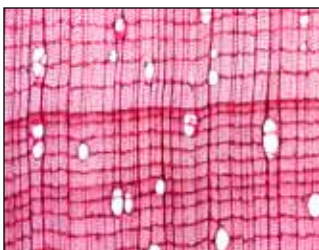

Albarco, or jequitiba as it is known in Brazil, is the common name applied to species in the genus *Cariniana*. The 10 species are distributed from eastern Peru and northern Bolivia through central Brazil to Venezuela and Colombia.

The heartwood is reddish or purplish brown and sometimes has dark streaks. It is usually not sharply demarcated from the pale brown sapwood. The texture is medium and the grain straight to interlocked. Albarco can be worked satisfactorily with only slight blunting of tool cutting edges because of the presence of silica. Veneer can be cut without difficulty. The wood is rather strong and moderately heavy, weighing about 560 kg m^{-3} (35 lb ft^{-3}) at 12% moisture content. In general, the wood has about the same strength as that of U.S. oaks (*Quercus* spp.). The heartwood is durable, particularly the deeply colored material. It has good resistance to dry-wood termite attack.

Albarco is primarily used for general construction and carpentry wood, but it can also be used for furniture components, shipbuilding, flooring, veneer for plywood, and turnery.

Amaranth

(see Purpleheart)

Anani

(see Manni)

Anaura

(see Marishballi)

Andiroba

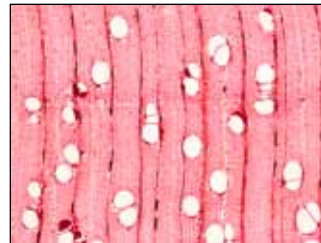

Because of the widespread distribution of andiroba (*Carapa guianensis*) in tropical America, the wood is known under a variety of names, including cedro macho, carapa, crabwood, and tangare. These names are

also applied to the related species *C. nicaraguensis*, whose properties are generally inferior to those of *C. guianensis*.

The heartwood varies from medium to dark reddish brown. The texture is like that of true mahogany (*Swietenia macrophylla*), and andiroba is sometimes substituted for true mahogany. The grain is usually interlocked but is rated easy to work, paint, and glue. The wood is rated as durable to very durable with respect to decay and insects. Andiroba is heavier than true mahogany and accordingly is markedly superior in all static bending properties, compression parallel to grain, hardness, shear, and durability.

On the basis of its properties, andiroba appears to be suited for such uses as flooring, frame construction in the tropics, furniture and cabinetwork, millwork, utility and decorative veneer, and plywood.

Angelin

(see Sucupira)

Angelique

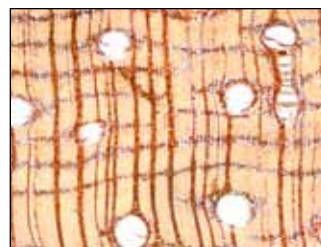

Angelique (*Dicorynia guianensis*) comes from French Guiana and Suriname.

Because of the variability in heartwood color between different trees, two forms are commonly recognized by producers. The heartwood that is russet-colored when freshly cut and becomes superficially dull brown with a purplish cast is referred to as "gris." The heartwood that is

more distinctly reddish and frequently shows wide purplish bands is called “angelique rouge.” The texture of the wood is somewhat coarser than that of black walnut (*Juglans nigra*), and the grain is generally straight or slightly interlocked. In strength, angelique is superior to teak (*Tectona grandis*) and white oak (*Quercus alba*), when green or air dry, in all properties except tension perpendicular to grain. Angelique is rated as highly resistant to decay and resistant to marine borer attack. Machining properties vary and may be due to differences in density, moisture content, and silica content. After the wood is thoroughly air or kiln dried, it can be worked effectively only with carbide-tipped tools.

The strength and durability of angelique make it especially suitable for heavy construction, harbor installations, bridges, heavy planking for pier and platform decking, and railroad bridge ties. The wood is also suitable for ship decking, planking, boat frames, industrial flooring, and parquet blocks and strips.

Apa

(see Wallaba)

Apamate

(see Roble)

Apitong

(see Keruing)

Avodire



Avodire (*Turraeanthus africanus*) has a rather extensive range in Africa, from Sierra Leone westward to the Congo region and southward to Zaire and Angola. It is most common in the eastern region of the Ivory Coast

and is scattered elsewhere. Avodire is a medium-size tree of the rainforest where it forms fairly dense but localized and discontinuous timber stands.

The wood is cream to pale yellow with high natural luster; it eventually darkens to a golden yellow. The grain is sometimes straight but more often wavy or irregularly interlocked, which produces an unusual and attractive mottled figure when sliced or cut on the quarter. Although avodire weighs less than northern red oak (*Quercus rubra*), it has almost identical strength properties except that it is lower in shock resistance and shear. The wood works fairly easily with hand and machine tools and finishes well in most operations.

Figured material is usually converted into veneer for use in decorative work, and it is this kind of material that is chiefly imported into the United States. Other uses include furniture, fine joinery, cabinetwork, and paneling.

Azobe (Ekki)

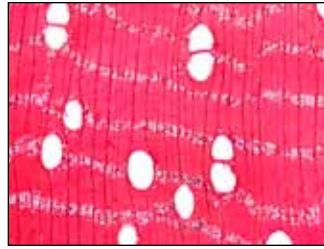

Azobe or ekki (*Lophira alata*) is found in West Africa and extends into the Congo basin.

The heartwood is dark red, chocolate-brown, or purple-brown with conspicuous white deposits in the pores (vessels). The texture is coarse, and the grain is usually interlocked. The wood is strong, and its density averages about 1,120 kg m⁻³ (70 lb ft⁻³) at 12% moisture content. It is very difficult to work with hand and machine tools, and tools are severely blunted if the wood is machined when dry. Azobe can be dressed to a smooth finish, and gluing properties are usually good. Drying is very difficult without excessive degrade, and the heartwood is extremely resistant to preservative treatment. The heartwood is rated as very durable against decay, resistant to teredo attack, but only moderately resistant to termites. Azobe is very resistant to acid and has good weathering properties.

Azobe is excellent for heavy construction work, harbor construction, heavy-duty flooring, and railroad crossties.

Bagtikan

(see Seraya, White)

Balata

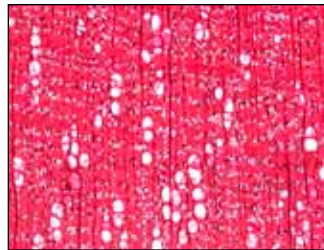

Balata or bulletwood (*Manilkara bidentata*) is widely distributed throughout the West Indies, Central America, and northern South America.

The heartwood of balata is light to dark reddish brown and not sharply demarcated from the pale brown sapwood. Texture is fine and uniform, and the grain is straight to occasionally wavy or interlocked. Balata is a strong and very heavy wood; density of air-dried wood is 1,060 kg m⁻³ (66 lb ft⁻³). It is generally difficult to air dry, with a tendency to develop severe checking and warp. The wood is moderately easy to work despite its high density, and it is rated good to excellent in all machining operations. Balata is very resistant to attack by decay fungi and highly resistant to subterranean termites but only moderately resistant to dry-wood termites.

Balata is suitable for heavy construction, textile and pulp-mill equipment, furniture parts, turnery, tool handles, flooring, boat frames and other bentwork, railroad crossties, violin bows, billiard cues, and other specialty uses.

Balau

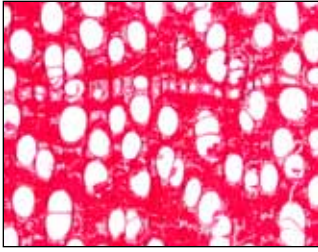

Balau, red balau, and selangan batu constitute a group of species that are the heaviest of the 200 *Shorea* species. About 45 species of this group grow from Sri Lanka and southern India through southeast Asia to the Philippines.

The heartwood is light to deep red or purple-brown, and it is fairly distinct from the lighter and yellowish- to reddish- or purplish-brown sapwood. The texture is moderately fine to coarse, and the grain is often interlocked. The wood weighs more than 750 kg m^{-3} (47 lb ft^{-3}) at 12% moisture content. Balau is a heavy, hard, and strong timber that dries slowly with moderate to severe end checks and splits. The heartwood is durable to moderately durable and very resistant to preservative treatments.

Balau is used for heavy construction, frames of boats, decking, flooring, and utility furniture.

Balau, Red

(see Balau)

Balsa

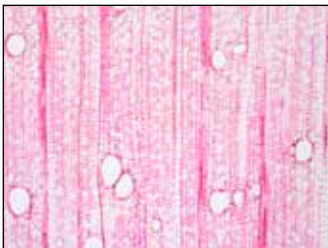

Balsa (*Ochroma pyramidale*) is widely distributed throughout tropical America from southern Mexico to southern Brazil and Bolivia, but Ecuador has been the principal source of supply since the wood gained commercial im-

portance. It is usually found at lower elevations, especially on bottom-land soils along streams and in clearings and cutover forests. Today, it is often cultivated in plantations.

Several characteristics make balsa suitable for a wide variety of uses. It is the lightest and softest of all woods on the market. The lumber selected for use in the United States weighs, on the average, about 180 kg m^{-3} (11 lb ft^{-3}) when dry and often as little as 100 kg m^{-3} (6 lb ft^{-3}). The wood is readily recognized by its light weight; nearly white or oatmeal color, often with a yellowish or pinkish hue; and unique velvety feel.

Because of its light weight and exceedingly porous composition, balsa is highly efficient in uses where buoyancy, insulation against heat or cold, or low propagation of sound and vibration are important. Principal uses are for life-saving equipment, floats, rafts, corestock, insulation, cushioning, sound modifiers, models, and novelties.

Banak, Cuangare

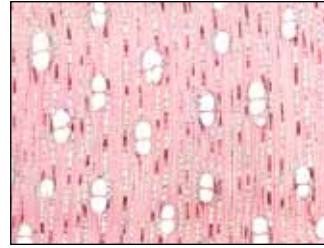

Various species of banak (*Virola*) occur in tropical America, from Belize and Guatemala southward to Venezuela, the Guianas, the Amazon region of northern Brazil, and southern Brazil, and on the Pacific Coast

to Peru and Bolivia. Most of the wood known as banak is *V. koschnyi* of Central America and *V. surinamensis* and *V. sebifera* of northern South America. Botanically, cuangare (*Dialyanthera*) is closely related to banak, and the woods are so similar that they are generally mixed in the trade. The main commercial supply of cuangare comes from Colombia and Ecuador. Banak and cuangare are common in swamp and marsh forests and may occur in almost pure stands in some areas.

The heartwood of both banak and cuangare is usually pinkish or grayish brown and is generally not differentiated from the sapwood. The wood is straight grained and is of a medium to coarse texture. The various species are non-resistant to decay and insect attack but can be readily treated with preservatives. Machining properties are very good, but when zones of tension wood are present, machining may result in surface fuzziness. The wood finishes readily and is easily glued. Strength properties of banak and cuangare are similar to those of yellow-poplar (*Liriodendron tulipifera*).

Banak is considered a general utility wood for lumber, veneer, and plywood. It is also used for moulding, millwork, and furniture components.

Benge, Ehie, Bubinga

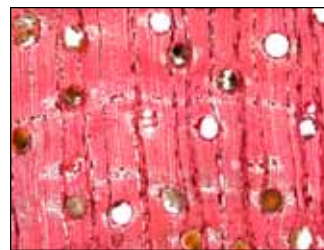

Although benge (*Guibourtia arnoldiana*), ehie (or ovankol) (*Guibourtia ehie*), and bubinga (*Guibourtia* spp.) belong to the same West African genus, they differ rather markedly in color and somewhat in texture.

The heartwood of benge is pale yellowish brown to medium brown with gray to almost black stripes. Ehie heartwood tends to be more golden brown to dark brown with gray to almost black stripes. Bubinga heartwood is pink, vivid red, or red-brown with purple streaks, and it becomes yellow or medium brown with a reddish tint upon exposure to air. The texture of ehie is moderately coarse, whereas that of benge and bubinga is fine to moderately fine. All three woods are moderately hard and heavy, but they can be worked well with hand and machine tools. They are listed as moderately

durable and resistant to preservative treatment. Drying may be difficult, but with care, the wood dries well.

These woods are used in turnery, flooring, furniture components, cabinetwork, and decorative veneers.

Brown Silverballi

(see Kaneelhart)

Bubinga

(see Benge)

Bulletwood

(see Balata)

Carapa

(see Andiroba)

Cativo

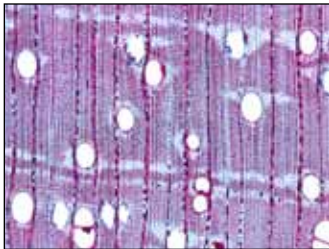

Cativo (*Prioria copaifera*) is one of the few tropical American species that occur in abundance and often in nearly pure stands. Commercial stands are found in Nicaragua, Costa Rica, Panama, and Colombia.

Sapwood may be very pale pink or distinctly reddish, and it is usually wide. In trees up to 76 cm (30 in.) in diameter, heartwood may be only 18 cm (7 in.) in diameter. The grain is straight and the texture of the wood is uniform, comparable with that of true mahogany (*Swietenia macrophylla*). On flat-sawn surfaces, the figure is rather subdued as a result of exposure of the narrow bands of parenchyma tissue. The wood can be dried rapidly and easily with very little degrade. Dimensional stability is very good—practically equal to that of true mahogany. Cativo is classified as a non-durable wood with respect to decay and insects. It may contain appreciable quantities of gum. In wood that has been properly dried, however, the aromatics in the gum are removed and there is no difficulty in finishing.

Considerable quantities of cativo are used for interior woodwork, and resin-stabilized veneer is an important pattern material. Cativo is widely used for furniture and cabinet parts, lumber core for plywood, picture frames, edge banding for doors, joinery, and millwork.

Cedro

(see Spanish-Cedar)

Cedro Macho

(see Andiroba)

Cedro-Rana

(see Tornillo)

Ceiba

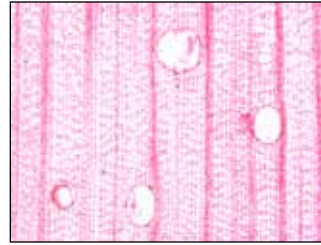

Ceiba (*Ceiba pentandra*) is a large tree that grows to 66 m (200 ft) in height with a straight cylindrical bole 13 to 20 m (40 to 60 ft) long. Trunk diameters of 2 m (6 ft) or more are common. Ceiba grows in West Africa, from the

Ivory Coast and Sierra Leone to Liberia, Nigeria, and the Congo region. A related species is lupuna (*C. samauma*) from South America.

Sapwood and heartwood are not clearly demarcated. The wood is whitish, pale brown, or pinkish brown, often with yellowish or grayish streaks. The texture is coarse, and the grain is interlocked or occasionally irregular. Ceiba is very soft and light; density of air-dried wood is 320 kg m⁻³ (20 lb ft⁻³). In strength, the wood is comparable with basswood (*Tilia americana*). Ceiba dries rapidly without marked deterioration. It is difficult to saw cleanly and dress smoothly because of the high percentage of tension wood. It provides good veneer and is easy to nail and glue. Ceiba is very susceptible to attack by decay fungi and insects. It requires rapid harvest and conversion to prevent deterioration. Treatability, however, is rated as good.

Ceiba is available in large sizes, and its low density combined with a rather high degree of dimensional stability make it ideal for pattern and corestock. Other uses include blockboard, boxes and crates, joinery, and furniture components.

Chewstick

(see Manni)

Courbaril, Jatoba

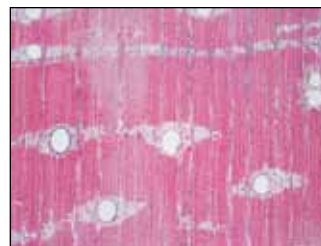

The genus *Hymenaea* consists of about 25 species that occur in the West Indies and from southern Mexico through Central America into the Amazon basin of South America. The best-known and most important species is

H. courbaril, which occurs throughout the range of the genus. Courbaril is often called jatoba in Brazil.

Sapwood of courbaril is gray–white and usually quite wide. The heartwood, which is sharply differentiated from the sapwood, is salmon red to orange–brown when freshly cut and becomes russet or reddish brown when dried. The heartwood is often marked with dark streaks. The texture is medium to rather coarse, and the grain is mostly interlocked. The wood is hard and heavy (about 800 kg m⁻³

(50 lb ft⁻³) at 12% moisture content). The strength properties of courbaril are quite high and very similar to those of shagbark hickory (*Carya ovata*), a species of lower specific gravity. Courbaril is rated as moderately to very resistant to attack by decay fungi and dry-wood termites. The heartwood is not treatable, but the sapwood is treatable with preservatives. Courbaril is moderately difficult to saw and machine because of its high density, but it can be machined to a smooth surface. Turning, gluing, and finishing properties are satisfactory. Planing, however, is somewhat difficult because of the interlocked grain. Courbaril compares favorably with white oak (*Quercus alba*) in steam-bending behavior.

Courbaril is used for tool handles and other applications that require good shock resistance. It is also used for steam-bent parts, flooring, turnery, furniture and cabinetwork, veneer and plywood, railroad crossties, and other specialty items.

Crabwood

(see Andiroba)

Cristobal

(see Macawood)

Cuangare

(see Banak)

Degame



Degame or lemonwood (*Calycophyllum candidissimum*) grows in Cuba and ranges from southern Mexico through Central America to Colombia and Venezuela. It may grow in pure

stands and is common on shaded hillsides and along waterways.

The heartwood of degame ranges from light brown to oatmeal-colored and is sometimes grayish. The sapwood is lighter in color and merges gradually with the heartwood. The texture is fine and uniform. The grain is usually straight or infrequently shows shallow interlocking, which may produce a narrow and indistinct stripe on quartered faces. In strength, degame is above the average for woods of similar density; density of air-dried wood is 817 kg m⁻³ (51 lb ft⁻³). Tests show degame superior to persimmon (*Diospyros virginiana*) in all respects but hardness. Natural durability is low when degame is used under conditions favorable to stain, decay, and insect attack. However, degame is reported to be highly resistant to marine borers. Degame is moderately difficult to machine because of its density and hardness, although it does not dull cutting tools to any extent. Machined surfaces are very smooth.

Degame is little used in the United States, but its characteristics have made it particularly adaptable for shuttles, picker sticks, and other textile industry items that require resilience and strength. Degame was once prized for the manufacture of archery bows and fishing rods. It is also suitable for tool handles and turnery.

Determa

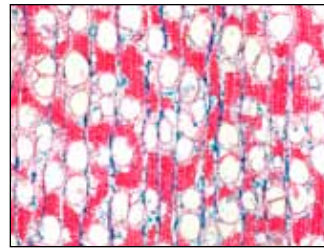

Determa (*Ocotea rubra*) is native to the Guianas, Trinidad, and the lower Amazon region of Brazil.

The heartwood is light reddish brown with a golden sheen and distinct from the dull gray or pale

yellowish brown sapwood. The texture is rather coarse, and the grain is interlocked to straight. Determa is a moderately strong and heavy wood (density of air-dried wood is 640 to 720 kg m⁻³ (40 to 45 lb ft⁻³)); this wood is moderately difficult to air dry. It can be worked readily with hand and machine tools with little dulling effect. It can be glued readily and polished fairly well. The heartwood is durable to very durable in resistance to decay fungi and moderately resistant to dry-wood termites. Weathering characteristics are excellent, and the wood is highly resistant to moisture absorption.

Uses for determa include furniture, general construction, boat planking, tanks and cooperage, heavy marine construction, turnery, and parquet flooring.

Ehie

(see Bengé)

Ekki

(see Azobe)

Ekop

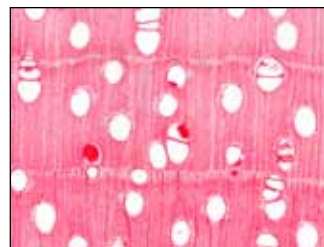

Ekop or gola (*Tetraberlinia tubmaniana*) grows only in Liberia.

The heartwood is light reddish brown and is distinct from the lighter colored sapwood, which may be up to 5 cm (2 in.)

wide. The wood is medium to coarse textured, and the grain is interlocked, with a narrow striped pattern on quartered surfaces. The wood weighs about 735 kg m⁻³ (46 lb ft⁻³) at 12% moisture content. It dries fairly well but with a marked tendency to end and surface checks. Ekop works well with hand and machine tools and is an excellent wood for turnery. It also slices well into veneer and has good gluing properties. The heartwood is only moderately durable and is moderately resistant to impregnation with preservative treatments.

Ekop is a general utility wood that is used for veneer, plywood, and furniture components.

Encino

(see Oak)

Gola

(see Ekop)

Gonçalo Alves

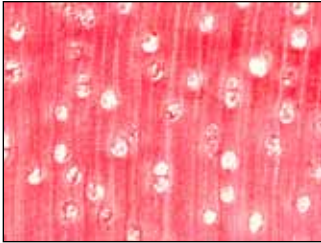

Most imports of gonçalo alves (*Astronium graveolens* and *A. fraxinifolium*) have been from Brazil. These species range from southern Mexico through Central America into the Amazon basin.

Freshly cut heartwood is russet brown, orange–brown, or reddish brown to red with narrow to wide, irregular, medium to very dark brown stripes. After exposure to air, the heartwood becomes brown, red, or dark reddish brown with nearly black stripes. The sapwood is grayish white and sharply demarcated from the heartwood. The texture is fine to medium and uniform. The grain varies from straight to interlocked and wavy.

Gonçalo alves turns readily, finishes very smoothly, and takes a high natural polish. The heartwood is highly resistant to moisture absorption; pigmented areas may present some difficulties in gluing because of their high density. The heartwood is very durable and resistant to both white- and brown-rot organisms. The high density (1,010 kg m⁻³ (63 lb ft⁻³)) of the air-dried wood is accompanied by equally high strength values, which are considerably higher in most respects than those of any U.S. species. Despite its strength, however, gonçalo alves is imported primarily for its beauty.

In the United States, gonçalo alves has the greatest value for specialty items such as archery bows, billiard cue butts, brushbacks, and cutlery handles, and in turnery and carving applications.

Greenheart



Greenheart (*Chlorocardium rodiei*) is essentially a Guyana tree, although small stands also occur in Suriname.

The heartwood varies from light to dark olive green or nearly black. The texture is fine and uniform, and the grain is straight to wavy. Greenheart is stronger and stiffer than white oak (*Quercus alba*) and generally more difficult to work with tools because of its high density; density of air-dried wood is more than 960 kg m⁻³ (60 lb ft⁻³). The heartwood is rated as very

resistant to decay fungi and termites. It is also very resistant to marine borers in temperate waters but much less so in warm tropical waters.

Greenheart is used principally where strength and resistance to wear are required. Uses include ship and dock building, lock gates, wharves, piers, jetties, vats, piling, planking, industrial flooring, bridges, and some specialty items (fishing rods and billiard cue butts).

Guatambu

(see Pau Marfim)

Guayacan

(see Ipe)

Hura

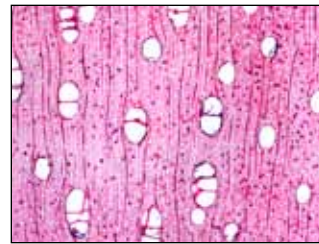

Hura (*Hura crepitans*) grows throughout the West Indies from Central America to northern Brazil and Bolivia.

It is a large tree, commonly reaching a height of 30 to 43 m (90 to 130 ft), with clear boles of 12 to 23 m (40 to 75 ft). The diameter often reaches 1 to 1.5 m (3 to 5 ft) and occasionally to 3 m (9 ft).

The pale yellowish-brown or pale olive-gray heartwood is indistinct from the yellowish-white sapwood. The texture is fine to medium and the grain straight to interlocked. Hura is a low-strength and low-density wood (density of air-dried wood is 240 to 448 kg m⁻³ (15 to 28 lb ft⁻³)); the wood is moderately difficult to air dry. Warping is variable and sometimes severe. The wood usually machines easily, but green material is somewhat difficult to work because of tension wood, which results in a fuzzy surface. The wood finishes well and is easy to glue and nail. Hura is variable in resistance to attack by decay fungi, but it is highly susceptible to blue stain and very susceptible to wood termites. However, the wood is easy to treat with preservative.

Hura is often used in general carpentry, boxes and crates, and lower grade furniture. Other important uses are veneer and plywood, fiberboard, and particleboard.

Ilomba

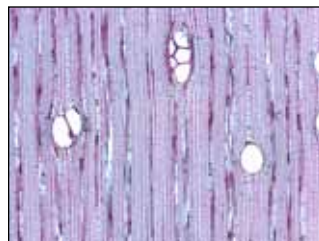

Ilomba (*Pycnanthus angolensis*) is a tree of the rainforest and ranges from Guinea and Sierra Leone through tropical West Africa to Uganda and Angola. Common names include pycnanthus, walele, and otie.

The wood is grayish white to pinkish brown and, in some trees, a uniform light brown. There is generally no distinction between heartwood and sapwood. The texture is medium to coarse, and the grain is generally straight. This species is generally similar to banak (*Virola*) but has a coarser texture. Air-dry density is about 512 kg m^{-3} (31 lb ft^{-3}), and the wood is about as strong as yellow-poplar (*Liriodendron tulipifera*). Ilomba dries rapidly but is prone to collapse, warp, and splits. It is easily sawn and can be worked well with hand and machine tools. It is excellent for veneer and has good gluing and nailing characteristics. Green wood is subject to insect and fungal attack. Logs require rapid extraction and conversion to avoid degrade. Both sapwood and heartwood are permeable and can be treated with preservatives.

In the United States, this species is used only in the form of plywood for general utility purposes. However, ilomba is definitely suited for furniture components, interior joinery, and general utility purposes.

Ipe

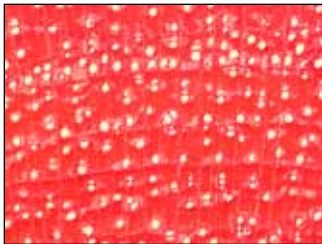

Ipe, the common name for the lapacho group of the genus *Tabebuia*, consists of about 20 species of trees and occurs in practically every Latin America country except Chile. Other commonly used names are guayacan and lapacho.

Sapwood is relatively wide, yellowish gray or gray-brown, and sharply differentiated from heartwood, which is light to dark olive brown. The texture is fine to medium. The grain is straight to very irregular and often narrowly interlocked. The wood is very heavy and averages about $1,025 \text{ kg m}^{-3}$ (64 lb ft^{-3}) at 12% moisture content. Thoroughly air-dried heartwood specimens generally sink in water. Because of its high density and hardness, ipe is moderately difficult to machine, but glassy smooth surfaces can be produced. Ipe is very strong; in the air-dried condition, it is comparable with greenheart (*Chlorocardium rodiei*). Hardness is two to three times that of white oak (*Quercus alba*) or keruing (*Dipterocarpus*). The wood is highly resistant to decay and insects, including both subterranean and dry-wood termites, but susceptible to marine borer attack. The heartwood is impermeable, but the sapwood can be readily treated with preservatives.

Ipe is used almost exclusively for heavy-duty and durable construction. Because of its hardness and good dimensional stability, it is particularly well suited for heavy-duty flooring in trucks and boxcars. It is also used for decks, railroad crossties, turnery, tool handles, decorative veneers, and some specialty items in textile mills.

Ipil

(see Merbau)

Iroko

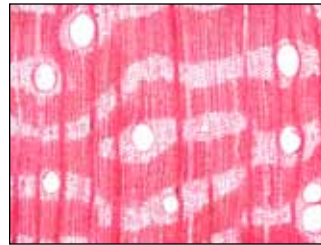

Iroko consists of two species (*Milicia excelsa* and *M. regia*). *Milicia excelsa* grows across the entire width of tropical Africa from the Ivory Coast southward to Angola and eastward to East Africa. *M. regia*,

however, is limited to extreme West Africa from Gambia to Ghana; it is less resistant to drought than is *M. excelsa*.

The heartwood varies from a pale yellowish brown to dark chocolate brown with light markings occurring most conspicuously on flat-sawn surfaces; the sapwood is yellowish white. The texture is medium to coarse, and the grain is typically interlocked. Iroko can be worked easily with hand or machine tools but with some tearing of interlocked grain. Occasional deposits of calcium carbonate severely damage cutting edges. The wood dries rapidly with little or no degrade. The strength is similar to that of red maple (*Acer rubrum*), and the weight is about 688 kg m^{-3} (43 lb ft^{-3}) at 12% moisture content. The heartwood is very resistant to decay fungi and resistant to termite and marine borer attack.

Because of its color and durability, iroko has been suggested as a substitute for teak (*Tectona grandis*). Its durability makes it suitable for boat building, piles, other marine work, and railroad crossties. Other uses include joinery, flooring, furniture, veneer, and cabinetwork.

Jacaranda

(see Rosewood, Brazilian)

Jarrah

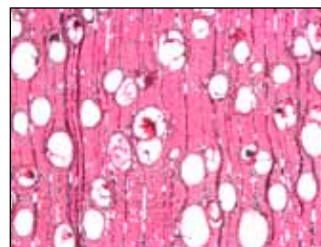

Jarrah (*Eucalyptus marginata*) is native to the coastal belt of southwestern Australia and is one of the principal species for that country's sawmill industry.

The heartwood is a uniform pink to dark red, often turning to deep brownish red with age and exposure to air. The sapwood is pale and usually very narrow in old trees. The texture is even and moderately coarse, and the grain is frequently interlocked or wavy. The wood weighs about 865 kg m^{-3} (54 lb ft^{-3}) at 12% moisture content. The common defects of jarrah include gum veins or pockets, which in extreme instances separate the log into concentric shells. Jarrah is a heavy, hard timber possessing correspondingly high strength properties. It is resistant to attack by termites and rated as very

durable with respect to decay. The wood is difficult to work with hand and machine tools because of its high density and irregular grain.

Jarrah is used for decking and underframing of piers, jetties, and bridges, as well as piles and fenders for docks and harbors. As flooring, jarrah has high resistance to wear, but it is inclined to splinter under heavy traffic. It is also used for railroad cross-ties and other heavy construction.

Jatoba

(see Courbaril)

Jelutong

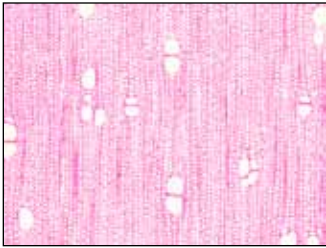

Jelutong (*Dyera costulata*) is an important species in Malaysia where it is best known for its latex production in the manufacture of chewing gum rather than for its wood.

The wood is white or straw colored, and there is no differentiation between heartwood and sapwood. The texture is moderately fine and even. The grain is straight, and luster is low. The wood weighs about 465 kg m⁻³ (28 lb ft⁻³) at 12% moisture content. The wood is very easy to dry with little tendency to split or warp, but staining may cause trouble. It is easy to work in all operations, finishes well, and glues satisfactorily. The wood is rated as nondurable but readily permeable to preservatives.

Because of its low density and ease of working, jelutong is well suited for sculpture and pattern making, wooden shoes, picture frames, and drawing boards.

Jequitiba

(see Albarco)

Kakaralli

(see Manbarklak)

Kaneelhart

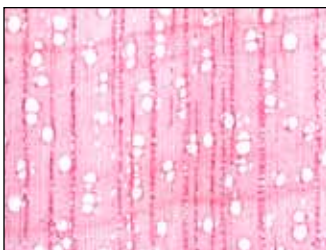

Kaneelhart or brown silverballi are names applied to the genus *Licaria*. Species of this genus grow mostly in Guyana, French Guiana, and Suriname and are found in association with greenheart (*Chlorocardium rodiei*) on hilly terrain and wallaba (*Eperua*) in forests.

The orange or brownish yellow heartwood darkens to yellowish or coffee brown on exposure to air. The wood is sometimes tinged with red or violet. The texture is fine to

medium, and the grain is straight to slightly interlocked. The wood has a fragrant odor, which is lost in drying. Kaneelhart is a very strong and very heavy wood (density of air-dried wood is 833 to 1,153 kg m⁻³ (52 to 72 lb ft⁻³)); the wood is difficult to work. It cuts smoothly and takes an excellent finish but requires care in gluing. Kaneelhart has excellent resistance to both brown- and white-rot fungi and is also rated very high in resistance to dry-wood termites.

Uses of kaneelhart include furniture, turnery, boat building, heavy construction, and parquet flooring.

Uses of kaneelhart include furniture, turnery, boat building, heavy construction, and parquet flooring.

Kapur

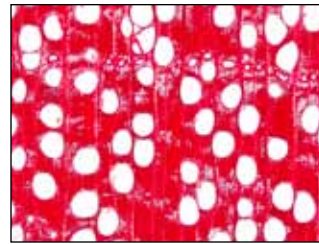

The genus *Dryobalanops* consists of nine species distributed over parts of Malaysia and Indonesia. For the export trade, the species are combined under the name kapur.

The heartwood is reddish brown and clearly demarcated from the pale sapwood. The wood is fairly coarse textured but uniform. In general, the wood resembles keruing (*Dipterocarpus*), but on the whole, kapur is straighter grained and not quite as coarse in texture. Density of the wood averages about 720 to 800 kg m⁻³ (45 to 50 lb ft⁻³) at 12% moisture content. Strength properties are similar to those of keruing at comparable specific gravity. The heartwood is rated resistant to attack by decay fungi; it is reported to be vulnerable to termites. Kapur is extremely resistant to preservative treatment. The wood works with moderate ease in most hand and machine operations, but blunting of cutters may be severe because of silica content, particularly when the dry wood is machined. A good surface can be obtained from various machining operations, but there is a tendency toward raised grain if dull cutters are used. Kapur takes nails and screws satisfactorily. The wood glues well with urea formaldehyde but not with phenolic adhesives.

Kapur provides good and very durable construction wood and is suitable for all purposes for which keruing (*Dipterocarpus*) is used in the United States. In addition, kapur is extensively used in plywood either alone or with species of *Shorea* (lauan–meranti).

Karri

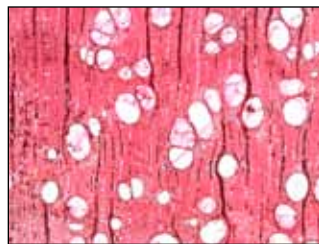

Karri (*Eucalyptus diversicolor*) is a very large tree limited to southwestern Australia.

Karri resembles jarrah (*E. marginata*) in structure and general appearance. It is usually paler

in color and, on average, slightly heavier (913 kg m⁻³ (57 lb ft⁻³)) at 12% moisture content. Karri is a heavy

hardwood with mechanical properties of a correspondingly high order, even somewhat higher than that of jarrah. The heartwood is rated as moderately durable, though less so than that of jarrah. It is extremely difficult to treat with preservatives. The wood is fairly hard to machine and difficult to cut with hand tools. It is generally more resistant to cutting than is jarrah and has a slightly more dulling effect on tool edges.

Karri is inferior to jarrah for underground use and water-works. However, where flexural strength is required, such as in bridges, floors, rafters, and beams, karri is an excellent wood. Karri is popular in heavy construction because of its strength and availability in large sizes and long lengths that are free of defects.

Kauta

(see Marishballi)

Kempas

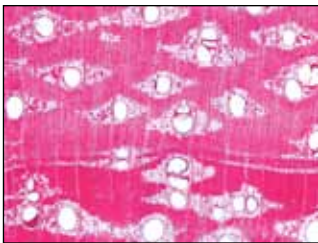

Kempas (*Koompassia malaccensis*) is distributed throughout the lowland forest in rather swampy areas of Malaysia and Indonesia.

When exposed to air, the freshly cut brick-red heart-

wood darkens to an orange-red or red-brown with numerous yellow-brown streaks as a result of the soft tissue (axial parenchyma) associated with the pores. The texture is rather coarse, and the grain is typically interlocked. Kempas is a hard, heavy wood (density of air-dried wood is 880 kg m^{-3} (55 lb ft^{-3})); the wood is difficult to work with hand and machine tools. The wood dries well, with some tendency to warp and check. The heartwood is resistant to attack by decay fungi but vulnerable to termite activity. However, it treats readily with preservative retention as high as 320 kg m^{-3} (20 lb ft^{-3}).

Kempas is ideal for heavy construction work, railroad crossties, and flooring.

Keruing (Apitong)

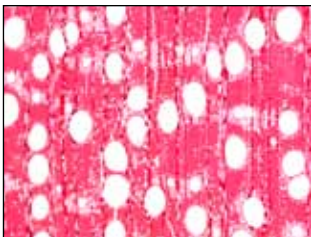

Keruing or apitong (*Dipterocarpus*) is widely scattered throughout the Indo-Malaysian region. Most of the more than 70 species in this genus are marketed under the name keruing. Other important species are

marketed as apitong in the Philippine Islands and yang in Thailand.

The heartwood varies from light to dark red-brown or brown to dark brown, sometimes with a purple tint; the heartwood is usually well defined from the gray or buff-colored sapwood. Similar to kapur (*Dryobalanops*), the

texture of keruing is moderately coarse and the grain is straight or shallowly interlocked. The wood is strong, hard, and heavy (density of air-dried wood is 720 to 800 kg m^{-3} (45 to 50 lb ft^{-3})); this wood is characterized by the presence of resin ducts, which occur singly or in short arcs as seen on end-grain surfaces. This resinous condition and the presence of silica can present troublesome problems. Sapwood and heartwood are moderately resistant to preservative treatments. However, the wood should be treated with preservatives when it is used in contact with the ground. Durability varies with species, but the wood is generally classified as moderately durable. Keruing generally takes to sawing and machining, particularly when green, but saws and cutters dull easily as a result of high silica content in the wood. Resin adheres to machinery and tools and may be troublesome. Also, resin may cause gluing and finishing difficulties.

Keruing is used for general construction work, framework for boats, flooring, pallets, chemical processing equipment, veneer and plywood, railroad crossties (if treated), truck floors, and boardwalks.

Khaya

(see Mahogany, African)

Kokrodua

(see Afrormosia)

Korina

(see Limba)

Krabak

(see Mersawa)

Kwila

(see Merbau)

Lapacho

(see Ipe)

Lapuna

(see Ceiba)

Lauan

(see Meranti Groups)

Lemonwood

(see Degame)

Lignumvitae

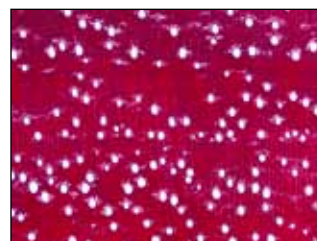

For many years, the only species of lignumvitae used on a large scale was *Guaiacum officinale*, which is native to the West Indies, northern Venezuela, northern Colombia, and Panama. With

the near exhaustion of *G. officinale*, harvesters turned to *G. sanctum*, which is now the principal commercial species. *G. sanctum* occupies the same range as *G. officinale* but is more extensive and includes the Pacific side of Central America as well as southern Mexico.

Lignumvitae is one of the heaviest and hardest woods on the market. The wood is characterized by its unique green color and oily or waxy feel. The wood has a fine uniform texture and closely interlocked grain. Its resin content may constitute up to one-fourth of the air-dried weight of the heartwood.

Lignumvitae wood is used chiefly for bearing or bushing blocks for ship propeller shafts. The great strength and tenacity of lignumvitae, combined with self-lubricating properties resulting from the high resin content, make it especially adaptable for underwater use. It is also used for such articles as mallets, pulley sheaves, caster wheels, stencil and chisel blocks, and turned products.

Limba

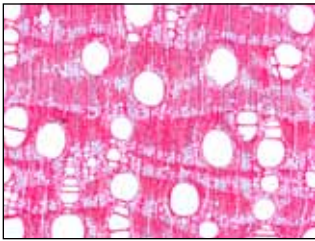

Limba (*Terminalia superba*), also referred to as afara, korina, or ofram, is widely distributed from Sierra Leone to Angola and Zaire in the rainforest and savanna forest. Limba is also favored as a plantation species in West Africa.

The heartwood varies from gray–white to creamy or yellow brown and may contain dark streaks that are nearly black, producing an attractive figure that is valued for decorative veneer. The light color of the wood is considered an important asset for the manufacture of blond furniture. The wood is generally straight grained and of uniform but coarse texture. The wood is easy to dry and shrinkage is reported to be rather low. Limba is not resistant to decay, insects, or termites. It is easy to work with all types of tools and is made into veneer without difficulty.

Principal uses include plywood, furniture, interior joinery, and sliced decorative veneer.

Macacauba

(see Macawood)

Macawood



Macawood and trebol are common names applied to species in the genus *Platymiscium*. Other common names include cristobal and macacauba. This genus is distributed across continental

tropical America from southern Mexico to the Brazilian Amazon region and Trinidad.

The bright red to reddish or purplish brown heartwood is more or less striped. Darker specimens look waxy, and the sapwood is sharply demarcated from the heartwood. The texture is medium to fine, and the grain is straight to curly or striped. The wood is not very difficult to work, and it finishes smoothly and takes on a high polish. Generally, macawood air dries slowly with a slight tendency to warp and check. Strength is quite high, and density of air-dried wood ranges from 880 to 1,170 kg m⁻³ (55 to 73 lb ft⁻³). The heartwood is reported to be highly resistant to attack by decay fungi, insects, and dry-wood termites. Although the sapwood absorbs preservatives well, the heartwood is resistant to treatment.

Macawood is a fine furniture and cabinet wood. It is also used in decorative veneers, musical instruments, turnery, joinery, and specialty items such as violin bows and billiard cues.

Machinmango

(see Manbarklak)

Mahogany

The name mahogany is presently applied to several distinct kinds of commercial wood. The original mahogany wood, produced by *Swietenia mahagoni*, came from the American West Indies. This was the premier wood for fine furniture cabinet work and shipbuilding in Europe as early as the 1600s. Because the good reputation associated with the name mahogany is based on this wood, American mahogany is sometimes referred to as true mahogany. A related African wood, of the genus *Khaya*, has long been marketed as “African mahogany” and is used for much the same purposes as American mahogany because of its similar properties and overall appearance. A third kind of wood called mahogany, and the one most commonly encountered in the market, is “Philippine mahogany.” This name is applied to a group of Asian woods belonging to the genus *Shorea*. In this chapter, information on the “Philippine mahoganies” is given under lauan and meranti groups.

Mahogany, African

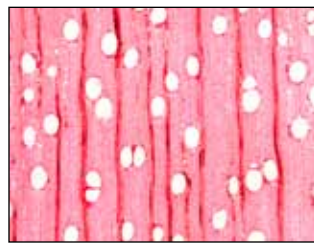

The bulk of “African mahogany” shipped from west-central Africa is *Khaya ivorensis*, the most widely distributed and plentiful species of the genus found in the coastal belt of the so-called high forest. The closely allied

species *K. anthotheca* has a more restricted range and is found farther inland in regions of lower rainfall but well within the area now being used for the export trade.

The heartwood varies from pale pink to dark reddish brown. The grain is frequently interlocked, and the texture is medium to coarse, comparable with that of American mahogany (*Swietenia macrophylla*). The wood is easy to dry, but machining properties are rather variable. Nailing and gluing properties are good, and an excellent finish is readily obtained. The wood is easy to slice and peel. In decay resistance, African mahogany is generally rated as moderately durable, which is below the durability rating for American mahogany.

Principal uses for African mahogany include furniture and cabinetwork, interior woodwork, boat construction, and veneer.

Mahogany, American

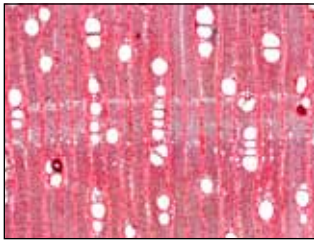

True, American, or Honduras mahogany (*Swietenia macrophylla*) ranges from southern Mexico through Central America into South America as far south as Bolivia. Plantations have been estab-

lished within its natural range and elsewhere throughout the tropics.

The heartwood varies from pale pink or salmon colored to dark reddish brown. The grain is generally straighter than that of African mahogany (*Khaya ivorensis*); however, a wide variety of grain patterns are obtained from American mahogany. The texture is rather fine to coarse. American mahogany is easily air or kiln dried without appreciable warp or checks, and it has excellent dimensional stability. It is rated as durable in resistance to decay fungi and moderately resistant to dry-wood termites. Both heartwood and sapwood are resistant to treatment with preservatives. The wood is very easy to work with hand and machine tools, and it slices and rotary cuts into fine veneer without difficulty. It also is easy to finish and takes an excellent polish. The air-dried strength of American mahogany is similar to that of American elm (*Ulmus americana*). Density of air-dried wood varies from 480 to 833 kg m⁻³ (30 to 52 lb ft⁻³).

The principal uses for mahogany are fine furniture and cabinets, interior woodwork, pattern woodwork, boat construction, fancy veneers, musical instruments, precision instruments, paneling, turnery, carving, and many other uses that call for an attractive and dimensionally stable wood.

Mahogany, Philippine

(see Meranti Groups)

Manbarklak

Manbarklak is a common name applied to species in the genus *Eschweilera*. Other names include kakaralli, machin-mango, and mata-mata. About 80 species of this genus are

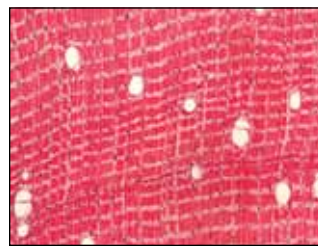

distributed from eastern Brazil through the Amazon basin, to the Guianas, Trinidad, and Costa Rica. The heartwood of most species is light, grayish, reddish brown, or brownish buff. The texture is fine and uniform, and the grain is typically straight. Manbarklak is a very hard and heavy wood (density of air-dried wood ranges from 768 to 1,185 kg m⁻³ (48 to 74 lb ft⁻³)) that is rated as fairly difficult to dry. Most species are difficult to work because of the high density and high silica content. Most species are highly resistant to attack by decay fungi. Also, most species have gained wide recognition for their high degree of resistance to marine borer attack. Resistance to dry-wood termite attack is variable depending on species.

Manbarklak is an ideal wood for marine and other heavy construction uses. It is also used for industrial flooring, mill equipment, railroad crossties, piles, and turnery.

Manni

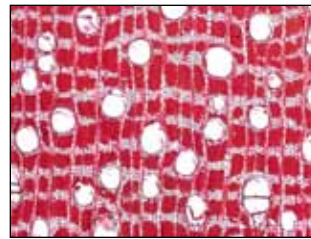

Manni (*Symphonia globulifera*) is native to the West Indies, Mexico, and Central, North, and South America. It also occurs in tropical West Africa. Other names include ossol (Gabon), anani (Brazil), waika (Africa), and chewstick

(Belize), a name acquired because of its use as a primitive toothbrush and flossing tool.

The heartwood is yellowish, grayish, or greenish brown and is distinct from the whitish sapwood. The texture is coarse and the grain straight to irregular. The wood is very easy to work with both hand and machine tools, but surfaces tend to roughen in planing and shaping. Manni air-dries rapidly with only moderate warp and checking. Its strength is similar to that of hickory (*Carya*), and the density of air-dried wood is 704 kg m⁻³ (44 lb ft⁻³). The heartwood is durable in ground contact but only moderately resistant to dry-wood and subterranean termites. The wood is rated as resistant to treatment with preservatives.

Manni is a general purpose wood that is used for railroad ties, general construction, cooperage, furniture components, flooring, and utility plywood.

Marishballi

Marishballi is the common name applied to species of the genus *Licania*. Other names include kauta and anaura. Species of *Licania* are widely distributed in tropical America

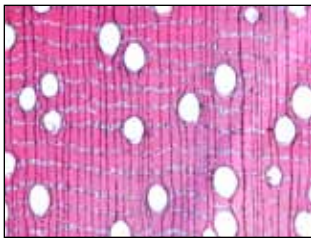

but most abundant in the Guianas and the lower Amazon region of Brazil.

The heartwood is generally yellowish to dark brown, sometimes with a reddish tinge. The texture is fine and close, and the

grain is usually straight. Marishballi is strong and very heavy; density of air-dried wood is 833 to 1,153 kg m⁻³ (52 to 72 lb ft⁻³). The wood is rated as easy to moderately difficult to air dry. Because of its high density and silica content, marishballi is difficult to work. The use of hardened cutters is suggested to obtain smooth surfaces. Durability varies with species, but marishballi is generally considered to have low to moderately low resistance to attack by decay fungi. However, it is known for its high resistance to attack by marine borers. Permeability also varies, but the heartwood is generally moderately responsive to treatment.

Marishballi is ideal for underwater marine construction, heavy construction above ground, and railroad cross ties (treated).

Mata-Mata

(see Manbarklak)

Mayflower

(see Roble)

Melapi

(see Meranti Groups)

Meranti Groups

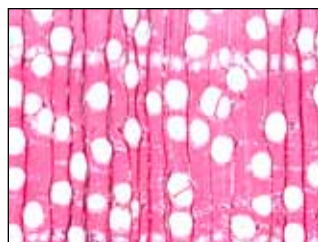

Meranti is a common name applied commercially to four groups of species of *Shorea* from southeast Asia, most commonly Malaysia, Indonesia, and the Philippines. There are thousands of

common names for the various species of *Shorea*, but the names Philippine mahogany and lauan are often substituted for meranti. The four groups of meranti are separated on the basis of heartwood color and weight (Table 2–2). About 70 species of *Shorea* belong to the light and dark red meranti groups, 22 species to the white meranti group, and 33 species to the yellow meranti group.

Meranti species as a whole have a coarser texture than that of mahogany (*Swietenia macrophylla*) and do not have dark-colored deposits in pores. The grain is usually interlocked. All merantis have axial resin ducts aligned in long, continuous, tangential lines as seen on the end surface of the wood. These ducts sometimes contain white deposits that are visible to the naked eye, but the wood is not

Table 2–2. Woods belonging to the genus *Shorea*

Name	Color	Density of air-dried wood
Dark red meranti (also called tanguile and dark red seraya)	Dark brown, medium to deep red, sometimes with a purplish tinge	640+ kg m ⁻³ (40+ lb ft ⁻³)
Light red meranti (also called red seraya)	Variable—almost white to pale pink, dark red, pale brown, or deep brown	400–640 kg m ⁻³ , averaging 512 kg m ⁻³ (25–40 lb ft ⁻³ , averaging 32 lb ft ⁻³)
White meranti (also called melapi)	Whitish when freshly cut, becoming light yellow–brown on exposure to air	480–870 kg m ⁻³ (30–54 lb ft ⁻³)
Yellow meranti (also called yellow seraya)	Light yellow or yellow–brown, sometimes with a greenish tinge; darkens on exposure to air	480–640 kg m ⁻³ (30–40 lb ft ⁻³)

resinous like some keruing (*Dipterocarpus*) species that resemble meranti. All the meranti groups are machined easily except white meranti, which dulls cutters as a result of high silica content in the wood. The light red and white merantis dry easily without degrade, but dark red and yellow merantis dry more slowly with a tendency to warp. The strength and shrinkage properties of the meranti groups compare favorably with that of northern red oak (*Quercus rubra*). The light red, white, and yellow merantis are not durable in exposed conditions or in ground contact, whereas dark red meranti is moderately durable. Generally, heartwood is extremely resistant to moderately resistant to preservative treatments.

Species of meranti constitute a large percentage of the total hardwood plywood imported into the United States. Other uses include joinery, furniture and cabinetwork, moulding and millwork, flooring, and general construction. Some dark red meranti is used for decking.

Merbau

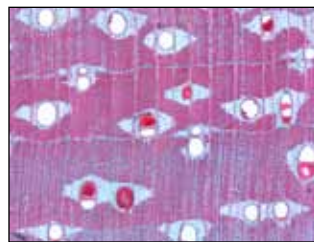

Merbau (Malaysia), ipil (Philippines), and kwila (New Guinea) are names applied to species of the genus *Intsia*, most commonly *I. bijuga*. *Intsia* is distributed throughout the Indo–Malaysian region, Indonesia,

Philippines, and many western Pacific islands, as well as Australia.

Freshly cut yellowish to orange–brown heartwood turns brown or dark red–brown on exposure to air. The texture is rather coarse, and the grain is straight to interlocked or

wavy. The strength of air-dried merbau is comparable with that of hickory (*Carya*), but density is somewhat lower (800 kg m^{-3} (50 lb ft^{-3}) at 12% moisture content). The wood dries well with little degrade but stains black in the presence of iron and moisture. Merbau is rather difficult to saw because it sticks to saw teeth and dulls cutting edges. However, the wood dresses smoothly in most operations and finishes well. Merbau has good durability and high resistance to termite attack. The heartwood resists treatment, but the sapwood can be treated with preservatives. Merbau is used in furniture, fine joinery, turnery, cabinets, flooring, musical instruments, and specialty items.

Mersawa

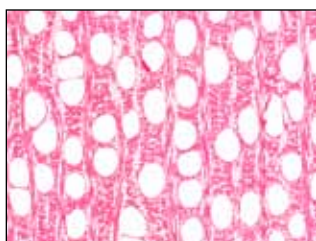

Mersawa is one of the common names applied to the genus *Anisoptera*, which has about 15 species distributed from the Philippine Islands and Malaysia to east Pakistan. Names applied to this wood vary

with the source, and three names are generally used in the lumber trade: krabak (Thailand), mersawa (Malaysia), and palosapis (Philippines).

Mersawa wood is light in color and has a moderately coarse texture. Freshly sawn heartwood is pale yellow or yellowish brown and darkens on exposure to air. Some wood may show a pinkish cast or pink streaks, but these eventually disappear on exposure to air. The wood weighs between 544 and 752 kg m^{-3} (34 and 47 lb ft^{-3}) at 12% moisture content and about 945 kg m^{-3} (59 lb ft^{-3}) when green. The sapwood is susceptible to attack by powderpost beetles, and the heartwood is not resistant to termites. The heartwood is rated as moderately resistant to fungal decay and should not be used under conditions that favor decay. The heartwood does not absorb preservative solutions readily. The wood machines easily, but because of the presence of silica, the wood severely dulls the cutting edges of ordinary tools and is very hard on saws.

The major volume of mersawa is used as plywood because conversion in this form presents considerably less difficulty than does the production of lumber.

Mora



Mora (*Mora excelsa* and *M. gonggrijpii*) is widely distributed in the Guianas and also occurs in the Orinoco Delta of Venezuela.

The yellowish red–brown, reddish brown, or dark red heartwood with pale

streaks is distinct from the yellowish to pale brown sapwood. The texture is moderately fine to rather coarse, and the grain is straight to interlocked. Mora is a strong and heavy wood (density of air-dried wood is 945 to $1,040 \text{ kg m}^{-3}$ (59 to 65 lb ft^{-3})); this wood is moderately difficult to work but yields smooth surfaces in sawing, planing, turning, and boring. The wood is generally rated as moderately difficult to dry. Mora is rated as durable to very durable in resistance to brown- and white-rot fungi. *M. gonggrijpii* is rated very resistant to dry-wood termites, but *M. excelsa* is considerably less resistant. The sapwood responds readily to preservative treatments, but the heartwood resists treatment.

Mora is used for industrial flooring, railroad cross ties, shipbuilding, and heavy construction.

Oak (Tropical)



The oaks (*Quercus*) are abundantly represented in Mexico and Central America with about 150 species, which are nearly equally divided between the red and white oak groups. More than 100 species

occur in Mexico and about 25 in Guatemala; the number diminishes southward to Colombia, which has two species. The usual Spanish name applied to the oaks is encino or roble, and both names are used interchangeably irrespective of species or use of the wood.

In heartwood color, texture, and grain characteristics, tropical oaks are similar to the diffuse porous oaks of the United States, especially live oak (*Quercus virginiana*). In most cases, tropical oaks are heavier (density of air-dried wood is 704 to 993 kg m^{-3} (44 to 62 lb ft^{-3})) than the U.S. species. Strength data are available for only four species, and the values fall between those of white oak (*Q. alba*) and live oak (*Q. virginiana*) or are equal to those of live oak. The heartwood is rated as very resistant to decay fungi and difficult to treat with preservatives.

Utilization of the tropical oaks is very limited at present because of difficulties encountered in the drying of the wood. The major volume is used in the form of charcoal, but the wood is used for flooring, railroad cross ties, mine timbers, tight cooperage, boat and ship construction, and decorative veneers.

Obeche

Obeche (*Triplochiton scleroxylon*) trees of west-central Africa reach a height of 50 m (150 ft) or more and a diameter of up to 2 m (5 ft). The trunk is usually free of branches for a considerable height so that clear lumber of considerable size can be obtained.

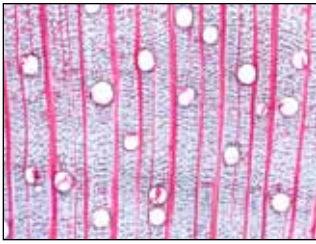

The wood is creamy white to pale yellow with little or no difference between sapwood and heartwood. The wood is fairly soft, of uniform medium to coarse texture, and the grain is usually interlocked but sometimes straight. Air-

dry wood weighs about 385 kg m^{-3} (24 lb ft^{-3}). Obeche dries readily with little degrade. It is not resistant to decay, and green sapwood is subject to blue stain. The wood is easy to work and machine, veneers and glues well, and takes nails and screws without splitting.

The characteristics of obeche make it especially suitable for veneer and corestock. Other uses include furniture, components, millwork, blockboard, boxes and crates, particleboard and fiberboard, patterns, and artificial limbs.

Ofram

(see Limba)

Okoume

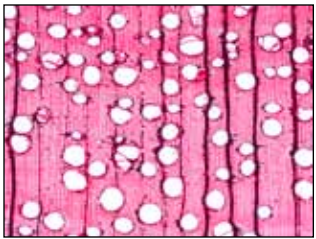

The natural distribution of okoume (*Aucoumea klaineana*) is rather restricted; the species is found only in west-central Africa and Guinea. However, okoume is extensively planted throughout its natural range.

The heartwood is salmon-pink in color, and the narrow sapwood is whitish or pale gray. The wood has a high luster and uniform texture. The texture is slightly coarser than that of birch (*Betula*). The nondurable heartwood dries readily with little degrade. Sawn lumber is somewhat difficult to machine because of the silica content, but the wood glues, nails, and peels into veneer easily. Okoume offers unusual flexibility in finishing because the color, which is of medium intensity, permits toning to either lighter or darker shades.

In the United States, okoume is generally used for decorative plywood paneling, general utility plywood, and doors. Other uses include furniture components, joinery, and light construction.

Opepe

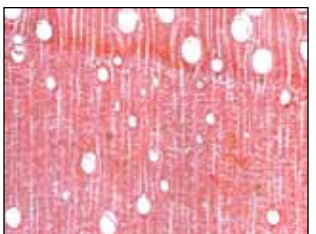

Opepe (*Nauclea diderichii*) is widely distributed in Africa from Sierra Leone to the Congo region and eastward to Uganda. It is often found in pure stands.

The orange or golden yellow heartwood darkens on exposure to air and is clearly defined from the whitish or pale yellow sapwood. The texture is rather coarse, and the grain is usually interlocked or irregular. The density of air-dried wood (752 kg m^{-3} (47 lb ft^{-3})) is about the same as that of true hickory (*Carya*), but strength properties are somewhat lower. Quartersawn stock dries rapidly with little checking or warp, but flat-sawn lumber may develop considerable degrade. The wood works moderately well with hand and machine tools. It also glues and finishes satisfactorily. The heartwood is rated as very resistant to decay and moderately resistant to termite attacks. The sapwood is permeable to preservatives, but the heartwood is moderately resistant to preservative treatment.

Opepe is a general construction wood that is used in dock and marine work, boat building, railroad cross-ties, flooring, and furniture.

Ossol

(see Manni)

Otie

(see Ilomba)

Ovangkol

(see Bengé)

Palosapis

(see Mersawa)

Para-Angelim

(see Sucupira)

Pau Marfim

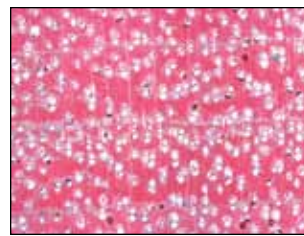

The range of pau marfim (*Balfourodendron riedelianum*) is rather limited, extending from the State of Sao Paulo, Brazil, into Paraguay and the provinces of Corrientes and Misiones of northern Argentina.

In Brazil, it is generally known as pau marfim and in Argentina and Paraguay, as guatambu.

In color and general appearance, pau marfim wood is very similar to birch (*Betula*) or sugar maple (*Acer saccharum*) sapwood. Although growth rings are present, they do not show as distinctly as those in birch and maple. There is no apparent difference in color between heartwood and sapwood. The wood is straight grained and easy to work and finish, but it is not considered resistant to decay. Average density of air-dried wood is about 802 kg m^{-3} (50 lb ft^{-3}).

In its areas of growth, pau marfim is used for much the same purposes as are sugar maple and birch in the United States. Introduced to the U.S. market in the late 1960s, pau marfim has been very well received and is especially esteemed for turnery.

Peroba, White

(see Peroba de Campos)

Peroba de Campos

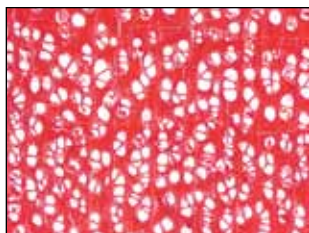

Peroba de campos (*Paratecoma peroba*), also referred to as white peroba, grows in the coastal forests of eastern Brazil, ranging from Bahia to Rio de Janeiro. It is the only species in the genus *Paratecoma*.

The heartwood varies in color but is generally shades of brown with tendencies toward olive and red. The sapwood is a yellowish gray and is clearly defined from the heartwood. The texture is relatively fine and approximates that of birch (*Betula*). The grain is commonly interlocked, with a narrow stripe or wavy figure. The wood machines easily; however, particular care must be taken in planing to prevent excessive grain tearing of quartered surfaces. There is some evidence that the fine dust from machining operations may produce allergic responses in certain individuals. Density of air-dried wood averages about 738 kg m^{-3} (46 lb ft^{-3}). Peroba de campos is heavier than teak (*Tectona grandis*) or white oak (*Quercus alba*), and it is proportionately stronger than either of these species. The heartwood of peroba de campos is rated as very durable with respect to decay and difficult to treat with preservatives.

In Brazil, peroba de campos is used in the manufacture of fine furniture, flooring, and decorative paneling. The principal use in the United States is shipbuilding, where peroba de campos serves as substitute for white oak (*Quercus alba*) for all purposes except bent members.

Peroba Rosa

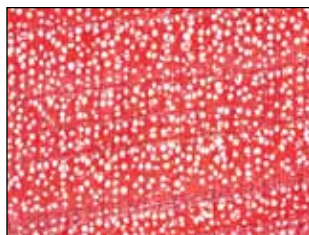

Peroba rosa is the common name applied to a number of similar species in the genus *Aspidosperma*. These species occur in southeastern Brazil and parts of Argentina.

The heartwood is a distinctive rose-red to yellowish, often variegated or streaked with purple or brown, and becomes brownish yellow to dark brown upon exposure to air; the heartwood is often not demarcated from the yellowish sapwood. The texture

is fine and uniform, and the grain is straight to irregular. The wood is moderately heavy; weight of air-dried wood is 752 kg m^{-3} (47 lb ft^{-3}). Strength properties are comparable with those of U.S. oak (*Quercus*). The wood dries with little checking or splitting. It works with moderate ease, and it glues and finishes satisfactorily. The heartwood is resistant to decay fungi but susceptible to dry-wood termite attack. Although the sapwood takes preservative treatment moderately well, the heartwood resists treatment.

Peroba is suited for general construction work and is favored for fine furniture and cabinetwork and decorative veneers. Other uses include flooring, interior woodwork, sashes and doors, and turnery.

Pilon

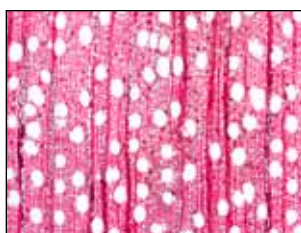

The two main species of pilon are *Hieronyma alchorneoides* and *H. laxiflora*, also referred to as suradan. These species range from southern Mexico to southern Brazil including the Guianas, Peru,

and Colombia. Pilon species are also found throughout the West Indies.

The heartwood is a light reddish brown to chocolate brown or sometimes dark red; the sapwood is pinkish white. The texture is moderately coarse and the grain interlocked. The wood air-dries rapidly with only a moderate amount of warp and checking. It has good working properties in all operations except planing, which is rated poor as a result of the characteristic interlocked grain. The strength of pilon is comparable with that of true hickory (*Carya*), and the density of air-dried wood ranges from 736 to 849 kg m^{-3} (46 to 53 lb ft^{-3}). Pilon is rated moderately to very durable in ground contact and resistant to moderately resistant to subterranean and dry-wood termites. Both heartwood and sapwood are reported to be treatable with preservatives by both open tank and pressure vacuum processes.

Pilon is especially suited for heavy construction, railway crossties, marinework, and flooring. It is also used for furniture, cabinetwork, decorative veneers, turnery, and joinery.

Piquia

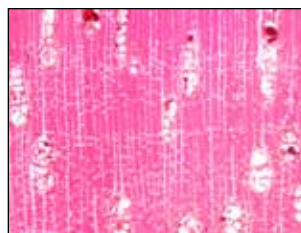

Piquia is the common name generally applied to species in the genus *Caryocar*. This genus is distributed from Costa Rica southward into northern Colombia and from the upland forest of the Amazon valley to eastern Brazil and the Guianas.

The yellowish to light grayish brown heartwood is hardly distinguishable from the sapwood. The texture is medium to rather coarse, and the grain is generally interlocked. The wood dries at a slow rate; warping and checking may develop, but only to a minor extent. Piquia is reported to be easy to moderately difficult to saw; cutting edges dull rapidly. The heartwood is very durable and resistant to decay fungi and dry-wood termites but only moderately resistant to marine borers.

Piquia is recommended for general and marine construction, heavy flooring, railway crossties, boat parts, and furniture components. It is especially suitable where hardness and high wear resistance are needed.

Primavera

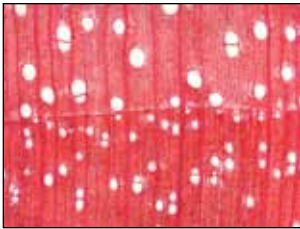

The natural distribution of primavera (*Tabebuia donnell-smithii*) is restricted to southwestern Mexico, the Pacific coast of Guatemala and El Salvador, and north-central Honduras.

Primavera is regarded as one of the primary light-colored woods, but its use has been limited because of its rather restricted range and relative scarcity of naturally grown trees. Recent plantations have increased the availability of this species and have provided a more constant source of supply. The quality of the plantation-grown wood is equal in all respects to the wood obtained from naturally grown trees.

The heartwood is whitish to straw-yellow, and in some logs it may be tinted with pale brown or pinkish streaks. The texture is medium to rather coarse, and the grain is straight to wavy, which produces a wide variety of figure patterns. The wood also has a very high luster. Shrinkage is rather low, and the wood shows a high degree of dimensional stability. Despite considerable grain variation, primavera machines remarkably well. The density of air-dried wood is 465 kg m⁻³ (29 lb ft⁻³), and the wood is comparable in strength with water tupelo (*Nyssa aquatica*). Resistance to both brown- and white-rot fungi varies. Weathering characteristics are good.

The dimensional stability, ease of working, and pleasing appearance make primavera a suitable choice for solid furniture, paneling, interior woodwork, and special exterior uses.

Purpleheart



Purpleheart, also referred to as amaranth, is the name applied to species in the genus *Peltogyne*. The center of distribution is in the north-central part of the Brazilian Amazon region, but the combined range of

all species is from Mexico through Central America and southward to southern Brazil.

Freshly cut heartwood is brown. It turns a deep purple upon exposure to air and eventually dark brown upon exposure to light. The texture is medium to fine, and the grain is usually straight. This strong and heavy wood (density of air-dried wood is 800 to 1,057 kg m⁻³ (50 to 66 lb ft⁻³)) is rated as easy to moderately difficult to air dry. It is moderately difficult to work with using either hand or machine tools, and it dulls cutters rather quickly. Gummy resin exudes when the wood is heated by dull tools. A slow feed rate and specially hardened cutters are suggested for optimal cutting. The wood turns easily, is easy to glue, and takes finishes well. The heartwood is rated as highly resistant to attack by decay fungi and very resistant to dry-wood termites. It is extremely resistant to treatment with preservatives.

The unusual and unique color of purpleheart makes this wood desirable for turnery, marquetry, cabinets, fine furniture, parquet flooring, and many specialty items, such as billiard cue butts and carvings. Other uses include heavy construction, shipbuilding, and chemical vats.

Pycnanthus

(see Ilomba)

Ramin

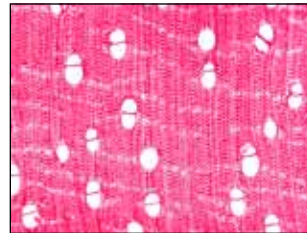

Ramin (*Gonystylus bancanus*) is native to southeast Asia from the Malaysian Peninsula to Sumatra and Borneo.

Both the heartwood and sapwood are the color of pale straw, yellow, or whitish. The grain is straight or shallowly interlocked. The texture is even, moderately fine, and similar to that of American mahogany (*Swietenia macrophylla*). The wood is without figure or luster. Ramin is moderately hard and heavy, weighing about 672 kg m⁻³ (42 lb ft⁻³) in the air-dried condition. The wood is easy to work, finishes well, and glues satisfactorily. Ramin is rated as not resistant to decay but permeable with respect to preservative treatment.

Ramin is used for plywood, interior woodwork, furniture, turnery, joinery, moulding, flooring, dowels, and handles of nonstriking tools (brooms), and as a general utility wood.

Roble

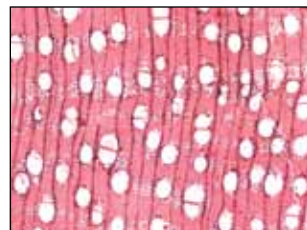

Roble, a species in the roble group of *Tabebuia* (generally *T. rosea*), ranges from southern Mexico through Central America to Venezuela and Ecuador. The name roble comes

from the Spanish word for oak (*Quercus*). In addition, *T. rosea* is called roble because the wood superficially resembles U.S. oak. Other names for *T. rosea* are mayflower and apamate.

The sapwood becomes a pale brown upon exposure to air. The heartwood varies from golden brown to dark brown, and it has no distinctive odor or taste. The texture is medium and the grain narrowly interlocked. The wood weighs about 642 kg m^{-3} (40 lb ft^{-3}) at 12% moisture content. Roble has excellent working properties in all machine operations. It finishes attractively in natural color and takes finishes with good results. It weighs less than the average of U.S. white oaks (*Quercus*) but is comparable with respect to bending and compression parallel to grain. The heartwood of roble is generally rated as moderately to very durable with respect to decay; the darker and heavier wood is regarded as more decay resistant than the lighter-colored woods.

Roble is used extensively for furniture, interior woodwork, doors, flooring, boat building, ax handles, and general construction. The wood veneers well and produces attractive paneling. For some applications, roble is suggested as a substitute for American white ash (*Fraxinus americana*) and oak (*Quercus*).

Rosewood, Brazilian

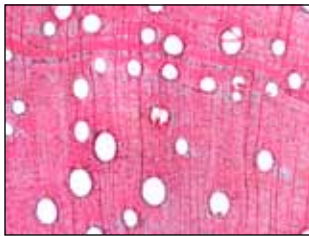

Brazilian rosewood (*Dalbergia nigra*), also referred to as jacaranda, occurs in eastern Brazilian forests from the State of Bahia to Rio de Janeiro. Because it was exploited for a long time, Brazilian rosewood is no longer abundant.

The heartwood varies with respect to color, through shades of brown, red, and violet, and it is irregularly and conspicuously streaked with black. It is sharply demarcated from the white sapwood. Many kinds of rosewood are distinguished locally on the basis of prevailing color. The texture is coarse, and the grain is generally straight. The heartwood has an oily or waxy appearance and feel, and its odor is fragrant and distinctive. The wood is hard and heavy (weight of air-dried wood is 752 to 897 kg m^{-3} (47 to 56 lb ft^{-3})); thoroughly air-dried wood will barely float in water. Strength properties of Brazilian rosewood are high and are more than adequate for the purposes for which this wood is used. For example, Brazilian rosewood is harder than any U.S. native hardwood species used for furniture and veneer. The wood machines and veneers well. It can be glued satisfactorily, provided the necessary precautions are taken to ensure good glue bonds, with respect to oily wood. Brazilian rosewood has an excellent reputation for

durability with respect to fungal and insect attack, including termites, although the wood is not used for purposes where durability is necessary.

Brazilian rosewood is used primarily in the form of veneer for decorative plywood. Limited quantities are used in the solid form for specialty items such as cutlery handles, brush backs, billiard cue butts, and fancy turnery.

Rosewood, Indian

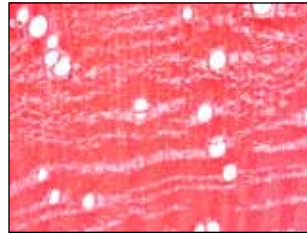

Indian rosewood (*Dalbergia latifolia*) is native to most provinces of India except in the northwest.

The heartwood varies in color from golden brown to dark purplish brown with denser blackish

streaks at the end of growth zones, giving rise to an attractive figure on flat-sawn surfaces. The narrow sapwood is yellowish. The average weight is about 849 kg m^{-3} (53 lb ft^{-3}) at 12% moisture content. The texture is uniform and moderately coarse. Indian rosewood is quite similar in appearance to Brazilian (*Dalbergia nigra*) and Honduran (*Dalbergia stevensonii*) rosewood. The wood is reported to kiln-dry well though slowly, and the color improves during drying. Indian rosewood is a heavy wood with high strength properties; after drying, it is particularly hard for its weight. The wood is moderately hard to work with hand tools and offers a fair resistance in machine operations. Lumber with calcareous deposits tends to dull tools rapidly. The wood turns well and has high screw-holding properties. If a very smooth surface is required for certain purposes, pores (vessels) may need to be filled.

Indian rosewood is essentially a decorative wood for high-quality furniture and cabinetwork. In the United States, it is used primarily in the form of veneer.

Sande

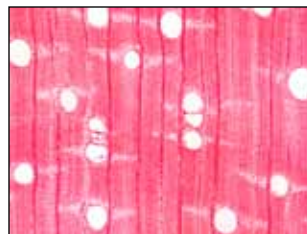

Practically all commercially available sande (mostly *Brosimum utile*) comes from Pacific Ecuador and Colombia. However, the group of species ranges from the Atlantic Coast in Costa Rica southward to Colombia and Ecuador.

The sapwood and heartwood show no distinction; the wood is uniformly yellowish white to yellowish or light brown. The texture is medium to moderately coarse and even, and the grain can be widely and narrowly interlocked. The density of air-dried wood ranges from 384 to 608 kg m^{-3} (24 to 38 lb ft^{-3}), and the strength is comparable with that of

U.S. oak (*Quercus*). The lumber air dries rapidly with little or no degrade. However, material containing tension wood is subject to warp, and the tension wood may cause fuzzy grain as well as overheating of saws as a result of pinching. The wood is not durable with respect to stain, decay, and insect attack, and care must be exercised to prevent degrade from these agents. The wood stains and finishes easily and presents no gluing problems.

Sande is used for plywood, particleboard, fiberboard, carpentry, light construction, furniture components, and moulding.

Santa Maria

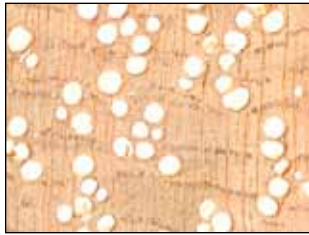

Santa Maria (*Calophyllum brasiliense*) ranges from the West Indies to southern Mexico and southward through Central America into northern South America.

The heartwood is pinkish to brick red or rich reddish brown and marked by fine and slightly darker striping on flat-sawn surfaces. The sapwood is lighter in color and generally distinct from the heartwood. The texture is medium and fairly uniform, and the grain is generally interlocked. The heartwood is rather similar in appearance to dark red meranti (*Shorea*). The wood is moderately easy to work, and good surfaces can be obtained when attention is paid to machining operations. The wood averages about 608 kg m^{-3} (38 lb ft^{-3}) at 12% moisture content. Santa Maria is in the density class of sugar maple (*Acer saccharum*), and its strength properties are generally similar; the hardness of sugar maple is superior to that of Santa Maria. The heartwood is generally rated as moderately durable to durable in contact with the ground, but it apparently has no resistance against termites and marine borers.

The inherent natural durability, color, and figure on the quarter-sawn face suggest that Santa Maria could be used as veneer for plywood in boat construction. Other uses are flooring, furniture, cabinetwork, millwork, and decorative plywood.

Sapele

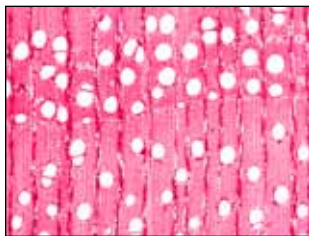

Sapele (*Entandrophragma cylindricum*) is a large African tree that occurs from Sierra Leone to Angola and eastward through the Congo to Uganda.

The heartwood ranges in color from that of American mahogany (*Swietenia macrophylla*) to a dark reddish or purplish brown. The lighter-colored and distinct sapwood

may be up to 10 cm (4 in.) wide. The texture is rather fine. The grain is interlocked and produces narrow and uniform striping on quarter-sawn surfaces. The wood averages about 674 kg m^{-3} (42 lb ft^{-3}) at 12% moisture content, and its mechanical properties are in general higher than those of white oak (*Quercus alba*). The wood works fairly easily with machine tools, although the interlocked grain makes it difficult to plane. Sapele finishes and glues well. The heartwood is rated as moderately durable and is resistant to preservative treatment.

As lumber, sapele is used for furniture and cabinetwork, joinery, and flooring. As veneer, it is used for decorative plywood.

Selangan Batu

(see Balau)

Sepetir

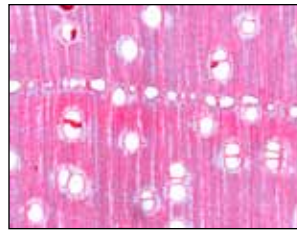

The name sepetir applies to species in the genus *Sindora* and to *Pseudosindora palustris*. These species are distributed throughout Malaysia, Indochina, and the Philippines.

The heartwood is brown with a pink or golden tinge that darkens on exposure to air. Dark brown or black streaks are sometimes present. The sapwood is light gray, brown, or straw-colored. The texture is moderately fine and even, and the grain is narrowly interlocked. The strength of sepetir is similar to that of shellbark hickory (*C. laciniosa*), and the density of the air-dried wood is also similar (640 to 720 kg m^{-3} (40 to 45 lb ft^{-3})). The wood dries well but rather slowly, with a tendency to end-split. The wood is difficult to work with hand tools and has a rather rapid dulling effect on cutters. Gums from the wood tend to accumulate on saw teeth, which causes additional problems. Sepetir is rated as nondurable in ground contact under Malaysian exposure. The heartwood is extremely resistant to preservative treatment; however, the sapwood is only moderately resistant.

Sepetir is a general carpentry wood that is also used for furniture and cabinetwork, joinery, flooring (especially truck flooring), plywood, and decorative veneers.

Seraya, Red and Dark Red

(see Meranti Groups)

Seraya, White

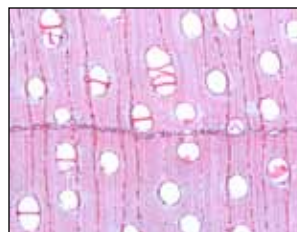

White seraya or bagtikan, as it is called in the Philippines, is a name applied to the 14 species of *Parashorea*, which grow in Sabah and the Philippines.

The heartwood is light brown or straw-colored, sometimes with a pinkish tint. The texture is moderately coarse and the grain interlocked. White seraya is very similar in appearance and strength properties to light red meranti, and sometimes the two are mixed in the market. White seraya dries easily with little degrade, and works fairly well with hand and machine tools. The heartwood is not durable to moderately durable in ground contact, and it is extremely resistant to preservative treatments.

White seraya is used for joinery, light construction, moulding and millwork, flooring, plywood, furniture, and cabinet work.

Seraya, Yellow

(see Meranti Groups)

Silverballi, Brown

(see Kaneelhart)

Spanish-Cedar

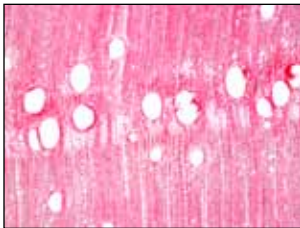

Spanish-cedar or cedro consists of a group of about seven species in the genus *Cedrela* that are widely distributed in tropical America from southern Mexico to northern Argentina.

The heartwood of spanish cedar varies from light to dark reddish brown, and the sapwood is pinkish to white. The texture is rather fine and uniform to coarse and uneven. The grain is not interlocked. The heartwood is characterized by a distinctive odor. The wood dries easily. Although Spanish-cedar is not high in strength, most other properties are similar to those of American mahogany (*Swietenia macrophylla*), except for hardness and compression perpendicular to the grain, where mahogany is definitely superior. Spanish-cedar is considered decay resistant; it works and glues well.

Spanish-cedar is used locally for all purposes that require an easily worked, light but straight grained, and durable wood. In the United States, the wood is favored for millwork, cabinets, fine furniture, boat building, cigar wrappers and boxes, humidores, and decorative and utility plywood.

Sucupira (Angelin, Para-Angelim)



Sucupira, angelin, and para-angelim apply to species in four genera of legumes from South America. Sucupira applies to *Bowdichia nitida* from northern Brazil, *B. virgilioides* from Venezuela, the Guianas, and Brazil, and

Diploptropis purpurea from the Guianas and southern Brazil. Angelin (*Andira inermis*) is a widespread species that occurs throughout the West Indies and from southern Mexico through Central America to northern South America and Brazil. Para-angelim (*Hymenolobium excelsum*) is generally restricted to Brazil.

The heartwood of sucupira is chocolate-brown, red-brown, or light brown (especially in *Diploptropis purpurea*). Angelin heartwood is yellowish brown to dark reddish brown; para-angelim heartwood turns pale brown upon exposure to air. The sapwood is generally yellowish to whitish and is sharply demarcated from the heartwood. The texture of all three woods is coarse and uneven, and the grain can be interlocked. The density of air-dried wood of these species ranges from 720 to 960 kg m⁻³ (45 to 60 lb ft⁻³), which makes them generally heavier than true hickory (*Carya*). Their strength properties are also higher than those of true hickory. The heartwood is rated very durable to durable in resistance to decay fungi but only moderately resistant to attack by dry-wood termites. Angelin is reported to be difficult to treat with preservatives, but para-angelim and sucupira treat adequately. Angelin can be sawn and worked fairly well, except that it is difficult to plane to a smooth surface because of alternating hard (fibers) and soft (parenchyma) tissue. Para-angelim works well in all operations. Sucupira is difficult to moderately difficult to work because of its high density, irregular grain, and coarse texture.

Sucupira, angelin, and para-angelim are ideal for heavy construction, railroad crossties, and other uses that do not require much fabrication. Other suggested uses include flooring, boat building, furniture, turnery, tool handles, and decorative veneer.

Suradan

(see Pilon)

Tangare

(see Andiroba)

Tanguile

(see Meranti Groups)

Teak

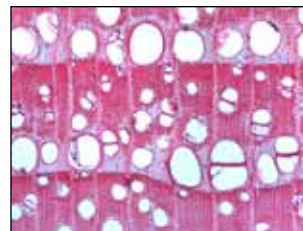

Teak (*Tectona grandis*) occurs in commercial quantities in India, Burma, Thailand, Laos, Cambodia, Vietnam, and the East Indies. Numerous plantations have been developed within its natural range and in tropical areas of Latin America and Africa, and many of these are now producing teakwood. The heartwood varies from yellow-brown to dark golden brown and eventually turns a rich brown upon exposure to air. Teakwood has a coarse,

uneven texture (ring porous), is usually straight grained, and has a distinctly oily feel. The heartwood has excellent dimensional stability and a very high degree of natural durability. Although teak is not generally used in the United States where strength is of prime importance, its properties are generally on par with those of U.S. oaks (*Quercus*). Teak is generally worked with moderate ease with hand and machine tools. However, the presence of silica often dulls tools. Finishing and gluing are satisfactory, although pretreatment may be necessary to ensure good bonding of finishes and glues.

Teak is one of the most valuable woods, but its use is limited by scarcity and high cost. Because teak does not cause rust or corrosion when in contact with metal, it is extremely useful in the shipbuilding industry, for tanks and vats, and for fixtures that require high acid resistance. Teak is currently used in the construction of boats, furniture, flooring, decorative objects, and decorative veneer.

Tornillo

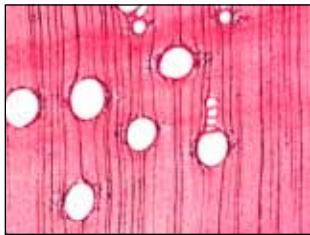

Tornillo (*Cedrelinga cateniformis*), also referred to as cedro-rana, grows in the Loreton Huanuco provinces of Peru and in the humid terra firma of the Brazilian Amazon region. Tornillo can grow up

to 52.5 m (160 ft) tall, with trunk diameters of 1.5 to 3 m (5 to 9 ft). Trees in Peru are often smaller in diameter, with merchantable heights of 15 m (45 ft) or more.

The heartwood is pale brown with a golden luster and prominently marked with red vessel lines; the heartwood gradually merges into the lighter-colored sapwood. The texture is coarse. The density of air-dried material collected in Brazil averages 640 kg m⁻³ (40 lb ft⁻³); for Peruvian stock, average density is about 480 kg m⁻³ (30 lb ft⁻³). The wood is comparable in strength with American elm (*Ulmus americana*). Tornillo cuts easily and can be finished smoothly, but areas of tension wood may result in woolly surfaces. The heartwood is fairly durable and reported to have good resistance to weathering.

Tornillo is a general construction wood that can be used for furniture components in lower-grade furniture.

Trebol

(see Macawood)

Virola

(see Banak)

Waika

(see Manni)

Walele

(see Ilomba)

Wallaba

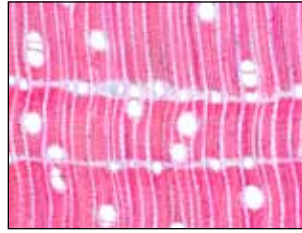

Wallaba is a common name applied to the species in the genus *Eperua*. Other names include wapa and apa. The center of distribution is in the Guianas, but the species extends into Venezuela and the Amazon

region of northern Brazil. Wallaba generally occurs in pure stands or as the dominant tree in the forest.

The heartwood ranges from light to dark red to reddish or purplish brown with characteristically dark, gummy streaks. The texture is rather coarse and the grain typically straight. Wallaba is a hard, heavy wood; density of air-dried wood is 928 kg m⁻³ (58 lb ft⁻³). Its strength is higher than that of shagbark hickory (*Carya ovata*). The wood dries very slowly with a marked tendency to check, split, and warp. Although the wood has high density, it is easy to work with hand and machine tools. However, the high gum content clogs sawteeth and cutters. Once the wood has been kiln dried, gum exudates are not a serious problem in machining. The heartwood is reported to be very durable and resistant to subterranean termites and fairly resistant to dry-wood termites.

Wallaba is well suited for heavy construction, railroad cross-ties, poles, industrial flooring, and tank staves. It is also highly favored for charcoal.

Wapa

(see Wallaba)

Yang

(see Keruing)

Imported Softwoods

Cypress, Mexican

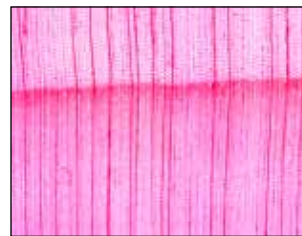

Native to Mexico and Guatemala, Mexican cypress (*Cupressus lusitanica*) is now widely planted at high elevations throughout the tropical world.

The heartwood is yellowish, pale brown, or pinkish, with occasional streaking or variegation. The texture is fine and uniform, and the grain is usually straight. The wood is fragrantly scented. The density of air-dried wood is 512 kg m⁻³ (32 lb ft⁻³), and the strength is comparable with that of yellow-cedar (*Chamaecyparis nootkatensis*) or western hemlock (*Tsuga heterophylla*). The wood is easy to work with hand and machine tools, and it nails, stains, and polishes well. Mexican cypress air dries very rapidly with little or no end- or surface-checking. Reports on durability

are conflicting. The heartwood is not treatable by the open tank process and seems to have an irregular response to pressure–vacuum systems.

Mexican cypress is used mainly for posts and poles, furniture components, and general construction.

Parana Pine



The wood commonly called parana pine (*Arcaucaria angustifolia*) is a softwood but not a true pine. It grows in southeastern Brazil and adjacent areas of Paraguay and Argentina.

Parana pine has many desirable characteristics. It is available in large-size clear boards with uniform texture. The small pinhead knots (leaf traces) that appear on flat-sawn surfaces and the light or reddish-brown heartwood provide a desirable figure for matching in paneling and interior woodwork. Growth rings are fairly distinct and similar to those of eastern white pine (*Pinus strobus*). The grain is not interlocked, and the wood takes paint well, glues easily, and is free from resin ducts, pitch pockets, and pitch streaks. Density of air-dried wood averages 545 kg m^{-3} (34 lb ft^{-3}). The strength of parana pine compares favorably with that of U.S. softwood species of similar density and, in some cases, approaches that of species with higher density. Parana pine is especially strong in shear strength, hardness, and nail-holding ability, but it is notably deficient in strength in compression across the grain. The tendency of the kiln-dried wood to split and warp is caused by the presence of compression wood, an abnormal type of wood with intrinsically large shrinkage along the grain. Boards containing compression wood should be excluded from exacting uses.

The principal uses of parana pine include framing lumber, interior woodwork, sashes and door stock, furniture case goods, and veneer.

Pine, Caribbean



Caribbean pine (*Pinus caribaea*) occurs along the Caribbean side of Central America from Belize to northeastern Nicaragua. It is also native to the Bahamas and Cuba. This low-elevation tree is widely

introduced as a plantation species throughout the world tropics.

The heartwood is golden- to red-brown and distinct from the sapwood, which is light yellow and roughly 2 to 5 cm (1 to 2 in.) wide. This softwood species has a strong

resinous odor and a greasy feel. The weight varies considerably and may range from 416 to 817 kg m^{-3} (26 to 51 lb ft^{-3}) at 12% moisture content. Caribbean pine may be appreciably heavier than slash pine (*P. elliottii*), but the mechanical properties of these two species are rather similar. The lumber can be kiln dried satisfactorily. Caribbean pine is easy to work in all machining operations, but its high resin content may cause resin to accumulate on the equipment. Durability and resistance to insect attack vary with resin content; in general, the heartwood is rated as moderately durable. The sapwood is highly permeable and is easily treated by open tank or pressure–vacuum systems. The heartwood is rated as moderately resistant to preservative treatment, depending on resin content.

Caribbean pine is used for the same purposes as are the southern pines (*Pinus* spp.).

Pine, Ocote

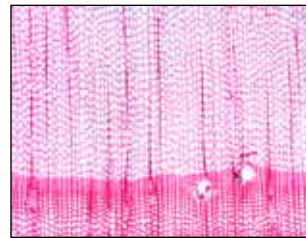

Ocote pine (*Pinus oocarpa*) is a high-elevation species that occurs from northwestern Mexico southward through Guatemala into Nicaragua. The largest and most extensive stands occur in Guatemala, Nicaragua, and Honduras.

The sapwood is a pale yellowish brown and generally up to 7 cm (3 in.) wide. The heartwood is a light reddish brown. The grain is not interlocked. The wood has a resinous odor, and it weighs about 656 kg m^{-3} (41 lb ft^{-3}) at 12% moisture content. The strength properties of ocote pine are comparable in most respects with those of longleaf pine (*P. palustris*). Decay resistance studies have shown ocote pine heartwood to be very durable with respect to white-rot fungal attack and moderately durable with respect to brown rot.

Ocote pine is comparable with the southern pines (*Pinus* spp.) in workability and machining characteristics. It is a general construction wood suited for the same uses as are the southern pines.

Pine, Radiata



Radiata pine (*Pinus radiata*), also known as Monterey pine, is rare in its native range on the coast of central California and Guadalupe Island, Mexico, but is planted extensively in the southern

hemisphere, mainly in Chile, New Zealand, Australia, and South Africa. Plantation-grown trees may reach a height of 26 to 30 m (80 to 90 ft) in 20 years.

The heartwood from plantation-grown trees is light brown to pinkish brown and is distinct from the paler cream-colored sapwood. Growth rings are primarily wide and distinct. False rings may be common. The texture is moderately even and fine, and the grain is not interlocked. Plantation-grown radiata pine averages about 480 kg m⁻³ (30 lb ft⁻³) at 12% moisture content. Its strength is comparable with that of red pine (*P. resinosa*), although location and growth rate may cause considerable variation in strength properties. The wood air- or kiln-dries rapidly with little degrade. The wood machines easily, although the grain tends to tear around large knots. Radiata pine nails and glues easily, and it takes paint and finishes well. The sapwood is prone to attack by stain fungi and vulnerable to boring insects. However, plantation-grown stock is mostly sapwood, which treats readily with preservatives. The heartwood is rated as durable above ground and is moderately resistant to preservative treatment.

Radiata pine can be used for the same purposes as other pines grown in the United States. These uses include veneer, plywood, pulp, fiberboard, construction, boxes, and millwork.

Scientific Name Index

U.S. Wood Species—Hardwoods

<i>Acer macrophyllum</i> Pursh	Maple, Bigleaf (Soft Maple Group)
<i>Acer negundo</i> L.	Boxelder (Soft Maple Group)
<i>Acer nigrum</i> Michx. f.	Maple, Black (Hard Maple Group)
<i>Acer rubrum</i> L.	Maple, Red (Soft Maple Group)
<i>Acer saccharinum</i> L.	Maple, Silver (Soft Maple Group)
<i>Acer saccharum</i> Marsh.	Maple, Sugar (Hard Maple Group)
<i>Aesculus glabra</i> Willd.	Buckeye, Ohio
<i>Aesculus octandra</i> Marsh.	Buckeye, Yellow
<i>Alnus rubra</i> Bong.	Alder, Red
<i>Betula alleghaniensis</i> Britton	Birch, Yellow
<i>Betula lenta</i> L.	Birch, Sweet
<i>Betula nigra</i> L.	Birch, River
<i>Betula papyrifera</i> Marsh.	Birch, Paper
<i>Betula populifolia</i> Marsh.	Birch, Gray
<i>Carya aquatica</i> (Michx. f.) Nutt.	Hickory, Water (Pecan Hickory Group)
<i>Carya cordiformis</i> (Wangenh.) K. Koch	Hickory, Bitternut (Pecan Hickory Group)
<i>Carya glabra</i> (Mill.) Sweet	Hickory, Pignut (True Hickory Group)
<i>Carya illinoensis</i> (Wangenh.) K. Koch	Hickory, Pecan (Pecan Hickory Group)
<i>Carya laciniosa</i> (Michx. f.) Loud.	Hickory, Shellbark (True Hickory Group)
<i>Carya myristiciformis</i> (Michx. f.) Nutt.	Hickory, Nutmeg (Pecan Hickory Group)
<i>Carya ovata</i> (Mill.) K. Koch	Hickory, Shagbark (True Hickory Group)
<i>Carya tomentosa</i> (Poir.) Nutt.	Hickory, Mockernut (True Hickory Group)
<i>Castanea dentata</i> (Marsh.) Borkh.	Chestnut, American
<i>Celtis laevigata</i> Willd.	Sugarberry (Hackberry Group)
<i>Celtis occidentalis</i> L.	Hackberry
<i>Fagus grandifolia</i> Ehrh.	Beech, American
<i>Fraxinus americana</i> L.	Ash, American White (White Ash Group)
<i>Fraxinus latifolia</i> Benth.	Ash, Oregon (White Ash Group)
<i>Fraxinus nigra</i> Marsh.	Ash, Black (Black Ash Group)
<i>Fraxinus pennsylvanica</i> Marsh.	Ash, Green (White Ash Group)
<i>Fraxinus profunda</i> (Bush) Bush	Ash, Pumpkin (Black Ash Group)
<i>Fraxinus quadrangulata</i> Michx.	Ash, Blue (White Ash Group)
<i>Gleditsia triacanthos</i> L.	Honeylocust
<i>Juglans cinerea</i> L.	Butternut
<i>Juglans nigra</i> L.	Walnut, Black
<i>Liquidambar styraciflua</i> L.	Sweetgum
<i>Liriodendron tulipifera</i> L.	Yellow-Poplar
<i>Lithocarpus densiflorus</i> (Hook. & Arn.) Rehd.	Tanoak
<i>Magnolia acuminata</i> L.	Cucumbertree (Magnolia Group)
<i>Magnolia grandiflora</i> L.	Magnolia, Southern
<i>Magnolia virginiana</i> L.	Sweetbay (Magnolia Group)
<i>Nyssa aquatica</i> L.	Tupelo, Water
<i>Nyssa ogeche</i> Bartr. ex Marsh.	Tupelo, Ogeechee
<i>Nyssa sylvatica</i> Marsh.	Tupelo, Black
<i>Nyssa sylvatica</i> var. <i>biflora</i> (Walt.) Sarg.	Tupelo, Swamp
<i>Platanus occidentalis</i> L.	Sycamore, American
<i>Populus balsamifera</i> L.	Balsam poplar (Cottonwood Group)
<i>Populus deltoides</i> Bartr. ex Marsh.	Cottonwood, Eastern
<i>Populus grandidentata</i> Michx.	Aspen, Bigtooth
<i>Populus heterophylla</i> L.	Cottonwood, Swamp
<i>Populus tremuloides</i> Michx.	Aspen, Quaking
<i>Populus trichocarpa</i> Torr. & Gray	Cottonwood, Black

<i>Prunus serotina</i> Ehrh.	Cherry, Black
<i>Quercus alba</i> L.	Oak, White (White Oak Group)
<i>Quercus bicolor</i> Willd.	Oak, Swamp White (White Oak Group)
<i>Quercus coccinea</i> Muenchh.	Oak, Scarlet (Red Oak Group)
<i>Quercus falcata</i> Michx.	Oak, Southern Red (Red Oak Group)
<i>Quercus falcata</i> var. <i>pagodaefolia</i> Ell.	Oak, Cherrybark (Red Oak Group)
<i>Quercus garryana</i> Dougl.	Oak, Oregon White (White Oak Group)
<i>Quercus kelloggii</i> Newb.	Oak, California Black (Red Oak Group)
<i>Quercus laurifolia</i> Michx.	Oak, Laurel (Red Oak Group)
<i>Quercus lyrata</i> Walt.	Oak, Overcup (White Oak Group)
<i>Quercus macrocarpa</i> Michx.	Oak, Bur (White Oak Group)
<i>Quercus michauxii</i> Nutt.	Oak, Swamp Chestnut (White Oak Group)
<i>Quercus muehlenbergii</i> Engelm.	Oak, Chinkapin (White Oak Group)
<i>Quercus nigra</i> L.	Oak, Water (Red Oak Group)
<i>Quercus nuttallii</i> Palmer	Oak, Nuttall (Red Oak Group)
<i>Quercus palustris</i> Muenchh.	Oak, Pin (Red Oak Group)
<i>Quercus phellos</i> L.	Oak, Willow (Red Oak Group)
<i>Quercus prinus</i> L.	Oak, Chestnut (White Oak Group)
<i>Quercus rubra</i> L.	Oak, Northern Red (Red Oak Group)
<i>Quercus shumardii</i> Buckl.	Oak, Shumard (Red Oak Group)
<i>Quercus stellata</i> Wangenh.	Oak, Post (White Oak Group)
<i>Quercus velutina</i> Lam.	Oak, Black (Red Oak Group)
<i>Quercus virginiana</i> Mill.	Oak, Live (Tropical Oak Group)
<i>Robinia pseudoacacia</i> L.	Locust, Black
<i>Salix nigra</i> Marsh.	Willow, Black
<i>Sassafras albidum</i> (Nutt.) Nees	Sassafras
<i>Tilia americana</i> L.	Basswood, American
<i>Tilia heterophylla</i> Vent.	Basswood, White
<i>Ulmus alata</i> Michx.	Elm, Winged
<i>Ulmus americana</i> L.	Elm, American
<i>Ulmus crassifolia</i> Nutt.	Elm, Cedar
<i>Ulmus rubra</i> Muhl.	Elm, Slippery
<i>Ulmus serotina</i> Sarg.	Elm, September
<i>Ulmus thomasii</i> Sarg.	Elm, Rock

U.S. Wood Species—Softwoods

<i>Abies amabilis</i> Dougl. ex Forbes	Fir, Pacific Silver (Fir, True; Western Species)
<i>Abies balsamea</i> (L.) Mill.	Fir, Balsam (Fir, True; Eastern Species)
<i>Abies concolor</i> (Gord. & Glend.) Lindl. ex Hildebr.	Fir, White (Fir, True; Western Species)
<i>Abies fraseri</i> (Pursh) Poir.	Fir, Fraser (Fir, True; Eastern Species)
<i>Abies grandis</i> (Dougl. ex D. Don) Lindl.	Fir, Grand (Fir, True; Western Species)
<i>Abies lasiocarpa</i> (Hook.) Nutt.	Fir, Subalpine (Fir, True; Western Species)
<i>Abies magnifica</i> A. Murr.	Fir, California Red (Fir, True; Western Species)
<i>Abies procera</i> Rehd.	Fir, Noble (Fir, True; Western Species)
<i>Calocedrus decurrens</i> (Torrey) Florin	Incense-Cedar
<i>Chamaecyparis lawsoniana</i> (A. Murr.) Parl.	Port-Orford-Cedar
<i>Chamaecyparis nootkatensis</i> (D. Don) Spach	Yellow-Cedar
<i>Chamaecyparis thyoides</i> (L.) B.S.P.	White-Cedar, Atlantic
<i>Juniperus silicicola</i> (Small) Bailey	Redcedar, Southern (Redcedar, Eastern Group)
<i>Juniperus virginiana</i> L.	Redcedar, Eastern
<i>Larix laricina</i> (Du Roi) K. Koch	Tamarack
<i>Larix occidentalis</i> Nutt.	Larch, Western
<i>Picea engelmannii</i> Parry ex Engelm.	Spruce, Engelmann
<i>Picea glauca</i> (Moench) Voss	Spruce, White (Spruce, Eastern Group)
<i>Picea mariana</i> (Mill.) B.S.P.	Spruce, Black (Spruce, Eastern Group)

Chapter 2 Characteristics and Availability of Commercially Important Woods

<i>Picea rubens</i> Sarg.	Spruce, Red (Spruce, Eastern Group)
<i>Picea sitchensis</i> (Bong.) Carr.	Spruce, Sitka
<i>Pinus banksiana</i> Lamb.	Pine, Jack
<i>Pinus contorta</i> Dougl. ex Loud.	Pine, Lodgepole
<i>Pinus echinata</i> Mill.	Pine, Shortleaf (Pine, Southern Group)
<i>Pinus elliotii</i> Engelm.	Pine, Slash (Pine, Southern Group)
<i>Pinus glabra</i> Walt.	Pine, Spruce
<i>Pinus jeffreyi</i> Grev. & Balf.	Pine, Jeffrey (see Pine, Ponderosa)
<i>Pinus lambertiana</i> Dougl.	Pine, Sugar
<i>Pinus monticola</i> Dougl. ex D. Don	Pine, Western White
<i>Pinus palustris</i> Mill.	Pine, Longleaf (Pine, Southern Group)
<i>Pinus ponderosa</i> Dougl. ex Laws.	Pine, Ponderosa
<i>Pinus resinosa</i> Ait.	Pine, Red
<i>Pinus rigida</i> Mill.	Pine, Pitch
<i>Pinus serotina</i> Michx.	Pine, Pond
<i>Pinus strobus</i> L.	Pine, Eastern White
<i>Pinus taeda</i> L.	Pine, Loblolly (Pine, Southern Group)
<i>Pinus virginiana</i> Mill.	Pine, Virginia
<i>Pseudotsuga menziesii</i> (Mirb.) Franco	Douglas-Fir
<i>Sequoia sempervirens</i> (D. Don) Endl.	Redwood
<i>Sequoiadendron giganteum</i> (Lindl.) Buchholz	Sequoia, Giant
<i>Taxodium distichum</i> (L.) Rich.	Baldcypress
<i>Thuja occidentalis</i> L.	White-Cedar, Northern
<i>Thuja plicata</i> Donn ex D. Don	Redcedar, Western
<i>Tsuga canadensis</i> (L.) Carr.	Hemlock, Eastern
<i>Tsuga heterophylla</i> (Raf.) Sarg.	Hemlock, Western
<i>Tsuga mertensiana</i> (Bong.) Carr.	Hemlock, Mountain

Imported Woods—Hardwoods

<i>Andira inermis</i> (W. Wright) H.B.K.	Angelin (see Sucupira)
<i>Anisoptera</i> spp.	Mersawa
<i>Aspidosperma</i> spp.	Peroba Rosa
<i>Astronium</i> spp.	Gonçalo Alves
<i>Aucoumea klaineana</i> Pierre	Okoume
<i>Balfourodendron riedelianum</i> (Engl.) Engl.	Pau Marfim
<i>Bowdichia</i> spp.	Sucupira
<i>Brosimum utile</i> (H.B.K.) Pittier	Sande
<i>Calophyllum brasiliense</i> Cambess.	Santa Maria
<i>Calycohyllum candidissimum</i> (Vahl) DC.	Degame
<i>Carapa</i> spp.	Andiroba
<i>Cariniana</i> spp.	Albarco
<i>Caryocar</i> spp.	Piquia
<i>Cedrela</i> spp.	Spanish-Cedar
<i>Cedrelinga cateniformis</i> (Ducke) Ducke	Tornillo
<i>Ceiba pentandra</i> (L.) Gaertn.	Ceiba
<i>Ceiba samauma</i> K. Schum.	Lupuna (see Ceiba)
<i>Chlorocardium rodiei</i> (Schomb.) Rohwer, Richter & van der Werff	Greenheart
<i>Dalbergia latifolia</i> Roxb. ex DC.	Rosewood, Indian
<i>Dalbergia nigra</i> (Vell.) Allem. ex Benth.	Rosewood, Brazilian
<i>Dalbergia stevensonii</i> Standl.	Rosewood, Honduran
<i>Dialyanthera</i> spp.	Cuangare (see Banak)
<i>Dicorynia guianensis</i> Amsch.	Angelique
<i>Diplotropis purpurea</i> (Rich.) Amshoff	Sucupira
<i>Dipterocarpus</i> spp.	Keruing

<i>Dryobalanops</i> spp.	Kapur
<i>Dyera costulata</i> (Miq.) Hook. f.	Jelutong
<i>Entandrophragma cylindricum</i> (Sprague) Sprague	Sapele
<i>Eperua</i> spp.	Wallaba
<i>Eschweilera</i> spp.	Manbarklak
<i>Eucalyptus diversicolor</i> F. Muell.	Karri
<i>Eucalyptus marginata</i> Donn ex Smith	Jarrah
<i>Gonystylus bancanus</i> (Miq.) Baill.	Ramin
<i>Guaiacum</i> spp.	Lignumvitae
<i>Guibourtia</i> spp.	Benge, Ehie, Bubinga
<i>Hieronyma</i> spp.	Pilon
<i>Hura crepitans</i> L.	Hura
<i>Hymenaea</i> spp.	Courbaril, Jatoba
<i>Hymenolobium excelsum</i> Ducke	Para-Angelim (see Sucupira)
<i>Intsia</i> spp.	Merbau
<i>Khaya</i> spp.	Mahogany, African
<i>Koompassia malaccensis</i> Maing. ex Benth.	Kempas
<i>Licania</i> spp.	Marishballi
<i>Licaria</i> spp.	Kaneelhart
<i>Lophira alata</i> Banks ex Gaertn. f.	Azobe
<i>Manilkara bidentata</i> (A. DC.) A. Chev.	Balata
<i>Milicia</i> spp.	Iroko
<i>Mora</i> spp.	Mora
<i>Nauclea diderichii</i> (De Wild.) Merrill	Opepe
<i>Ochroma pyramidale</i> (Cav. ex Lam.) Urban	Balsa
<i>Ocotea rubra</i> Mez	Determa
<i>Parashorea</i> spp.	Seraya, White
<i>Paratecoma peroba</i> (Record & Mell) Kuhlm.	Peroba de Campos
<i>Peltogyne</i> spp.	Purpleheart
<i>Pericopsis elata</i> (Harms) v. Meeuwen	Afromosia
<i>Platymiscium</i> spp.	Macawood
<i>Prioria copaifera</i> Griseb.	Cativo
<i>Pseudosindora palustris</i> Sym.	Sepetir
<i>Pycnanthus angolensis</i> (Welw.) Warb.	Ilomba
<i>Quercus</i> spp.	Oak (Tropical)
<i>Shorea</i> spp.	Balau
<i>Shorea</i> spp.	Meranti
<i>Sindora</i> spp.	Sepetir
<i>Swietenia macrophylla</i> King	Mahogany, American
<i>Symphonia globulifera</i> L. f.	Manni
<i>Tabebuia donnell-smithii</i> Rose	Primavera
<i>Tabebuia rosea</i> (Bertol.) DC.	Roble
<i>Tabebuia</i> spp.	Ipe
<i>Tectona grandis</i> L. f.	Teak
<i>Terminalia superba</i> Engl. & Diels	Limba
<i>Tetraberlinia tubmaniana</i> J. Leonard	Ekop
<i>Triplochiton scleroxylon</i> K. Schum.	Obeche
<i>Turraeanthus africanus</i> (Welw. ex DC.) Pellegr.	Avodire
<i>Virola</i> spp.	Banak

Imported Woods—Softwoods

<i>Araucaria angustifolia</i> (Bertol.) Kuntze	Parana Pine
<i>Cupressus lusitanica</i> Mill.	Cypress, Mexican
<i>Pinus caribaea</i> Morelet	Pine, Caribbean
<i>Pinus oocarpa</i> Schiede	Pine, Ocote
<i>Pinus radiata</i> D. Don	Pine, Radiata

Literature Cited

Haynes, R.W. tech. coord. 2003. An analysis of the timber situation in the United States: 1952 to 2050. Gen. Tech. Rep. PNW–GTR–560. Portland, OR: U.S. Department of Agriculture, Forest Service, Pacific Northwest Research Station. 253 p.

Haynes, R.W.; Adams, D.M.; Alig, R.J.; Ince, P.J.; Mills, J.R.; Zhou, X. 2007. The 2005 RPA timber assessment update. Gen. Tech. Rep. PNW–GTR–699. Portland, OR: U.S. Department of Agriculture, Forest Service, Pacific Northwest Research Station. 212 p.

Howard, J.L. 2007. U.S. timber production, trade, consumption, and price statistics, 1965–2005. Res. Pap. FPL–RP–637. Madison, WI: U.S. Department of Agriculture, Forest Service, Forest Products Laboratory. 91 p.

Additional References

Alden, H.A. 1995. Hardwoods of North America. Gen. Tech. Rep. FPL–GTR–83. Madison, WI: U.S. Department of Agriculture, Forest Service, Forest Products Laboratory. 136 p.

Alden, H.A. 1997. Softwoods of North America. Gen. Tech. Rep. FPL–GTR–102. Madison, WI: U.S. Department of Agriculture, Forest Service, Forest Products Laboratory. 151 p.

Berni, C.A.; Bolza, E.; Christensen, F.J. 1979. South American timbers—characteristics, properties, and uses of 190 species. Melbourne, Australia: Commonwealth Scientific and Industrial Research Organization, Division of Building Research. 229 p.

Bolza, E.; Keating, W.G. 1972. African timbers—the properties, uses, and characteristics of 700 species. Melbourne, Australia: Commonwealth Scientific and Industrial Research Organization, Division of Building Research.

Chudnoff, M. 1984. Tropical timbers of the world. Agric. Handb. 607. Madison, WI: U.S. Department of Agriculture, Forest Service, Forest Products Laboratory. 464 p.

Farmer, R.H. 1972. Handbook of hardwoods. 2nd ed. Building Research Establishment, Princes Risborough Laboratory; London: Her Majesty's Stationery Office. 243 p.

Hardwood Market Report [Current edition]. Memphis, TN: Lumber News Letter.

Henderson, F.Y. 1977. A handbook of softwoods. Building Research Establishment, Princes Risborough Laboratory; London: Her Majesty's Stationery Office. 63 p.

Keating, W.G.; Bolza, E. 1982. Characteristics, properties, and uses of timbers: Vol. 1. Southeast Asia, Northern Australia, and the Pacific. Melbourne, Australia: Inkata Press. 362 p.

Kukachka, B.F. 1970. Properties of imported tropical woods. Res. Pap. FPL 125. Madison, WI: U.S. Department of Agriculture, Forest Service, Forest Products Laboratory. 67 p.

Markwardt, L.J. 1930. Comparative strength properties of woods grown in the United States. Technical Bulletin 158. Madison, WI: U.S. Department of Agriculture, Forest Service, Forest Products Laboratory. 39 p.

Markwardt, L.J.; Wilson, T.R.C. 1935. Strength and related properties of woods grown in the United States. Tech. Bull. 479. Washington, DC: U.S. Department of Agriculture. 99 p.

Panshin, A.J.; deZeeuw, C. 1980. Textbook of wood technology. 4th ed. New York: McGraw-Hill. 722 p.

Record, S.J.; Hess, R.W. 1949. Timbers of the new world. New Haven, CT: Yale University Press. 640 p.

Ulrich, A.H. 1981. U.S. timber production, trade, consumption, and price statistics, 1950–1980. Misc. Pub. 1408. Washington, DC: U.S. Department of Agriculture.

Structure and Function of Wood

Alex Wiedenhoef, Botanist

Contents

Biological Structure of Wood at Decreasing Scales 3–2

The Tree 3–2

Softwoods and Hardwoods 3–2

Sapwood and Heartwood 3–2

Axial and Radial Systems 3–3

Planes of Section 3–3

Vascular Cambium 3–4

Growth Rings 3–4

Cells in Wood 3–6

Cell Walls 3–7

Pits 3–8

Microscopic Structure of Softwoods and Hardwoods 3–9

Softwoods 3–9

Hardwoods 3–10

Wood Technology 3–12

Moisture Relations 3–12

Density 3–12

Juvenile Wood and Reaction Wood 3–13

Appearance of Wood as Sawn Lumber 3–13

Color and Luster 3–13

Grain and Texture 3–13

Plainsawn and Quartersawn 3–14

Slope of Grain: Straight, Diagonal, Spiral, and Interlocked Grain 3–14

Knots 3–15

Decorative Features 3–15

Wood Identification 3–16

Literature Cited 3–16

Wood is a complex biological structure, a composite of many chemistries and cell types acting together to serve the needs of a living plant. Attempting to understand wood in the context of wood technology, we have often overlooked the key and basic fact that wood evolved over the course of millions of years to serve three main functions in plants—conduction of water from the roots to the leaves, mechanical support of the plant body, and storage of biochemicals. There is no property of wood—physical, mechanical, chemical, biological, or technological—that is not fundamentally derived from the fact that wood is formed to meet the needs of the living tree. To accomplish any of these functions, wood must have cells that are designed and interconnected in ways sufficient to perform these functions. These three functions have influenced the evolution of approximately 20,000 different species of woody plants, each with unique properties, uses, and capabilities, in both plant and human contexts. Understanding the basic requirements dictated by these three functions and identifying the structures in wood that perform them allow insight to the realm of wood as an engineering material (Hoadley 2000). A scientist who understands the interrelationships between form and function can predict the utility of a specific wood in a new context. The objective of this chapter is to review the basic biological structure of wood and provide a basis for interpreting its properties in an engineering context. By understanding the function of wood in the living tree, we can better understand the strengths and limitations it presents as a material.

The component parts of wood must be defined and delimited at a variety of scales. The wood anatomical expertise necessary for a researcher who is using a solid wood beam is different from that necessary for an engineer designing a glued-laminated beam, which in turn is different from that required for making a wood–resin composite with wood flour. Differences in the kinds of knowledge required in these three cases are related to the scale at which one intends to interact with wood, and in all three cases the properties of these materials are derived from the biological needs of the living tree. For this reason, this chapter explains the structure of wood at decreasing scales and in ways that demonstrate the biological rationale for a plant to produce wood with such features. This background will permit the reader to understand the biological bases for the properties presented in subsequent chapters.

Although shrubs and many vines form wood, the remainder of this chapter will focus on wood from trees, which are the

predominant source of wood for commercial and engineering applications and provide examples of virtually all features that merit discussion.

Biological Structure of Wood at Decreasing Scales

The Tree

A living, growing tree has two main domains, the shoot and the roots. Roots are the subterranean structures responsible for water and mineral nutrient uptake, mechanical anchoring of the shoot, and storage of biochemicals. The shoot is made up of the trunk or bole, branches, and leaves (Raven and others 1999). The remainder of the chapter will be concerned with the trunk of the tree.

If one cuts down a tree and looks at the stump, several gross observations can be made. The trunk is composed of various materials present in concentric bands. From the outside of the tree to the inside are outer bark, inner bark, vascular cambium, sapwood, heartwood, and the pith (Fig. 3–1). Outer bark provides mechanical protection to the softer inner bark and also helps to limit evaporative water loss. Inner bark is the tissue through which sugars (food) produced by photosynthesis are translocated from the leaves to the roots or growing portions of the tree. The vascular cambium is the layer between the bark and the wood that produces both these tissues each year. The sapwood is the active, “living” wood that conducts the water (or sap) from the roots to the leaves. It has not yet accumulated the often-colored chemicals that set apart the non-conductive heartwood found as a core of darker-colored wood in the middle of most trees. The pith at the very center of the trunk is the remnant of the early growth of the trunk, before wood was formed.

Softwoods and Hardwoods

Despite what one might think based on the names, not all softwoods have soft, lightweight wood, nor do all hardwoods have hard, heavy wood. To define them botanically, softwoods are those woods that come from gymnosperms (mostly conifers), and hardwoods are woods that come from angiosperms (flowering plants). In the temperate portion of the northern hemisphere, softwoods are generally needle-leaved evergreen trees such as pine (*Pinus*) and spruce (*Picea*), whereas hardwoods are typically broadleaf, deciduous trees such as maple (*Acer*), birch (*Betula*), and oak (*Quercus*). Softwoods and hardwoods not only differ in terms of the types of trees from which they are derived, but they also differ in terms of their component cells. Softwoods have a simpler basic structure than do hardwoods because they have only two cell types and relatively little variation in structure within these cell types. Hardwoods have greater structural complexity because they have both a greater number of basic cell types and a far greater degree of variability within the cell types. The single most important distinction between the two general kinds of wood is that hardwoods

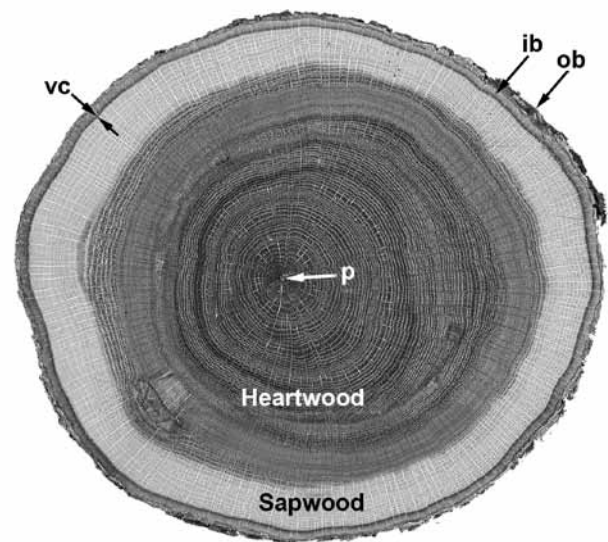

Figure 3–1. Macroscopic view of a transverse section of a *Quercus alba* trunk. Beginning at the outside of the tree is the outer bark (ob). Next is the inner bark (ib) and then the vascular cambium (vc), which is too narrow to see at this magnification. Interior toward the vascular cambium is the sapwood, which is easily differentiated from the heartwood that lies toward the interior. At the center of the trunk is the pith (p), which is barely discernible in the center of the heartwood.

have a characteristic type of cell called a vessel element (or pore) whereas softwoods lack these (Fig. 3–2). An important cellular similarity between softwoods and hardwoods is that in both kinds of wood, most of the cells are dead at maturity, even in the sapwood. The cells that are alive at maturity are known as parenchyma cells and can be found in both softwoods and hardwoods.

Sapwood and Heartwood

In both softwoods and hardwoods, the wood in the trunk of the tree is typically divided into two zones, each of which serves an important function distinct from the other. The actively conducting portion of the stem in which parenchyma cells are still alive and metabolically active is referred to as sapwood. A looser, more broadly applied definition is that sapwood is the band of lighter colored wood adjacent to the bark. Heartwood is the darker colored wood found to the interior of the sapwood (Fig. 3–1).

In the living tree, sapwood is responsible not only for conduction of sap but also for storage and synthesis of biochemicals. An important storage function is the long-term storage of photosynthate. Carbon that must be expended to form a new flush of leaves or needles must be stored somewhere in the tree, and parenchyma cells of the sapwood are often where this material is stored. The primary storage forms of photosynthate are starch and lipids. Starch grains are stored in the parenchyma cells and can be easily seen with a microscope. The starch content of sapwood can have important ramifications in the wood industry. For example, in the tropical tree ceiba (*Ceiba pentandra*), an abundance

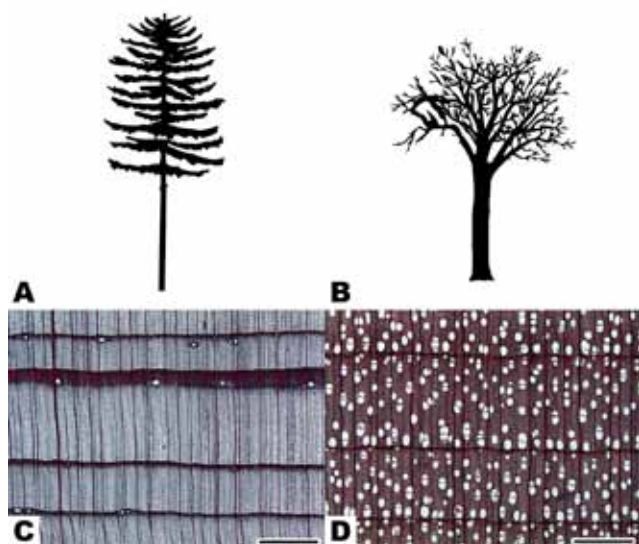

Figure 3–2. A, the general form of a generic softwood tree. B, the general form of a generic hardwood tree. C, transverse section of *Pseudotsuga mensiezii*, a typical softwood; the thirteen round white spaces are resin canals. D, transverse section of *Betula allegheniensis*, a typical hardwood; the many large, round white structures are vessels or pores, the characteristic feature of a hardwood. Scale bars = 780 μm .

of starch can lead to growth of anaerobic bacteria that produce ill-smelling compounds that can make the wood commercially unusable (Chudnoff 1984). In southern yellow pines of the United States, a high starch content encourages growth of sap-stain fungi that, though they do not affect the strength of the wood, can nonetheless decrease the lumber value for aesthetic reasons (Simpson 1991).

Living cells of the sapwood are also the agents of heartwood formation. Biochemicals must be actively synthesized and translocated by living cells. For this reason, living cells at the border between heartwood and sapwood are responsible for the formation and deposition of heartwood chemicals, one important step leading to heartwood formation (Hillis 1996). Heartwood functions in long-term storage of biochemicals of many varieties depending on the species in question. These chemicals are known collectively as extractives. In the past, heartwood was thought to be a disposal site for harmful byproducts of cellular metabolism, the so-called secondary metabolites. This led to the concept of the heartwood as a dumping ground for chemicals that, to a greater or lesser degree, would harm living cells if not sequestered in a safe place. We now know that extractives are a normal part of the plant's system of protecting its wood. Extractives are formed by parenchyma cells at the heartwood–sapwood boundary and are then exuded through pits into adjacent cells (Hillis 1996). In this way, dead cells can become occluded or infiltrated with extractives despite the fact that these cells lack the ability to synthesize or accumulate these compounds on their own.

Extractives are responsible for imparting several larger-scale characteristics to wood. For example, extractives provide natural durability to timbers that have a resistance to decay fungi. In the case of a wood like teak (*Tectona grandis*), known for its stability and water resistance, these properties are conferred in large part by the waxes and oils formed and deposited in the heartwood. Many woods valued for their colors, such as mahogany (*Swietenia mahagoni*), African blackwood (*Diospyros melanoxylon*), Brazilian rosewood (*Dalbergia nigra*), and others, owe their value to the type and quantity of extractives in the heartwood. For these species, the sapwood has little or no value, because the desirable properties are imparted by heartwood extractives. Gharu wood, or eagle wood (*Aquilaria malaccensis*), has been driven to endangered status due to human harvest of the wood to extract valuable resins used in perfume making (Lagenheim 2003). Sandalwood (*Santalum spicatum*), a wood famed for its use in incenses and perfumes, is valuable only if the heartwood is rich with the desired scented extractives. The utility of a wood for a technological application can be directly affected by extractives. For example, if a wood like western redcedar, high in hydrophilic extractives, is finished with a water-based paint without a stain blocker, extractives may bleed through the paint, ruining the product (Chap. 16).

Axial and Radial Systems

The distinction between sapwood and heartwood, though important, is a gross feature that is often fairly easily observed. More detailed inquiry into the structure of wood shows that wood is composed of discrete cells connected and interconnected in an intricate and predictable fashion to form an integrated system that is continuous from root to twig. The cells of wood are typically many times longer than wide and are specifically oriented in two separate systems of cells: the axial system and the radial system. Cells of the axial system have their long axes running parallel to the long axis of the organ (up and down the trunk). Cells of the radial system are elongated perpendicularly to the long axis of the organ and are oriented like radii in a circle or spokes in a bicycle wheel, from the pith to the bark. In the trunk of a tree, the axial system runs up and down, functions in long-distance water movement, and provides the bulk of the mechanical strength of the tree. The radial system runs in a pith to bark direction, provides lateral transport for biochemicals, and in many cases performs a large fraction of the storage function in wood. These two systems are interpenetrating and interconnected, and their presence is a defining characteristic of wood as a tissue.

Planes of Section

Although wood can be cut in any direction for examination, the organization and interrelationship between the axial and radial systems give rise to three main perspectives from which they can be viewed to glean the most information. These three perspectives are the transverse plane of section (the cross section), the radial plane of section, and the

tangential plane of section. Radial and tangential sections are referred to as longitudinal sections because they extend parallel to the axial system (along the grain).

The transverse plane of section is the face that is exposed when a tree is cut down. Looking down at the stump one sees the transverse section (as in Fig. 3–3H); cutting a board across the grain exposes the transverse section. The transverse plane of section provides information about features that vary both in the pith to bark direction (called the radial direction) and also those that vary in the circumferential direction (called the tangential direction). It does not provide information about variations up and down the trunk.

The radial plane of section runs in a pith-to-bark direction (Fig. 3–3A, top), and it is parallel to the axial system, so it provides information about longitudinal changes in the stem and from pith to bark along the radial system. To describe it geometrically, it is parallel to the radius of a cylinder, and extending up and down the length of the cylinder. In a practical sense, it is the face or plane that is exposed when a log is split exactly from pith to bark. It does not provide any information about features that vary in a tangential direction.

The tangential plane is at a right angle to the radial plane (Fig. 3–3A, top). Geometrically, it is parallel to any tangent line that would touch the cylinder, and it extends along the length of the cylinder. One way in which the tangential plane would be exposed is if the bark were peeled from a log; the exposed face is the tangential plane. The tangential plane of section does not provide any information about features that vary in the radial direction, but it does provide information about the tangential dimensions of features.

All three planes of section are important to the proper observation of wood, and only by looking at each can a holistic and accurate understanding of the three-dimensional structure of wood be gleaned. The three planes of section are determined by the structure of wood and the way in which the cells in wood are arrayed. The topology of wood and the distribution of the cells are accomplished by a specific part of the tree stem.

Vascular Cambium

The axial and radial systems and their component cells are derived from a part of the tree called the vascular cambium. The vascular cambium is a thin layer of cells that exists between the inner bark and the wood (Figs. 3–1, 3–4) that produces, by means of many cell divisions, wood (or secondary xylem) to the inside and bark (or secondary phloem) to the outside, both of which are vascular conducting tissues (Larson 1994). As the vascular cambium adds cells to the layers of wood and bark around a tree, the girth of the tree increases, and thus the total surface area of the vascular cambium itself must increase, and this is accomplished by cell division as well.

The axial and radial systems are generated in the vascular cambium by two component cells: fusiform initials and ray initials. Fusiform initials, named to describe their long, slender shape, give rise to cells of the axial system, and ray initials give rise to the radial system. For this reason, there is a direct and continuous link between the most recently formed wood, the vascular cambium, and the inner bark. In most cases, the radial system in the wood is continuous into the inner bark, through the vascular cambium. In this way wood, the water-conducting tissue, stays connected to the inner bark, the photosynthate-conducting tissue. They are interdependent tissues because the living cells in wood require photosynthate for respiration and cell growth and the inner bark requires water in which to dissolve and transport the photosynthate. The vascular cambium is an integral feature that not only gives rise to these tissue systems but also links them so that they may function in the living tree.

Growth Rings

Wood is produced by the vascular cambium one layer of cell divisions at a time, but we know from general experience that in many woods large groups of cells are produced more or less together in time, and these groups act together to serve the tree. These collections of cells produced together over a discrete time interval are known as growth increments or growth rings. Cells formed at the beginning of the growth increment are called earlywood cells, and cells formed in the latter portion of the growth increment are called latewood cells (Fig. 3–3D,E). Springwood and summerwood were terms formerly used to refer to earlywood and latewood, respectively, but their use is no longer recommended (IAWA 1989).

In temperate portions of the world and anywhere else with distinct, regular seasonality, trees form their wood in annual growth increments; that is, all the wood produced in one growing season is organized together into a recognizable, functional entity that many sources refer to as annual rings. Such terminology reflects this temperate bias, so a preferred term is growth increment, or growth ring (IAWA 1989). In many woods in the tropics, growth rings are not evident. However, continuing research in this area has uncovered several characteristics whereby growth rings can be correlated with seasonality changes in some tropical species (Worbes 1995, 1999; Callado and others 2001).

Woods that form distinct growth rings, and this includes most woods that are likely to be used as engineering materials in North America, show three fundamental patterns within a growth ring: no change in cell pattern across the ring; a gradual reduction of the inner diameter of conducting elements from the earlywood to the latewood; and a sudden and distinct change in the inner diameter of the conducting elements across the ring (Fig. 3–5). These patterns appear in both softwoods and hardwoods but differ in

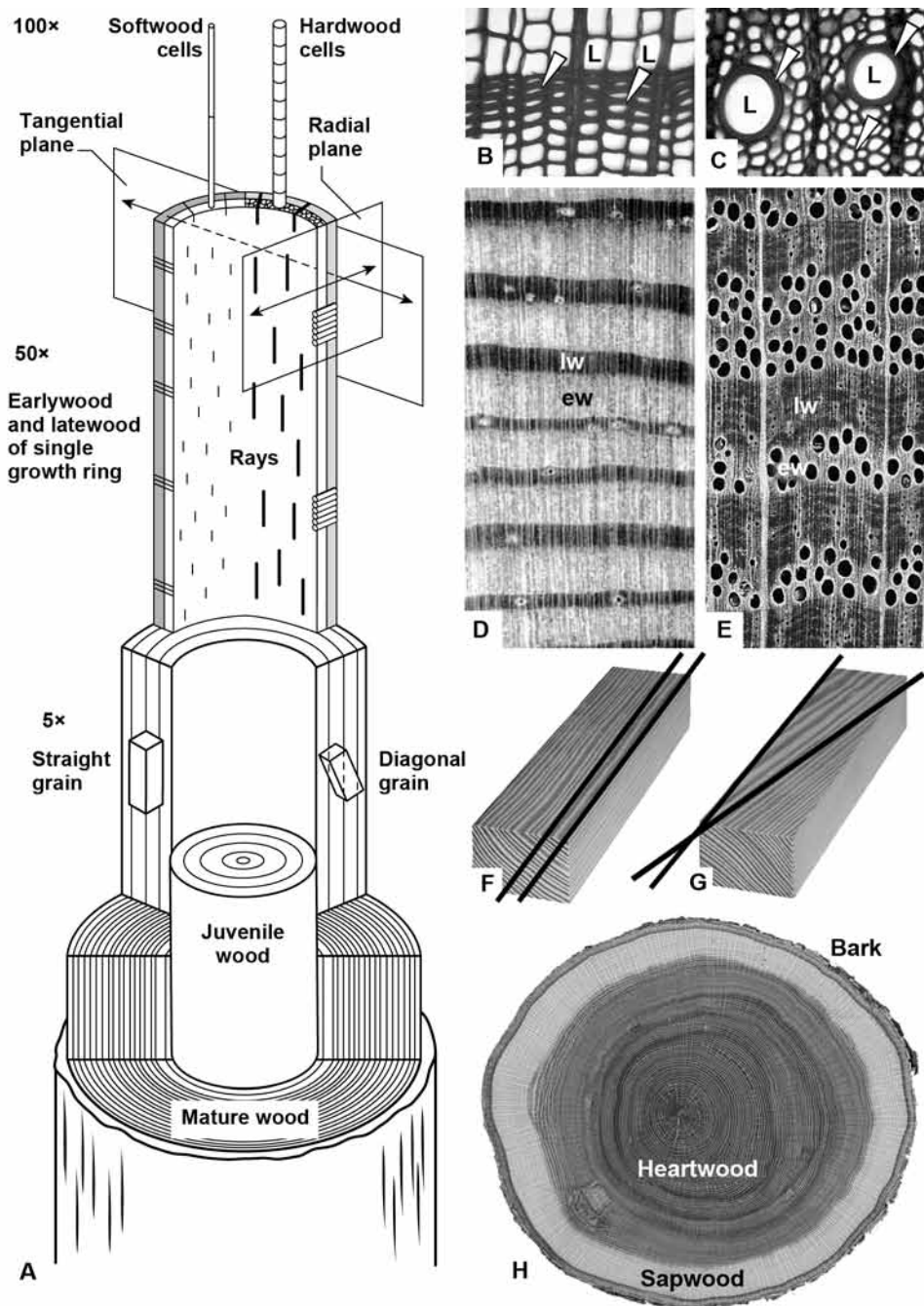

Figure 3-3. A, illustration of a cut-away tree at various magnifications, corresponding roughly with the images to its right; at the top, at an approximate magnification of 100 \times , a softwood cell and several hardwood cells are illustrated, to give a sense of scale between the two; one tier lower, at an approximate magnification of 50 \times , is a single growth ring of a softwood (left) and a hardwood (right), and an indication of the radial and tangential planes; the next tier, at approximately 5 \times magnification, illustrates many growth rings together and how one might produce a straight-grained rather than a diagonal-grained board; the lowest tier includes an illustration of the relative position of juvenile and mature wood in the tree, at 1 \times magnification. B,C, light microscopic views of the lumina (L) and cell walls (arrowheads) of a softwood (B) and a hardwood (C). D,E, hand-lens views of growth rings, each composed of earlywood (ew) and latewood (lw), in a softwood (D) and a hardwood (E). F, a straight-grained board; note that the line along the edge of the board is parallel to the line along the grain of the board. G, a diagonal-grained board; note that the two lines are markedly not parallel; this board has a slope of grain of about 1 in 7. H, the gross anatomy of a tree trunk, showing bark, sapwood, and heartwood.

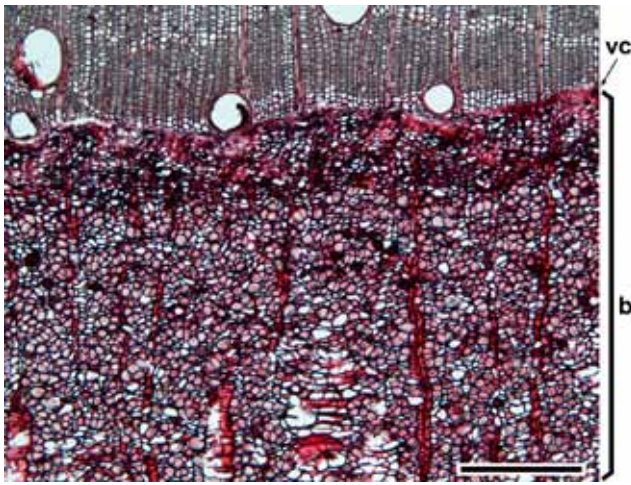

Figure 3–4. Light microscopic view of the vascular cambium. Transverse section showing vascular cambium (vc) and bark (b) in *Croton macrobothrys*. The tissue above the vascular cambium is wood. Scale bar = 390 μm .

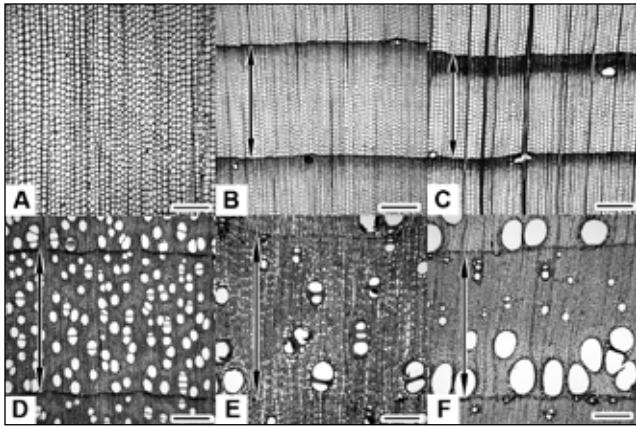

Figure 3–5. Transverse sections of woods showing types of growth rings. Arrows delimit growth rings, when present. A–C, softwoods. A, no transition within the growth ring (growth ring absent) in *Podocarpus imbricata*. B, gradual transition from earlywood to latewood in *Picea glauca*. C, abrupt transition from earlywood to latewood in *Pseudotsuga menziesii*. D–F, hardwoods. D, diffuse-porous wood (no transition) in *Acer saccharum*. E, semi-ring-porous wood (gradual transition) in *Diospyros virginiana*. F, ring-porous wood (abrupt transition) in *Fraxinus americana*. Scale bars = 300 μm .

each because of the distinct anatomical differences between the two.

Non-porous woods (or softwoods, woods without vessels) can exhibit any of these three general patterns. Some softwoods such as Western redcedar (*Thuja plicata*), northern white-cedar (*Thuja occidentalis*), and species of spruce (*Picea*) and true fir (*Abies*) have growth increments that undergo a gradual transition from the thin-walled wide-lumined earlywood cells to the thicker-walled, narrower-

lumined latewood cells (Fig. 3–5B). Other woods undergo an abrupt transition from earlywood to latewood, such as southern yellow pine (*Pinus*), larch (*Larix*), Douglas-fir (*Pseudotsuga menziesii*), baldcypress (*Taxodium disticum*), and redwood (*Sequoia sempervirens*) (Fig. 3–5C). Because most softwoods are native to the north temperate regions, growth rings are clearly evident. Only in species such as araucaria (*Araucaria*) and some podocarps (*Podocarpus*) does one find no transition within the growth ring (Fig. 3–5A). Some authors report this state as growth rings being absent or only barely evident (Phillips 1948, Kukachka 1960).

Porous woods (or hardwoods, woods with vessels) have two main types of growth rings and one intermediate form. In diffuse-porous woods, vessels either do not markedly differ in size and distribution from the earlywood to the latewood, or the change in size and distribution is gradual and no clear distinction between earlywood and latewood can be found (Fig. 3–5D). Maple (*Acer*), birch (*Betula*), aspen/cottonwood (*Populus*), and yellow-poplar (*Liriodendron tulipifera*) are examples of diffuse porous species.

This pattern is in contrast to ring-porous woods wherein the transition from earlywood to latewood is abrupt, with vessel diameters decreasing substantially (often by an order or magnitude or more); this change in vessel size is often accompanied by a change in the pattern of vessel distribution as well. This creates a ring pattern of large earlywood vessels around the inner portion of the growth increment, and then denser, more fibrous tissue in the latewood, as is found in hackberry (*Celtis occidentalis*), white ash (*Fraxinus americana*), shagbark hickory (*Carya ovata*), and northern red oak (*Quercus rubra*) (Fig. 3–5F).

Sometimes the vessel size and distribution pattern falls more or less between these two definitions, and this condition is referred to as semi-ring-porous (Fig. 3–5E). Black walnut (*Juglans nigra*) is a temperate-zone semi-ring-porous wood. Most tropical hardwoods are diffuse-porous; the best-known commercial exceptions to this are the Spanish-cedars (*Cedrela* spp.) and teak (*Tectona grandis*), which are generally semi-ring-porous and ring-porous, respectively.

Few distinctly ring-porous species grow in the tropics and comparatively few grow in the southern hemisphere. In genera that span temperate and tropical zones, it is common to have ring-porous species in the temperate zone and diffuse-porous species in the tropics. The oaks (*Quercus*), ashes (*Fraxinus*), and hackberries (*Celtis*) native to the tropics are diffuse-porous, whereas their temperate congeners are ring-porous. Numerous detailed texts provide more information on growth increments in wood, a few of which are of particular note (Panshin and deZeeuw 1980, Dickison 2000, Carlquist 2001).

Cells in Wood

Understanding a growth ring in greater detail requires some familiarity with the structure, function, and variability of

Chapter 3 Structure and Function of Wood

cells that make up the ring. A living plant cell consists of two primary domains: the protoplast and the cell wall. The protoplast is the sum of the living contents that are bounded by the cell membrane. The cell wall is a non-living, largely carbohydrate matrix extruded by the protoplast to the exterior of the cell membrane. The plant cell wall protects the protoplast from osmotic lysis and often provides mechanical support to the plant at large (Esau 1977, Raven and others 1999, Dickison 2000).

For cells in wood, the situation is somewhat more complicated than this highly generalized case. In many cases in wood, the ultimate function of the cell is borne solely by the cell wall. This means that many mature wood cells not only do not require their protoplasts, but indeed must completely remove their protoplasts prior to achieving functional maturity. For this reason, a common convention in wood literature is to refer to a cell wall without a protoplast as a cell. Although this is technically incorrect from a cell biological standpoint, this convention is common in the literature and will be observed throughout the remainder of the chapter.

In the case of a mature cell in wood in which there is no protoplast, the open portion of the cell where the protoplast would have existed is known as the lumen (plural: lumina). Thus, in most cells in wood there are two domains; the cell wall and the lumen (Fig. 3–3B,C). The lumen is a critical component of many cells, whether in the context of the amount of space available for water conduction or in the context of a ratio between the width of the lumen and the thickness of the cell wall. The lumen has no structure per se, as it is the void space in the interior of the cell. Thus, wood is a substance that has two basic domains; air space (mostly in the lumina of the cells) and the cell walls of the component cells.

Cell Walls

Cell walls in wood give wood the majority of its properties discussed in later chapters. Unlike the lumen, which is a void space, the cell wall itself is a highly regular structure, from one cell type to another, between species, and even when comparing softwoods and hardwoods. The cell wall consists of three main regions: the middle lamella, the primary wall, and the secondary wall (Fig. 3–6). In each region, the cell wall has three major components: cellulose microfibrils (with characteristic distributions and organization), hemicelluloses, and a matrix or encrusting material, typically pectin in primary walls and lignin in secondary walls (Panshin and deZeeuw 1980). In a general sense, cellulose can be understood as a long string-like molecule with high tensile strength; microfibrils are collections of cellulose molecules into even longer, stronger thread-like macromolecules. Lignin is a brittle matrix material. The hemicelluloses are smaller, branched molecules thought to help link the lignin and cellulose into a unified whole in each layer of the cell wall.

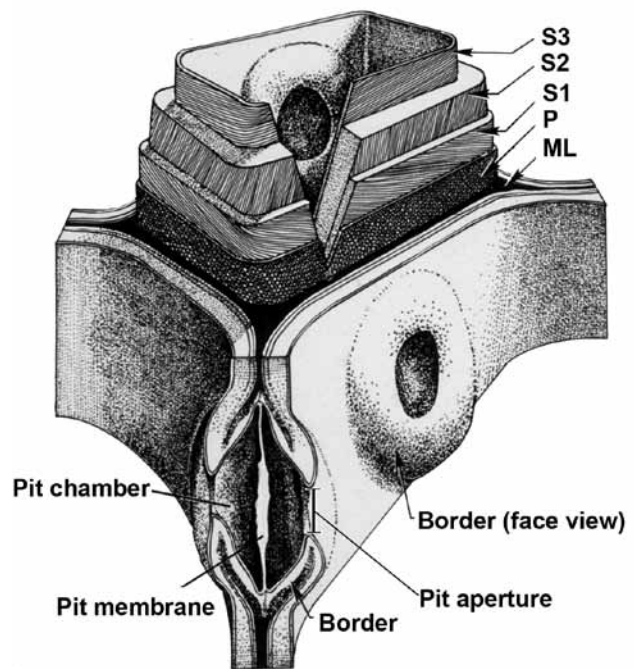

Figure 3–6. Cut-away drawing of the cell wall, including the structural details of a bordered pit. The various layers of the cell wall are detailed at the top of the drawing, beginning with the middle lamella (ML). The next layer is the primary wall (P), and on the surface of this layer the random orientation of the cellulose microfibrils is detailed. Interior to the primary wall is the secondary wall in its three layers: S1, S2, and S3. The microfibril angle of each layer is illustrated, as well as the relative thickness of the layers. The lower portion of the illustration shows bordered pits in both sectional and face view.

To understand these wall layers and their interrelationships, it is necessary to remember that plant cells generally do not exist singly in nature; instead they are adjacent to many other cells, and this association of thousands of cells, taken together, forms an organ, such as a leaf. Each of the individual cells must adhere to one another in a coherent way to ensure that the cells can act as a unified whole. This means they must be interconnected to permit the movement of biochemicals (such as photosynthate, hormones, cell-signaling agents) and water. This adhesion is provided by the middle lamella, the layer of cell wall material between two or more cells, a part of which is contributed by each of the individual cells (Fig. 3–6). This layer is the outermost layer of the cell wall continuum and in a non-woody organ is pectin rich. In the case of wood, the middle lamella is lignified.

The next layer formed by the protoplast just interior to the middle lamella is the primary wall (Fig. 3–6). The primary wall is characterized by a largely random orientation of cellulose microfibrils; like thin threads wound round and round a balloon in no particular order, where any microfibril angle from 0° to 90° relative to the long axis of the cell may

be present. In cells in wood, the primary wall is thin and is generally indistinguishable from the middle lamella. For this reason, the term compound middle lamella is used to denote the primary cell wall of a cell, the middle lamella, and the primary cell wall of the adjacent cell. Even when viewed with transmission electron microscopy, the compound middle lamella often cannot be separated unequivocally into its component layers.

The remaining cell wall domain, found in virtually all cells in wood (and in many cells in non-woody plants or plant parts), is the secondary cell wall. The secondary cell wall is composed of three layers (Fig. 3–6). As the protoplast lays down the cell wall layers, it progressively reduces the lumen volume. The first-formed secondary cell wall layer is the S_1 (Fig. 3–6), which is adjacent to compound middle lamella (or technically, the primary wall). This layer is a thin layer and is characterized by a large microfibril angle. That is to say, the cellulose microfibrils are laid down in a helical fashion, and the angle between the mean microfibril direction and the long axis of the cell is large (50° to 70°).

The next wall layer is arguably the most important cell wall layer in determining the properties of the cell and, thus, the wood properties at a macroscopic level (Panshin and deZeeuw 1980). This layer, formed interior to the S_1 layer, is the S_2 layer (Fig. 3–6). This is the thickest secondary cell wall layer and it makes the greatest contribution to the overall properties of the cell wall. It is characterized by a lower lignin percentage and a low microfibril angle (5° to 30°). The microfibril angle of the S_2 layer of the wall has a strong but not fully understood relationship with wood properties at a macroscopic level (Kretschmann and others 1998), and this is an area of active research.

Interior to the S_2 layer is the S_3 layer, a relatively thin wall layer (Fig. 3–6). The microfibril angle of this layer is relatively high and similar to the S_1 ($>70^\circ$). This layer has the lowest percentage of lignin of any of the secondary wall layers. The explanation of this phenomenon is related directly to the physiology of the living tree. In brief, for water to move up the plant (transpiration), there must be adhesion between the water molecules and the cell walls of the water conduits. Lignin is a hydrophobic macromolecule, so it must be in low concentration in the S_3 to permit adhesion of water to the cell wall and thus facilitate transpiration. For more detail on these wall components and information on transpiration and the role of the cell wall, see any college-level plant physiology textbook (for example, Kozlowski and Pallardy 1997, Taiz and Zeiger 1991).

Pits

Any discussion of cell walls in wood must be accompanied by a discussion of the ways in which cell walls are modified to allow communication and transport between the cells in the living plant. These wall modifications, called pit-pairs

(or more commonly just pits), are thin areas in the cell walls between two cells and are a critical aspect of wood structure too often overlooked in wood technological treatments. Pits have three domains: the pit membrane, the pit aperture, and the pit chamber. The pit membrane (Fig. 3–6) is the thin semi-porous remnant of the primary wall; it is a carbohydrate and not a phospholipid membrane. The pit aperture is the opening or hole leading into the open area of the pit, which is called the pit chamber (Fig. 3–6). The type, number, size, and relative proportion of pits can be characteristic of certain types of wood and furthermore can directly affect how wood behaves in a variety of situations, such as how wood interacts with surface coatings (DeMeijer and others 1998, Rijkaert and others 2001).

Pits of predictable types occur between different types of cells. In the cell walls of two adjacent cells, pits will form in the wall of each cell separately but in a coordinated location so that the pitting of one cell will match up with the pitting of the adjacent cell (thus a pit-pair). When this coordination is lacking and a pit is formed only in one of the two cells, it is called a blind pit. Blind pits are fairly rare in wood. Understanding the type of pit can permit one to determine what type of cell is being examined in the absence of other information. It can also allow one to make a prediction about how the cell might behave, particularly in contexts that involve fluid flow. Pits occur in three varieties: bordered, simple, and half-bordered (Esau 1977, Raven and others 1999).

Bordered pits are thus named because the secondary wall overarches the pit chamber and the aperture is generally smaller or differently shaped than the pit chamber, or both. The portion of the cell wall that is overarched the pit chamber is called the border (Figs. 3–6, 3–7A,D). When seen in face view, bordered pits often are round in appearance and look somewhat like a doughnut (Fig. 3–6). When seen in sectional view, the pit often looks like a pair of V's with the open ends of the V's facing each other (Fig. 3–7A,D). In this case, the long stems of the V represent the borders, the secondary walls that are overarched the pit chamber. Bordered pits always occur between two conducting cells, and sometimes between other cells, typically those with thick cell walls. The structure and function of bordered pits, particularly those in softwoods (see following section), are much-studied and considered to be well-suited to the safe and efficient conduction of sap. The status of the bordered pit (whether it is open or closed) has great importance in the field of wood preservation and can affect wood finishing and adhesive bonding.

Simple pits lack any sort of border (Fig. 3–7C,F). The pit chamber is straight-walled, and the pits are uniform in size and shape in each of the partner cells. Simple pits are typical between parenchyma cells and in face view merely look like clear areas in the walls.

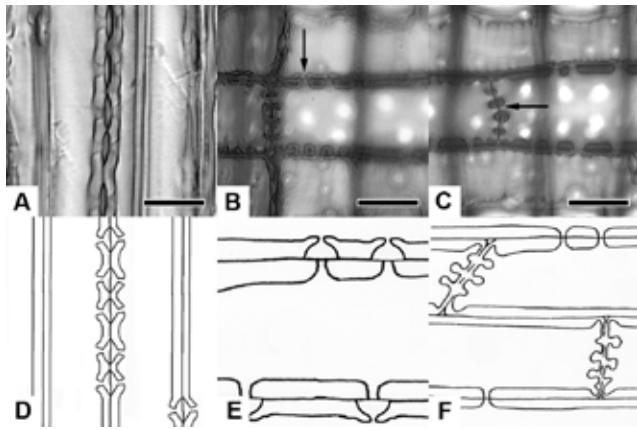

Figure 3–7. Light micrographs and sketches of the three types of pits. A,D, longitudinal section of bordered pits in *Xanthocyparis vietnamensis*; the pits look like a vertical stack of thick-walled letter Vs. B,E, half-bordered pits in *Pseudotsuga mensiezii*; the arrow shows one half-bordered pit. C,F, simple pits on an end-wall in *Pseudotsuga mensiezii*; the arrow indicates one of five simple pits on the end wall. Scale bars = 20 µm.

Half-bordered pits occur between a conducting cell and a parenchyma cell. In this case, each cell forms the kind of pit that would be typical of its type (bordered in the case of a conducting cell and simple in the case of a parenchyma cell) and thus half of the pit pair is simple and half is bordered (Fig. 3–7B,E). In the living tree, these pits are of great importance because they represent the communication between conducting cells and biochemically active parenchyma cells.

Microscopic Structure of Softwoods and Hardwoods

As discussed previously, the fundamental differences between woods are founded on the types, sizes, proportions, pits, and arrangements of different cells that comprise the wood. These fine details of structure can affect the use of a wood.

Softwoods

The structure of a typical softwood is relatively simple. The axial or vertical system is composed mostly of axial tracheids, and the radial or horizontal system is the rays, which are composed mostly of ray parenchyma cells.

Tracheids

Tracheids are long cells that are often more than 100 times longer (1 to 10 mm) than wide and they are the major component of softwoods, making up over 90% of the volume of the wood. They serve both the conductive and mechanical needs of softwoods. On the transverse view or section (Fig. 3–8A), tracheids appear as square or slightly rectangular cells in radial rows. Within one growth ring they are

typically thin-walled in the earlywood and thicker-walled in the latewood. For water to flow between tracheids, it must pass through circular bordered pits that are concentrated in the long, tapered ends of the cells. Tracheids overlap with adjacent cells across both the top and bottom 20% to 30% of their length. Water flow thus must take a slightly zigzag path as it goes from one cell to the next through the pits. Because the pits have a pit membrane, resistance to flow is substantial. The resistance of the pit membrane coupled with the narrow diameter of the lumina makes tracheids relatively inefficient conduits compared with the conducting cells of hardwoods. Detailed treatments of the structure of wood in relation to its conductive functions can be found in the literature (Zimmermann 1983, Kozlowski and Pallardy 1997).

Axial Parenchyma and Resin Canal Complexes

Another cell type that is sometimes present in softwoods is axial parenchyma. Axial parenchyma cells are similar in size and shape to ray parenchyma cells, but they are vertically oriented and stacked one on top of the other to form a parenchyma strand. In transverse section they often look like axial tracheids but can be differentiated when they contain dark colored organic substances in the lumina of the cells. In the radial or tangential section they appear as long strands of cells generally containing dark-colored substances. Axial parenchyma is most common in redwood, juniper, cypress, baldcypress, and some species of *Podocarpus* but never makes up even 1% of the volume of a block of wood. Axial parenchyma is generally absent in pine, spruce, larch, hemlock, and species of *Araucaria* and *Agathis*.

In species of pine, spruce, Douglas-fir, and larch, structures commonly called resin ducts or resin canals are present axially (Fig. 3–9) and radially (Fig. 3–9C). These structures are voids or spaces in the wood and are not cells. Specialized parenchyma cells that function in resin production surround resin canals. When referring to the resin canal and all the associated parenchyma cells, the correct term is axial or radial resin canal complex (Wiedenhoft and Miller 2002). In pine, resin canal complexes are often visible on the transverse section to the naked eye, but they are much smaller in spruce, larch, and Douglas-fir, and a hand lens is needed to see them. Radial resin canal complexes are embedded in specialized rays called fusiform rays (Figs. 3–8C, 3–9C). These rays are typically taller and wider than normal rays. Resin canal complexes are absent in the normal wood of other softwoods, but some species can form large tangential clusters of traumatic axial resin canals in response to substantial injury.

Rays

The other cells in Figure 3–8A are ray parenchyma cells that are barely visible and appear as dark lines running in a top-to-bottom direction. Ray parenchyma cells are

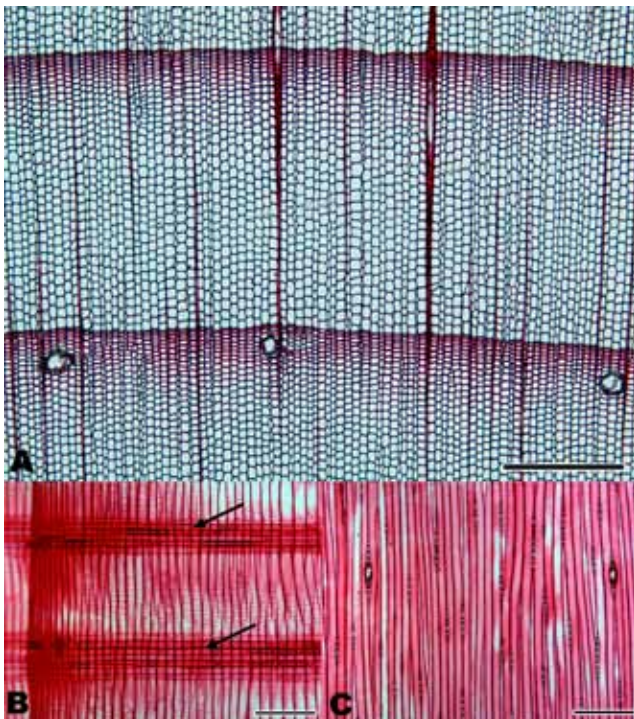

Figure 3–8. Microscopic structure of *Picea glauca*, a typical softwood. A, transverse section, scale bar = 390 μm ; the bulk of the wood is made of tracheids, the small rectangles of various thicknesses; the three large, round structures are resin canals and their associated cells; the dark lines running from the top to the bottom of the photo are the ray cells of the rays. B, radial section showing two rays (arrows) running from left to right; each cell in the ray is a ray cell, and they are low, rectangular cells; the rays begin on the right in the earlywood (thin-walled tracheids) and continue into and through the latewood (thick-walled tracheids) and into the earlywood of the next growth ring, on the left side of the photo; scale bar = 195 μm . C, tangential section; rays seen in end-view, mostly only one cell wide; two rays are fusiform rays; there are radial resin canals embedded in the rays, causing them to bulge; scale bar = 195 μm .

rectangular prisms or brick-shaped cells. Typically they are approximately 15 μm high by 10 μm wide by 150 to 250 μm long in the radial or horizontal direction (Fig. 3–8B). These brick-like cells form the rays, which function primarily in synthesis, storage, and lateral transport of biochemicals and, to a lesser degree, water. In radial view or section (Fig. 3–8B), the rays look like brick walls and the ray parenchyma cells are sometimes filled with dark-colored substances. In tangential section (Fig. 3–8C), the rays are stacks of ray parenchyma cells one on top of the other forming a ray that is only one cell in width, called a uniseriate ray.

When ray parenchyma cells intersect with axial tracheids, specialized pits are formed to connect the axial and radial systems. The area of contact between the tracheid wall and the wall of the ray parenchyma cells is called a cross-field. The type, shape, and size and number of pits in the

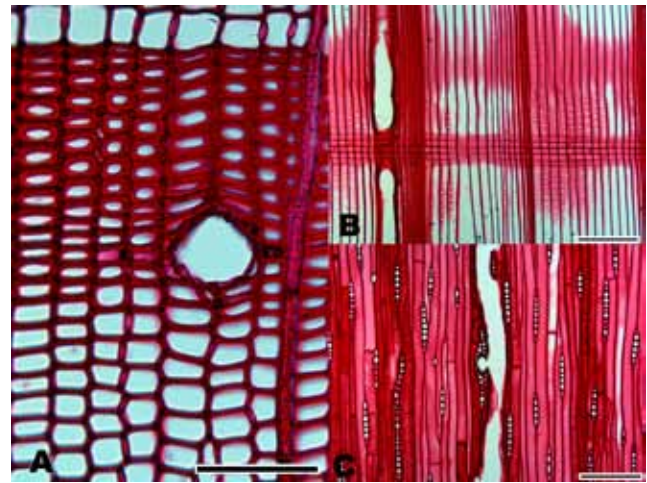

Figure 3–9. Resin canal complexes in *Pseudotsuga menziesii*. A, transverse section showing a single axial resin canal complex. In this view the tangential and radial diameters of the canal can be measured accurately. Scale bar = 100 μm . B, radial section showing an axial resin canal complex embedded in the latewood. It is crossed by a ray that also extends into the earlywood on either side of the latewood. Scale bar = 195 μm . C, tangential section showing the anastomosis between an axial and a radial resin canal complex. The fusiform ray bearing the radial resin canal complex is in contact with the axial resin canal complex. Scale bar = 195 μm .

cross-field are generally consistent within a species and can be diagnostic for wood identification.

Species that have resin canal complexes also have ray tracheids, which are specialized horizontal tracheids that normally are situated at the margins of the rays. These ray tracheids have bordered pits like axial tracheids but are much shorter and narrower. Ray tracheids also occur in a few species that do not have resin canals. Alaska yellow-cedar, (*Chamaecyparis nootkatensis*), hemlock (*Tsuga*), and rarely some species of true fir (*Abies*) have ray tracheids. Additional detail regarding the microscopic structure of softwoods can be found in the literature (Phillips 1948, Kukachka 1960, Panshin and deZeeuw 1980, IAWA 2004).

Hardwoods

The structure of a typical hardwood is much more complicated than that of a softwood. The axial system is composed of fibrous elements of various kinds, vessel elements in various sizes and arrangements, and axial parenchyma in various patterns and abundance. As in softwoods, rays comprise the radial system and are composed of ray parenchyma cells, but hardwoods show greater variety in cell sizes and shapes.

Vessels

Vessel elements are the specialized water-conducting cells of hardwoods. They are stacked one on top of the other to form vessels. Where the ends of the vessel elements come in contact with one another, a hole is formed called a

Chapter 3 Structure and Function of Wood

perforation plate. Thus hardwoods have perforated tracheary elements (vessels elements) for water conduction, whereas softwoods have imperforate tracheary elements (tracheids). On the transverse section, vessels appear as large openings and are often referred to as pores (Fig. 3–2D).

Vessel diameters may be small (<30 μm) or quite large (>300 μm), but typically range from 50 to 200 μm . They are much shorter than tracheids and range from 100 to 1,200 μm , or 0.1 to 1.2 mm. Vessels can be arranged in various patterns. If all the vessels are the same size and more or less scattered throughout the growth ring, the wood is diffuse-porous (Fig. 3–5D). If the earlywood vessels are much larger than the latewood vessels, the wood is ring-porous (Fig. 3–5F). Vessels can also be arranged in a tangential or oblique arrangement in a radial arrangement, in clusters, or in many combinations of these types (IAWA 1989). In addition, individual vessels may occur alone (solitary arrangement) or in pairs or radial multiples of up to five or more vessels in a row. At the end of the vessel element is a hole or perforation plate. If there are no obstructions across the perforation plate, it is called a simple perforation plate. If bars are present, the perforation plate is called a scalariform perforation plate.

Where vessel elements come in contact with each other tangentially, intervessel or intervascular bordered pits are formed. These pits range in size from 2 to >16 μm in height and are arranged on the vessel walls in three basic ways. The most common arrangement is alternate, where the pits are offset by half the diameter of a pit from one row to the next. In the opposite arrangement, the pits are in files with their apertures aligned vertically and horizontally. In the scalariform arrangement, the pits are much wider than high. Combinations of these arrangements can also be observed in some species. Where vessel elements come in contact with ray cells, often half-bordered pits are formed called vessel–ray pits. These pits can be the same size and shape as the intervessel pits or much larger.

Fibers

Fibers in hardwoods function almost exclusively as mechanical supporting cells. They are shorter than softwood tracheids (0.2 to 1.2 mm), average about half the width of softwood tracheids, but are usually two to ten times longer than vessel elements (Fig. 3–10B). The thickness of the fiber cell wall is the major factor governing density and mechanical strength of hardwood timbers. Species with thin-walled fibers, such as cottonwood (*Populus deltoides*), basswood (*Tilia americana*), ceiba, and balsa (*Ochroma pyramidale*), have low density and strength; species with thick-walled fibers, such as hard maple, black locust (*Robinia pseudoacacia*), ipe (*Tabebuia serratifolia*), and bulletwood (*Manilkara bidentata*), have high density and strength. Pits between fibers are generally inconspicuous and may be simple or bordered. In some woods such as oak (*Quercus*) and meranti/lauan (*Shorea*), vascular or vasicentric tracheids are present,

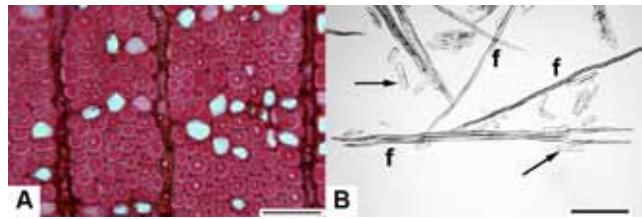

Figure 3–10. Fibers in *Quercus rubra*. A, transverse section showing thick-walled, narrow-lumined fibers; three rays are passing vertically through the photo, and there are a number of axial parenchyma cells, the thin-walled, wide-lumined cells, in the photo; scale bar = 50 μm . B, macerated wood; there are several fibers (f), two of which are marked; also easily observed are parenchyma cells (arrows), both individually and in small groups; note the thin walls and small rectangular shape compared to the fibers; scale bar = 300 μm .

especially near or surrounding the vessels. These specialized fibrous elements in hardwoods typically have bordered pits, are thin-walled, and are shorter than the fibers of the species; they should not be confused with the tracheids in softwoods, which are much longer than hardwood fibers.

Axial Parenchyma

Axial parenchyma in softwoods is absent or only occasionally present as scattered cells, but hardwoods have a wide variety of axial parenchyma patterns (Fig. 3–11). The axial parenchyma cells in hardwoods and softwoods are roughly the same size and shape, and they also function in the same manner. The difference comes in the abundance and specific patterns in hardwoods. Paratracheal parenchyma is associated with the vessels, and apotracheal parenchyma is not associated with the vessels. Paratracheal parenchyma is further divided into vasicentric (surrounding the vessels, Fig. 3–11A), aliform (surrounding the vessel and with wing-like extensions, Fig. 3–11C), and confluent (several connecting patches of paratracheal parenchyma sometimes forming a band, Fig. 3–11E). Apotracheal parenchyma is divided into diffuse (scattered), diffuse-in-aggregate (short bands, Fig. 3–11B), and banded, whether at the beginning or end of the growth ring (marginal, Fig. 3–11F) or within a growth ring (Fig. 3–11D). Each species has a particular pattern of axial parenchyma, which is more or less consistent from specimen to specimen, and these cell patterns are important in wood identification.

Rays

The rays in hardwoods are structurally more diverse than those found in softwoods. In some species such as willow (*Salix*), cottonwood, and koa (*Acacia koa*), the rays are exclusively uniseriate and are much like softwood rays. In hardwoods, most species have rays that are more than one cell wide. In oak and hard maple, the rays are two-sized, uniseriate and more than eight cells wide and in oak several

Gregory 1994; Cutler and Gregory 1998; Dickison 2000; Carlquist 2001).

Wood Technology

Though briefly discussing each kind of cell in isolation is necessary, the beauty and complexity of wood are found in the interrelationship between many cells at a much larger scale. The macroscopic properties of wood such as density, hardness, bending strength, and others are properties derived from the cells that make up the wood. Such larger-scale properties are based on chemical and anatomical details of wood structure (Panshin and deZeeuw 1980).

Moisture Relations

The cell wall is largely made up of cellulose and hemicellulose, and the hydroxyl groups on these chemicals make the cell wall hygroscopic. Lignin, the agent cementing cells together, is a comparatively hydrophobic molecule. This means that the cell walls in wood have a great affinity for water, but the ability of the walls to take up water is limited in part by the presence of lignin. Water in wood has a strong effect on wood properties, and wood–water relations greatly affect the industrial use of wood in wood products. Additional information regarding dimensional changes of wood with changing moisture content can be found in Chapters 4 and 13.

Density

Density (or specific gravity) is one of the most important physical properties of wood (Desch and Dinwoodie 1996, Bowyer and others 2003). Density is the weight or mass of wood divided by the volume of the specimen at a given moisture content. Thus, units for density are typically expressed as pounds per cubic foot (lb ft^{-3}) or kilograms per cubic meter (kg m^{-3}). When density values are reported in the literature, the moisture content of the wood must also be given. Specific gravity is the density of the sample normalized to the density of water. (This topic is addressed in greater detail in Chap. 4, including a detailed explanation of wood specific gravity.)

Wood structure determines wood density; in softwoods where latewood is abundant (Fig. 3–3D) in proportion to earlywood, density is higher (for example, 0.59 specific gravity in longleaf pine, *Pinus palustris*). The reverse is true when there is much more earlywood than latewood (Fig. 3–5B) (for example, 0.35 specific gravity in eastern white pine, *Pinus strobus*). To say it another way, density increases as the proportion of cells with thick cell walls increases. In hardwoods, density is dependent not only on fiber wall thickness, but also on the amount of void space occupied by vessels and parenchyma. In balsa, vessels are large (typically $>250\ \mu\text{m}$ in tangential diameter) and there is an abundance of axial and ray parenchyma. Fibers that are present are thin walled, and the specific gravity may be <0.20 . In dense woods, the fibers are thick walled, lumina are virtually absent, and fibers are abundant in relation to vessels and



Figure 3–11. Transverse sections of various woods showing a range of hardwood axial parenchyma patterns. A, C, and E are woods with paratracheal types of parenchyma. A, vasicentric parenchyma in *Enterolobium maximum*; note that two vessels in the middle of the view are connected by parenchyma, which is the feature also shown in E; the other vessels in the image present vasicentric parenchyma only. C, aliform parenchyma in *Afzelia africana*; the parenchyma cells are the light-colored, thin-walled cells, and are easily visible. E, confluent parenchyma in *Afzelia cuazensis*. B, D, and F are woods with apotracheal types of parenchyma. B, diffuse-in-aggregate parenchyma in *Dalbergia stevensonii*. D, banded parenchyma in *Micropholis guyanensis*. F, marginal parenchyma in *Juglans nigra*; in this case, the parenchyma cells are darker in color, and they delimit the growth rings (arrows). Scale bars = $780\ \mu\text{m}$.

centimeters high (Fig. 3–12A). In most species the rays are one to five cells wide and $<1\ \text{mm}$ high (Fig. 3–12B). Rays in hardwoods are composed of ray parenchyma cells that are either procumbent or upright. As the name implies, procumbent ray cells are horizontal and are similar in shape and size to the softwood ray parenchyma cells (Fig. 3–12C). Upright ray cells have their long axis oriented axially (Fig. 3–12D). Upright ray cells are generally shorter than procumbent cells are long, and sometimes they are nearly square. Rays that have only one type of ray cell, typically only procumbent cells, are called homocellular rays. Those that have procumbent and upright cells are called heterocellular rays. The number of rows of upright ray cells, when present, varies from one to many and can be diagnostic in wood identification.

The great diversity of hardwood anatomy is treated in many sources throughout the literature (Metcalf and Chalk 1950, 1979, 1987; Panshin and deZeeuw 1980; IAWA 1989;

Chapter 3 Structure and Function of Wood

parenchyma. Some tropical hardwoods have specific gravities >1.0 . In all woods, density is related to the proportion of the volume of cell wall material to the volume of lumina of those cells in a given bulk volume.

Juvenile Wood and Reaction Wood

Two key examples of the biology of the tree affecting the quality of wood can be seen in the formation of juvenile wood and reaction wood. They are grouped together because they share several common cellular, chemical, and tree physiological characteristics, and each may or may not be present in a certain piece of wood.

Juvenile wood is the first-formed wood of the young tree—the rings closest to the pith (Fig. 3–3A, bottom). Juvenile wood in softwoods is in part characterized by the production of axial tracheids that have a higher microfibril angle in the S₂ wall layer (Larson and others 2001). A higher microfibril angle in the S₂ is correlated with drastic longitudinal shrinkage of the cells when the wood is dried for human use, resulting in a piece of wood that has a tendency to warp, cup, and check. The morphology of the cells themselves is often altered so that the cells, instead of being long and straight, are often shorter and angled, twisted, or bent. The precise functions of juvenile wood in the living tree are not fully understood but are thought to confer little-understood mechanical advantages.

Reaction wood is similar to juvenile wood in several respects but is formed by the tree for different reasons. Most any tree of any age will form reaction wood when the woody organ (whether a twig, branch, or the trunk) is deflected from the vertical by more than one or two degrees. This means that all non-vertical branches form considerable quantities of reaction wood. The type of reaction wood formed by a tree differs in softwoods and hardwoods. In softwoods, the reaction wood is formed on the underside of the leaning organ and is called compression wood (Fig. 3–13A) (Timmel 1986). In hardwoods, the reaction wood forms on the top side of the leaning organ and is called tension wood (Fig. 3–13B) (Desch and Dinwoodie 1996, Bowyer and others 2003). As mentioned above, the various features of juvenile wood and reaction wood are similar. In compression wood, the tracheids are shorter, misshapen cells with a large S₂ microfibril angle, a high degree of longitudinal shrinkage, and high lignin content (Timmel 1986). They also take on a distinctly rounded outline (Fig. 3–13C). In tension wood, the fibers fail to form a proper secondary wall and instead form a highly cellulosic wall layer called the G layer, or gelatinous layer (Fig. 3–13D).

Appearance of Wood as Sawn Lumber

Color and Luster

As mentioned previously when discussing heartwood and sapwood, the sapwood color of most species is in the white

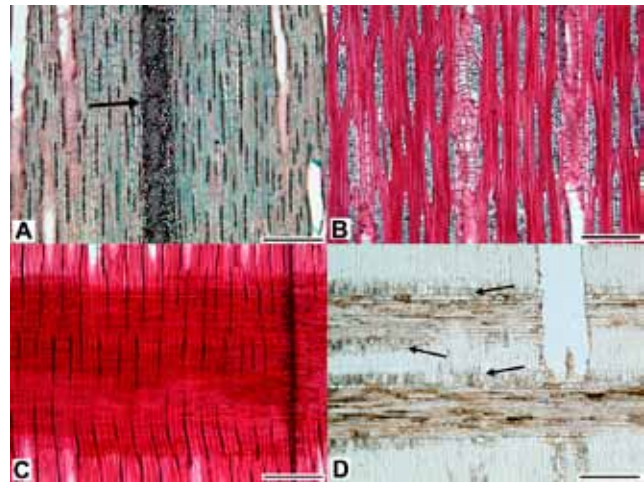

Figure 3–12. Rays in longitudinal sections. A and B show tangential sections, scale bars = 300 μm . A, *Quercus falcata* showing a wide multiseriate ray (arrow) and many uniseriate rays. B, *Swietenia macrophylla* showing numerous rays ranging from 1 to 4 cells wide; note that in this wood the rays are arranged roughly in rows from side to side. C and D show radial sections, scale bars = 200 μm . C, homocellular ray in *Tilia americana*; all cells in the ray are procumbent cells; they are longer radially than they are tall. D, two heterocellular rays in *Khaya ivorensis*; the central portion of the ray is composed of procumbent cells, but the margins of the ray, both top and bottom, have two rows of upright cells (arrows), which are as tall as or taller than they are wide.

range. The color of heartwood depends on the presence, characteristics, and concentrations of extractives in the wood. The heartwood color of a given species can vary greatly, depending on growth history and health of the tree, genetic differences between trees, and other factors. Heartwood formation, particularly as it relates to final timber color, is not fully understood. Description of color in wood is highly dependent on the particular author; assertions that a particular wood is exactly one color are spurious.

Luster is a somewhat subjective characteristic of some woods and refers to the way in which light reflecting from the wood appears to penetrate into and then shine from the surface of the board. Genuine mahogany (*Swietenia* sp.) is one of the better-known woods with distinct luster.

Grain and Texture

The terms grain and texture are commonly used rather loosely in connection with wood. Grain is often used in reference to the relative sizes and distributions of cells, as in fine grain and coarse grain; this use of grain is roughly synonymous with texture (below). Grain is also used to indicate the orientation of the cells of the axial system (“fiber direction”), as in “along the grain,” straight grain, spiral grain, and interlocked grain, and this use of the term is preferred. Grain, as a synonym for fiber direction, is discussed in detail relative to mechanical properties in Chapter 5.

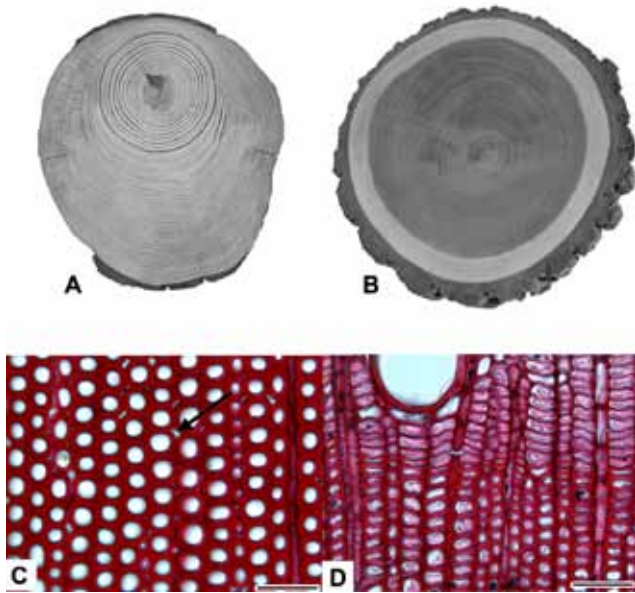

Figure 3–13. Macroscopic and microscopic views of reaction wood in a softwood and a hardwood. A, compression wood in *Pinus* sp.; note that the pith is not in the center of the trunk, and the growth rings are much wider in the compression wood zone. B, tension wood in *Juglans nigra*; the pith is nearly centered in the trunk, but the growth rings are wider in the tension wood zone. C, transverse section of compression wood in *Picea engelmannii*; the tracheids are thick-walled and round in outline, giving rise to prominent intercellular spaces in the cell corners (arrow). D, tension wood fibers showing prominent gelatinous layers in *Croton gossypifolius*; the gelatinous layers in the fibers are most pronounced across the top of the image on either side of and just below the vessel; the fibers in the lower half of the image show thinner gelatinous layers. Scale bars = 50 μ m.

Wood finishers refer to wood as open grained and close (or closed) grained, which are terms reflecting the relative size of the cells and the need for fillers prior to finishing. Texture is another word used to describe a macroscopic summary of the relative sizes of cells in wood. Fine-textured woods have uniform structure with typically small cells. Coarse-textured woods generally have structure with concentrations of large diameter cells (such as the earlywood in ring porous hardwoods, Fig. 3–5F) that produce areas of clearly different appearance to the naked eye. Even-textured woods may have uniformly large or small cells, but their distribution is not concentrated in particular areas, such as in diffuse porous hardwoods. Even if terms used for describing the appearance of wood were universally agreed upon (and they are not), variations in wood structure within a tree, between trees of the same species, and between two or more species would defy complete characterization using these terms. For this reason, when discussing wood, reference should be made to specific properties when possible. At a minimum, it is desirable to ensure that the same operating definitions of terms like “open grained” or “coarse textured” are used by all parties.

Plainsawn and Quartersawn

When boards are cut from logs, a sawyer makes decisions about how to orient to the log with respect to the saw blade and in this way produces boards with different cuts. Specific nomenclature for these angles of cutting exists but is not precisely the same for hardwood lumber and softwood lumber; this unfortunate fact results in a parallel set of terms for hardwoods and softwoods. The sawyer can cut boards from a log in two distinct ways: (a) tangential to the growth rings, producing flatsawn or plainsawn lumber in hardwoods and flatsawn or slash-grained lumber in softwoods, and (b) radially from the pith or parallel to the rays, producing quartersawn lumber in hardwoods and edge-grained or vertical-grained lumber in softwoods (Fig. 3–14). In plainsawn boards, the surfaces next to the edges are often far from tangential to the rings, and quartersawn lumber is not usually cut strictly parallel with the rays. In commercial practice, lumber with rings at angles of 0° to 45° to the wide surface is called plainsawn and lumber with rings at angles of 45° to 90° to the wide surface is called quartersawn. Hardwood lumber in which annual rings form angles of 30° to 60° to the wide face is sometimes called bastard sawn. For many purposes, either plainsawn or quartersawn lumber is satisfactory, but each type has certain advantages that can be important for a particular use. Some advantages of plainsawn and quartersawn lumber are given in Table 3–1.

Slope of Grain: Straight, Diagonal, Spiral, and Interlocked Grain

The slope of grain of a board is determined by the way in which the sawyer cuts the board and the basic biological characteristics of the log from which the board is cut, but it is distinct from the type of cut (plainsawn or quartersawn). In an idealized saw log, the cells of the axial system in the wood are parallel to the length of the log; they run straight up and down the trunk. When this is the case, the grain angle of a board cut from the log is wholly a function of how the sawyer cuts the board. It is assumed that when a board is cut from the log, the long edge of the board will be parallel (or nearly so) with the cells of the axial system, or parallel with the grain (middle of Fig. 3–3A, 3–3F). Boards prepared in this way are straight-grained boards. When the long edge of the board is not parallel with the grain, the board has what is called diagonal grain (middle of Fig. 3–3A, 3–3F). Boards with diagonal grain will show atypical shrinking and swelling with changes in moisture content (Chap. 4), and altered mechanical properties (Chap. 5) depending on the slope of grain. The degree to which the long edge of a board is not parallel to the grain is referred to as slope of grain and is addressed in Chapter 5.

Not all logs have grain that runs perfectly straight up and down the length of the log. In some logs, the grain runs in a helical manner up the trunk, like the stripes on a barber pole or the lines on a candy cane. Such logs produce boards with spiral grain, and there is no way to cut long boards from

Table 3–1. Some advantages of plainsawn and quartersawn lumber

Plainsawn	Quartersawn
Shrinks and swells less in thickness	Shrinks and swells less in width
Surface appearance less affected by round or oval knots compared to effect of spike knots in quartersawn boards; boards with round or oval knots not as weak as boards with spike knots	Cups, surface-checks, and splits less in seasoning and in use
Shakes and pitch pockets, when present, extend through fewer boards	Raised grain caused by separation in annual rings does not become as pronounced
Figure patterns resulting from annual rings and some other types of figure brought out more conspicuously	Figure patterns resulting from pronounced rays, interlocked grain, and wavy grain are brought out more conspicuously
Is less susceptible to collapse in drying	Does not allow liquids to pass through readily in some species
Costs less because it is easy to obtain	Holds paint better in some species
	Sapwood appears in boards at edges and its width is limited by the width of the log

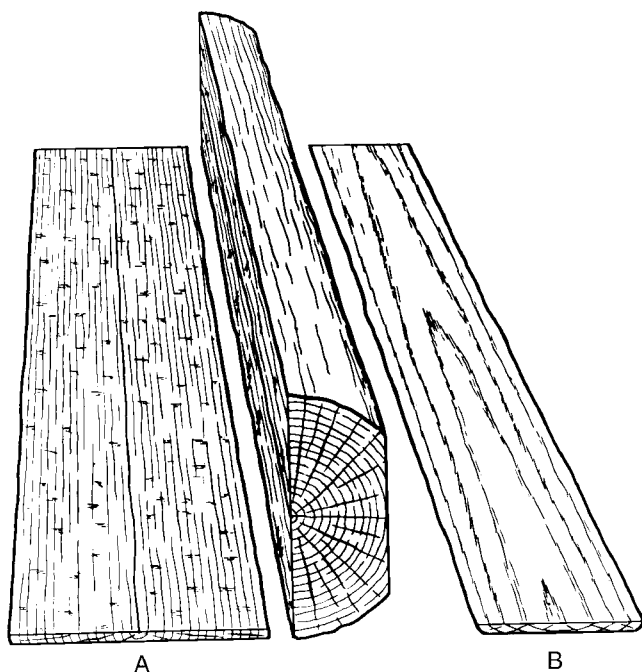
**Figure 3–14. Quartersawn (A) and plainsawn (B) boards cut from a log.**

such a log to produce straight-grained lumber. In other logs, the angle of helical growth of the wood cells will change over time, such that the grain may curve in a right-handed helix (e.g., 5°) for a few years and then over the course of a few years change to a left-handed 5° helix, and so on over the life of the tree. This growth produces wood with interlocked grain. There is no way to saw a board from such a log to produce uniformly straight grain. Therefore, a straight-grained board can be cut only from a straight-grained log; a log with spiral or interlocked grain can never produce truly straight-grained lumber, regardless of the skill of the sawyer.

Knots

Knots are remnants of branches in the tree appearing in a board. In a flat-sawn board, knots appear as round and typically brown pieces of wood perpendicular to the grain of the board. In a quartersawn board, knots can be cut along their length and are referred to as spike knots. Independent of the cut of the board, knots occur in two basic varieties: intergrown knots and encased knots. These terms refer to the continuity, or lack thereof, of stem wood with wood of the branch. If the branch was alive at the time when the growth rings making up the board were formed, the wood of the trunk of the tree and that branch is continuous; the growth rings continue uninterrupted out along the branch, forming an intergrown knot. If the branch was dead at the time when growth rings of the board were formed, the stem wood curves around the branch without continuing up the branch, giving rise to a knot that is not continuous with the stem wood; this produces an encased knot. With intergrown knots, the grain angle of the trunk wood in the vicinity of the knot is typically more disturbed than in encased knots, and this influences wood properties (Chap. 5). Encased knots generally disturb the grain angle less than intergrown knots.

Decorative Features

The decorative value of wood depends upon its color, figure, luster, and the way in which it bleaches or takes fillers, stains, and transparent finishes. In addition to quantifiable or explicable characteristics, decorative value is also determined by the individual preferences of the end user.

The structure of a given wood, in conjunction with how the final wood product was cut from a log, gives rise to the majority of the patterns seen in wood. A general term for the pattern of wood is figure, which can refer to mundane features, such as the appearance of growth rings in a plainsawn board or the appearance of ray fleck on a quartersawn board,

or more exotic patterns determined by anomalous growth, such as birdseye, wavy grain, or wood burls.

Wood Identification

The identification of wood can be of critical importance to the primary and secondary wood using industry, government agencies, museums, law enforcement, and scientists in the fields of botany, ecology, anthropology, forestry, and wood technology. Wood identification is the recognition of characteristic cell patterns and wood features and is generally accurate only to the generic level. Because woods of different species from the same genus often have different properties and perform differently under various conditions, serious problems can develop if species or genera are mixed during the manufacturing process and in use. Because foreign woods are imported to the U.S. market, both buyers and sellers must have access to correct identifications and information about properties and uses.

Lumber graders, furniture workers, those working in the industry, and hobbyists often identify wood without laboratory tools. Features often used are color, odor, grain patterns, density, and hardness. With experience, these features can be used to identify many different woods, but the accuracy of the identification is dependent on the experience of the person and the quality of the unknown wood. If the unknown wood specimen is atypical, decayed, or small, often the identification is incorrect. Examining woods, especially hardwoods, with a 10× to 20× hand lens, greatly improves the accuracy of the identification (Panshin and deZeeuw 1980, Hoadley 1990, Brunner and others 1994). Some foresters and wood technologists armed with a hand lens and sharp knife can accurately identify lumber in the field. They make a cut on the transverse surface and examine all patterns to make an identification.

Scientifically rigorous, accurate identifications require that the wood be sectioned and examined with a light microscope. With the light microscope, even with only a 10× objective, many more features are available for use in making a determination. Equally important as the light microscope in wood identification is the reference collection of correctly identified specimens to which unknown samples can be compared (Wheeler and Baas 1998). If a reference collection is not available, books of photomicrographs or books or journal articles with anatomical descriptions and dichotomous keys can be used (Miles 1978, Schweingruber 1978, Core and others 1979, Gregory 1980, Ilic 1991, Miller and Détienne 2001). In addition to these resources, several computer-assisted wood identification packages are available and are suitable for people with a robust wood anatomical background, such as the on-line searchable resource InsideWood (<http://insidewood.lib.ncsu.edu/>).

Wood identification by means of molecular biological techniques is a field that is still in its infancy. Substantial population-biological effects limit the statistical likelihood of a

robust and certain identification for routine work (Canadian Forest Service 1999). In highly limited cases of great financial or criminal import and a narrowly defined context, the cost and labor associated with rigorous evaluation of DNA from wood can be warranted (Hipkins 2001). For example, if the question were “Did this piece of wood come from this individual tree?” or “Of the 15 species present in this limited geographical area, which one produced this root?” it is feasible to analyze the specimens with molecular techniques (Brunner and others 2001). If, however, the question were “What kind of wood is this, and from which forest did it come?” it would not be feasible at this time to analyze the specimen. Workers have shown that specific identification can be accomplished using DNA among six species of Japanese white oak (Ohyama and others 2001), but the routine application of their methods is not likely for some time. As technological advances improve the quality, quantity, and speed with which molecular data can be collected, the difficulty and cost of molecular wood identification will decrease. We can reasonably expect that at some point in the future molecular tools will be employed in routine identification of wood and that such techniques will greatly increase the specificity and accuracy of identification. For now, routine scientific wood identification is based on microscopic evaluation of wood anatomical features.

Literature Cited

- Bowyer, J.; Shmulsky, R.; Haygreen, J.G. 2003. Forest products and wood science: an introduction. 4th ed. Iowa City, IA: Iowa State Press. 554 p.
- Brunner, I.; Brodbeck, S.; Buchler, U.; Sperisen, C. 2001. Molecular identification of fine roots from trees from the Alps: reliable and fast DNA extraction and PCR-RFLP analyses of plastid DNA. *Molecular Ecology*. 10: 2079–2087.
- Brunner, M.; Kucera, L.J.; Zürcher, E. 1994. Major timber trees of Guyana: a lens key. Tropenbos Series 10. Wageningen, The Netherlands: The Tropenbos Foundation. 224 p.
- Callado, C.H.; da Silva Neto, S.J.; Scarano, F.R.; Costa, C.G. 2001. Periodicity of growth rings in some flood-prone trees of the Atlantic rain forest in Rio de Janeiro, Brazil. *Trees* 15: 492–497.
- Canadian Forest Service, Pacific Forestry Centre. 1999. Combating tree theft using DNA technology. Breakout session consensus. Victoria, BC.
- Carlquist, S. 2001. *Comparative Wood Anatomy*. 2nd ed. Berlin: Springer. 448 p.
- Chudnoff, M. 1984. Tropical timbers of the world. *Agric. Handb.* 607. Madison, WI: U.S. Department of Agriculture, Forest Service, Forest Products Laboratory. 464 p.
- Core, H.A.; Côte, W.A.; Day, A.C. 1979. Wood structure and identification. 2nd ed. Syracuse, NY: Syracuse University Press. 182 p.

Chapter 3 Structure and Function of Wood

- Cutler, D.F.; Gregory, M. 1998. Anatomy of the dicotyledons. 2nd ed. New York: NY: Oxford University Press. 304 p. Vol. IV.
- DeMeijer, M.; Thurich, K.; Militz, H. 1998. Comparative study on penetration characteristics of modern wood coatings. *Wood Science and Technology*. 32: 347–365.
- Desch, H.E.; Dinwoodie, J.M. 1996. Timber structure, properties, conversion and use. 7th ed. London, UK: Macmillan Press. 306 p.
- Dickison, W. 2000. Integrative plant anatomy. New York, NY: Academic Press. 533 p.
- Esau, K. 1977. Anatomy of the seed plants. 2nd ed. New York, NY: John Wiley and Sons. 550 p.
- Gregory, M. 1980. Wood identification: an annotated bibliography. *IAWA Bull.* 1. ISSN: New Series. 1(1): 3–41.
- Gregory, M. 1994. Bibliography of systematic wood anatomy of dicotyledons. *IAWA Journal*. Supplement 1.
- Hillis, W.E. 1996. Formation of robinetin crystals in vessels of *Intsia* species. *IAWA Journal*. 17(4): 405–419.
- Hipkins, V. 2001. DNA profiling and identity analysis of ponderosa pine evidence samples. In: NFGEL Annual Report.
- Hoadley, R.B. 1990. Identifying wood: accurate results with simple tools. Newtown, CT: Taunton Press. 223 p.
- Hoadley, R.B. 2000. Understanding wood: a craftsman's guide to wood technology. 2nd ed. Newtown, CT: Taunton Press. 280 p.
- IAWA Committee. 1989. IAWA list of microscopic features for hardwood identification. In: Wheeler, E.A.; Baas, P.; Gasson, P., eds. *IAWA Bull.* 10. ISSN: New Series 10(3): 219–332.
- IAWA Committee. 2004. IAWA list of microscopic features of softwood identification. In: Richter, H.G.; Grosser, D.; Heinz, I.; Gasson, P., eds. *IAWA Journal*. 25(1): 1–70.
- Ilic, J. 1991. CSIRO atlas of hardwoods. Bathurst, Australia: Crawford House Press. 525 p.
- Kozlowski, T.T.; Pallardy, S.G. 1997. Physiology of woody plants. 2nd ed. San Diego, CA: Academic Press. Chapters 11, 12.
- Kretschmann, D.E.; Alden, H.A.; Verrill, S. 1998. Variations of microfibril angle in loblolly pine: comparison of iodine crystallization and X-ray diffraction techniques. In: Butterfield, B.G., ed. *Microfibril angle in wood*. New Zealand: University of Canterbury. 157–176.
- Kukachka, B.F. 1960. Identification of coniferous woods. *Tappi Journal*. 43(11): 887–896.
- Lagenheim, J.H. 2003. Plant resins: chemistry, evolution, ecology, and ethnobotany. Portland, OR: Timber Press. 448 p.
- Larson, P.R. 1994. The vascular cambium, development and structure. Berlin: Springer-Verlag. 725 p.
- Larson, P.R.; Kretschmann, D.E.; Clark, A., III; Isenbrands, J.G. 2001. Formation and properties of juvenile wood in southern pines: a synopsis. Gen. Tech. Rep. FPL–GTR–129. Madison, WI: U.S. Department of Agriculture, Forest Service, Forest Products Laboratory.
- Metcalfe, C.R.; Chalk, L. 1950. Anatomy of the Dicotyledons. Oxford, UK: Clarendon Press. 2 vols. 1,500 p.
- Metcalfe, C.R.; Chalk, L. 1979. Anatomy of the Dicotyledons. 2nd ed. New York: Oxford University Press. Vol. I. 276 p.
- Metcalfe, C.R.; Chalk, L. 1987. Anatomy of the Dicotyledons. 2nd ed. New York: Oxford University Press. Vol. III. 224 p.
- Miles, A. 1978. Photomicrographs of world woods. Building Research Establishment, Princes Risborough Laboratory; London: Her Majesty's Stationery Office. 233 p.
- Miller, R.B.; Détienne, P. 2001. Major timber trees of Guyana: wood anatomy. Tropenbos Series 20. Wageningen, The Netherlands: The Tropenbos Foundation. 218 p.
- Ohyama, M.; Baba, K.; Itoh, T. 2001. Wood identification of Japanese Cyclobalanopsis species (Fagaceae) based on DNA polymorphism of the intergenic spacer between trnT and trnL 5' exon. *Journal of Wood Science*. 47: 81–86.
- Panshin, A.J.; deZeeuw, C. 1980. Textbook of wood technology. 4th ed. New York: McGraw-Hill. 722 p.
- Phillips, E.W.J. 1948. Identification of softwoods by microscopic structure. *Forest Products Res. Bull.* 22.
- Raven, P.; Evert, R.; Eichhorn, S. 1999. Biology of plants. 6th ed. New York, NY: W.H. Freeman & Company. 944 p.
- Rijkaert, V.; Stevens, M.; de Meijer, M.; Militz, H. 2001. Quantitative assessment of the penetration of water-borne and solvent-borne wood coatings in Scots pine sapwood. *Holz als Roh-und Werkstoff*. 59: 278–287.
- Schweingruber, F. 1978. Microscopic wood anatomy. Birmensdorf: Swiss Federal Institute for Foreign Research. 800 p.
- Simpson, W.T., ed. 1991. Dry kiln operator's manual. Agric. Handb. AH-188. Madison, WI: U.S. Department of Agriculture, Forest Service, Forest Products Laboratory. 274 p.
- Taiz, L.; Zeiger, E. 1991. Plant physiology. Upper Saddle River, NJ: Benjamin-Cummings Publishing Company. Chapter 4.

- Timmel, T.E. 1986. Compression wood in gymnosperms. Heidelberg: Springer. 2,150 p.
- Wheeler, E.A.; Baas, P. 1998. Wood identification: a review. IAWA Journal. 19(3): 241–264.
- Wiedenhoef, A.C.; Miller, R.B. 2002. Brief comments on the nomenclature of softwood axial resin canals and their associated cells. IAWA Journal. 23(3): 299–303.
- Worbes, M. 1995. How to measure growth dynamics in tropical trees: a review. IAWA Journal. 16(4): 337–351.
- Worbes, M. 1999. Annual growth rings, rainfall-dependent growth and long-term growth patterns of tropical trees in the Capar Forest Reserve in Venezuela. Journal of Ecology. 87: 391–403.
- Zimmermann, M.H. 1983. Xylem structure and the ascent of sap. New York: Springer-Verlag. 143 p.

Moisture Relations and Physical Properties of Wood

Samuel V. Glass, Research Physical Scientist
Samuel L. Zelinka, Materials Research Engineer

Contents

Wood–Moisture Relationships 4–1
Moisture Content and Green Wood 4–1
Fiber Saturation and Maximum Moisture Content 4–2
Water Vapor Sorption 4–3
Liquid Water Absorption 4–4
Dimensional Stability 4–5
Density and Specific Gravity 4–7
Thermal Properties 4–10
Thermal Conductivity 4–10
Heat Capacity 4–11
Thermal Diffusivity 4–12
Coefficient of Thermal Expansion 4–14
Electrical Properties 4–15
DC Electrical Properties 4–15
AC Electrical Properties 4–16
Friction Properties 4–17
Nuclear Radiation Properties 4–17
Literature Cited 4–18
Additional References 4–19

Wood, like many natural materials, is hygroscopic; it takes on moisture from the surrounding environment. Moisture exchange between wood and air depends on the relative humidity and temperature of the air and the current amount of water in the wood. This moisture relationship has an important influence on wood properties and performance. Many of the challenges of using wood as an engineering material arise from changes in moisture content or an abundance of moisture within the wood.

This chapter discusses the macroscopic physical properties of wood with emphasis given to their relationship with moisture content. Some properties are species-dependent; in such cases, data from the literature are tabulated according to species. The chapter begins with a broad overview of wood–water relations, defining key concepts needed to understand the physical properties of wood.

Wood–Moisture Relationships

Moisture Content and Green Wood

Many physical and mechanical properties of wood depend upon the moisture content of wood. Moisture content (MC) is usually expressed as a percentage and can be calculated from

$$MC = \frac{m_{\text{water}}}{m_{\text{wood}}} (100\%) \quad (4-1)$$

where m_{water} is the mass of water in wood and m_{wood} is the mass of the oven-dry wood. Operationally, the moisture content of a given piece of wood can be calculated by

$$MC = \frac{m_{\text{wet}} - m_{\text{dry}}}{m_{\text{dry}}} (100\%) \quad (4-2)$$

where m_{wet} is the mass of the specimen at a given moisture content and m_{dry} is the mass of the oven-dry specimen.

Green wood is often defined as freshly sawn wood in which the cell walls are completely saturated with water and additional water may reside in the lumina. The moisture content of green wood can range from about 30% to more than 200%. In green softwoods, the moisture content of sapwood is usually greater than that of heartwood. In green hardwoods, the difference in moisture content between heartwood and sapwood depends on the species. The average moisture content of green heartwood and green sapwood of some domestic species is given in Table 4–1. These values

Table 4–1. Average moisture content of green wood, by species

Species	Moisture content (%)		Species	Moisture content (%)	
	Heartwood	Sapwood		Heartwood	Sapwood
Hardwoods			Softwoods		
Alder, red	—	97	Baldcypress	121	171
Apple	81	74	Cedar, eastern red	33	—
Ash, black	95	—	Cedar, incense	40	213
Ash, green	—	58	Cedar, Port-Orford	50	98
Ash, white	46	44	Cedar, western red	58	249
Aspen	95	113	Cedar, yellow	32	166
Basswood, American	81	133	Douglas-fir, coast type	37	115
Beech, American	55	72	Fir, balsam	88	173
Birch, paper	89	72	Fir, grand	91	136
Birch, sweet	75	70	Fir, noble	34	115
Birch, yellow	74	72	Fir, Pacific silver	55	164
Cherry, black	58	—	Fir, white	98	160
Chestnut, American	120	—	Hemlock, eastern	97	119
Cottonwood	162	146	Hemlock, western	85	170
Elm, American	95	92	Larch, western	54	119
Elm, cedar	66	61	Pine, loblolly	33	110
Elm, rock	44	57	Pine, lodgepole	41	120
Hackberry	61	65	Pine, longleaf	31	106
Hickory, bitternut	80	54	Pine, ponderosa	40	148
Hickory, mockernut	70	52	Pine, red	32	134
Hickory, pignut	71	49	Pine, shortleaf	32	122
Hickory, red	69	52	Pine, sugar	98	219
Hickory, sand	68	50	Pine, western white	62	148
Hickory, water	97	62	Redwood, old growth	86	210
Magnolia	80	104	Spruce, black	52	113
Maple, silver	58	97	Spruce, Engelmann	51	173
Maple, sugar	65	72	Spruce, Sitka	41	142
Oak, California black	76	75	Tamarack	49	—
Oak, northern red	80	69			
Oak, southern red	83	75			
Oak, water	81	81			
Oak, white	64	78			
Oak, willow	82	74			
Sweetgum	79	137			
Sycamore, American	114	130			
Tupelo, black	87	115			
Tupelo, swamp	101	108			
Tupelo, water	150	116			
Walnut, black	90	73			
Yellow-poplar	83	106			

are considered typical, but variation within and between trees is considerable. Variability of green moisture content exists even within individual boards cut from the same tree. Additional information on moisture in green lumber is given in Chapter 13.

Fiber Saturation and Maximum Moisture Content

Moisture can exist in wood as free water (liquid water or water vapor in cell lumina and cavities) or as bound water (held by intermolecular attraction within cell walls). The moisture content at which only the cell walls are completely saturated (all bound water) but no water exists in cell lumina

is called the fiber saturation point, MC_{fs} . Operationally, the fiber saturation point is considered as that moisture content above which the physical and mechanical properties of wood do not change as a function of moisture content. The fiber saturation point of wood averages about 30% moisture content, but in individual species and individual pieces of wood it can vary by several percentage points from that value.

Conceptually, fiber saturation distinguishes between the two ways water is held in wood. However, in actuality, a more gradual transition occurs between bound and free water near the fiber saturation point. Within a piece of wood, in

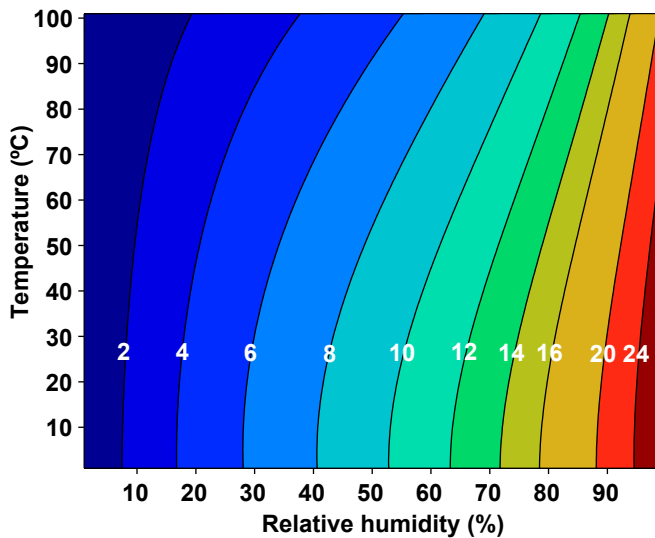

Figure 4-1. Equilibrium moisture content of wood (labeled contours) as a function of relative humidity and temperature.

one portion all cell lumina may be empty and the cell walls partially dried, while in another part of the same piece, cell walls may be saturated and lumina partially or completely filled with water. Even within a single cell, the cell wall may begin to dry before all water has left the lumen of that same cell.

The moisture content at which both cell lumina and cell walls are completely saturated with water is the maximum possible moisture content. Basic specific gravity G_b (based on oven-dry mass and green volume—see section on Density and Specific Gravity) is the major determinant of maximum moisture content. As basic specific gravity increases, the volume of the lumina must decrease because the specific gravity of wood cell walls is constant among species. This decreases the maximum moisture content because less room is available for free water. Maximum moisture content MC_{max} for any basic specific gravity can be estimated from

$$MC_{max} = 100(1.54 - G_b) / 1.54G_b \quad (4-3)$$

where the specific gravity of wood cell walls is taken as 1.54. Maximum possible moisture content varies from 267% at $G_b = 0.30$ to 44% at $G_b = 0.90$. Maximum possible moisture content is seldom attained in living trees. The moisture content at which wood will sink in water can be calculated by

$$MC_{sink} = 100(1 - G_b) / G_b \quad (4-4)$$

Water Vapor Sorption

When wood is protected from contact with liquid water and shaded from sunlight, its moisture content below the fiber

saturation point is a function of both relative humidity (RH) and temperature of the surrounding air. Wood in service is exposed to both long-term (seasonal) and short-term (daily) changes in relative humidity and temperature of the surrounding air, which induce changes in wood moisture content. These changes usually are gradual, and short-term fluctuations tend to influence only the wood surface. Moisture content changes can be retarded, but not prevented, by protective coatings such as varnish, lacquer, or paint (Chap. 16). The objective of wood drying is to bring the moisture content close to the expected value that a finished product will have in service (Chap. 13).

Equilibrium Moisture Content

Equilibrium moisture content (EMC) is defined as that moisture content at which the wood is neither gaining nor losing moisture. The relationship between EMC, relative humidity, and temperature is shown in Figure 4-1 and Table 4-2. For most practical purposes, the values in Table 4-2 may be applied to wood of any species. These values have been calculated from the following equation:

$$EMC(\%) = \frac{1,800}{W} \left[\frac{Kh}{1 - Kh} + \frac{K_1Kh + 2K_1K_2K^2h^2}{1 + K_1Kh + K_1K_2K^2h^2} \right] \quad (4-5)$$

where h is relative humidity (decimal) and the parameters W , K , K_1 , and K_2 depend on temperature:

For temperature T in $^{\circ}C$,

$$\begin{aligned} W &= 349 + 1.29T + 0.0135T^2 \\ K &= 0.805 + 0.000736T - 0.00000273T^2 \\ K_1 &= 6.27 - 0.00938T - 0.000303T^2 \\ K_2 &= 1.91 + 0.0407T - 0.000293T^2 \end{aligned}$$

For temperature T in $^{\circ}F$,

$$\begin{aligned} W &= 330 + 0.452T + 0.00415T^2 \\ K &= 0.791 + 0.000463T - 0.000000844T^2 \\ K_1 &= 6.34 + 0.000775T - 0.0000935T^2 \\ K_2 &= 1.09 + 0.0284T - 0.0000904T^2 \end{aligned}$$

Simpson (1973) showed that this equation provides a good fit to EMC–RH–temperature data.

Sorption Hysteresis

The relationship between EMC and relative humidity at constant temperature is referred to as a sorption isotherm. The history of a wood specimen also affects its EMC; this is called sorption hysteresis and is shown in Figure 4-2. A desorption isotherm is measured by bringing wood that was initially wet to equilibrium with successively lower values of relative humidity. A resorption, or adsorption, isotherm is measured in the opposite direction (from the dry state to successively higher RH values). As wood is dried from the initial green condition below the fiber saturation point (initial desorption), the EMC is greater than in subsequent desorption isotherms (Spalt 1958). Furthermore, the EMC

Table 4–2. Moisture content of wood in equilibrium with stated temperature and relative humidity

Temperature		Moisture content (%) at various relative humidity values																		
(°C	(°F))	5%	10%	15%	20%	25%	30%	35%	40%	45%	50%	55%	60%	65%	70%	75%	80%	85%	90%	95%
–1.1	(30)	1.4	2.6	3.7	4.6	5.5	6.3	7.1	7.9	8.7	9.5	10.4	11.3	12.4	13.5	14.9	16.5	18.5	21.0	24.3
4.4	(40)	1.4	2.6	3.7	4.6	5.5	6.3	7.1	7.9	8.7	9.5	10.4	11.3	12.3	13.5	14.9	16.5	18.5	21.0	24.3
10.0	(50)	1.4	2.6	3.6	4.6	5.5	6.3	7.1	7.9	8.7	9.5	10.3	11.2	12.3	13.4	14.8	16.4	18.4	20.9	24.3
15.6	(60)	1.3	2.5	3.6	4.6	5.4	6.2	7.0	7.8	8.6	9.4	10.2	11.1	12.1	13.3	14.6	16.2	18.2	20.7	24.1
21.1	(70)	1.3	2.5	3.5	4.5	5.4	6.2	6.9	7.7	8.5	9.2	10.1	11.0	12.0	13.1	14.4	16.0	17.9	20.5	23.9
26.7	(80)	1.3	2.4	3.5	4.4	5.3	6.1	6.8	7.6	8.3	9.1	9.9	10.8	11.7	12.9	14.2	15.7	17.7	20.2	23.6
32.2	(90)	1.2	2.3	3.4	4.3	5.1	5.9	6.7	7.4	8.1	8.9	9.7	10.5	11.5	12.6	13.9	15.4	17.3	19.8	23.3
37.8	(100)	1.2	2.3	3.3	4.2	5.0	5.8	6.5	7.2	7.9	8.7	9.5	10.3	11.2	12.3	13.6	15.1	17.0	19.5	22.9
43.3	(110)	1.1	2.2	3.2	4.0	4.9	5.6	6.3	7.0	7.7	8.4	9.2	10.0	11.0	12.0	13.2	14.7	16.6	19.1	22.4
48.9	(120)	1.1	2.1	3.0	3.9	4.7	5.4	6.1	6.8	7.5	8.2	8.9	9.7	10.6	11.7	12.9	14.4	16.2	18.6	22.0
54.4	(130)	1.0	2.0	2.9	3.7	4.5	5.2	5.9	6.6	7.2	7.9	8.7	9.4	10.3	11.3	12.5	14.0	15.8	18.2	21.5
60.0	(140)	0.9	1.9	2.8	3.6	4.3	5.0	5.7	6.3	7.0	7.7	8.4	9.1	10.0	11.0	12.1	13.6	15.3	17.7	21.0
65.6	(150)	0.9	1.8	2.6	3.4	4.1	4.8	5.5	6.1	6.7	7.4	8.1	8.8	9.7	10.6	11.8	13.1	14.9	17.2	20.4
71.1	(160)	0.8	1.6	2.4	3.2	3.9	4.6	5.2	5.8	6.4	7.1	7.8	8.5	9.3	10.3	11.4	12.7	14.4	16.7	19.9
76.7	(170)	0.7	1.5	2.3	3.0	3.7	4.3	4.9	5.6	6.2	6.8	7.4	8.2	9.0	9.9	11.0	12.3	14.0	16.2	19.3
82.2	(180)	0.7	1.4	2.1	2.8	3.5	4.1	4.7	5.3	5.9	6.5	7.1	7.8	8.6	9.5	10.5	11.8	13.5	15.7	18.7
87.8	(190)	0.6	1.3	1.9	2.6	3.2	3.8	4.4	5.0	5.5	6.1	6.8	7.5	8.2	9.1	10.1	11.4	13.0	15.1	18.1
93.3	(200)	0.5	1.1	1.7	2.4	3.0	3.5	4.1	4.6	5.2	5.8	6.4	7.1	7.8	8.7	9.7	10.9	12.5	14.6	17.5
98.9	(210)	0.5	1.0	1.6	2.1	2.7	3.2	3.8	4.3	4.9	5.4	6.0	6.7	7.4	8.3	9.2	10.4	12.0	14.0	16.9
104.4	(220)	0.4	0.9	1.4	1.9	2.4	2.9	3.4	3.9	4.5	5.0	5.6	6.3	7.0	7.8	8.8	9.9			
110.0	(230)	0.3	0.8	1.2	1.6	2.1	2.6	3.1	3.6	4.2	4.7	5.3	6.0	6.7						
115.6	(240)	0.3	0.6	0.9	1.3	1.7	2.1	2.6	3.1	3.5	4.1	4.6								
121.1	(250)	0.2	0.4	0.7	1.0	1.3	1.7	2.1	2.5	2.9										
126.7	(260)	0.2	0.3	0.5	0.7	0.9	1.1	1.4												
132.2	(270)	0.1	0.1	0.2	0.3	0.4	0.4													

for resorption (adsorption) is lower than for desorption. The ratio of adsorption EMC to desorption EMC varies with species, RH, and temperature, with a mean value of about 0.8 near room temperature (Stamm 1964, Skaar 1988). EMC values in Table 4–2 were derived primarily for Sitka spruce under conditions described as oscillating vapor pressure desorption (Stamm and Loughborough 1935), which was shown to represent a condition midway between adsorption and desorption. The tabulated EMC values thus provide a suitable and practical compromise for use when the direction of sorption is not always known.

Liquid Water Absorption

Wood products in service may be exposed to liquid water through a variety of mechanisms. Contact with liquid water can induce rapid changes in the moisture content of wood, in contrast to the slow changes that occur due to water vapor sorption. In addition, liquid water absorption can bring the moisture content of wood above fiber saturation (water vapor sorption alone cannot). As wood absorbs water above its fiber saturation point, air in the cell lumina is replaced by water. Absorption of liquid water may continue until the maximum moisture content is reached.

The mechanism of water absorption is called capillary action or wicking. Water interacts strongly with the wood cell wall and forms a concave meniscus (curved surface) within the lumen. This interaction combined with the water–air

surface tension creates a pressure that draws water up the lumina.

The rate of liquid water absorption in wood depends on several factors. The rate of absorption is most rapid in the longitudinal direction (that is, when the transverse section or end grain is exposed to water). The rate at which air can escape from wood affects water absorption, as water displaces air in the lumina. Chapter 16 discusses the ability of surface finishes such as water repellents to inhibit water absorption.

International Standard ISO 15148 (ISO 2002) describes a method for measuring the rate of water absorption. One surface of a specimen is partially immersed in water. To limit absorption to this one surface and restrict moisture transport to one dimension, the sides of the specimen are coated with a water- and vapor-tight sealant. The specimen is periodically removed, surfaces are blotted, and the specimen is weighed and again partially immersed in the water. The mass of water absorbed per unit area of specimen surface is plotted against the square root of time. The initial part of the curve is usually linear, and the slope of this linear portion is the water absorption coefficient A_w ($\text{kg m}^{-2} \text{s}^{-1/2}$). Measured values of A_w for softwoods are in the range 10–16 $\text{g m}^{-2} \text{s}^{-1/2}$ in the longitudinal direction and 1–7 $\text{g m}^{-2} \text{s}^{-1/2}$ in the transverse directions (IEA 1991; Kumaran 1999, 2002).

The liquid water diffusivity D_w ($\text{m}^2 \text{s}^{-1}$) is a measure of the rate of moisture flow ($\text{kg m}^{-2} \text{s}^{-1}$) through a material

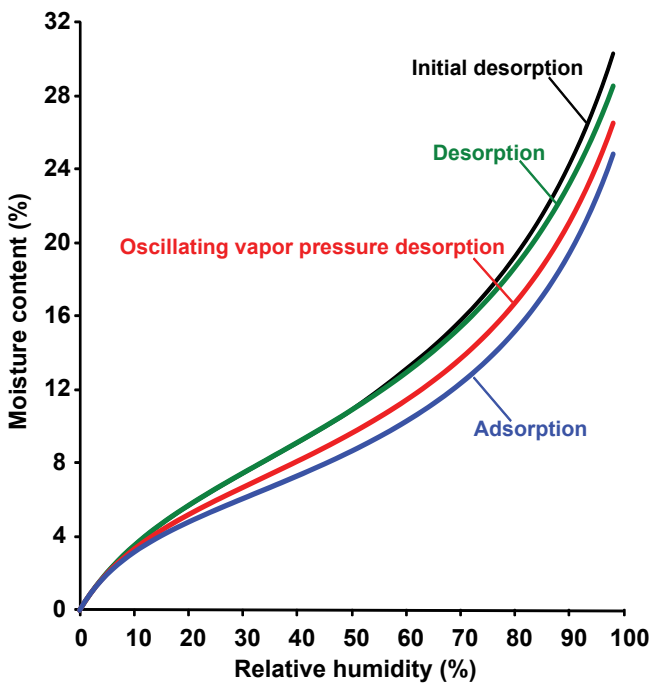

Figure 4–2. Moisture content–relative humidity relationship for wood under adsorption and various desorption conditions.

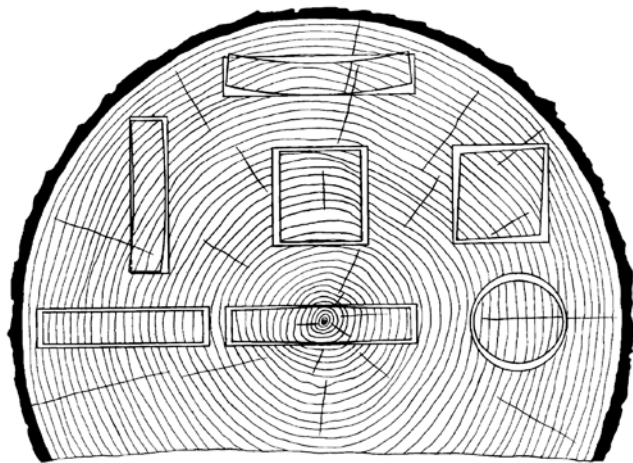

Figure 4–3. Characteristic shrinkage and distortion of flat, square, and round pieces as affected by direction of growth rings. Tangential shrinkage is about twice as great as radial.

subjected to unit difference in moisture concentration (kg m^{-3}) across unit thickness (m). An order-of-magnitude estimate of D_w can be made using the value of A_w as

$$D_w \approx \left(\frac{A_w}{c_{\text{sat}}} \right)^2 \quad (4-6)$$

where c_{sat} is the moisture concentration (kg m^{-3}) in water-saturated wood (Kumaran 1999).

Dimensional Stability

Wood is dimensionally stable when moisture content is greater than the fiber saturation point. Below MC_{fs} wood changes dimension as it gains moisture (swells) or loses moisture (shrinks), because volume of the cell wall depends on the amount of bound water. This shrinking and swelling can result in warping, checking, and splitting of the wood, which in turn can lead to decreased utility of wood products, such as loosening of tool handles, gaps in flooring, or other performance problems. Therefore, it is important that the dimensional stability be understood and considered when a wood product will be exposed to large moisture fluctuations in service.

With respect to dimensional stability, wood is an anisotropic material. It shrinks (swells) most in the direction of the annual growth rings (tangentially), about half as much across the rings (radially), and only slightly along the grain (longitudinally). The combined effects of radial and tangential shrinkage can distort the shape of wood pieces because of the difference in shrinkage and the curvature of annual rings. The major types of distortion as a result of these effects are illustrated in Figure 4–3.

Transverse and Volumetric Shrinkage

Data have been collected to represent the average radial, tangential, and volumetric shrinkage of numerous domestic species by methods described in American Society for Testing and Materials (ASTM) D 143—Standard Test Methods for Small Clear Specimens of Timber (ASTM 2007). Shrinkage values, expressed as a percentage of the green dimension, are listed in Table 4–3. Shrinkage values collected from the world literature for selected imported species are listed in Table 4–4.

The shrinkage of wood is affected by a number of variables. In general, greater shrinkage is associated with greater density. The size and shape of a piece of wood can affect shrinkage, and the rate of drying can affect shrinkage for some species. Transverse and volumetric shrinkage variability can be expressed by a coefficient of variation of approximately 15% (Markwardt and Wilson 1935).

Longitudinal Shrinkage

Longitudinal shrinkage of wood (shrinkage parallel to the grain) is generally quite small. Average values for shrinkage from green to oven-dry are between 0.1% and 0.2% for most species of wood. However, certain types of wood exhibit excessive longitudinal shrinkage, and these should be avoided in uses where longitudinal stability is important. Reaction wood, whether compression wood in softwoods or tension wood in hardwoods, tends to shrink excessively parallel to the grain. Wood from near the center of trees (juvenile wood) of some species also shrinks excessively lengthwise. Reaction wood and juvenile wood can shrink 2% from green

Table 4–3. Shrinkage values of domestic woods

Species	Shrinkage ^a (%) from green to oven-dry moisture content			Species	Shrinkage ^a (%) from green to oven-dry moisture content		
	Radial	Tangential	Volumetric		Radial	Tangential	Volumetric
Hardwoods				Oak, white—con.			
Alder, red	4.4	7.3	12.6	Chestnut	5.3	10.8	16.4
Ash				Live	6.6	9.5	14.7
Black	5.0	7.8	15.2	Overcup	5.3	12.7	16.0
Blue	3.9	6.5	11.7	Post	5.4	9.8	16.2
Green	4.6	7.1	12.5	Swamp, chestnut	5.2	10.8	16.4
Oregon	4.1	8.1	13.2	White	5.6	10.5	16.3
Pumpkin	3.7	6.3	12.0	Persimmon, common	7.9	11.2	19.1
White	4.9	7.8	13.3	Sassafras	4.0	6.2	10.3
Aspen				Sweetgum	5.3	10.2	15.8
Bigtooth	3.3	7.9	11.8	Sycamore, American	5.0	8.4	14.1
Quaking	3.5	6.7	11.5	Tanoak	4.9	11.7	17.3
Basswood, American	6.6	9.3	15.8	Tupelo			
Beech, American	5.5	11.9	17.2	Black	5.1	8.7	14.4
Birch				Water	4.2	7.6	12.5
Alaska paper	6.5	9.9	16.7	Walnut, black	5.5	7.8	12.8
Gray	5.2	—	14.7	Willow, black	3.3	8.7	13.9
Paper	6.3	8.6	16.2	Yellow-poplar	4.6	8.2	12.7
River	4.7	9.2	13.5	Softwoods			
Sweet	6.5	9.0	15.6	Cedar			
Yellow	7.3	9.5	16.8	Yellow	2.8	6.0	9.2
Buckeye, yellow	3.6	8.1	12.5	Atlantic white	2.9	5.4	8.8
Butternut	3.4	6.4	10.6	Eastern redcedar	3.1	4.7	7.8
Cherry, black	3.7	7.1	11.5	Incense	3.3	5.2	7.7
Chestnut, American	3.4	6.7	11.6	Northern white	2.2	4.9	7.2
Cottonwood				Port-Orford	4.6	6.9	10.1
Balsam poplar	3.0	7.1	10.5	Western redcedar	2.4	5.0	6.8
Black	3.6	8.6	12.4	Douglas-fir,			
Eastern	3.9	9.2	13.9	Coast ^b	4.8	7.6	12.4
Elm				Interior north ^b	3.8	6.9	10.7
American	4.2	9.5	14.6	Interior west ^b	4.8	7.5	11.8
Cedar	4.7	10.2	15.4	Fir			
Rock	4.8	8.1	14.9	Balsam	2.9	6.9	11.2
Slippery	4.9	8.9	13.8	California red	4.5	7.9	11.4
Winged	5.3	11.6	17.7	Grand	3.4	7.5	11.0
Hackberry	4.8	8.9	13.8	Noble	4.3	8.3	12.4
Hickory, pecan	4.9	8.9	13.6	Pacific silver	4.4	9.2	13.0
Hickory, true				Subalpine	2.6	7.4	9.4
Mockernut	7.7	11.0	17.8	White	3.3	7.0	9.8
Pignut	7.2	11.5	17.9	Hemlock			
Shagbark	7.0	10.5	16.7	Eastern	3.0	6.8	9.7
Shellbark	7.6	12.6	19.2	Mountain	4.4	7.1	11.1
Holly, American	4.8	9.9	16.9	Western	4.2	7.8	12.4
Honeylocust	4.2	6.6	10.8	Larch, western	4.5	9.1	14.0
Locust, black	4.6	7.2	10.2	Pine			
Madrone, Pacific	5.6	12.4	18.1	Eastern white	2.1	6.1	8.2
Magnolia				Jack	3.7	6.6	10.3
Cucumbertree	5.2	8.8	13.6	Loblolly	4.8	7.4	12.3
Southern	5.4	6.6	12.3	Lodgepole	4.3	6.7	11.1
Sweetbay	4.7	8.3	12.9	Longleaf	5.1	7.5	12.2
Maple				Pitch	4.0	7.1	10.9
Bigleaf	3.7	7.1	11.6	Pond	5.1	7.1	11.2
Black	4.8	9.3	14.0	Ponderosa	3.9	6.2	9.7
Red	4.0	8.2	12.6	Red	3.8	7.2	11.3
Silver	3.0	7.2	12.0	Shortleaf	4.6	7.7	12.3
Striped	3.2	8.6	12.3	Slash	5.4	7.6	12.1
Sugar	4.8	9.9	14.7	Sugar	2.9	5.6	7.9
Oak, red				Virginia	4.2	7.2	11.9
Black	4.4	11.1	15.1	Western white	4.1	7.4	11.8
Laurel	4.0	9.9	19.0	Redwood			
Northern red	4.0	8.6	13.7	Old growth	2.6	4.4	6.8
Pin	4.3	9.5	14.5	Young growth	2.2	4.9	7.0
Scarlet	4.4	10.8	14.7	Spruce			
Southern red	4.7	11.3	16.1	Black	4.1	6.8	11.3
Water	4.4	9.8	16.1	Engelmann	3.8	7.1	11.0
Willow	5.0	9.6	18.9	Red	3.8	7.8	11.8
Oak, white				Sitka	4.3	7.5	11.5
Bur	4.4	8.8	12.7	Tamarack	3.7	7.4	13.6

^aExpressed as a percentage of the green dimension.

^bCoast type Douglas-fir is defined as Douglas-fir growing in the States of Oregon and Washington west of the summit of the Cascade Mountains. Interior West includes the State of California and all counties in Oregon and Washington east of but adjacent to the Cascade summit. Interior North includes the remainder of Oregon and Washington and the States of Idaho, Montana, and Wyoming.

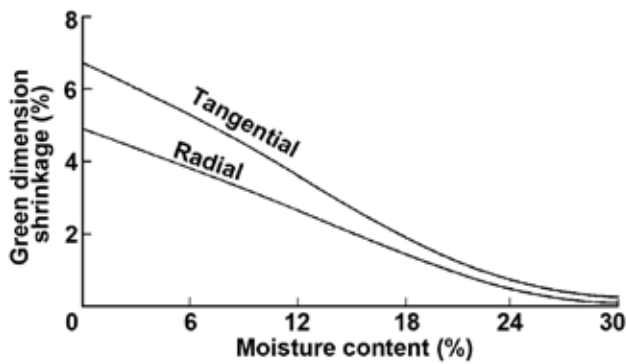

Figure 4-4. Typical moisture content–shrinkage curves.

to oven-dry. Wood with cross grain exhibits increased shrinkage along the longitudinal axis of the piece.

Reaction wood exhibiting excessive longitudinal shrinkage can occur in the same board with normal wood. The presence of this type of wood, as well as cross grain, can cause serious warping, such as bow, crook, or twist, and cross breaks can develop in the zones of high shrinkage.

Relationship between Moisture Content and Shrinkage

For a sufficiently small piece of wood without moisture gradients, shrinkage normally begins at about the fiber saturation point and continues in a fairly linear manner until the wood is completely dry. However, in the normal drying of lumber or other large pieces, the surface of the wood dries first, causing a moisture gradient. When the surface MC drops below the fiber saturation point, it begins to shrink even though the interior can still be quite wet and not shrink. Because of moisture gradients, shrinkage of lumber can occur even when the average moisture content of the entire piece of lumber is above fiber saturation. With moisture gradients, the moisture content–shrinkage relationship is not linear but rather looks similar to the one in Figure 4-4. The exact form of the shrinkage curve with moisture gradients depends on several variables, principally size and shape of the piece, species of wood, and drying conditions used.

Considerable variation in shrinkage occurs for any species. Tangential shrinkage data for Douglas-fir boards, 22 by 140 mm (7/8 by 5-1/2 in.) in cross section, are given in Figure 4-5 (Comstock 1965). The material was grown in one locality and dried under mild conditions from green to near equilibrium at 32 °C (90 °F) and two different humidity conditions: (1) 60–65% RH and (2) 30% RH. The figure shows that accurately predicting the shrinkage of an individual piece of wood is impossible; however, the average shrinkage of a quantity of pieces can be predicted accurately.

Average shrinkage data in Tables 4-3 and 4-4 can be used to estimate shrinkage for a particular species if a great deal

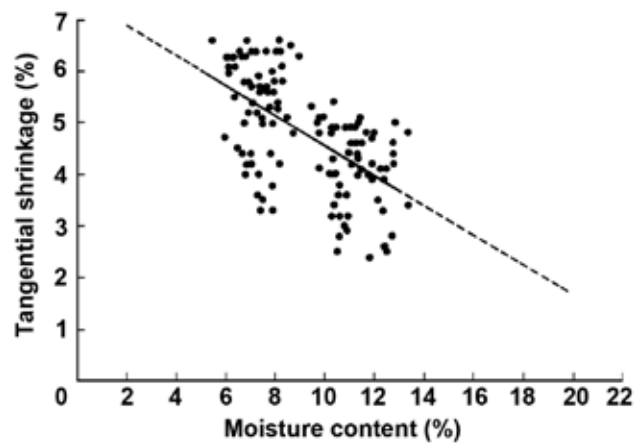

Figure 4-5. Variation in individual tangential shrinkage values of several Douglas-fir boards from one locality, dried from green condition.

of accuracy is not required. The following assumptions are made: (1) shrinkage begins at the fiber saturation point MC_{fs} , and (2) dimensions decrease linearly with decreasing moisture content. The percent shrinkage S_x from the green condition to final moisture content x can be calculated from

$$S_x = S_0 \left(1 - \frac{x}{MC_{fs}} \right) \quad (4-7)$$

where S_0 is percent shrinkage from the green condition to oven-dry (radial, tangential, or volumetric) from Table 4-3 or 4-4. If MC_{fs} is not known, 30% MC can be used as an approximation. Tangential values for S_0 should be used for estimating width shrinkage of plainsawn material and radial values for quartersawn material. For mixed or unknown ring orientations, tangential values are suggested. Shrinkage values for individual pieces will vary from predicted shrinkage values. As noted previously, shrinkage variability is characterized by a coefficient of variation of approximately 15%. This applies to pure tangential or radial ring orientation and is probably somewhat greater in commercial lumber, where ring orientation is seldom aligned perfectly parallel or perpendicular to board faces. Chapter 13 contains additional discussion of shrinkage–moisture content relationships, including a method to estimate shrinkage for the relatively small moisture content changes of wood in service. Shrinkage assumptions for commercial lumber, which typically is not perfectly plainsawn or quartersawn, are discussed in Chapter 7.

Density and Specific Gravity

The density ρ of a substance is defined as the ratio of its mass to its volume and is expressed in the international system (SI) in units of kilograms per cubic meter (kg m^{-3}), in the inch–pound system (I-P) in units of pounds per cubic foot (lb ft^{-3}), or in the centimeter–gram–second system (CGS) in units of grams per cubic centimeter (g cm^{-3}). The

Table 4–4. Shrinkage values of some woods imported into the United States^a

Species	Shrinkage ^b from green to oven-dry moisture content (%)				Species	Shrinkage ^b from green to oven-dry moisture content (%)			
	Radial	Tan- gential	Volu- metric	Loca- tion ^c		Radial	Tan- gential	Volu- metric	Loca- tion ^c
Afromosia (<i>Pericopsis elata</i>)	3.0	6.4	10.7	AF	Lauan, white (<i>Pentacme contorta</i>)	4.0	7.7	11.7	AS
Albarco (<i>Cariniana</i> spp.)	2.8	5.4	9.0	AM	Limba (<i>Terminalia superba</i>)	4.5	6.2	10.8	AF
Andiroba (<i>Carapa guianensis</i>)	3.1	7.6	10.4	AM	Macawood (<i>Platymiscium</i> spp.)	2.7	3.5	6.5	AM
Angelin (<i>Andira inermis</i>)	4.6	9.8	12.5	AM	Mahogany, African (<i>Khaya</i> spp.)	2.5	4.5	8.8	AF
Angelique (<i>Dicorynia guianensis</i>)	5.2	8.8	14.0	AM	Mahogany, true (<i>Swietenia macrophylla</i>)	3.0	4.1	7.8	AM
Apitong (<i>Dipterocarpus</i> spp.)	5.2	10.9	16.1	AS	Manbarklak (<i>Eschweilera</i> spp.)	5.8	10.3	15.9	AM
Avodire (<i>Turreanthus africanus</i>)	4.6	6.7	12.0	AF	Manni (<i>Symphonia globulifera</i>)	5.7	9.7	15.6	AM
Azobe (<i>Lophira alata</i>)	8.4	11.0	17.0	AM	Marishballi (<i>Licania</i> spp.)	7.5	11.7	17.2	AM
Balata (<i>Manilkara bidentata</i>)	6.3	9.4	16.9	AM	Meranti, white (<i>Shorea</i> spp.)	3.0	6.6	7.7	AS
Balsa (<i>Ochroma pyramidale</i>)	3.0	7.6	10.8	AM	Meranti, yellow (<i>Shorea</i> spp.)	3.4	8.0	10.4	AS
Banak (<i>Virola</i> spp.)	4.6	8.8	13.7	AM	Merbau (<i>Intsia bijuga</i> and <i>I. palembanica</i>)	2.7	4.6	7.8	AS
Benge (<i>Guibourtia arnoldiana</i>)	5.2	8.6	13.8	AF	Mersawa (<i>Anisoptera</i> spp.)	4.0	9.0	14.6	AS
Bubinga (<i>Guibourtia</i> spp.)	5.8	8.4	14.2	AF	Mora (<i>Mora</i> spp.)	6.9	9.8	18.8	AM
Bulletwood (<i>Manilkara bidentata</i>)	6.3	9.4	16.9	AM	Obeche (<i>Triplochiton scleroxylon</i>)	3.0	5.4	9.2	AF
Caribbean pine (<i>Pinus caribaea</i>)	6.3	7.8	12.9	AM	Ocota pine (<i>Pinus oocarpa</i>)	4.6	7.5	12.3	AM
Cativo (<i>Prioria copaifera</i>)	2.4	5.3	8.9	AM	Okoume (<i>Aucoumea klaineana</i>)	4.1	6.1	11.3	AF
Ceiba (<i>Ceiba pentandra</i>)	2.1	4.1	10.4	AM	Opepe (<i>Nauclea</i> spp.)	4.5	8.4	12.6	AF
Cocobolo (<i>Dalbergia retusa</i>)	2.7	4.3	7.0	AM	Ovangkol (<i>Guibourta ehie</i>)	4.5	8.2	12	AF
Courbaril (<i>Hymenaea courbaril</i>)	4.5	8.5	12.7	AM	Para-angelium (<i>Hymenolobium excelsum</i>)	4.4	7.1	10.2	AM
Cuangare (<i>Dialyanthera</i> spp.)	4.2	9.4	12.0	AM	Parana pine (<i>Araucaria angustifolia</i>)	4.0	7.9	11.6	AS
Degame (<i>Calycohyllum candidissimum</i>)	4.8	8.6	13.2	AM	Pau Marfim (<i>Balfourodendron riedelianum</i>)	4.6	8.8	13.4	AM
Determa (<i>Ocotea rubra</i>)	3.7	7.6	10.4	AM	Peroba de campos (<i>Paratecoma peroba</i>)	3.8	6.6	10.5	AM
Ebony, East Indian (<i>Diospyros</i> spp.)	5.4	8.8	14.2	AS	Peroba Rosa (<i>Aspidosperma</i> spp.)	3.8	6.4	11.6	AM
Ebony, African (<i>Diospyros</i> spp.)	9.2	10.8	20.0	AF	Piquia (<i>Caryocarpus</i> spp.)	5.0	8.0	13.0	AM
Ekop (<i>Tetraberlinia tubmaniana</i>)	5.6	10.2	15.8	AF	Pilon (<i>Hyeronima</i> spp.)	5.4	11.7	17.0	AM
Gmelina (<i>Gmelina arborea</i>)	2.4	4.9	8.8	AS	Primavera (<i>Cybistax donnell-smithii</i>)	3.1	5.1	9.1	AM
Goncalo alves (<i>Astronium graveolens</i>)	4.0	7.6	10.0	AM	Purpleheart (<i>Peltogyne</i> spp.)	3.2	6.1	9.9	AM
Greenheart (<i>Ocotea rodiaei</i>)	8.8	9.6	17.1	AM	Ramin (<i>Gonystylus</i> spp.)	4.3	8.7	13.4	AS
Hura (<i>Hura crepitans</i>)	2.7	4.5	7.3	AM	Roble (<i>Quercus</i> spp.)	6.4	11.7	18.5	AM
Ilomba (<i>Pycnanthus angolensis</i>)	4.6	8.4	12.8	AF	Roble (<i>Tabebuia</i> spp. Roble group)	3.6	6.1	9.5	AM
Imbuia (<i>Phoebe porosa</i>)	2.7	6.0	9.0	AM	Rosewood, Brazilian (<i>Dalbergia nigra</i>)	2.9	4.6	8.5	AM
Ipe (<i>Tabebuia</i> spp.)	6.6	8.0	13.2	AM	Rosewood, Indian (<i>Dalbergia latifolia</i>)	2.7	5.8	8.5	AS
Iroko (<i>Chlorophora excelsa</i> and <i>C. regia</i>)	2.8	3.8	8.8	AF	Rubberwood (<i>Hevea brasiliensis</i>)	2.3	5.1	7.4	AM
Jarra (<i>Eucalyptus marginata</i>)	7.7	11.0	18.7	AS	Sande (<i>Brosimum</i> spp. Utile group)	4.6	8.0	13.6	AM
Jelutong (<i>Dyera costulata</i>)	2.3	5.5	7.8	AS	Sapele (<i>Entandrophragma cylindricum</i>)	4.6	7.4	14.0	AF
Kaneelhart (<i>Licaria</i> spp.)	5.4	7.9	12.5	AM	Sepetir (<i>Pseudosindora</i> spp. and <i>Sindora</i> spp.)	3.7	7.0	10.5	AS
Kapur (<i>Dryobalanops</i> spp.)	4.6	10.2	14.8	AS	Spanish-cedar (<i>Cedrela</i> spp.)	4.2	6.3	10.3	AM
Karri (<i>Eucalyptus diversicolor</i>)	7.8	12.4	20.2	AS	Sucupira (<i>Diplotropis purpurea</i>)	4.6	7.0	11.8	AM
Kempas (<i>Koompassia malaccensis</i>)	6.0	7.4	14.5	AS	Teak (<i>Tectona grandis</i>)	2.5	5.8	7.0	AS
Keruing (<i>Dipterocarpus</i> spp.)	5.2	10.9	16.1	AS	Wallaba (<i>Eperua</i> spp.)	3.6	6.9	10.0	AM
Lauan, light red and red (<i>Shorea</i> spp.)	4.6	8.5	14.3	AS					
Lauan, dark red (<i>Shorea</i> spp.)	3.8	7.9	13.1	AS					

^aShrinkage values were obtained from world literature and may not represent a true species average.

^bExpressed as a percentage of the green dimension.

^cAF is Africa; AM is Tropical America; AS is Asia and Oceania.

Table 4–5. Expressions for specific gravity and density of wood^a

Symbol	Mass basis	Volume basis
G_0	Ovendry	Ovendry
G_b (basic specific gravity)	Ovendry	Green
G_{12}	Ovendry	12% MC
G_x	Ovendry	$x\%$ MC
ρ_0	Ovendry	Ovendry
ρ_{12}	12% MC	12% MC
ρ_x	$x\%$ MC	$x\%$ MC

^a x is any chosen moisture content.

CGS system is convenient because of its relationship to specific gravity (also known as relative density). Specific gravity G is defined as the ratio of the density of a substance to the density of water ρ_w at a specified reference temperature, typically 4 °C (39 °F), where ρ_w is 1.000 g cm⁻³ (1,000 kg m⁻³ or 62.43 lb ft⁻³). Therefore, a material with a density of 5 g cm⁻³ has a specific gravity of 5.

At constant temperature, the density of materials that do not adsorb moisture is constant. For example, at room temperature the densities of steel, aluminum, and lead are 7.8, 2.7, and 11.3 g cm⁻³, respectively. For materials that adsorb moisture but do not change volume, such as stone and brick, the density depends upon moisture content. For these materials, the density can be calculated at any moisture content as the ratio of mass to volume, and the relationship between density and moisture content is linear. Specific gravity has only one definition for these materials (because volume is constant): the ratio of oven-dry density to density of water.

In contrast to these materials, for wood, both mass and volume depend on moisture content. The remainder of this section explains the relationships between moisture content, volumetric shrinkage, specific gravity, and density.

The density of oven-dry wood ρ_0 varies significantly between species. Although the oven-dry density of most species falls between about 320 and 720 kg m⁻³ (20 and 45 lb ft⁻³), the range actually extends from about 160 kg m⁻³ (10 lb ft⁻³) for balsa to more than 1,040 kg m⁻³ (65 lb ft⁻³) for some other imported woods. Within a given species, ρ_0 varies because of anatomical characteristics such as the ratio of earlywood to latewood and heartwood to sapwood. For a limited number of species, minerals and extractable substances may also affect density. A coefficient of variation of about 10% is considered suitable for describing the variability of oven-dry density within common domestic species.

Wood is used in a wide range of conditions and thus has a wide range of moisture content values in service. Determining the density of wood (including water) at a given moisture content, ρ_x , is often necessary for applications such

as estimating structural loads or shipping weights. Several methods can be used for determining ρ_x , as discussed in the following sections. The resulting value should be considered an approximation because of the inherent variability in the properties used in calculating ρ_x .

To make comparisons between species or products, a standard reference basis is desirable. Several valid choices are possible for wood, including oven-dry density ρ_0 and specific gravity G referenced to a particular volume basis. As shown in Table 4–5, the specific gravity of wood may be referenced to its volume at any moisture content, but in all cases G is based on oven-dry mass. Commonly used bases for volume are (a) oven-dry, (b) green, and (c) 12% moisture content. The combination of oven-dry mass and oven-dry volume is used in design specifications for wood, such as contained in the *National Design Specification for Wood Construction* (AF&PA 2005). The combination of oven-dry mass and green volume is referred to as basic specific gravity G_b . Some specific gravity data are reported in Tables 5–3, 5–4, and 5–5 (Chap. 5) on both the green (basic) and 12% MC volume basis.

Converting between Different Specific Gravity Bases

In general, we use the symbol G_x to denote specific gravity based on the volume at a given moisture content x . If the value of G_x is known for a particular moisture content, the value at any other moisture content can be approximated using expressions for volumetric shrinkage. Explicitly, if the specific gravity is known at moisture content x' , the value at x'' is

$$G_{x''} = G_{x'} \left(\frac{100 - S_{x'}}{100 - S_{x''}} \right) \quad (4-8)$$

where S_x is the percent volumetric shrinkage from the green condition to moisture content x . In the case where basic specific gravity G_b is known, the value at any moisture content x below the fiber saturation point is

$$G_x = G_b / (1 - S_x / 100) \quad (4-9)$$

The shrinkage–moisture content relationship can be reasonably approximated using Table 4–3 or 4–4 and Equation (4–7). However, if the total volumetric shrinkage S_0 is not known for the species of interest, it can be estimated from the basic specific gravity (Stamm 1964):

$$S_0 = 26.5G_b \quad (4-10)$$

Using this relation, Equation (4–9) then becomes

$$G_x = G_b / [1 - 0.265G_b(1 - x/MC_{fb})] \quad (4-11)$$

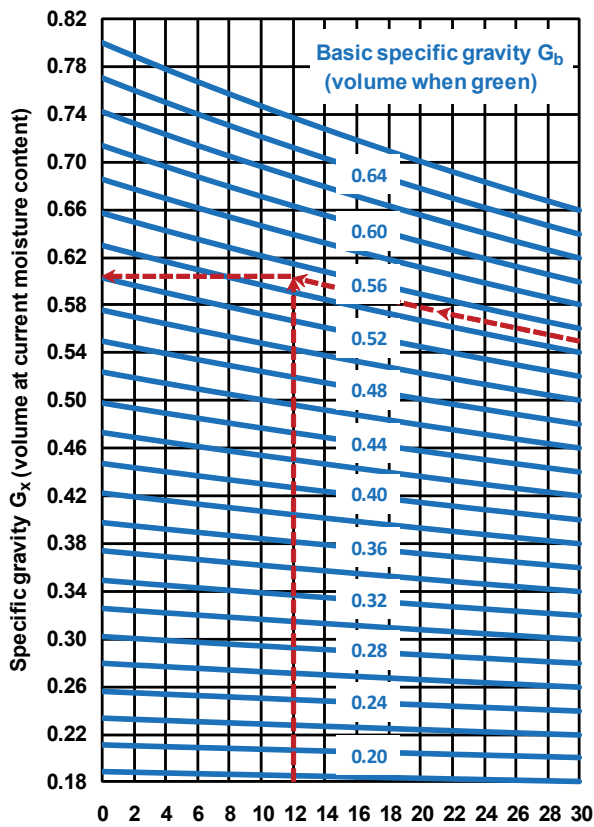

Figure 4–6. Relationship of specific gravity and moisture content.

Methods for Calculating Density

The density of wood (including water) at a given moisture content, ρ_x , may be determined by any of three methods:

Method 1—Equations Using Basic Specific Gravity

The specific gravity G_x based on volume at the moisture content of interest may be calculated from Equation (4–9) or (4–11) with basic specific gravity taken from Table 5–3, 5–4, or 5–5 (Chap. 5). Density is then calculated by

$$\rho_x = \rho_w G_x (1 + x/100) \tag{4-12}$$

Method 2—Equations Using Ovendry Density

Density is given by

$$\rho_x = \rho_0 (1 + x/100) \left(\frac{100 - S_0}{100 - S_x} \right) \tag{4-13}$$

where S_x is calculated using Equation (4–7) and S_0 is taken from Table 4–3 or 4–4. If S_0 is not known for the particular species of interest, it can be estimated using the same relation as in Equation (4–10), which in terms of ovendry density is

$$S_0 = 26.5 \rho_0 / (\rho_w + 0.265 \rho_0) \tag{4-14}$$

Method 3—Using Figure 4–6 and Table 4–6

Figure 4–6 depicts the relationship between specific gravity G_x and moisture content for different values of basic specific gravity. This figure adjusts for average dimensional changes that occur below the fiber saturation point (assumed to be 30% MC) and incorporates the assumptions in Equations (4–7), (4–10), and (4–11). The specific gravity of wood does not change at moisture content values above approximately 30% because the volume does not change. To use Figure 4–6, locate the inclined line corresponding to the known basic specific gravity (volume when green). From this point, move left parallel to the inclined lines until vertically above the target moisture content. Then read the specific gravity G_x corresponding to this point at the left-hand side of the graph.

For example, to estimate the density of white ash at 12% moisture content, consult Table 5–3a in Chapter 5. The average basic specific gravity G_b for this species is 0.55 (volume when green). Using Figure 4–6, the dashed curve for $G_b = 0.55$ is found to intersect with the vertical 12% moisture content dashed line at a point corresponding to $G_{12} = 0.605$. The density of wood (including water) at this moisture content can then be obtained from Table 4–6 (these values are based on Eq. (4–12)). By interpolation, the specific gravity of 0.605 corresponds to a density at 12% MC of 678 kg m⁻³ (42.2 lb ft⁻³).

Thermal Properties

Four important thermal properties of wood are thermal conductivity, heat capacity, thermal diffusivity, and coefficient of thermal expansion.

Thermal Conductivity

Thermal conductivity k is a measure of the rate of heat flow (W m⁻² or Btu h⁻¹ ft⁻²) through a material subjected to unit temperature difference (K or °F) across unit thickness (m or in.). The thermal conductivity of common structural woods is much less than the conductivity of metals with which wood often is mated in construction. It is about two to four times that of common insulating materials. For example, the conductivity of structural softwood lumber at 12% moisture content is in the range of 0.10 to 0.14 W m⁻¹ K⁻¹ (0.7 to 1.0 Btu in. h⁻¹ ft⁻² °F⁻¹) compared with 216 (1,500) for aluminum, 45 (310) for steel, 0.9 (6) for concrete, 1 (7) for glass, 0.7 (5) for plaster, and 0.036 (0.25) for mineral wool. Thermal resistivity is simply the reciprocal of the thermal conductivity. Insulating materials of a given thickness are commonly compared by their “R-value,” or thermal resistance, which is simply the thermal resistivity times the thickness.

The thermal conductivity of wood is affected by a number of basic factors: density, moisture content, extractive content, grain direction, structural irregularities such as checks

Table 4–6a. Density of wood as a function of specific gravity and moisture content (SI)

Moisture content of wood (%)	Density (kg m ⁻³) when the specific gravity G_x is																				
	0.30	0.32	0.34	0.36	0.38	0.40	0.42	0.44	0.46	0.48	0.50	0.52	0.54	0.56	0.58	0.60	0.62	0.64	0.66	0.68	0.70
0	300	320	340	360	380	400	420	440	460	480	500	520	540	560	580	600	620	640	660	680	700
4	312	333	354	374	395	416	437	458	478	499	520	541	562	582	603	624	645	666	686	707	728
8	324	346	367	389	410	432	454	475	497	518	540	562	583	605	626	648	670	691	713	734	756
12	336	358	381	403	426	448	470	493	515	538	560	582	605	627	650	672	694	717	739	762	784
16	348	371	394	418	441	464	487	510	534	557	580	603	626	650	673	696	719	742	766	789	812
20	360	384	408	432	456	480	504	528	552	576	600	624	648	672	696	720	744	768	792	816	840
24	372	397	422	446	471	496	521	546	570	595	620	645	670	694	719	744	769	794	818	843	868
28	384	410	435	461	486	512	538	563	589	614	640	666	691	717	742	768	794	819	845	870	896
32	396	422	449	475	502	528	554	581	607	634	660	686	713	739	766	792	818	845	871	898	924
36	408	435	462	490	517	544	571	598	626	653	680	707	734	762	789	816	843	870	898	925	952
40	420	448	476	504	532	560	588	616	644	672	700	728	756	784	812	840	868	896	924	952	980
44	432	461	490	518	547	576	605	634	662	691	720	749	778	806	835	864	893	922	950	979	1,008
48	444	474	503	533	562	592	622	651	681	710	740	770	799	829	858	888	918	947	977	1,006	1,036
52	456	486	517	547	578	608	638	669	699	730	760	790	821	851	882	912	942	973	1,003	1,034	1,064
56	468	499	530	562	593	624	655	686	718	749	780	811	842	874	905	936	967	998	1,030	1,061	1,092
60	480	512	544	576	608	640	672	704	736	768	800	832	864	896	928	960	992	1,024	1,056	1,088	1,120
64	492	525	558	590	623	656	689	722	754	787	820	853	886	918	951	984	1,017	1,050	1,082	1,115	1,148
68	504	538	571	605	638	672	706	739	773	806	840	874	907	941	974	1,008	1,042	1,075	1,109	1,142	1,176
72	516	550	585	619	654	688	722	757	791	826	860	894	929	963	998	1,032	1,066	1,101	1,135	1,170	1,204
76	528	563	598	634	669	704	739	774	810	845	880	915	950	986	1,021	1,056	1,091	1,126	1,161	1,197	
80	540	576	612	648	684	720	756	792	828	864	900	936	972	1,008	1,044	1,080	1,116	1,152	1,188		
84	552	589	626	662	699	736	773	810	846	883	920	957	994	1,030	1,067	1,104	1,141	1,178			
88	564	602	639	677	714	752	790	827	865	902	940	978	1,015	1,053	1,090	1,128	1,166				
92	576	614	653	691	730	768	806	845	883	922	960	998	1,037	1,075	1,114	1,152	1,190				
96	588	627	666	706	745	784	823	862	902	941	980	1,019	1,058	1,098	1,137	1,176					
100	600	640	680	720	760	800	840	880	920	960	1,000	1,040	1,080	1,120	1,160	1,200					
110	630	672	714	756	798	840	882	924	966	1,008	1,050	1,092	1,134	1,176	1,218						
120	660	704	748	792	836	880	924	968	1,012	1,056	1,100	1,144	1,188	1,232							
130	690	736	782	828	874	920	966	1,012	1,058	1,104	1,150	1,196	1,242	1,288							
140	720	768	816	864	912	960	1,008	1,056	1,104	1,152	1,200	1,248	1,296								
150	750	800	850	900	950	1,000	1,050	1,100	1,150	1,200	1,250	1,300	1,350								

and knots, fibril angle, and temperature. Thermal conductivity increases as density, moisture content, temperature, or extractive content of the wood increases. Thermal conductivity is nearly the same in the radial and tangential directions. However, conductivity along the grain has been reported as greater than conductivity across the grain by a factor of 1.5 to 2.8, with an average of about 1.8.

For moisture contents below 25%, approximate thermal conductivity k across the grain can be calculated with a linear equation of the form

$$k = G_x(B + Cx) + A \quad (4-15)$$

where G_x is specific gravity based on oven-dry mass and volume at moisture content x (%) and A , B , and C are constants. For $G_x > 0.3$, temperatures around 24 °C (75 °F), and $x < 25\%$ MC, the values of the constants are as follows:

$$A = 0.01864, B = 0.1941, C = 0.004064 \quad (k \text{ in } \text{W m}^{-1} \text{K}^{-1})$$

$$A = 0.129, B = 1.34, C = 0.028 \quad (k \text{ in } \text{Btu in. h}^{-1} \text{ft}^{-2} \text{°F}^{-1})$$

Equation (4–15) was derived from measurements made by

several researchers on a variety of species. Table 4–7 provides average approximate conductivity values for selected wood species, based on Equation (4–15). However, actual conductivity may vary as much as 20% from the tabulated values.

Although thermal conductivity measurements have been made at moisture content values above 25%, measurements have been few in number and generally lacking in accuracy. Therefore, we do not provide values for moisture content values above 25%.

The effect of temperature on thermal conductivity is relatively minor: conductivity increases about 2% to 3% per 10 °C (1% to 2% per 10 °F).

Heat Capacity

Heat capacity is defined as the amount of energy needed to increase one unit of mass (kg or lb) one unit in temperature (K or °F). The heat capacity of wood depends on the temperature and moisture content of the wood but is practically independent of density or species. Heat capacity of dry wood c_{p0} (kJ kg⁻¹ K⁻¹, Btu lb⁻¹ °F⁻¹) is approximately related to temperature T (K, °F) by

$$c_{p0} = 0.1031 + 0.003867T \quad (\text{SI}) \quad (4-16a)$$

Table 4–6b. Density of wood as a function of specific gravity and moisture content (I–P)

Moisture content of wood (%)	Density (lb ft ⁻³) when the specific gravity G_x is																				
	0.30	0.32	0.34	0.36	0.38	0.40	0.42	0.44	0.46	0.48	0.50	0.52	0.54	0.56	0.58	0.60	0.62	0.64	0.66	0.68	0.70
0	18.7	20.0	21.2	22.5	23.7	25.0	26.2	27.5	28.7	30.0	31.2	32.4	33.7	34.9	36.2	37.4	38.7	39.9	41.2	42.4	43.7
4	19.5	20.8	22.1	23.4	24.7	26.0	27.2	28.6	29.8	31.2	32.4	33.7	35.0	36.6	37.6	38.9	40.2	41.5	42.8	44.1	45.4
8	20.2	21.6	22.9	24.3	25.6	27.0	28.3	29.6	31.0	32.3	33.7	35.0	36.4	37.7	39.1	40.4	41.8	43.1	44.5	45.8	47.2
12	21.0	22.4	23.8	25.2	26.6	28.0	29.4	30.8	32.2	33.5	34.9	36.3	37.7	39.1	40.5	41.9	43.3	44.7	46.1	47.5	48.9
16	21.7	23.2	24.6	26.0	27.5	29.0	30.4	31.8	33.3	34.7	36.2	37.6	39.1	40.5	42.0	43.4	44.9	46.3	47.8	49.2	50.7
20	22.5	24.0	25.5	27.0	28.4	30.0	31.4	32.9	34.4	35.9	37.4	38.9	40.4	41.9	43.4	44.9	46.4	47.9	49.4	50.9	52.4
24	23.2	24.8	26.3	27.8	29.4	31.0	32.5	34.0	35.6	37.1	38.7	40.2	41.8	43.3	44.9	46.4	48.0	49.5	51.1	52.6	54.2
28	24.0	25.6	27.2	28.8	30.4	31.9	33.5	35.1	36.7	38.3	39.9	41.5	43.1	44.7	46.3	47.9	49.5	51.1	52.7	54.3	55.9
32	24.7	26.4	28.0	29.7	31.3	32.9	34.6	36.2	37.9	39.5	41.2	42.8	44.5	46.1	47.8	49.4	51.1	52.7	54.4	56.0	57.7
36	25.5	27.2	28.9	30.6	32.2	33.9	35.6	37.3	39.0	40.7	42.4	44.1	45.8	47.5	49.2	50.9	52.6	54.3	56.0	57.7	59.4
40	26.2	28.0	29.7	31.4	33.2	34.9	36.7	38.4	40.2	41.9	43.7	45.4	47.2	48.9	50.7	52.4	54.2	55.9	57.7	59.4	61.2
44	27.0	28.8	30.6	32.3	34.1	35.9	37.7	39.5	41.3	43.1	44.9	46.7	48.5	50.3	52.1	53.9	55.7	57.5	59.3	61.1	62.9
48	27.7	29.6	31.4	33.2	35.1	36.9	38.8	40.6	42.5	44.3	46.2	48.0	49.9	51.7	53.6	55.4	57.3	59.1	61.0	62.8	64.6
52	28.5	30.4	32.2	34.1	36.0	37.9	39.8	41.7	43.6	45.5	47.4	49.3	51.2	53.1	55.0	56.9	58.8	60.7	62.6	64.5	66.4
56	29.2	31.2	33.1	35.0	37.0	38.9	40.9	42.8	44.8	46.7	48.7	50.6	52.6	54.5	56.5	58.4	60.4	62.3	64.2	66.2	68.1
60	30.0	31.9	33.9	35.9	37.9	39.9	41.9	43.9	45.9	47.9	49.9	51.9	53.9	55.9	57.9	59.9	61.9	63.9	65.9	67.9	69.9
64	30.7	32.7	34.8	36.8	38.9	40.9	43.0	45.0	47.1	49.1	51.2	53.2	55.3	57.3	59.4	61.4	63.4	65.5	67.5	69.6	71.6
68	31.4	33.5	35.6	37.7	39.8	41.9	44.0	46.1	48.2	50.3	52.4	54.5	56.6	58.7	60.8	62.9	65.0	67.1	69.2	71.3	73.4
72	32.2	34.3	36.5	38.6	40.8	42.9	45.1	47.2	49.4	51.5	53.7	55.8	58.0	60.1	62.3	64.4	66.5	68.7	70.8	73.0	75.1
76	32.9	35.1	37.3	39.5	41.7	43.9	46.1	48.3	50.5	52.7	54.9	57.1	59.3	61.5	63.7	65.9	68.1	70.3	72.5		
80	33.7	35.9	38.2	40.4	42.7	44.9	47.2	49.4	51.7	53.9	56.2	58.4	60.7	62.9	65.1	67.4	69.6	71.9	74.1		
84	34.4	36.7	39.0	41.3	43.6	45.9	48.2	50.5	52.8	55.1	57.4	59.7	62.0	64.3	66.6	68.9	71.2	73.5			
88	35.2	37.5	39.9	42.2	44.6	46.9	49.3	51.6	54.0	56.3	58.7	61.0	63.3	65.7	68.0	70.4	72.7				
92	35.9	38.3	40.7	43.1	45.5	47.9	50.3	52.7	55.1	57.5	59.9	62.3	64.7	67.1	69.5	71.9	74.3				
96	36.7	39.1	41.6	44.0	46.5	48.9	51.4	53.8	56.3	58.7	61.2	63.6	66.0	68.5	70.9	73.4					
100	37.4	39.9	42.4	44.9	47.4	49.9	52.4	54.9	57.4	59.9	62.4	64.9	67.4	69.9	72.4	74.9					
110	39.3	41.9	44.6	47.2	49.8	52.4	55.0	57.7	60.3	62.9	65.5	68.1	70.8	73.4	76.0						
120	41.2	43.9	46.7	49.4	52.2	54.9	57.7	60.4	63.1	65.9	68.6	71.4	74.1	76.9							
130	43.1	45.9	48.8	51.7	54.5	57.4	60.3	63.1	66.0	68.9	71.8	74.6	77.5	80.4							
140	44.9	47.9	50.9	53.9	56.9	59.9	62.9	65.9	68.9	71.9	74.9	77.9	80.9								
150	46.8	49.9	53.0	56.2	59.3	62.4	65.5	68.6	71.8	74.9	78.0	81.1	84.2								

$$c_{p0} = 0.2605 + 0.0005132T \quad (\text{I–P}) \quad (4-16b)$$

The heat capacity of wood that contains water is greater than that of dry wood. Below fiber saturation, it is the sum of the heat capacity of the dry wood and that of water (c_{pw}) and an additional adjustment factor A_c that accounts for the additional energy in the wood–water bond:

$$c_{p,x} = (c_{p0} + c_{pw} x/100)/(1 + x/100) + A_c \quad (4-17)$$

where x is moisture content (%). The heat capacity of water is about 4.18 kJ kg⁻¹ K⁻¹ (1.00 Btu lb⁻¹ °F⁻¹). The adjustment factor can be calculated from

$$A_c = x(b_1 + b_2T + b_3x) \quad (4-18)$$

with

$$b_1 = -0.06191, b_2 = 2.36 \times 10^{-4}, b_3 = -1.33 \times 10^{-4} \quad (T \text{ in K})$$

$$b_1 = -4.23 \times 10^{-4}, b_2 = 3.12 \times 10^{-5}, b_3 = -3.17 \times 10^{-5} \quad (T \text{ in } ^\circ\text{F})$$

These formulas are valid for wood below fiber saturation at temperatures between 280 K (44 °F) and 420 K (296 °F). Representative values for heat capacity can be found in Table 4–8. The moisture content above fiber saturation contributes to heat capacity according to the simple rule of mixtures.

Thermal Diffusivity

Thermal diffusivity is a measure of how quickly a material can absorb heat from its surroundings. It is defined as the ratio of thermal conductivity to the product of density and heat capacity. Therefore, conclusions regarding its variation with temperature and density are often based on calculating the effect of these variables on heat capacity and thermal conductivity. Because of the low thermal conductivity and moderate density and heat capacity of wood, the thermal diffusivity of wood is much lower than that of other structural materials, such as metal, brick, and stone. A typical value for wood is $1.6 \times 10^{-7} \text{ m}^2 \text{ s}^{-1}$ ($0.00025 \text{ in}^2 \text{ s}^{-1}$), compared with $1 \times 10^{-5} \text{ m}^2 \text{ s}^{-1}$ ($0.02 \text{ in}^2 \text{ s}^{-1}$) for steel and $1 \times 10^{-6} \text{ m}^2 \text{ s}^{-1}$ ($0.002 \text{ in}^2 \text{ s}^{-1}$) for stone and mineral wool. For this reason, wood does not feel extremely hot or cold to the touch as do some other materials.

Table 4–7. Thermal conductivity of selected hardwoods and softwoods^a

Species	Specific gravity	Conductivity (W m ⁻¹ K ⁻¹ (Btu in. h ⁻¹ ft ⁻² °F ⁻¹))		Resistivity (K m W ⁻¹ (h ft ² °F Btu ⁻¹ in. ⁻¹))	
		Ovendry	12% MC	Ovendry	12% MC
Hardwoods					
Ash					
Black	0.53	0.12 (0.84)	0.15 (1.0)	8.2 (1.2)	6.8 (0.98)
White	0.63	0.14 (0.98)	0.17 (1.2)	7.1 (1.0)	5.8 (0.84)
Aspen					
Big tooth	0.41	0.10 (0.68)	0.12 (0.82)	10 (1.5)	8.5 (1.2)
Quaking	0.40	0.10 (0.67)	0.12 (0.80)	10 (1.5)	8.6 (1.2)
Basswood, American	0.38	0.092 (0.64)	0.11 (0.77)	11 (1.6)	9.0 (1.3)
Beech, American	0.68	0.15 (1.0)	0.18 (1.3)	6.6 (0.96)	5.4 (0.78)
Birch					
Sweet	0.71	0.16 (1.1)	0.19 (1.3)	6.4 (0.92)	5.2 (0.76)
Yellow	0.66	0.15 (1.0)	0.18 (1.2)	6.8 (0.98)	5.6 (0.81)
Cherry, black	0.53	0.12 (0.84)	0.15 (1.0)	8.2 (1.2)	6.8 (0.98)
Chestnut, American	0.45	0.11 (0.73)	0.13 (0.89)	9.4 (1.4)	7.8 (1.1)
Cottonwood					
Black	0.35	0.087 (0.60)	0.10 (0.72)	12 (1.7)	9.6 (1.4)
Eastern	0.43	0.10 (0.71)	0.12 (0.85)	9.8 (1.4)	8.1 (1.2)
Elm					
American	0.54	0.12 (0.86)	0.15 (1.0)	8.1 (1.2)	6.7 (0.96)
Rock	0.67	0.15 (1.0)	0.18 (1.3)	6.7 (0.97)	5.5 (0.80)
Slippery	0.56	0.13 (0.88)	0.15 (1.1)	7.9 (1.1)	6.5 (0.93)
Hackberry	0.57	0.13 (0.90)	0.16 (1.1)	7.7 (1.1)	6.4 (0.92)
Hickory, pecan	0.69	0.15 (1.1)	0.19 (1.3)	6.6 (0.95)	5.4 (0.77)
Hickory, true					
Mockernut	0.78	0.17 (1.2)	0.21 (1.4)	5.9 (0.85)	4.8 (0.69)
Shagbark	0.77	0.17 (1.2)	0.21 (1.4)	5.9 (0.86)	4.9 (0.70)
Magnolia, southern	0.52	0.12 (0.83)	0.14 (1.0)	8.4 (1.2)	6.9 (1.0)
Maple					
Black	0.60	0.14 (0.94)	0.16 (1.1)	7.4 (1.1)	6.1 (0.88)
Red	0.56	0.13 (0.88)	0.15 (1.1)	7.9 (1.1)	6.5 (0.93)
Silver	0.50	0.12 (0.80)	0.14 (0.97)	8.6 (1.2)	7.1 (1.0)
Sugar	0.66	0.15 (1.0)	0.18 (1.2)	6.8 (0.98)	5.6 (0.81)
Oak, red					
Black	0.66	0.15 (1.0)	0.18 (1.2)	6.8 (0.98)	5.6 (0.81)
Northern red	0.65	0.14 (1.0)	0.18 (1.2)	6.9 (1.0)	5.7 (0.82)
Southern red	0.62	0.14 (0.96)	0.17 (1.2)	7.2 (1.0)	5.9 (0.85)
Oak, white					
Bur	0.66	0.15 (1.0)	0.18 (1.2)	6.8 (0.98)	5.6 (0.81)
White	0.72	0.16 (1.1)	0.19 (1.3)	6.3 (0.91)	5.2 (0.75)
Sweetgum	0.55	0.13 (0.87)	0.15 (1.1)	8.0 (1.2)	6.6 (0.95)
Sycamore, American	0.54	0.12 (0.86)	0.15 (1.0)	8.1 (1.2)	6.7 (0.96)
Tupelo					
Black	0.54	0.12 (0.86)	0.15 (1.0)	8.1 (1.2)	6.7 (0.96)
Water	0.53	0.12 (0.84)	0.15 (1.0)	8.2 (1.2)	6.8 (0.98)
Yellow-poplar	0.46	0.11 (0.75)	0.13 (0.90)	9.3 (1.3)	7.7 (1.1)

Table 4–7. Thermal conductivity of selected hardwoods and softwoods^a—con.

Species	Specific gravity	Conductivity (W m ⁻¹ K ⁻¹ (Btu in. h ⁻¹ ft ⁻² °F ⁻¹))		Resistivity (K m W ⁻¹ (h ft ² °F Btu ⁻¹ in. ⁻¹))	
		Ovendry	12% MC	Ovendry	12% MC
Softwoods					
Baldcypress	0.47	0.11 (0.76)	0.13 (0.92)	9.1 (1.3)	7.5 (1.1)
Cedar					
Atlantic white	0.34	0.085 (0.59)	0.10 (0.70)	12 (1.7)	9.9 (1.4)
Eastern red	0.48	0.11 (0.77)	0.14 (0.94)	8.9 (1.3)	7.4 (1.1)
Northern white	0.31	0.079 (0.55)	0.094 (0.65)	13 (1.8)	11 (1.5)
Port-Orford	0.43	0.10 (0.71)	0.12 (0.85)	9.8 (1.4)	8.1 (1.2)
Western red	0.33	0.083 (0.57)	0.10 (0.68)	12 (1.7)	10 (1.5)
Yellow	0.46	0.11 (0.75)	0.13 (0.90)	9.3 (1.3)	7.7 (1.1)
Douglas-fir					
Coast	0.51	0.12 (0.82)	0.14 (0.99)	8.5 (1.2)	7.0 (1.0)
Interior north	0.50	0.12 (0.80)	0.14 (0.97)	8.6 (1.2)	7.1 (1.0)
Interior west	0.52	0.12 (0.83)	0.14 (1.0)	8.4 (1.2)	6.9 (1.0)
Fir					
Balsam	0.37	0.090 (0.63)	0.11 (0.75)	11 (1.6)	9.2 (1.3)
White	0.41	0.10 (0.68)	0.12 (0.82)	10 (1.5)	8.5 (1.2)
Hemlock					
Eastern	0.42	0.10 (0.69)	0.12 (0.84)	10 (1.4)	8.3 (1.2)
Western	0.48	0.11 (0.77)	0.14 (0.94)	8.9 (1.3)	7.4 (1.1)
Larch, western	0.56	0.13 (0.88)	0.15 (1.1)	7.9 (1.1)	6.5 (0.93)
Pine					
Eastern white	0.37	0.090 (0.63)	0.11 (0.75)	11 (1.6)	9.2 (1.3)
Jack	0.45	0.11 (0.73)	0.13 (0.89)	9.4 (1.4)	7.8 (1.1)
Loblolly	0.54	0.12 (0.86)	0.15 (1.0)	8.1 (1.2)	6.7 (0.96)
Lodgepole	0.43	0.10 (0.71)	0.12 (0.85)	9.8 (1.4)	8.1 (1.2)
Longleaf	0.62	0.14 (0.96)	0.17 (1.2)	7.2 (1.0)	5.9 (0.85)
Pitch	0.53	0.12 (0.84)	0.15 (1.0)	8.2 (1.2)	6.8 (0.98)
Ponderosa	0.42	0.10 (0.69)	0.12 (0.84)	10 (1.4)	8.3 (1.2)
Red	0.46	0.11 (0.75)	0.13 (0.90)	9.3 (1.3)	7.7 (1.1)
Shortleaf	0.54	0.12 (0.86)	0.15 (1.0)	8.1 (1.2)	6.7 (0.96)
Slash	0.61	0.14 (0.95)	0.17 (1.2)	7.3 (1.1)	6.0 (0.86)
Sugar	0.37	0.090 (0.63)	0.11 (0.75)	11 (1.6)	9.2 (1.3)
Western white	0.40	0.10 (0.67)	0.12 (0.80)	10 (1.5)	8.6 (1.2)
Redwood					
Old growth	0.41	0.10 (0.68)	0.12 (0.82)	10 (1.5)	8.5 (1.2)
Young growth	0.37	0.090 (0.63)	0.11 (0.75)	11 (1.6)	9.2 (1.3)
Spruce					
Black	0.43	0.10 (0.71)	0.12 (0.85)	9.8 (1.4)	8.1 (1.2)
Engelmann	0.37	0.090 (0.63)	0.11 (0.75)	11 (1.6)	9.2 (1.3)
Red	0.42	0.10 (0.69)	0.12 (0.84)	10 (1.4)	8.3 (1.2)
Sitka	0.42	0.10 (0.69)	0.12 (0.84)	10 (1.4)	8.3 (1.2)
White	0.37	0.090 (0.63)	0.11 (0.75)	11 (1.6)	9.2 (1.3)

^aValues in this table are approximate and should be used with caution; actual conductivities may vary by as much as 20%. The specific gravities also do not represent species averages.

Coefficient of Thermal Expansion

The coefficient of thermal expansion is a measure of the relative change of dimension caused by temperature change. The thermal expansion coefficients of completely dry wood are positive in all directions; that is, wood expands on heating and contracts on cooling. Limited research has been carried out to explore the influence of wood property variability on thermal expansion. The thermal expansion coefficient of oven-dry wood parallel to the grain appears to be independent of specific gravity and species. In tests of both

hardwoods and softwoods, the parallel-to-grain values have ranged from about 3.1 to $4.5 \times 10^{-6} \text{ K}^{-1}$ (1.7 to $2.5 \times 10^{-6} \text{ °F}^{-1}$).

Thermal expansion coefficients across the grain (radial and tangential) are proportional to specific gravity. These coefficients range from about 5 to more than 10 times greater than the parallel-to-grain coefficients and are of more practical interest. The radial and tangential thermal expansion coefficients for oven-dry wood, α_r and α_t , can be approximated

Table 4–8. Heat capacity of solid wood at selected temperatures and moisture contents

Temperature		Heat capacity (kJ kg ⁻¹ K ⁻¹ (Btu lb ⁻¹ °F ⁻¹))			
(K)	(°C (°F))	Ovendry	5% MC	12% MC	20% MC
280	7 (44)	1.2 (0.28)	1.3 (0.32)	1.5 (0.37)	1.7 (0.41)
290	17 (62)	1.2 (0.29)	1.4 (0.33)	1.6 (0.38)	1.8 (0.43)
300	27 (80)	1.3 (0.30)	1.4 (0.34)	1.7 (0.40)	1.9 (0.45)
320	47 (116)	1.3 (0.32)	1.5 (0.37)	1.8 (0.43)	2.0 (0.49)
340	67 (152)	1.4 (0.34)	1.6 (0.39)	1.9 (0.46)	2.2 (0.52)
360	87 (188)	1.5 (0.36)	1.7 (0.41)	2.0 (0.49)	2.3 (0.56)

by the following equations, over an oven-dry specific gravity range of about 0.1 to 0.8:

$$\alpha_r = (32.4G_0 + 9.9)10^{-6} \text{ K}^{-1} \quad (4-19a)$$

$$\alpha_r = (18G_0 + 5.5)10^{-6} \text{ °F}^{-1} \quad (4-19b)$$

$$\alpha_t = (32.4G_0 + 18.4)10^{-6} \text{ K}^{-1} \quad (4-20a)$$

$$\alpha_t = (18G_0 + 10.2)10^{-6} \text{ °F}^{-1} \quad (4-20b)$$

Thermal expansion coefficients can be considered independent of temperature over the temperature range of -51 to 54 °C (-60 to 130 °F).

Wood that contains moisture reacts differently to varying temperature than does nearly oven-dry wood. When moist wood is heated, it tends to expand because of normal thermal expansion and to shrink because of loss in moisture content. Unless the wood is very dry initially (perhaps 3% or 4% moisture content or less), shrinkage caused by moisture loss on heating will be greater than thermal expansion, so the net dimensional change on heating will be negative. Wood at intermediate moisture levels (about 8% to 20%) will expand when first heated, and then gradually shrink to a volume smaller than the initial volume as the wood gradually loses water while in the heated condition.

Even in the longitudinal (grain) direction, where dimensional change caused by moisture change is very small, such changes will still predominate over corresponding dimensional changes as a result of thermal expansion unless the wood is very dry initially. For wood at usual moisture levels, net dimensional changes will generally be negative after prolonged heating.

Electrical Properties

The electrical properties of wood depend strongly on moisture content, exhibiting changes that span almost 10 orders of magnitude over the range of possible moisture contents. Because electrical properties of wood undergo large changes with relatively small changes in moisture content below fiber saturation, electrical measurements have been used to accurately predict the moisture content of wood.

The literature on electrical properties of wood has been divided into measurements of either dielectric constant or resistivity. In general, dielectric constant data were measured with alternating current (AC), whereas resistivity measurements used direct current (DC). In a way, this is a false dichotomy because the dielectric constant can be measured using DC signals for some materials, and the complex resistivity, which is related to impedance, can be measured from AC signals. Furthermore, given the AC dielectric constant, one can calculate the AC resistivity. The remainder of this section will review AC and DC measurements of the electrical properties of wood, with emphasis on clarifying the nomenclature that is often used in the wood literature.

DC Electrical Properties

Resistivity

When an electric potential or voltage V is applied between two points on a conducting solid, the amount of current I that will flow between those points depends on the resistance R of the material. This measured resistance depends on the geometry of the specimen:

$$R = \rho \frac{L}{A} \quad (4-21)$$

where L is the distance the current travels, A is the cross-sectional area through which the current travels, and ρ is a materials parameter, the resistivity with units of Ω m. In some situations, it is more convenient to talk about the conductivity σ , which is the reciprocal of the resistivity ($\sigma \equiv 1/\rho$).

The resistivity of wood is a strong function of moisture content. For example, Figure 4–7 illustrates this dependence for slash pine (*Pinus elliottii*) in the longitudinal direction between 8% MC and 180% MC (Stamm 1929, 1964). As the moisture content of wood increases from near zero to fiber saturation, resistivity can decrease by a factor of over 10^{10} (in comparison, the circumference of the earth at the equator is 4×10^{10} mm). Resistivity is about 10^{15} – 10^{16} Ω m for oven-dry wood and 10^3 – 10^4 Ω m for wood at fiber saturation (Stamm 1964). As the moisture content increases from fiber saturation to complete saturation of the wood structure, the further decrease in resistivity is smaller, generally amounting to less than a hundredfold.

The conductivity of wood also depends on temperature, grain angle, and the amount of water-soluble salts. Unlike conductivity of metals, the conductivity of wood increases with increasing temperature. Conductivity is greater along the grain than across the grain and slightly greater in the radial direction than in the tangential direction. Relative conductivity values in the longitudinal, radial, and tangential directions are related by the approximate ratio of 1.0:0.55:0.50. When wood contains abnormal quantities of water-soluble salts or other electrolytic substances, such as preservative or fire-retardant treatment, or is in prolonged

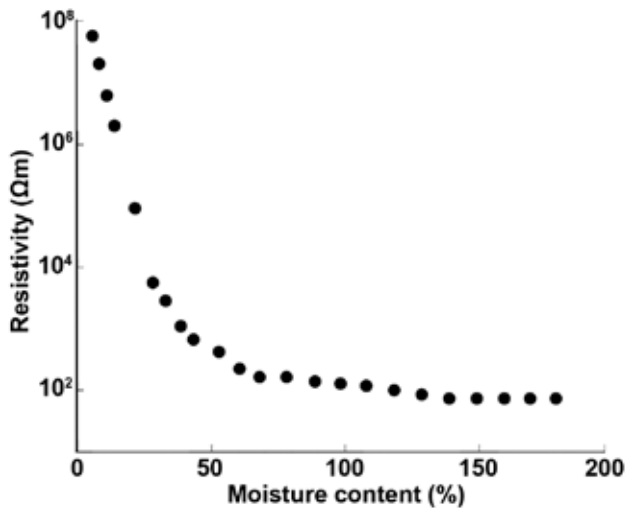

Figure 4–7. Resistivity of slash pine (*Pinus elliottii*) as a function of moisture content.

contact with seawater, electrical conductivity can be substantially increased.

DC Dielectric Constant

When an electric potential or voltage V is applied to a perfectly insulating material ($\sigma \equiv 0$) between two parallel plates, no current will flow and instead charge will build up on the plates. The amount of charge per unit voltage that these plates can store is called the capacitance C and is given by

$$C = \epsilon \epsilon_0 \frac{A}{L} \quad (4-22)$$

where A and L have the same meanings as in Equation (4–21), ϵ is a unitless materials parameter, the DC dielectric constant, and ϵ_0 is a universal constant, the permittivity of a vacuum, and is $8.854 \times 10^{-12} \text{ F m}^{-1}$. The DC dielectric constant is the ratio of the dielectric permittivity of the material to ϵ_0 ; it is essentially a measure of the potential energy per unit volume stored in the material in the form of electric polarization when the material is in a given electric field. As measured by practical tests, the dielectric constant of a material is the ratio of the capacitance of a capacitor using the material as the dielectric to the capacitance of the same capacitor using free space as the dielectric.

Because wood is not a perfect insulator ($\sigma \neq 0$ at any moisture content), the DC dielectric constant of wood is not well defined and theoretically cannot be measured with DC techniques. Nevertheless, researchers have tried to measure this quantity and have found that it is difficult to measure and depends on experimental technique (Skaar 1988).

AC Electrical Properties

AC Dielectric Constant and Related Properties

When an alternating current is applied, the dielectric constant can no longer be represented by a scalar, because

response will be out of phase with the original signal. The AC dielectric constant is a complex number $\epsilon = \epsilon' + j\epsilon''$ with real component ϵ' , imaginary component ϵ'' , and $j \equiv \sqrt{-1}$. Instead of presenting the real and imaginary components of the dielectric constant, it is customary in the wood literature to present the real component of the dielectric constant ϵ' and the loss tangent, $\tan(\delta)$, defined by

$$\tan(\delta) = \frac{\epsilon''}{\epsilon'} \quad (4-23)$$

It is also customary in the wood literature to refer to the real component of the dielectric constant ϵ' as simply “the dielectric constant” and to represent this with ϵ . This notation should not be encouraged, because it is ambiguous and also implies that the dielectric constant is not a complex number.

Both ϵ' and $\tan(\delta)$ depend non-linearly on the frequency at which they are measured. The frequency dependence is related to the mechanism of conduction in wood, and this relationship between the frequency dependence and mechanism has been explored in the literature (James 1975, Zelinka and others 2007).

At a given frequency, ϵ' increases with temperature and moisture content. At 20 Hz, ϵ' may range from about 4 for dry wood to near 1×10^6 for wet wood; at 1 kHz, from about 4 when dry to about 5,000 when wet; and at 1 MHz, from about 3 when dry to about 100 when wet. ϵ' is larger for polarization parallel to the grain than across the grain.

Another parameter, the dielectric power factor f_p given by

$$f_p = \sin(\delta) = \frac{\epsilon''}{\sqrt{(\epsilon')^2 + (\epsilon'')^2}} \quad (4-24)$$

is used in dielectric moisture meters (James 1988). The power factor of wood is large compared with that of inert plastic insulating materials, but some materials, for example some formulations of rubber, have equally large power factors. The power factor of wood varies from about 0.01 for dry, low-density woods to as large as 0.95 for dense woods at high moisture levels. The power factor is usually, but not always, greater for electric fields along the grain than across the grain.

Because the power factor of wood is derived from ϵ' and ϵ'' , it is also affected by frequency, moisture content, and temperature. These factors interact in such a way to cause f_p to have maximum and minimum values at various combinations of these factors.

Impedance

Just as the AC dielectric constant was represented by a complex number to account for both magnitude and phase, the “resistance” of an AC circuit is also represented by a complex number called impedance, $Z = Z' + jZ''$ with real

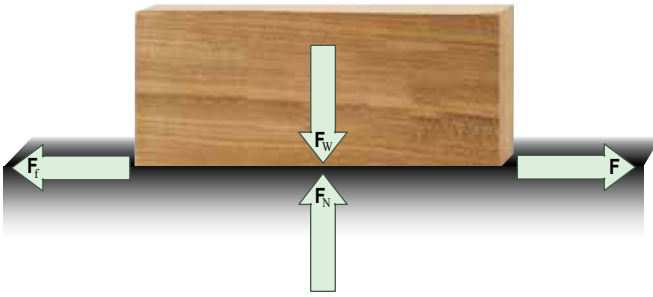

Figure 4–8. Diagram depicting the forces acting on an object in contact with a surface.

component Z' and imaginary component Z'' . Impedance is related to the AC dielectric constant through

$$Z = (j\omega C_c \cdot \epsilon)^{-1} \quad (4-25)$$

where ω is the angular frequency and C_c is a geometrical factor needed for unit analysis and represents the capacitance of an empty cell (that is, $C_c = \epsilon_0 A/L$) (MacDonald and Johnson 1987). In short, this transforms the real component of the dielectric constant to the imaginary component of the impedance, and vice versa.

Recently, measurements of the impedance of wood have been used to determine moisture gradients (Tiitta and Olkkonen 2002), better understand the mechanism of electrical conduction in wood (Zelinka and others 2007), and quantify the corrosion of metals embedded in wood (Zelinka and Rammer 2005).

Friction Properties

Figure 4–8 depicts the forces acting on an object. The weight of the object F_W (the gravitational force acting downward) is opposed by the normal force F_N exerted by the surface supporting it. The applied horizontal force F is opposed by the friction force F_f parallel to the surface. In the case in which the object is not moving but is on the verge of sliding across the surface, the coefficient of static friction μ_s is defined as

$$\mu_s = \frac{F_f(\text{max})}{F_N} \quad (4-26)$$

where $F_f(\text{max})$ is the magnitude of the maximum friction force and F_N is the magnitude of the normal force. In the case in which the object is sliding across the surface at constant speed, the coefficient of kinetic friction μ_k is defined as

$$\mu_k = \frac{F_f}{F_N} \quad (4-27)$$

These coefficients depend on the moisture content of the wood, the roughness of the wood surface, and the characteristics of the opposing surface. They vary little with species

except for woods that contain abundant oily or waxy extractives, such as *lignumvitae* (see Chap. 2). The coefficients of friction are an important safety consideration in applications such as wood decks, stairs, and sloped surfaces such as roof sheathing.

On most materials, the coefficients of friction for wood increase continuously as the moisture content of the wood increases from oven-dry to fiber saturation, then remain about constant as the moisture content increases further until considerable free water is present. When the surface is flooded with water, the coefficients of friction decrease.

Coefficients of static friction are generally greater than those of kinetic friction, and the latter depend somewhat on the speed of sliding. Coefficients of kinetic friction vary only slightly with speed when the wood moisture content is less than about 20%; at high moisture content, the coefficient of kinetic friction decreases substantially as speed increases.

Coefficients of kinetic friction for smooth, dry wood against hard, smooth surfaces commonly range from 0.3 to 0.5; at intermediate moisture content, 0.5 to 0.7; and near fiber saturation, 0.7 to 0.9.

Nuclear Radiation Properties

Several techniques using high-energy radiation can be used to measure density and moisture content of wood. Radiation passing through matter is reduced in intensity according to the relationship

$$I = I_0 \exp(-\mu z) \quad (4-28)$$

where I is the reduced intensity of the beam at depth z in the material, I_0 is the incident intensity of a beam of radiation, and μ , the linear absorption coefficient of the material, is the fraction of energy removed from the beam per unit depth traversed. When density is a factor of interest in energy absorption, the linear absorption coefficient is divided by the density of the material to derive the mass absorption coefficient. The absorption coefficient of a material varies with the type and energy of radiation.

The linear absorption coefficient of wood for γ radiation is known to vary directly with moisture content and density and inversely with the γ ray energy. As an example, the irradiation of oven-dry yellow-poplar with 0.047-MeV γ rays yields linear absorption coefficients ranging from about 0.065 to about 0.11 cm^{-1} over the oven-dry specific gravity range of about 0.33 to 0.62. An increase in the linear absorption coefficient of about 0.01 cm^{-1} occurs with an increase in moisture content from oven-dry to fiber saturation. Absorption of γ rays in wood is of practical interest, in part for measuring the density of wood.

The interaction of wood with β radiation is similar in character to that with γ radiation, except that the absorption coefficients are larger. The linear absorption coefficient of

wood with a specific gravity of 0.5 for a 0.5-MeV β ray is about 3.0 cm^{-1} . The result of the larger coefficient is that even very thin wood products are virtually opaque to β rays.

The interaction of neutrons with wood is of interest because wood and the water it contains are compounds of hydrogen, and hydrogen has a relatively large probability of interaction with neutrons. Higher energy neutrons lose energy much more quickly through interaction with hydrogen than with other elements found in wood. Lower energy neutrons that result from this interaction are thus a measure of the hydrogen density of the specimen. Measurement of the lower energy level neutrons can be related to the moisture content of the wood.

When neutrons interact with wood, an additional result is the production of radioactive isotopes of the elements present in the wood. The radioisotopes produced can be identified by the type, energy, and half-life of their emissions, and the specific activity of each indicates the amount of isotope present. This procedure, called neutron activation analysis, provides a sensitive nondestructive method of analysis for trace elements.

Discussions in this section assume moderate radiation levels that leave the wood physically unchanged. However, very large doses of γ rays or neutrons can cause substantial degradation of wood. The effect of large radiation doses on mechanical properties of wood is discussed in Chapter 5.

Literature Cited

- AF&PA. 2005. National design specification for wood construction. ANSI/AF&PA NDS-2005. Washington, DC: American Forest & Paper Association, American Wood Council. 174 p.
- ASTM. 2007. Standard test methods for small clear specimens of timber. ASTM Standard D143, 1994 (2007). West Conshohocken, PA: ASTM International.
- Comstock, G.L. 1965. Shrinkage of coast-type Douglas-fir and old-growth redwood boards. Res. Pap. FPL 30. Madison, WI: U.S. Department of Agriculture, Forest Service, Forest Products Laboratory. 20 p.
- IEA. 1991. Catalogue of material properties. In: International Energy Agency, Annex XIV: Condensation and Energy. Leuven, Belgium: Katholieke Universiteit Leuven, Laboratory for Building Physics. Report Annex XIV, Vol. 3.
- ISO. 2002. Hygrothermal performance of building materials and products—determination of water absorption coefficient by partial immersion. International Standard ISO 15148:2002. Geneva, Switzerland: International Organization for Standardization.
- James, W.L. 1975. Dielectric properties of wood and hardboard: variation with temperature, frequency, moisture content, and grain orientation. Res. Pap. FPL–RP–245. Madison, WI: U.S. Department of Agriculture, Forest Service, Forest Products Laboratory. 32 p.
- James, W.L. 1988. Electric moisture meters for wood. Gen. Tech. Rep. FPL–GTR–6. Madison, WI: U.S. Department of Agriculture, Forest Service, Forest Products Laboratory. 17 p.
- Kumaran, M.K. 1999. Moisture diffusivity of building materials from water absorption measurements. *Journal of Thermal Envelope and Building Science*. 22: 349–355.
- Kumaran, M.K. 2002. A thermal and moisture transport property database for common building and insulating materials. Final Report, ASHRAE Research Project 1018-RP. Atlanta, GA: American Society of Heating, Refrigerating and Air-Conditioning Engineers, Inc.
- MacDonald, J.R.; Johnson, W.B. 1987. Fundamentals of impedance spectroscopy. In: MacDonald, J.R., ed. *Impedance spectroscopy emphasizing solid materials and systems*. New York, NY: John Wiley & Sons: 1–26.
- Markwardt, L.J.; Wilson, T.R.C. 1935. Strength and related properties of woods grown in the United States. *Tech. Bull. No. 479*. Washington, DC: U.S. Department of Agriculture.
- Simpson, W.T. 1973. Predicting equilibrium moisture content of wood by mathematical models. *Wood and Fiber*. 5(1): 41–49.
- Skaar, C. 1988. *Wood–water relations*. New York: Springer-Verlag. 283 p.
- Spalt, H.A. 1958. The fundamentals of water vapor sorption by wood. *Forest Products Journal*. 8(10): 288–295.
- Stamm, A.J. 1929. The fiber-saturation point of wood as obtained from electrical conductivity measurements. *Industrial and Engineering Chemistry, Analytical Edition*. 1(2): 94–97.
- Stamm, A.J. 1964. *Wood and Cellulose Science*. New York: Ronald Press. 549 p.
- Stamm, A.J.; Loughborough, W.K. 1935. Thermodynamics of the swelling of wood. *Journal of Physical Chemistry*. 39(1): 121–132.
- Tiitta, M.; Olkkonen, H. 2002. Electrical impedance spectroscopy device for measurement of moisture gradients in wood. *Review of Scientific Instruments*. 73(8): 3093–3100.
- Zelinka, S.L.; Rammer, D.R. 2005. The use of electrochemical impedance spectroscopy (EIS) to measure the corrosion of metals in contact with wood. *TMS Letters*. 2(1): 15–16.
- Zelinka, S.L.; Stone, D.S.; Rammer, D.R. 2007. Equivalent circuit modeling of wood at 12% moisture content. *Wood Fiber Science*. 39(4): 556–565.

Additional References

ASHRAE. 2009. 2009 ASHRAE Handbook—fundamentals. Atlanta, GA: American Society of Heating, Refrigerating and Air-Conditioning Engineers, Inc.

Beall, F.C. 1968. Specific heat of wood—further research required to obtain meaningful data. Res. Note FPL–RN–0184. Madison, WI: U.S. Department of Agriculture, Forest Service, Forest Products Laboratory. 8 p.

Kleuters, W. 1964. Determining local density of wood by beta ray method. *Forest Products Journal*. 14(9): 414.

Kollman, F.F.P.; Côté, W.A., Jr. 1968. Principles of wood science and technology I—solid wood. New York: Springer-Verlag. 592 p.

Kubler, H.; Liang, L.; Chang, L.S. 1973. Thermal expansion of moist wood. *Wood and Fiber*. 5(3): 257–267.

Kukachka, B.F. 1970. Properties of imported tropical woods. Res. Pap. FPL–RP–125. Madison, WI: U.S. Department of Agriculture, Forest Service, Forest Products Laboratory. 67 p.

Lin, R.T. 1967. Review of dielectric properties of wood and cellulose. *Forest Products Journal*. 17(7): 61.

McKenzie, W.M.; Karpovich, H. 1968. Frictional behavior of wood. Munich: Wood Science Technology. 2(2): 138.

Murase, Y. 1980. Frictional properties of wood at high sliding speed. *Journal of the Japanese Wood Research Society*. 26(2): 61–65.

Panshin, A.J.; deZeeuw, C. 1980. Textbook of wood technology. New York: McGraw-Hill. Vol. 1, 4th ed.

Simpson, W.T., ed. 1991. Dry kiln operator's manual. Agric. Handb. AH-188. Madison, WI: U.S. Department of Agriculture, Forest Service, Forest Products Laboratory. 274 p.

Simpson, W.T. 1993. Specific gravity, moisture content, and density relationships for wood. Gen. Tech. Rep. FPL–GTR–76. Madison, WI: U.S. Department of Agriculture, Forest Service, Forest Products Laboratory. 13 p.

Steinhagen, H.P. 1977. Thermal conductive properties of wood, green or dry, from -40° to $+100^{\circ}\text{C}$: a literature review. Gen. Tech. Rep. FPL–GTR–9. Madison, WI: U.S. Department of Agriculture, Forest Service, Forest Products Laboratory. 10 p.

TenWolde, A.; McNatt, J.D.; Krahn, L. 1988. Thermal properties of wood panel products for use in buildings. ORNL/Sub/87–21697/1. Oak Ridge, TN: Oak Ridge National Laboratory. 38 p.

Weatherwax, R.C.; Stamm, A.J. 1947. The coefficients of thermal expansion of wood and wood products. *Transactions of American Society of Mechanical Engineers*. 69(44): 421–432.

Mechanical Properties of Wood

David E. Kretschmann, Research General Engineer

Contents

Orthotropic Nature of Wood	5–1
Elastic Properties	5–2
Modulus of Elasticity	5–2
Poisson’s Ratio	5–2
Modulus of Rigidity	5–3
Strength Properties	5–3
Common Properties	5–3
Less Common Properties	5–15
Vibration Properties	5–17
Speed of Sound	5–17
Internal Friction	5–17
Mechanical Properties of Clear Straight-Grained Wood	5–21
Natural Characteristics Affecting Mechanical Properties	5–26
Specific Gravity	5–26
Knots	5–26
Slope of Grain	5–28
Annual Ring Orientation	5–31
Reaction Wood	5–31
Juvenile Wood	5–32
Compression Failures	5–33
Pitch Pockets	5–33
Bird Peck	5–33
Extractives	5–34
Properties of Timber from Dead Trees	5–34
Effects of Manufacturing and Service Environments	5–34
Temperature	5–35
Time Under Load	5–38
Aging	5–41
Exposure to Chemicals	5–41
Chemical Treatment	5–41
Nuclear Radiation	5–43
Mold and Stain Fungi	5–43
Decay	5–43
Insect Damage	5–44
Literature Cited	5–44
Additional References	5–44

The mechanical properties presented in this chapter were obtained from tests of pieces of wood termed “clear” and “straight grained” because they did not contain characteristics such as knots, cross grain, checks, and splits. These test pieces did have anatomical characteristics such as growth rings that occurred in consistent patterns within each piece. Clear wood specimens are usually considered “homogeneous” in wood mechanics.

Many of the mechanical properties of wood tabulated in this chapter were derived from extensive sampling and analysis procedures. These properties are represented as the average mechanical properties of the species. Some properties, such as tension parallel to the grain, and all properties for some imported species are based on a more limited number of specimens that were not subjected to the same sampling and analysis procedures. The appropriateness of these latter properties to represent the average properties of a species is uncertain; nevertheless, the properties represent the best information available.

Variability, or variation in properties, is common to all materials. Because wood is a natural material and the tree is subject to many constantly changing influences (such as moisture, soil conditions, and growing space), wood properties vary considerably, even in clear material. This chapter provides information, where possible, on the nature and magnitude of variability in properties.

This chapter also includes a discussion of the effect of growth features, such as knots and slope of grain, on clear wood properties. The effects of manufacturing and service environments on mechanical properties are discussed, and their effects on clear wood and material containing growth features are compared. Chapter 7 discusses how these research results have been implemented in engineering standards.

Orthotropic Nature of Wood

Wood may be described as an orthotropic material; that is, it has unique and independent mechanical properties in the directions of three mutually perpendicular axes: longitudinal, radial, and tangential. The longitudinal axis L is parallel to the fiber (grain); the radial axis R is normal to the growth rings (perpendicular to the grain in the radial direction); and the tangential axis T is perpendicular to the grain but tangent to the growth rings. These axes are shown in Figure 5–1.

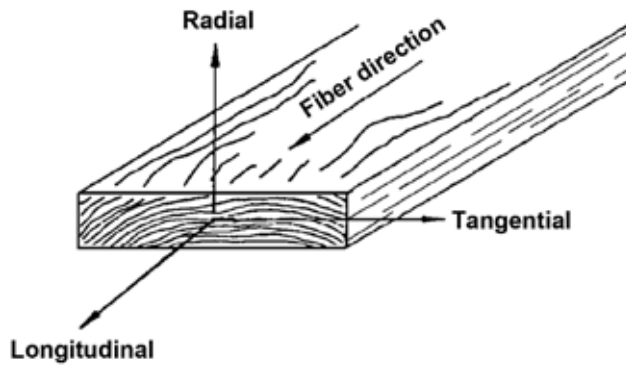

Figure 5–1. Three principal axes of wood with respect to grain direction and growth rings.

Elastic Properties

Twelve constants (nine are independent) are needed to describe the elastic behavior of wood: three moduli of elasticity E , three moduli of rigidity G , and six Poisson’s ratios μ . The moduli of elasticity and Poisson’s ratios are related by expressions of the form

$$\frac{\mu_{ij}}{E_i} = \frac{\mu_{ji}}{E_j}, \quad i \neq j, \quad i, j = L, R, T \quad (5-1)$$

General relations between stress and strain for a homogeneous orthotropic material can be found in texts on anisotropic elasticity.

Modulus of Elasticity

Elasticity implies that deformations produced by low stress are completely recoverable after loads are removed. When loaded to higher stress levels, plastic deformation or failure occurs. The three moduli of elasticity, which are denoted by E_L , E_R , and E_T , respectively, are the elastic moduli along the longitudinal, radial, and tangential axes of wood. These moduli are usually obtained from compression tests; however, data for E_R and E_T are not extensive. Average values of E_R and E_T for samples from a few species are presented in Table 5–1 as ratios with E_L ; the Poisson’s ratios are shown in Table 5–2. The elastic ratios, and the elastic constants themselves, vary within and between species and with moisture content and specific gravity.

The modulus of elasticity determined from bending, E_L , rather than from an axial test, may be the only modulus of elasticity available for a species. Average E_L values obtained from bending tests are given in Tables 5–3 to 5–5. Representative coefficients of variation of E_L determined with bending tests for clear wood are reported in Table 5–6. As tabulated, E_L includes an effect of shear deflection; E_L from bending can be increased by 10% to remove this effect approximately. This adjusted bending E_L can be used to determine E_R and E_T based on the ratios in Table 5–1.

Poisson’s Ratio

When a member is loaded axially, the deformation perpendicular to the direction of the load is proportional to the

Table 5–1. Elastic ratios for various species at approximately 12% moisture content^a

Species	E_T/E_L	E_R/E_L	G_{LR}/E_L	G_{LT}/E_L	G_{RT}/E_L
Hardwoods					
Ash, white	0.080	0.125	0.109	0.077	—
Balsa	0.015	0.046	0.054	0.037	0.005
Basswood	0.027	0.066	0.056	0.046	—
Birch, yellow	0.050	0.078	0.074	0.068	0.017
Cherry, black	0.086	0.197	0.147	0.097	—
Cottonwood, eastern	0.047	0.083	0.076	0.052	—
Mahogany, African	0.050	0.111	0.088	0.059	0.021
Mahogany, Honduras	0.064	0.107	0.066	0.086	0.028
Maple, sugar	0.065	0.132	0.111	0.063	—
Maple, red	0.067	0.140	0.133	0.074	—
Oak, red	0.082	0.154	0.089	0.081	—
Oak, white	0.072	0.163	0.086	—	—
Sweetgum	0.050	0.115	0.089	0.061	0.021
Walnut, black	0.056	0.106	0.085	0.062	0.021
Yellow-poplar	0.043	0.092	0.075	0.069	0.011
Softwoods					
Baldcypress	0.039	0.084	0.063	0.054	0.007
Cedar, northern white	0.081	0.183	0.210	0.187	0.015
Cedar, western red	0.055	0.081	0.087	0.086	0.005
Douglas-fir	0.050	0.068	0.064	0.078	0.007
Fir, subalpine	0.039	0.102	0.070	0.058	0.006
Hemlock, western	0.031	0.058	0.038	0.032	0.003
Larch, western	0.065	0.079	0.063	0.069	0.007
Pine					
Loblolly	0.078	0.113	0.082	0.081	0.013
Lodgepole	0.068	0.102	0.049	0.046	0.005
Longleaf	0.055	0.102	0.071	0.060	0.012
Pond	0.041	0.071	0.050	0.045	0.009
Ponderosa	0.083	0.122	0.138	0.115	0.017
Red	0.044	0.088	0.096	0.081	0.011
Slash	0.045	0.074	0.055	0.053	0.010
Sugar	0.087	0.131	0.124	0.113	0.019
Western white	0.038	0.078	0.052	0.048	0.005
Redwood	0.089	0.087	0.066	0.077	0.011
Spruce, Sitka	0.043	0.078	0.064	0.061	0.003
Spruce, Engelmann	0.059	0.128	0.124	0.120	0.010

^a E_L may be approximated by increasing modulus of elasticity values in Table 5–3 by 10%.

deformation parallel to the direction of the load. The ratio of the transverse to axial strain is called Poisson’s ratio. The Poisson’s ratios are denoted by μ_{LR} , μ_{RL} , μ_{LT} , μ_{TL} , μ_{RT} , and μ_{TR} . The first letter of the subscript refers to direction of applied stress and the second letter to direction of lateral deformation. For example, μ_{LR} is the Poisson’s ratio for deformation along the radial axis caused by stress along the longitudinal axis. Average values of experimentally determined Poisson’s ratios for samples of a few species are given in Table 5–2. The ideal relationship between Poisson’s ratio and the moduli of elasticity given in Equation (5–1) are not always closely met. Two of the Poisson’s ratios, μ_{RL} and μ_{TL} , are very small and are less precisely determined than are those for other Poisson’s ratios. Poisson’s ratios vary within and between species and are affected by moisture content and specific gravity.

Table 5–2. Poisson’s ratios for various species at approximately 12% moisture content

Species	μ_{LR}	μ_{LT}	μ_{RT}	μ_{TR}	μ_{RL}	μ_{TL}
Hardwoods						
Ash, white	0.371	0.440	0.684	0.360	0.059	0.051
Aspen, quaking	0.489	0.374	—	0.496	0.054	0.022
Balsa	0.229	0.488	0.665	0.231	0.018	0.009
Basswood	0.364	0.406	0.912	0.346	0.034	0.022
Birch, yellow	0.426	0.451	0.697	0.426	0.043	0.024
Cherry, black	0.392	0.428	0.695	0.282	0.086	0.048
Cottonwood, eastern	0.344	0.420	0.875	0.292	0.043	0.018
Mahogany, African	0.297	0.641	0.604	0.264	0.033	0.032
Mahogany, Honduras	0.314	0.533	0.600	0.326	0.033	0.034
Maple, sugar	0.424	0.476	0.774	0.349	0.065	0.037
Maple, red	0.434	0.509	0.762	0.354	0.063	0.044
Oak, red	0.350	0.448	0.560	0.292	0.064	0.033
Oak, white	0.369	0.428	0.618	0.300	0.074	0.036
Sweetgum	0.325	0.403	0.682	0.309	0.044	0.023
Walnut, black	0.495	0.632	0.718	0.367	0.052	0.036
Yellow-poplar	0.318	0.392	0.703	0.329	0.030	0.019
Softwoods						
Baldcypress	0.338	0.326	0.411	0.356	—	—
Cedar, northern white	0.337	0.340	0.458	0.345	—	—
Cedar, western red	0.378	0.296	0.484	0.403	—	—
Douglas-fir	0.292	0.449	0.390	0.374	0.036	0.029
Fir, subalpine	0.341	0.332	0.437	0.336	—	—
Hemlock, western	0.485	0.423	0.442	0.382	—	—
Larch, western	0.355	0.276	0.389	0.352	—	—
Pine						
Loblolly	0.328	0.292	0.382	0.362	—	—
Lodgepole	0.316	0.347	0.469	0.381	—	—
Longleaf	0.332	0.365	0.384	0.342	—	—
Pond	0.280	0.364	0.389	0.320	—	—
Ponderosa	0.337	0.400	0.426	0.359	—	—
Red	0.347	0.315	0.408	0.308	—	—
Slash	0.392	0.444	0.447	0.387	—	—
Sugar	0.356	0.349	0.428	0.358	—	—
Western white	0.329	0.344	0.410	0.334	—	—
Redwood	0.360	0.346	0.373	0.400	—	—
Spruce, Sitka	0.372	0.467	0.435	0.245	0.040	0.025
Spruce, Engelmann	0.422	0.462	0.530	0.255	0.083	0.058

Modulus of Rigidity

The modulus of rigidity, also called shear modulus, indicates the resistance to deflection of a member caused by shear stresses. The three moduli of rigidity denoted by G_{LR} , G_{LT} , and G_{RT} are the elastic constants in the LR , LT , and RT planes, respectively. For example, G_{LR} is the modulus of rigidity based on shear strain in the LR plane and shear stresses in the LT and RT planes. Average values of shear moduli for samples of a few species expressed as ratios with E_L are given in Table 5–1. As with moduli of elasticity, the moduli of rigidity vary within and between species and with moisture content and specific gravity.

Strength Properties

Common Properties

Mechanical properties most commonly measured and represented as “strength properties” for design include modulus

of rupture in bending, maximum stress in compression parallel to grain, compressive stress perpendicular to grain, and shear strength parallel to grain. Additional measurements are often made to evaluate work to maximum load in bending, impact bending strength, tensile strength perpendicular to grain, and hardness. These properties, grouped according to the broad forest tree categories of hardwood and softwood (not correlated with hardness or softness), are given in Tables 5–3 to 5–5 for many of the commercially important species. Average coefficients of variation for these properties from a limited sampling of specimens are reported in Table 5–6.

Modulus of rupture—Reflects the maximum load-carrying capacity of a member in bending and is proportional to maximum moment borne by the specimen. Modulus of rupture is an accepted criterion of strength, although it is not a true stress because the formula by which it is computed is valid only to the elastic limit.

Work to maximum load in bending—Ability to absorb shock with some permanent deformation and more or less injury to a specimen. Work to maximum load is a measure of the combined strength and toughness of wood under bending stresses.

Compressive strength parallel to grain—Maximum stress sustained by a compression parallel-to-grain specimen having a ratio of length to least dimension of less than 11.

Compressive stress perpendicular to grain—Reported as stress at proportional limit. There is no clearly defined ultimate stress for this property.

Shear strength parallel to grain—Ability to resist internal slipping of one part upon another along the grain. Values presented are average strength in radial and tangential shear planes.

Impact bending—In the impact bending test, a hammer of given weight is dropped upon a beam from successively increased heights until rupture occurs or the beam deflects 152 mm (6 in.) or more. The height of the maximum drop, or the drop that causes failure, is a comparative value that represents the ability of wood to absorb shocks that cause stresses beyond the proportional limit.

Tensile strength perpendicular to grain—Resistance of wood to forces acting across the grain that tend to split a member. Values presented are the average of radial and tangential observations.

Hardness—Generally defined as resistance to indentation using a modified Janka hardness test, measured by the load required to embed a 11.28-mm (0.444-in.) ball to one-half its diameter. Values presented are the average of radial and tangential penetrations.

Tensile strength parallel to grain—Maximum tensile stress sustained in direction parallel to grain. Relatively few data are available on the tensile strength of various species

Table 5–3a. Strength properties of some commercially important woods grown in the United States (metric)^a

Common species names	Moisture content	Specific gravity ^b	Static bending			Impact bending (mm)	Compression parallel to grain (kPa)	Compression perpendicular to grain (kPa)	Shear parallel to grain (kPa)	Tension perpendicular to grain (kPa)	Side hardness (N)
			Modulus of rupture (kPa)	Modulus of elasticity ^c (MPa)	Work to maximum load (kJ m ⁻³)						
Hardwoods											
Alder, red	Green	0.37	45,000	8,100	55	560	20,400	1,700	5,300	2,700	2,000
	12%	0.41	68,000	9,500	58	510	40,100	3,000	7,400	2,900	2,600
Ash											
Black	Green	0.45	41,000	7,200	83	840	15,900	2,400	5,900	3,400	2,300
	12%	0.49	87,000	11,000	103	890	41,200	5,200	10,800	4,800	3,800
Blue	Green	0.53	66,000	8,500	101	—	28,800	5,600	10,600	—	—
	12%	0.58	95,000	9,700	99	—	48,100	9,800	14,000	—	—
Green	Green	0.53	66,000	9,700	81	890	29,000	5,000	8,700	4,100	3,900
	12%	0.56	97,000	11,400	92	810	48,800	9,000	13,200	4,800	5,300
Oregon	Green	0.50	52,000	7,800	84	990	24,200	3,700	8,200	4,100	3,500
	12%	0.55	88,000	9,400	99	840	41,600	8,600	12,300	5,000	5,200
White	Green	0.55	66,000	9,900	108	970	27,500	4,600	9,300	4,100	4,300
	12%	0.60	103,000	12,000	115	1,090	51,100	8,000	13,200	6,500	5,900
Aspen											
Bigtooth	Green	0.36	37,000	7,700	39	—	17,200	1,400	5,000	—	—
	12%	0.39	63,000	9,900	53	—	36,500	3,100	7,400	—	—
Quaking	Green	0.35	35,000	5,900	44	560	14,800	1,200	4,600	1,600	1,300
	12%	0.38	58,000	8,100	52	530	29,300	2,600	5,900	1,800	1,600
Basswood, American	Green	0.32	34,000	7,200	37	410	15,300	1,200	4,100	1,900	1,100
	12%	0.37	60,000	10,100	50	410	32,600	2,600	6,800	2,400	1,800
Beech, American	Green	0.56	59,000	9,500	82	1,090	24,500	3,700	8,900	5,000	3,800
	12%	0.64	103,000	11,900	104	1,040	50,300	7,000	13,900	7,000	5,800
Birch											
Paper	Green	0.48	44,000	8,100	112	1,240	16,300	1,900	5,800	2,600	2,500
	12%	0.55	85,000	11,000	110	860	39,200	4,100	8,300	—	4,000
Sweet	Green	0.60	65,000	11,400	108	1,220	25,800	3,200	8,500	3,000	4,300
	12%	0.65	117,000	15,000	124	1,190	58,900	7,400	15,400	6,600	6,500
Yellow	Green	0.55	57,000	10,300	111	1,220	23,300	3,000	7,700	3,000	3,600
	12%	0.62	114,000	13,900	143	1,400	56,300	6,700	13,000	6,300	5,600
Butternut	Green	0.36	37,000	6,700	57	610	16,700	1,500	5,200	3,000	1,700
	12%	0.38	56,000	8,100	57	610	36,200	3,200	8,100	3,000	2,200
Cherry, black	Green	0.47	55,000	9,000	88	840	24,400	2,500	7,800	3,900	2,900
	12%	0.50	85,000	10,300	79	740	49,000	4,800	11,700	3,900	4,200
Chestnut, American	Green	0.40	39,000	6,400	48	610	17,000	2,100	5,500	3,000	1,900
	12%	0.43	59,000	8,500	45	480	36,700	4,300	7,400	3,200	2,400
Cottonwood											
Balsam poplar	Green	0.31	27,000	5,200	29	—	11,700	1,000	3,400	—	—
	12%	0.34	47,000	7,600	34	—	27,700	2,100	5,400	—	—
Black	Green	0.31	34,000	7,400	34	510	15,200	1,100	4,200	1,900	1,100
	12%	0.35	59,000	8,800	46	560	31,000	2,100	7,200	2,300	1,600
Eastern	Green	0.37	37,000	7,000	50	530	15,700	1,400	4,700	2,800	1,500
	12%	0.40	59,000	9,400	51	510	33,900	2,600	6,400	4,000	1,900
Elm											
American	Green	0.46	50,000	7,700	81	970	20,100	2,500	6,900	4,100	2,800
	12%	0.50	81,000	9,200	90	990	38,100	4,800	10,400	4,600	3,700
Rock	Green	0.57	66,000	8,200	137	1,370	26,100	4,200	8,800	—	—
	12%	0.63	102,000	10,600	132	1,420	48,600	8,500	13,200	—	—
Slippery	Green	0.48	55,000	8,500	106	1,190	22,900	2,900	7,700	4,400	2,900
	12%	0.53	90,000	10,300	117	1,140	43,900	5,700	11,200	3,700	3,800
Hackberry	Green	0.49	45,000	6,600	100	1,220	18,300	2,800	7,400	4,300	3,100
	12%	0.53	76,000	8,200	88	1,090	37,500	6,100	11,000	4,000	3,900

Table 5–3a. Strength properties of some commercially important woods grown in the United States (metric)^a—con.

Common species names	Moisture content	Specific gravity ^b	Static bending				Impact bending (mm)	Compression parallel to grain (kPa)	Compression perpendicular to grain (kPa)	Shear parallel to grain (kPa)	Tension perpendicular to grain (kPa)	Side hardness (N)
			Modulus of rupture (kPa)	Modulus of elasticity ^c (MPa)	Work to maximum load (kJ m ⁻³)							
Hickory, pecan												
Bitternut	Green	0.60	71,000	9,700	138	1,680	31,500	5,500	8,500	—	—	
	12%	0.66	118,000	12,300	125	1,680	62,300	11,600	—	—	—	
Nutmeg	Green	0.56	63,000	8,900	157	1,370	27,400	5,200	7,100	—	—	
	12%	0.60	114,000	11,700	173	—	47,600	10,800	—	—	—	
Pecan	Green	0.60	68,000	9,400	101	1,350	27,500	5,400	10,200	4,700	5,800	
	12%	0.66	94,000	11,900	95	1,120	54,100	11,900	14,300	—	8,100	
Water	Green	0.61	74,000	10,800	130	1,420	32,100	6,100	9,900	—	—	
	12%	0.62	123,000	13,900	133	1,350	59,300	10,700	—	—	—	
Hickory, true ^d												
Mockernut	Green	0.64	77,000	10,800	180	2,240	30,900	5,600	8,800	—	6,400	
	12%	0.72	132,000	15,300	156	1,960	61,600	11,900	12,000	—	8,800	
Pignut	Green	0.66	81,000	11,400	219	2,260	33,200	6,300	9,400	—	6,800	
	12%	0.75	139,000	15,600	210	1,880	63,400	13,700	14,800	—	9,500	
Shagbark	Green	0.64	76,000	10,800	163	1,880	31,600	5,800	10,500	—	6,500	
	12%	0.72	139,000	14,900	178	1,700	63,500	12,100	16,800	—	8,400	
Shellbark	Green	0.62	72,000	9,200	206	2,640	27,000	5,600	8,200	—	7,400	
	12%	0.69	125,000	13,000	163	2,240	55,200	12,400	14,500	—	8,100	
Honeylocust	Green	0.60	70,000	8,900	87	1,190	30,500	7,900	11,400	6,400	6,200	
	12%	—	101,000	11,200	92	1,190	51,700	12,700	15,500	6,200	7,000	
Locust, black	Green	0.66	95,000	12,800	106	1,120	46,900	8,000	12,100	5,300	7,000	
	12%	0.69	134,000	14,100	127	1,450	70,200	12,600	17,100	4,400	7,600	
Magnolia												
Cucumbertree	Green	0.44	51,000	10,800	69	760	21,600	2,300	6,800	3,000	2,300	
	12%	0.48	85,000	12,500	84	890	43,500	3,900	9,200	4,600	3,100	
Southern	Green	0.46	47,000	7,700	106	1,370	18,600	3,200	7,200	4,200	3,300	
	12%	0.50	77,000	9,700	88	740	37,600	5,900	10,500	5,100	4,500	
Maple												
Bigleaf	Green	0.44	51,000	7,600	60	580	22,300	3,100	7,700	4,100	2,800	
	12%	0.48	74,000	10,000	54	710	41,000	5,200	11,900	3,700	3,800	
Black	Green	0.52	54,000	9,200	88	1,220	22,500	4,100	7,800	5,000	3,700	
	12%	0.57	92,000	11,200	86	1,020	46,100	7,000	12,500	4,600	5,200	
Red	Green	0.49	53,000	9,600	79	810	22,600	2,800	7,900	—	3,100	
	12%	0.54	92,000	11,300	86	810	45,100	6,900	12,800	—	4,200	
Silver	Green	0.44	40,000	6,500	76	740	17,200	2,600	7,200	3,900	2,600	
	12%	0.47	61,000	7,900	57	640	36,000	5,100	10,200	3,400	3,100	
Sugar	Green	0.56	65,000	10,700	92	1,020	27,700	4,400	10,100	—	4,300	
	12%	0.63	109,000	12,600	114	990	54,000	10,100	16,100	—	6,400	
Oak, red												
Black	Green	0.56	57,000	8,100	84	1,020	23,900	4,900	8,400	—	4,700	
	12%	0.61	96,000	11,300	94	1,040	45,000	6,400	13,200	—	5,400	
Cherrybark	Green	0.61	74,000	12,300	101	1,370	31,900	5,200	9,100	5,500	5,500	
	12%	0.68	125,000	15,700	126	1,240	60,300	8,600	13,800	5,800	6,600	
Laurel	Green	0.56	54,000	9,600	77	990	21,900	3,900	8,100	5,300	4,400	
	12%	0.63	87,000	11,700	81	990	48,100	7,300	12,600	5,400	5,400	
Northern red	Green	0.56	57,000	9,300	91	1,120	23,700	4,200	8,300	5,200	4,400	
	12%	0.63	99,000	12,500	100	1,090	46,600	7,000	12,300	5,500	5,700	
Pin	Green	0.58	57,000	9,100	97	1,220	25,400	5,000	8,900	5,500	4,800	
	12%	0.63	97,000	11,900	102	1,140	47,000	7,000	14,300	7,200	6,700	
Scarlet	Green	0.60	72,000	10,200	103	1,370	28,200	5,700	9,700	4,800	5,300	
	12%	0.67	120,000	13,200	141	1,350	57,400	7,700	13,000	6,000	6,200	
Southern red	Green	0.52	48,000	7,900	55	740	20,900	3,800	6,400	3,300	3,800	
	12%	0.59	75,000	10,300	65	660	42,000	6,000	9,600	3,500	4,700	
Water	Green	0.56	61,000	10,700	77	990	25,800	4,300	8,500	5,700	4,500	
	12%	0.63	106,000	13,900	148	1,120	46,700	7,000	13,900	6,300	5,300	

Table 5–3a. Strength properties of some commercially important woods grown in the United States (metric)^a—con.

Common species names	Moisture content	Specific gravity ^b	Static bending				Impact bending (mm)	Compression parallel to grain (kPa)	Compression perpendicular to grain (kPa)	Shear parallel to grain (kPa)	Tension perpendicular to grain (kPa)	Side hardness (N)
			Modulus of rupture (kPa)	Modulus of elasticity ^c (MPa)	Work to maximum load (kJ m ⁻³)							
Cedar—con.												
Port-Orford	Green	0.39	45,000	9,000	51	530	21,600	2,100	5,800	1,200	1,700	
	12%	0.43	88,000	11,700	63	710	43,100	5,000	9,400	2,800	2,800	
Western redcedar	Green	0.31	35,900	6,500	34	430	19,100	1,700	5,300	1,600	1,200	
	12%	0.32	51,700	7,700	40	430	31,400	3,200	6,800	1,500	1,600	
Yellow	Green	0.42	44,000	7,900	63	690	21,000	2,400	5,800	2,300	2,000	
	12%	0.44	77,000	9,800	72	740	43,500	4,300	7,800	2,500	2,600	
Douglas-fir ^c												
Coast	Green	0.45	53,000	10,800	52	660	26,100	2,600	6,200	2,100	2,200	
	12%	0.48	85,000	13,400	68	790	49,900	5,500	7,800	2,300	3,200	
Interior West	Green	0.46	53,000	10,400	50	660	26,700	2,900	6,500	2,000	2,300	
	12%	0.50	87,000	12,600	73	810	51,200	5,200	8,900	2,400	2,900	
Interior North	Green	0.45	51,000	9,700	56	560	23,900	2,500	6,600	2,300	1,900	
	12%	0.48	90,000	12,300	72	660	47,600	5,300	9,700	2,700	2,700	
Interior South	Green	0.43	47,000	8,000	55	380	21,400	2,300	6,600	1,700	1,600	
	12%	0.46	82,000	10,300	62	510	43,000	5,100	10,400	2,300	2,300	
Fir												
Balsam	Green	0.33	38,000	8,600	32	410	18,100	1,300	4,600	1,200	1,300	
	12%	0.35	63,000	10,000	35	510	36,400	2,800	6,500	1,200	1,700	
California red	Green	0.36	40,000	8,100	44	530	19,000	2,300	5,300	2,600	1,600	
	12%	0.38	72,400	10,300	61	610	37,600	4,200	7,200	2,700	2,200	
Grand	Green	0.35	40,000	8,600	39	560	20,300	1,900	5,100	1,700	1,600	
	12%	0.37	61,400	10,800	52	710	36,500	3,400	6,200	1,700	2,200	
Noble	Green	0.37	43,000	9,500	41	480	20,800	1,900	5,500	1,600	1,300	
	12%	0.39	74,000	11,900	61	580	42,100	3,600	7,200	1,500	1,800	
Pacific silver	Green	0.40	44,000	9,800	41	530	21,600	1,500	5,200	1,700	1,400	
	12%	0.43	75,800	12,100	64	610	44,200	3,100	8,400	—	1,900	
Subalpine	Green	0.31	34,000	7,200	—	—	15,900	1,300	4,800	—	1,200	
	12%	0.32	59,000	8,900	—	—	33,500	2,700	7,400	—	1,600	
White	Green	0.37	41,000	8,000	39	560	20,000	1,900	5,200	2,100	1,500	
	12%	0.39	68,000	10,300	50	510	40,000	3,700	7,600	2,100	2,100	
Hemlock												
Eastern	Green	0.38	44,000	7,400	46	530	21,200	2,500	5,900	1,600	1,800	
	12%	0.40	61,000	8,300	47	530	37,300	4,500	7,300	—	2,200	
Mountain	Green	0.42	43,000	7,200	76	810	19,900	2,600	6,400	2,300	2,100	
	12%	0.45	79,000	9,200	72	810	44,400	5,900	10,600	—	3,000	
Western	Green	0.42	46,000	9,000	48	560	23,200	1,900	5,900	2,000	1,800	
	12%	0.45	78,000	11,300	57	580	49,000	3,800	8,600	2,300	2,400	
Larch, western	Green	0.48	53,000	10,100	71	740	25,900	2,800	6,000	2,300	2,300	
	12%	0.52	90,000	12,900	87	890	52,500	6,400	9,400	3,000	3,700	
Pine												
Eastern white	Green	0.34	34,000	6,800	36	430	16,800	1,500	4,700	1,700	1,300	
	12%	0.35	59,000	8,500	47	460	33,100	3,000	6,200	2,100	1,700	
Jack	Green	0.40	41,000	7,400	50	660	20,300	2,100	5,200	2,500	1,800	
	12%	0.43	68,000	9,300	57	690	39,000	4,000	8,100	2,900	2,500	
Loblolly	Green	0.47	50,000	9,700	57	760	24,200	2,700	5,900	1,800	2,000	
	12%	0.51	88,000	12,300	72	760	49,200	5,400	9,600	3,200	3,100	
Lodgepole	Green	0.38	38,000	7,400	39	510	18,000	1,700	4,700	1,500	1,500	
	12%	0.41	65,000	9,200	47	510	37,000	4,200	6,100	2,000	2,100	
Longleaf	Green	0.54	59,000	11,000	61	890	29,800	3,300	7,200	2,300	2,600	
	12%	0.59	100,000	13,700	81	860	58,400	6,600	10,400	3,200	3,900	
Pitch	Green	0.47	47,000	8,300	63	—	20,300	2,500	5,900	—	—	
	12%	0.52	74,000	9,900	63	—	41,000	5,600	9,400	—	—	

Table 5–3a. Strength properties of some commercially important woods grown in the United States (metric)^a—con.

Common species names	Moisture content	Specific gravity ^b	Static bending				Impact bending (mm)	Compression parallel to grain (kPa)	Compression perpendicular to grain (kPa)	Shear parallel to grain (kPa)	Tension perpendicular to grain (kPa)	Side hardness (N)
			Modulus of rupture (kPa)	Modulus of elasticity ^c (MPa)	Work to maximum load (kJ m ⁻³)							
Pine—con.												
Pond	Green	0.51	51,000	8,800	52	—	25,200	3,000	6,500	—	—	
	12%	0.56	80,000	12,100	59	—	52,000	6,300	9,500	—	—	
Ponderosa	Green	0.38	35,000	6,900	36	530	16,900	1,900	4,800	2,100	1,400	
	12%	0.40	65,000	8,900	49	480	36,700	4,000	7,800	2,900	2,000	
Red	Green	0.41	40,000	8,800	42	660	18,800	1,800	4,800	2,100	1,500	
	12%	0.46	76,000	11,200	68	660	41,900	4,100	8,400	3,200	2,500	
Sand	Green	0.46	52,000	7,000	66	—	23,700	3,100	7,900	—	—	
	12%	0.48	80,000	9,700	66	—	47,700	5,800	—	—	—	
Shortleaf	Green	0.47	51,000	9,600	57	760	24,300	2,400	6,300	2,200	2,000	
	12%	0.51	90,000	12,100	76	840	50,100	5,700	9,600	3,200	3,100	
Slash	Green	0.54	60,000	10,500	66	—	26,300	3,700	6,600	—	—	
	12%	0.59	112,000	13,700	91	—	56,100	7,000	11,600	—	—	
Spruce	Green	0.41	41,000	6,900	—	—	19,600	1,900	6,200	—	2,000	
	12%	0.44	72,000	8,500	—	—	39,000	5,000	10,300	—	2,900	
Sugar	Green	0.34	34,000	7,100	37	430	17,000	1,400	5,000	1,900	1,200	
	12%	0.36	57,000	8,200	38	460	30,800	3,400	7,800	2,400	1,700	
Virginia	Green	0.45	50,000	8,400	75	860	23,600	2,700	6,100	2,800	2,400	
	12%	0.48	90,000	10,500	94	810	46,300	6,300	9,300	2,600	3,300	
Western white	Green	0.36	32,000	8,200	34	480	16,800	1,300	4,700	1,800	1,200	
	12%	0.35	67,000	10,100	61	580	34,700	3,200	7,200	—	1,900	
Redwood												
Old-growth	Green	0.38	52,000	8,100	51	530	29,000	2,900	5,500	1,800	1,800	
	12%	0.40	69,000	9,200	48	480	42,400	4,800	6,500	1,700	2,100	
Young-growth	Green	0.34	41,000	6,600	39	410	21,400	1,900	6,100	2,100	1,600	
	12%	0.35	54,000	7,600	36	380	36,000	3,600	7,600	1,700	1,900	
Spruce												
Black	Green	0.38	42,000	9,500	51	610	19,600	1,700	5,100	700	1,500	
	12%	0.42	74,000	11,100	72	580	41,100	3,800	8,500	—	2,400	
Engelmann	Green	0.33	32,000	7,100	35	410	15,000	1,400	4,400	1,700	1,150	
	12%	0.35	64,000	8,900	44	460	30,900	2,800	8,300	2,400	1,750	
Red	Green	0.37	41,000	9,200	48	460	18,800	1,800	5,200	1,500	1,600	
	12%	0.40	74,000	11,400	58	640	38,200	3,800	8,900	2,400	2,200	
Sitka	Green	0.37	39,000	8,500	43	610	18,400	1,900	5,200	1,700	1,600	
	12%	0.40	70,000	10,800	65	640	38,700	4,000	7,900	2,600	2,300	
White	Green	0.33	34,000	7,900	41	560	16,200	1,400	4,400	1,500	1,200	
	12%	0.36	65,000	9,600	53	510	35,700	3,000	6,700	2,500	1,800	
Tamarack	Green	0.49	50,000	8,500	50	710	24,000	2,700	5,900	1,800	1,700	
	12%	0.53	80,000	11,300	49	580	49,400	5,500	8,800	2,800	2,600	

^aResults of tests on clear specimens in the green and air-dried conditions, converted to metric units directly from Table 5–3b. Definition of properties: impact bending is height of drop that causes complete failure, using 0.71-kg (50-lb) hammer; compression parallel to grain is also called maximum crushing strength; compression perpendicular to grain is fiber stress at proportional limit; shear is maximum shearing strength; tension is maximum tensile strength; and side hardness is hardness measured when load is perpendicular to grain.

^bSpecific gravity is based on weight when oven-dry and volume when green or at 12% moisture content.

^cModulus of elasticity measured from a simply supported, center-loaded beam, on a span depth ratio of 14/1. To correct for shear deflection, the modulus can be increased by 10%.

^dValues for side hardness of the true hickories are from Bendtsen and Ethington (1975).

^eCoast Douglas-fir is defined as Douglas-fir growing in Oregon and Washington State west of the Cascade Mountains summit. Interior West includes California and all counties in Oregon and Washington east of, but adjacent to, the Cascade summit; Interior North, the remainder of Oregon and Washington plus Idaho, Montana, and Wyoming; and Interior South, Utah, Colorado, Arizona, and New Mexico.

Table 5–3b. Strength properties of some commercially important woods grown in the United States (inch–pound)^a

Common species names	Moisture content	Specific gravity ^b	Static bending					Compression parallel to grain (lbf in ⁻²)	Compression perpendicular to grain (lbf in ⁻²)	Shear parallel to grain (lbf in ⁻²)	Tension perpendicular to grain (lbf in ⁻²)	Side hardness (lbf)
			Modulus of rupture (lbf in ⁻²)	Modulus of elasticity ^c (×10 ⁶ lbf in ⁻²)	Work to maximum load (in-lbf in ⁻³)	Impact bending (in.)						
Hardwoods												
Alder, red	Green	0.37	6,500	1.17	8.0	22	2,960	250	770	390	440	
	12%	0.41	9,800	1.38	8.4	20	5,820	440	1,080	420	590	
Ash												
Black	Green	0.45	6,000	1.04	12.1	33	2,300	350	860	490	520	
	12%	0.49	12,600	1.60	14.9	35	5,970	760	1,570	700	850	
Blue	Green	0.53	9,600	1.24	14.7	—	4,180	810	1,540	—	—	
	12%	0.58	13,800	1.40	14.4	—	6,980	1,420	2,030	—	—	
Green	Green	0.53	9,500	1.40	11.8	35	4,200	730	1,260	590	870	
	12%	0.56	14,100	1.66	13.4	32	7,080	1,310	1,910	700	1,200	
Oregon	Green	0.50	7,600	1.13	12.2	39	3,510	530	1,190	590	790	
	12%	0.55	12,700	1.36	14.4	33	6,040	1,250	1,790	720	1,160	
White	Green	0.55	9,500	1.44	15.7	38	3,990	670	1,350	590	960	
	12%	0.60	15,000	1.74	16.6	43	7,410	1,160	1,910	940	1,320	
Aspen												
Bigtooth	Green	0.36	5,400	1.12	5.7	—	2,500	210	730	—	—	
	12%	0.39	9,100	1.43	7.7	—	5,300	450	1,080	—	—	
Quaking	Green	0.35	5,100	0.86	6.4	22	2,140	180	660	230	300	
	12%	0.38	8,400	1.18	7.6	21	4,250	370	850	260	350	
Basswood, American	Green	0.32	5,000	1.04	5.3	16	2,220	170	600	280	250	
	12%	0.37	8,700	1.46	7.2	16	4,730	370	990	350	410	
Beech, American	Green	0.56	8,600	1.38	11.9	43	3,550	540	1,290	720	850	
	12%	0.64	14,900	1.72	15.1	41	7,300	1,010	2,010	1,010	1,300	
Birch												
Paper	Green	0.48	6,400	1.17	16.2	49	2,360	270	840	380	560	
	12%	0.55	12,300	1.59	16.0	34	5,690	600	1,210	—	910	
Sweet	Green	0.60	9,400	1.65	15.7	48	3,740	470	1,240	430	970	
	12%	0.65	16,900	2.17	18.0	47	8,540	1,080	2,240	950	1,470	
Yellow	Green	0.55	8,300	1.50	16.1	48	3,380	430	1,110	430	780	
	12%	0.62	16,600	2.01	20.8	55	8,170	970	1,880	920	1,260	
Butternut	Green	0.36	5,400	0.97	8.2	24	2,420	220	760	430	390	
	12%	0.38	8,100	1.18	8.2	24	5,110	460	1,170	440	490	
Cherry, black	Green	0.47	8,000	1.31	12.8	33	3,540	360	1,130	570	660	
	12%	0.50	12,300	1.49	11.4	29	7,110	690	1,700	560	950	
Chestnut, American	Green	0.40	5,600	0.93	7.0	24	2,470	310	800	440	420	
	12%	0.43	8,600	1.23	6.5	19	5,320	620	1,080	460	540	
Cottonwood												
Balsam, poplar	Green	0.31	3,900	0.75	4.2	—	1,690	140	500	—	—	
	12%	0.34	6,800	1.10	5.0	—	4,020	300	790	—	—	
Black	Green	0.31	4,900	1.08	5.0	20	2,200	160	610	270	250	
	12%	0.35	8,500	1.27	6.7	22	4,500	300	1,040	330	350	
Eastern	Green	0.37	5,300	1.01	7.3	21	2,280	200	680	410	340	
	12%	0.40	8,500	1.37	7.4	20	4,910	380	930	580	430	
Elm												
American	Green	0.46	7,200	1.11	11.8	38	2,910	360	1,000	590	620	
	12%	0.50	11,800	1.34	13.0	39	5,520	690	1,510	660	830	
Rock	Green	0.57	9,500	1.19	19.8	54	3,780	610	1,270	—	940	
	12%	0.63	14,800	1.54	19.2	56	7,050	1,230	1,920	—	1,320	
Slippery	Green	0.48	8,000	1.23	15.4	47	3,320	420	1,110	640	660	
	12%	0.53	13,000	1.49	16.9	45	6,360	820	1,630	530	860	
Hackberry	Green	0.49	6,500	0.95	14.5	48	2,650	400	1,070	630	700	
	12%	0.53	11,000	1.19	12.8	43	5,440	890	1,590	580	880	

Table 5–3b. Strength properties of some commercially important woods grown in the United States (inch–pound)^a—con.

Common species names	Moisture content	Specific gravity ^b	Static bending					Compression parallel to grain (lbf in ⁻²)	Compression perpendicular to grain (lbf in ⁻²)	Shear parallel to grain (lbf in ⁻²)	Tension perpendicular to grain (lbf in ⁻²)	Side hardness (lbf)
			Modulus of rupture (lbf in ⁻²)	Modulus of elasticity ^c (×10 ⁶ lbf in ⁻²)	Work to maximum load (in-lbf in ⁻³)	Impact bending (in.)						
Hickory, pecan												
Bitternut	Green	0.60	10,300	1.40	20.0	66	4,570	800	1,240	—	—	
	12%	0.66	17,100	1.79	18.2	66	9,040	1,680	—	—	—	
Nutmeg	Green	0.56	9,100	1.29	22.8	54	3,980	760	1,030	—	—	
	12%	0.60	16,600	1.70	25.1	—	6,910	1,570	—	—	—	
Pecan	Green	0.60	9,800	1.37	14.6	53	3,990	780	1,480	680	1,310	
	12%	0.66	13,700	1.73	13.8	44	7,850	1,720	2,080	—	1,820	
Water	Green	0.61	10,700	1.56	18.8	56	4,660	880	1,440	—	—	
	12%	0.62	17,800	2.02	19.3	53	8,600	1,550	—	—	—	
Hickory, true ^d												
Mockernut	Green	0.64	11,100	1.57	26.1	88	4,480	810	1,280	—	1,440	
	12%	0.72	19,200	2.22	22.6	77	8,940	1,730	1,740	—	1,970	
Pignut	Green	0.66	11,700	1.65	31.7	89	4,810	920	1,370	—	1,520	
	12%	0.75	20,100	2.26	30.4	74	9,190	1,980	2,150	—	2,140	
Shagbark	Green	0.64	11,000	1.57	23.7	74	4,580	840	1,520	—	1,460	
	12%	0.72	20,200	2.16	25.8	67	9,210	1,760	2,430	—	1,880	
Shellbark	Green	0.62	10,500	1.34	29.9	104	3,920	810	1,190	—	1,670	
	12%	0.69	18,100	1.89	23.6	88	8,000	1,800	2,110	—	1,810	
Honeylocust	Green	0.60	10,200	1.29	12.6	47	4,420	1,150	1,660	930	1,390	
	12%	—	14,700	1.63	13.3	47	7,500	1,840	2,250	900	1,580	
Locust, black	Green	0.66	13,800	1.85	15.4	44	6,800	1,160	1,760	770	1,570	
	12%	0.69	19,400	2.05	18.4	57	10,180	1,830	2,480	640	1,700	
Magnolia												
Cucumbertree	Green	0.44	7,400	1.56	10.0	30	3,140	330	990	440	520	
	12%	0.48	12,300	1.82	12.2	35	6,310	570	1,340	660	700	
Southern	Green	0.46	6,800	1.11	15.4	54	2,700	460	1,040	610	740	
	12%	0.50	11,200	1.40	12.8	29	5,460	860	1,530	740	1,020	
Maple												
Bigleaf	Green	0.44	7,400	1.10	8.7	23	3,240	450	1,110	600	620	
	12%	0.48	10,700	1.45	7.8	28	5,950	750	1,730	540	850	
Black	Green	0.52	7,900	1.33	12.8	48	3,270	600	1,130	720	840	
	12%	0.57	13,300	1.62	12.5	40	6,680	1,020	1,820	670	1,180	
Red	Green	0.49	7,700	1.39	11.4	32	3,280	400	1,150	—	700	
	12%	0.54	13,400	1.64	12.5	32	6,540	1,000	1,850	—	950	
Silver	Green	0.44	5,800	0.94	11.0	29	2,490	370	1,050	560	590	
	12%	0.47	8,900	1.14	8.3	25	5,220	740	1,480	500	700	
Sugar	Green	0.56	9,400	1.55	13.3	40	4,020	640	1,460	—	970	
	12%	0.63	15,800	1.83	16.5	39	7,830	1,470	2,330	—	1,450	
Oak, red												
Black	Green	0.56	8,200	1.18	12.2	40	3,470	710	1,220	—	1,060	
	12%	0.61	13,900	1.64	13.7	41	6,520	930	1,910	—	1,210	
Cherrybark	Green	0.61	10,800	1.79	14.7	54	4,620	760	1,320	800	1,240	
	12%	0.68	18,100	2.28	18.3	49	8,740	1,250	2,000	840	1,480	
Laurel	Green	0.56	7,900	1.39	11.2	39	3,170	570	1,180	770	1,000	
	12%	0.63	12,600	1.69	11.8	39	6,980	1,060	1,830	790	1,210	
Northern red	Green	0.56	8,300	1.35	13.2	44	3,440	610	1,210	750	1,000	
	12%	0.63	14,300	1.82	14.5	43	6,760	1,010	1,780	800	1,290	
Pin	Green	0.58	8,300	1.32	14.0	48	3,680	720	1,290	800	1,070	
	12%	0.63	14,000	1.73	14.8	45	6,820	1,020	2,080	1,050	1,510	
Scarlet	Green	0.60	10,400	1.48	15.0	54	4,090	830	1,410	700	1,200	
	12%	0.67	17,400	1.91	20.5	53	8,330	1,120	1,890	870	1,400	
Southern red	Green	0.52	6,900	1.14	8.0	29	3,030	550	930	480	860	
	12%	0.59	10,900	1.49	9.4	26	6,090	870	1,390	510	1,060	

Table 5-3b. Strength properties of some commercially important woods grown in the United States (inch-pound)^a—con.

Common species names	Moisture content	Specific gravity ^b	Static bending				Impact bending (in.)	Compression parallel to grain (lbf in ⁻²)	Compression perpendicular to grain (lbf in ⁻²)	Shear parallel to grain (lbf in ⁻²)	Tension perpendicular to grain (lbf in ⁻²)	Side hardness (lbf)
			Modulus of rupture (lbf in ⁻²)	Modulus of elasticity ^c (×10 ⁶ lbf in ⁻²)	Work to maximum load (in-lbf in ⁻³)							
Oak, red—con.												
Water	Green	0.56	8,900	1.55	11.1	39	3,740	620	1,240	820	1,010	
	12%	0.63	15,400	2.02	21.5	44	6,770	1,020	2,020	920	1,190	
Willow	Green	0.56	7,400	1.29	8.8	35	3,000	610	1,180	760	980	
	12%	0.69	14,500	1.90	14.6	42	7,040	1,130	1,650	—	1,460	
Oak, white												
Bur	Green	0.58	7,200	0.88	10.7	44	3,290	680	1,350	800	1,110	
	12%	0.64	10,300	1.03	9.8	29	6,060	1,200	1,820	680	1,370	
Chestnut	Green	0.57	8,000	1.37	9.4	35	3,520	530	1,210	690	890	
	12%	0.66	13,300	1.59	11.0	40	6,830	840	1,490	—	1,130	
Live	Green	0.80	11,900	1.58	12.3	—	5,430	2,040	2,210	—	—	
	12%	0.88	18,400	1.98	18.9	—	8,900	2,840	2,660	—	—	
Overcup	Green	0.57	8,000	1.15	12.6	44	3,370	540	1,320	730	960	
	12%	0.63	12,600	1.42	15.7	38	6,200	810	2,000	940	1,190	
Post	Green	0.60	8,100	1.09	11.0	44	3,480	860	1,280	790	1,130	
	12%	0.67	13,200	1.51	13.2	46	6,600	1,430	1,840	780	1,360	
Swamp chestnut	Green	0.60	8,500	1.35	12.8	45	3,540	570	1,260	670	1,110	
	12%	0.67	13,900	1.77	12.0	41	7,270	1,110	1,990	690	1,240	
Swamp white	Green	0.64	9,900	1.59	14.5	50	4,360	760	1,300	860	1,160	
	12%	0.72	17,700	2.05	19.2	49	8,600	1,190	2,000	830	1,620	
White	Green	0.60	8,300	1.25	11.6	42	3,560	670	1,250	770	1,060	
	12%	0.68	15,200	1.78	14.8	37	7,440	1,070	2,000	800	1,360	
Sassafras	Green	0.42	6,000	0.91	7.1	—	2,730	370	950	—	—	
	12%	0.46	9,000	1.12	8.7	—	4,760	850	1,240	—	—	
Sweetgum	Green	0.46	7,100	1.20	10.1	36	3,040	370	990	540	600	
	12%	0.52	12,500	1.64	11.9	32	6,320	620	1,600	760	850	
Sycamore, American	Green	0.46	6,500	1.06	7.5	26	2,920	360	1,000	630	610	
	12%	0.49	10,000	1.42	8.5	26	5,380	700	1,470	720	770	
Tanoak	Green	0.58	10,500	1.55	13.4	—	4,650	—	—	—	—	
	12%	—	—	—	—	—	—	—	—	—	—	
Tupelo												
Black	Green	0.46	7,000	1.03	8.0	30	3,040	480	1,100	570	640	
	12%	0.50	9,600	1.20	6.2	22	5,520	930	1,340	500	810	
Water	Green	0.46	7,300	1.05	8.3	30	3,370	480	1,190	600	710	
	12%	0.50	9,600	1.26	6.9	23	5,920	870	1,590	700	880	
Walnut, Black	Green	0.51	9,500	1.42	14.6	37	4,300	490	1,220	570	900	
	12%	0.55	14,600	1.68	10.7	34	7,580	1,010	1,370	690	1,010	
Willow, Black	Green	0.36	4,800	0.79	11.0	—	2,040	180	680	—	—	
	12%	0.39	7,800	1.01	8.8	—	4,100	430	1,250	—	—	
Yellow-poplar	Green	0.40	6,000	1.22	7.5	26	2,660	270	790	510	440	
	12%	0.42	10,100	1.58	8.8	24	5,540	500	1,190	540	540	
Softwoods												
Baldecypress	Green	0.42	6,600	1.18	6.6	25	3,580	400	810	300	390	
	12%	0.46	10,600	1.44	8.2	24	6,360	730	1,000	270	510	
Cedar												
Atlantic white	Green	0.31	4,700	0.75	5.9	18	2,390	240	690	180	290	
	12%	0.32	6,800	0.93	4.1	13	4,700	410	800	220	350	
Eastern redcedar	Green	0.44	7,000	0.65	15.0	35	3,570	700	1,010	330	650	
	12%	0.47	8,800	0.88	8.3	22	6,020	920	—	—	—	
Incense	Green	0.35	6,200	0.84	6.4	17	3,150	370	830	280	390	
	12%	0.37	8,000	1.04	5.4	17	5,200	590	880	270	470	
Northern White	Green	0.29	4,200	0.64	5.7	15	1,990	230	620	240	230	
	12%	0.31	6,500	0.80	4.8	12	3,960	310	850	240	320	

Table 5–3b. Strength properties of some commercially important woods grown in the United States (inch–pound)^a—con.

Common species names	Moisture content	Specific gravity ^b	Static bending					Impact bending (in.)	Compression parallel to grain (lbf in ⁻²)	Compression perpendicular to grain (lbf in ⁻²)	Shear parallel to grain (lbf in ⁻²)	Tension perpendicular to grain (lbf in ⁻²)	Side hardness (lbf)
			Modulus of rupture (lbf in ⁻²)	Modulus of elasticity ^c (×10 ⁶ lbf in ⁻²)	Work to maximum load (in·lbf in ⁻³)								
Cedar—con.													
Port-Orford	Green	0.39	6,600	1.30	7.4	21	3,140	300	840	180	380		
	12%	0.43	12,700	1.70	9.1	28	6,250	720	1,370	400	630		
Western redcedar	Green	0.31	5,200	0.94	5.0	17	2,770	240	770	230	260		
	12%	0.32	7,500	1.11	5.8	17	4,560	460	990	220	350		
Yellow	Green	0.42	6,400	1.14	9.2	27	3,050	350	840	330	440		
	12%	0.44	11,100	1.42	10.4	29	6,310	620	1,130	360	580		
Douglas-fir ^e													
Coast	Green	0.45	7,700	1.56	7.6	26	3,780	380	900	300	500		
	12%	0.48	12,400	1.95	9.9	31	7,230	800	1,130	340	710		
Interior West	Green	0.46	7,700	1.51	7.2	26	3,870	420	940	290	510		
	12%	0.50	12,600	1.83	10.6	32	7,430	760	1,290	350	660		
Interior North	Green	0.45	7,400	1.41	8.1	22	3,470	360	950	340	420		
	12%	0.48	13,100	1.79	10.5	26	6,900	770	1,400	390	600		
Interior South	Green	0.43	6,800	1.16	8.0	15	3,110	340	950	250	360		
	12%	0.46	11,900	1.49	9.0	20	6,230	740	1,510	330	510		
Fir													
Balsam	Green	0.33	5,500	1.25	4.7	16	2,630	190	660	180	290		
	12%	0.35	9,200	1.45	5.1	20	5,280	400	940	180	380		
California red	Green	0.36	5,800	1.17	6.4	21	2,760	330	770	380	360		
	12%	0.38	10,500	1.50	8.9	24	5,460	610	1,040	390	500		
Grand	Green	0.35	5,800	1.25	5.6	22	2,940	270	740	240	360		
	12%	0.37	8,900	1.57	7.5	28	5,290	500	900	240	490		
Noble	Green	0.37	6,200	1.38	6.0	19	3,010	270	800	230	290		
	12%	0.39	10,700	1.72	8.8	23	6,100	520	1,050	220	410		
Pacific silver	Green	0.40	6,400	1.42	6.0	21	3,140	220	750	240	310		
	12%	0.43	11,000	1.76	9.3	24	6,410	450	1,220	—	430		
Subalpine	Green	0.31	4,900	1.05	—	—	2,300	190	700	—	260		
	12%	0.32	8,600	1.29	—	—	4,860	390	1,070	—	350		
White	Green	0.37	5,900	1.16	5.6	22	2,900	280	760	300	340		
	12%	0.39	9,800	1.50	7.2	20	5,800	530	1,100	300	480		
Hemlock													
Eastern	Green	0.38	6,400	1.07	6.7	21	3,080	360	850	230	400		
	12%	0.40	8,900	1.20	6.8	21	5,410	650	1,060	—	500		
Mountain	Green	0.42	6,300	1.04	11.0	32	2,880	370	930	330	470		
	12%	0.45	11,500	1.33	10.4	32	6,440	860	1,540	—	680		
Western	Green	0.42	6,600	1.31	6.9	22	3,360	280	860	290	410		
	12%	0.45	11,300	1.63	8.3	23	7,200	550	1,290	340	540		
Larch, western	Green	0.48	7,700	1.46	10.3	29	3,760	400	870	330	510		
	12%	0.52	13,000	1.87	12.6	35	7,620	930	1,360	430	830		
Pine													
Eastern white	Green	0.34	4,900	0.99	5.2	17	2,440	220	680	250	290		
	12%	0.35	8,600	1.24	6.8	18	4,800	440	900	310	380		
Jack	Green	0.40	6,000	1.07	7.2	26	2,950	300	750	360	400		
	12%	0.43	9,900	1.35	8.3	27	5,660	580	1,170	420	570		
Loblolly	Green	0.47	7,300	1.40	8.2	30	3,510	390	860	260	450		
	12%	0.51	12,800	1.79	10.4	30	7,130	790	1,390	470	690		
Lodgepole	Green	0.38	5,500	1.08	5.6	20	2,610	250	680	220	330		
	12%	0.41	9,400	1.34	6.8	20	5,370	610	880	290	480		
Longleaf	Green	0.54	8,500	1.59	8.9	35	4,320	480	1,040	330	590		
	12%	0.59	14,500	1.98	11.8	34	8,470	960	1,510	470	870		
Pitch	Green	0.47	6,800	1.20	9.2	—	2,950	360	860	—	—		
	12%	0.52	10,800	1.43	9.2	—	5,940	820	1,360	—	—		

Table 5–3b. Strength properties of some commercially important woods grown in the United States (inch–pound)^a—con.

Common species names	Moisture content	Specific gravity ^b	Static bending					Impact bending (in.)	Compression parallel to grain (lbf in ⁻²)	Compression perpendicular to grain (lbf in ⁻²)	Shear parallel to grain (lbf in ⁻²)	Tension perpendicular to grain (lbf in ⁻²)	Side hardness (lbf)
			Modulus of rupture of (lbf in ⁻²)	Modulus of elasticity ^c (×10 ⁶ lbf in ⁻²)	Work to maximum load (in-lbf in ⁻³)								
Pine—con.													
Pond	Green	0.51	7,400	1.28	7.5	—	3,660	440	940	—	—		
	12%	0.56	11,600	1.75	8.6	—	7,540	910	1,380	—	—		
Ponderosa	Green	0.38	5,100	1.00	5.2	21	2,450	280	700	310	320		
	12%	0.40	9,400	1.29	7.1	19	5,320	580	1,130	420	460		
Red	Green	0.41	5,800	1.28	6.1	26	2,730	260	690	300	340		
	12%	0.46	11,000	1.63	9.9	26	6,070	600	1,210	460	560		
Sand	Green	0.46	7,500	1.02	9.6	—	3,440	450	1,140	—	—		
	12%	0.48	11,600	1.41	9.6	—	6,920	836	—	—	—		
Shortleaf	Green	0.47	7,400	1.39	8.2	30	3,530	350	910	320	440		
	12%	0.51	13,100	1.75	11.0	33	7,270	820	1,390	470	690		
Slash	Green	0.54	8,700	1.53	9.6	—	3,820	530	960	—	—		
	12%	0.59	16,300	1.98	13.2	—	8,140	1,020	1,680	—	—		
Spruce	Green	0.41	6,000	1.00	—	—	2,840	280	900	—	450		
	12%	0.44	10,400	1.23	—	—	5,650	730	1,490	—	660		
Sugar	Green	0.34	4,900	1.03	5.4	17	2,460	210	720	270	270		
	12%	0.36	8,200	1.19	5.5	18	4,460	500	1,130	350	380		
Virginia	Green	0.45	7,300	1.22	10.9	34	3,420	390	890	400	540		
	12%	0.48	13,000	1.52	13.7	32	6,710	910	1,350	380	740		
Western white	Green	0.35	4,700	1.19	5.0	19	2,430	190	680	260	260		
	12%	0.38	9,700	1.46	8.8	23	5,040	470	1,040	—	420		
Redwood													
Old-growth	Green	0.38	7,500	1.18	7.4	21	4,200	420	800	260	410		
	12%	0.40	10,000	1.34	6.9	19	6,150	700	940	240	480		
Young-growth	Green	0.34	5,900	0.96	5.7	16	3,110	270	890	300	350		
	12%	0.35	7,900	1.10	5.2	15	5,220	520	1,110	250	420		
Spruce													
Black	Green	0.38	6,100	1.38	7.4	24	2,840	240	740	100	340		
	12%	0.42	10,800	1.61	10.5	23	5,960	550	1,230	—	530		
Engelmann	Green	0.33	4,700	1.03	5.1	16	2,180	200	640	240	260		
	12%	0.35	9,300	1.30	6.4	18	4,480	410	1,200	350	390		
Red	Green	0.37	6,000	1.33	6.9	18	2,720	260	750	220	340		
	12%	0.40	10,800	1.66	8.4	25	5,540	550	1,290	350	530		
Sitka	Green	0.37	5,700	1.23	6.3	24	2,670	280	760	250	350		
	12%	0.40	10,200	1.57	9.4	25	5,610	580	1,150	370	510		
White	Green	0.33	5,000	1.14	6.0	22	2,350	210	640	220	270		
	12%	0.36	9,400	1.43	7.7	20	5,180	430	970	360	410		
Tamarack	Green	0.49	7,200	1.24	7.2	28	3,480	390	860	260	380		
	12%	0.53	11,600	1.64	7.1	23	7,160	800	1,280	400	590		

^aResults of tests on clear specimens in the green and air-dried conditions. Definition of properties: impact bending is height of drop that causes complete failure, using 0.71-kg (50-lb) hammer; compression parallel to grain is also called maximum crushing strength; compression perpendicular to grain is fiber stress at proportional limit; shear is maximum shearing strength; tension is maximum tensile strength; and side hardness is hardness measured when load is perpendicular to grain.

^bSpecific gravity is based on weight when oven-dry and volume when green or at 12% moisture content.

^cModulus of elasticity measured from a simply supported, center-loaded beam, on a span depth ratio of 14/1. To correct for shear deflection, the modulus can be increased by 10%.

^dValues for side hardness of the true hickories are from Bendtsen and Ethington (1975).

^eCoast Douglas-fir is defined as Douglas-fir growing in Oregon and Washington State west of the Cascade Mountains summit. Interior West includes California and all counties in Oregon and Washington east of, but adjacent to, the Cascade summit; Interior North, the remainder of Oregon and Washington plus Idaho, Montana, and Wyoming; and Interior South, Utah, Colorado, Arizona, and New Mexico.

Table 5–4a. Mechanical properties of some commercially important woods grown in Canada and imported into the United States (metric)^a

Common species names	Moisture content	Specific gravity	Static bending		Compression parallel to grain (kPa)	Compression perpendicular to grain (kPa)	Shear parallel to grain (kPa)
			Modulus of rupture (kPa)	Modulus of elasticity (MPa)			
Hardwoods							
Aspen							
Quaking	Green	0.37	38,000	9,000	16,200	1,400	5,000
	12%		68,000	11,200	36,300	3,500	6,800
Big-toothed	Green	0.39	36,000	7,400	16,500	1,400	5,400
	12%		66,000	8,700	32,800	3,200	7,600
Cottonwood							
Balsam, poplar	Green	0.37	34,000	7,900	14,600	1,200	4,600
	12%		70,000	11,500	34,600	2,900	6,100
Black	Green	0.30	28,000	6,700	12,800	700	3,900
	12%		49,000	8,800	27,700	1,800	5,900
Eastern	Green	0.35	32,000	6,000	13,600	1,400	5,300
	12%		52,000	7,800	26,500	3,200	8,000
Softwoods							
Cedar							
Northern white	Green	0.30	27,000	3,600	13,000	1,400	4,600
	12%		42,000	4,300	24,800	2,700	6,900
Western redcedar	Green	0.31	36,000	7,200	19,200	1,900	4,800
	12%		54,000	8,200	29,600	3,400	5,600
Yellow	Green	0.42	46,000	9,200	22,300	2,400	6,100
	12%		80,000	11,000	45,800	4,800	9,200
Douglas-fir	Green	0.45	52,000	11,100	24,900	3,200	6,300
	12%		88,000	13,600	50,000	6,000	9,500
Fir							
Subalpine	Green	0.33	36,000	8,700	17,200	1,800	4,700
	12%		56,000	10,200	36,400	3,700	6,800
Pacific silver	Green	0.36	38,000	9,300	19,100	1,600	4,900
	12%		69,000	11,300	40,900	3,600	7,500
Balsam	Green	0.34	36,000	7,800	16,800	1,600	4,700
	12%		59,000	9,600	34,300	3,200	6,300
Hemlock							
Eastern	Green	0.40	47,000	8,800	23,600	2,800	6,300
	12%		67,000	9,700	41,200	4,300	8,700
Western	Green	0.41	48,000	10,200	24,700	2,600	5,200
	12%		81,000	12,300	46,700	4,600	6,500
Larch, western	Green	0.55	60,000	11,400	30,500	3,600	6,300
	12%		107,000	14,300	61,000	7,300	9,200
Pine							
Eastern white	Green	0.36	35,000	8,100	17,900	1,600	4,400
	12%		66,000	9,400	36,000	3,400	6,100
Jack	Green	0.42	43,000	8,100	20,300	2,300	5,600
	12%		78,000	10,200	40,500	5,700	8,200
Lodgepole	Green	0.40	39,000	8,800	19,700	1,900	5,000
	12%		76,000	10,900	43,200	3,600	8,500
Ponderosa	Green	0.44	39,000	7,800	19,600	2,400	5,000
	12%		73,000	9,500	42,300	5,200	7,000
Red	Green	0.39	34,000	7,400	16,300	1,900	4,900
	12%		70,000	9,500	37,900	5,200	7,500
Western white	Green	0.36	33,000	8,200	17,400	1,600	4,500
	12%		64,100	10,100	36,100	3,200	6,300
Spruce							
Black	Green	0.41	41,000	9,100	19,000	2,100	5,500
	12%		79,000	10,500	41,600	4,300	8,600

Table 5–4a. Mechanical properties of some commercially important woods grown in Canada and imported into the United States (metric)^a—con.

Common species names	Moisture content	Specific gravity	Static bending		Compression parallel to grain (kPa)	Compression perpendicular to grain (kPa)	Shear parallel to grain (kPa)
			Modulus of rupture (kPa)	Modulus of elasticity (MPa)			
Engelmann	Green	0.38	39,000	8,600	19,400	1,900	4,800
	12%		70,000	10,700			
Red	Green	0.38	41,000	9,100	19,400	1,900	5,600
	12%		71,000	11,000			
Sitka	Green	0.35	37,000	9,400	17,600	2,000	4,300
	12%		70,000	11,200			
White	Green	0.35	35,000	7,900	17,000	1,600	4,600
	12%		63,000	10,000			
Tamarack	Green	0.48	47,000	8,600	21,600	2,800	6,300
	12%		76,000	9,400			

^aResults of tests on clear, straight-grained specimens. Property values based on ASTM Standard D 2555–88. Information on additional properties can be obtained from Department of Forestry, Canada, Publication No. 1104. For each species, values in the first line are from tests of green material; those in the second line are adjusted from the green condition to 12% moisture content using dry to green clear wood property ratios as reported in ASTM D 2555–88. Specific gravity is based on weight when oven-dry and volume when green.

of clear wood parallel to grain. Table 5–7 lists average tensile strength values for a limited number of specimens of a few species. In the absence of sufficient tension test data, modulus of rupture values are sometimes substituted for tensile strength of small, clear, straight-grained pieces of wood. The modulus of rupture is considered to be a low or conservative estimate of tensile strength for clear specimens (this is not true for lumber).

Less Common Properties

Strength properties less commonly measured in clear wood include torsion, toughness, rolling shear, and fracture toughness. Other properties involving time under load include creep, creep rupture or duration of load, and fatigue strength.

Torsion strength—Resistance to twisting about a longitudinal axis. For solid wood members, torsional shear strength may be taken as shear strength parallel to grain. Two-thirds of the value for torsional shear strength may be used as an estimate of the torsional shear stress at the proportional limit.

Toughness—Energy required to cause rapid complete failure in a centrally loaded bending specimen. Tables 5–8 and 5–9 give average toughness values for samples of a few hardwood and softwood species. Average coefficients of variation for toughness as determined from approximately 50 species are shown in Table 5–6.

Creep and duration of load—Time-dependent deformation of wood under load. If the load is sufficiently high and the duration of load is long, failure (creep–rupture) will eventually occur. The time required to reach rupture is commonly called duration of load. Duration of load is an important factor in setting design values for wood. Creep and duration of load are described in later sections of this chapter.

Fatigue—Resistance to failure under specific combinations of cyclic loading conditions: frequency and number of cycles, maximum stress, ratio of maximum to minimum stress, and other less-important factors. The main factors affecting fatigue in wood are discussed later in this chapter. The discussion also includes interpretation of fatigue data and information on fatigue as a function of the service environment.

Rolling shear strength—Shear strength of wood where shearing force is in a longitudinal plane and is acting perpendicular to the grain. Few test values of rolling shear in solid wood have been reported. In limited tests, rolling shear strength averaged 18% to 28% of parallel-to-grain shear values. Rolling shear strength is about the same in the longitudinal–radial and longitudinal–tangential planes.

Nanoindentation hardness—This type of hardness measurement is conducted at the nanometer scale (the scale of the cell wall). Nanoindentation uses an extremely small indenter of a hard material and specified shape (usually a pyramid) to press into the surface with sufficient force that the wood deforms. The load and deformation history is used to develop mechanical property information. Nanoindentation hardness provides a method for describing a material's response to various applied loading conditions at a scale that may explain differences in wood cell structures and help predict material performance after chemical treatments have been applied (Moon and others 2006).

Fracture toughness—Ability of wood to withstand flaws that initiate failure. Measurement of fracture toughness helps identify the length of critical flaws that initiate failure in materials.

To date, there is no standard test method for determining fracture toughness in wood. Three types of stress fields, and

Table 5–4b. Mechanical properties of some commercially important woods grown in Canada and imported into the United States (inch–pound)^a

Common species names	Moisture content	Specific gravity	Static bending		Compression parallel to grain (lbf in ⁻²)	Compression perpendicular to grain (lbf in ⁻²)	Shear parallel to grain (lbf in ⁻²)
			Modulus of rupture (lbf in ⁻²)	Modulus of elasticity (×10 ⁶ lbf in ⁻²)			
Hardwoods							
Aspen							
Quaking	Green	0.37	5,500	1.31	2,350	200	720
	12%		9,800	1.63	5,260	510	980
Bigtooth	Green	0.39	5,300	1.08	2,390	210	790
	12%		9,500	1.26	4,760	470	1,100
Cottonwood							
Balsam, poplar	Green	0.37	5,000	1.15	2,110	180	670
	12%		10,100	1.67	5,020	420	890
Black	Green	0.30	4,100	0.97	1,860	100	560
	12%		7,100	1.28	4,020	260	860
Eastern	Green	0.35	4,700	0.87	1,970	210	770
	12%		7,500	1.13	3,840	470	1,160
Softwoods							
Cedar							
Northern white	Green	0.30	3,900	0.52	1,890	200	660
	12%		6,100	0.63	3,590	390	1,000
Western redcedar	Green	0.31	5,300	1.05	2,780	280	700
	12%		7,800	1.19	4,290	500	810
Yellow	Green	0.42	6,600	1.34	3,240	350	880
	12%		11,600	1.59	6,640	690	1,340
Douglas-fir	Green	0.45	7,500	1.61	3,610	460	920
	12%		12,800	1.97	7,260	870	1,380
Fir							
Balsam	Green	0.34	5,300	1.13	2,440	240	680
	12%		8,500	1.40	4,980	460	910
Pacific silver	Green	0.36	5,500	1.35	2,770	230	710
	12%		10,000	1.64	5,930	520	1,190
Subalpine	Green	0.33	5,200	1.26	2,500	260	680
	12%		8,200	1.48	5,280	540	980
Hemlock							
Eastern	Green	0.40	6,800	1.27	3,430	400	910
	12%		9,700	1.41	5,970	630	1,260
Western	Green	0.41	7,000	1.48	3,580	370	750
	12%		11,800	1.79	6,770	660	940
Larch, western	Green	0.55	8,700	1.65	4,420	520	920
	12%		15,500	2.08	8,840	1,060	1,340
Pine							
Eastern white	Green	0.36	5,100	1.18	2,590	240	640
	12%		9,500	1.36	5,230	490	880
Jack	Green	0.42	6,300	1.17	2,950	340	820
	12%		11,300	1.48	5,870	830	1,190
Lodgepole	Green	0.40	5,600	1.27	2,860	280	720
	12%		11,000	1.58	6,260	530	1,240
Ponderosa	Green	0.44	5,700	1.13	2,840	350	720
	12%		10,600	1.38	6,130	760	1,020
Red	Green	0.39	5,000	1.07	2,370	280	710
	12%		10,100	1.38	5,500	720	1,090
Western white	Green	0.36	4,800	1.19	2,520	240	650
	12%		9,300	1.46	5,240	470	920
Spruce							
Black	Green	0.41	5,900	1.32	2,760	300	800
	12%		11,400	1.52	6,040	620	1,250
Engelmann	Green	0.38	5,700	1.25	2,810	270	700
	12%		10,100	1.55	6,150	540	1,100
Red	Green	0.38	5,900	1.32	2,810	270	810
	12%		10,300	1.60	5,590	550	1,330

Table 5–4b. Mechanical properties of some commercially important woods grown in Canada and imported into the United States (inch–pound)^a—con.

Common species names	Moisture content	Specific gravity	Static bending		Compression parallel to grain (lbf in ⁻²)	Compression perpendicular to grain (lbf in ⁻²)	Shear parallel to grain (lbf in ⁻²)
			Modulus of rupture (lbf in ⁻²)	Modulus of elasticity (×10 ⁶ lbf in ⁻²)			
Sitka	Green	0.35	5,400	1.37	2,560	290	630
	12%		10,100	1.63	5,480	590	980
White	Green	0.35	5,100	1.15	2,470	240	670
	12%		9,100	1.45	5,360	500	980
Tamarack	Green	0.48	6,800	1.24	3,130	410	920
	12%		11,000	1.36	6,510	900	1,300

^aResults of tests on clear, straight-grained specimens. Property values based on ASTM Standard D 2555–88. Information on additional properties can be obtained from Department of Forestry, Canada, Publication No. 1104. For each species, values in the first line are from tests of green material; those in the second line are adjusted from the green condition to 12% moisture content using dry to green clear wood property ratios as reported in ASTM D 2555–88. Specific gravity is based on weight when oven-dry and volume when green.

associated stress intensity factors, can be defined at a crack tip: opening mode (I), forward shear mode (II), and transverse shear mode (III) (Fig. 5–2a). A crack may lie in one of these three planes and may propagate in one of two directions in each plane. This gives rise to six crack-propagation systems (*RL*, *TL*, *LR*, *TR*, *LT*, and *RT*) (Fig. 5–2b). Of these crack-propagation systems, four systems are of practical importance: *RL*, *TL*, *TR*, and *RT*. Each of these four systems allow for propagation of a crack along the lower strength path parallel to the grain. The *RL* and *TL* orientations in wood (where *R* or *T* is perpendicular to the crack plane and *L* is the direction in which the crack propagates) will predominate as a result of the low strength and stiffness of wood perpendicular to the grain. It is therefore one of these two orientations that is most often tested. Values for mode I fracture toughness range from 220 to 550 kPa m^{1/2} (200 to 500 lbf in⁻² in^{1/2}) and for mode II range from 1,650 to 2,400 kPa m^{1/2} (1,500 to 2,200 lbf in⁻² in^{1/2}). Table 5–10 summarizes selected mode I and mode II test results at 10% to 12% moisture content available in the literature. The limited information available on moisture content effects on fracture toughness suggests that fracture toughness is either insensitive to moisture content or increases as the material dries, reaching a maximum between 6% and 15% moisture content; fracture toughness then decreases with further drying.

Vibration Properties

The vibration properties of primary interest in structural materials are speed of sound and internal friction (damping capacity).

Speed of Sound

The speed of sound in a structural material is a function of the modulus of elasticity and density. In wood, the speed of sound also varies with grain direction because the transverse modulus of elasticity is much less than the longitudinal value (as little as 1/20); the speed of sound across the grain is about one-fifth to one-third of the longitudinal value.

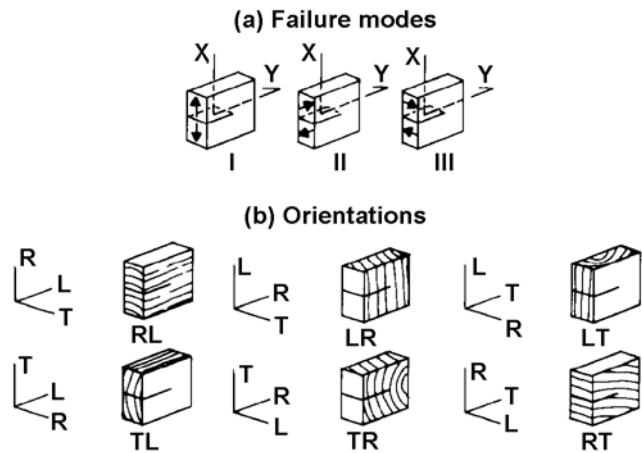

Figure 5–2. Possible crack propagation systems for wood.

For example, a piece of wood with a longitudinal modulus of elasticity of 12.4 GPa (1.8×10^6 lbf in⁻²) and density of 480 kg m⁻³ (30 lb ft⁻³) would have a speed of sound in the longitudinal direction of about 3,800 m s⁻¹ (12,500 ft s⁻¹). In the transverse direction, modulus of elasticity would be about 690 MPa (100×10^3 lbf in⁻²) and the speed of sound approximately 890 m s⁻¹ (2,900 ft s⁻¹).

The speed of sound decreases with increasing temperature or moisture content in proportion to the influence of these variables on modulus of elasticity and density. The speed of sound decreases slightly with increasing frequency and amplitude of vibration, although for most common applications this effect is too small to be significant. There is no recognized independent effect of species on the speed of sound. Variability in the speed of sound in wood is directly related to the variability of modulus of elasticity and density.

Internal Friction

When solid material is strained, some mechanical energy is dissipated as heat. Internal friction is the term used to denote the mechanism that causes this energy dissipation.

Table 5–5a. Mechanical properties of some woods imported into the United States other than Canadian imports (metric)^a

Common and botanical names of species	Moisture content	Specific gravity	Static bending			Work to maximum load (kJ m ⁻³)	Compression parallel to grain (kPa)	Shear parallel to grain (kPa)	Side hardness (N)	Sample origin ^b
			Modulus of rupture (kPa)	Modulus of elasticity (MPa)	Modulus of rupture (kPa)					
Afromosia (<i>Pericopsis elata</i>)	Green	0.61	102,000	12,200	135	51,600	11,500	7,100	AF	
	12%		126,900	13,400	127	68,500	14,400	6,900		
Albarco (<i>Cariniana</i> spp.)	Green	0.48	—	—	—	—	—	—	AM	
	12%		100,000	10,300	95	47,000	15,900	4,500		
Andiroba (<i>Carapa guianensis</i>)	Green	0.54	71,000	11,700	68	33,000	8,400	3,900	AM	
	12%		106,900	13,800	97	56,000	10,400	5,000		
Angelin (<i>Andira inermis</i>)	Green	0.65	—	—	—	—	—	—	AF	
	12%		124,100	17,200	—	63,400	12,700	7,800		
Angelique (<i>Dicorynia guianensis</i>)	Green	0.6	78,600	12,700	83	38,500	9,200	4,900	AM	
	12%		120,000	15,100	105	60,500	11,400	5,700		
Avodire (<i>Turraeanthus africanus</i>)	Green	0.48	—	—	—	—	—	—	AF	
	12%		87,600	10,300	65	49,300	14,000	4,800		
Azobe (<i>Lophira alata</i>)	Green	0.87	116,500	14,900	83	65,600	14,100	12,900	AF	
	12%		168,900	17,000	—	86,900	20,400	14,900		
Balsa (<i>Ochroma pyramidale</i>)	Green	0.16	—	—	—	—	—	—	AM	
	12%		21,600	3,400	14	14,900	2,100	—		
Banak (<i>Virola</i> spp.)	Green	0.42	38,600	11,300	28	16,500	5,000	1,400	AM	
	12%		75,200	14,100	69	35,400	6,800	2,300		
Benge (<i>Guibourtia arnoldiana</i>)	Green	0.65	—	—	—	—	—	—	AF	
	12%		147,500	14,100	—	78,600	14,400	7,800		
Bubinga (<i>Guibourtia</i> spp.)	Green	0.71	—	—	—	—	—	—	AF	
	12%		155,800	17,100	—	72,400	21,400	12,000		
Bulletwood (<i>Manilkara bidentata</i>)	Green	0.85	119,300	18,600	94	59,900	13,100	9,900	AM	
	12%		188,200	23,800	197	80,300	17,200	14,200		
Cativo (<i>Prioria copaifera</i>)	Green	0.4	40,700	6,500	37	17,000	5,900	2,000	AM	
	12%		59,300	7,700	50	29,600	7,300	2,800		
Ceiba (<i>Ceiba pentandra</i>)	Green	0.25	15,200	2,800	8	7,300	2,400	1,000	AM	
	12%		29,600	3,700	19	16,400	3,800	1,100		
Courbaril (<i>Hymenaea courbaril</i>)	Green	0.71	88,900	12,700	101	40,000	12,200	8,800	AM	
	12%		133,800	14,900	121	65,600	17,000	10,500		
Cuangare (<i>Dialyanthera</i> spp.)	Green	0.31	27,600	7,000	—	14,300	4,100	1,000	AM	
	12%		50,300	10,500	—	32,800	5,700	1,700		
Cypress, Mexican (<i>Cupressus lustianica</i>)	Green	0.39	42,700	6,300	—	19,900	6,600	1,500	AF	
	12%		71,000	7,000	—	37,100	10,900	2,000		
Degame (<i>Calycophyllum candidissimum</i>)	Green	0.67	98,600	13,300	128	42,700	11,400	7,300	AM	
	12%		153,800	15,700	186	66,700	14,600	8,600		
Determa (<i>Ocotea rubra</i>)	Green	0.52	53,800	10,100	33	25,900	5,900	2,300	AM	
	12%		72,400	12,500	44	40,000	6,800	2,900		
Ekop (<i>Tetraberlinia tubmaniana</i>)	Green	0.6	—	—	—	—	—	—	AF	
	12%		115,100	15,200	—	62,100	—	—		
Goncalo alves (<i>Astronium graveolens</i>)	Green	0.84	83,400	13,400	46	45,400	12,100	8,500	AM	
	12%		114,500	15,400	72	71,200	13,500	9,600		
Greenheart (<i>Chlorocardium rodiei</i>)	Green	0.8	133,100	17,000	72	64,700	13,300	8,400	AM	
	12%		171,700	22,400	175	86,300	18,100	10,500		
Hura (<i>Hura crepitans</i>)	Green	0.38	43,400	7,200	41	19,200	5,700	2,000	AM	
	12%		60,000	8,100	46	33,100	7,400	2,400		

Table 5–5a. Mechanical properties of some woods imported into the United States other than Canadian imports (metric)^a—con.

Common and botanical names of species	Moisture content	Specific gravity	Static bending			Compression parallel to grain (kPa)	Shear parallel to grain (kPa)	Side hardness (N)	Sample origin ^b
			Modulus of rupture (kPa)	Modulus of elasticity (MPa)	Work to maximum load (kJ m ⁻³)				
Llomba (<i>Pycnanthus angolensis</i>)	Green	0.40	37,900	7,900	—	20,000	5,800	2,100	AF
	12%	—	68,300	11,000	—	38,300	8,900	2,700	
Ipe (<i>Tabebuia</i> spp., lapacho group)	Green	0.92	155,800	20,100	190	71,400	14,600	13,600	AM
	12%	—	175,100	21,600	152	89,700	14,200	16,400	
Iroko (<i>Chlorophora</i> spp.)	Green	0.54	70,300	8,900	72	33,900	9,000	4,800	AF
	12%	—	85,500	10,100	62	52,300	12,400	5,600	
Jarrah (<i>Eucalyptus marginata</i>)	Green	0.67	68,300	10,200	—	35,800	9,100	5,700	AS
	12%	—	111,700	13,000	—	61,200	14,700	8,500	
Jelutong (<i>Dyera costulata</i>)	Green	0.36	38,600	8,000	39	21,000	5,200	1,500	AS
	15%	—	50,300	8,100	44	27,000	5,800	1,700	
Kaneelhart (<i>Licaria</i> spp.)	Green	0.96	153,800	26,300	94	92,300	11,600	9,800	AM
	12%	—	206,200	28,000	121	120,000	13,600	12,900	
Kapur (<i>Dryobalanops</i> spp.)	Green	0.64	88,300	11,000	108	42,900	8,100	4,400	AS
	12%	—	126,200	13,000	130	69,600	13,700	5,500	
Karri (<i>Eucalyptus diversicolor</i>)	Green	0.82	77,200	13,400	80	37,600	10,400	6,000	AS
	12%	—	139,000	17,900	175	74,500	16,700	9,100	
Kempas (<i>Koompassia malaccensis</i>)	Green	0.71	100,000	16,600	84	54,700	10,100	6,600	AS
	12%	—	122,000	18,500	106	65,600	12,300	7,600	
Keruing (<i>Dipterocarpus</i> spp.)	Green	0.69	82,000	11,800	96	39,200	8,100	4,700	AS
	12%	—	137,200	14,300	162	72,400	14,300	5,600	
Lignumvitae (<i>Guaicum</i> spp.)	Green	1.05	—	—	—	—	—	—	AM
	12%	—	—	—	—	78,600	—	20,000	
Limba (<i>Terminalia superba</i>)	Green	0.38	41,400	5,300	53	19,200	6,100	1,800	AF
	12%	—	60,700	7,000	61	32,600	9,700	2,200	
Macawood (<i>Platymiscium</i> spp.)	Green	0.94	153,800	20,800	—	72,700	12,700	14,800	AM
	12%	—	190,300	22,100	—	111,000	17,500	14,000	
Mahogany, African (<i>Khaya</i> spp.)	Green	0.42	51,000	7,900	49	25,700	6,400	2,800	AF
	12%	—	73,800	9,700	57	44,500	10,300	3,700	
Mahogany, true (<i>Swietenia macrophylla</i>)	Green	0.45	62,100	9,200	63	29,900	8,500	3,300	AM
	12%	—	79,300	10,300	52	46,700	8,500	3,600	
Manbarklak (<i>Eschweilera</i> spp.)	Green	0.87	117,900	18,600	120	50,600	11,200	10,100	AM
	12%	—	182,700	21,600	230	77,300	14,300	15,500	
Manni (<i>Symphonia globulifera</i>)	Green	0.58	77,200	13,500	77	35,600	7,900	4,200	AM
	12%	—	116,500	17,000	114	60,800	9,800	5,000	
Marishballi (<i>Lincania</i> spp.)	Green	0.88	117,900	20,200	92	52,300	11,200	10,000	AM
	12%	—	191,000	23,000	98	92,300	12,100	15,900	
Merbau (<i>Intsia</i> spp.)	Green	0.64	88,900	13,900	88	46,700	10,800	6,100	AS
	15%	—	115,800	15,400	102	58,200	12,500	6,700	
Mersawa (<i>Anisoptera</i> spp.)	Green	0.52	55,200	12,200	—	27,300	5,100	3,900	AS
	12%	—	95,100	15,700	—	50,800	6,100	5,700	
Mora (<i>Mora</i> spp.)	Green	0.78	86,900	16,100	93	44,100	9,700	6,400	AM
	12%	—	152,400	20,400	128	81,600	13,100	10,200	
Oak (<i>Quercus</i> spp.)	Green	0.76	—	—	—	—	—	—	AM
	12%	—	158,600	20,800	114	—	—	11,100	
Obeche (<i>Triplochiton scleroxylon</i>)	Green	0.3	35,200	5,000	43	17,700	4,600	1,900	AF
	12%	—	51,000	5,900	48	27,100	6,800	1,900	

Table 5–5a. Mechanical properties of some woods imported into the United States other than Canadian imports (metric)^a—con.

Common and botanical names of species	Moisture content	Specific gravity	Static bending			Compression parallel to grain (kPa)	Shear parallel to grain (kPa)	Side hardness (N)	Sample origin ^b
			Modulus of rupture (kPa)	Modulus of elasticity (MPa)	Work to maximum load (kJ m ⁻³)				
Okoume (<i>Aucoumea klaineana</i>)	Green	0.33	—	—	—	—	—	—	AF
	12%		51,000	7,900	—	27,400	6,700	1,700	
Opepe (<i>Nauclea diderrichii</i>)	Green	0.63	93,800	11,900	84	51,600	13,100	6,800	AF
	12%		120,000	13,400	99	71,700	17,100	7,300	
Ovangkol (<i>Guibourtia ehie</i>)	Green	0.67	—	—	—	—	—	—	AF
	12%		116,500	17,700	—	57,200	—	—	
Para-angelim (<i>Hymenolobium excelsum</i>)	Green	0.63	100,700	13,400	88	51,400	11,000	7,700	AM
	12%		121,300	14,100	110	62,000	13,900	7,700	
Parana-pine (<i>Araucaria augustifolia</i>)	Green	0.46	49,600	9,300	67	27,600	6,700	2,500	AM
	12%		93,100	11,100	84	52,800	11,900	3,500	
Pau marfim (<i>Balfourodendron riedelianum</i>)	Green	0.73	99,300	11,400	—	41,900	—	—	AM
	15%		130,300	—	—	56,500	—	—	
Peroba de campos (<i>Paratecoma peroba</i>)	Green	0.62	—	—	—	—	—	—	AM
	12%		106,200	12,200	70	61,200	14,700	7,100	
Peroba rosa (<i>Aspidosperma</i> spp., peroba group)	Green	0.66	75,200	8,900	72	38,200	13,000	7,000	AM
	12%		83,400	10,500	63	54,600	17,200	7,700	
Pilon (<i>Hyeronima</i> spp.)	Green	0.65	73,800	13,000	57	34,200	8,300	5,400	AM
	12%		125,500	15,700	83	66,300	11,900	7,600	
Pine, Caribbean (<i>Pinus caribaea</i>)	Green	0.68	77,200	13,000	74	33,800	8,100	4,400	AM
	12%		115,100	15,400	119	58,900	14,400	5,500	
Pine, ocote (<i>Pinus oocarpa</i>)	Green	0.55	55,200	12,000	48	25,400	7,200	2,600	AM
	12%		102,700	15,500	75	53,000	11,900	4,000	
Pine, radiata (<i>Pinus radiata</i>)	Green	0.42	42,100	8,100	—	19,200	5,200	2,100	AS
	12%		80,700	10,200	—	41,900	11,000	3,300	
Piquia (<i>Caryocar</i> spp.)	Green	0.72	85,500	12,500	58	43,400	11,300	7,700	AM
	12%		117,200	14,900	109	58,000	13,700	7,700	
Primavera (<i>Tabebuia donnell-smithii</i>)	Green	0.4	49,600	6,800	50	24,200	7,100	3,100	AM
	12%		65,500	7,200	44	38,600	9,600	2,900	
Purpleheart (<i>Peltogyne</i> spp.)	Green	0.67	94,000	13,800	102	48,400	11,300	8,100	AM
	12%		132,400	15,700	121	71,200	15,300	8,300	
Ramin (<i>Gonystylus bancanus</i>)	Green	0.52	67,600	10,800	62	37,200	6,800	2,800	AS
	12%		127,600	15,000	117	69,500	10,500	5,800	
Robe (<i>Tabebuia</i> spp., robe group)	Green	0.52	74,500	10,000	81	33,900	8,600	4,000	AM
	12%		95,100	11,000	86	50,600	10,000	4,300	
Rosewood, Brazilian (<i>Dalbergia nigra</i>)	Green	0.8	97,200	12,700	91	38,000	16,300	10,900	AM
	12%		131,000	13,000	—	66,200	14,500	12,100	
Rosewood, Indian (<i>Dalbergia latifolia</i>)	Green	0.75	63,400	8,200	80	31,200	9,700	6,900	AS
	12%		116,500	12,300	90	63,600	14,400	14,100	
Sande (<i>Brosimum</i> spp., utile group)	Green	0.49	58,600	13,400	—	31,000	7,200	2,700	AM
	12%		98,600	16,500	—	56,700	8,900	4,000	
Santa Maria (<i>Calophyllum brasiliense</i>)	Green	0.52	72,400	11,000	88	31,400	8,700	4,000	AM
	12%		100,700	12,600	111	47,600	14,300	5,100	
Sapele (<i>Entandrophragma cylindricum</i>)	Green	0.55	70,300	10,300	72	34,500	8,600	4,500	AF
	12%		105,500	12,500	108	56,300	15,600	6,700	
Sepetir (<i>Pseudosindora palustris</i>)	Green	0.56	77,200	10,800	92	37,600	9,000	4,200	AS
	12%		118,600	13,600	92	61,200	14,000	6,300	

Table 5–5a. Mechanical properties of some woods imported into the United States other than Canadian imports (metric)^a—con.

Common and botanical names of species	Moisture content	Specific gravity	Static bending			Compression parallel to grain (kPa)	Shear parallel to grain (kPa)	Side hardness (N)	Sample origin ^b
			Modulus of rupture (kPa)	Modulus of elasticity (MPa)	Work to maximum load (kJ m ⁻³)				
Shorea (<i>Shorea</i> spp., baulau group)	Green	0.68	80,700	14,500	—	37,100	9,900	6,000	AS
	12%		129,600	18,000	—	70,200	15,100	7,900	
Shorea, lauan–meranti group									
Dark red meranti	Green	0.46	64,800	10,300	59	32,500	7,700	3,100	AS
	12%		87,600	12,200	95	50,700	10,000	3,500	
Light red meranti	Green	0.34	45,500	7,200	43	23,000	4,900	2,000	AS
	12%		65,500	8,500	59	40,800	6,700	2,000	
White meranti	Green	0.55	67,600	9,000	57	37,900	9,100	4,400	AS
	15%		85,500	10,300	79	43,800	10,600	5,100	
Yellow meranti	Green	0.46	55,200	9,000	56	26,800	7,100	3,300	AS
	12%		78,600	10,700	70	40,700	10,500	3,400	
Spanish-cedar (<i>Cedrela</i> spp.)	Green	0.41	51,700	9,000	49	23,200	6,800	2,400	AM
	12%		79,300	9,900	65	42,800	7,600	2,700	
Sucupira (<i>Bowdichia</i> spp.)	Green	0.74	118,600	15,700	—	67,100	—	—	AM
	15%		133,800	—	—	76,500	—	—	
Sucupira (<i>Diploptropis purpurea</i>)	Green	0.78	120,000	18,500	90	55,300	12,400	8,800	AM
	12%		142,000	19,800	102	83,700	13,500	9,500	
Teak (<i>Tectona grandis</i>)	Green	0.55	80,000	9,400	92	41,100	8,900	4,100	AS
	12%		100,700	10,700	83	58,000	13,000	4,400	
Tornillo (<i>Cedrelinga cateniformis</i>)	Green	0.45	57,900	—	—	28,300	8,100	3,900	AM
	12%		—	—	—	—	—	—	
Wallaba (<i>Eperua</i> spp.)	Green	0.78	98,600	16,100	—	55,400	—	6,900	AM
	12%		—	131,700	15,700	—	74,200	—	

^aResults of tests on clear, straight-grained specimens. Property values were taken from world literature (not obtained from experiments conducted at the Forest Products Laboratory). Other species may be reported in the world literature, as well as additional data on many of these species. Some property values have been adjusted to 12% moisture content.

^bAF is Africa; AM, America; AS, Asia.

The internal friction mechanism in wood is a complex function of temperature and moisture content. In general, there is a value of moisture content at which internal friction is minimum. On either side of this minimum, internal friction increases as moisture content varies down to zero or up to the fiber saturation point. The moisture content at which minimum internal friction occurs varies with temperature. At room temperature (23 °C (73 °F)), the minimum occurs at about 6% moisture content; at –20 °C (–4 °F), it occurs at about 14% moisture content, and at 70 °C (158 °F), at about 4%. At 90 °C (194 °F), the minimum is not well defined and occurs near zero moisture content.

Similarly, there are temperatures at which internal friction is minimum, and the temperatures of minimum internal friction vary with moisture content. The temperatures of minimum internal friction increase as moisture content decreases. For temperatures above 0 °C (32 °F) and moisture content greater than about 10%, internal friction increases strongly as temperature increases, with a strong positive interaction with moisture content. For very dry wood, there is a general tendency for internal friction to decrease as the temperature increases.

The value of internal friction, expressed by logarithmic decrement, ranges from about 0.1 for hot, moist wood to less than 0.02 for hot, dry wood. Cool wood, regardless of moisture content, would have an intermediate value.

Mechanical Properties of Clear Straight-Grained Wood

The mechanical properties listed in Table 5–1 to Table 5–9 are based on a variety of sampling methods. Generally, the most extensive sampling is represented in Tables 5–3 and 5–4. Values in Table 5–3 are averages derived for a number of species grown in the United States. The tabulated value is an estimate of the average clear wood property of the species. Many values were obtained from test specimens taken at a height of 2.4 to 5 m (8 to 16 ft) above the stump of the tree. Values reported in Table 5–4 represent estimates of the average clear wood properties of species grown in Canada and commonly imported into the United States.

Methods of data collection and analysis changed over the years during which the data in Tables 5–3 and 5–4 were collected. In addition, the character of some forests has changed with time. Because not all the species were

Table 5–5b. Mechanical properties of some woods imported into the United States other than Canadian imports (inch–pound)^a

Common and botanical names of species	Moisture content	Specific gravity	Static bending			Compression parallel to grain (lbf in ⁻²)	Shear parallel to grain (lbf in ⁻²)	Side hardness (lbf)	Sample origin ^b
			Modulus of rupture (lbf in ⁻²)	Modulus of elasticity (×10 ⁶ lbf in ⁻²)	Work to maximum load (in-lbf in ⁻³)				
Afromosia (<i>Pericopsis elata</i>)	Green	0.61	14,800	1.77	19.5	7,490	1,670	1,600	AF
	12%	—	18,400	1.94	18.4	9,940	2,090	1,560	
Albarco (<i>Cariniana</i> spp.)	Green	0.48	—	—	—	—	—	—	AM
	12%	—	14,500	1.5	13.8	6,820	2,310	1,020	
Andiroba (<i>Carapa guianensis</i>)	Green	0.54	10,300	1.69	9.8	4,780	1,220	880	AM
	12%	—	15,500	2	14	8,120	1,510	1,130	
Angelin (<i>Andira inermis</i>)	Green	0.65	—	—	—	—	—	—	AF
	12%	—	18,000	2.49	—	9,200	1,840	1,750	
Angelique (<i>Dicorynia guianensis</i>)	Green	0.6	11,400	1.84	12	5,590	1,340	1,100	AM
	12%	—	17,400	2.19	15.2	8,770	1,660	1,290	
Avodire (<i>Turraeanthus africanus</i>)	Green	0.48	—	—	—	—	—	—	AF
	12%	—	12,700	1.49	9.4	7,150	2,030	1,080	
Azobe (<i>Lophira alata</i>)	Green	0.87	16,900	2.16	12	9,520	2,040	2,890	AF
	12%	—	24,500	2.47	—	12,600	2,960	3,350	
Balsa (<i>Ochroma pyramidale</i>)	Green	0.16	—	—	—	—	—	—	AM
	12%	—	3,140	0.49	2.1	2,160	300	—	
Banak (<i>Virola</i> spp.)	Green	0.42	5,600	1.64	4.1	2,390	720	320	AM
	12%	—	10,900	2.04	10	5,140	980	510	
Benge (<i>Guibourtia arnoldiana</i>)	Green	0.65	—	—	—	—	—	—	AF
	12%	—	21,400	2.04	—	11,400	2,090	1,750	
Bubinga (<i>Guibourtia</i> spp.)	Green	0.71	—	—	—	—	—	—	AF
	12%	—	22,600	2.48	—	10,500	3,110	2,690	
Bulletwood (<i>Manilkara bidentata</i>)	Green	0.85	17,300	2.7	13.6	8,690	1,900	2,230	AM
	12%	—	27,300	3.45	28.5	11,640	2,500	3,190	
Cativo (<i>Prioria copaifera</i>)	Green	0.4	5,900	0.94	5.4	2,460	860	440	AM
	12%	—	8,600	1.11	7.2	4,290	1,060	630	
Ceiba (<i>Ceiba pentandra</i>)	Green	0.25	2,200	0.41	1.2	1,060	350	220	AM
	12%	—	4,300	0.54	2.8	2,380	550	240	
Courbaril (<i>Hymenaea courbaril</i>)	Green	0.71	12,900	1.84	14.6	5,800	1,770	1,970	AM
	12%	—	19,400	2.16	17.6	9,510	2,470	2,350	
Cuangare (<i>Dialyanthera</i> spp.)	Green	0.31	4,000	1.01	—	2,080	590	230	AM
	12%	—	7,300	1.52	—	4,760	830	380	
Cypress, Mexican (<i>Cupressus lustianica</i>)	Green	0.39	6,200	0.92	—	2,880	950	340	AF
	12%	—	10,300	1.02	—	5,380	1,580	460	
Degame (<i>Calycophyllum candidissimum</i>)	Green	0.67	14,300	1.93	18.6	6,200	1,660	1,630	AM
	12%	—	22,300	2.27	27	9,670	2,120	1,940	
Determa (<i>Ocotea rubra</i>)	Green	0.52	7,800	1.46	4.8	3,760	860	520	AM
	12%	—	10,500	1.82	6.4	5,800	980	660	
Ekop (<i>Tetraberlinia tubmaniana</i>)	Green	0.6	—	—	—	—	—	—	AF
	12%	—	16,700	2.21	—	9,010	—	—	
Goncalo alves (<i>Astronium graveolens</i>)	Green	0.84	12,100	1.94	6.7	6,580	1,760	1,910	AM
	12%	—	16,600	2.23	10.4	10,320	1,960	2,160	
Greenheart (<i>Chlorocardium rodiei</i>)	Green	0.8	19,300	2.47	10.5	9,380	1,930	1,880	AM
	12%	—	24,900	3.25	25.3	12,510	2,620	2,350	
Hura (<i>Hura crepitans</i>)	Green	0.38	6,300	1.04	5.9	2,790	830	440	AM
	12%	—	8,700	1.17	6.7	4,800	1,080	550	

Table 5–5b. Mechanical properties of some woods imported into the United States other than Canadian imports (inch–pound)^a—con.

Common and botanical names of species	Moisture content	Specific gravity	Static bending			Compression parallel to grain (lbf in ⁻²)	Shear parallel to grain (lbf in ⁻²)	Side hardness (lbf)	Sample origin ^b
			Modulus of rupture (lbf in ⁻²)	Modulus of elasticity (×10 ⁶ lbf in ⁻²)	Work to maximum load (in-lbf in ⁻³)				
Ilomba (<i>Pycnanthus angolensis</i>)	Green	0.4	5,500	1.14	—	2,900	840	470	AF
	12%	—	9,900	1.59	—	5,550	1,290	610	
Ipe (<i>Tabebuia</i> spp., lapacho group)	Green	0.92	22,600	2.92	27.6	10,350	2,120	3,060	AM
	12%	—	25,400	3.14	22	13,010	2,060	3,680	
Iroko (<i>Chlorophora</i> spp.)	Green	0.54	10,200	1.29	10.5	4,910	1,310	1,080	AF
	12%	—	12,400	1.46	9	7,590	1,800	1,260	
Jarrah (<i>Eucalyptus marginata</i>)	Green	0.67	9,900	1.48	—	5,190	1,320	1,290	AS
	12%	—	16,200	1.88	—	8,870	2,130	1,910	
Jelutong (<i>Dyera costulata</i>)	Green	0.36	5,600	1.16	5.6	3,050	760	330	AS
	15%	—	7,300	1.18	6.4	3,920	840	390	
Kaneelhart (<i>Licaria</i> spp.)	Green	0.96	22,300	3.82	13.6	13,390	1,680	2,210	AM
	12%	—	29,900	4.06	17.5	17,400	1,970	2,900	
Kapur (<i>Dryobalanops</i> spp.)	Green	0.64	12,800	1.6	15.7	6,220	1,170	980	AS
	12%	—	18,300	1.88	18.8	10,090	1,990	1,230	
Karri (<i>Eucalyptus diversicolor</i>)	Green	0.82	11,200	1.94	11.6	5,450	1,510	1,360	AS
	12%	—	20,160	2.6	25.4	10,800	2,420	2,040	
Kempas (<i>Koompassia malaccensis</i>)	Green	0.71	14,500	2.41	12.2	7,930	1,460	1,480	AS
	12%	—	17,700	2.69	15.3	9,520	1,790	1,710	
Keruing (<i>Dipterocarpus</i> spp.)	Green	0.69	11,900	1.71	13.9	5,680	1,170	1,060	AS
	12%	—	19,900	2.07	23.5	10,500	2,070	1,270	
Lignumvitae (<i>Guaiacum</i> spp.)	Green	1.05	—	—	—	—	—	—	AM
	12%	—	—	—	—	11,400	—	4,500	
Limba (<i>Terminalia superba</i>)	Green	0.38	6,000	0.77	7.7	2,780	880	400	AF
	12%	—	8,800	1.01	8.9	4,730	1,410	490	
Macawood (<i>Platymiscium</i> spp.)	Green	0.94	22,300	3.02	—	10,540	1,840	3,320	AM
	12%	—	27,600	3.2	—	16,100	2,540	3,150	
Mahogany, African (<i>Khaya</i> spp.)	Green	0.42	7,400	1.15	7.1	3,730	931	640	AF
	12%	—	10,700	1.4	8.3	6,460	1,500	830	
Mahogany, true (<i>Swietenia macrophylla</i>)	Green	0.45	9,000	1.34	9.1	4,340	1,240	740	AM
	12%	—	11,500	1.5	7.5	6,780	1,230	800	
Manbarklak (<i>Eschweilera</i> spp.)	Green	0.87	17,100	2.7	17.4	7,340	1,630	2,280	AM
	12%	—	26,500	3.14	33.3	11,210	2,070	3,480	
Manni (<i>Symphonia globulifera</i>)	Green	0.58	11,200	1.96	11.2	5,160	1,140	940	AM
	12%	—	16,900	2.46	16.5	8,820	1,420	1,120	
Marishballi (<i>Lincania</i> spp.)	Green	0.88	17,100	2.93	13.4	7,580	1,620	2,250	AM
	12%	—	27,700	3.34	14.2	13,390	1,750	3,570	
Merbau (<i>Intsia</i> spp.)	Green	0.64	12,900	2.02	12.8	6,770	1,560	1,380	AS
	15%	—	16,800	2.23	14.8	8,440	1,810	1,500	
Mersawa (<i>Anisoptera</i> spp.)	Green	0.52	8,000	1.77	—	3,960	740	880	AS
	12%	—	13,800	2.28	—	7,370	890	1,290	
Mora (<i>Mora</i> spp.)	Green	0.78	12,600	2.33	13.5	6,400	1,400	1,450	AM
	12%	—	22,100	2.96	18.5	11,840	1,900	2,300	
Oak (<i>Quercus</i> spp.)	Green	0.76	—	—	—	—	—	—	AM
	12%	—	23,000	3.02	16.5	—	—	2,500	
Obeche (<i>Triplochiton scleroxylon</i>)	Green	0.3	5,100	0.72	6.2	2,570	660	420	AF
	12%	—	7,400	0.86	6.9	3,930	990	430	

Table 5–5b. Mechanical properties of some woods imported into the United States other than Canadian imports (inch–pound)^a—con.

Common and botanical names of species	Moisture content	Specific gravity	Static bending			Compression parallel to grain (lbf in ⁻²)	Shear parallel to grain (lbf in ⁻²)	Side hardness (lbf)	Sample origin ^b
			Modulus of rupture (lbf in ⁻²)	Modulus of elasticity (×10 ⁶ lbf in ⁻²)	Work to maximum load (in-lbf in ⁻³)				
Okoume (<i>Aucoumea klaineana</i>)	Green	0.33	—	—	—	—	—	—	AF
	12%		7,400	1.14	—	3,970	970	380	
Opepe (<i>Nauclea diderrichii</i>)	Green	0.63	13,600	1.73	12.2	7,480	1,900	1,520	AF
	12%		17,400	1.94	14.4	10,400	2,480	1,630	
Ovangkol (<i>Guibourtia ehie</i>)	Green	0.67	—	—	—	—	—	—	AF
	12%		16,900	2.56	—	8,300	—	—	
Para-angelim (<i>Hymenolobium excelsum</i>)	Green	0.63	14,600	1.95	12.8	7,460	1,600	1,720	AM
	12%		17,600	2.05	15.9	8,990	2,010	1,720	
Parana-pine (<i>Araucaria augustifolia</i>)	Green	0.46	7,200	1.35	9.7	4,010	970	560	AM
	12%	—	13,500	1.61	12.2	7,660	1,730	780	
Pau marfim (<i>Balfourodendron riedelianum</i>)	Green	0.73	14,400	1.66	—	6,070	—	—	AM
	15%		18,900	—	—	8,190	—	—	
Peroba de campos (<i>Paratecoma peroba</i>)	Green	0.62	—	—	—	—	—	—	AM
	12%		15,400	1.77	10.1	8,880	2,130	1,600	
Peroba rosa (<i>Aspidosperma</i> spp., peroba group)	Green	0.66	10,900	1.29	10.5	5,540	1,880	1,580	AM
	12%		12,100	1.53	9.2	7,920	2,490	1,730	
Pilon (<i>Hyeronima</i> spp.)	Green	0.65	10,700	1.88	8.3	4,960	1,200	1,220	AM
	12%		18,200	2.27	12.1	9,620	1,720	1,700	
Pine, Caribbean (<i>Pinus caribaea</i>)	Green	0.68	11,200	1.88	10.7	4,900	1,170	980	AM
	12%	—	16,700	2.24	17.3	8,540	2,090	1,240	
Pine, ocote (<i>Pinus oocarpa</i>)	Green	0.55	8,000	1.74	6.9	3,690	1,040	580	AM
	12%	—	14,900	2.25	10.9	7,680	1,720	910	
Pine, radiata (<i>Pinus radiata</i>)	Green	0.42	6,100	1.18	—	2,790	750	480	AS
	12%	—	11,700	1.48	—	6,080	1,600	750	
Piquia (<i>Caryocar</i> spp.)	Green	0.72	12,400	1.82	8.4	6,290	1,640	1,720	AM
	12%		17,000	2.16	15.8	8,410	1,990	1,720	
Primavera (<i>Tabebuia donnell-smithii</i>)	Green	0.4	7,200	0.99	7.2	3,510	1,030	700	AM
	12%		9,500	1.04	6.4	5,600	1,390	660	
Purpleheart (<i>Peltogyne</i> spp.)	Green	0.67	13,700	2	14.8	7,020	1,640	1,810	AM
	12%		19,200	2.27	17.6	10,320	2,220	1,860	
Ramin (<i>Gonystylus bancanus</i>)	Green	0.52	9,800	1.57	9	5,390	990	640	AS
	12%	—	18,500	2.17	17	10,080	1,520	1,300	
Robe (<i>Tabebuia</i> spp., robe group)	Green	0.52	10,800	1.45	11.7	4,910	1,250	910	AM
	12%		13,800	1.6	12.5	7,340	1,450	960	
Rosewood, Brazilian (<i>Dalbergia nigra</i>)	Green	0.8	14,100	1.84	13.2	5,510	2,360	2,440	AM
	12%	—	19,000	1.88	—	9,600	2,110	2,720	
Rosewood, Indian (<i>Dalbergia latifolia</i>)	Green	0.75	9,200	1.19	11.6	4,530	1,400	1,560	AS
	12%		16,900	1.78	13.1	9,220	2,090	3,170	
Sande (<i>Brosimum</i> spp., utile group)	Green	0.49	8,500	1.94	—	4,490	1,040	600	AM
	12%		14,300	2.39	—	8,220	1,290	900	
Santa Maria (<i>Calophyllum brasiliense</i>)	Green	0.52	10,500	1.59	12.7	4,560	1,260	890	AM
	12%	—	14,600	1.83	16.1	6,910	2,080	1,150	
Sapele (<i>Entandrophragma cylindricum</i>)	Green	0.55	10,200	1.49	10.5	5,010	1,250	1,020	AF
	12%	—	15,300	1.82	15.7	8,160	2,260	1,510	
Sepetir (<i>Pseudosindora palustris</i>)	Green	0.56	11,200	1.57	13.3	5,460	1,310	950	AS
	12%		17,200	1.97	13.3	8,880	2,030	1,410	

Table 5–5b. Mechanical properties of some woods imported into the United States other than Canadian imports (inch–pound)^a—con.

Common and botanical names of species	Moisture content	Specific gravity	Static bending			Compression parallel to grain (lbf in ⁻²)	Shear parallel to grain (lbf in ⁻²)	Side hardness (lbf)	Sample origin ^b
			Modulus of rupture (lbf in ⁻²)	Modulus of elasticity (×10 ⁶ lbf in ⁻²)	Work to maximum load (in·lbf in ⁻³)				
Shorea (<i>Shorea</i> spp., bullau group)	Green	0.68	11,700	2.1	—	5,380	1,440	1,350	AS
	12%		18,800	2.61	—	10,180	2,190	1,780	
Shorea, lauan–meranti group									
Dark red meranti	Green	0.46	9,400	1.5	8.6	4,720	1,110	700	AS
	12%		12,700	1.77	13.8	7,360	1,450	780	
Light red meranti	Green	0.34	6,600	1.04	6.2	3,330	710	440	AS
	12%		9,500	1.23	8.6	5,920	970	460	
White meranti	Green	0.55	9,800	1.3	8.3	5,490	1,320	1,000	AS
	15%		12,400	1.49	11.4	6,350	1,540	1,140	
Yellow meranti	Green	0.46	8,000	1.3	8.1	3,880	1,030	750	AS
	12%		11,400	1.55	10.1	5,900	1,520	770	
Spanish-cedar (<i>Cedrela</i> spp.)	Green	0.41	7,500	1.31	7.1	3,370	990	550	AM
	12%		—	11,500	1.44	9.4	6,210	1,100	
Sucupira (<i>Bowdichia</i> spp.)	Green	0.74	17,200	2.27	—	9,730	—	—	AM
	15%		19,400	—	—	11,100	—	—	
Sucupira (<i>Diploptropis purpurea</i>)	Green	0.78	17,400	2.68	13	8,020	1,800	1,980	AM
	12%		20,600	2.87	14.8	12,140	1,960	2,140	
Teak (<i>Tectona grandis</i>)	Green	0.55	11,600	1.37	13.4	5,960	1,290	930	AS
	12%		14,600	1.55	12	8,410	1,890	1,000	
Tornillo (<i>Cedrelinga cateniformis</i>)	Green	0.45	8,400	—	—	4,100	1,170	870	AM
	12%		—	—	—	—	—	—	
Wallaba (<i>Eperua</i> spp.)	Green	0.78	14,300	2.33	—	8,040	—	1,540	AM
	12%		—	19,100	2.28	—	10,760	—	

^aResults of tests on clear, straight-grained specimens. Property values were taken from world literature (not obtained from experiments conducted at the Forest Products Laboratory). Other species may be reported in the world literature, as well as additional data on many of these species. Some property values have been adjusted to 12% moisture content.

^bAF is Africa; AM, America; AS, Asia.

reevaluated to reflect these changes, the appropriateness of the data should be reviewed when used for critical applications such as stress grades of lumber.

Values reported in Table 5–5 were collected from the world literature; thus, the appropriateness of these properties to represent a species is not known. The properties reported in Tables 5–1, 5–2, 5–5, and 5–7 to 5–10 may not necessarily represent average species characteristics because of inadequate sampling; however, they do suggest the relative influence of species and other specimen parameters on the mechanical behavior recorded.

Variability in properties can be important in both production and consumption of wood products. The fact that a piece may be stronger, harder, or stiffer than the average is often of less concern to the user than if the piece is weaker; however, this may not be true if lightweight material is selected for a specific purpose or if harder or tougher material is difficult to work. Some indication of the spread of property values is therefore desirable. Average coefficients of variation for many mechanical properties are presented in Table 5–6.

The mechanical properties reported in the tables are significantly affected by specimen moisture content at time of test. Some tables include properties that were evaluated at different moisture levels; these moisture levels are reported. As indicated in the tables, many of the dry test data were adjusted to a common moisture content base of 12%.

Specific gravity is reported in many tables because this property is used as an index of clear wood mechanical properties. The specific gravity values given in Tables 5–3 and 5–4 represent the estimated average clear wood specific gravity of the species. In the other tables, specific gravity values represent only the specimens tested. The variability of specific gravity, represented by the coefficient of variation derived from tests on 50 species, is included in Table 5–6.

Mechanical and physical properties as measured and reported often reflect not only the characteristics of the wood but also the influence of the shape and size of the test specimen and the test mode. The test methods used to establish properties in Tables 5–3, 5–4, and 5–7 to 5–9 are based on standard procedures (ASTM D 143). Test methods for

Table 5–6. Average coefficients of variation for some mechanical properties of clear wood

Property	Coefficient of variation ^a (%)
Static bending	
Modulus of rupture	16
Modulus of elasticity	22
Work to maximum load	34
Impact bending	25
Compression parallel to grain	18
Compression perpendicular to grain	28
Shear parallel to grain, maximum shearing strength	14
Tension parallel to grain	25
Side hardness	20
Toughness	34
Specific gravity	10

^aValues based on results of tests of green wood from approximately 50 species. Values for wood adjusted to 12% moisture content may be assumed to be approximately of the same magnitude.

Table 5–7. Average parallel-to-grain tensile strength of some wood species^a

Species	Tensile strength (kPa (lb in ⁻²))	
	Hardwoods	
Beech, American	86,200	(12,500)
Elm, cedar	120,700	(17,500)
Maple, sugar	108,200	(15,700)
Oak		
Overcup	77,900	(11,300)
Pin	112,400	(16,300)
Poplar, balsam	51,000	(7,400)
Sweetgum	93,800	(13,600)
Willow, black	73,100	(10,600)
Yellow-poplar	109,600	(15,900)
	Softwoods	
Baldcypress	58,600	(8,500)
Cedar		
Port-Orford	78,600	(11,400)
Western redcedar	45,500	(6,600)
Douglas-fir, interior north	107,600	(15,600)
Fir		
California red	77,900	(11,300)
Pacific silver	95,100	(13,800)
Hemlock, western	89,600	(13,000)
Larch, western	111,700	(16,200)
Pine		
Eastern white	73,100	(10,600)
Loblolly	80,000	(11,600)
Ponderosa	57,900	(8,400)
Virginia	94,500	(13,700)
Redwood		
Virgin	64,800	(9,400)
Young growth	62,700	(9,100)
Spruce		
Engelmann	84,800	(12,300)
Sitka	59,300	(8,600)

^aResults of tests on clear, straight-grained specimens tested green. For hardwood species, strength of specimens tested at 12% moisture content averages about 32% higher; for softwoods, about 13% higher.

properties presented in other tables are referenced in the selected bibliography at the end of this chapter.

Common names of species listed in the tables conform to standard nomenclature of the U.S. Forest Service. Other names may be used locally for a species. Also, one common name may be applied to groups of species for marketing.

Natural Characteristics Affecting Mechanical Properties

Clear straight-grained wood is used for determining fundamental mechanical properties; however, because of natural growth characteristics of trees, wood products vary in specific gravity, may contain cross grain, or may have knots and localized slope of grain. Natural defects such as pitch pockets may occur as a result of biological or climatic elements influencing the living tree. These wood characteristics must be taken into account in assessing actual properties or estimating actual performance of wood products.

Specific Gravity

The substance of which wood is composed is actually heavier than water; its specific gravity is about 1.5 regardless of wood species. In spite of this, dry wood of most species floats in water, and it is thus evident that part of the volume of a piece of wood is occupied by cell cavities and pores. Variations in the size of these openings and in the thickness of the cell walls cause some species to have more wood substance per unit volume than other species and therefore higher specific gravity. Thus, specific gravity is an excellent index of the amount of wood substance contained in a piece of wood; it is a good index of mechanical properties as long as the wood is clear, straight grained, and free from defects. However, specific gravity values also reflect the presence of gums, resins, and extractives, which contribute little to mechanical properties.

Approximate relationships between various mechanical properties and specific gravity for clear straight-grained wood of hardwoods and softwoods are given in Table 5–11 as power functions. Those relationships are based on average values for the 43 softwood and 66 hardwood species presented in Table 5–3. The average data vary around the relationships, so that the relationships do not accurately predict individual average species values or an individual specimen value. In fact, mechanical properties within a species tend to be linearly, rather than curvilinearly, related to specific gravity; where data are available for individual species, linear analysis is suggested.

Knots

A knot is that portion of a branch that has become incorporated in the bole of a tree. The influence of a knot on the mechanical properties of a wood member is due to the interruption of continuity and change in the direction of wood fibers

Table 5–8. Average toughness values for a few hardwood species^a

Species	Moisture content	Specific gravity ^c	Toughness ^b			
			Radial (J (in-lbf))		Tangential (J (in-lbf))	
Birch, yellow	12%	0.65	8,100	(500)	10,100	(620)
Hickory (mockernut, pignut, sand)	12%	0.71	11,400	(700)	11,700	(720)
Maple, sugar	14%	0.64	6,000	(370)	5,900	(360)
Oak, red						
Pin	12%	0.64	7,000	(430)	7,000	(430)
Scarlet	11%	0.66	8,300	(510)	7,200	(440)
Oak, white						
Overcup	Green	0.56	11,900	(730)	11,100	(680)
	13%	0.62	5,500	(340)	5,000	(310)
Sweetgum	Green	0.48	5,500	(340)	5,400	(330)
	13%	0.51	4,200	(260)	4,200	(260)
Willow, black	Green	0.38	5,000	(310)	5,900	(360)
	11%	0.4	3,400	(210)	3,700	(230)
Yellow-poplar	Green	0.43	5,200	(320)	4,900	(300)
	12%	0.45	3,600	(220)	3,400	(210)

^aResults of tests on clear, straight-grained specimens.

^bProperties based on specimen size of 2 cm square by 28 cm long; radial indicates load applied to radial face and tangential indicates load applied to tangential face of specimens.

^cBased on oven-dry weight and volume at moisture content of test.

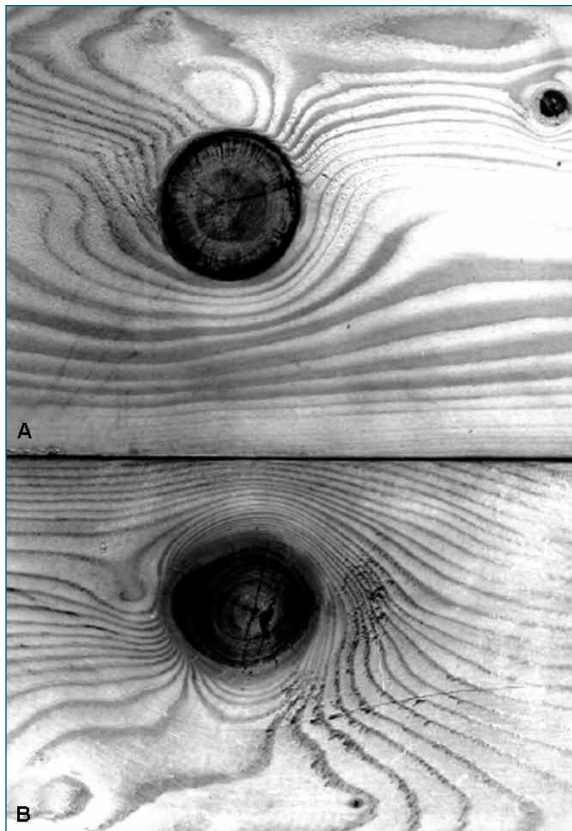

Figure 5–3. Types of knots. A, encased knot; B, intergrown knot.

associated with the knot. The influence of knots depends on their size, location, shape, and soundness; attendant local slope of grain; and type of stress to which the wood member is subjected.

The shape (form) of a knot on a sawn surface depends upon the direction of the exposing cut. A nearly round knot is produced when lumber is sawn from a log and a branch is sawn through at right angles to its length (as in a flatsawn board). An oval knot is produced if the saw cut is diagonal to the branch length (as in a bastard-sawn board) and a “spiked” knot when the cut is lengthwise to the branch (as in a quartersawn board).

Knots are further classified as intergrown or encased (Fig. 5–3). As long as a limb remains alive, there is continuous growth at the junction of the limb and the bole of the tree, and the resulting knot is called intergrown. After the branch has died, additional growth on the trunk encloses the dead limb, resulting in an encased knot; bole fibers are not continuous with the fibers of the encased knot. Encased knots and knotholes tend to be accompanied by less cross-grain than are intergrown knots and are therefore generally less problematic with regard to most mechanical properties.

Most mechanical properties are lower in sections containing knots than in clear straight-grained wood because (a) the clear wood is displaced by the knot, (b) the fibers around the knot are distorted, resulting in cross grain, (c) the discontinuity of wood fiber leads to stress concentrations, and (d) checking often occurs around the knots during drying. Hardness and strength in compression perpendicular to the grain

Table 5–9. Average toughness values for a few softwood species^a

Species	Moisture content	Specific gravity ^c	Toughness ^b			
			Radial (J (in-lbf))		Tangential (J (in-lbf))	
Cedar						
Western red	9%	0.33	1,500	(90)	2,100	(130)
Yellow	10%	0.48	3,400	(210)	3,700	(230)
Douglas-fir						
Coast	Green	0.44	3,400	(210)	5,900	(360)
	12%	0.47	3,300	(200)	5,900	(360)
Interior west	Green	0.48	3,300	(200)	4,900	(300)
	13%	0.51	3,400	(210)	5,500	(340)
Interior north	Green	0.43	2,800	(170)	3,900	(240)
	14%	0.46	2,600	(160)	4,100	(250)
Interior south	Green	0.38	2,100	(130)	2,900	(180)
	14%	0.4	2,000	(120)	2,900	(180)
Fir						
California red	Green	0.36	2,100	(130)	2,900	(180)
	12%	0.39	2,000	(120)	2,800	(170)
Noble	Green	0.36	—	—	3,900	(240)
	12%	0.39	—	—	3,600	(220)
Pacific silver	Green	0.37	2,400	(150)	3,700	(230)
	13%	0.4	2,800	(170)	4,200	(260)
White	Green	0.36	2,300	(140)	3,600	(220)
	13%	0.38	2,100	(130)	3,300	(200)
Hemlock						
Mountain	Green	0.41	4,100	(250)	4,600	(280)
	14%	0.44	2,300	(140)	2,800	(170)
Western	Green	0.38	2,400	(150)	2,800	(170)
	12%	0.41	2,300	(140)	3,400	(210)
Larch, western	Green	0.51	4,400	(270)	6,500	(400)
	12%	0.55	3,400	(210)	5,500	(340)
Pine						
Eastern white	Green	0.33	2,000	(120)	2,600	(160)
	12%	0.34	1,800	(110)	2,000	(120)
Jack	Green	0.41	3,300	(200)	6,200	(380)
	12%	0.42	2,300	(140)	3,900	(240)
Loblolly	Green	0.48	5,000	(310)	6,200	(380)
	12%	0.51	2,600	(160)	4,200	(260)
Lodgepole	Green	0.38	2,600	(160)	3,400	(210)
Ponderosa	Green	0.38	3,100	(190)	4,400	(270)
	11%	0.43	2,400	(150)	3,100	(190)
Red	Green	0.4	3,400	(210)	5,700	(350)
	12%	0.43	2,600	(160)	4,700	(290)
Shortleaf	Green	0.47	4,700	(290)	6,500	(400)
	13%	0.5	2,400	(150)	3,700	(230)
Slash	Green	0.55	5,700	(350)	7,300	(450)
	12%	0.59	3,400	(210)	5,200	(320)
Virginia	Green	0.45	5,500	(340)	7,600	(470)
	12%	0.49	2,800	(170)	4,100	(250)
Redwood						
Old-growth	Green	0.39	1,800	(110)	3,300	(200)
	11%	0.39	1,500	(90)	2,300	(140)
Young-growth	Green	0.33	1,800	(110)	2,300	(140)
	12%	0.34	1,500	(90)	1,800	(110)
Spruce, Engelmann	Green	0.34	2,400	(150)	3,100	(190)
	12%	0.35	1,800	(110)	2,900	(180)

^aResults of tests on clear, straight-grained specimens.

^bProperties based on specimen size of 2 cm square by 28 cm long; radial indicates load applied to radial face and tangential indicates load applied to tangential face of specimens.

^cBased on oven-dry weight and volume at moisture content of test.

Table 5–10. Summary of selected fracture toughness results

Species	Fracture toughness (kPa m ^{1/2} (lbf in ⁻² in ^{1/2}))			
	Mode I		Mode II	
	TL	RL	TL	RL
Douglas-fir	320 (290)	360 (330)		2,230 (2,030)
Western hemlock	375 (340)		2,240 (2,040)	
Pine				
Western white	250 (225)	260 (240)		
Scots	440 (400)	500 (455)	2,050 (1,860)	
Southern	375 (340)		2,070 (1,880)	
Ponderosa	290 (265)			
Red spruce	420 (380)		2,190 (1,990)	1,665 (1,510)
Northern red oak	410 (370)			
Sugar maple	480 (430)			
Yellow-poplar	517 (470)			

are exceptions, where knots may be objectionable only in that they cause nonuniform wear or nonuniform stress distributions at contact surfaces.

Knots have a much greater effect on strength in axial tension than in axial short-column compression, and the effects on bending are somewhat less than those in axial tension. For this reason, in a simply supported beam, a knot on the lower side (subjected to tensile stresses) has a greater effect on the load the beam will support than does a knot on the upper side (subjected to compressive stresses).

In long columns, knots are important because they affect stiffness. In short or intermediate columns, the reduction in strength caused by knots is approximately proportional to their size; however, large knots have a somewhat greater relative effect than do small knots.

Knots in round timbers, such as poles and piles, have less effect on strength than do knots in sawn timbers. Although the grain is irregular around knots in both forms of timber, the angle of the grain to the surface is smaller in naturally round timber than in sawn timber. Furthermore, in round timbers there is no discontinuity in wood fibers, which results from sawing through both local and general slope of grain.

The effects of knots in structural lumber are discussed in Chapter 7.

Slope of Grain

In some wood product applications, the directions of important stresses may not coincide with the natural axes of fiber orientation in the wood. This may occur by choice in

Table 5–11a. Functions relating mechanical properties to specific gravity of clear, straight-grained wood (metric)

Property ^a	Specific gravity–strength relationship			
	Green wood		Wood at 12% moisture content	
	Softwoods	Hardwoods	Softwoods	Hardwoods
Static bending				
MOR (kPa)	109,600 $G^{1.01}$	118,700 $G^{1.16}$	170,700 $G^{1.01}$	171,300 $G^{1.13}$
MOE (MPa)	16,100 $G^{0.76}$	13,900 $G^{0.72}$	20,500 $G^{0.84}$	16,500 $G^{0.7}$
WML (kJ m^{-3})	147 $G^{1.21}$	229 $G^{1.51}$	179 $G^{1.34}$	219 $G^{1.54}$
Impact bending (N)	353 $G^{1.35}$	422 $G^{1.39}$	346 $G^{1.39}$	423 $G^{1.65}$
Compression parallel (kPa)	49,700 $G^{0.94}$	49,000 $G^{1.11}$	93,700 $G^{0.97}$	76,000 $G^{0.89}$
Compression perpendicular (kPa)	8,800 $G^{1.53}$	18,500 $G^{2.48}$	16,500 $G^{1.57}$	21,600 $G^{2.09}$
Shear parallel (kPa)	11,000 $G^{0.73}$	17,800 $G^{1.24}$	16,600 $G^{0.85}$	21,900 $G^{1.13}$
Tension perpendicular (kPa)	3,800 $G^{0.78}$	10,500 $G^{1.37}$	6,000 $G^{1.11}$	10,100 $G^{1.3}$
Side hardness (N)	6,230 $G^{1.41}$	16,550 $G^{2.31}$	8,590 $G^{1.49}$	15,300 $G^{2.09}$

^aCompression parallel to grain is maximum crushing strength; compression perpendicular to grain is fiber stress at proportional limit. MOR is modulus of rupture; MOE, modulus of elasticity; and WML, work to maximum load. For green wood, use specific gravity based on oven-dry weight and green volume; for dry wood, use specific gravity based on oven-dry weight and volume at 12% moisture content. Calculated using all data from Table 5–3.

Table 5–11b. Functions relating mechanical properties to specific gravity of clear, straight-grained wood (inch–pound)

Property ^a	Specific gravity–strength relationship			
	Green wood		Wood at 12% moisture content	
	Softwoods	Hardwoods	Softwoods	Hardwoods
Static bending				
MOR (lb in^{-2})	15,890 $G^{1.01}$	17,210 $G^{1.16}$	24,760 $G^{1.01}$	24,850 $G^{1.13}$
MOE ($\times 10^6 \text{ lb in}^{-2}$)	2.33 $G^{0.76}$	2.02 $G^{0.72}$	2.97 $G^{0.84}$	2.39 $G^{0.7}$
WML (in-lbf in^{-3})	21.33 $G^{1.21}$	33.2 $G^{1.51}$	25.9 $G^{1.34}$	31.8 $G^{1.54}$
Impact bending (lbf)	79.28 $G^{1.35}$	94.8 $G^{1.39}$	77.7 $G^{1.39}$	95.1 $G^{1.65}$
Compression parallel (lb in^{-2})	7,210 $G^{0.94}$	7,110 $G^{1.11}$	13,590 $G^{0.97}$	11,030 $G^{0.89}$
Compression perpendicular (lb in^{-2})	1,270 $G^{1.53}$	2,680 $G^{2.48}$	2,390 $G^{1.57}$	3,130 $G^{2.09}$
Shear parallel (lb in^{-2})	1,590 $G^{0.73}$	2,580 $G^{1.24}$	2,410 $G^{0.85}$	3,170 $G^{1.13}$
Tension perpendicular (lb in^{-2})	550 $G^{0.78}$	1,520 $G^{1.37}$	870 $G^{1.11}$	1,460 $G^{1.3}$
Side hardness (lbf)	1,400 $G^{1.41}$	3,720 $G^{2.31}$	1,930 $G^{1.49}$	3,440 $G^{2.09}$

^aCompression parallel to grain is maximum crushing strength; compression perpendicular to grain is fiber stress at proportional limit. MOR is modulus of rupture; MOE, modulus of elasticity; and WML, work to maximum load. For green wood, use specific gravity based on oven-dry weight and green volume; for dry wood, use specific gravity based on oven-dry weight and volume at 12% moisture content. Calculated using all data from Table 5–3.

design, from the way the wood was removed from the log, or because of grain irregularities that occurred while the tree was growing.

Elastic properties in directions other than along the natural axes can be obtained from elastic theory. Strength properties in directions ranging from parallel to perpendicular to the fibers can be approximated using a Hankinson-type formula (Bodig and Jayne 1982):

$$N = \frac{PQ}{P \sin^n \theta + Q \cos^n \theta} \quad (5-2)$$

where N is strength at angle θ from fiber direction, Q strength perpendicular to grain, P strength parallel to grain, and n an empirically determined constant.

This formula has been used for modulus of elasticity as well as strength properties. Values of n and associated ratios of Q/P tabulated from available literature are as follows:

Property	n	Q/P
Tensile strength	1.5–2	0.04–0.07
Compression strength	2–2.5	0.03–0.40
Bending strength	1.5–2	0.04–0.10
Modulus of elasticity	2	0.04–0.12
Toughness	1.5–2	0.06–0.10

The Hankinson-type formula can be graphically depicted as a function of Q/P and n . Figure 5–4 shows the strength in any direction expressed as a fraction of the strength parallel

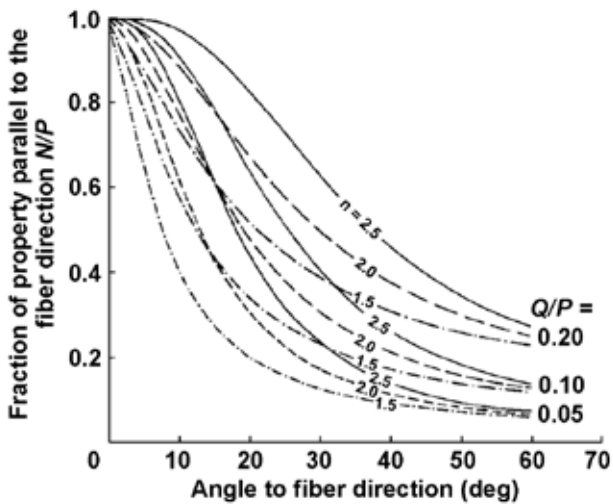

Figure 5-4. Effect of grain angle on mechanical property of clear wood according to Hankinson-type formula. Q/P is ratio of mechanical property across the grain (Q) to that parallel to the grain (P); n is an empirically determined constant.

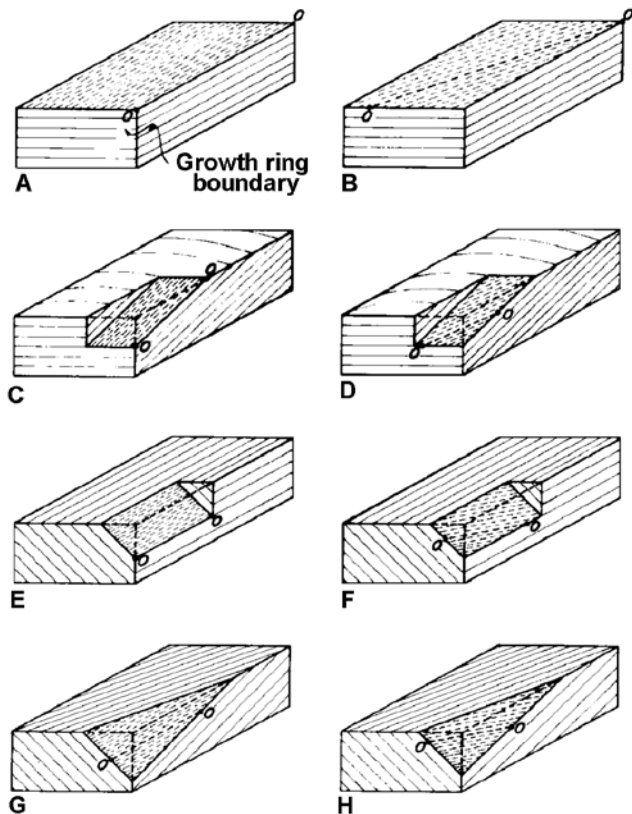

Figure 5-5. Relationship of fiber orientation (O-O) to axes, as shown by schematic of wood specimens containing straight grain and cross grain. Specimens A through D have radial and tangential surfaces; E through H do not. Specimens A and E contain no cross grain; B, D, F, and H have spiral grain; C, D, G, and H have diagonal grain.

to fiber direction, plotted against angle to the fiber direction θ . The plot is for a range of values of Q/P and n .

The term slope of grain relates the fiber direction to the edges of a piece. Slope of grain is usually expressed by the ratio between 25 mm (1 in.) of the grain from the edge or long axis of the piece and the distance in millimeters (inches) within which this deviation occurs ($\tan \theta$). The effect of grain slope on some properties of wood, as determined from tests, is shown in Table 5-12. The values for modulus of rupture fall very close to the curve in Figure 5-4 for $Q/P = 0.1$ and $n = 1.5$. Similarly, the impact bending values fall close to the curve for $Q/P = 0.05$ and $n = 1.5$, and the compression values for the curve for $Q/P = 0.1$, $n = 2.5$.

The term cross grain indicates the condition measured by slope of grain. Two important forms of cross grain are spiral and diagonal (Fig. 5-5). Other types are wavy, dipped, interlocked, and curly.

Spiral grain is caused by winding or spiral growth of wood fibers about the bole of the tree instead of vertical growth. In sawn products, spiral grain can be defined as fibers lying in the tangential plane of the growth rings, rather than parallel to the longitudinal axis of the product (see Fig. 5-5 for a simple case). Spiral grain in sawn products often goes undetected by ordinary visual inspection. The best test for spiral grain is to split a sample section from the piece in the radial direction. A visual method of determining the presence of spiral grain is to note the alignment of pores, rays, and resin ducts on a flatsawn face. Drying checks on a flatsawn surface follow the fibers and indicate the slope of the fiber. Relative change in electrical capacitance is an effective technique for measuring slope of grain.

Diagonal grain is cross grain caused by growth rings that are not parallel to one or both surfaces of the sawn piece. Diagonal grain is produced by sawing a log with pronounced taper parallel to the axis (pith) of the tree. Diagonal grain also occurs in lumber sawn from crooked logs or logs with butt swell.

Cross grain can be quite localized as a result of the disturbance of a growth pattern by a branch. This condition, termed local slope of grain, may be present even though the branch (knot) may have been removed by sawing. The degree of local cross grain may often be difficult to determine. Any form of cross grain can have a deleterious effect on mechanical properties or machining characteristics.

Spiral and diagonal grain can combine to produce a more complex cross grain. To determine net cross grain, regardless of origin, fiber slopes on the contiguous surface of a piece must be measured and combined. The combined slope of grain is determined by taking the square root of the sum of the squares of the two slopes. For example, assume

Table 5–12. Strength of wood members with various grain slopes compared with strength of a straight-grained member^a

Maximum slope of grain in member	Modulus of rupture (%)	Impact bending (%)	Compression parallel to grain (%)
Straight-grained	100	100	100
1 in 25	96	95	100
1 in 20	93	90	100
1 in 15	89	81	100
1 in 10	81	62	99
1 in 5	55	36	93

^aImpact bending is height of drop causing complete failure (22.7-kg (50-lb) hammer); compression parallel to grain is maximum crushing strength.

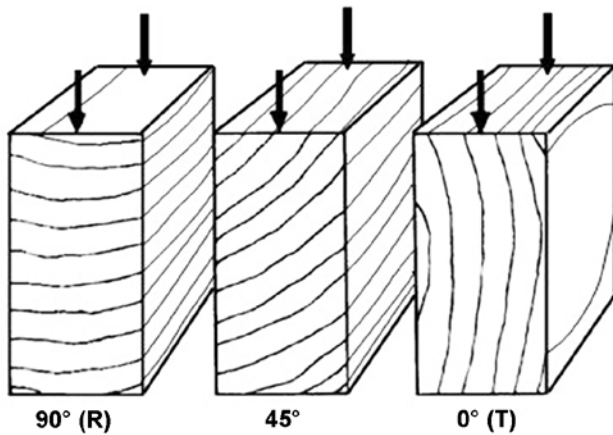

Figure 5–6. Direction of load in relation to direction of annual growth rings: 90° or perpendicular (R), 45°, 0° or parallel (T).

that the spiral grain slope on the flat-grained surface of Figure 5–5D is 1 in 12 and the diagonal-grain slope is 1 in 18. The combined slope is

$$\sqrt{(1/18)^2 + (1/12)^2} = 1/10$$

or a slope of 1 in 10.

A regular reversal of right and left spiraling of grain in a tree stem produces the condition known as interlocked grain. Interlocked grain occurs in some hardwood species and markedly increases resistance to splitting in the radial plane. Interlocked grain decreases both the static bending strength and stiffness of clear wood specimens. The data from tests of domestic hardwoods shown in Table 5–3 do not include pieces that exhibited interlocked grain. Some mechanical property values in Table 5–5 are based on specimens with interlocked grain because that is a characteristic of some species. The presence of interlocked grain alters the relationship between bending strength and compressive strength of lumber cut from tropical hardwoods.

Annual Ring Orientation

Stresses perpendicular to the fiber (grain) direction may be at any angle from 0° (*T* direction) to 90° (*R* direction) to the growth rings (Fig. 5–6). Perpendicular-to-grain properties depend somewhat upon orientation of annual rings with respect to the direction of stress. The compression perpendicular-to-grain values in Table 5–3 were derived from tests in which the load was applied parallel to the growth rings (*T* direction); shear parallel-to-grain and tension perpendicular-to-grain values are averages of equal numbers of specimens with 0° and 90° growth ring orientations. In some species, there is no difference in 0° and 90° orientation properties. Other species exhibit slightly higher shear parallel or tension perpendicular-to-grain properties for the 0° orientation than for the 90° orientation; the converse is true for about an equal number of species.

The effects of intermediate annual ring orientations have been studied in a limited way. Modulus of elasticity, compressive perpendicular-to-grain stress at the proportional limit, and tensile strength perpendicular to the grain tend to be about the same at 45° and 0°, but for some species these values are 40% to 60% lower at the 45° orientation. For those species with lower properties at 45° ring orientation, properties tend to be about equal at 0° and 90° orientations. For species with about equal properties at 0° and 45° orientations, properties tend to be higher at the 90° orientation.

Reaction Wood

Abnormal woody tissue is frequently associated with leaning boles and crooked limbs of both conifers and hardwoods. Such wood is generally believed to be formed as a natural response of the tree to return its limbs or bole to a more normal position, hence the term reaction wood. In softwoods, the abnormal tissue is called compression wood; it is common to all softwood species and is found on the lower side of the limb or inclined bole. In hardwoods, the abnormal tissue is known as tension wood; it is located on the upper side of the inclined member, although in some instances it is distributed irregularly around the cross section. Reaction wood is more prevalent in some species than in others.

Many of the anatomical, chemical, physical, and mechanical properties of reaction wood differ distinctly from those of normal wood. Perhaps most evident is the increase in density compared with that of normal wood. The specific gravity of compression wood is commonly 30% to 40% greater than that of normal wood; the specific gravity of tension wood commonly ranges between 5% and 10% greater than that of normal wood, but it may be as much as 30% greater.

Compression wood is usually somewhat darker than normal wood because of the greater proportion of latewood, and it frequently has a relatively lifeless appearance, especially in woods in which the transition from earlywood to latewood is abrupt. Because compression wood is more opaque than



Figure 5-7. Projecting tension wood fibers on sawn surface of mahogany board.

normal wood, intermediate stages of compression wood can be detected by transmitting light through thin cross sections; however, borderline forms of compression wood that merge with normal wood can commonly be detected only by microscopic examination.

Tension wood is more difficult to detect than is compression wood. However, eccentric growth as seen on the transverse section suggests its presence. Also, because it is difficult to cleanly cut the tough tension wood fibers, the surfaces of sawn boards are “woolly,” especially when the boards are sawn in the green condition (Fig. 5-7). In some species, tension wood may be evident on a smooth surface as areas of contrasting colors. Examples of this are the silvery appearance of tension wood in sugar maple and the darker color of tension wood in mahogany.

Reaction wood, particularly compression wood in the green condition, may be stronger than normal wood. However, compared with normal wood with similar specific gravity, reaction wood is definitely weaker. Possible exceptions to this are compression parallel-to-grain properties of compression wood and impact bending properties of tension wood.

Because of the abnormal properties of reaction wood, it may be desirable to eliminate this wood from raw material. In logs, compression wood is characterized by eccentric growth about the pith and the large proportion of latewood at the point of greatest eccentricity (Fig. 5-8A). Fortunately, pronounced compression wood in lumber can generally be detected by ordinary visual examination.

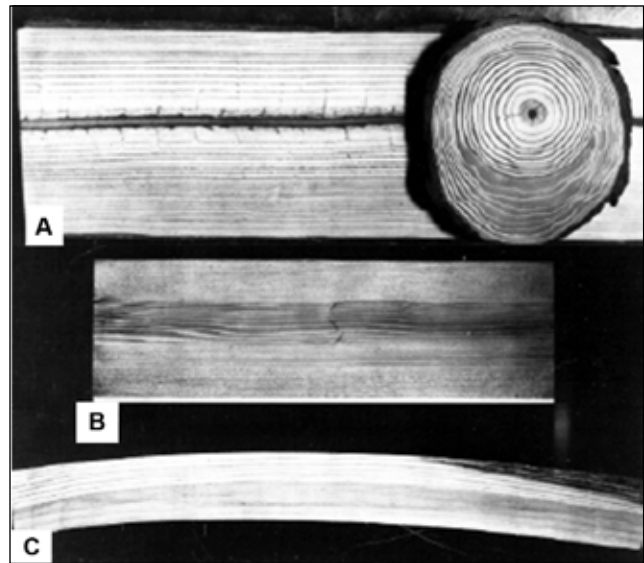

Figure 5-8. Effects of compression wood. A, eccentric growth about pith in cross section containing compression wood—dark area in lower third of cross section is compression wood; B, axial tension break caused by excessive longitudinal shrinkage of compression wood; C, warp caused by excessive longitudinal shrinkage.

Compression and tension wood undergo extensive longitudinal shrinkage when subjected to moisture loss below the fiber saturation point. Longitudinal shrinkage in compression wood may be up to 10 times that in normal wood, and in tension wood, perhaps up to 5 times that in normal wood. When reaction wood and normal wood are present in the same board, unequal longitudinal shrinkage causes internal stresses that result in warping. In extreme cases, unequal longitudinal shrinkage results in axial tension failure over a portion of the cross section of the lumber (Fig. 5-8B). Warp sometimes occurs in rough lumber but more often in planed, ripped, or resawn lumber (Fig. 5-8C).

Juvenile Wood

Juvenile wood is the wood produced near the pith of the tree; for softwoods, it is usually defined as the material 5 to 20 rings from the pith depending on species. Juvenile wood has considerably different physical and anatomical properties than that of mature wood (Fig. 5-9). In clear wood, the properties that have been found to influence mechanical behavior include fibril angle, cell length, and specific gravity, the latter a composite of percentage of latewood, cell wall thickness, and lumen diameter. Juvenile wood has a high fibril angle (angle between longitudinal axis of wood cell and cellulose fibrils), which causes longitudinal shrinkage that may be more than 10 times that of mature wood. Compression wood and spiral grain are also more prevalent in juvenile wood than in mature wood and contribute to longitudinal shrinkage. In structural lumber, the ratio of modulus of rupture, ultimate tensile stress, and modulus of elasticity for juvenile to mature wood ranges from 0.5

to 0.9, 0.5 to 0.95, and 0.45 to 0.75, respectively. Changes in shear strength resulting from increases in juvenile wood content can be adequately predicted by monitoring changes in density alone for all annual ring orientations. The same is true for perpendicular-to-grain compressive strength when the load is applied in the tangential direction. Compressive strength perpendicular-to-grain for loads applied in the radial direction, however, is more sensitive to changes in juvenile wood content and may be up to eight times less than that suggested by changes in density alone (Kretschmann 2008). The juvenile wood to mature wood ratio is lower for higher grades of lumber than for lower grades, which indicates that juvenile wood has greater influence in reducing the mechanical properties of high-grade structural lumber. Only a limited amount of research has been done on juvenile wood in hardwood species.

Compression Failures

Excessive compressive stresses along the grain that produce minute compression failures can be caused by excessive bending of standing trees from wind or snow; felling of trees across boulders, logs, or irregularities in the ground; or rough handling of logs or lumber. Compression failures should not be confused with compression wood. In some instances, compression failures are visible on the surface of a board as minute lines or zones formed by crumpling or buckling of cells (Fig. 5–10A), although the failures usually appear as white lines or may even be invisible to the unaided eye. The presence of compression failures may be indicated by fiber breakage on end grain (Fig. 5–10B). Because compression failures are often difficult to detect with the unaided eye, special efforts, including optimum lighting, may be required for detection. The most difficult cases are detected only by microscopic examination.

Products containing visible compression failures have low strength properties, especially in tensile strength and shock resistance. The tensile strength of wood containing compression failures may be as low as one-third the strength of matched clear wood. Even slight compression failures, visible only under a microscope, may seriously reduce strength and cause brittle fracture. Because of the low strength

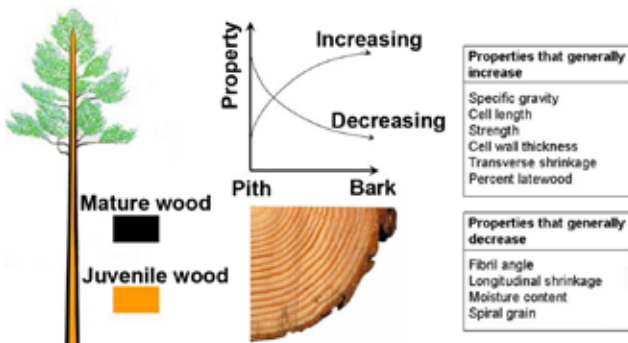

Figure 5–9. Properties of juvenile wood.

associated with compression failures, many safety codes require certain structural members, such as ladder rails and scaffold planks, to be entirely free of such failures.

Pitch Pockets

A pitch pocket is a well-defined opening that contains free resin. The pocket extends parallel to the annual rings; it is almost flat on the pith side and curved on the bark side. Pitch pockets are confined to such species as the pines, spruces, Douglas-fir, tamarack, and western larch.

The effect of pitch pockets on strength depends upon their number, size, and location in the piece. A large number of pitch pockets indicates a lack of bond between annual growth layers, and a piece with pitch pockets should be inspected for shake or separation along the grain.

Bird Peck

Maple, hickory, white ash, and a number of other species are often damaged by small holes made by woodpeckers. These bird pecks often occur in horizontal rows, sometimes encircling the tree, and a brown or black discoloration known as a mineral streak originates from each hole. Holes for tapping

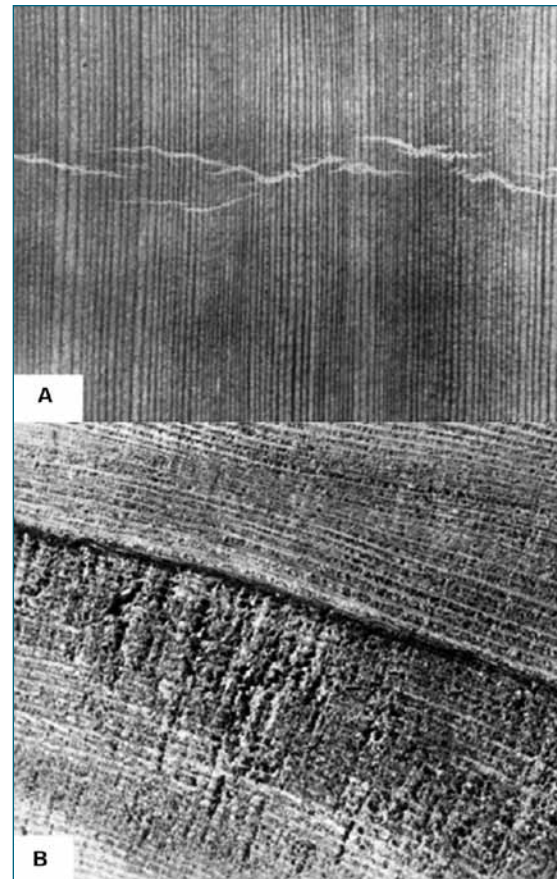

Figure 5–10. Compression failures. A, compression failure shown by irregular lines across grain; B, fiber breakage in end-grain surfaces of spruce lumber caused by compression failures below dark line.

Table 5–13. Intersection moisture content values for selected species^a

Species	M_p (%)
Ash, white	24
Birch, yellow	27
Chestnut, American	24
Douglas-fir	24
Hemlock, western	28
Larch, western	28
Pine, loblolly	21
Pine, longleaf	21
Pine, red	24
Redwood	21
Spruce, red	27
Spruce, Sitka	27
Tamarack	24

^aIntersection moisture content is point at which mechanical properties begin to change when wood is dried from the green condition.

maple trees are also a source of mineral streaks. The streaks are caused by oxidation and other chemical changes in the wood. Bird pecks and mineral streaks are not generally important in regard to strength of structural lumber, although they do impair the appearance of the wood.

Extractives

Many wood species contain removable extraneous materials or extractives that do not degrade the cellulose–lignin structure of the wood. These extractives are especially abundant in species such as larch, redwood, western redcedar, and black locust.

A small decrease in modulus of rupture and strength in compression parallel to grain has been measured for some species after the extractives have been removed. The extent to which extractives influence strength is apparently a function of the amount of extractives, the moisture content of the piece, and the mechanical property under consideration.

Properties of Timber from Dead Trees

Timber from trees killed by insects, blight, wind, or fire may be as good for any structural purpose as that from live trees, provided further insect attack, staining, decay, or drying degrade has not occurred. In a living tree, the heartwood is entirely dead and only a comparatively few sapwood cells are alive. Therefore, most wood is dead when cut, regardless of whether the tree itself is living or not. However, if a tree stands on the stump too long after its death, the sapwood is likely to decay or to be attacked severely by wood-boring insects, and eventually the heartwood will be similarly affected. Such deterioration also occurs in logs that have been cut from live trees and improperly cared for afterwards. Because of variations in climatic and other factors that affect deterioration, the time that dead timber may stand or lie in the forest without serious deterioration varies.

Tests on wood from trees that had stood as long as 15 years after being killed by fire demonstrated that this wood was as sound and strong as wood from live trees. Also, the heartwood of logs of some more durable species has been found to be thoroughly sound after lying in the forest for many years.

On the other hand, in nonresistant species, decay may cause great loss of strength within a very brief time, both in trees standing dead on the stump and in logs cut from live trees and allowed to lie on the ground. The important consideration is not whether the trees from which wood products are cut are alive or dead, but whether the products themselves are free from decay or other degrading factors that would render them unsuitable for use.

Effects of Manufacturing and Service Environments

Moisture Content

Many mechanical properties are affected by changes in moisture content below the fiber saturation point. Most properties reported in Tables 5–3 to 5–5 increase with decrease in moisture content. The relationship that describes these changes in clear wood property at about 21 °C (70 °F) is

$$P = P_{12} \left(\frac{P_{12}}{P_g} \right)^{\left(\frac{12-M}{M_p-12} \right)} \quad (5-3)$$

where P is the property at moisture content M (%), P_{12} the same property at 12% MC, P_g the same property for green wood, and M_p moisture content at the intersection of a horizontal line representing the strength of green wood and an inclined line representing the logarithm of the strength–moisture content relationship for dry wood. This assumed linear relationship results in an M_p value that is slightly less than the fiber saturation point. Table 5–13 gives values of M_p for a few species; for other species, $M_p = 25$ may be assumed.

Average property values of P_{12} and P_g are given for many species in Tables 5–3 to 5–5. The formula for moisture content adjustment is not recommended for work to maximum load, impact bending, and tension perpendicular to grain. These properties are known to be erratic in their response to moisture content change.

The formula can be used to estimate a property at any moisture content below M_p from the species data given. For example, suppose you want to find the modulus of rupture of white ash at 8% moisture content. Using information from Tables 5–3a and 5–13,

$$P_g = 103,000 \left[\frac{103,000}{66,000} \right]^{4/12} = 119,500 \text{ kPa}$$

Care should be exercised when adjusting properties below 12% moisture. Although most properties will continue to

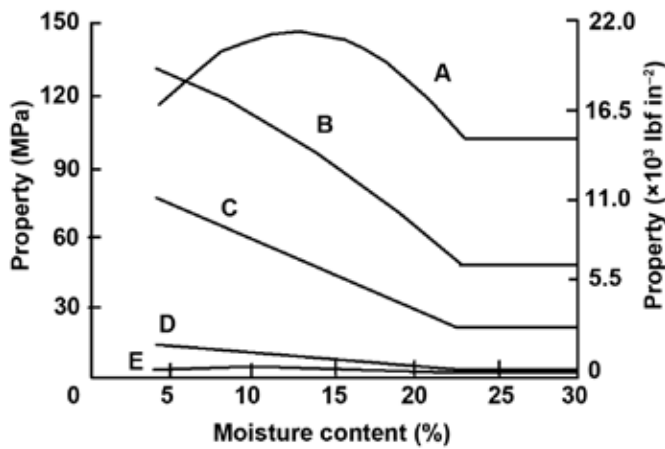

Figure 5–11. Effect of moisture content on wood strength properties. A, tension parallel to grain; B, bending; C, compression parallel to grain; D, compression perpendicular to grain; and E, tension perpendicular to grain.

Table 5–14. Moisture content for maximum property value in drying clear Southern Pine and yellow poplar from green to 4% moisture content

Property	Moisture content at which peak property occurs (%)	
	Southern Pine	Yellow poplar
Ultimate tensile stress parallel to grain	12.6	8.6
Ultimate tensile stress perpendicular to grain	10.2	7.1
MOE tension perpendicular to grain	4.3	—
MOE compression parallel to grain	4.3	4.0
Modulus of rigidity, G_{RT}	10.0	—

increase while wood is dried to very low moisture content levels, for most species some properties may reach a maximum value and then decrease with further drying (Fig. 5–11) (Kretschmann and Green 1996, 2008). For clear Southern Pine and yellow poplar, the moisture content at which a maximum property has been observed is given in Table 5–14.

This increase in mechanical properties with drying assumes small, clear specimens in a drying process in which no deterioration of the product (degrade) occurs. For 51-mm-(2-in.-) thick lumber containing knots, the increase in property with decreasing moisture content is dependent upon lumber quality. Clear, straight-grained lumber may show increases in properties with decreasing moisture content that approximate those of small, clear specimens. However, as the frequency and size of knots increase, the reduction in strength resulting from the knots begins to negate the increase in property in the clear wood portion of the lumber. Very low quality lumber that has many large knots may be insensitive to changes in moisture content. Figures 5–12 and 5–13 illustrate the effect of moisture content on the proper-

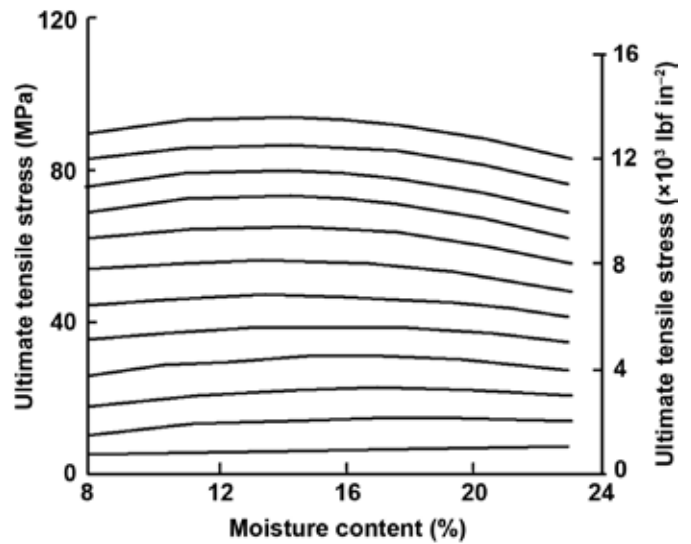

Figure 5–12. Effect of moisture content on tensile strength of lumber parallel to grain.

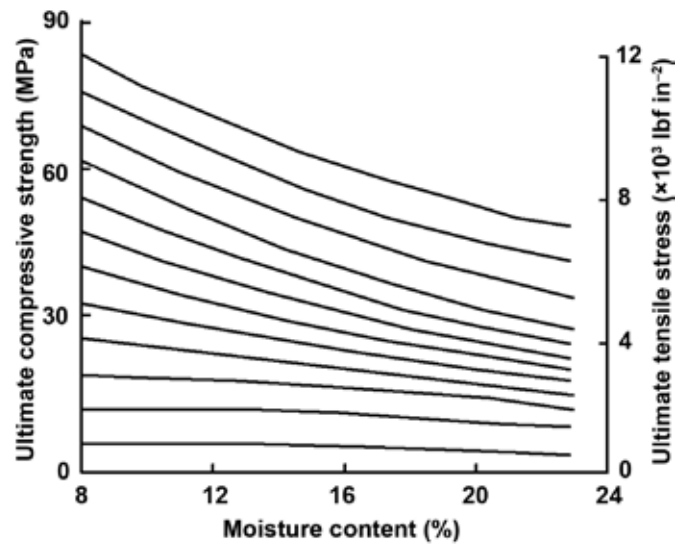

Figure 5–13. Effect of moisture content on compressive strength of lumber parallel to grain.

ties of lumber as a function of initial lumber strength (Green and others 1989). Application of these results in adjusting allowable properties of lumber is discussed in Chapter 7. Additional information on influences of moisture content on dimensional stability is included in Chapter 13.

Temperature

Reversible Effects

In general, the mechanical properties of wood decrease when heated and increase when cooled. At a constant moisture content and below approximately 150 °C (302 °F), mechanical properties are approximately linearly related to temperature. The change in properties that occurs when wood is quickly heated or cooled and then tested at that condition is termed an immediate effect. At temperatures

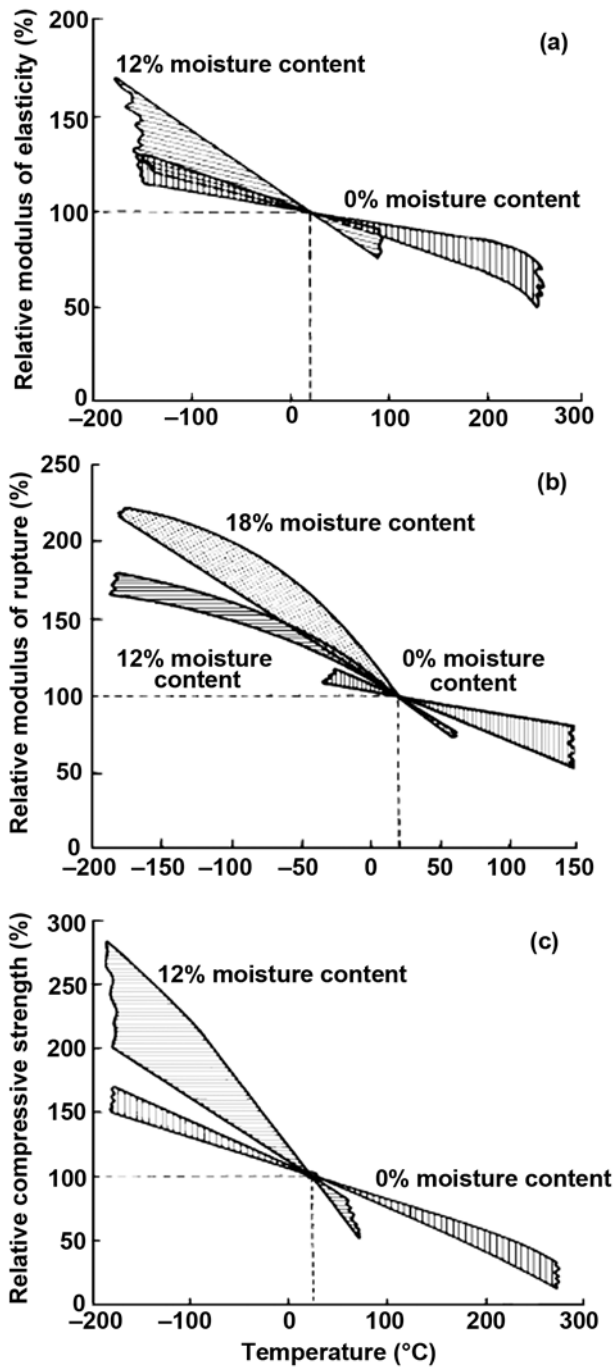

Figure 5–14. Immediate effect of temperature at two moisture content levels relative to value at 20 °C (68 °F) for clear, defect-free wood: (a) modulus of elasticity parallel to grain, (b) modulus of rupture in bending, (c) compressive strength parallel to grain. The plot is a composite of results from several studies. Variability in reported trends is illustrated by width of bands.

Table 5–15. Approximate middle-trend effects of temperature on mechanical properties of clear wood at various moisture conditions

Property	Moisture condition ^a (%)	Relative change in mechanical property from 20 °C (68 °F) at:	
		–50 °C (–58 °F) (%)	+50 °C (+122 °F) (%)
MOE parallel to grain	0	+11	–6
	12	+17	–7
	>FSP	+50	—
MOE perpendicular to grain	6	—	–20
	12	—	–35
	≥20	—	–38
Shear modulus	>FSP	—	–25
Bending strength	≤4	+18	–10
	11–15	+35	–20
	18–20	+60	–25
	>FSP	+110	–25
Tensile strength parallel to grain	0–12	—	–4
Compressive strength parallel to grain	0	+20	–10
	12–45	+50	–25
Shear strength parallel to grain	>FSP	—	–25
Tensile strength perpendicular to grain	4–6	—	–10
	11–16	—	–20
	≥18	—	–30
Compressive strength perpendicular to grain at proportional limit	0–6	—	–20
	≥10	—	–35

^a>FSP indicates moisture content greater than fiber saturation point.

below 100 °C (212 °F), the immediate effect is essentially reversible; that is, the property will return to the value at the original temperature if the temperature change is rapid.

Figure 5–14 illustrates the immediate effect of temperature on modulus of elasticity parallel to grain, modulus of rupture, and compression parallel to grain, 20 °C (68 °F), based on a composite of results for clear, defect-free wood. This figure represents an interpretation of data from several investigators. The width of the bands illustrates variability between and within reported trends.

Table 5–15 lists changes in clear wood properties at –50 °C (–58 °F) and 50 °C (122 °F) relative to those at 20 °C (68 °F) for a number of moisture conditions. The large changes at –50 °C (–58 °F) for green wood (at fiber saturation point or wetter) reflect the presence of ice in the wood cell cavities.

The strength of dry lumber, at about 12% moisture content, may change little as temperature increases from –29 °C (–20 °F) to 38 °C (100 °F). For green lumber, strength generally decreases with increasing temperature. However, for temperatures between about 7 °C (45 °F) and 38 °C (100 °F), the changes may not differ significantly from those at room temperature. Table 5–16 provides equations that

Table 5–16. Percentage change in bending properties of lumber with change in temperature^a

Property	Lumber grade ^b	Moisture content	$((P-P_{70})/P_{70})100 = A + BT + CT^2$			Temperature range	
			A	B	C	T _{min}	T _{max}
MOE	All	Green	22.0350	-0.4578	0	0	32
		Green	13.1215	-0.1793	0	32	150
		12%	7.8553	-0.1108	0	-15	150
MOR	SS	Green	34.13	-0.937	0.0043	-20	46
		Green	0	0	0	46	100
		12%	0	0	0	-20	100
	No. 2 or less	Green	56.89	-1.562	0.0072	-20	46
		Green	0	0	0	46	100
		Dry	0	0	0	-20	100

^aFor equation, *P* is property at temperature *T* in °F; *P*₇₀, property at 21 °C (70 °F).

^bSS is Select Structural.

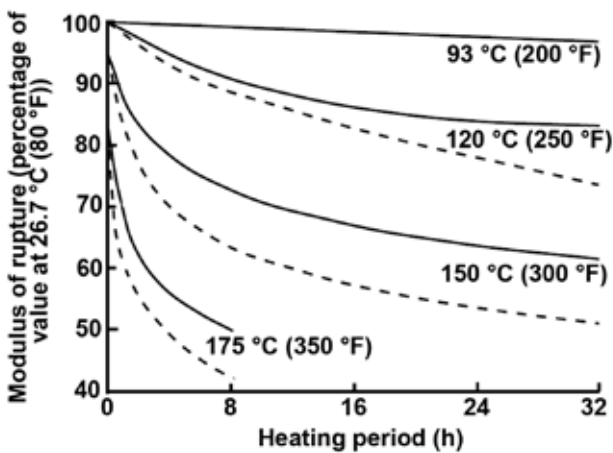

Figure 5–15. Permanent effect of heating in water (solid line) and steam (dashed line) on modulus of rupture of clear, defect-free wood. All data based on tests of Douglas-fir and Sitka spruce at room temperature.

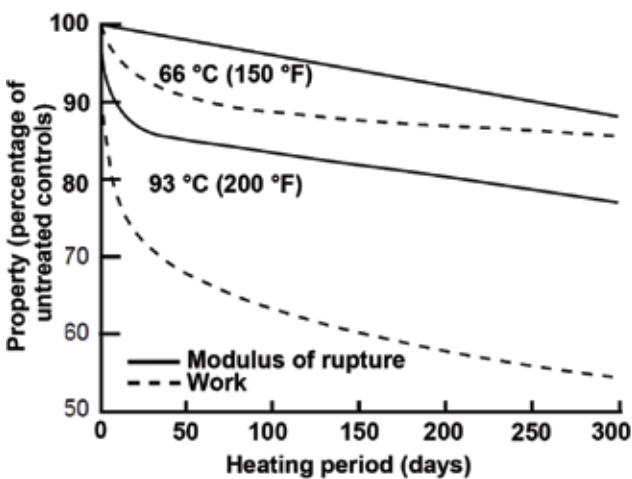

Figure 5–16. Permanent effect of heating in water on work to maximum load and modulus of rupture of clear, defect-free wood. All data based on tests of Douglas-fir and Sitka spruce at room temperature.

have been used to adjust some lumber properties for the reversible effects of temperature.

Irreversible Effects

In addition to the reversible effect of temperature on wood, there is an irreversible effect at elevated temperature. This permanent effect is one of degradation of wood substance, which results in loss of weight and strength. The loss depends on factors that include moisture content, heating medium, temperature, exposure period, and to some extent, species and size of piece involved.

The permanent decrease of modulus of rupture caused by heating in steam and water is shown as a function of temperature and heating time in Figure 5–15, based on tests of clear pieces of Douglas-fir and Sitka spruce. In the same studies, heating in water affected work to maximum load more than modulus of rupture (Fig. 5–16). The effect of heating dry wood (0% moisture content) on modulus of rupture and modulus of elasticity is shown in Figures 5–17 and 5–18, respectively, as derived from tests on four softwoods and two hardwoods.

Figure 5–19 illustrates the permanent loss in bending strength of Spruce–Pine–Fir, Southern Pine, and Douglas-fir standard 38- by 89-mm (nominal 2- by 4-in.) lumber heated at 66 °C (150 °F) and about 12% moisture content. Figure 5–20 illustrates the permanent loss in bending strength of Spruce–Pine–Fir, Southern Pine, Douglas-fir, and yellow-poplar standard 38- by 89-mm (nominal 2- by 4-in.) lumber heated at 82 °C (180 °F) and about 12% moisture content. The curves for Spruce–Pine–Fir heated at 66 °C (150 °F) and about 12% moisture content are included for comparison. The trends in Figure 5–20 can be compared with the trends in 5–19. In general, there is a greater reduction in MOR with time at the higher temperature. During the same time periods shown in Figures 5–19 and 5–20, modulus of elasticity barely changed. Acid hydrolysis of hemicellulose, especially of arabinose, appears to be the fundamental cause of strength loss resulting from thermal

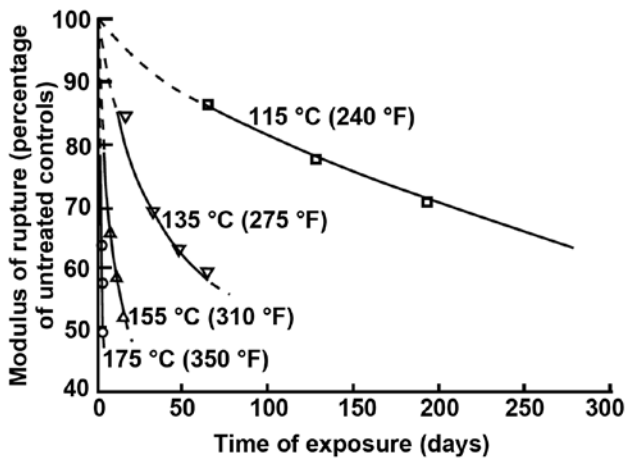

Figure 5–17. Permanent effect of oven heating at four temperatures on modulus of rupture, based on clear pieces of four softwood and two hardwood species. All tests conducted at room temperature.

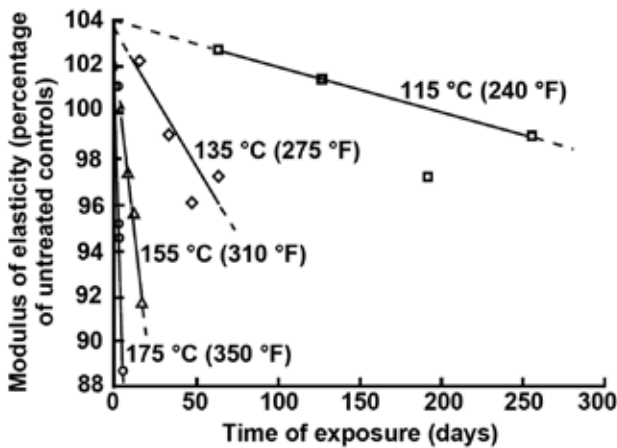

Figure 5–18. Permanent effect of oven heating at four temperatures on modulus of elasticity, based on clear pieces of four softwood and two hardwood species. All tests conducted at room temperature.

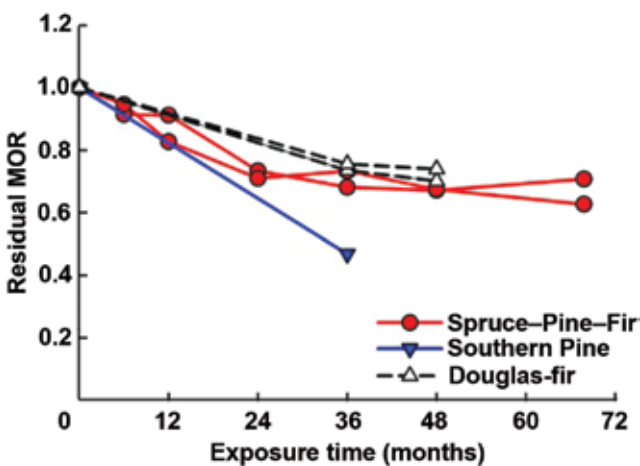

Figure 5–19. Residual MOR for solid-sawn lumber at 66 °C (150 °F) and 75% relative humidity (Green and others 2003).

degradation (Green and others 2005). It should be noted that most in-service exposures at 66 °C (150 °F) or 82 °C (180 °F) would be expected to result in much lower moisture content levels.

The permanent property losses discussed here are based on tests conducted after the specimens were cooled to room temperature and conditioned to a range of 7% to 12% moisture content. If specimens are tested hot, the percentage of strength reduction resulting from permanent effects is based on values already reduced by the immediate effects. Repeated exposure to elevated temperature has a cumulative effect on wood properties. For example, at a given temperature the property loss will be about the same after six 1-month exposures as it would be after a single 6-month exposure.

The shape and size of wood pieces are important in analyzing the influence of temperature. If exposure is for only a short time, so that the inner parts of a large piece do not reach the temperature of the surrounding medium, the immediate effect on strength of the inner parts will be less than that for the outer parts. However, the type of loading must be considered. If the member is to be stressed in bending, the outer fibers of a piece will be subjected to the greatest stress and will ordinarily govern the ultimate strength of the piece; hence, under this loading condition, the fact that the inner part is at a lower temperature may be of little significance.

For extended noncyclic exposures, it can be assumed that the entire piece reaches the temperature of the heating medium and will therefore be subject to permanent strength losses throughout the volume of the piece, regardless of size and mode of stress application. However, in ordinary construction wood often will not reach the daily temperature extremes of the air around it; thus, long-term effects should be based on the accumulated temperature experience of critical structural parts.

Time Under Load

Rate of Loading

Mechanical property values, as given in Tables 5–3 to 5–5, are usually referred to as static strength values. Static strength tests are typically conducted at a rate of loading or rate of deformation to attain maximum load in about 5 min. Higher values of strength are obtained for wood loaded at a more rapid rate, and lower values are obtained at slower rates. For example, the load required to produce failure in a wood member in 1 s is approximately 10% higher than that obtained in a standard static strength test. Over several orders of magnitude of rate of loading, strength is approximately an exponential function of rate. See Chapter 7 for application to treated woods.

Figure 5–21 illustrates how strength decreases with time to maximum load. The variability in the trend shown is based on results from several studies pertaining to bending, compression, and shear.

Creep and Relaxation

When initially loaded, a wood member deforms elastically. If the load is maintained, additional time-dependent deformation occurs. This is called creep. Creep occurs at even very low stresses, and it will continue over a period of years. For sufficiently high stresses, failure eventually occurs. This failure phenomenon, called duration of load (or creep rupture), is discussed in the next section.

At typical design levels and use environments, after several years the additional deformation caused by creep may approximately equal the initial, instantaneous elastic deformation. For illustration, a creep curve based on creep as a function of initial deflection (relative creep) at several stress levels is shown in Figure 5–22; creep is greater under higher stresses than under lower ones.

Ordinary climatic variations in temperature and humidity will cause creep to increase. An increase of about 28 °C (50 °F) in temperature can cause a two- to threefold increase in creep. Green wood may creep four to six times the initial deformation as it dries under load.

Unloading a member results in immediate and complete recovery of the original elastic deformation and after time, a recovery of approximately one-half the creep at deformation as well. Fluctuations in temperature and humidity increase the magnitude of the recovered deformation.

Relative creep at low stress levels is similar in bending, tension, or compression parallel to grain, although it may be somewhat less in tension than in bending or compression under varying moisture conditions. Relative creep across the grain is qualitatively similar to, but likely to be greater than, creep parallel to the grain. The creep behavior of all species studied is approximately the same.

If instead of controlling load or stress, a constant deformation is imposed and maintained on a wood member, the initial stress relaxes at a decreasing rate to about 60% to 70% of its original value within a few months. This reduction of stress with time is commonly called relaxation. In limited bending tests carried out between approximately 18 °C (64 °F) and 49 °C (120 °F) over 2 to 3 months, the curve of stress as a function of time that expresses relaxation is approximately the mirror image of the creep curve (deformation as a function of time). These tests were carried out at initial stresses up to about 50% of the bending strength of the wood. As with creep, relaxation is markedly affected by fluctuations in temperature and humidity.

Duration of Load

The duration of load, or the time during which a load acts on a wood member either continuously or intermittently, is an important factor in determining the load that the member can safely carry. The duration of load may be affected by changes in temperature and relative humidity. The constant stress that a wood member can sustain is approximately an

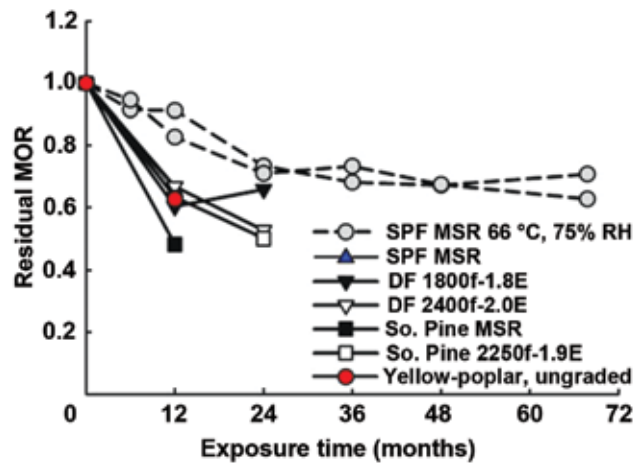

Figure 5–20. Residual MOR for solid-sawn lumber at 82 °C (180 °F) and 80% relative humidity (RH); SPF at 66 °C (150 °F) and 75% RH shown for comparison. SPF is Spruce–Pine–Fir; MSR, machine stress rated; DF, Douglas-fir; and So. pine, Southern Pine (Green and others 2005).

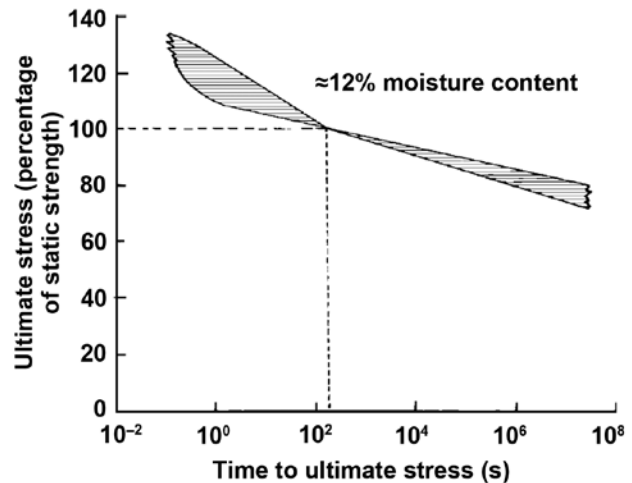

Figure 5–21. Relationship of ultimate stress at short-time loading to that at 5-min loading, based on composite of results from rate-of-load studies on bending, compression, and shear parallel to grain. Variability in reported trends is indicated by width of band.

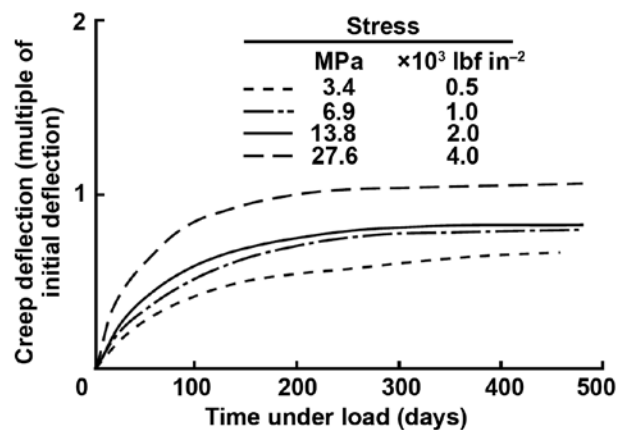

Figure 5–22. Influence of four levels of stress on creep (Kingston 1962).

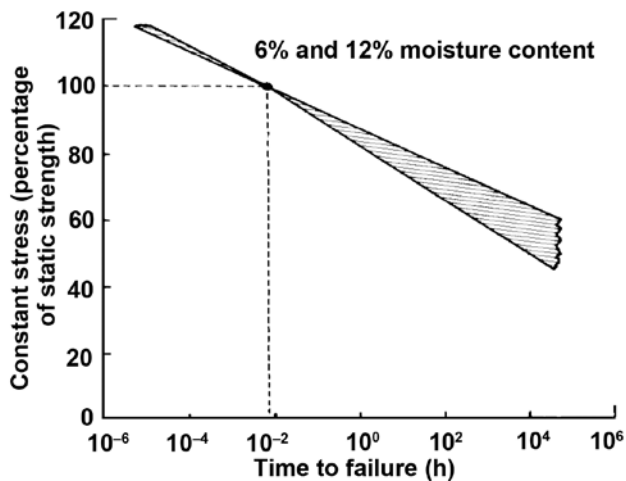

Figure 5–23. Relationship between stress due to constant load and time to failure for small clear wood specimens, based on 28 s at 100% stress. The figure is a composite of trends from several studies; most studies involved bending but some involved compression parallel to grain and bending perpendicular to grain. Variability in reported trends is indicated by width of band.

exponential function of time to failure, as illustrated in Figure 5–22. This relationship is a composite of results of studies on small, clear wood specimens, conducted at constant temperature and relative humidity.

For a member that continuously carries a load for a long period, the load required to produce failure is much less than that determined from the strength properties in Tables 5–3 to 5–5. Based on Figure 5–23, a wood member under the continuous action of bending stress for 10 years may carry only 60% (or perhaps less) of the load required to produce failure in the same specimen loaded in a standard bending strength test of only a few minutes duration. Conversely, if the duration of load is very short, the load-carrying capacity may be higher than that determined from strength properties given in the tables.

Time under intermittent loading has a cumulative effect. In tests where a constant load was periodically placed on a beam and then removed, the cumulative time the load was actually applied to the beam before failure was essentially equal to the time to failure for a similar beam under the same load applied continuously.

The time to failure under continuous or intermittent loading is looked upon as a creep–rupture process; a member has to undergo substantial deformation before failure. Deformation at failure is approximately the same for duration of load tests as for standard strength tests.

Changes in climatic conditions increase the rate of creep and shorten the duration during which a member can support a given load. This effect can be substantial for very small wood specimens under large cyclic changes in temperature

and relative humidity. Fortunately, changes in temperature and relative humidity are moderate for wood in the typical service environment.

Fatigue

In engineering, the term fatigue is defined as the progressive damage that occurs in a material subjected to cyclic loading. This loading may be repeated (stresses of the same sign; that is, always compression or always tension) or reversed (stresses of alternating compression and tension). When sufficiently high and repetitious, cyclic loading stresses can result in fatigue failure.

Fatigue life is a term used to define the number of cycles that are sustained before failure. Fatigue strength, the maximum stress attained in the stress cycle used to determine fatigue life, is approximately exponentially related to fatigue life; that is, fatigue strength decreases approximately linearly as the logarithm of number of cycles increases. Fatigue strength and fatigue life also depend on several other factors: frequency of cycling; repetition or reversal of loading; range factor (ratio of minimum to maximum stress per cycle); and other factors such as temperature, moisture content, and specimen size. Negative range factors imply repeated reversing loads, whereas positive range factors imply nonreversing loads.

Results from several fatigue studies on wood are given in Table 5–17. Most of these results are for repeated loading with a range ratio of 0.1, meaning that the minimum stress per cycle is 10% of the maximum stress. The maximum stress per cycle, expressed as a percentage of estimated static strength, is associated with the fatigue life given in millions of cycles. The first three lines of data, which list the same cyclic frequency (30 Hz), demonstrate the effect of range ratio on fatigue strength (maximum fatigue stress that can be maintained for a given fatigue life); fatigue bending strength decreases as range ratio decreases. Third-point bending results show the effect of small knots or slope of grain on fatigue strength at a range ratio of 0.1 and frequency of 8.33 Hz. Fatigue strength is lower for wood containing small knots or a 1-in-12 slope of grain than for clear straight-grained wood and even lower for wood containing a combination of small knots and a 1-in-12 slope of grain. Fatigue strength is the same for a scarf joint in tension as for tension parallel to the grain, but a little lower for a finger joint in tension. Fatigue strength is slightly lower in shear than in tension parallel to the grain. Other comparisons do not have much meaning because range ratios or cyclic frequency differ; however, fatigue strength is high in compression parallel to the grain compared with other properties. Little is known about other factors that may affect fatigue strength in wood.

Creep, temperature rise, and loss of moisture content occur in tests of wood for fatigue strength. At stresses that cause

Table 5–17. Summary of reported results on cyclic fatigue^a

Property	Range ratio	Cyclic frequency (Hz)	Maximum stress per cycle ^b (%)	Approximate fatigue life ($\times 10^6$ cycles)
Bending, clear, straight grain				
Cantilever	0.45	30	45	30
Cantilever	0	30	40	30
Cantilever	-1.0	30	30	30
Center-point	-1.0	40	30	4
Rotational	-1.0	—	28	30
Third-point	0.1	8-1/3	60	2
Bending, third-point				
Small knots	0.1	8-1/3	50	2
Clear, 1:12 slope of grain	0.1	8-1/3	50	2
Small knots, 1:12 slope of grain	0.1	8-1/3	40	2
Tension parallel to grain				
Clear, straight grain	0.1	15	50	30
Clear, straight grain	0	40	60	3.5
Scarf joint	0.1	15	50	30
Finger joint	0.1	15	40	30
Compression parallel to grain				
Clear, straight grain	0.1	40	75	3.5
Shear parallel to grain				
Glued-laminated	0.1	15	45	30

^aInitial moisture content about 12% to 15%.

^bPercentage of estimated static strength.

failure in about 106 cycles at 40 Hz, a temperature rise of 15 °C (27 °F) has been reported for parallel-to-grain compression fatigue (range ratio slightly greater than zero), parallel-to-grain tension fatigue (range ratio = 0), and reversed bending fatigue (range ratio = -1). The rate of temperature rise is high initially but then diminishes to moderate; a moderate rate of temperature rise remains more or less constant during a large percentage of fatigue life. During the latter stages of fatigue life, the rate of temperature rise increases until failure occurs. Smaller rises in temperature would be expected for slower cyclic loading or lower stresses. Decreases in moisture content are probably related to temperature rise.

Aging

In relatively dry and moderate temperature conditions where wood is protected from deteriorating influences such as decay, the mechanical properties of wood show little change with time. Test results for very old timbers suggest that significant losses in clear wood strength occur only after several centuries of normal aging conditions. The soundness

of centuries-old wood in some standing trees (redwood, for example) also attests to the durability of wood.

Exposure to Chemicals

The effect of chemical solutions on mechanical properties depends on the specific type of chemical. Nonswelling liquids, such as petroleum oils and creosote, have no appreciable effect on properties. Properties are lowered in the presence of water, alcohol, or other wood-swelling organic liquids even though these liquids do not chemically degrade the wood substance. The loss in properties depends largely on the amount of swelling, and this loss is regained upon removal of the swelling liquid. Anhydrous ammonia markedly reduces the strength and stiffness of wood, but these properties are regained to a great extent when the ammonia is removed. Heartwood generally is less affected than sapwood because it is more impermeable. Accordingly, wood treatments that retard liquid penetration usually enhance natural resistance to chemicals.

Chemical solutions that decompose wood substance (by hydrolysis or oxidation) have a permanent effect on strength. The following generalizations summarize the effect of chemicals:

- Some species are quite resistant to attack by dilute mineral and organic acids.
- Oxidizing acids such as nitric acid degrade wood more than do nonoxidizing acids.
- Alkaline solutions are more destructive than are acidic solutions.
- Hardwoods are more susceptible to attack by both acids and alkalis than are softwoods.
- Heartwood is less susceptible to attack by both acids and alkalis than is sapwood.

Because both species and application are extremely important, reference to industrial sources with a specific history of use is recommended where possible. For example, large cypress tanks have survived long continuous use where exposure conditions involved mixed acids at the boiling point. Wood is also used extensively in cooling towers because of its superior resistance to mild acids and solutions of acidic salts.

Chemical Treatment

Wood is often treated with chemicals to enhance its fire performance or decay resistance in service. Each set of treatment chemicals and processes has a unique effect on the mechanical properties of the treated wood.

Fire-retardant treatments and treatment methods distinctly reduce the mechanical properties of wood. Some fire-retardant-treated products have experienced significant in-service degradation on exposure to elevated temperatures when used as plywood roof sheathing or roof-truss lumber. New performance requirements within standards set by ASTM

International (formerly the American Society for Testing and Materials) and American Wood Protection Association (AWPA) preclude commercialization of inadequately performing fire-retardant-treated products.

Although preservative treatments and treatment methods generally reduce the mechanical properties of wood, any initial loss in strength from treatment must be balanced against the progressive loss of strength from decay when untreated wood is placed in wet conditions. The effects of preservative treatments on mechanical properties are directly related to wood quality, size, and various pretreatment, treatment, and post-treatment processing factors. The key factors include preservative chemistry or chemical type, preservative retention, initial kiln-drying temperature, post-treatment drying temperature, and pretreatment incising (if required). North American design guidelines address the effects of incising on mechanical properties of refractory wood species and the short-term duration-of-load adjustments for all treated lumber. These guidelines are described in Chapter 7.

Oil-Type Preservatives

Oil-type preservatives cause no appreciable strength loss because they do not chemically react with wood cell wall components. However, treatment with oil-type preservatives can adversely affect strength if extreme in-retort seasoning parameters are used (for example, Boultonizing, steaming, or vapor drying conditions) or if excessive temperatures or pressures are used during the treating process. To preclude strength loss, the user should follow specific treatment processing requirements as described in the treatment standards.

Waterborne Preservatives

Waterborne preservative treatments can reduce the mechanical properties of wood. Treatment standards include specific processing requirements intended to prevent or limit strength reductions resulting from the chemicals and the waterborne preservative treatment process. The effects of waterborne preservative treatment on mechanical properties are related to species, mechanical properties, preservative chemistry or type, preservative retention, post-treatment drying temperature, size and grade of material, product type, initial kiln-drying temperature, incising, and both temperature and moisture in service.

Species—The magnitude of the effect of various waterborne preservatives on mechanical properties does not appear to vary greatly between different species.

Mechanical property—Waterborne preservatives affect each mechanical property differently. If treated according to AWPA standards, the effects are as follows: modulus of elasticity (MOE), compressive strength parallel to grain, and compressive stress perpendicular to grain are unaffected or slightly increased; modulus of rupture (MOR) and ten-

sile strength parallel to grain are reduced from 0% to 20%, depending on chemical retention and severity of redrying temperature; and energy-related properties (for example, work to maximum load and impact strength) are reduced from 10% to 50%.

Preservative chemistry or type—Waterborne preservative chemical systems differ in regard to their effect on strength, but the magnitude of these differences is slight compared with the effects of treatment processing factors. Chemistry-related differences seem to be related to the reactivity of the waterborne preservative and the temperature during the fixation/precipitation reaction with wood.

Retention—Waterborne preservative retention levels of $\leq 16 \text{ kg m}^{-3}$ ($\leq 1.0 \text{ lb ft}^{-3}$) have no effect on MOE or compressive strength parallel to grain and a slight negative effect (-5% to -10%) on tensile or bending strength. However, energy-related properties are often reduced from 15% to 30%. At a retention level of 40 kg m^{-3} (2.5 lb ft^{-3}), MOR and energy-related properties are further reduced.

Post-treatment drying temperature—Air drying after treatment causes no significant reduction in the static strength of wood treated with waterborne preservative at a retention level of 16 kg m^{-3} (1.0 lb ft^{-3}). However, energy-related properties are reduced. The post-treatment redrying temperature used for material treated with waterborne preservative has been found to be critical when temperatures exceed $75 \text{ }^\circ\text{C}$ ($167 \text{ }^\circ\text{F}$). Redrying limitations in treatment standards have precluded the need for an across-the-board design adjustment factor for waterborne-preservative-treated lumber in engineering design standards. The limitation on post-treatment kiln-drying temperature is set at $74 \text{ }^\circ\text{C}$ ($165 \text{ }^\circ\text{F}$).

Size of material—Generally, larger material, specifically thicker, appears to undergo less reduction in strength than does smaller material. Recalling that preservative treatments usually penetrate the treated material to a depth of only 6 to 51 mm (0.25 to 2.0 in.), depending on species and other factors, the difference in size effect appears to be a function of the product's surface-to-volume ratio, which affects the relative ratio of treatment-induced weight gain to original wood weight.

Grade of material—The effect of waterborne preservative treatment is a quality-dependent phenomenon. Higher grades of wood are more affected than lower grades. When viewed over a range of quality levels, higher quality lumber is reduced in strength to a proportionately greater extent than is lower quality lumber.

Product type—The magnitude of the treatment effect on strength for laminated veneer lumber conforms closely to effects noted for higher grades of solid-sawn lumber. The effects of waterborne preservative treatment on plywood seem comparable to that on lumber. Fiber-based composite

products may be reduced in strength to a greater extent than is lumber. This additional effect on fiber-based composites may be more a function of internal bond damage caused by waterborne-treatment-induced swelling rather than actual chemical hydrolysis.

Initial kiln-drying temperature—Although initial kiln drying of some lumber species at 100 to 116 °C (212 to 240 °F) for short durations has little effect on structural properties, such drying results in more hydrolytic degradation of the cell wall than does drying at lower temperature kiln schedules. Subsequent preservative treatment and re-drying of material initially dried at high temperatures cause additional hydrolytic degradation. When the material is subsequently treated, initial kiln drying at 113 °C (235 °F) has been shown to result in greater reductions over the entire bending and tensile strength distributions than does initial kiln drying at 91 °C (196 °F). Because Southern Pine lumber, the most widely treated product, is most often initially kiln dried at dry-bulb temperatures near or above 113 °C (235 °F), treatment standards have imposed a maximum redrying temperature limit of 74 °C (165 °F) to preclude the cumulative effect of thermal processing.

Incising—Incising, a pretreatment mechanical process in which small slits (incisions) are punched in the surface of the wood product, is used to improve preservative penetration and distribution in difficult-to-treat species. Incising may reduce strength; however, because the increase in treatability provides a substantial increase in biological performance, this strength loss must be balanced against the progressive loss in strength of untreated wood from the incidence of decay. Most incising patterns induce some strength loss, and the magnitude of this effect is related to the size of material being incised and the incision depth and density (that is, number of incisions per unit area). In <50-mm- (<2-in.-) thick, dry lumber, incising and preservative treatment induces losses in MOE of 5% to 15% and in static strength properties of 20% to 30%. Incising and treating timbers or tie stock at an incision density of $\leq 1,500$ incisions m^{-2} (≤ 140 incisions ft^{-2}) and to a depth of 19 mm (0.75 in.) reduces strength by 5% to 10%.

In-service temperature—Both fire-retardant and preservative treatments accelerate the thermal degradation of bending strength of lumber when exposed to temperatures above 54 °C (130 °F).

In-service moisture content—Current design values apply to material dried to $\leq 19\%$ maximum (15% average) moisture content or to green material. No differences in strength have been found between treated and untreated material when tested green or at moisture contents above 12%. When very dry treated lumber of high grade was tested at 10% moisture content, its bending strength was reduced compared with that of matched dry untreated lumber.

Duration of load—When subjected to impact loads, wood treated with chromated copper arsenate (CCA) does not

exhibit the same increase in strength as that exhibited by untreated wood. However, when loaded over a long period, treated and untreated wood behave similarly.

Polymerization

Wood is also sometimes impregnated with monomers, such as methyl methacrylate, which are subsequently polymerized. Many of the mechanical properties of the resultant wood-plastic composite are greater than those of the original wood, generally as a result of filling the void spaces in the wood structure with plastic. The polymerization process and both the chemical nature and quantity of monomers influence composite properties.

Nuclear Radiation

Wood is occasionally subjected to nuclear radiation. Examples are wooden structures closely associated with nuclear reactors, the polymerization of wood with plastic using nuclear radiation, and nondestructive estimation of wood density and moisture content. Very large doses of gamma rays or neutrons can cause substantial degradation of wood. In general, irradiation with gamma rays in doses up to about 10 kGy has little effect on the strength properties of wood. As dosage exceeds 10 kGy, tensile strength parallel to grain and toughness decrease. At a dosage of 3 MGy, tensile strength is reduced about 90%. Gamma rays also affect compressive strength parallel to grain at a dosage above 10 kGy, but higher dosage has a greater effect on tensile strength than on compressive strength; only approximately one-third of compressive strength is lost when the total dose is 3 MGy. Effects of gamma rays on bending and shear strength are intermediate between the effects on tensile and compressive strength.

Mold and Stain Fungi

Mold and stain fungi do not seriously affect most mechanical properties of wood because such fungi feed on substances within the cell cavity or attached to the cell wall rather than on the structural wall itself. The duration of infection and the species of fungi involved are important factors in determining the extent of degradation.

Although low levels of biological stain cause little loss in strength, heavy staining may reduce specific gravity by 1% to 2%, surface hardness by 2% to 10%, bending and crushing strength by 1% to 5%, and toughness or shock resistance by 15% to 30%. Although molds and stains usually do not have a major effect on strength, conditions that favor these organisms also promote the development of wood-destroying (decay) fungi and soft-rot fungi (Chap. 14). Pieces with mold and stain should be examined closely for decay if they are used for structural purposes.

Decay

Unlike mold and stain fungi, wood-destroying (decay) fungi seriously reduce strength by metabolizing the cellulose fraction of wood that gives wood its strength.

Early stages of decay are virtually impossible to detect. For example, brown-rot fungi may reduce mechanical properties in excess of 10% before a measurable weight loss is observed and before decay is visible. When weight loss reaches 5% to 10%, mechanical properties are reduced from 20% to 80%. Decay has the greatest effect on toughness, impact bending, and work to maximum load in bending, the least effect on shear and hardness, and an intermediate effect on other properties. Thus, when strength is important, adequate measures should be taken to (a) prevent decay before it occurs, (b) control incipient decay by remedial measures (Chap. 14), or (c) replace any wood member in which decay is evident or believed to exist in a critical section. Decay can be prevented from starting or progressing if wood is kept dry (below 20% moisture content).

No method is known for estimating the amount of reduction in strength from the appearance of decayed wood. Therefore, when strength is an important consideration, the safe procedure is to discard every piece that contains even a small amount of decay. An exception may be pieces in which decay occurs in a knot but does not extend into the surrounding wood.

Insect Damage

Insect damage may occur in standing trees, logs, and undried (unseasoned) or dried (seasoned) lumber. Although damage is difficult to control in the standing tree, insect damage can be eliminated to a great extent by proper control methods. Insect holes are generally classified as pinholes, grub holes, and powderpost holes. Because of their irregular burrows, powderpost larvae may destroy most of a piece's interior while only small holes appear on the surface, and the strength of the piece may be reduced virtually to zero. No method is known for estimating the reduction in strength from the appearance of insect-damaged wood. When strength is an important consideration, the safe procedure is to eliminate pieces containing insect holes.

Literature Cited

Bendtsen, B.A.; Ethington, R.L. 1975. Mechanical properties of 23 species of eastern hardwoods. Res. Note FPL–RN–0230. Madison, WI: U.S. Department of Agriculture, Forest Service, Forest Products Laboratory. 12 p.

Bodig, J.; Jayne, B.A. 1982. Mechanics of wood and wood composites. New York: Van Nostrand Reinhold Company.

Green, D.W.; Evans, J.W.; Craig, B.A. 2003. Durability of structural lumber products at high temperatures I: 66°C at 75% RH and 82°C at 30% RH. *Wood and Fiber Science*. 35(4): 499–523.

Green, D.W.; Evans, J.W.; Hatfield, C.A.; Byrd, P.J. 2005. Durability of structural lumber products after exposure at 82°C and 80% relative humidity. Res. Pap. FPL–RP–631. Madison, WI: U.S. Department of Agriculture, Forest Service, Forest Products Laboratory. 21 p.

Green, D.W.; Shelley, B.E.; Vokey, H.P., eds. 1989. In-grade testing of structural lumber. Proceedings 47363. Madison, WI: Forest Products Society.

Kingston, R.S.T. 1962. Creep, relaxation, and failure of wood. *Research Applied in Industry*. 15(4).

Kretschmann, D.E. 2008. The influence of juvenile wood content on shear parallel, compression and tension perpendicular to grain strength and mode I fracture toughness of loblolly pine at various ring orientations. *Forest Products Journal*. 58(7/8): 89–96.

Kretschmann, D.E.; Green, D.W. 1996. Modeling moisture content–mechanical property relationships for clear Southern Pine. *Wood and Fiber Science*. 28(3): 320–337.

Kretschmann, D.E.; Green, D.W. 2008. Strength properties of low moisture content yellow-poplar. In: Proceedings, world conference timber engineering; 2008 June 2–5; Miyazaki, Japan: WCTE. 8p.

Moon, R.J.; Frihart, C.R.; Wegner, T. 2006. Nanotechnology applications in the forest products industry. *Forest Products Journal*. (56)5: 4–10.

Additional References

ASTM. [Current edition]. Standard methods for testing small clear specimens of timber. ASTM D143–94. West Conshohocken, PA: American Society for Testing and Materials.

Bendtsen, B.A. 1976. Rolling shear characteristics of nine structural softwoods. *Forest Products Journal*. 26(11): 51–56.

Bendtsen, B.A.; Freese, F.; Ethington, R.L. 1970. Methods for sampling clear, straight-grained wood from the forest. *Forest Products Journal*. 20(11): 38–47.

Bodig, J.; Goodman, J.R. 1973. Prediction of elastic parameters for wood. *Wood Science*. 5(4): 249–264.

Boller, K.H. 1954. Wood at low temperatures. *Modern Packaging*. 28(1): 153–157.

Chudnoff, M. 1984. Tropical timbers of the world. *Agriculture Handbook 607*. Madison, WI: U.S. Department of Agriculture, Forest Service, Forest Products Laboratory. 464 p.

Coffey, D.J. 1962. Effects of knots and holes on the fatigue strength of quarter-scale timber bridge stringers. Madison, WI: University of Wisconsin, Department of Civil Engineering. M.S. thesis.

Gerhards, C.C. 1968. Effects of type of testing equipment and specimen size on toughness of wood. Res. Pap. FPL–RP–97. Madison, WI: U.S. Department of Agriculture, Forest Service, Forest Products Laboratory. 12 p.

Gerhards, C.C. 1977. Effect of duration and rate of loading on strength of wood and wood based materials. Res. Pap.

Chapter 5 Mechanical Properties of Wood

- FPL–RP–283. Madison, WI: U.S. Department of Agriculture, Forest Service, Forest Products Laboratory. 24 p.
- Gerhards, C.C. 1979. Effect of high-temperature drying on tensile strength of Douglas-fir 2 by 4s. *Forest Products Journal*. 29(3): 39–46.
- Gerhards, C.C. 1982. Effect of moisture content and temperature on the mechanical properties of wood: an analysis of immediate effects. *Wood and Fiber*. 14(1): 4–36.
- Green, D.W.; Evans, J.W. 1994. Effect of ambient temperatures on the flexural properties of lumber. In: PTEC 94 timber shaping the future: Proceedings, Pacific timber engineering conference; 1994 July 11–15; Gold Coast, Australia. Fortitude Valley MAC, Queensland, Australia: Timber Research Development and Advisory Council: 190–197. Vol. 2.
- Green, D.W.; Evans, J.W.; Logan, J.D.; Nelson, W.J. 1999. Adjusting modulus of elasticity of lumber for changes in temperature. Madison, WI: Forest Products Society. *Forest Products Journal*. 49(10): 82–94.
- Green, D.W.; Rosales, A. 1996. Property relationships for tropical hardwoods. In: Proceedings, international wood engineering conference; 1996 October 21–31; New Orleans, LA. Madison, WI: Forest Products Society: 3-516–3-521.
- Hearmon, R.F.S. 1948. The elasticity of wood and plywood. Special Rep. 7. London, England: Department of Scientific and Industrial Research, Forest Products Research.
- Hearmon, R.F.S. 1961. An introduction to applied anisotropic elasticity. London, England: Oxford University Press.
- Kollmann, F.F.P.; Cote, W.A., Jr. 1968. Principles of wood science and technology. New York: Springer-Verlag.
- Koslik, C.J. 1967. Effect of kiln conditions on the strength of Douglas-fir and western hemlock. Rep. D–9. Corvallis, OR: Oregon State University, School of Forestry, Forestry Research Laboratory.
- Kretschmann, D.E.; Bendtsen, B.A. 1992. Ultimate tensile stress and modulus of elasticity of fast-grown plantation loblolly pine lumber. *Wood and Fiber Science*. 24(2): 189–203.
- Kretschmann, D.E.; Green, D.W.; Malinauskas, V. 1991. Effect of moisture content on stress intensity factors in Southern Pine. In: Proceedings, 1991 international timber engineering conference; 1991 September 2–5; London. London: TRADA: 3.391–3.398. Vol. 3.
- LeVan, S.L.; Winandy, J.E. 1990. Effects of fire-retardant treatments on wood strength: a review. *Wood and Fiber Science*. 22(1): 113–131.
- Little, E.L., Jr. 1979. Checklist of United States trees (native and naturalized). *Agric. Handb.* 541. Washington, DC: U.S. Department of Agriculture. 375 p.
- MacLean, J.D. 1953. Effect of steaming on the strength of wood. *American Wood-Preservers' Association*. 49: 88–112.
- MacLean, J.D. 1954. Effect of heating in water on the strength properties of wood. *American Wood-Preservers' Association*. 50: 253–281.
- Mallory, M.P.; Cramer, S. 1987. Fracture mechanics: a tool for predicting wood component strength. *Forest Products Journal*. 37(7/8): 39–47.
- Mark, R.E.; Adams, S.F.; Tang, R.C. 1970. Moduli of rigidity of Virginia pine and tulip poplar related to moisture content. *Wood Science*. 2(4): 203–211.
- McDonald, K.A.; Bendtsen, B.A. 1986. Measuring localized slope of grain by electrical capacitance. *Forest Products Journal*. 36(10): 75–78.
- McDonald, K.A.; Hennon, P.E.; Stevens, J.H.; Green, D.W. 1997. Mechanical properties of salvaged yellow-cedar in southeastern Alaska—Phase I. Res. Pap. FPL–RP–565. Madison, WI: U.S. Department of Agriculture, Forest Service, Forest Products Laboratory.
- Millett, M.A.; Gerhards, C.C. 1972. Accelerated aging: residual weight and flexural properties of wood heated in air at 115°C to 175°C. *Wood Science*. 4(4): 193–201.
- Nicholas, D.D. 1973. Wood deterioration and its prevention by preservative treatments. In: *Degradation and Protection of Wood*. Syracuse, NY: Syracuse University Press. Vol. I.
- Pillow, M.Y. 1949. Studies of compression failures and their detection in ladder rails. Rep. D 1733. Madison, WI: U.S. Department of Agriculture, Forest Service, Forest Products Laboratory.
- Sliker, A.; Yu, Y. 1993. Elastic constants for hardwoods measured from plate and tension tests. *Wood and Fiber Science*. 25(1): 8–22.
- Sliker, A.; Yu, Y.; Weigel, T.; Zhang, W. 1994. Orthotropic elastic constants for eastern hardwood species. *Wood and Fiber Science*. 26(1): 107–121.
- Soltis, L.A.; Winandy, J.E. 1989. Long-term strength of CCA-treated lumber. *Forest Products Journal*. 39(5): 64–68.
- Timell, T.E. 1986. Compression wood in gymnosperms. Vol. I–III. Berlin: Springer-Verlag.
- U.S. Department of Defense. 1951. Design of wood aircraft structures. ANC–18 Bull. Subcommittee on Air Force–Navy Civil Aircraft, Design Criteria Aircraft Commission. 2nd ed. Munitions Board Aircraft Committee.
- Wangaard, F.F. 1966. Resistance of wood to chemical degradation. *Forest Products Journal*. 16(2): 53–64.
- Wilcox, W.W. 1978. Review of literature on the effects of early stages of decay on wood strength. *Wood and Fiber Science*. 9(4): 252–257.

- Wilson, T.R.C. 1921. The effect of spiral grain on the strength of wood. *Journal of Forestry*. 19(7): 740–747.
- Wilson, T.R.C. 1932. Strength-moisture relations for wood. *Tech. Bull.* 282. Washington, DC: U.S. Department of Agriculture.
- Winandy, J.E. 1994. Effects of long-term elevated temperature on CCA-treated Southern Pine lumber. *Forest Products Journal*. 44(6): 49–55.
- Winandy, J.E. 1995a. Effects of waterborne preservative treatment on mechanical properties: a review. In: *Proceedings, 91st annual meeting of American Wood Preservers' Association*; 1995, May 21–24; New York, NY. Woodstock, MD: American Wood Preservers' Association. 91: 17–33.
- Winandy, J.E. 1995b. The influence of time to failure on the strength of CCA treated lumber. *Forest Products Journal*. 45(2): 82–85.
- Winandy, J.E. 1995c. Effects of moisture content on strength of CCA-treated lumber. *Wood and Fiber Science*. 27(2): 168–177.
- Winandy, J.E.; Morrell, J.J. 1993. Relationship between incipient decay, strength, and chemical composition of Douglas-fir heartwood. *Wood and Fiber Science*. 25(3): 278–288.
- Woodfin, R.O.; Estep, E.M., eds. 1978. In: *The dead timber resource. Proceedings, 1978 May 22–24, Spokane, WA*. Pullman, WA: Engineering Extension Service, Washington State University.

Commercial Lumber, Round Timbers, and Ties

David E. Kretschmann, Research General Engineer

Contents

Hardwood Lumber 6–2
Factory Lumber 6–2
Dimension and Component Parts 6–4
Finished Market Products 6–4
Lumber Species 6–6
Softwood Lumber 6–6
Lumber Grades 6–7
Lumber Manufacture 6–10
Softwood Lumber Species 6–11
Softwood Lumber Grading 6–12
Purchase of Lumber 6–12
Retail Yard Inventory 6–12
Important Purchase Considerations 6–17
Round Timbers and Ties 6–18
Standards and Specifications 6–18
Material Requirements 6–18
Availability 6–19
Form 6–20
Weight and Volume 6–21
Durability 6–22
Preservative Treatment 6–22
Service Life 6–22
Commonly Used Lumber, Round Timber, and Tie Abbreviations 6–23
References 6–25

When sawn, a log yields round timber, ties, or lumber of varying quality. This chapter presents a general discussion of grading, standards, and specifications for these commercial products.

In a broad sense, commercial lumber is any lumber that is bought or sold in the normal channels of commerce. Commercial lumber may be found in a variety of forms, species, and types, and in various commercial establishments, both wholesale and retail. Most commercial lumber is graded by standardized rules that make purchasing more or less uniform throughout the country.

Round timbers and ties represent some of the most efficient uses of our forest resources. They require a minimum of processing between harvesting the tree and marketing the structural commodity. Poles and piles are debarked or peeled, seasoned, and often treated with preservative prior to use as structural members. Construction logs are usually shaped to facilitate construction. Ties, used for railroads, landscaping, and mining, are slab-cut to provide flat surfaces. Because these products are relatively economical to produce compared with glulam, steel, and concrete products, they are commonly used throughout the United States.

To enable users to buy the quality that best suits their purposes, lumber, round timbers, and ties are graded into use categories, each having an appropriate range in quality.

Generally, the grade of a piece of wood is based on the number, character, and location of features that may lower its strength, durability, or utility value. Among the more common visual features are knots, checks, pitch pockets, shake, and stain, some of which are a natural part of the tree. Some grades are free or practically free from these features. Other grades, which constitute the great bulk of solid wood products, contain fairly numerous knots and other features. With proper grading, lumber containing these features is entirely satisfactory for many uses.

The grading operation for most solid wood products takes place at the sawmill. Establishment of grading procedures is largely the responsibility of manufacturers' associations. Because of the wide variety of wood species, industrial practices, and customer needs, different grading practices coexist. The grading practices of most interest are considered in the sections that follow, under the major categories of hardwood lumber and softwood lumber, round timbers, and ties.

Hardwood Lumber

The principal use of hardwood lumber is for remanufacture into furniture, cabinetwork, and pallets or direct use as flooring, paneling, moulding, and millwork. Hardwood lumber is graded and marketed in three main categories: Factory lumber, dimension parts, and finished market products. Several hardwood species are graded under the American Softwood Lumber Standard and sold as structural lumber (Chap. 7). Also, specially graded hardwood lumber can be used for structural glued-laminated lumber.

Prior to 1898, hardwoods were graded by individual mills for local markets. In 1898, manufacturers and users formed the National Hardwood Lumber Association to standardize grading for hardwood lumber. Between 1898 and 1932, grading was based on the number and size of visual features. In 1932, the basis for grading was changed to standard clear-cutting sizes.

Both Factory lumber and dimension parts are intended to serve the industrial customer. The important difference is that for Factory lumber, the grades reflect the proportion of a piece that can be cut into useful smaller pieces, whereas the grades for dimension parts are based on use of the entire piece. Finished market products are graded for their unique end-use with little or no remanufacture. Examples of finished products include moulding, stair treads, and hardwood flooring.

Factory Lumber

Grades

The rules adopted by the National Hardwood Lumber Association are considered standard in grading hardwood lumber

intended for cutting into smaller pieces to make furniture or other fabricated products. In these rules, the grade of a piece of hardwood lumber is determined by the proportion of a piece that can be cut into a certain number of smaller pieces of material, commonly called cuttings, which are generally clear on one side, have the reverse face sound, and are not smaller than a specified size.

The best grade in the Factory lumber category is termed FAS (Firsts and Seconds). The second grade is F1F (FAS one face). The third grade is Selects, which is followed by No. 1 Common, No. 2A Common, No. 2B Common, No. 3A Common, No. 3B Common, and Sound Wormy. Except for F1F and Selects, the poorer side of a piece is inspected for grade assignment. Standard hardwood lumber grades are described in Table 6-1. This table illustrates, for example, that FAS includes pieces that will allow at least 83-1/3% of their surface measure to be cut into clear face material. Except for Sound Wormy, the minimum acceptable length, width, surface measure, and percentage of piece that must work into a cutting decrease with decreasing grade. Figure 6-1 is an example of grading for cuttings.

This brief summary of grades for Factory lumber should not be regarded as a complete set of grading rules, because many details, exceptions, and special rules for certain species are not included. The complete official rules of the National Hardwood Lumber Association (NHLA) should be followed as the only full description of existing grades (see Table 6-2 for addresses of NHLA and other U.S. hardwood grading associations). Table 6-3 lists names of commercial domestic hardwood species that are graded by NHLA rules.

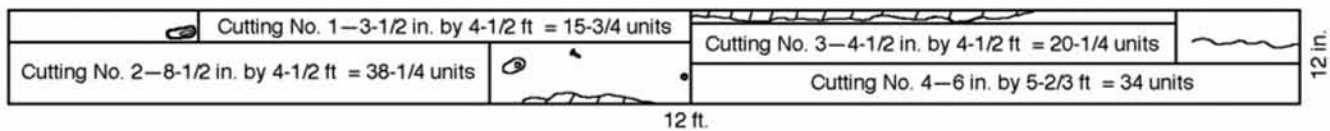

1. Determine Surface Measure (S.M.) using lumber scale stick or from formula:

$$\frac{\text{Width in inches} \times \text{length in feet}}{12} = \frac{12 \text{ in.} \times 12 \text{ ft}}{12}$$

= 12 ft² S.M.

2. No. 1 Common is assumed grade of board. Percent of clear-cutting area required for No. 1 Common—66²/₃% or ⁸/₁₂.

3. Determine maximum number of cuttings permitted.

$$\text{For No. 1 Common grade (S.M. + 1) } \div 3$$

$$= \frac{(12 + 1)}{3} = \frac{13}{3} = 4 \text{ cuttings.}$$

4. Determine minimum size of cuttings.

For No. 1 Common grade 4 in. x 2 ft or 3 in. x 3 ft.

5. Determine clear-face cutting units needed.

$$\text{For No. 1 Common grade S.M.} \times 8 = 12 \times 8$$

$$= 96 \text{ units}$$

6. Determine total area of permitted clear-face cutting in units.

Width in inches and fractions of inches
x length in feet and fractions of feet

$$\text{Cutting \#1—} 3\frac{1}{2} \text{ in.} \times 4\frac{1}{2} \text{ ft} = 15\frac{3}{4} \text{ units}$$

$$\text{Cutting \#2—} 8\frac{1}{2} \text{ in.} \times 4\frac{1}{2} \text{ ft} = 38 \text{ units}$$

$$\text{Cutting \#3—} 4\frac{1}{2} \text{ in.} \times 4\frac{1}{2} \text{ ft} = 20\frac{1}{4} \text{ units}$$

$$\text{Cutting \#4—} 6 \text{ in.} \times 5\frac{2}{3} \text{ ft} = 34 \text{ units}$$

$$\text{Total Units} \quad \quad \quad 108$$

Units required for No. 1 Common—96.

7. Conclusion: Board meets requirements for No. 1 Common grade.

Figure 6-1. Example of hardwood grading for cuttings using No. 1 Common lumber grade. Current grading rules are written only in the inch-pound system of measurement. Standard lengths are in 1-ft increments.

Table 6–1. Standard hardwood lumber grades^{a,b}

Grade and allowable lengths	Allowable width (in.)	Allowable surface measure of pieces (ft ²)	Minimum amount of piece in clearface cuttings (%)	Allowable cuttings	
				Maximum no.	Minimum size
FAS	6+	4 to 7	83-1/3	1	4 in. by 5 ft
8 to 16 ft		6 and 7	91-2/3	2	or
and		8 to 11	83-1/3	2	3 in. by 7 ft
F1F		8 to 11	91-2/3	3	
8 to 16 ft ^c		12 to 15	83-1/2	3	
		12 to 15	91-2/3	4	
		16+	83-1/3	4	
Selects 6 to 16 ft	4+	2 and 3	91-2/3	1	4 in. by 5 ft
		4+	— ^d		or
					3 in. by 7 ft
No. 1 Common 4 to 16 ft (only 5% of minimum width is allowed)	3+	1	100	0	4 in. by 2 ft
		2	75	1	or
		3 and 4	66-2/3	1	3 in. by 3 ft
		3 and 4	75	2	
		5 to 7	66-2/3	2	
		5 to 7	75	3	
		8 to 10	66-2/3	3	
		11 to 13	66-2/3	4	
		14+	66-2/3	5	
No. 2 Common 4 to 16 ft	3+	1	66-2/3	1	3 in. by 2 ft
		2 and 3	50	1	
		2 and 3	66-2/3	2	
		4 and 5	50	2	
		4 and 5	66-2/3	3	
		6 and 7	50	3	
		6 and 7	66-2/3	4	
		8 and 9	50	4	
		10 and 11	50	5	
		12 and 13	50	6	
		14+	50	7	
No. 3A Common 4 to 16 ft	3+	1+	33-1/3 ^f	— ^g	3 in. by 2 ft
No. 3B Common 4 to 16 ft	3+	1+	25 ^h	— ^g	1-1/2 in. by 36 in ²
Sound Wormy ^e					

^aCurrent grading rules are written only in the inch–pound system of measurement.

^bInspection made on poorer side of piece, except in Selects grade.

^cFAS is a grade that designates Firsts and Seconds. F1F is a grade that designates FAS one face.

^dSame as F1F, with reverse side of board not below No. 1 Common.

^eSound Wormy grade shall not be below No. 1 Common except that the natural characteristics of worm holes, bird pecks, stain, sound knot not exceeding 3/4 in. in diameter are admitted. Other sound defects that do not exceed in extent or damage the defects described are admitted in the cuttings. Unless otherwise specified, Sound Wormy shall include the full product of the log in No. 1 Common and Better Sound Wormy.

^fAlso admits pieces that grade not below No. 2 Common on the good face and reverse side of sound cuttings.

^gUnlimited.

^hCuttings must be sound; clear face not required.

Standard Dimensions

Standard lengths of hardwood lumber are in 305-mm (1-ft) increments from 1.2 to 4.9 m (4 to 16 ft). Standard thickness values for hardwood lumber, rough and surfaced on two sides (S2S), are given in Table 6–4. The thickness of S1S lumber is subject to contract agreement. Abbreviations commonly used in contracts and other documents for the purchase and sale of lumber are listed at the end of this chapter.

Hardwood lumber is usually manufactured to random width. The hardwood lumber grades do not specify standard

widths; however, the grades do specify minimum width for each grade as follows:

Grade	Minimum width (mm (in.))
FAS	152 (6)
F1F	152 (6)
Selects	102 (4)
No. 1, 2A, 2B, 3A, 3B Common	76 (3)

Table 6–2. Hardwood grading associations in United States^a

Name and address	Species covered by grading rules (products)
National Hardwood Lumber Association P.O. Box 34518 Memphis, TN 38184–0518 www.nhla.com	All hardwood species (furniture cuttings, construction lumber)
Wood Components Manufacturers Association 741 Butlers Gate, Suite 100 Marietta, GA 30068 www.woodcomponents.org	All hardwood species (hardwood furniture dimension, squares, laminated stock, interior trim, stair treads and risers)
Maple Flooring Manufacturers Association 111 Deer lake Road Suite 100 Deerfield, IL 60015 www.maplefloor.org	Maple, beech, birch (flooring)
National Oak Flooring Manufacturers Association 22 N. Front St., Suite 1080 Memphis, TN 38103 www.nofma.org	Oak, ash, pecan, hickory, pecan, beech, birch, hard maple (flooring, including prefinished)

^aGrading associations that include hardwood species in structural grades are listed in Table 6–5.

If the width is specified by purchase agreement, S1E or S2E lumber is 10 mm (3/8 in.) scant of nominal size in lumber less than 203 mm (8 in.) wide and 13 mm (1/2 in.) scant in lumber ≥203 mm (≥8 in.) wide.

Dimension and Component Parts

The term “dimension parts” for hardwoods signifies stock that is processed in specific thickness, width, and length, or multiples thereof and ranges from semi-machined to completely machined component products. This stock is sometimes referred to as “hardwood dimension stock” or “hardwood lumber for dimension parts.” This stock should not be confused with “dimension lumber,” a term used in the structural lumber market to mean lumber standard 38 mm to less than 89 mm thick (nominal 2 in. to less than 4 in. thick).

Dimension component parts are normally kiln dried and generally graded under the rules of the Wood Components Manufacturers Association (WCMA). These rules encompass three classes of material, each of which is classified into various grades:

Hardwood dimension parts (flat stock)	Solid kiln-dried squares (rough)	Solid kiln-dried squares (surfaced)
Clear two faces	Clear	Clear
Clear one face	Select	Select
Paint	Sound	Paint
Core		Second
Sound		

Each class may be further defined as semifabricated (rough or surfaced) or completely fabricated, including edge-glued panels. The rough wood component parts are blank-sawn and ripped to size. Surfaced semifabricated parts have been

through one or more manufacturing stages. Completely fabricated parts have been completely processed for their end use.

Finished Market Products

Some hardwood lumber products are graded in relatively finished form, with little or no further processing anticipated. Flooring is probably the finished market product with the highest volume. Other examples are lath, siding, ties, planks, carstock, construction boards, timbers, trim, moulding, stair treads, and risers. Grading rules promulgated for flooring anticipate final consumer use and are summarized in this section. Details on grades of other finished products are found in appropriate association grading rules.

Hardwood flooring generally is graded under the rules of the Maple Flooring Manufacturers Association (MFMA) or the National Oak Flooring Manufacturers Association (NOFMA). Tongued-and-grooved, end-matched hardwood flooring is commonly furnished. Square-edge, square-end-strip flooring is also available as well as parquet flooring suitable for laying with mastic.

The grading rules of the Maple Flooring Manufacturers Association cover flooring that is manufactured from hard maple, beech, and birch. Each species is graded into four categories:

- First grade—one face practically free of all imperfections; variations in natural color of wood allowed
- Second grade—tight, sound knots (except on edges or ends) and other slight imperfections allowed; must be possible to lay flooring without waste
- Third grade—may contain all visual features common to hard maple, beech, and birch; will not admit voids on edges or ends, or holes over 10-mm (3/8-in.) in

Chapter 6 Commercial Lumber, Round Timbers, and Ties

Table 6–3. Nomenclature of commercial hardwood lumber

Commercial name for lumber	Common tree name	Botanical name	Commercial name for lumber	Common tree name	Botanical name
Alder, red	Red alder	<i>Alnus rubra</i>	Maple, Oregon	Big leaf maple	<i>Acer macrophyllum</i>
Ash, black	Black ash	<i>Fraxinus nigra</i>	Maple, soft	Red maple	<i>Acer rubrum</i>
Ash, Oregon	Oregon ash	<i>Fraxinus latifolia</i>		Silver maple	<i>Acer saccharinum</i>
Ash, white	Blue ash	<i>Fraxinus quadrangulata</i>	Oak, red	Black oak	<i>Quercus velutina</i>
	Green ash	<i>Fraxinus pennsylvanica</i>		Blackjack oak	<i>Quercus marilandica</i>
	White ash	<i>Fraxinus americana</i>		California black oak	<i>Quercus kelloggi</i>
Aspen (popple)	Bigtooth aspen	<i>Populus grandidentata</i>		Cherrybark oak	<i>Quercus falcata</i> var. <i>pagodaefolia</i>
	Quaking aspen	<i>Populus tremuloides</i>		Laurel oak	<i>Quercus laurifolia</i>
Basswood	American basswood	<i>Tilia americana</i>		Northern pin oak	<i>Quercus ellipsoidalis</i>
	White basswood	<i>Tilia heterophylla</i>		Northern red oak	<i>Quercus rubra</i>
Beech	American beech	<i>Fagus grandifolia</i>		Nuttall oak	<i>Quercus nuttallii</i>
Birch	Gray birch	<i>Betula populifolia</i>		Pin oak	<i>Quercus palustris</i>
	Paper birch	<i>Betula papyrifera</i>		Scarlet oak	<i>Quercus coccinea</i>
	River birch	<i>Betula nigra</i>		Shumard oak	<i>Quercus shumardii</i>
	Sweet birch	<i>Betula lenta</i>		Southern red oak	<i>Quercus falcata</i>
	Yellow birch	<i>Betula alleghaniensis</i>		Turkey oak	<i>Quercus laevis</i>
Boxelder	Boxelder	<i>Acer negundo</i>		Willow oak	<i>Quercus phellos</i>
Buckeye	Ohio buckeye	<i>Aesculus glabra</i>	Oak, white	Arizona white oak	<i>Quercus arizonica</i>
	Yellow buckeye	<i>Aesculus octandra</i>		Blue oak	<i>Quercus douglasii</i>
Butternut	Butternut	<i>Juglans cinerea</i>		Bur oak	<i>Quercus macrocarpa</i>
Cherry	Black cherry	<i>Prunus serotina</i>		Valley oak	<i>Quercus lobata</i>
Chestnut	American chestnut	<i>Castanea dentate</i>		Chestnut oak	<i>Quercus prinus</i>
Cottonwood	Balsam poplar	<i>Populus balsamifera</i>		Chinkapin oak	<i>Quercus muehlenbergii</i>
	Eastern cottonwood	<i>Populus deltoids</i>		Emory oak	<i>Quercus emoryi</i>
	Black cottonwood	<i>Populus trichocarpa</i>		Gambel oak	<i>Quercus gambelii</i>
Cucumber	Cucumbertree	<i>Magnolia acuminata</i>		Mexican blue oak	<i>Quercus oblongifolia</i>
Dogwood	Flowering dogwood	<i>Cornus florida</i>		Live oak	<i>Quercus virginiana</i>
	Pacific dogwood	<i>Cornus nuttallii</i>		Oregon white oak	<i>Quercus garryana</i>
Elm, rock	Cedar elm	<i>Ulmus crassifolia</i>		Overcup oak	<i>Quercus lyrata</i>
	Rock elm	<i>Ulmus thomasii</i>		Post oak	<i>Quercus stellata</i>
	September elm	<i>Ulmus serotina</i>		Swamp chestnut oak	<i>Quercus michauxii</i>
	Winged elm	<i>Ulmus alata</i>		Swamp white oak	<i>Quercus bicolor</i>
Elm, soft	American elm	<i>Ulmus Americana</i>		White oak	<i>Quercus alba</i>
	Slippery elm	<i>Ulmus rubra</i>	Oregon myrtle	California-laurel	<i>Umbellularia californica</i>
Gum	Sweetgum	<i>Liquidambar styraciflua</i>	Osage orange	Osage-orange	<i>Maclura pomifera</i>
Hackberry	Hackberry	<i>Celtis occidentalis</i>	Pecan	Bitternut hickory	<i>Carya cordiformis</i>
	Sugarberry	<i>Celtis laevigata</i>		Nutmeg hickory	<i>Carya myristiciformis</i>
Hickory	Mockernut hickory	<i>Carya tomentosa</i>		Water hickory	<i>Carya aquatica</i>
	Pignut hickory	<i>Carya glabra</i>		Pecan	<i>Carya illinoensis</i>
	Shagbark hickory	<i>Carya ovata</i>	Persimmon	Common persimmon	<i>Diospyros virginiana</i>
	Shellbark hickory	<i>Carya lacinoso</i>	Poplar	Yellow-poplar	<i>Liriodendron tulipifera</i>
Holly	American holly	<i>Ilex opaca</i>	Sassafras	Sassafras	<i>Sassafras albidum</i>
Ironwood	Eastern hophornbeam	<i>Ostrya virginiana</i>	Sycamore	Sycamore	<i>Platanus occidentalis</i>
Locust	Black locust	<i>Robinia pseudoacacia</i>	Tanoak	Tanoak	<i>Lithocarpus densiflorus</i>
	Honeylocust	<i>Gleditsia triacanthos</i>	Tupelo	Black tupelo, blackgum	<i>Nyssa sylvatica</i>
Madrone	Pacific madrone	<i>Arbutus menziesii</i>		Ogeechee tupelo	<i>Nyssa ogeche</i>
Magnolia	Southern magnolia	<i>Magnolia grandiflora</i>		Water tupelo	<i>Nyssa aquatica</i>
	Sweetbay	<i>Magnolia virginiana</i>	Walnut	Black walnut	<i>Juglans nigra</i>
Maple, hard	Black maple	<i>Acer nigrum</i>	Willow	Black willow	<i>Salix nigra</i>
	Sugar maple	<i>Acer saccharum</i>		Peachleaf willow	<i>Salix amygdaloides</i>

diameter; must permit proper laying of floor and provide a serviceable floor; few restrictions on imperfections; must be possible to lay flooring properly

- Fourth grade—may contain all visual features, but must be possible to lay a serviceable floor, with some cutting

Combination grades of “Second and Better” and “Third and Better” are sometimes specified. There are also special grades based on color and species.

The standard thickness of MFMA hard maple, beech, and birch flooring is 20 mm (25/32 in.). Face widths are 38, 51, 57, and 83 mm (1-1/2, 2, 2-1/4, and 3-1/4 in.). Standard lengths are 610 mm (2 ft) and longer in First- and Second-grade flooring and 381 mm (1-1/4 ft) and longer in Third-grade flooring.

The Official Flooring Grading Rules of NOFMA cover oak (unfinished and prefinished), beech, birch, hard maple, ash, and hickory/pecan. Flooring grades are determined by the appearance of the face surface.

Oak is separated as red oak and white oak and by grain direction: plain sawn (all cuts), quartersawn (50% quartered character), rift sawn (75% rift character), and quarter/rift sawn (a combination). Oak flooring has four main grade separations—Clear, Select, No. 1 Common, and No. 2 Common. Clear is mostly heartwood and accepts a 10-mm (3/8-in.) strip of bright sapwood or an equivalent amount not more than 25 mm (1 in.) wide along the edge and a minimum number of character marks and discoloration, allowing for all natural heartwood color variations. Select allows all color variations of natural heartwood and sapwood

Table 6–4. Standard thickness values for rough and surfaced (S2S) hardwood lumber

Rough (mm)(in.)		Surfaced (mm)(in.)	
10	(3/8)	5	(3/16)
13	(1/2)	8	(5/16)
16	(5/8)	9	(7/16)
19	(3/4)	14	(9/16)
25	(1)	21	(13/16)
32	(1-1/4)	27	(1-1/16)
38	(1-1/2)	33	(1-5/16)
44	(1-3/4)	38	(1-1/2)
51	(2)	44	(1-3/4)
63	(2-1/2)	57	(2-1/4)
76	(3)	70	(2-3/4)
89	(3-1/2)	83	(3-1/4)
102	(4)	95	(3-3/4)
114	(4-1/2)	— ^a	— ^a
127	(5)	— ^a	— ^a
140	(5-1/2)	— ^a	— ^a
152	(6)	— ^a	— ^a

^aFinished size not specified in rules. Thickness subject to special contract.

along with characters such as small knots, pinworm holes, and brown streaks. No. 1 Common contains prominent variations in coloration, which include heavy streaks, sticker stains, open checks, knots, and small knot holes that fill. No. 2 Common contains sound natural variation of the forest product and manufacturing imperfections to provide a serviceable floor.

Average lengths for unfinished oak grades are as follows:

Grade	Standard packaging	Shorter packaging
Clear	1.14 m (3-3/4 ft)	1.07 m (3-1/2 ft)
Select	0.99 m (3-1/4 ft)	0.91 m (3 ft)
No. 1 Common	0.84 m (2-3/4 ft)	0.76 m (2-1/2 ft)
No. 2 Common	0.69 m (2-1/4 ft)	0.61 m (2 ft)

Standard packaging refers to nominal 2.4-m (8-ft) pallets or nested bundles. Shorter packaging refers to nominal 2.1-m (7-ft) and shorter pallets or nested bundles.

Standard and special NOFMA grades for species other than oak are as follows:

Species	Grade
Standard Grades	
Beech, birch, and hard maple	First, Second, Third, Second & Better, Third & Better
Hickory and pecan	First, Second, Third, Second & Better, Third & Better
Ash	Clear, Select, No. 1 Common, No. 2 Common
Special Grades	
Beech and birch	First Grade Red
Hard maple	First Grade White
Hickory and pecan	First Grade White, First Grade Red, Second Grade Red

Standard thickness values for NOFMA tongue and groove flooring are 19, 13, 10 (3/4, 1/2, 3/8 in.), with 20 and 26 mm (25/32 and 33/32 in.) for maple flooring. Standard face widths are 38, 51, 57, and 83 mm (1-1/2, 2, 2-1/4, and 3-1/4 in.). Strips are random length from minimum 0.23 m to maximum 2.6 m (9 to 102 in.).

Lumber Species

Names used by the trade to describe commercial lumber in the United States are not always the same as names of trees adopted as official by the U.S. Forest Service. Table 6–3 shows the commercial name, the U.S. Forest Service tree name, and the botanical name. United States agencies and associations that prepare rules for and supervise grading of hardwoods are given in Table 6–2.

Softwood Lumber

For many years, softwood lumber has demonstrated the versatility of wood by serving as a primary raw material for

construction and manufacture. In this role, softwood lumber has been produced in a wide variety of products from many different species. The first industry-sponsored grading rules (product descriptions) for softwoods, which were established before 1900, were comparatively simple because sawmills marketed their lumber locally and grades had only local significance. As new timber sources were developed and lumber was transported to distant points, each producing region continued to establish its own grading rules; thus, lumber from various regions differed in size, grade name, and allowable grade characteristics. When different species were graded under different rules and competed in the same consuming areas, confusion and dissatisfaction were inevitable.

To minimize unnecessary differences in the grading rules of softwood lumber and to improve and simplify these rules, a number of conferences were organized by the U.S. Department of Commerce from 1919 to 1925. These meetings were attended by representatives of lumber manufacturers, distributors, wholesalers, retailers, engineers, architects, and contractors. The result was a relative standardization of sizes, definitions, and procedures for deriving allowable design properties, formulated as a voluntary American Lumber Standard. This standard has been modified several times, including addition of hardwood species to the standard beginning in 1970. The current edition is the American Softwood Lumber Standard PS-20. Lumber cannot be graded as American Standard lumber unless the grade rules have been approved by the American Lumber Standard Committee (ALSC), Inc., Board of Review.

Softwood lumber is classified for market use by form of manufacture, species, and grade. For many products, the American Softwood Lumber Standard and the grading rules certified through it serve as a basic reference. For specific information on other products, reference must be made to grade rules, industry marketing aids, and trade journals.

Lumber Grades

Softwood lumber grades can be classified into three major categories of use: (a) yard lumber, (b) structural lumber, and (c) Factory and Shop lumber. Yard lumber and structural lumber relate principally to lumber expected to function as graded and sized after primary processing (sawing and planing). Factory and Shop refer to lumber that will undergo a number of further manufacturing steps and reach the consumer in a significantly different form.

Yard Lumber

Grading requirements of yard lumber are specifically related to the construction uses intended, and little or no further grading occurs once the piece leaves the sawmill. Yard lumber can be placed into two basic classifications, Select and Common. Select and Common lumber, as categorized here, encompass those lumber products in which appearance or utility is of primary importance; structural integrity, while sometimes important, is a secondary feature.

Select Lumber—Select lumber is generally non-stress-graded, but it forms a separate category because of the distinct importance of appearance in the grading process. Select lumber is intended for natural and paint finishes. This category of lumber includes lumber that has been machined to a pattern and S4S lumber. Secondary manufacture of these items is usually restricted to on-site fitting such as cutting to length and mitering. The Select category includes trim, siding, flooring, ceiling, paneling, casing, base, stepping, and finish boards.

Most Select lumber grades are generally described by letters and combinations of letters (B&BTR, C&BTR, C Select, D, D Select) or names (Superior, Prime, Supreme, Choice, Quality) depending upon the species and the grading rules under which the lumber is graded. (See list of commonly used lumber abbreviations at the end of this chapter.) The specifications FG (flat grain), VG (vertical grain), and MG (mixed grain) are offered as a purchase option for some select lumber products.

In cedar and redwood, there is a pronounced difference in color between heartwood and sapwood. Heartwood also has high natural resistance to decay, so some grades are denoted as “heart.” Because Select lumber grades emphasize the quality of one face, the reverse side may be lower in quality. Select lumber grades are not uniform across species and products, so certified grade rules for the species must be used for detailed reference.

Common Lumber—Common lumber is normally a non-stress-graded product. The grades of Common lumber are suitable for construction and utility purposes. Common lumber is generally separated into three to five different grades depending upon the species and grading rules involved. Grades may be described by number (No. 1, No. 2, No. 1 Common, No. 2 Common) or descriptive term (Select Merchantable, Construction, Standard).

Because there are differences in the inherent properties of various species and their corresponding names, the grades for different species are not always interchangeable. The top-grade boards (No. 1, No. 1 Common, Select Merchantable) are usually graded for serviceability, but appearance is also considered. These grades are used for such purposes as siding, cornice, shelving, and paneling. Features such as knots and knotholes are permitted to be larger and more frequent as the grade level becomes lower. Intermediate-grade boards are often used for such purposes as subfloors, roof and wall sheathing, and rough concrete work. The lower grade boards are selected for adequate usability, not appearance. They are used for roof and wall sheathing, subfloor, and rough concrete form work (Fig. 6-2).

Grading provisions for other non-stress-graded products vary by species, product, and applicable grading rules. For detailed descriptions, consult the appropriate grade rule for these products (see Table 6-5 for softwood grading organizations).

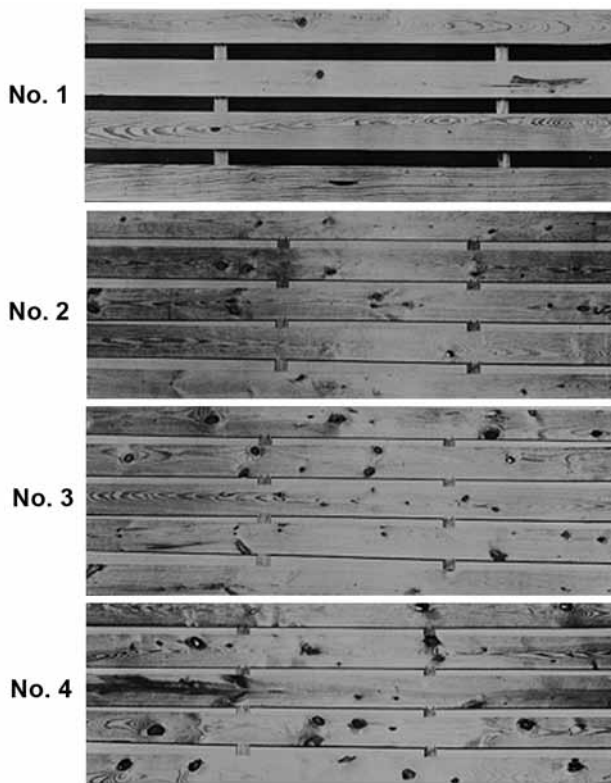

Figure 6–2. Typical examples of softwood boards in the lower grades.

Structural Lumber—Almost all softwood lumber standard 38 to 89 mm thick (nominal 2 to 4 in. thick, actual 1-1/2 to 3-1/2 in. thick) is produced as dimension lumber. Dimension lumber is stress graded and assigned allowable properties under the National Grading Rule, a part of the American Softwood Lumber Standard. For dimension lumber, a single set of grade names and descriptions is used throughout the United States, although the allowable properties vary with species. Timbers (lumber standard 114 mm (nominal 5 in.) or more in least dimension) are also structurally graded under ALSC procedures. Unlike grade descriptions for dimension lumber, grade descriptions for structural timbers are not standardized across species. For most species, timber grades are classified according to intended use. Beams and stringers are members standard 114 mm (nominal 5 in.) or more in thickness with a width more than 38 mm (nominal 2 in.) greater than the thickness. Beams and stringers are primarily used to resist bending stresses, and the grade description of some timber grades for the middle third of the length of the beam is more stringent than that for the outer two-thirds. Posts and timbers are members standard 114 by 114 mm (nominal 5 by 5 in.) and larger, where the width is not more than 38 mm (nominal 2 in.) greater than the thickness. Post and timbers are primarily used to resist axial stresses. Structural timbers of Southern Pine are graded without regard to anticipated use, as with dimension lumber.

Other stress-graded products include decking and some boards. Stress-graded lumber may be graded visually or

mechanically. Stress grades and the National Grading Rule are discussed in Chapter 6.

Structural Laminations—Structural laminating grades describe the characteristics used to segregate lumber to be used in structural glued-laminated (glulam) timbers. Generally, allowable properties are not assigned separately to laminating grades; rather, the rules for laminating grades are based on the expected effect of that grade of lamination on the combined glulam timber.

There are two kinds of graded material: visually graded and E-rated. Visually graded material is graded according to one of three sets of grading rules: (1) the first set is based on the grading rules certified as meeting the requirements of the American Softwood Lumber Standard with additional requirements for laminating; (2) the second set involves laminating grades typically used for visually graded western species and includes three basic categories (L1, L2, L3); and (3) the third set includes special requirements for tension members and outer tension laminations on bending members. The visual grades have provisions for dense, close-grain, medium-grain, or coarsegrain lumber.

The E-rated grades are categorized by a combination of visual grading criteria and lumber stiffness. These grades are expressed in terms of the size of maximum edge characteristic permitted (as a fraction of the width) along with a specified long-span modulus of elasticity (for example, 1/6–2.2E).

Radius-Edged Decking—Radius-edged decking is another substantial softwood lumber product. Radius-edged decking is intended for flatwise use and has oversized eased edges of a particular radius. Most often radius-edged decking is produced as 25- or 38-mm- (nominal 5/4- or 2-in.-, actual 1- or 1-1/2-in.-) thick by 140-mm- (nominal 4- to 6-in.-, actual 3-1/2- to 5-1/2-in.-) wide pieces of lumber 2.4 to 4.9 m (8 to 16 ft) in length. The standard radius for 25-mm-thick radius-edged decking product is 6.4 mm (1/4 in.), and 9.5 mm (3/8 in.) for 38-mm-thick decking. Decking is usually separated into a minimum of two grades, most commonly Premium and Standard.

Factory and Shop Lumber

A wide variety of species, grades, and sizes of softwood lumber is supplied to industrial accounts for cutting to specific smaller sizes, which become integral parts of other products. In the secondary manufacturing process, grade descriptions, sizes, and often the entire appearance of the wood piece are changed. Thus, for Factory and Shop lumber, the role of the grading process is to reflect as accurately as possible the yield to be obtained in the subsequent cutting operation. Typical of lumber for secondary manufacture are the factory grades, industrial clears, box lumber, moulding stock, and ladder stock. The variety of species available for these purposes has led to a variety of grade names and grade definitions. The following sections briefly outline some of the more common classifications. For details, reference must

Table 6–5. Organizations promulgating softwood grades

Name and address	Species covered by grading rules
Cedar Shingle & Shake Bureau 515 116th Avenue NE, Suite 275 Bellevue, WA 98004–5294	Western redcedar (shingles and shakes)
National Hardwood Lumber Association P.O. Box 34518 Memphis, TN 38184–0518	Baldcypress, eastern redcedar
National Lumber Grades Authority ^a 406 First Capital Place 960 Quamside Drive New Westminster, BC, Canada V3M6G2	Northern white-cedar, western redcedar, yellow-cedar, alpine fir, amabilis fir, balsam fir, Douglas-fir, grand fir, eastern hemlock, western hemlock, western larch, eastern white pine, jack pine, lodgepole pine, ponderosa pine, red pine, western white pine, black spruce, Sitka spruce, red spruce, Engelmann spruce, white spruce, tamarack, aspen, black cottonwood, balsam poplar, red alder, white birch
Northeastern Lumber Manufacturers Association, Inc. ^a 272 Tuttle Road, P.O. Box 87A Cumberland Center, ME 04021	Balsam fir, eastern white pine, red pine, eastern hemlock, black spruce, white spruce, red spruce, pitch pine, tamarack, jack pine, northern white cedar, aspen, mixed maple, beech, birch, hickory, mixed oaks, yellow poplar
Northern Softwood Lumber Bureau ^a 272 Tuttle Road, P.O. Box 87A Cumberland Center, ME 04021	Eastern white pine, jack pine, red pine, pitch pine, eastern spruce (red, white, and black), balsam fir, eastern hemlock, tamarack, eastern cottonwood, aspen yellow poplar
Redwood Inspection Service ^a 405 Enfrente Drive, Suite 200 Novato, CA 94949	Redwood
Southern Cypress Manufacturers Association 400 Penn Center Boulevard Suite 530 Pittsburgh, PA 15235	Baldcypress
Southern Pine Inspection Bureau ^a 4709 Scenic Highway Pensacola, FL 32504	Longleaf pine, slash pine, shortleaf pine, loblolly pine, Virginia pine, pond pine, sand pine, baldcypress
West Coast Lumber Inspection Bureau ^a Box 23145 6980 SW. Varns Road Portland, OR 97223	Douglas-fir, western hemlock, western redcedar, incense-cedar, Port-Orford-cedar, yellow-cedar, western true firs, mountain hemlock, Sitka spruce, western larch
Western Wood Products Association ^a Yeon Building, 522 SW Fifth Avenue Portland, OR 97204–2122	Ponderosa pine, western (Idaho) white pine, Douglas-fir, sugar pine, western true firs, western larch, Engelmann spruce, incense-cedar, western hemlock, lodgepole pine, western redcedar, mountain hemlock, red alder, aspen, subalpine fir, Sitka spruce, Port-Orford cedar

^aPublishes grading rules certified by the Board of Review of the American Lumber Standard Committee as conforming to the American Softwood Lumber Standard PS–20.

be made to industry sources, such as certified grading rules. Availability and grade designation often vary by region and species.

Factory (Shop) Grades—Traditionally, softwood lumber used for cuttings has been called Factory or Shop. This lumber forms the basic raw material for many secondary manufacturing operations. Some grading rules refer to these grades as Factory, while others refer to them as Shop. All impose a somewhat similar nomenclature in the grade structure. Shop lumber is graded on the basis of characteristics that affect its use for general cut-up purposes or on the basis of size of cutting, such as for sash and doors. Factory Select and Select Shop are typical high grades, followed by No. 1 Shop, No. 2 Shop, and No. 3 Shop.

Grade characteristics of boards are influenced by the width, length, and thickness of the basic piece and are based on the amount of high-quality material that can be removed by cutting. Typically, Factory Select and Select Shop lumber would be required to contain 70% of cuttings of specified size, clear on both sides. No. 1 Shop would be required to have 50% cuttings and No. 2 Shop, 33-1/3%. Because of different characteristics assigned to grades with similar nomenclature, the grades of Factory and Shop lumber must be referenced to the appropriate certified grading rules.

Industrial Clears—These grades are used for trim, cabinet stock, garage door stock, and other product components where excellent appearance, mechanical and physical properties, and finishing characteristics are important. The principal grades are B&BTR, C, and D Industrial. Grading is primarily based on the best face, although the influence of edge characteristics is important and varies depending upon piece width and thickness. In redwood, the Industrial Clear All Heart grade includes an “all heart” requirement for decay resistance in the manufacture of cooling towers, tanks, pipe, and similar products.

Moulding, Ladder, Pole, Tank, and Pencil Stock—Within producing regions, grading rules delineate the requirements for a variety of lumber classes oriented to specific consumer products. Custom and the characteristics of the wood supply have led to different grade descriptions and terminology. For example, in West Coast species, the ladder industry can choose from one “ladder and pole stock” grade plus two ladder rail grades and one ladder rail stock grade. In Southern Pine, ladder stock is available as Select and Industrial. Moulding stock, tank stock, pole stock, stave stock, stadium seat stock, box lumber, and pencil stock are other typical classes oriented to the final product. Some product classes have only one grade level; a few offer two or three levels. Special features of these grades may include a restriction on sapwood related to desired decay resistance, specific requirements for slope of grain and growth ring orientation for high-stress use such as ladders, and particular cutting requirements as in pencil stock. All references to these grades should be made directly to current certified grading rules.

Lumber Manufacture

Size

Lumber length is recorded in actual dimensions, whereas width and thickness are traditionally recorded in “nominal” dimensions—actual dimensions are somewhat less.

Softwood lumber is manufactured in length multiples of 305 mm (1 ft) as specified in various grading rules. In practice, 610-mm (2-ft) multiples (in even numbers) are common for most construction lumber. Width of softwood lumber varies, commonly from standard 38 to 387 mm (nominal 2 to 16 in.). The thickness of lumber can be generally categorized as follows:

- Boards—lumber less than standard 38 mm (nominal 2 in.) in thickness
- Dimension—lumber from standard 38 mm (nominal 2 in.) to, but not including, 114 mm (nominal 5 in.) in thickness
- Timbers—lumber standard 114 mm (nominal 5 in.) or more in thickness in least dimension

To standardize and clarify nominal to actual sizes, the American Softwood Lumber Standard PS–20 specifies the actual thickness and width for lumber that falls under the standard. The standard sizes for yard and structural lumber are given in Table 6–6. Timbers are usually surfaced while “green” (unseasoned); however, dry sizes are also given.

Because dimension lumber and boards of some species may be surfaced green or dry at the prerogative of the manufacturer, both green and dry standard sizes are given. The sizes are such that a piece of green lumber, surfaced to the standard green size, will shrink to approximately the standard dry size as it dries to about 15% moisture content. The definition of dry boards and dimension is lumber that has been seasoned or dried to a maximum moisture content of 19%. The definition for dry timbers of the various species is found in the certified grading rules. Lumber may also be designated as kiln dried (KD), meaning the lumber has been seasoned in a chamber to a predetermined moisture content by applying heat.

Factory and Shop lumber for remanufacture is offered in specified sizes to fit end-product requirements. Factory (Shop) grades for general cuttings are offered in thickness from standard 19 to 89 mm (nominal 1 to 4 in.). Thicknesses of door cuttings start at 29 mm (nominal 1-3/8 in.). Cuttings are of various lengths and widths. Laminating stock is sometimes offered oversize, compared with standard dimension sizes, to permit resurfacing prior to laminating. Industrial Clears can be offered rough or surfaced in a variety of sizes, starting from standard 38 mm (nominal 2 in.) and thinner and as narrow as standard 64 mm (nominal 3 in.). Sizes for special product grades such as moulding stock and ladder stock are specified in appropriate grading rules or handled by purchase agreements.

Table 6–6. American Standard Lumber sizes for yard and structural lumber for construction

Item	Thickness					Face width					
	Nominal	Minimum dressed				Nominal	Minimum dressed				
		Dry		Green			Dry		Green		
(in.)	(mm)	(in.)	(mm)	(in.)	(in.)	(mm)	(in.)	(mm)	(in.)		
Boards	1	19	(3/4)	20	(25/32)	2	38	(1-1/2)	40	(1-9/16)	
	1-1/4	25	(1)	26	(1-1/32)	3	64	(2-1/2)	65	(2-9/16)	
	1-1/2	32	(1-1/4)	33	(1-9/32)	4	89	(3-1/2)	90	(3-9/16)	
						5	114	(4-1/2)	117	(4-5/8)	
						6	140	(5-1/2)	143	(5-5/8)	
						7	165	(6-1/2)	168	(6-5/8)	
						8	184	(7-1/4)	190	(7-1/2)	
						9	210	(8-1/4)	216	(8-1/2)	
						10	235	(9-1/4)	241	(9-1/2)	
						11	260	(10-1/4)	267	(10-1/2)	
						12	286	(11-1/4)	292	(11-1/2)	
						14	337	(13-1/4)	343	(13-1/2)	
						16	387	(15-1/4)	394	(15-1/2)	
	Dimension	2	38	(1-1/2)	40	(1-9/16)	2	38	(1-1/2)	40	(1-9/16)
		2-1/2	51	(2)	52	(2-1/16)	3	64	(2-1/2)	65	(2-9/16)
		3	64	(2-1/2)	65	(2-9/16)	4	89	(3-1/2)	90	(3-9/16)
3-1/2		76	(3)	78	(3-1/16)	5	114	(4-1/2)	117	(4-5/8)	
4		89	(3-1/2)	90	(3-9/16)	6	140	(5-1/2)	143	(5-5/8)	
4-1/2		102	(4)	103	(4-1/16)	8	184	(7-1/4)	190	(7-1/2)	
						10	235	(9-1/4)	241	(9-1/2)	
						12	286	(11-1/4)	292	(11-1/2)	
						14	337	(13-1/4)	343	(13-1/2)	
						16	387	(15-1/4)	394	(15-1/2)	
Timbers	5 & 6 thick	13 mm off	(1/2 in. off)	13 mm off	(1/2 in. off)	5 & 6 wide	13 mm off	(1/2 in. off)	13 mm off	(1/2 in. off)	
	7–15 thick	19 mm off	(3/4 in. off)	13 mm off	(1/2 in. off)	7–15 wide	19 mm off	(3/4 in. off)	13 mm off	(1/2 in. off)	
	≥ 16 thick	25 mm off	(1 in. off)	13 mm off	(1/2 in. off)	≥ 16 wide	25 mm off	(1 in. off)	13 mm off	(1/2 in. off)	

Surfacing

Lumber can be produced either rough or surfaced (dressed). Rough lumber has surface imperfections caused by the primary sawing operations. It may be greater than target size by variable amounts in both thickness and width, depending upon the type of sawmill equipment. Rough lumber serves as a raw material for further manufacture and also for some decorative purposes. A roughsawn surface is common in post and timber products.

Surfaced lumber has been surfaced by a machine on one side (S1S), two sides (S2S), one edge (S1E), two edges (S2E), or combinations of sides and edges (S1S1E, S2S1E, S1S2, S4S). Lumber is surfaced to attain smoothness of surface and uniformity of size.

Imperfections or blemishes defined in the grading rules and caused by machining are classified as “manufacturing imperfections.” For example, chipped and torn grain are surface irregularities in which surface fibers have been torn out by the surfacing operation. Chipped grain is a “barely perceptible” characteristic, while torn grain is classified by depth. Raised grain, skip, machine burn and gouge, chip marks, and wavy surfacing are other manufacturing imperfections. Manufacturing imperfections are defined in the

American Softwood Lumber Standard and further detailed in the grading rules. Classifications of manufacturing imperfections (combinations of imperfections allowed) are established in the rules as Standard A, Standard B, and so on. For example, Standard A admits very light torn grain, occasional very light chip marks, and very slight knife marks. These classifications are used as part of the grade rule description of some lumber products to specify the allowable surface quality.

Patterns

Lumber that has been matched, shiplapped, or otherwise patterned, in addition to being surfaced, is often classified as “worked lumber.” Figure 6–3 shows typical patterns.

Softwood Lumber Species

The names of lumber species adopted by the trade as standard may vary from the names of trees adopted as official by the U.S. Forest Service. Table 6–7 shows the American Softwood Lumber Standard commercial names for lumber, the U.S. Forest Service tree names, and the botanical names. Some softwood species are marketed primarily in combinations. Designations such as Southern Pine and Hem–Fir represent typical combinations. Grading rule agencies

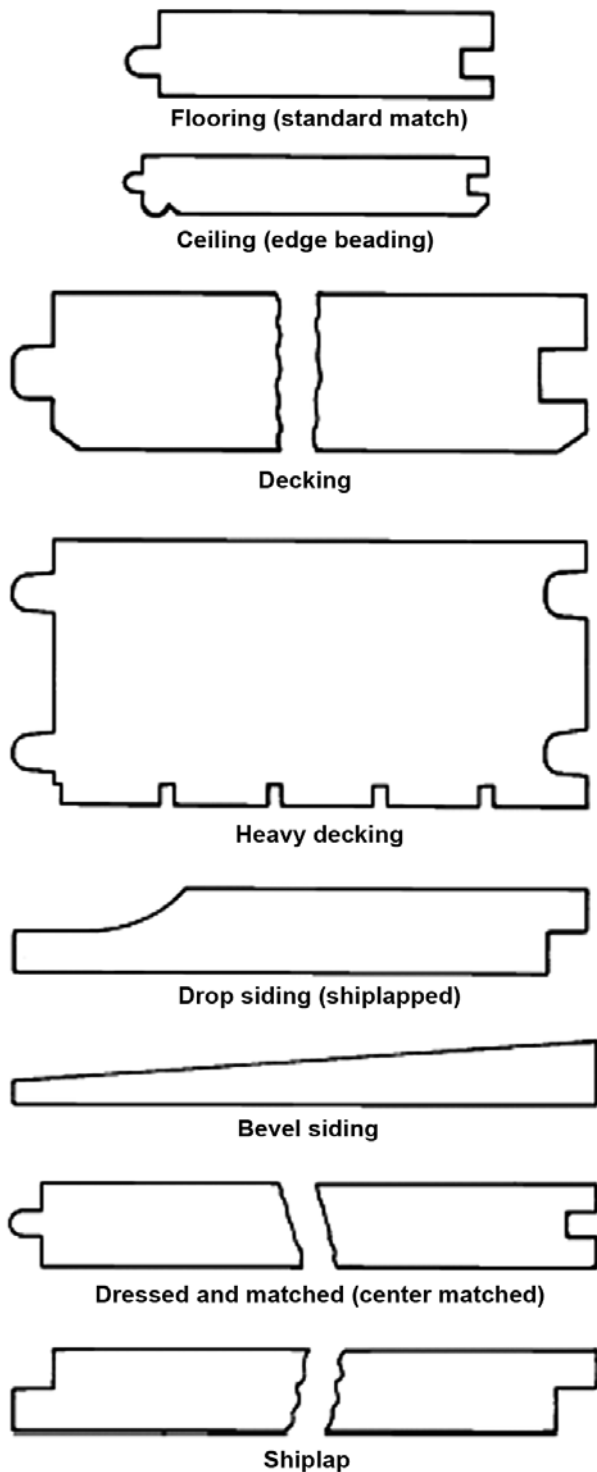

Figure 6-3. Typical patterns of worked lumber.

(Table 6-5) should be contacted for questions regarding combination names and species not listed in Table 6-7. Species groups are discussed further in Chapter 7.

Softwood Lumber Grading

Most lumber is graded under the supervision of inspection bureaus and grading agencies. These organizations supervise lumber mill grading and provide reinspection services

to resolve disputes concerning lumber shipments. Some of these agencies also write grading rules that reflect the species and products in the geographic regions they represent. These grading rules follow the American Softwood Lumber Standard (PS-20). This is important because it provides for recognized uniform grading procedures. Names and addresses of rules-writing organizations in the United States and the species with which they are concerned are listed in Table 6-5. Canadian softwood lumber imported into the United States and graded by inspection agencies in Canada also follows the PS-20 standard. (Names and addresses of accredited Canadian grading agencies may be obtained from the American Lumber Standard Committee, P.O. Box 210, Germantown, MD 20874; email: alsc@alsc.org; www.alsc.org.)

Purchase of Lumber

After primary manufacture, most lumber products are marketed through wholesalers to remanufacturing plants or retail outlets. Because of the extremely wide variety of lumber products, wholesaling is very specialized—some organizations deal with only a limited number of species or products. Where the primary manufacturer can readily identify the customers, direct sales may be made. Primary manufacturers often sell directly to large retail-chain contractors, manufacturers of mobile and modular housing, and truss fabricators.

Some primary manufacturers and wholesalers set up distribution yards in lumber-consuming areas to distribute both hardwood and softwood products more effectively. Retail yards draw inventory from distribution yards and, in wood-producing areas, from local lumber producers. The wide range of grades and species covered in the grade rules may not be readily available in most retail outlets.

Transportation is a vital factor in lumber distribution. Often, the lumber shipped by water is green because weight is not a major factor in this type of shipping. On the other hand, lumber reaching the East Coast from the Pacific Coast by rail is usually kiln-dried because rail shipping rates are based on weight. A shorter rail haul places southern and northeastern species in a favorable economic position in regard to shipping costs in this market.

Changing transportation costs have influenced shifts in market distribution of species and products. Trucks have become a major factor in lumber transport for regional remanufacture plants, for retail supply from distribution yards, and for much construction lumber distribution.

The increased production capacity of foreign hardwood and softwood manufacturing and the availability of water transport have brought foreign lumber products to the U.S. market, particularly in coastal areas.

Retail Yard Inventory

Small retail yards throughout the United States carry softwoods for construction purposes and often carry small

Table 6–7. Nomenclature of principal commercial softwood lumber

Commercial species or species group names under American Softwood Lumber Standard	Tree name used in this handbook	Botanical name
Cedar		
Alaska	yellow-cedar	<i>Chamaecyparis nootkatensis</i>
Eastern red	eastern redcedar	<i>Juniperus virginiana</i>
Incense	incense-cedar	<i>Libocedrus decurrens</i>
Northern white	northern white-cedar	<i>Thuja occidentalis</i>
Port Orford	Port-Orford-cedar	<i>Chamaecyparis lawsoniana</i>
Southern white	Atlantic white-cedar	<i>Chamaecyparis thyoides</i>
Western red	western redcedar	<i>Thuja plicata</i>
Cypress		
Baldcypress	baldcypress	<i>Taxodium distichum</i>
Pond cypress	pond cypress	<i>Taxodium distichum</i> var. <i>nutans</i>
Fir		
Alpine	subalpine fir (alpine fir)	<i>Abies lasiocarpa</i>
Balsam	balsam fir	<i>Abies balsamea</i>
California red	California red fir	<i>Abies magnifica</i>
Douglas Fir	Douglas-fir	<i>Pseudotsuga menziesii</i>
Fraser	Fraser fir	<i>Abies fraseri</i>
Grand	grand fir	<i>Abies grandis</i>
Noble Fir	noble fir	<i>Abies procera</i>
Pacific Grand	Pacific silver fir	<i>Abies amabilis</i>
White	white fir	<i>Abies concolor</i>
Hemlock		
Carolina	Carolina hemlock	<i>Tsuga caroliniana</i>
Eastern	eastern hemlock	<i>Tsuga canadensis</i>
Mountain	mountain hemlock	<i>Tsuga mertensiana</i>
Western	western hemlock	<i>Tsuga heterophylla</i>
Juniper		
Western	alligator juniper	<i>Juniperus deppeana</i>
	Rocky Mountain juniper	<i>Juniperus scopulorum</i>
	Utah juniper	<i>Juniperus osteosperma</i>
	western juniper	<i>Juniperus occidentalis</i>
Larch		
Western	western larch	<i>Larix occidentalis</i>
Pine		
Bishop	bishop pine	<i>Pinus muricata</i>
Coulter	Coulter pine	<i>Pinus coulteri</i>
Digger	Digger pine	<i>Pinus sabibiana</i>
Knobcone	knobcone pine	<i>Pinus attenuata</i>
Idaho white	Western white pine	<i>Pinus monticola</i>
Jack	jack pine	<i>Pinus banksiana</i>
Jeffrey	Jeffrey pine	<i>Pinus jeffreyi</i>
Limber	limber pine	<i>Pinus flexilis</i>
Lodgepole	lodgepole pine	<i>Pinus contorta</i>
Longleaf	longleaf pine	<i>Pinus palustris</i>
	slash pine	<i>Pinus elliottii</i>
Northern white	eastern white pine	<i>Pinus strobus</i>
Norway	red pine	<i>Pinus resinosa</i>
Pitch	pitch pine	<i>Pinus rigida</i>
Ponderosa	ponderosa pine	<i>Pinus ponderosa</i>
Southern Pine Major	loblolly pine	<i>Pinus taeda</i>
	longleaf pine	<i>Pinus palustris</i>
	shortleaf pine	<i>Pinus echinata</i>
	slash pine	<i>Pinus elliottii</i>
Southern Pine Minor	pond pine	<i>Pinus serotina</i>
	sand pine	<i>Pinus clausa</i>
	spruce pine	<i>Pinus glabra</i>
	Virginia pine	<i>Pinus virginiana</i>
Southern Pine Mixed	loblolly pine	<i>Pinus taeda</i>
	longleaf pine	<i>Pinus palustris</i>

Table 6–7. Nomenclature of principal commercial softwood lumber—con.

Commercial species or species group names under American Softwood Lumber Standard	Tree name used in this handbook	Botanical name
	pond pine	<i>Pinus serotina</i>
	shortleaf pine	<i>Pinus echinata</i>
	slash pine	<i>Pinus elliottii</i>
	Virginia pine	<i>Pinus virginiana</i>
Radiata/Monterey Pine	Monterey pine	<i>Pinus radiata</i>
Sugar	sugar pine	<i>Pinus lambertiana</i>
Whitebark	whitebark pine	<i>Pinus albicaulis</i>
Redwood		
Redwood	redwood	<i>Sequoia sempervirens</i>
Spruce		
Blue	blue spruce	<i>Picea pungens</i>
Eastern	black spruce	<i>Picea mariana</i>
	red spruce	<i>Picea rubens</i>
	white spruce	<i>Picea glauca</i>
Engelmann	Engelmann spruce	<i>Picea engelmannii</i>
Sitka	Sitka spruce	<i>Picea sitchensis</i>
Tamarack		
Tamarack	tamarack	<i>Larix laricina</i>
Yew		
Pacific	Pacific yew	<i>Taxus brevifolia</i>
Coast Species	Douglas-fir	<i>Pseudotsuga menziesii</i>
	western larch	<i>Larix occidentalis</i>
Eastern Softwoods	black spruce	<i>Picea mariana</i>
	red spruce	<i>Picea rubens</i>
	white spruce	<i>Picea glauca</i>
	balsam fir	<i>Abies balsamea</i>
	eastern white pine	<i>Pinus strobus</i>
	jack pine	<i>Pinus banksiana</i>
	pitch pine	<i>Pinus rigida</i>
	red pine	<i>Pinus resinosa</i>
	eastern hemlock	<i>Tsuga canadensis</i>
Hem–Fir	tamarack	<i>Larix occidentalis</i>
	western hemlock	<i>Tsuga heterophylla</i>
	California red fir	<i>Abies magnifica</i>
	grand fir	<i>Abies grandis</i>
	noble fir	<i>Abies procera</i>
	Pacific silver fir	<i>Abies amabilis</i>
	white fir	<i>Abies concolor</i>
Hem–Fir (North)	western hemlock	<i>Tsuga heterophylla</i>
	Pacific silver fir	<i>Abies amabilis</i>
Northern Pine	jack pine	<i>Pinus banksiana</i>
	pitch pine	<i>Pinus rigida</i>
	red pine	<i>Pinus resinosa</i>
North Species	northern white cedar	<i>Thuja occidentalis</i>
	western redcedar	<i>Thuja plicata</i>
	yellow-cedar	<i>Chamaecyparis nootkatensis</i>
	eastern hemlock	<i>Tsuga canadensis</i>
	western hemlock	<i>Tsuga heterophylla</i>
	Douglas-fir	<i>Pseudotsuga menziesii</i>
	balsam fir	<i>Abies balsamea</i>
	grand fir	<i>Abies grandis</i>
	Pacific silver fir	<i>Abies amabilis</i>
	subalpine (alpine) fir	<i>Abies lasiocarpa</i>
	western larch	<i>Larix occidentalis</i>
	tamarack	<i>Larix laricina</i>
	eastern white pine	<i>Pinus strobus</i>
	jack pine	<i>Pinus banksiana</i>
	lodgepole pine	<i>Pinus contorta</i>
	ponderosa pine	<i>Pinus ponderosa</i>
	red pine	<i>Pinus resinosa</i>
	western white pine	<i>Pinus monticola</i>
	whitebark pine	<i>Pinus albicaulis</i>

Table 6–7. Nomenclature of principal commercial softwood lumber—con.

Commercial species or species group names under American Softwood Lumber Standard	Tree name used in this handbook	Botanical name
	black spruce	<i>Picea mariana</i>
	Engelmann spruce	<i>Picea engelmannii</i>
	red spruce	<i>Picea rubens</i>
	Sitka spruce	<i>Picea sitchensis</i>
	bigtooth aspen	<i>Populus grandidentata</i>
	quaking aspen	<i>Populus tremuloides</i>
	black cottonwood	<i>Populus trichocarpa</i>
	balsam poplar	<i>Populus balsamifera</i>
Southern Pine	loblolly pine	<i>Pinus taeda</i>
	longleaf pine	<i>Pinus palustris</i>
	shortleaf pine	<i>Pinus echinata</i>
	slash pine	<i>Pinus elliotii</i>
Spruce–Pine–Fir	black spruce	<i>Picea mariana</i>
	Engelmann spruce	<i>Picea engelmannii</i>
	red spruce	<i>Picea rubens</i>
	balsam fir	<i>Abies balsamea</i>
	subalpine (alpine) fir	<i>Abies lasiocarpa</i>
	jack pine	<i>Pinus banksiana</i>
	lodgepole pine	<i>Pinus contorta</i>
Spruce–Pine–Fir (South)	black spruce	<i>Picea mariana</i>
	Engelmann spruce	<i>Picea engelmannii</i>
	red spruce	<i>Picea rubens</i>
	Sitka spruce	<i>Picea sitchensis</i>
	white spruce	<i>Picea glauca</i>
	balsam fir	<i>Abies balsamea</i>
	jack pine	<i>Pinus banksiana</i>
	lodgepole pine	<i>Pinus contorta</i>
	red pine	<i>Pinus resinosa</i>
Western Cedars	incense-cedar	<i>Libocedrus decurrens</i>
	western redcedar	<i>Thuja plicata</i>
	Port-Orford-cedar	<i>Chamaecyparis lawsoniana</i>
	yellow-cedar	<i>Chamaecyparis nootkatensis</i>
Western Cedar (North)	western redcedar	<i>Thuja plicata</i>
	yellow-cedar	<i>Chamaecyparis nootkatensis</i>
Western Woods	Douglas-fir	<i>Pseudotsuga menziesii</i>
	California red fir	<i>Abies magnifica</i>
	grand fir	<i>Abies grandis</i>
	noble fir	<i>Abies procera</i>
	Pacific silver fir	<i>Abies amabilis</i>
	subalpine fir	<i>Abies lasiocarpa</i>
	white fir	<i>Abies concolor</i>
Hemlock	mountain	<i>Tsuga mertensiana</i>
	western hemlock	<i>Tsuga heterophylla</i>
	western larch	<i>Larix occidentalis</i>
	Engelmann spruce	<i>Picea engelmannii</i>
	Sitka spruce	<i>Picea sitchensis</i>
	lodgepole pine	<i>Pinus contorta</i>
	ponderosa pine	<i>Pinus ponderosa</i>
	sugar pine	<i>Pinus lambertiana</i>
	western white pine	<i>Pinus monticola</i>
White Woods	California red fir	<i>Abies magnifica</i>
	grand fir	<i>Abies grandis</i>
	noble fir	<i>Abies procera</i>
	Pacific silver fir	<i>Abies amabilis</i>
	subalpine fir	<i>Abies lasiocarpa</i>
	white fir	<i>Abies concolor</i>
	mountain hemlock	<i>Tsuga mertensiana</i>
	western hemlock	<i>Tsuga heterophylla</i>
	Engelmann spruce	<i>Picea engelmannii</i>
	Sitka spruce	<i>Picea sitchensis</i>
	lodgepole pine	<i>Pinus contorta</i>
	ponderosa pine	<i>Pinus ponderosa</i>
	sugar pine	<i>Pinus lambertiana</i>
	western white pine	<i>Pinus monticola</i>

stocks of one or two hardwoods in grades suitable for finishing or cabinetwork. Special orders must be made for other hardwoods. Trim items such as moulding in either softwood or hardwood are available cut to standard size and pattern. Millwork plants usually make ready-for-installation cabinets, and retail yards carry or catalog many common styles and sizes. Hardwood flooring is available to the buyer only in standard patterns. Most retail yards carry stress grades of lumber.

The assortment of species in general construction items carried by retail yards depends to a great extent upon geographic location, and both transportation costs and tradition are important factors. Retail yards within, or close to, a major lumber-producing region commonly emphasize local timber. For example, a local retail yard on the Pacific Northwest Coast may stock only green Douglas Fir and cedar in dimension grades, dry pine and hemlock in boards and moulding, and assorted special items such as redwood posts, cedar shingles and shakes, and rough cedar siding. The only hardwoods may be walnut and “Philippine mahogany” (the common market name encompassing many species, including tanguile, red meranti, and white lauan). Retail yards located farther from a major softwood supply, such as in the Midwest, may draw from several growing areas and may stock spruce and Southern Pine, for example. Because they are located in a major hardwood production area, these yards may stock, or have available to them, a different and wider variety of hardwoods.

Geography has less influence where consumer demands are more specific. For example, where long construction lumber (6 to 8 m (20 to 26 ft)) is required, West Coast species are often marketed because the height of the trees in several species makes long lengths a practical market item. Ease of preservative treatability makes treated Southern Pine construction lumber available in a wide geographic area.

Structural Lumber for Construction

Dimension lumber is the principal stress-graded lumber available in a retail yard. It is primarily framing lumber for joists, rafters, and studs. Strength, stiffness, and uniformity of size are essential requirements. Dimension lumber is stocked in almost all yards, frequently in only one or two of the general purpose construction woods such as pine, fir, hemlock, or spruce. Standard 38- by 89-mm (nominal 2- by 4-in.) and wider dimension lumber is found in Select Structural, No. 1, No. 2, and No. 3 grades. Standard 38- by 89-mm (nominal 2- by 4-in.) dimension lumber may also be available as Construction, Standard, Utility, and Stud grades. Stud grade is also available in wider widths.

Dimension lumber is often found in standard 38-, 89-, 140-, 184-, 235-, and 286-mm (nominal 2-, 4-, 6-, 8-, 10-, and 12-in.) widths and 2.4- to 5.5-m (8- to 18-ft) lengths in multiples of 0.6 m (2 ft). Dimension lumber formed by structural end-jointing procedures may be available. Dimension lumber thicker than standard 38 mm (nominal 2 in.) and

longer than 5.5 m (18 ft) may not be commonly available in many retail yards.

Other stress-graded products generally available are posts and timbers; some beams and stringers may also be in stock. Typical grades in these products are Select Structural, No. 1, and No. 2.

Yard Lumber for Construction

Boards are the most common non-stress-graded general purpose construction lumber in the retail yard. Boards are stocked in one or more species, usually in standard 19-mm (nominal 1-in.) thickness. Common widths are standard 38, 64, 89, 140, 184, 235, and 286 mm (nominal 2, 3, 4, 6, 8, 10, and 12 in.). Grades generally available in retail yards are No. 1 Common, No. 2 Common, and No. 3 Common (Construction, Standard, No. 1, No. 2, etc.). Boards are sold square edged, dressed (surfaced) and matched (tongued and grooved), or with a shiplapped joint. Boards formed by end-jointing of shorter sections may constitute an appreciable portion of the inventory.

Select Lumber

Completion of a construction project usually depends on the availability of lumber items in finished or semi-finished form. The following items often may be stocked in only a few species, finishes, or sizes depending on the lumber yard.

Finish—Finish boards usually are available in a local yard in one or two species, principally in grade C&BTR. Cedar and redwood have different grade designations: grades such as Clear Heart, A, or B are used in cedar; Clear All Heart, Clear, and B grade are typical in redwood. Finish boards are usually standard 19 mm (nominal 1 in.) thick, surfaced on two sides to 19 mm (nominal 1 in.); 38- to 286-mm (nominal 2- to 12-in.) widths are usually stocked, in even increments.

Siding—Siding is specifically intended to cover exterior walls. Beveled siding is ordinarily stocked in white pine, ponderosa pine, western redcedar, cypress, or redwood. Drop siding, also known as rustic or barn siding, is usually stocked in the same species as is beveled siding. Siding may be stocked as B&BTR or C&BTR except in cedar, where Clear, A, and B grades may be available, and redwood, where Clear All Heart, Clear, and B grades may be found. Vertical grain (VG) is sometimes part of the grade designation. Drop siding is also sometimes stocked in C and D grades of Southern Pine, Douglas Fir, and hemlock. Drop siding may be surfaced and matched, or shiplapped. Knotty grades of cedar (Select Tight Knot (STK)) and redwood (Rustic) are commonly available.

Flooring—Flooring is made chiefly from hardwoods, such as oak and maple, and the harder softwood species, such as Douglas-fir, western larch, and Southern Pine. Often, at least one softwood and one hardwood are stocked. Flooring is usually 19 mm (nominal 1 in.) thick. Thicker flooring is available for heavy-duty floors. Thinner flooring is

available, especially for re-covering old floors. Vertical- and flat-grained (also called quartersawn and plainsawn) flooring is manufactured from both softwoods and hardwoods. Vertical-grained flooring shrinks and swells less than flat-grained flooring, is more uniform in texture, and wears more uniformly, and the edge joints have less tendency to open.

Softwood flooring is usually available in B&BTR, C Select, or D Select grades. In maple, the chief grades are Clear, No. 1, and No. 2. The grades in quartersawn oak are Clear and Select, and in plainsawn, Clear, Select, and No. 1 Common. Quartersawn hardwood flooring has the same advantages as does vertical-grained softwood flooring. In addition, the silver or flaked grain of quartersawn flooring is frequently preferred to the figure of plainsawn flooring.

Casing and Base—Casing and base are standard items in the more important softwoods and are stocked in most yards in at least one species. The chief grade, B&BTR, is designed to meet the requirements of interior trim for dwellings. Many casing and base patterns are surfaced to 17 by 57 mm (11/16 by 2-1/4 in.); other sizes include 14 mm (9/16 in.) by 76 mm (3 in.), by 83 mm (3-1/4 in.), and by 89 mm (3-1/2 in.). Hardwoods for the same purposes, such as oak and birch, may be carried in stock in the retail yard or obtained on special order.

Shingles and Shakes—Commonly available shingles are sawn from western redcedar and northern white-cedar. For western redcedar, the shingle grades are No. 1, No. 2, and No. 3; for northern white-cedar, Extra, Clear, 2nd Clear, Clearwall, and Utility.

Shingles that contain only heartwood are more resistant to decay than are shingles that contain sapwood. Edge-grained shingles are less likely to warp and split than flat-grained shingles, thick-butted shingles less likely than thin-butted shingles, and narrow shingles less likely than wide shingles. The standard thickness values of thin-butted shingles are described as 4/2, 5/2-1/4, and 5/2 (four shingles to 51 mm (2 in.) of butt thickness, five shingles to 57 mm (2-1/4 in.) of butt thickness, and five shingles to 51 mm (2 in.) of butt thickness). Lengths may be 406, 457, or 610 mm (16, 18, or 24 in.). Random widths and specified (“dimension” shingle) widths are available in western redcedar, redwood, and cypress.

Shingles are usually packed four bundles to a square. A square of shingles will cover roughly 9 m² (100 ft²) of roof area when the shingles are applied at standard weather exposures.

Shakes are hand split or hand split and resawn from western redcedar. Shakes are of a single grade and must be 100% clear. In the case of hand split and resawn material, shakes are graded from the split face. Hand-split shakes are graded from the best face. Shakes must be 100% heartwood. The standard thickness of shakes ranges from 9.5 to 32 mm (3/8 to 1-1/4 in.). Lengths are 457 and 610 mm (18 and

24 in.), with a special “Starter–Finish Course” length of 381 mm (15 in.).

Pallet and Container Stock—Wood is often manufactured into lengths and sizes for wooden pallets and containers. As with other uses of wood, pallet and container stock must meet minimum wood quality requirements for checks, splits, shakes, wane, cross grain, decay, knots, and warp that are specific to their intended application. A detailed description of the recognized minimum quality requirements for wood used in the principal types of wood pallets is documented in Uniform Standard for Wood Pallets, and that for packaging is detailed in the Uniform Standard for Wood Containers produced by the National Wooden Pallet and Container Association (NWPCA 2007, 2009). See these documents for a more complete description of terms commonly understood among manufacturers, repairers, distributors, and users of wood pallets and containers. The specifications are specific to the expected number of uses, single or multiple, the item being manufactured is expected to see.

Important Purchase Considerations

Some points to consider when ordering lumber or timbers are the following:

1. **Quantity**—Lineal measure, board measure, surface measure, number of pieces of definite size and length. Consider that the board measure depends on the thickness and width nomenclature used and that the interpretation of these must be clearly delineated. In other words, such features as nominal or actual dimensions and pattern size must be considered.
2. **Size**—Thickness in millimeters or inches—nominal or actual if surfaced on faces; width in millimeters or inches—nominal or actual if surfaced on edges; length in meters or feet—may be nominal average length, limiting length, or a single uniform length. Often a trade designation, “random” length, is used to denote a nonspecified assortment of lengths. Such an assortment should contain critical lengths as well as a range. The limits allowed in making the assortment random can be established at the time of purchase.
3. **Grade**—As indicated in grading rules of lumber manufacturing associations. In softwoods that are in compliance with the American Softwood Lumber Standard, each piece of lumber may be grade stamped with its official grade designation, species identification, a name or number identifying the producing mill, the dryness at the time of surfacing, and a symbol identifying the inspection agency supervising the grading inspection. The grade designation stamped on a piece indicates the quality at the time the piece was graded. Subsequent exposure to unfavorable storage conditions, improper drying, or careless handling may cause the material to fall below its original grade.

Working or recutting a graded product to a pattern may change or invalidate the original grade. The purchase

Table 6–8. Standards and specifications for round timbers and ties^a

Product	Material requirements	Preservative treatment	Engineering design stresses	
			Procedures	Design values
Utility poles	ANSI O5.1	AWPA Commodity Specification D	—	ANSI O5.1
Construction poles	ANSI O5.1	AWPA Commodity Specification D	ASTM D 3200	ASAE EP 388
Piles	ASTM D 25	AWPA Commodity Specification E	ASTM D 2899	NDS
Construction logs	(See material supplier)	—	ASTM D 3957	(See material supplier)
Ties	AREA	AWPA Commodity Specification C, AREA	—	AREA

^aANSI, American National Standards Institute; ASTM, ASTM International; ASAE, American Society of Agricultural Engineers; AREA, American Railway Engineers Association; NDS, National Design Specification (for Wood Construction); AWPA, American Wood Protection Association.

specification should be clear in regard to regrading or acceptance of worked lumber. In softwood lumber, grades for dry lumber generally are determined after kiln drying and surfacing. However, this practice is not general for hardwood Factory lumber, where the grade is generally based on quality and size prior to kiln drying. To be certain the product grade is correct, refer to the grading rule by number and paragraph.

4. Species or species group of wood—Such as Douglas Fir, Southern Pine, Hem–Fir. Some species have been grouped for marketing convenience; others are sold under a variety of names. Be sure the species or species group is correctly and clearly described on the purchase specification.
5. Product—Such as flooring, siding, timbers, boards. Nomenclature varies by species, region, and grading association. To be certain the nomenclature is correct for the product, refer to the grading rule by number and paragraph.
6. Condition of seasoning—Such as air dry, kiln dry. Softwood lumber less than 114 mm (nominal 5 in.) in thickness dried to 19% moisture content or less is defined as dry by the American Softwood Lumber Standard. Kiln-dried lumber is lumber that has been seasoned in a chamber to a predetermined moisture content by applying heat. For lumber of nominal 5-in. or greater in thickness, some species are defined as dry having a maximum moisture content of greater than 19%. Green lumber is lumber less than 114 mm (nominal 5 in.) in thickness that has a moisture content in excess of 19%. For lumber of nominal 5-in. or greater thickness, green shall be defined in accordance with the provision of the applicable grading rules. If the moisture requirement is critical, the level of moisture content and the method by which it will be achieved must be specified.
7. Surfacing and working—Rough (unplaned), surfaced (dressed, planed), or patterned stock. Specify condition. If surfaced, indicate code (S4S, S1S1E). If patterned, list pattern number with reference to appropriate grade rules.
8. Grading rules—Official grading agency name and name of official rules under which product is graded, product identification, paragraph and page number of rules, and date of rules or official rule edition may be specified by the buyer.
9. Manufacturer—Name of manufacturer or trade name of specific product or both. Most lumber products are sold without reference to a specific manufacturer. If proprietary names or quality features of a manufacturer are required, this must be stipulated clearly on the purchase agreement.
10. Structural lumber and timbers should be stamped by an agency accredited by the Board of Review of the American Lumber Standard Committee.
11. Reinspection—Procedures for resolution of purchase disputes. The American Softwood Lumber Standard provides for procedures to be followed in resolution of manufacturer–wholesaler–consumer conflicts over quality or quantity of ALS lumber grades. The dispute may be resolved by reinspecting the shipment. Time limits, liability, costs, and complaint procedures are outlined in the grade rules of both softwood and hardwood agencies under which the disputed shipment was graded and purchased.

Round Timbers and Ties

Standards and Specifications

Material standards and specifications listed in Table 6–8 were created through the joint efforts of producers and users to ensure compatibility between product quality and end use. These guidelines include recommendations for production, treatment, and engineering design. They are updated periodically to conform to changes in material and design technology.

Material Requirements

Round timber and tie material requirements vary with intended use. The majority of uses involve exposure to harsh



Figure 6–4.
An example
of round
timber poles
used for
electrical
utility
distribution.

environments. Thus, in addition to availability, form, and weight, durability is also an important consideration for the use of round timbers and ties. Availability reflects the economic feasibility of procuring members of the required size and grade. Form or physical appearance refers to visual characteristics, such as straightness and occurrence of knots and spiral grain. Weight affects shipping and handling costs and is a function of volume, moisture content, and wood density. Durability is directly related to expected service life and is a function of treatability and natural decay resistance. Finally, regardless of the application, any structural member must be strong enough to resist imposed loads with a reasonable factor of safety. Material specifications available for most applications of round timbers and ties contain guidelines for evaluating these factors.

Availability

Material evaluation begins with an assessment of availability. For some applications, local species of timber may be readily available in an acceptable form and quality. However, this is not normally the case. Pole producers and tie mills are scattered throughout heavily forested regions. Their products are shipped to users throughout North America.

Poles

Most structural applications of poles require timbers that are relatively straight and free of large knots. Poles used to support electric utility distribution and transmission lines (Fig. 6–4) range in length from 6 to 38 m (20 to 125 ft) and from 0.13 to 0.76 m (5 to 30 in.) in diameter, 1.8 m (6 ft) from the butt. Poles used to support local area distribution lines are normally <15 m (<50 ft) long and are predominately Southern Pine.

Hardwood species can be used for poles when the trees are of suitable size and form; their use is limited, however, by their weight, by their excessive checking, and because of the lack of experience in preservative treatment of hardwoods. Thus, most poles are softwoods.

The Southern Pine lumber group (principally loblolly, longleaf, shortleaf, and slash) accounts for roughly 80% of poles treated in the United States. Three traits of these pines account for their extensive use: thick and easily treated sapwood, favorable strength properties and form, and availability in popular pole sizes. In longer lengths, Southern Pine poles are in limited supply, so Douglas-fir, and to some extent western redcedar, ponderosa pine, and western larch, are used to meet requirements for 15-m (50-ft) and longer transmission poles.

Douglas-fir is used throughout the United States for transmission poles and is used in the Pacific Coast region for distribution and building poles. Because the heartwood of Douglas-fir is resistant to preservative penetration and has limited decay and termite resistance, serviceable poles need a well-treated shell of sapwood that is free of checking. To minimize checking after treatment, poles should be adequately seasoned or conditioned before treatment. With these precautions, the poles should compare favorably with treated Southern Pine poles in serviceability.

A small percentage of the poles treated in the United States are of western redcedar, produced mostly in British Columbia. The number of poles of this species used without treatment is not known but is considered to be small. Used primarily for utility lines in northern and western United States, well-treated redcedar poles have a service life that compares favorably with poles made from other species and could be used effectively in pole-type buildings.

Lodgepole pine is also used in small quantities for treated poles. This species is used both for utility lines and for pole-type buildings. It has a good service record when well treated. Special attention is necessary, however, to obtain poles with sufficient sapwood thickness to ensure adequate penetration of preservative, because the heartwood is not usually penetrated and is not decay resistant. The poles must also be well seasoned prior to treatment to avoid checking and exposure of unpenetrated heartwood to attack by decay fungi.

Western larch poles produced in Montana and Idaho came into use after World War II because of their favorable size, shape, and strength properties. Western larch requires preservative treatment full length for use in most areas and, as in the case of lodgepole pine poles, must be selected for adequate sapwood thickness and must be well seasoned prior to treatment. Other species occasionally used for poles are listed in the American National Standards Institute (ANSI) O5.1 standard. These minor species make up a very small portion of pole production and are used locally. Glued-laminated, or glulam, poles are also available for use where



Figure 6–5. Logs are used to construct logging bridges in remote forest areas.

special sizes or shapes are required. The ANSI Standard O5.2 provides guidelines for specifying these poles.

Piles

Material available for timber piles is more restricted than that for poles. Most timber piles used in the eastern half of the United States are Southern Pine, while those used in western United States are coast Douglas-fir. Oak, red pine, and cedar piles are also referenced in timber pile literature but are not as widely used as Southern Pine and Douglas-fir.

Construction Logs

Round timbers have been used in a variety of structures, including bridges, log cabins, and pole buildings. Log stringer bridges (Fig. 6–5) are generally designed for a limited life on logging roads intended to provide access to remote areas. In Alaska where logs may exceed 1 m (3 ft) in diameter, bridge spans may exceed 9 m (30 ft). Building poles, on the other hand, are preservative-treated logs in the 0.15- to 0.25-m- (6- to 10-in.-) diameter range. These poles rarely exceed 9 m (30 ft) in length. Although poles sold for this application are predominately Southern Pine, there is potential for competition from local species in this category. Finally, log cabin logs normally range from 0.2 to 0.25 m (8 to 10 in.) in diameter, and the availability of logs in this size range is not often a problem. However, because logs are not normally preservative-treated for this application, those species that offer moderate to high natural decay resistance, such as western redcedar, are preferred. Pole buildings, which incorporate round timbers as vertical columns and cantilever supports, require preservative-treated wood. Preservative-treated poles for this use may not be readily available.

Ties

The most important availability consideration for railroad cross ties is quantity. Ties are produced from most native species of timber that yield log lengths >2.4 m (8 ft) with diameters >0.18 m (7 in.). The American Railway Engineering Association (AREA) lists 26 U.S. species that may be

Table 6–9. Circumference taper

Species	Change in circumference per meter (cm)	Change in circumference per foot ^a (in.)
Western redcedar	3.7	0.38
Ponderosa pine	2.4	0.29
Jack, lodgepole, and red pine	2.5	0.30
Southern Pine	2.1	0.25
Douglas-fir, larch	1.7	0.21
Western hemlock	1.7	0.20

^aTaken from ANSI O5.1.

used for ties. Thus, the tie market provides a use for many low-grade hardwood and softwood logs.

Form

Natural growth properties of trees play an important role in their use as structural round timbers. Three important form considerations are cross-sectional dimensions, straightness, and the presence of surface characteristics such as knots.

Poles and Piles

Standards for poles and piles have been written with the assumption that trees have a round cross section with a circumference that decreases linearly with height. Thus, the shape of a pole or pile is often assumed to be that of the frustum of a cone. Actual measurements of tree shape indicate that taper is rarely linear and often varies with location along the height of the tree. Average taper values from the ANSI O5.1 standard are shown in Table 6–9 for the more popular pole species. Guidelines to account for the effect of taper on the location of the critical section above the groundline are given in ANSI O5.1. The standard also tabulates pole dimensions for up to 15 size classes of 11 major pole species.

Taper also affects construction detailing of pole buildings. Where siding or other exterior covering is applied, poles are generally set with the taper to the interior side of the structures to provide a vertical exterior surface (Fig. 6–6).

Another common practice is to modify the round poles by slabbing to provide a continuous flat face. The slabbed face permits more secure attachment of sheathing and framing members and facilitates the alignment and setting of intermediate wall and corner poles. The slabbing consists of a minimum cut to provide a single continuous flat face from the groundline to the top of intermediate wall poles and two continuous flat faces at right angles to one another from the groundline to the top of corner poles. However, preservative penetration is generally limited to the sapwood of most species; therefore slabbing, particularly in the groundline area of poles with thin sapwood, may result in somewhat less protection than that of an unslabbed pole. All cutting and sawing should be confined to that portion of the pole above the groundline and should be performed before treatment.

The ASTM International (formerly American Society for Testing and Materials) standard ASTM D 25 provides tables of pile sizes for either friction piles or end-bearing piles. Friction piles rely on skin friction rather than tip area for support, whereas end-bearing piles resist compressive force at the tip. For this reason, a friction pile is specified by butt circumference and may have a smaller tip than an end-bearing pile. Conversely, end-bearing piles are specified by tip area and butt circumference is minimized.

Straightness of poles or piles is determined by two form properties: sweep and crook. Sweep is a measure of bow or gradual deviation from a straight line joining the ends of the pole or pile. Crook is an abrupt change in direction of the centroidal axis. Limits on these two properties are specified in both ANSI O5.1 and ASTM D 25.

Construction Logs

Logs used in construction are generally specified to meet the same criteria for straightness and knots as poles and piles (ASTM D 25). For log stringer bridges, the log selection criteria may vary with the experience of the person doing the selection, but straightness, spiral grain, wind shake, and knots are limiting criteria. Although no consensus standard is available for specifying and designing log stringers, the *Design Guide for Native Log Stringer Bridges* was prepared by the U.S. Forest Service.

Logs used for log cabins come in a wide variety of cross-sectional shapes (Fig. 6–7). Commercial cabin logs are usually milled so that their shape is uniform along their length. The ASTM D 3957 standard, a guide for establishing stress grades for building logs, recommends stress grading on the basis of the largest rectangular section that can be inscribed totally within the log section. The standard also provides commentary on the effects of knots and slope of grain.

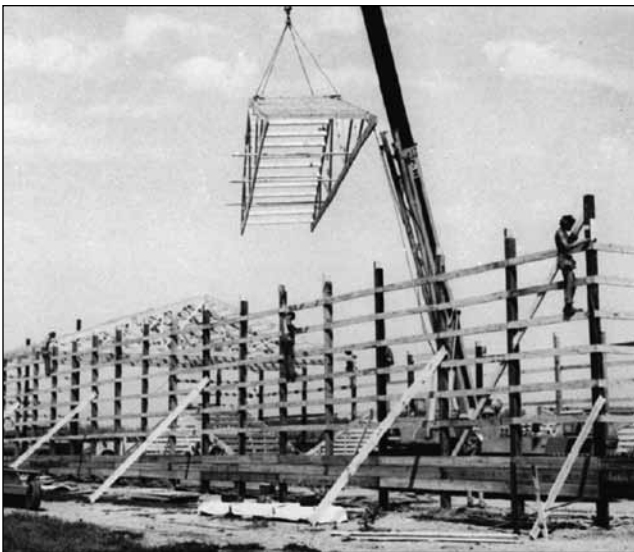

Figure 6–6. Poles provide economical foundation and wall systems for agricultural and storage buildings.

Ties

Railroad ties are commonly shaped to a fairly uniform section along their length. The American Railway Engineering Association (AREA) publishes specifications for the sizes, which include seven size classes ranging from 0.13 by 0.13 m (5 by 5 in.) to 0.18 by 0.25 m (7 by 10 in.). These tie classes may be ordered in any of three standard lengths: 2.4 m (8 ft), 2.6 m (8.5 ft), or 2.7 m (9 ft).

Weight and Volume

The weight of any wood product is a function of its volume, density, moisture content, and any retained treatment substance. An accurate estimate of volume of a round pole would require numerous measurements of the circumference and shape along the length, because poles commonly exhibit neither a uniform linear taper nor a perfectly round shape. The American Wood Protection Association (AWPA) Factor 3 section therefore recommends volume estimates be based on the assumption that the pole is shaped as the frustum of a cone (that is, a cone with the top cut perpendicular to the axis), with adjustments dependent on species. The volume in this case is determined as the average cross-sectional area A times the length. Estimates of average cross-sectional area may be obtained either by measuring the circumference at mid-length ($A = C_m^2/4\pi$) or taking the average of the butt and tip diameters ($A = \pi(D + d)^2/16$) to estimate the area of a circle. The AWPA recommends that these estimates then be adjusted by the following correction factors for the given species and application:

Oak piles	0.82
Southern Pine piles	0.93
Southern Pine and red pine poles	0.95

Tables for round timber volume are given in AWPA Factor 3 tables. The volume of a round timber differs little whether it is green or dry. Drying of round timbers causes checks to open, but there is little reduction of the gross diameter of the pole.

Wood density also differs with species, age, and growing conditions. It will even vary along the height of a single tree. Average values, tabulated by species, are normally expressed as specific gravity (SG), which is density expressed as a ratio of the density of water (see Chap. 5). For commercial species grown in the United States, SG varies from

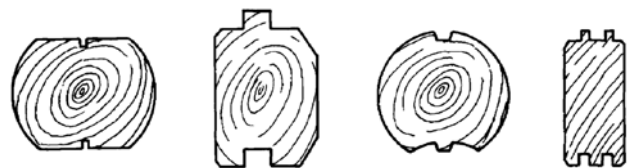

Figure 6–7. Construction logs can be formed in a variety of shapes for log homes. Vertical surfaces may be varied for aesthetic purposes, while the horizontal surfaces generally reflect structural and thermal considerations.

0.32 to 0.65. If you know the green volume of a round timber and its SG, its dry weight is a product of its SG, its volume, and the unit weight of water (1,000 kg m⁻³ (62.4 lb ft⁻³)). Wood moisture content can also be highly variable. A pole cut in the spring when sap is flowing may have a moisture content exceeding 100% (the weight of the water it contains may exceed the weight of the dry wood substance). If you know the moisture content (MC) of the timber, multiply the dry weight by (1 + MC/100) to get the wet weight.

Finally, in estimating the weight of a treated wood product such as a pole, pile, or tie, you must take into account the weight of the preservative. Recommended preservative retentions are listed in Table 15–1 in Chapter 15. By knowing the volume, the preservative weight can be approximated by multiplying volume by the recommended preservative retention. This estimation will err on the side of overestimating preservative weight because the actual retention specifications are based on an outer assay zone and not the entire volume.

Durability

For most applications of round timbers and ties, durability is primarily a question of decay resistance. Some species are noted for their natural decay resistance; however, even these may require preservative treatment, depending upon the environmental conditions under which the material is used and the required service life. For some applications, natural decay resistance is sufficient. This is the case for temporary piles, marine piles in fresh water entirely below the permanent water level, and construction logs used in building construction. Any wood members used in ground contact should be pressure treated, and the first two or three logs above a concrete foundation should be brush treated with a preservative–sealer.

Preservative Treatment

The American Wood Protection Association (AWPA) standards covers the inspection and treatment requirements for various wood products including poles, piles, and ties. Federal Specification TT–W–571 (U.S. Federal Supply Service (USFSS)) is no longer current, and government specifiers now use AWPA standards.) AWPA Standard T1 contains general pressure treatment specifications, Commodity Specification A covers treatment of lumber timbers, Commodity Specification C covers treatment of ties, Commodity Specification D covers pressure and thermal treatment of poles, and Commodity Specification E covers round timber piles. The AREA specifications for cross ties and switch ties also cover preservative treatment. Retention and types of various preservatives recommended for various applications are given in Table 15–1.

Inspection and treatment of poles in service has been effective in prolonging the useful life of untreated poles and those with inadequate preservative penetration or retention.

The Forest Research Laboratory at Oregon State University has published guidelines for developing an in-service pole maintenance program.

Service Life

Service conditions for round timbers and ties vary from mild for construction logs to severe for cross ties. Construction logs used in log homes may last indefinitely if kept dry and properly protected from insects. Most railroad ties, on the other hand, are continually in ground contact and are subject to mechanical damage.

Poles

The life of poles can vary within wide limits, depending upon properties of the pole, preservative treatments, service conditions, and maintenance practices. In distribution or transmission line supports, however, service life is often limited by obsolescence of the line rather than the physical life of the pole.

It is common to report the average life of untreated or treated poles based on observations over a period of years. These average life values are useful as a rough guide to the service life to be expected from a group of poles, but it should be kept in mind that, within a given group, 60% of the poles will have failed before reaching an age equal to the average life.

Early or premature failure of treated poles can generally be attributed to one or more of three factors: (a) poor penetration and distribution of preservative, (b) an inadequate retention of preservative, or (c) use of a substandard preservative. Properly treated poles can last 50 years or longer.

Western redcedar is one species with a naturally decay-resistant heartwood. If used without treatment, however, the average life is somewhat less than 20 years.

Piles

The expected life of a pile is also determined by treatment and use. Wood that remains completely submerged in water does not decay, although bacteria may cause some degradation; therefore, decay resistance is not necessary in all piles, but it is necessary in any part of the pile that may extend above the permanent water level. When piles that support the foundations of bridges or buildings are to be cut off above the permanent water level, they should be pressure treated to conform to recognized specifications such as AWPA Commodity Specification E. The untreated surfaces exposed at the cutoffs should also be given protection by thoroughly brushing the cut surface with copper naphthenate containing at least 1% elemental copper. A coat of pitch, asphalt, or similar material may then be applied over the creosote and a protective sheet material, such as metal, roofing felt, or saturated fabric, should be fitted over the pile cut-off in accordance with AWPA Standard M4. Correct application and maintenance of these materials are critical in maintaining the integrity of piles.

Chapter 6 Commercial Lumber, Round Timbers, and Ties

Piles driven into earth that is not constantly wet are subject to about the same service conditions as apply to poles but are generally required to last longer. Preservative retention requirements for piles are therefore sometimes greater than for poles (Table 15–1). Piles used in salt water are subject to destruction by marine borers even though they do not decay below the waterline. The most effective practical protection against marine borers has been a treatment first with a waterborne preservative, followed by seasoning with a creosote treatment. Other preservative treatments of marine piles are covered in AWPAs Commodity Specification E and shown in Table 15–2.

Ties

The life of ties in service depends on their ability to resist decay and mechanical destruction. Under sufficiently light traffic, heartwood ties of naturally durable wood, even if of low strength, may give 10 or 15 years of average service without preservative treatment; under heavy traffic without adequate mechanical protection, the same ties might fail in 2 or 3 years. Advances in preservatives and treatment processes, coupled with increasing loads, are shifting the primary cause of tie failure from decay to mechanical damage. Well-treated ties, properly designed to carry intended loads, should last from 25 to 40 years on average. Records on life of treated and untreated ties are occasionally published in the annual proceedings of the AREA and AWPAs.

Commonly Used Lumber, Round Timber, and Tie Abbreviations

The following standard lumber abbreviations are commonly used in contracts and other documents for purchase and sale of lumber.

AAR	Association of American Railroads
AD	air dried
ADF	after deducting freight
AF	alpine fir
ALS	American Lumber Standard
AST	antistain treated; at ship tackle (western softwoods)
AV or avg	Average
AW&L	all widths and lengths
B1S	see EB1S, CB1S, and E&CB1S
B2S	see EB2S, CB2S, and E&CB2S
B&B, B&BTR	B and Better
B&S	beams and stringers
BD	Board
BD FT	board feet
BDL	Bundle
BEV	bevel or beveled
BH	boxed heart
B/L, BL	bill of lading
BM	board measure
BSND	bright sapwood, no defect

BTR	Better
CB	center beaded
CB1S	center bead on one side
CB2S	center bead on two sides
CC	cubical content
cft or cu. ft.	cubic foot or feet
CF	cost and freight
CIF	cost, insurance, and freight
CIFE	cost, insurance, freight, and exchange
CG2E	center groove on two edges
C/L	carload
CLG	ceiling
CLR	clear
CM	center matched
Com	Common
CONST	construction
CS	caulking seam
CSG	casing
CV	center V
CV1S	center V on one side
CV2S	center V on two sides
DB Clg	double-beaded ceiling (E&CB1S)
DB Part	double-beaded partition (E&CB2S)
DET	double end-trimmed
DF	Douglas-fir
DF–L	Douglas-fir plus larch
DIM	dimension
DKG	decking
D/S, DS, D/Sdg	drop siding
D1S, D2S	see S1S and S2S
D&M	dressed and matched
D&CM	dressed and center matched
D&SM	dressed and standard matched
D2S&CM	dressed two sides and center matched
D2S&SM	dressed two sides and standard matched
E	edge
EB1S	edge bead one side
EB2S, SB2S	edge bead on two sides
EE	eased edges
EG	edge (vertical or rift) grain
EM	end matched
EV1S, SV1S	edge V one side
EV2S, SV2S	edge V two sides
E&CB1S	edge and center bead one side
E&CB2S, DB2S, BC&2S	edge and center bead two sides
E&CV1S, DV1S, V&CV1S	edge and center V one side
E&CV2S, DV2S, V&CV2S	edge and center V two sides
ES	Engelmann spruce
$F_b, F_t, F_c, F_v, F_{cx}$	allowable stress (MPa (lb/in ²)) in bending; tension, compression and shear parallel to grain; and in compression perpendicular to grain, respectively
FA	facial area

Fac	factory	NBM	net board measure
FAS	free alongside (vessel)	NOFMA	National Oak Flooring Manufacturers Association
FAS	Firsts and Seconds	No.	number
FAS1F	Firsts and Seconds one face	N1E or N2E	nosed one or two edges
FBM, Ft. BM	feet board measure	Ord	Order
FG	flat or slash grain	PAD	partially air-dried
FJ	finger joint; end-jointed lumber using finger-joint configuration	PAR, Par	paragraph
FLG, Flg	flooring	PART, Part	partition
FOB	free on board (named point)	PAT, Pat	pattern
FOHC	free of heart center	Pcs.	pieces
FOK	free of knots	PE	plain end
FRT, Frt	freight	PET	precision end-trimmed
FT, ft	foot, feet	PP	ponderosa pine
FT. SM	feet surface measure	P&T	posts and timbers
G	girth	P1S, P2S	see S1S and S2S
GM	grade marked	RDM	random
G/R	grooved roofing	REG, Reg	regular
HB, H.B.	hollow back	Rfg.	roofing
HEM	hemlock	RGH, Rgh	rough
H-F	mixed hemlock and fir (Hem–Fir)	R/L, RL	random lengths
Hrt	heart	R/W, RW	random widths
H&M	hit and miss	RES	resawn
H or M	hit or miss	SB1S	single bead one side
IC	incense cedar	SDG, Sdg	siding
IN, in.	inch, inches	S-DRY	surfaced dry; lumber ≤19% moisture content per ALS for softwood
Ind	industrial	SE	square edge
IWP	Idaho white pine	SEL, Sel	Select or Select grade
J&P	joists and planks	SE&S	square edge and sound
JTD	jointed	SG	slash or flat grain
KD	kiln dried	S-GRN	surfaced green; lumber unseasoned, >19% moisture content per ALS for softwood
KDAT	kiln-dried after treatment	SGSSND	sapwood, gum spots and streaks, no defect
L	western larch	SIT. SPR	Sitka spruce
LBR, Lbr	lumber	S/L, SL, S/Lap	shiplap
LCL	less than carload	SM	surface measure
LGR	longer	Specs	specifications
LGTH	length	SP	sugar pine
Lft, Lf	lineal foot, feet	SQ	square
LIN, Lin	lineal	SQRS	squares
LL	longleaf	SRB	stress-rated board
LNG, Lng	lining	STD, Std	standard
LP	lodgepole pine	Std. lgths.	standard lengths
M	thousand	STD. M	standard matched
MBM, MBF, M.BM	thousand (feet) board measure	SS	Sitka spruce
MC, M.C.	moisture content	SSE	sound square edge
MERCH, Merch	merchantable	SSND	sap stain, no defect (stained)
MFMA	Maple Flooring Manufacturers Association	STK	Select tight knot
MG	medium grain or mixed grain	STK	stock
MH	mountain hemlock	STPG	stepping
MLDG, Mldg	moulding	STR, STRUCT	structural
Mft	thousand feet	SYP	Southern Pine
M-S	mixed species	S&E	side and edge (surfaced on)
MSR	machine stress rated	S1E	surfaced one edge
N	nosed	S2E	surfaced two edges

Chapter 6 Commercial Lumber, Round Timbers, and Ties

S1S	surfaced one side
S2S	surfaced two sides
S4S	surfaced four sides
S1S&CM	surfaced one side and center matched
S2S&CM	surfaced two sides and center matched
S4S&CS	surfaced four sides and caulking seam
S1S1E	surfaced one side, one edge
S1S2E	surfaced one side, two edges
S2S1E	surfaced two sides, one edge
S2S&SL	surfaced two sides and shiplapped
S2S&SM	surfaced two sides and standard matched
TBR	timber
T&G	tongued and grooved
TSO	treating service only (nonconforming to standard)
UTIL	utility
VG	vertical (edge) grain
V1S	see EV1S, CV1S, and E&CV1S
V2S	see EV2S, CV2S, and E&CV2S
WC	western cedar
WCH	West Coast hemlock
WCW	West Coast woods
WDR, wdr	wider
WF	white fir
WHAD	worm holes (defect)
WHND	worm holes (no defect)
WT	weight
WTH	width
WRC	western redcedar
WW	white woods (Engelmann spruce, any true firs, any hemlocks, any pines)

NWPCA 2007. Uniform Standard for Wood Pallets. Alexandria, VA: National Wooden Pallet and Container Association. 49 p.

NWPCA 2009. Uniform Standard for Wood Containers. Alexandria, VA: National Wooden Pallet and Container Association. 44 p.

Smith, L. W.; Wood, L. W. 1964. History of yard lumber size standards. Madison, WI: U.S. Department of Agriculture, Forest Service, Forest Products Laboratory. 59 p.

References

ANSI. [Current edition]. ANSI O5.1. Specifications and dimensions for wood poles. New York, NY: American National Standards Institute.

ASTM. [Current edition]. ASTM D 3957. Standard methods for establishing stress grades for structural members used in log buildings. West Conshohocken, PA: ASTM International.

AWPA. [Current edition]. Book of standards (includes standards on pressure and thermal treatment of poles, piles, and ties). American Wood-Preserver's Bureau official quality control standards. Bethesda, MD: American Wood Protection Association.

DOC. [Current edition]. American softwood lumber standard. Voluntary Product Standard PS-20-94. Washington, DC: U.S. Department of Commerce.

Muchmore, F.W. 1977. Design guide for native log stringer bridges. Juneau, AK: U.S. Department of Agriculture, Forest Service, Region 10.

Stress Grades and Design Properties for Lumber, Round Timber, and Ties

David E. Kretschmann, Research General Engineer

Contents

Lumber 7–1

Responsibilities and Standards for Stress Grading 7–2

Visually Graded Structural Lumber 7–3

Machine-Graded Structural Lumber 7–7

Adjustment of Properties for Design Use 7–10

Round Timbers and Ties 7–13

Strength Properties 7–13

Poles 7–13

Piles 7–14

Construction Logs 7–14

Ties 7–14

Literature Cited 7–14

Additional References 7–15

Lumber 7–15

General 7–15

Poles 7–15

Piles 7–16

Construction Logs 7–16

Ties 7–16

Round timbers, ties, and lumber sawn from a log, regardless of species and size, are quite variable in mechanical properties. Pieces may differ in strength by several hundred percent. For simplicity and economy in use, pieces of wood of similar mechanical properties are placed in categories called stress grades, which are characterized by (a) one or more sorting criteria, (b) a set of properties for engineering design, and (c) a unique grade name. The most familiar system is that for lumber. Sorting criteria have also been established for round timbers and ties. This chapter briefly discusses the stress grades and design properties for lumber, round timber, and ties.

Lumber

The U.S. Department of Commerce American Softwood Lumber Standard PS 20 describes sorting criteria for two stress-grading methods and the philosophy of how properties for engineering design are derived. The derived properties are then used in one of two design formats: (a) the load and resistance factor design (LRFD), which is based on a reference strength at the lower 5th percentile 5-min stress (AF&PA [current edition]), or (b) the allowable stress design (ASD), which is based on a design stress at the lower 5th percentile 10-year stress. The properties depend on the particular sorting criteria and on additional factors that are independent of the sorting criteria. Design properties are lower than the average properties of clear, straight-grained wood tabulated in Chapter 5.

From one to six design properties are associated with a stress grade: bending modulus of elasticity for an edgewise loading orientation and stress in tension and compression parallel to the grain, stress in compression perpendicular to the grain, stress in shear parallel to the grain, and extreme fiber stress in bending. As is true of the properties of any structural material, the allowable engineering design properties must be either inferred or measured nondestructively. In wood, the properties are inferred through visual grading criteria, nondestructive measurement such as flatwise bending stiffness or density, or a combination of these properties. These nondestructive tests provide both a sorting criterion and a means of calculating appropriate mechanical properties.

The philosophies contained in this chapter are used by a number of organizations to develop visual and machine stress grades. References are made to exact procedures

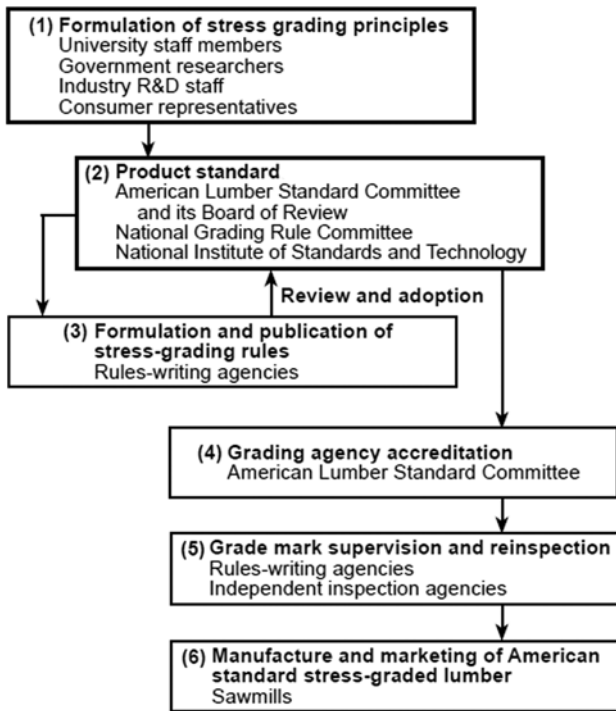

Figure 7–1. Voluntary system of responsibilities for stress grading under the American Softwood Lumber Standard.

and the resulting design stresses, but these are not presented in detail.

Responsibilities and Standards for Stress Grading

An orderly, voluntary, but circuitous system of responsibilities has evolved in the United States for the development, manufacture, and merchandising of most stress-graded lumber. The system is shown schematically in Figure 7–1. Stress-grading principles are developed from research findings and engineering concepts, often within committees and subcommittees of ASTM International (formerly the American Society for Testing and Materials).

American Lumber Standard Committee

Voluntary product standards are developed under procedures published by the U.S. Department of Commerce. The Department of Commerce National Institute of Standards and Technology (NIST), working with rules-writing agencies, lumber inspection agencies, lumber producers, distributors and wholesalers, retailers, end users, members of Federal agencies, and others, works through the American Lumber Standard Committee (ALSC) to maintain a voluntary consensus softwood standard, the American Softwood Lumber Standard (PS 20). The PS 20 Standard prescribes the ways in which stress-grading principles can be used to formulate grading rules designated as conforming to the American Lumber Standard. Under the auspices of the ALSC is the

Table 7–1. Sawn lumber grading agencies^a

Rules-writing agencies

- Northeastern Lumber Manufacturers Association (NeLMA)
- Northern Softwood Lumber Bureau (NSLB)
- Redwood Inspection Service (RIS)
- Southern Pine Inspection Bureau (SPIB)
- West Coast Lumber Inspection Bureau (WCLIB)
- Western Wood Products Association (WWPA)
- National Lumber Grades Authority (NLGA)

Independent agencies

- American Institute of Timber Construction
- Continental Inspection Agency, LLC
- Pacific Lumber Inspection Bureau, Inc.
- Renewable Resource Associates, Inc.
- Stafford Inspection and Consulting, LLC
- Renewable Resource Associates, Inc.
- Timber Products Inspection
- Alberta Forest Products Association
- Canadian Lumbermen’s Association
- Canadian Mill Services Association
- Canadian Softwood Inspection Agency, Inc.
- Central Forest Products Association
- Council of Forest Industries
- MacDonald Inspection
- Maritime Lumber Bureau
- Newfoundland and Labrador Lumber Producers Association
- Quebec Forest Industry Council

^aFor updated information, contact American Lumber Standard Committee, P.O. Box 210, Germantown, MD 20875; alsc@alsc.org; www.alsc.org.

National Grading Rule, which specifies grading characteristics for different grade specifications.

Organizations that write and publish grading rule books containing stress-grade descriptions are called rules-writing agencies. Grading rules that specify American Softwood Lumber Standard PS 20 must be certified by the ALSC Board of Review for conformance with this standard. Organizations that write grading rules, as well as independent agencies, can be accredited by the ALSC Board of Review to provide grading and grade-marking supervision and reinspection services to individual lumber manufacturers. Accredited rules-writing and independent agencies are listed in Table 7–1. The continued accreditation of these organizations is under the scrutiny of the ALSC Board of Review.

Most commercial softwood species lumber manufactured in the United States is stress graded under American Lumber Standard practice and is called American Lumber Standard (ALS) program lumber. Distinctive grade marks for each species or species grouping are provided by accredited agencies. The principles of stress grading are also applied to several hardwood species under provisions of the American Softwood Lumber Standard. Lumber found in the marketplace may be stress graded under grading rules developed in accordance with methods approved by the ALSC or by some other stress-grading rule, or it may not be stress graded. Only those stress grades that meet the requirements of the voluntary American Softwood Lumber Standard system are discussed in this chapter.

National Grading Rule

Stress grading under the auspices of the ALSC is applied to many sizes and patterns of lumber that meet the American Softwood Lumber Standard provision. However, most stress-graded lumber is dimension lumber (standard 38 mm to 89 mm (nominal 2 to 4 in., actual 1.5 to 3.5 in.) thick) and is governed by uniform specifications under the National Grading Rule. The National Grading Rule provides guidelines for writing grading rules for lumber in this thickness range and specifies grading characteristics for different grade specifications. American Softwood Lumber Standard dimension lumber in this thickness range is required to conform to the National Grading Rule, except for special products such as scaffold planks. Grade rules for other sizes, such as structural timbers (standard 114-mm and larger (nominal 5-in. and larger) thick) may vary between rules-writing agencies or species.

The National Grading Rule establishes the lumber classifications and grade names for visually stress-graded dimension lumber (Table 7–2). The ALSC Machine Grading Policy provides for the grading of dimension lumber by a combination of machine and visual methods. Visual requirements for this type of lumber are developed by the respective rules-writing agencies for particular species grades.

Standards

Table 7–2 also shows associated minimum bending strength ratios to provide a comparative index of quality. The strength ratio is the hypothetical ratio of the strength of a piece of lumber with visible strength-reducing growth characteristics to its strength if those characteristics were absent. Formulas for calculating strength ratios are given in ASTM standard D 245. The corresponding visual description of the dimension lumber grades can be found in the grading rule books of the rules-writing agencies listed in Table 7–1. Design properties will vary by size, species, and grade and are published in the appropriate rule books and in the *National Design Specification for Wood Construction* (AF&PA).

Grouping of Species

Most species are grouped together and the lumber from them treated as equivalent. Species are usually grouped when they have about the same mechanical properties, when the wood of two or more species is very similar in appearance, or for marketing convenience. For visual stress grades, ASTM D 2555 contains procedures for calculating clear wood properties for groups of species to be used with ASTM D 245. ASTM D 1990 contains procedures for calculating design properties for groups of species tested as full-sized members. The properties assigned to a group by such procedures will often be different from those of any species that make up the group. The group will have a unique identity, with nomenclature approved by the Board of Review of the ALSC. The identities, properties, and characteristics

Table 7–2. Visual grades described in National Grading Rule

Lumber classification ^a	Grade name	Bending strength ratio (%)
Light framing ^b	Construction	34
	Standard	19
	Utility	9
Structural light framing ^b	Select Structural	67
	1	55
	2	45
	3	26
Stud ^c	Stud	26
Structural joists and planks ^d	Select Structural	65
	1	55
	2	45
	3	26

^aContact rules-writing agencies for additional information.
^bStandard 38 to 89 mm (nominal 2 to 4 in.) thick and wide. Widths narrower than 89 mm (4 in. nominal) may have different strength ratio than shown.
^cStandard 38 to 89 mm (nominal 2 to 4 in.) thick, ≥38 mm (≥4 in. nominal) wide.
^dStandard 38 to 89 mm (nominal 2 to 4 in.) thick, ≥114 mm (≥5 in. nominal) wide.

of individual species of the group are found in the grading rules for any particular species or species grouping. In the case of machine stress grading, the inspection agency that supervises the grading certifies by testing that the design properties in that grade are appropriate for the species or species grouping and the grading process.

Foreign Species

Currently, the importation of structural lumber is governed by two ALSC guidelines that describe the application of the American Lumber Standard and ASTM D 1990 procedures to foreign species. The approval process is outlined in Table 7–3.

Visually Graded Structural Lumber

Visual Sorting Criteria

Visual grading is the original method for stress grading. It is based on the premise that mechanical properties of lumber differ from mechanical properties of clear wood because many growth characteristics affect properties and these characteristics can be seen and judged by eye. Growth characteristics are used to sort lumber into stress grades. The typical visual sorting criteria discussed here are knots, slope of grain, checks and splits, shake, density, decay, annual ring count and percentage latewood, pitch pockets, and wane.

Knots

Knots cause localized cross grain with steep slopes. A very damaging aspect of knots in sawn lumber is that the continuity of the grain around the knot is interrupted by the sawing process.

In general, knots have a greater effect on strength in tension than compression; in bending, the effect depends on whether a knot is in the tension or compression side of a beam (knots along the centerline have little or no effect). Intergrown (or live) knots resist (or transmit) some kinds of stress, but encased knots (unless very tight) or knotholes resist (or transmit) little or no stress. On the other hand, distortion of grain is greater around an intergrown knot than around an encased (or dead) knot of equivalent size. As a result, overall strength effects are roughly equalized, and often no distinction is made in stress grading between intergrown knots, dead knots, and knotholes.

The zone of distorted grain (cross grain) around a knot has less “parallel to piece” stiffness than does straight-grained wood; thus, localized areas of low stiffness are often associated with knots. However, such zones generally constitute only a minor part of the total volume of a piece of lumber. Because overall stiffness of a piece reflects the character of all parts, stiffness is not greatly influenced by knots.

The presence of a knot has a greater effect on most strength properties than on stiffness. The effect on strength depends approximately on the proportion of the cross section of the piece of lumber occupied by the knot, knot location, and distribution of stress in the piece. Limits on knot sizes are therefore made in relation to the width of the face and location on the face in which the knot appears. Compression members are stressed about equally throughout, and no limitation related to location of knots is imposed. In tension, knots along the edge of a member cause an eccentricity that induces bending stresses, and they should therefore be more restricted than knots away from the edge. In simply supported structural members subjected to bending, stresses are greater in the middle of the length and at the top and bottom edges than at midheight. These facts are recognized in some grades by differing limitations on the sizes of knots in different locations.

Knots in glued-laminated structural members are not continuous as in sawn structural lumber, and different methods are used for evaluating their effect on strength (Chap. 12).

Slope of Grain

Slope of grain (cross grain) reduces the mechanical properties of lumber because the fibers are not parallel to the edges. Severely cross-grained pieces are also undesirable because they tend to warp with changes in moisture content. Stresses caused by shrinkage during drying are greater in structural lumber than in small, clear straight-grained specimens and are increased in zones of sloping or distorted grain. To provide a margin of safety, the reduction in design properties resulting from cross grain in visually graded structural lumber is considerably greater than that observed in small, clear specimens that contain similar cross grain.

Table 7–3. Approval process for acceptance of design values for foreign species

1	Rules-writing agency seeks approval to include species in grading rule book.
2	Agency develops sampling and testing plan, following American Lumber Standard Committee (ALSC) foreign importation guidelines, which must then be approved by ALSC Board of Review.
3	Lumber is sampled and tested in accordance with approved sampling and testing plan.
4	Agency analyzes data by ALSC Board of Review, ASTM D 1990 procedures, and other appropriate criteria (if needed).
5	Agency submits proposed design values to ALSC Board of Review.
6	Submission is reviewed by ALSC Board of Review and USDA Forest Service, Forest Products Laboratory.
7	Submission is available for comment by other agencies and interested parties.
8	ALSC Board of Review approves (or disapproves) design values, with modification (if needed) based on all available information.
9	Agency publishes new design values for species.

Checks and Splits

Checks are separations of the wood that normally occur across or through the annual rings, usually as a result of seasoning. Splits are a separation of the wood through the piece to the opposite surface or to an adjoining surface caused by tearing apart of the wood cells. As opposed to shakes, checks and splits are rated by only the area of actual opening. An end-split is considered equal to an end-check that extends through the full thickness of the piece. The effects of checks and splits on strength and the principles of their limitation are the same as those for shake.

Shake

Shake is a separation or a weakness of fiber bond, between or through the annual rings, that is presumed to extend lengthwise without limit. Because shake reduces resistance to shear in members subjected to bending, grading rules therefore restrict shake most closely in those parts of a bending member where shear stresses are highest. In members with limited cross grain, which are subjected only to tension or compression, shake does not affect strength greatly. Shake may be limited in a grade because of appearance and because it permits entrance of moisture, which results in decay.

Density

Strength is related to the mass per unit volume (density) of clear wood. Properties assigned to lumber are sometimes modified by using the rate of growth and percentage of latewood as measures of density. Typically, selection for density requires that the rings per unit length on the cross section and the percentage of latewood be within a specified range. Some very low-strength pieces may be excluded

from a grade by excluding those that are exceptionally low in density.

Decay

Decay in most forms should be prohibited or severely restricted in stress grades because the extent of decay is difficult to determine and its effect on strength is often greater than visual observation would indicate. Decay of the pocket type (for example, *Fomes pini*) can be permitted to some extent in stress grades, as can decay that occurs in knots but does not extend into the surrounding wood.

Heartwood and Sapwood

Heartwood does not need to be taken into account in stress grading because heartwood and sapwood have been assumed to have equal mechanical properties. However, heartwood is sometimes specified in a visual grade because the heartwood of some species is more resistant to decay than is the sapwood; heartwood may be required if untreated wood will be exposed to a decay hazard. On the other hand, sapwood takes preservative treatment more readily than heartwood and it is preferable for lumber that will be treated with preservatives.

Pitch Pockets

Pitch pockets ordinarily have so little effect on structural lumber that they can be disregarded in stress grading if they are small and limited in number. The presence of a large number of pitch pockets, however, may indicate shake or weakness of bond between annual rings.

Wane

Wane refers to bark or lack of wood on the edge or corner of a piece of lumber, regardless of cause (except manufactured eased edges). Requirements of appearance, fabrication, or ample bearing or nailing surfaces generally impose stricter limitations on wane than does strength. Wane is therefore limited in structural lumber on that basis.

Procedures for Deriving Design Properties

The mechanical properties of visually graded lumber may be established by (a) tests of a representative sample of full-size members (ASTM D 1990 in-grade testing procedure) or (b) appropriate modification of test results conducted on clear specimens (ASTM D 245 procedure for small clear wood). Design properties for the major commercial softwood dimension lumber species given in current design specification and codes in the United States have been derived from full-size member test results. However, design properties for some species of softwood and most species of hardwood dimension lumber (standard 38- to 89-mm (nominal 2- to 4-in.) thick) and all species of structural timbers (standard 114-mm and larger (nominal 5-in. and larger) thick) are still derived using results of tests on small clear samples.

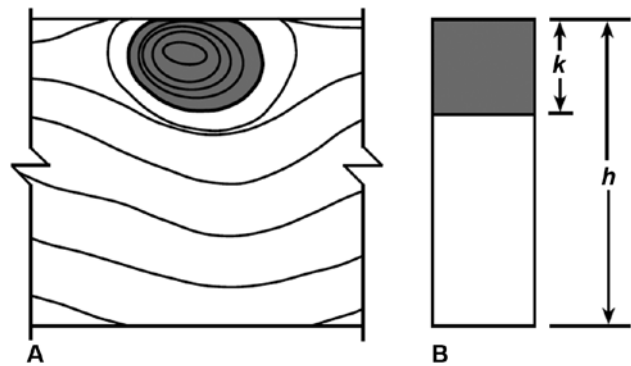

Figure 7-2. Effect of edge knot: A, edge knot in lumber; B, assumed loss of cross section (cross-hatched area).

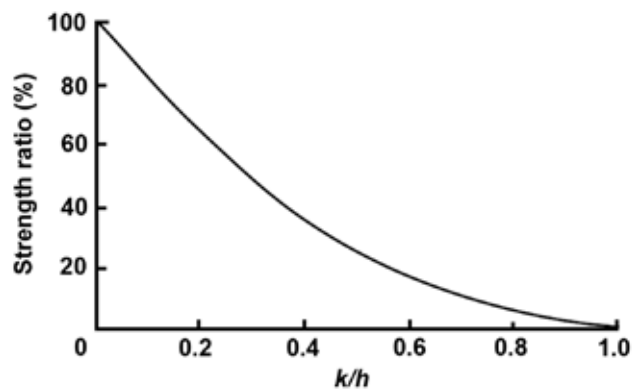

Figure 7-3. Relation between bending strength ratio and size of edge knot expressed as fraction of face width. *k* is knot size; *h*, width of face containing the knot.

Procedure for Clear Wood

The derivation of mechanical properties of visually graded lumber was historically based on clear wood properties with appropriate modifications for the lumber characteristics allowed by visual sorting criteria. Sorting criteria that influence mechanical properties are handled with “strength ratios” for the strength properties and with “quality factors” for the modulus of elasticity.

Piece to piece variation occurs in both the clear wood properties and the occurrence of growth characteristics. The influence of this variability on lumber properties is handled differently for strength properties than for modulus of elasticity.

Strength Properties—Each strength property of a piece of lumber is derived from the product of the clear wood strength for the species and the limiting strength ratio. The strength ratio is the hypothetical ratio of the strength of a piece of lumber with visible strength-reducing growth characteristics to its strength if those characteristics were absent. The true strength ratio of a piece of lumber is never known

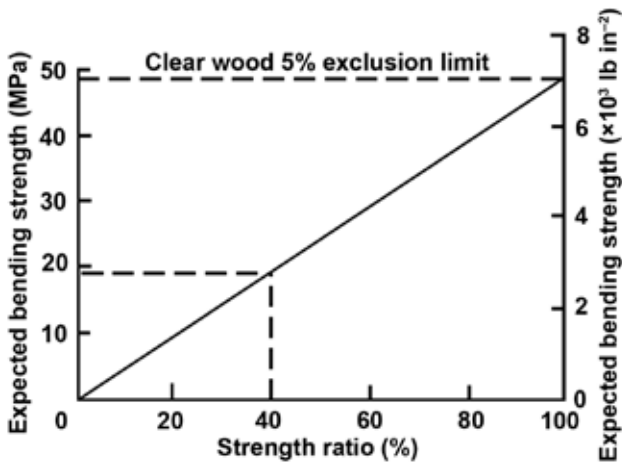

Figure 7–4. Example of relation between strength and strength ratio.

and must be estimated. Therefore, the strength ratio assigned to a growth characteristic serves as a predictor of lumber strength. Strength ratio is expressed as a percentage, ranging from 0 to 100.

Estimated strength ratios for cross grain and density have been obtained empirically; strength ratios for other growth characteristics have been derived theoretically. For example, to account for the weakening effect of knots, the assumption is made that the knot is effectively a hole through the piece, reducing the cross section, as shown in Figure 7–2. For a beam containing an edge knot, the bending strength ratio can be idealized as the ratio of the bending moment that can be resisted by a beam with a reduced cross section to that of a beam with a full cross section:

$$SR = \left(1 - \frac{k}{h}\right)^2$$

where SR is strength ratio, k knot size, and h width of face containing the knot. This is the basic expression for the effect of a knot at the edge of the vertical face of a beam that is deflected vertically. Figure 7–3 shows how strength ratio changes with knot size according to the formula.

Strength ratios for all knots, shakes, checks, and splits are derived using similar concepts. Strength ratio formulas are given in ASTM D 245. The same reference contains guidelines for measuring various growth characteristics.

An individual piece of lumber will often have several characteristics that can affect any particular strength property. Only the characteristic that gives the lowest strength ratio is used to derive the estimated strength of the piece. In theory, a visual stress grade contains lumber ranging from pieces with the minimum strength ratio permitted in the grade up to pieces with the strength ratio just below the next higher grade. In practice, there are often pieces in a grade with strength ratios of a higher grade. This is a result of grade reduction for appearance factors such as wane that do not affect strength.

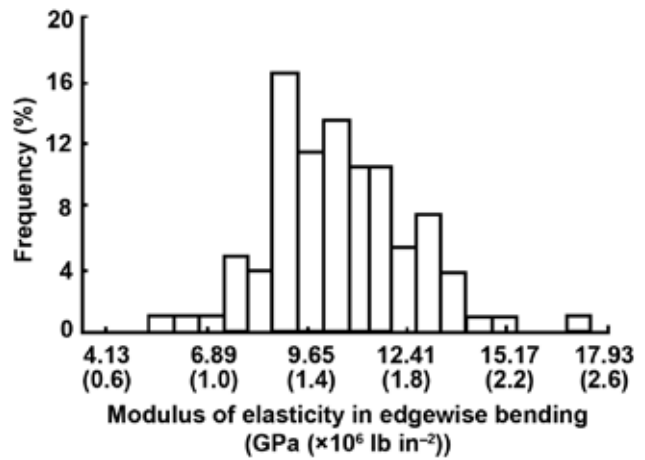

Figure 7–5. Histogram of modulus of elasticity observed in a single visual grade, from pieces selected over a broad geographical range.

The range of strength ratios in a grade and the natural variation in clear wood strength give rise to variation in strength between pieces in the grade. To account for this variation and to ensure safety in design, it is intended that the actual strength of at least 95% of the pieces in a grade exceed the design properties (before reduction for duration of load and safety) assigned to that grade. In visual grading, according to ASTM D 245, this is handled by using a near-minimum clear wood strength as a base value and multiplying it by the minimum strength ratio permitted in the grade to obtain the grade strength property. The near-minimum value is called the 5% exclusion limit. ASTM D 2555 provides clear wood strength data and gives a method for estimating the 5% exclusion limit.

For example, suppose a 5% exclusion limit for the clear wood bending strength of a species in the green condition is 48 MPa (7,000 lb in^{–2}). Suppose also that among the characteristics allowed in a grade of lumber, one characteristic (a knot, for example) provides the lowest strength ratio in bending—assumed in this example as 40%. Using the numbers, the bending strength for the grade is estimated by multiplying the strength ratio (0.40) by 48 MPa (7,000 lb in^{–2}), equaling 19 MPa (2,800 lb in^{–2}) (Fig. 7–4). The bending strength in the green condition of 95% of the pieces in this species in a grade that has a strength ratio of 40% is expected to be ≥19 MPa (≥2,800 lb in^{–2}). Similar procedures are followed for other strength properties, using the appropriate clear wood property value and strength ratio. Additional multiplying factors are then applied to produce properties for design, as summarized later in this chapter.

Modulus of Elasticity—Modulus of elasticity E is a measure of the ability of a beam to resist deflection or of a column to resist buckling. The assigned E is an estimate of the average modulus, adjusted for shear deflection, of the lumber grade when tested in static bending. The average modulus of elasticity for clear wood of the species, as recorded in ASTM D 2555, is used as a base. The clear wood average is

Table 7–4. Common grades for machine-graded lumber^a

Grade name	F_b (MPa (lb in ⁻²))	E (GPa ($\times 10^6$ lb in ⁻²))	F_t (MPa (lb in ⁻²))	F_{cl} (MPa (lb in ⁻²))
MSR				
1350f–1.3E	9.3 (1,350)	9.0 (1.3)	5.2 (750)	11.0 (1,600)
1450f–1.3E	10.0 (1,450)	9.0 (1.3)	5.5 (800)	11.2 (1,625)
1650f–1.5E	11.4 (1,650)	10.3 (1.5)	7.0 (1,020)	11.7 (1,700)
1800f–1.6E	12.4 (1,800)	11.0 (1.6)	8.1 (1,175)	12.1 (1,750)
1950f–1.7E	13.4 (1,950)	11.7 (1.7)	9.5 (1,375)	12.4 (1,800)
2100f–1.8E	14.5 (2,100)	12.4 (1.8)	10.9 (1,575)	12.9 (1,875)
2250f–1.9E	15.5 (2,250)	13.1 (1.9)	12.1 (1,750)	13.3 (1,925)
2400f–2.0E	16.5 (2,400)	13.8 (2.0)	13.3 (1,925)	13.6 (1,975)
2550f–2.1E	17.6 (2,550)	14.5 (2.1)	14.1 (2,050)	14.0 (2,025)
2700f–2.2E	18.6 (2,700)	15.2 (2.2)	14.8 (2,150)	14.4 (2,100)
2850f–2.3E	19.7 (2,850)	15.9 (2.3)	15.9 (2,300)	14.8 (2,150)
MEL				
M–10	9.7 (1,400)	8.3 (1.2)	5.5 (800)	11.0 (1,600)
M–11	10.7 (1,550)	10.3 (1.5)	5.9 (850)	11.5 (1,675)
M–14	12.4 (1,800)	11.7 (1.7)	6.9 (1,000)	12.1 (1,750)
M–19	13.8 (2,000)	11.0 (1.6)	9.0 (1,300)	12.6 (1,825)
M–21	15.9 (2,300)	13.1 (1.9)	9.7 (1,400)	13.4 (1,950)
M–23	16.5 (2,400)	12.4 (1.8)	13.1 (1,900)	13.6 (1,975)
M–24	18.6 (2,700)	13.1 (1.9)	12.4 (1,800)	14.5 (2,100)

^aForest Products Society (1997). Other grades are available and permitted.

F_b is allowable 10-year load duration bending stress parallel to grain.

E is modulus of elasticity.

F_t is allowable 10-year load duration tensile stress parallel to grain.

F_{cl} is allowable 10-year load duration compressive stress parallel to grain.

multiplied by empirically derived “quality factors” to represent the reduction in modulus of elasticity that occurs by lumber grade for pieces tested in an edgewise orientation. This procedure is outlined in ASTM D 245.

For example, assume a clear wood average modulus of elasticity of 12.4 GPa (1.8×10^6 lb in⁻²) for the example shown earlier. The limiting bending strength ratio was 40%. ASTM D 245 assigns a quality multiplying factor of 0.80 for lumber with this bending strength ratio. The modulus of elasticity for that grade would be the product of the clear wood modulus and the quality factor; that is, $12.4 \times 0.8 = 9.9$ GPa ($1.8 \times 0.8 = 1.44 \times 10^6$ lb in⁻²).

Actual modulus of elasticity of individual pieces of a grade varies from the average assumed for design (Fig. 7–5). Small individual lots of lumber can be expected to deviate from the distribution shown by this histogram. The additional multiplying factors used to derive final design values of modulus of elasticity are discussed later in this chapter.

In-Grade Procedure

To establish the mechanical properties of specified grades of lumber from tests of full-size specimens, a representative sample of the lumber population is obtained following procedures in ASTM D 2915 and D 1990. The specimens are tested using appropriate procedures given in ASTM D 198 or D 4761. Because the range of quality with any one specific grade may be large, it is necessary to assess the grade quality index (GQI) of the sampled material in relation to the assumed GQI. In the North American In-Grade

Program, GQI was the strength ratio calculated according to formulas in ASTM D 245. The sample GQI and the assumed GQI are compared to see if adjustment to the test data is necessary. An average value for the edgewise modulus of elasticity or a near-minimum estimate of strength properties is obtained using ASTM D 1990 procedures. The grade GQI is also used as a scaling parameter that allows for modeling of strength and modulus of elasticity with respect to grade. These properties are further modified for design use by consideration of service moisture content, duration of load, and safety.

Machine-Graded Structural Lumber

Machine-graded lumber is lumber evaluated by a machine using a nondestructive test followed by visual grading to evaluate certain characteristics that the machine cannot or may not properly evaluate. Machine-stress-rated (MSR) lumber and machine-evaluated-lumber (MEL) are two types of machine-graded lumber used in North America. MSR is lumber that has modulus of elasticity E evaluated by mechanical stress equipment, with each piece being marked to indicate the modulus of elasticity E . MEL is lumber that has a parameter, often density, nondestructively evaluated by mechanical grading equipment approved by the ALSC Board of Review to predict certain mechanical properties. The MEL machine evaluates each piece and sorts each piece into various strength classification grade categories. Machine-graded lumber allows for better sorting of material for specific applications in engineered structures. The basic components of a machine-grading system are as follows:

- Sorting and prediction of strength through machine-measured nondestructive determination of properties coupled with visual assessment of growth characteristics
- Assignment of design properties based on strength prediction
- Quality control to ensure that assigned properties are being obtained

The quality control procedures ensure

- proper operation of the machine used to make the nondestructive measurements,
- appropriateness of the predictive parameter–bending strength relationship, and
- appropriateness of properties assigned for tension and compression.

The MSR and MEL systems differ in grade names, quality control, and coefficient of variation (COV) for E values. Grade names for MSR lumber are a combination of the design bending stress and average modulus of elasticity, whereas grade names for MEL lumber start with an M designation. For quality control, MSR requires pieces to be tested daily for at least one strength property and bending modulus of elasticity in an edgewise orientation, whereas MEL requires daily tension quality control and edgewise bending strength and stiffness testing. Finally, MSR grades are assigned a COV = 11% on E , whereas MEL grades are assigned a COV \leq 15% on E . Grade names for a wide range of machine-graded lumber commonly available across North America are given in Table 7–4. Not all grades are available in all sizes or species.

Machine Sorting Criteria

The most common method of sorting machine-graded lumber is modulus of elasticity E . When used as a sorting criterion for mechanical properties of lumber, E can be measured in a variety of ways. Usually, the apparent E , or deflection related to stiffness, is actually measured. Because lumber is heterogeneous, the apparent E depends on span, orientation (edgewise or flatwise in bending), load speed of test (static or dynamic), and method of loading (tension, bending, concentrated, or uniform). Any of the apparent E values can be used, as long as the grading machine is properly calibrated, to assign the graded piece to a “not to exceed” grade category. Most grading machines in the United States are designed to detect the lowest flatwise bending E that occurs in any approximately 1.2-m (4-ft) span and the average flatwise E for the entire length of the piece.

Another method of sorting machine-graded lumber is using density measurements to estimate knot sizes and frequency. X-ray sources in conjunction with a series of detectors are used to determine density information. Density information is then used to assign the graded piece to a “not to exceed” grade category.

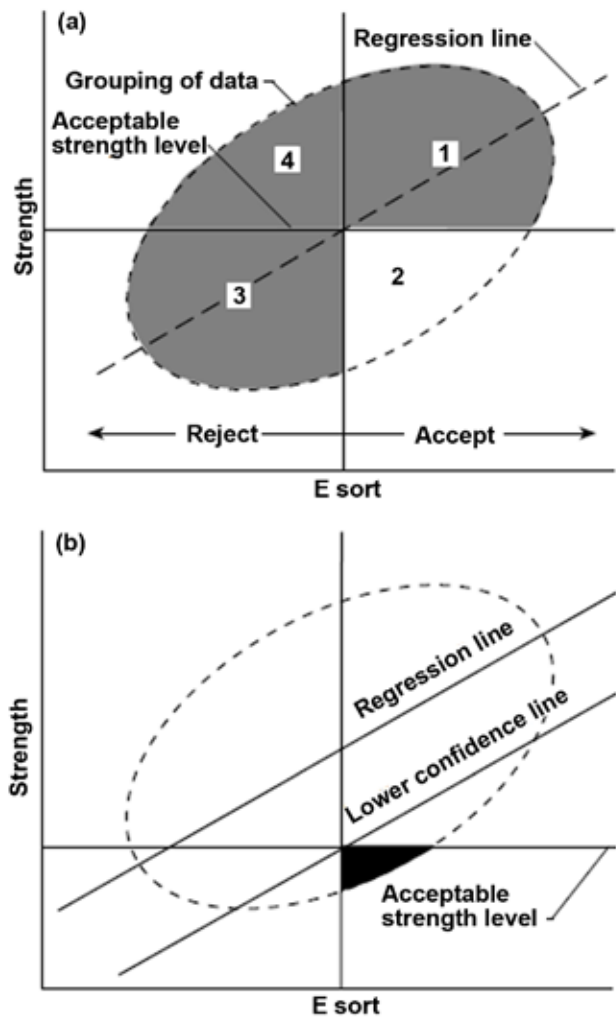

Figure 7–6. Schematic E sort: (a) using a regression line as the predictor showing four categories: 1—accepted correctly; 2—accepted incorrectly; 3—rejected correctly; and 4—rejected correctly; (b) using a lower confidence line as the predictor and showing the relatively low proportion of material in the accepted incorrectly category (lower right).

In the United States and Canada, MSR and MEL lumber are also subjected to a visual assessment because the size of edge knots in combination with E is a better predictor of strength than is E alone. Maximum edge knots are limited to a specified proportion of the cross section, depending on grade level. Other visual restrictions, which are primarily appearance rather than strength criteria, are placed on checks, shake, skips (portions of board “skipped” by the planer), splits, wane, and warp.

Procedures for Deriving Design Properties

Mechanical properties of machine-graded structural lumber may be established using ASTM D 6570.

Allowable Stress for Bending

A stress grade derived for machine-graded lumber relates design strength to a nondestructive parameter such as E or

density. For this example, it will be considered to be E . Because E is an imperfect predictor of strength, lumber sorted solely by average E falls into one of four categories, one of which is sorted correctly and three incorrectly (Fig. 7-6).

Consider, for example, the simplest case (sometimes referred to as “go” or “no go”) where lumber is sorted into two groups: one with sufficient strength and stiffness for a specific application, the other without. In Figure 7-6a, a regression line relating E and strength is used as the prediction model. The “accept–reject” groups identified by the regression sort can be classified into four categories:

- Category 1—Material that has been accepted correctly, that is, pieces have sufficient strength and stiffness as defined
- Category 2—Material that has been accepted incorrectly, that is, pieces do not have sufficient strength
- Category 3—Material that has been rejected correctly because it does not have sufficient strength
- Category 4—Material that has been rejected correctly because it does not have sufficient stiffness

Thus, the sort shown in Figure 7-6a has worked correctly for categories 1, 3, and 4 but incorrectly for category 2. Pieces in category 2 present a problem. These pieces are accepted as having sufficient strength but in reality they do not, and they are mixed with the accepted pieces of category 1. The number of problem pieces that fall in category 2 depends on the variability in the prediction model.

To minimize the material that falls into category 2, adjustments are made to the property assignment claims made about the sorted material. An appropriate model is one that minimizes the material in category 2 or at least reduces it to a lower risk level. Additional grading criteria (edge-knot limitations, for example) are also added to improve the efficiency of the sorting system relative to the resource and the claimed properties.

Commonly, a lower confidence line is used as the prediction model (Fig. 7-6b). The number of pieces that fall into category 2 is now low compared with the regression line model. Furthermore, the probability of a piece (and thus the number of pieces) falling into category 2 is controlled by the confidence line selected.

In actual MSR systems, the lumber is sorted (graded) into E classes. In the United States and Canada, the number of grades has increased as specific market needs have developed for MSR lumber. Today, individual grading agencies list as many as 13 E classifications and more than 20 different grades. The grades are designated by the recommended extreme fiber stress in bending F_b and edgewise modulus of elasticity E . For example, “2100F-1.8E” designates an MSR grade with a design stress $F_b = 14$ MPa (2,100 lb in⁻²) and $E = 12.4$ GPa (1.8 × 10⁶ lb in⁻²).

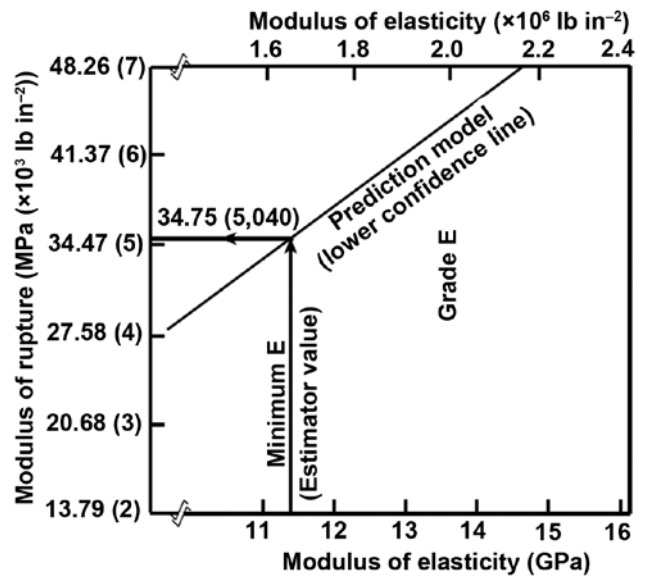

Figure 7-7. Typical assignment of F_b - E values for MSR lumber in United States (solid lines are minimum E for the F_b - E classification and bending strengths predicted by minimum E values).

In theory, any F - E combination can be marketed that can be supported by test data. In practice, a mill will usually produce only a few of the possible existing F - E classifications depending on the potential of the timber being harvested, mill production capabilities, and product or market demand. When a mill has determined the grades it would like to produce (based on their lumber resource and marketing issues), grade boundary machine settings are used to separate the lumber into F - E classifications. A qualification sample of lumber is tested by a grading agency for strength and stiffness, to verify that the proper machine settings are being used. After initial qualification, additional quality control tests are performed during production.

Figure 7-7 illustrates how F_b - E classifications have been developed historically for species groups. Data for a particular species group are collected, the relationship of E and modulus of rupture (MOR) is evaluated, and a lower confidence line is established for the species, as illustrated in Figure 7-6b. Using the lower confidence line of this relationship, a MOR value corresponding to the “minimum E ” assigned to the grade is determined. The “minimum E ” assigned to the grade represents the 5th percentile of the E distribution. The 5th percentile value is expected to be exceeded by 95% of the pieces in a grade or class. In this example, for a grade with an assigned E of 13.8 GPa (2.0 × 10⁶ lb in⁻²), the “minimum E ” is 11.3 GPa (1.64 × 10⁶ lb in⁻²). The corresponding MOR value from the lower confidence line prediction model, approximately a 5th percentile MOR value, is 34.8 MPa (5.04 × 10³ lb in⁻²). This value is then adjusted by a factor (2.1) for assumed 10-year duration of load and safety to obtain F_b . This factor

applied to an estimated 5th percentile MOR value of 34.8 MPa (5.04×10^3 lb in⁻²) yields an F_b of 16.5 MPa (2.40×10^3 lb in⁻²) for the 2.0E grade; in other words, a 2400f–2.0E MSR grade.

Design Stresses for Other Properties

Properties in tension and compression are commonly developed from relationships with bending rather than estimated directly by the nondestructive parameter E . In Canada and the United States, the relationships between the 5th percentile 10-year bending stress and those in tension and compression are based upon limited lumber testing for the three properties but supported by years of successful experience in construction with visual stress grades of lumber. For tension, it is assumed that the ratio of design bending stress F_b to design tensile stress F_t is between 0.5 and 0.8, depending on the grade, whereas the relationship between F_b and fiber stress in design compressive parallel-to-grain stress F_c is assumed to be

$$F_c = [0.338(2.1F_b) + 2060.7]/1.9$$

Strength in shear parallel to the grain and in compression perpendicular to the grain is poorly related to modulus of elasticity. Therefore, in machine stress grading these properties are assumed to be grade-independent and are assigned the same values as those for visual lumber grades, except when predicted from specific gravity on a mill-by-mill basis. It is permissible to assign higher allowable stress for shear parallel to grain and compression perpendicular to grain to specific grades based on additional specific gravity research.

Quality Control

Quality control procedures are necessary to ensure that stresses assigned by a machine-grading system reflect the actual properties of the lumber graded. These procedures must check for correct machine operation. Verification of the relationships between bending and other properties may also be required by the rules-writing agency, particularly for fiber stress in tension F_t .

Daily or even more frequent calibration of machine operation may be necessary. Depending upon machine principle, calibration may involve operating the machine on a calibration bar of known stiffness, comparing grading machine E values to those obtained on the same pieces of lumber by calibrated laboratory test equipment, determining if machine-predicted density matches a calibration sample density, or in some instances, using two or more procedures. Machine operation should be certified for all sizes of lumber being produced. Machine settings may need to be adjusted to produce the same grade material from different widths.

Quality control procedures of the MSR prediction model (E –bending strength relationship) have been adopted in Canada and the United States. Daily or more frequently, lumber production is representatively sampled and proof-loaded, usually in bending, with supplementary testing in tension. The pieces are proof-loaded to at least twice the

design stress (F_b or F_t) for the assigned F_b – E classification. In bending, the pieces are loaded on a random edge with the maximum-edge defect within the maximum moment area (middle one-third span in third-point loading) or as near to that point as possible. In tension, the pieces are tested with a 2.4-m (8-ft) gauge length.

If the number of pieces in the sample failing the proof-test load indicates a high probability that the population from which the pieces came does not meet the minimum grade criteria, a second sampling and proof test are conducted immediately. If the second sample confirms the results of the first sample, the MSR grading system is declared “out of control” and the operation is shut down to isolate and correct the problem. The lumber that was incorrectly labeled is then correctly labeled.

Cumulative machine calibration records are useful for detecting trends or gradual change in machine operation that might coincide with use and wear of machine parts. The proof-test results are also accumulated. Standard statistical quality control procedures (such as control charts) are used to monitor the production process so that it can be modified as needed in response to change in the timber resource, and to make the output fit the assumed model.

Too many failures in one, or even consecutive, samples do not necessarily indicate that the system is out of control. If the prediction line is based on 95% confidence, it can be expected by chance alone that 1 sample in 20 will not meet the proof-load requirements. One or more out-of-control samples may also represent a temporary aberration in material properties (E –strength relationship). In any event, this situation would call for inspection of the cumulative quality control records for trends to determine if machine adjustment might be needed. A “clean” record (a period when the system does not go out of control) rectifies the evaluation of a system thought to be out of control.

Adjustment of Properties for Design Use

The mechanical properties associated with lumber quality are adjusted to give design unit stresses and a modulus of elasticity suitable for engineering uses. First, a lower confidence level is determined for the material, and this value is then adjusted for shrinkage, size, duration of load, and in ASD, an additional factor of safety. These adjustment factors are discussed in the following text (specific adjustments are given in ASTM D 245 and D 1990).

Shrinkage

As described in Chapter 4, lumber shrinks and swells with changes in moisture content. The amount of dimensional change depends on a number of factors, such as species and ring angle. The American Softwood Lumber Standard PS 20 lists specific shrinkage factors from green to 15% moisture content that were used historically to set green lumber dimensions for most species (2.35% for thickness and 2.80% for width). The standard does provide a means of adjusting

lumber dimensions to other moisture content by recognizing an allowance of a tolerance below or above minimum standard dry sizes on a basis of 1% shrinkage or expansion for each 4% change in moisture content. (See sections 6.2.3.1 and 6.2.5.1 of PS 20 for additional information.) The standard also provides specific shrinkage factors for species such as redwood and the cedars, which shrink less than most species. Using the PS 20 recommendations and an assumed green moisture content M_g , we derive equations that can be used with most species to calculate the shrinkage of lumber as a function of percentage moisture content M . The equation is applicable to lumber of all annual ring orientations. For dimension lumber, the dimensions at different moisture contents can be estimated with the following equation:

$$d_2 = d_1 \frac{1 - (a - bM_2) / 100}{1 - (a - bM_1) / 100}$$

where d_1 is dimension (mm, in.) at moisture content M_1 , d_2 dimension (mm, in.) at moisture content M_2 , M_1 moisture content (%) at d_1 , M_2 moisture content (%) at d_2 , and a and b are variables from Table 7-5.

Size Factor

In general, a size effect causes small members to have greater unit strength than that of large members. Two procedures can be used for calculating size-adjustment factors—small clear and In-grade.

Small Clear Procedure

ASTM D 245 provides only a formula for adjusting bending strength. The bending strength for lumber is adjusted to a new depth F_n other than 2 in. (51 mm) using the formula

$$F_n = \left(\frac{d_o}{d_n} \right)^{\frac{1}{9}} F_o$$

where d_o is original depth (51 mm, 2 in.), d_n new depth, and F_o original bending strength.

This formula is based on an assumed center load and a span-to-depth ratio of 14. A depth effect formula for two equal concentrated loads applied symmetrical to the midspan points is given in Chapter 9.

In-Grade Test Procedures

ASTM D 1990 provides a formula for adjusting bending, tension, and compression parallel to grain. No size adjustments are made to modulus of elasticity or for thickness effects in bending, tension, and compression. The size adjustments to dimension lumber are based on volume using the formula

$$P_1 = P_2 \left(\frac{W_1}{W_2} \right)^w \left(\frac{L_1}{L_2} \right)^l$$

where P_1 is property value (MPa, lb in⁻²) at volume 1, P_2 property value (MPa, lb in⁻²) at volume 2, W_1 width (mm,

Table 7-5. Coefficients for equations to determine dimensional changes with moisture content change in dimension lumber

Species	Width		Thickness		M_g^a
	a	b	a	b	
Redwood, western redcedar, and northern white cedar	3.454	0.157	2.816	0.128	22
Other species	6.031	0.215	5.062	0.181	28

^a M_g is assumed green moisture content.

Table 7-6. Exponents for adjustment of dimension lumber mechanical properties with change in size^a

Exponent	MOR	UTS	UCS
w	0.29	0.29	0.13
l	0.14	0.14	0

^aMOR, modulus of rupture; UTS, ultimate tensile stress; and UCS, ultimate compressive parallel-to-grain stress.

in.) at P_1 , W_2 width (mm, in.) at P_2 , L_1 length (mm, in.) at P_1 , and L_2 length (mm, in.) at P_2 . Exponents are defined in Table 7-6.

Moisture Adjustments

For lumber ≤102 mm (≤4 in.) thick that has been dried, strength properties have been shown to be related quadratically to moisture content. Two relationships for modulus of rupture at any moisture content are shown in Figure 7-8. Both models start with the modulus of elasticity of green lumber. The curves with solid dots represent a precise quadratic model fit to experimental results. In typical practice, adjustments are made to correspond to average moisture contents of 15% and 12% with expected maximum moisture contents of 19% and 15%, respectively, using simplified expressions represented by the open dot curves. Below about 8% moisture content, some properties may decrease with decreasing moisture content values, and care should be exercised in these situations. Equations applicable to adjusting properties to other moisture levels between green and 10% moisture content are as follows:

For MOR, ultimate tensile stress (UTS), and ultimate compressive stress (UCS), the following ASTM D 1990 equations apply:

$$\begin{aligned} \text{For MOR} &\leq 16.7 \text{ MPa (2,415 lb in}^{-2}\text{)} \\ \text{UTS} &\leq 21.7 \text{ MPa (3,150 lb in}^{-2}\text{)} \\ \text{UCS} &\leq 9.7 \text{ MPa (1,400 lb in}^{-2}\text{)} \end{aligned}$$

$$P_1 = P_2$$

Thus, there is no adjustment for stresses below these levels.

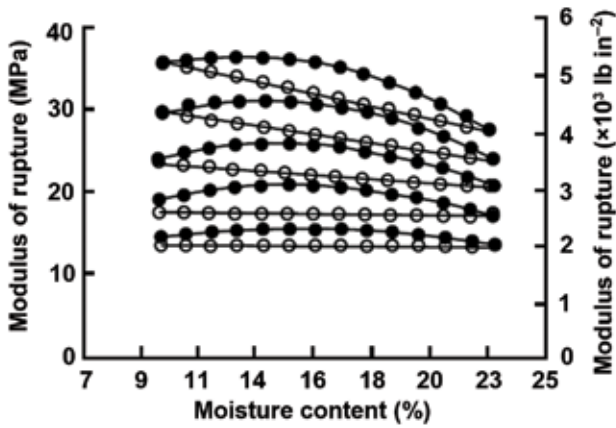

Figure 7-8. Modulus of rupture as a function of moisture content for dimension lumber. Open dots represent the ASTM D 1990 model, and solid dots represent the more precise quadratic surface model on which the ASTM D 1990 model was based.

For MOR > 16.6 MPa (2,415 lb in⁻²)
 UTS > 21.7 MPa (3,150 lb in⁻²)
 UCS > 9.7 MPa (1,400 lb in⁻²)

$$P_2 = P_1 + \left(\frac{P_1 - B_1}{B_2 - M_1} \right) (M_1 - M_2)$$

where M_1 is moisture content 1 (%), M_2 is moisture content 2 (%), and B_1, B_2 are constants from Table 7-7.

For E , the following equation applies:

$$E_1 = E_2 \left(\frac{1.857 - (0.0237M_2)}{1.857 - (0.0237M_1)} \right)$$

where E_1 is property (MPa, lb in⁻²) at moisture content 1 and E_2 is property (MPa, lb in⁻²) at moisture content 2.

For lumber thicker than 102 mm (4 in.), often no adjustment for moisture content is made because properties are assigned on the basis of wood in the green condition. This lumber is usually put in place without drying, and it is assumed that drying degrade offsets the increase in strength normally associated with loss in moisture.

Duration of Load

Design may be based on either design stresses and a duration of load factor or on ultimate limit state design stresses and a time effects factor. Both the duration of load and time effects factor describe the same phenomenon. In allowable

Table 7-7. Coefficients for moisture adjustment of dimension lumber mechanical properties with change in moisture content^a

Coefficients	Property (MPa (lb in ⁻²))		
	MOR	UTS	UCS
B_1	16.6 (2,415)	21.7 (3,150)	9.6 (1,400)
B_2	0.276 (40)	0.552 (80)	0.234 (34)

^aMOR is modulus of rupture; UTS, ultimate tensile stress; and UCS, ultimate compressive parallel-to-grain stress.

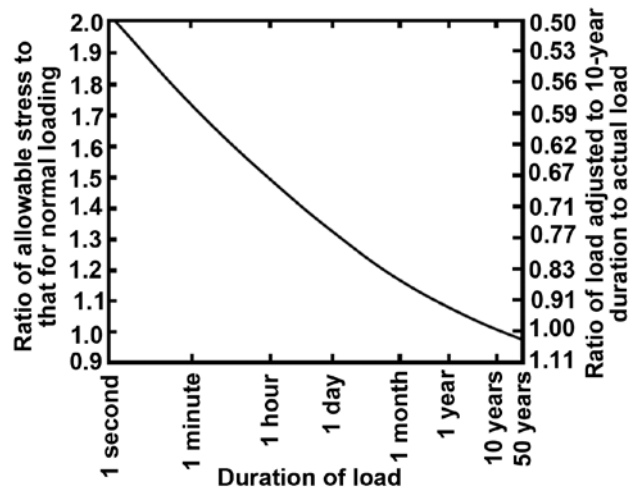

Figure 7-9. Relation of strength to duration of load.

stress design, design stresses are based on an assumed 10-year loading period (called normal loading). If duration of loading, either continuously or cumulatively, is expected to exceed 10 years, design stresses are reduced 10%. If the expected duration of loading is for shorter periods, published design stresses can be increased using Figure 7-9. Ultimate limit-state design stresses are based on a 5-min loading period. If the duration of loading is expected to exceed 5 min, limit-state design stresses are reduced by applying the time effects factor. Intermittent loading causes cumulative effects on strength and should be treated as continuous load of equivalent duration. The effects of cyclic loads of short duration must also be considered in design (see discussion of fatigue in Chap. 5). These duration of load modifications are not applicable to modulus of elasticity.

In many design circumstances, several loads bear on the structure, some acting simultaneously and each with a

Table 7-8. Example of duration of load adjustments for ASD

Time (year)	Total load (kPa (lb ft ⁻²))	Load adjustment ^a	Equivalent 10-year design load (kPa (lb ft ⁻²))
1	4.8 (100) + 0.96 (20) = 5.7 (120)	0.93	5.36 (112)
50	0.96 (20)	1.04	1.0 (21)

^aFigure 7-9.

different duration. When loads of different time duration are applied, the load duration factor corresponding to the shortest time duration is used. Each increment of time during which the total load is constant should be treated separately, and the most severe condition governs the design. Either the design stress or the total design load (but not both) can be adjusted using Figure 7–9.

For example, suppose a structure is expected to support a load of 4.8 kPa (100 lb ft⁻²) on and off for a cumulative duration of 1 year. Also, it is expected to support its own dead load of 0.96 kPa (20 lb ft⁻²) for the anticipated 50-year life of the structure. The adjustments to be made to arrive at an equivalent 10-year design load for ASD are listed in Table 7–8.

The more severe design load is 5.36 kPa (112 lb ft⁻²), and this load and the design stress for lumber would be used to select members of suitable size. In this case, it was convenient to adjust the loads on the structure, although the same result can be obtained by adjusting the design stress.

Treatment Effects

Treatments have been shown to affect the final strength of wood (see Chap. 5 for detailed discussion). There is a 5% reduction in *E* and a 15% reduction in strength properties of incised and treated dimension lumber for both dry- and wet-use conditions in the United States. In Canada, a 10% reduction in *E* and a 30% reduction in all strength properties from incising are applied to dry-use conditions, whereas 5% and 15% reductions are used for wet-use conditions. The wet-use factors are applied in addition to the traditional wet-use service factor. Reductions in energy-related properties are about 1.5 to 2 times those reported for static strength properties. There is no difference in long-term duration of load behavior between treated and untreated material (Fig. 7–10). Current design standards prohibit increases in design stresses beyond the 1.6 factor for short-term duration of load when considering impact-type loading for material treated with waterborne preservative.

Temperature Effects

As wood is cooled below normal temperatures, its properties increase. When heated, its properties decrease. The magnitude of the change depends upon moisture content. Up to 65 °C (150 °F), the effect of temperature is assumed by design codes to be reversible. For structural members that

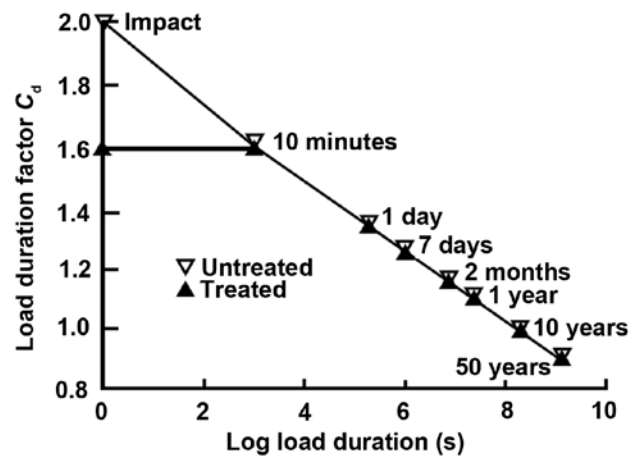

Figure 7–10. Load duration factor for material untreated and treated with waterborne preservative.

will be exposed to temperatures up to 65 °C (150 °F), design values are multiplied by the factors given in Table 7–9 (AF&PA). Prolonged exposure to heat can lead to a permanent loss in strength (see Chap. 5).

Round Timbers and Ties

Strength Properties

Allowable strength properties of round timbers have been developed and published in several standards. In most cases, published values are based on strength of clear test samples. Allowable stresses are derived by adjusting clear test values for effects of growth characteristics, conditioning, shape, and load conditions as discussed in applicable standards. In addition, published values for some species of poles and piles reflect results of full-sized tests.

Poles

Most poles are used as structural members in support structures for distribution and transmission lines. For this application, poles may be designed as single-member or guyed cantilevers or as structural members of a more complex structure. Specifications for wood poles used in single pole structures have been published by the American National Standards Institute (ANSI) in Standard O5.1. Guidelines for the design of pole structures are given in the ANSI National Electric Safety Code (NESC) (ANSI C2).

Table 7–9. Property adjustment factors for in-service temperature exposures

Design values	In-service moisture content	Factor		
		$T \leq 37\text{ }^\circ\text{C}$ ($T \leq 100\text{ }^\circ\text{F}$)	$37\text{ }^\circ\text{C} < T \leq 52\text{ }^\circ\text{C}$ ($100\text{ }^\circ\text{F} < T \leq 125\text{ }^\circ\text{F}$)	$52\text{ }^\circ\text{C} < T \leq 65\text{ }^\circ\text{C}$ ($125\text{ }^\circ\text{F} < T \leq 150\text{ }^\circ\text{F}$)
F_t, E	Wet or dry	1.0	0.9	0.9
$F_b, F_v, F_c, F_{c\perp}$	Dry	1.0	0.8	0.7
	Wet	1.0	0.7	0.5

The ANSI O5.1 standard gives values for fiber stress in bending for species commonly used as transmission or distribution poles. These values represent the near-ultimate fiber stress for poles used as cantilever beams. For most species, these values are based partly on full-sized pole tests and include adjustments for moisture content and pretreatment conditioning. The values in ANSI O5.1 are compatible with the ultimate strength design philosophy of the NESC, but they are not compatible with the working stress design philosophy of the *National Design Specification* (NDS).

Reliability-based design techniques have been developed for the design of distribution–transmission line systems. This approach requires a strong database on the performance of pole structures. Supporting information for these design procedures is available in a series of reports published by the Electric Power Research Institute (EPRI).

Piles

Bearing loads on piles are sustained by earth friction along their surface (skin friction) or by bearing of the tip on a solid stratum. Wood piles, because of their tapered form, are particularly efficient in supporting loads by skin friction. Bearing values that depend upon friction are related to the stability of the soil and generally do not approach the ultimate strength of the pile. Where wood piles sustain foundation loads by bearing of the tip on a solid stratum, loads may be limited by the compressive strength of the wood parallel to the grain. If a large proportion of the length of a pile extends above ground, its bearing value may be limited by its strength as a long column. Side loads may also be applied to piles extending above ground. In such instances, however, bracing is often used to reduce the unsupported column length or to resist the side loads.

The most critical loads on piles often occur during driving. Under hard driving conditions, piles that are too dry (<18% moisture content at a 51-mm (2-in.) depth) have literally exploded under the force of the driving hammers. Steel banding is recommended to increase resistance to splitting, and driving the piles into predrilled holes reduces driving stresses.

The reduction in strength of a wood column resulting from crooks, eccentric loading, or any other condition that will result in combined bending and compression is not as great as would be predicted with the NDS interaction equations. This does not imply that crooks and eccentricity should be without restriction, but it should relieve anxiety as to the influence of crooks, such as those found in piles. Design procedures for eccentrically loaded columns are given in Chapter 9.

There are several ways to determine bearing capacity of piles. Engineering formulas can estimate bearing values from the penetration under blows of known energy from the driving hammer. Some engineers prefer to estimate bearing capacity from experience or observation of the behavior of

pile foundations under similar conditions or from the results of static-load tests.

Working stresses for piles are governed by building code requirements and by recommendations of ASTM D 2899. This standard gives recommendations for adjusting small clear strength values listed in ASTM D 2555 for use in the design of full-sized piles. In addition to adjustments for properties inherent to the full-sized pile, the ASTM D 2899 standard provides recommendations for adjusting allowable stresses for the effects of pretreatment conditioning.

Design stresses for timber piles are tabulated in the NDS for wood construction. The NDS values include adjustments for the effects of moisture content, load duration, and preservative treatment. Recommendations are also given to adjust for lateral support conditions and factors of safety.

Construction Logs

Design values for round timbers used as structural members in pole or log buildings may be determined following standards published by ASTM International. The ASTM standard D 3200 refers pole designers to the same standard used to derive design stresses for timber piles (D 2899). Derivation of design stresses for construction logs used in log homes is covered in ASTM D 3957, which provides a method of establishing stress grades for structural members of any of the more common log configurations. Manufacturers can use this standard to develop grading specifications and derive engineering design stresses for their construction logs.

Ties

Railroad cross and switch ties have historically been over-designed from the standpoint of rail loads. Tie service life was limited largely by deterioration rather than mechanical damage. However, because of advances in decay-inhibiting treatment and increased axle loads, adequate structural design is becoming more important in increasing railroad tie service life.

Rail loads induce stresses in bending and shear as well as in compression perpendicular to the grain in railroad ties. The American Railway Engineering and Maintenance-of-Way Association (AREMA) manual gives recommended limits on ballast bearing pressure and allowable stresses for cross ties. This information may be used by the designer to determine adequate tie size and spacing to avoid premature failure due to mechanical damage.

Specific gravity and compressive strength parallel to the grain are also important properties to consider in evaluating cross tie material. These properties indicate the resistance of the wood to both pull out and lateral thrust of spikes.

Literature Cited

AF&PA. [Current edition]. Washington, DC: American Forest & Paper Association.

Design values for wood construction—a supplement to the national design specification for wood construction.

National design specification for wood construction.

Forest Products Society. 1997. Machine-graded lumber. Madison, WI: Forest Products Society. Wood Design Focus. 8(2): 1–24.

Additional References

Lumber

ALSC. 1995. Germantown, MD: American Lumber Standards Committee.

ASTM. [Current edition]. Section 04—Construction; Volume 10—Wood. West Conshohocken, PA: American Society for Testing and Materials.

ASTM D 198–05a. Standard methods of static tests of timbers in structural sizes.

ASTM D 245–06. Standard methods for establishing structural grades for visually-graded lumber.

ASTM D 1990–07. Standard methods for establishing allowable properties for visually-graded dimension lumber from in-grade tests of full-size specimens.

ASTM D 2555–06. Standard methods for establishing clear wood strength values.

ASTM D 2915–03. Standard practice for evaluating properties for stress grades of structural lumber.

ASTM D 4761–05. Standard test methods for mechanical properties of lumber and wood-base structural materials.

ASTM D 6570–04. Standard practice for assigning allowable properties for mechanically graded lumber.

DOC. [Current edition]. American softwood lumber standard. Voluntary Product Standard PS–20. Washington, DC: U.S. Department of Commerce.

Galligan, W.L.; Green, D.W.; Gromala, D.S.; Haskell, J.H. 1980. Evaluation of lumber properties in the United States and their application to structural research. Forest Products Journal. 30(10): 45–51.

Gerhards, C.C. 1977. Effect of duration and rate of loading on strength of wood and wood-based materials. Res. Pap. FPL–RP–283. Madison, WI: U.S. Department of Agriculture, Forest Service, Forest Products Laboratory. 27 p.

Green, D.W. 1989. Moisture content and the shrinkage of lumber. Res. Pap. FPL–RP–489. Madison, WI: U.S. Department of Agriculture, Forest Service, Forest Products Laboratory. 11 p.

Green, D.W.; Evans, J.W. 1987. Mechanical properties of visually graded dimension lumber. PB–88–159–371.

Springfield, VA: National Technical Information Service. Vol. 1–Vol. 7.

Green, D.W.; Kretschmann, D.E. 1992. Properties and grading of Southern Pine timbers. Forest Products Journal. 47(9): 78–85.

Green, D.W.; Shelley, B.E. 2006. Guidelines for assigning allowable properties to visually graded foreign species. Germantown, MD: Board of Review, American Lumber Standards Committee. 10 p.

Green, D.W.; Shelley, B.E. 2006. Guidelines for assigning allowable properties to mechanically graded foreign species. Germantown, MD: American Lumber Standard Committee. 12 p.

Green, D.W.; Shelley, B.E.; Vokey, H.P. 1989. In-grade testing of structural lumber. In: Proceedings of workshop sponsored by In-grade Testing Committee and Forest Products Society. Proceedings 47363. Madison, WI: Forest Products Society.

Kretschmann, D.E.; Green D.W. 1996. Modeling moisture content–mechanical property relationships for clear Southern Pine. Wood Fiber Science. 28(3): 320–337.

Kretschmann, D.E.; Evans, J.W. 2010. History of lumber submissions under ASTM D 1990 since the North American in-grade testing program. Gen. Tech. Rep. FPL–GTR–189. Madison, WI: U.S. Department of Agriculture, Forest Service. Forest Products Laboratory. 52 p.

Winandy, J.E. 1995. The influence of time-to-failure on the strength of CCA-treated lumber. Forest Products Journal. 45(2): 82–85.

General

AWPA. [Current edition]. Book of standards (includes standards on pressure and thermal treatment of poles, piles, and ties). American Wood-Preserver's Bureau official quality control standards. Bethesda, MD: American Wood Protection Association.

Engineering Data Management and Colorado State University. 1989–1998. International conference—Wood poles and piles. Conference proceedings. Fort Collins, CO: Engineering Data Management and Colorado State University.

USFSS. [Current edition]. Poles and piles, wood. Federal Specification MM–P–371c—ties, railroad (cross and switch); Federal Specification MM–T–371d—wood preservation: treating practice; Federal Specification TT–W–571. Washington, DC: U.S. Federal Supply Service.

Poles

ANSI. [Current edition]. New York, NY: American National Standards Institute.

ANSI O5.1. Specifications and dimensions for wood poles.

ANSI C2. National electrical safety code.

ANSI O5.2. Structural glued laminated timber for utility structures.

ASTM. [Current edition]. West Conshohocken, PA: American Society for Testing and Materials.

ANSI/ASTM D 1036–99. Standard methods of static tests of wood poles.

ASTM D 3200–74. Standard specification and methods for establishing recommended design stresses for round timber construction poles.

Carson, J.M.; Dougherty, M., eds. 1997. Post-frame building handbook: materials, design considerations, construction procedures. Ithaca, NY: Northeast Regional Agricultural Engineering Service. 78 p.

EPRI. 1981. Probability-based design of wood transmission structures. (a) Vol. 1: Strength and stiffness of wood utility poles. (b) Vol. 2: Analysis and probability-based design of wood utility structures. (c) Vol. 3: Users' manual. POLEDA–80. Pole design and analysis. Prepared by: Research Institute of Colorado for Electric Power Research Institute. Palo Alto, CA: Electric Power Research Institute. EL1–2040. Vols. 1–3, Proj. 1352–1. September.

EPRI. 1985. Wood pole properties. Vol. 1: Background and Southern Pine data. Prepared by: Research Institute of Colorado for Electric Power Research Institute. Palo Alto, CA: Electric Power Research Institute. EL–4109. Proj. 1352–2. July.

EPRI. 1986. Wood pole properties. (a) Vol. 2: Douglas-fir data. (b) Vol. 3: Western redcedar. Prepared by: Research Institute of Colorado for Electric Power Research Institute. Palo Alto, CA: Electric Power Research Institute. EL–4109. Proj. 1352–2. January.

Morrell, J.J. 1996. Wood pole maintenance manual. Corvallis, OR: Oregon State University, College of Forestry, Forest Research Laboratory. 47 p.

NRAES. 1997. Post-frame building construction. Ithaca, NY: Northeast Regional Agricultural Engineering Service.

Thompson, W.S. 1969. Effect of steaming and kiln drying on properties of Southern Pine poles. Part I—mechanical properties. *Forest Products Journal*. 19(1): 21–28.

Wood, L.W.; Erickson, E.C.O.; Dohr, A.W. 1960. Strength and related properties of wood poles. Philadelphia, PA: American Society for Testing and Materials. 83 p.

Wood, L.W.; Markwardt, L.J. 1965. Derivation of fiber stresses from strength values of wood poles. Res. Pap. FPL 39. Madison, WI: U.S. Department of Agriculture, Forest Service, Forest Products Laboratory. 12 p.

Piles

AF&PA. [Current edition]. National design specification for wood construction. Washington, DC: American Forest & Paper Association.

AREA. 1982. Timber structures. In: Manual for railway engineering. Washington, DC: American Railway Engineering Association. Chapter 7.

Armstrong, R.M. 1979. Structural properties of timber piles. In: Behavior of deep foundations. ASTM STP670. Philadelphia, PA: American Society for Testing and Materials: 118–152.

ASTM. [Current edition]. West Conshohocken, PA: American Society for Testing and Materials.

ASTM D 25–99. Standard specification for round timber piles.

ASTM D 2899–03. Establishing design stresses for round timber piles.

AWPI. 1969. Pile foundations know-how. Washington, DC: American Wood Preservers Institute.

Thompson, W.S. 1969. Factors affecting the variation in compressive strength of Southern Pine piling. Washington, DC: American Wood-Preservers' Association.

Construction Logs

ASTM. [Current edition]. Standard methods for establishing stress grades for structural members used in log buildings. ASTM D 3957. West Conshohocken, PA: American Society for Testing and Materials.

Muchmore, F.W. 1977. Design guide for native log stringer bridges. Juneau, AK: U.S. Department of Agriculture, Forest Service, Region 10. 12 p.

Rowell, R.M.; Black, J.M.; Gjovik, L.R.; Feist, W.C. 1977. Protecting log cabins from decay. Gen. Tech. Rep. FPL–11. Madison, WI: U.S. Department of Agriculture, Forest Service, Forest Products Laboratory. 16 p.

Ties

AREMA. 2008. Ties. In: Manual for railway engineering. Washington, DC: American Railway Engineering and Maintenance-of-Way Association. Volume 1, Chapter 30.

Fastenings

Douglas R. Rammer, Research General Engineer

Contents

Nails 8–1
Withdrawal Resistance 8–2
Lateral Resistance 8–6
Spikes 8–9
Staples 8–9
Drift Bolts 8–10
Wood Screws 8–10
Withdrawal Resistance 8–10
Lateral Resistance 8–11
Lag Screws 8–12
Withdrawal Resistance 8–12
Lateral Resistance 8–13
Bolts 8–14
Bearing Stress of Wood under Bolts 8–14
Loads at an Angle to the Grain 8–15
Steel Side Plates 8–15
Bolt Quality 8–15
Effect of Member Thickness 8–16
Two Member, Multiple Member Joints 8–16
Spacing, Edge, and End Distance 8–16
Effect of Bolt Holes 8–16
Pre-1991 Allowable Loads 8–17
Post-1991 Yield Model 8–17
Connector Joints 8–19
Parallel-to-Grain Loading 8–19
Perpendicular-to-Grain Loading 8–20
Design Loads 8–20
Modifications 8–21
Net Section 8–23
End Distance and Spacing 8–23
Placement of Multiple Connectors 8–23
Cross Bolts 8–24
Multiple-Fastener Joints 8–24
Metal Plate Connectors 8–25
Joist Hangers 8–25
Fastener Head Embedment 8–26
Literature Cited 8–27
Additional References 8–27

The strength and stability of any structure depend heavily on the fastenings that hold its parts together. One prime advantage of wood as a structural material is the ease with which wood structural parts can be joined together with a wide variety of fastenings—nails, spikes, screws, bolts, lag screws, drift pins, staples, and metal connectors of various types. For utmost rigidity, strength, and service, each type of fastening requires joint designs adapted to the strength properties of wood along and across the grain and to dimensional changes that may occur with changes in moisture content.

Maximum lateral resistance and safe design load values for small-diameter (nails, spikes, and wood screws) and large-diameter dowel-type fasteners (bolts, lag screws, and drift pins) were based on an empirical method prior to 1991. Research conducted during the 1980s resulted in lateral resistance values that are currently based on a yield model theory. This theoretical method was adapted for the 1991 edition of the *National Design Specification for Wood Construction* (NDS). Because literature and design procedures exist that are related to both the empirical and theoretical methods, we refer to the empirical method as pre-1991 and the theoretical method as post-1991 throughout this chapter. Withdrawal resistance methods have not changed, so the pre- and post-1991 refer only to lateral resistance.

The information in this chapter represents primarily Forest Products Laboratory research results. A more comprehensive discussion of fastenings is given in the American Society of Civil Engineers Manuals and Reports on Engineering Practice No. 84, *Mechanical Connections in Wood Structures*. The research results of this chapter are often modified for structural safety, based on judgment or experience, and thus information presented in design documents may differ from information presented in this chapter. Additionally, research by others serves as a basis for some current design criteria. Allowable stress design and limit states design criteria are presented in the *National Design Specification for Wood Construction* published by the American Forest and Paper Association.

Nails

Nails are the most common mechanical fastenings used in wood construction. There are many types, sizes, and forms of nails (Fig. 8–1). Most load equations presented in this section apply for bright, smooth, common steel wire nails driven into wood when there is no visible splitting. For nails other than common wire nails, the loads can be adjusted by factors given later in the chapter.



Figure 8–1. Various types of nails: (left to right) bright smooth wire nail, cement coated, zinc-coated, annularly threaded, helically threaded, helically threaded and barbed, and barbed.

Nails in use resist withdrawal loads, lateral loads, or a combination of the two. Both withdrawal and lateral resistance are affected by the wood, the nail, and the condition of use. In general, however, any variation in these factors has a more pronounced effect on withdrawal resistance than on lateral resistance. The serviceability of joints with nails laterally loaded does not depend greatly on withdrawal resistance unless large joint distortion is tolerable.

The diameters of various penny or gauge sizes of bright common nails are given in Table 8–1. The penny size designation should be used cautiously. International nail producers sometimes do not adhere to the dimensions of Table 8–1. Thus penny sizes, although still widely used, are obsolete. Specifying nail sizes by length and diameter dimensions is recommended. Bright box nails are generally of the same length but slightly smaller diameter (Table 8–2), whereas cement-coated nails such as coolers, sinkers, and coated box nails are slightly shorter (3.2 mm (1/8 in.)) and of smaller diameter than common nails of the same penny size. Helically and annularly threaded nails generally have smaller diameters than common nails for the same penny size (Table 8–3).

Withdrawal Resistance

The resistance of a nail shank to direct withdrawal from a piece of wood depends on the density of the wood, the diameter of the nail, and the depth of penetration. The surface condition of the nail at the time of driving also influences the initial withdrawal resistance.

For bright common wire nails driven into the side grain of seasoned wood or unseasoned wood that remains wet, the results of many tests have shown that the maximum withdrawal load is given by the empirical equation

$$p = 54.12G^{5/2}DL \quad (\text{metric}) \quad (8-1a)$$

$$p = 7,850G^{5/2}DL \quad (\text{inch–pound}) \quad (8-1b)$$

Table 8–1. Sizes of bright common wire nails

Size	Gauge	Length (mm (in.))	Diameter (mm (in.))
6d	11-1/2	50.8 (2)	2.87 (0.113)
8d	10-1/4	63.5 (2-1/2)	3.33 (0.131)
10d	9	76.2 (3)	3.76 (0.148)
12d	9	82.6 (3-1/4)	3.76 (0.148)
16d	8	88.9 (3-1/2)	4.11 (0.162)
20d	6	101.6 (4)	4.88 (0.192)
30d	5	114.3 (4-1/2)	5.26 (0.207)
40d	4	127.0 (5)	5.72 (0.225)
50d	3	139.7 (5-1/2)	6.20 (0.244)
60d	2	152.4 (6)	6.65 (0.262)

Table 8–2. Sizes of smooth box nails

Size	Gauge	Length (mm (in.))	Diameter (mm (in.))
3d	14-1/2	31.8 (1-1/4)	1.93 (0.076)
4d	14	38.1 (1-1/2)	2.03 (0.080)
5d	14	44.5 (1-3/4)	2.03 (0.080)
6d	12-1/2	50.8 (2)	2.49 (0.099)
7d	12-1/2	57.2 (2-1/4)	2.49 (0.099)
8d	11-1/2	63.5 (2-1/2)	2.87 (0.113)
10d	10-1/2	76.2 (3)	3.25 (0.128)
16d	10	88.9 (3-1/2)	3.43 (0.135)
20d	9	101.6 (4)	3.76 (0.148)

Table 8–3. Sizes of helically and annularly threaded nails

Size	Length (mm (in.))	Diameter (mm (in.))
6d	50.8 (2)	3.05 (0.120)
8d	63.5 (2-1/2)	3.05 (0.120)
10d	76.2 (3)	3.43 (0.135)
12d	82.6 (3-1/4)	3.43 (0.135)
16d	88.9 (3-1/2)	3.76 (0.148)
20d	101.6 (4)	4.50 (0.177)
30d	114.3 (4-1/2)	4.50 (0.177)
40d	127.0 (5)	4.50 (0.177)
50d	139.7 (5-1/2)	4.50 (0.177)
60d	152.4 (6)	4.50 (0.177)
70d	177.8 (7)	5.26 (0.207)
80d	203.2 (8)	5.26 (0.207)
90d	228.6 (9)	5.26 (0.207)

where *p* is maximum load (N, lb), *L* depth (mm, in.) of penetration of the nail in the member holding the nail point, *G* specific gravity of the wood based on oven-dry weight and volume at 12% moisture content (see Chap. 5, Tables 5–2 to 5–5), and *D* diameter of the nail (mm, in.). (The NDS uses oven-dry weight and volume as a basis.)

The loads expressed by Equation (8–1) represent average data. Certain wood species give test values that are somewhat greater or less than the equation values. A

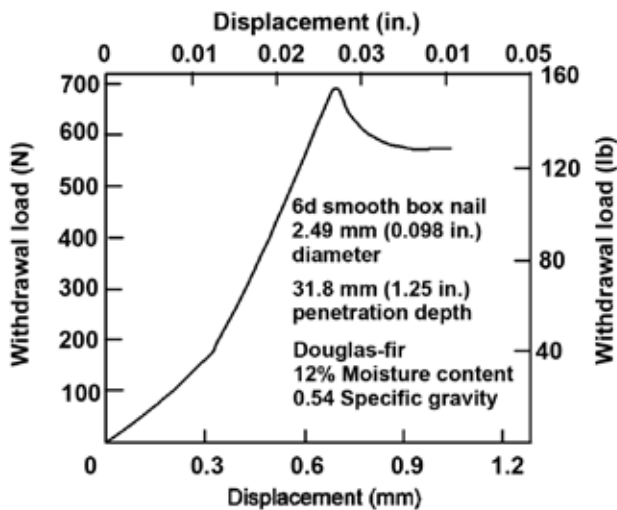

Figure 8-2. Typical load–displacement curve for direct withdrawal of a nail.

typical load–displacement curve for nail withdrawal (Fig. 8-2) shows that maximum load occurs at relatively small values of displacement.

Although the equation for nail-withdrawal resistance indicates that the dense, heavy woods offer greater resistance to nail withdrawal than do the lower density ones, lighter species should not be disqualified for uses requiring high resistance to withdrawal. As a rule, the less dense species do not split as readily as the denser ones, thus offering an opportunity for increasing the diameter, length, and number of the nails to compensate for the wood's lower resistance to nail withdrawal.

The withdrawal resistance of nail shanks is greatly affected by such factors as type of nail point, type of shank, time the nail remains in the wood, surface coatings, and moisture content changes in the wood.

Effect of Seasoning

With practically all species, nails driven into green wood and pulled before any seasoning takes place offer about the same withdrawal resistance as nails driven into seasoned wood and pulled soon after driving. However, if common smooth-shank nails are driven into green wood that is allowed to season, or into seasoned wood that is subjected to cycles of wetting and drying before the nails are pulled, they lose a major part of their initial withdrawal resistance. The withdrawal resistance for nails driven into wood that is subjected to changes in moisture content may be as low as 25% of the values for nails tested soon after driving. On the other hand, if the wood fibers deteriorate or the nail corrodes under some conditions of moisture variation and time, withdrawal resistance is erratic; resistance may be regained or even increased over the immediate withdrawal resistance. However, such sustained performance should not be relied on in the design of a nailed joint.

In seasoned wood that is not subjected to appreciable moisture content changes, the withdrawal resistance of nails may also diminish due to relaxation of the wood fibers with time. Under all these conditions of use, the withdrawal resistance of nails differs among species and shows variation within individual species.

Effect of Nail Form

The surface condition of nails is frequently modified during the manufacturing process to improve withdrawal resistance. Such modification is usually done by surface coating, surface roughening, or mechanical deformation of the shank. Other factors that affect the surface condition of the nail are the oil film remaining on the shank after manufacture or corrosion resulting from storage under adverse conditions; but these factors are so variable that their influence on withdrawal resistance cannot be adequately evaluated.

Surface Modifications—A common surface treatment for nails is the so-called cement coating. Cement coatings, contrary to what the name implies, do not include cement as an ingredient; they generally are a composition of resin applied to the nail to increase the resistance to withdrawal by increasing the friction between the nail and the wood. If properly applied, they increase the resistance of nails to withdrawal immediately after the nails are driven into the softer woods. However, in the denser woods (such as hard maple, birch, or oak), cement-coated nails have practically no advantage over plain nails, because most of the coating is removed in driving. Some of the coating may also be removed in the side member before the nail penetrates the main member.

Good-quality cement coatings are uniform, not sticky to the touch, and cannot be rubbed off easily. Different techniques of applying the cement coating and variations in its ingredients may cause large differences in the relative resistance to withdrawal of different lots of cement-coated nails. Some nails may show only a slight initial advantage over plain nails. In the softer woods, the increase in withdrawal resistance of cement-coated nails is not permanent but drops off significantly after a month or so. Cement-coated nails are used primarily in construction of boxes, crates, and other containers usually built for rough handling and relatively short service.

Nails that have galvanized coatings, such as zinc, are intended primarily for uses where corrosion and staining resistance are important factors in permanence and appearance. If the zinc coating is evenly applied, withdrawal resistance may be increased, but extreme irregularities of the coating may actually reduce it. The advantage that uniformly coated galvanized nails may have over nongalvanized nails in resistance to initial withdrawal is usually reduced by repeated cycles of wetting and drying.

Nails have also been made with plastic coatings. The usefulness and characteristics of these coatings are influenced by

the quality and type of coating, the effectiveness of the bond between the coating and base fastener, and the effectiveness of the bond between the coating and wood fibers. Some plastic coatings appear to resist corrosion or improve resistance to withdrawal, while others offer little improvement.

Fasteners with properly applied nylon coating tend to retain their initial resistance to withdrawal compared with other coatings, which exhibit a marked decrease in withdrawal resistance within the first month after driving.

A chemically etched nail has somewhat greater withdrawal resistance than some coated nails, as the minutely pitted surface is an integral part of the nail shank. Under impact loading, however, the withdrawal resistance of etched nails is little different from that of plain or cement-coated nails under various moisture conditions.

Sand-blasted nails perform in much the same manner as chemically etched nails.

Shape Modifications—Nail shanks may be varied from a smooth, circular form to give an increase in surface area without an increase in nail weight. Special nails with barbed, helically or annularly threaded, and other irregular shanks (Fig. 8-1) are commercially available.

The form and magnitude of the deformations along the shank influence the performance of the nails in various wood species. In wood remaining at a uniform moisture content, the withdrawal resistance of these nails is generally somewhat greater than that of common wire nails of the same diameter. From tests in which nails were driven in the side grain of seasoned wood, bright annularly threaded nails, with shank-to-thread-crest diameter difference greater than 0.2 mm (0.008 in.) and thread spacing between 1.27 mm (0.05 in.) and 1.96 mm (0.077 in.), the immediate maximum withdrawal load is given by the empirical equation

$$p = 73.11G^2DL \quad (\text{metric}) \quad (8-2a)$$

$$p = 10,600G^2DL \quad (\text{inch-pound}) \quad (8-2b)$$

where p is maximum load (N, lb), L depth (mm, in.) of penetration of the nail in the member holding the nail point, G specific gravity of the wood based on oven-dry weight and volume and oven-dry moisture content (see Chap. 5, Tables 5-2 to 5-5), and D shank diameter of the nail (mm, in.). The expression is valid only for the threaded portion of the nail. Comparison of Equations (8-1) and (8-2) indicates that the bright annularly threaded nail can have withdrawal resistances that are double the values of common nails. For galvanized annularly threaded nails, the immediate withdrawal strength is slightly lower. However, under conditions involving changes in moisture content of the wood, some special nail forms provide considerably greater withdrawal resistance than the common wire nail—about four times greater for annularly and helically threaded nails of the same diameter. This is especially true of nails driven into green

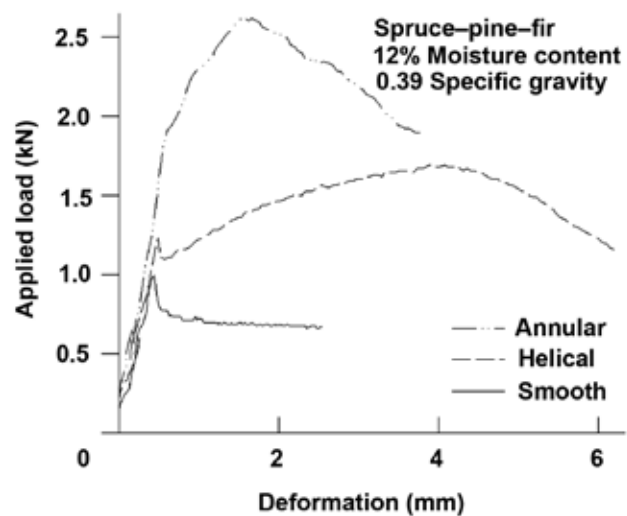

Figure 8-3. Typical load-displacement curves deformed and smooth shank for direct withdrawal of a nail.

wood that subsequently dries. In general, annularly threaded nails sustain larger withdrawal loads, and helically threaded nails sustain greater impact withdrawal work values than do the other nail forms (Fig. 8-3).

Nails with deformed shanks are sometimes hardened by heat treatments for use where driving conditions are difficult or to obtain improved performance, such as in pallet assembly. Hardened nails are brittle and care should be exercised to avoid injuries from fragments of nails broken during driving.

Nail Point—A smooth, round shank nail with a long, sharp point will usually have a greater withdrawal resistance, particularly in the softer woods, than the common wire nail (which usually has a diamond point). However, sharp points accentuate splitting in certain species, which may reduce withdrawal resistance. A blunt or flat point without taper reduces splitting, but its destruction of the wood fibers when driven reduces withdrawal resistance to less than that of the common wire nail. A nail tapered at the end and terminating in a blunt point will cause less splitting. In heavier woods, such a tapered, blunt-pointed nail will provide about the same withdrawal resistance, but in less dense woods, its resistance to withdrawal is less than that of the common nail.

Nail Head—Nail head classifications include flat, oval, countersunk, deep-countersunk, and brad. Nails with all types of heads, except the deep-countersunk, brad, and some of the thin flathead nails, are sufficiently strong to withstand the force required to pull them from most woods in direct withdrawal. One exception to this statement is for annularly threaded nails. Due to the increased withdrawal capacity for these type nails, nail head can be pulled into or through wood members. The deep-countersunk and brad nails are usually driven below the wood surface and are not intended to carry large withdrawal loads. In general, the thickness

Chapter 8 Fastenings

and diameter of the heads of the common wire nails increase as the size of the nail increases.

The development of some pneumatically operated portable nailers has introduced nails with specially configured heads, such as T-nails and nails with a segment of the head cut off.

Corrosion and Staining

In the presence of moisture, metals used for nails may corrode when in contact with wood treated with certain preservative or fire-retardant treatments (Chaps. 15 and 18). Use of certain metals or metal alloys will reduce the amount of corrosion. Nails of copper, silicon bronze, and 300 series stainless steels have performed well in wood treated with ammoniacal copper arsenate and chromated copper arsenate. Similarly, 300 series stainless steel nails have performed well in wood treated with copper azole and alkaline copper quaternary. The choice of metals for use with fire-retardant-treated woods depends upon the particular fire-retardant chemical.

With the greater use of metal connectors, such as joist hangers, in outdoor environments, an additional corrosion concern is possible. Both the joist hanger and fastener should be of the same metal type; if not, the corrosion rate of either the fastener or hanger may increase due to galvanic (mixed metal) corrosion between the hanger and fastener.

Organic coated fasteners, such as polymer coatings, resist corrosion on the principle of isolation. Any damage that occurs to the coating during insertion can give the corrosive environment a path to the substrate, and pitting or crevice corrosion will occur at these sites.

Staining caused by the reaction of certain wood extractives (Chap. 3) and steel in the presence of moisture is a problem if appearance is important, such as with naturally finished siding. Use of stainless steel, aluminum, or hot-dipped galvanized nails can alleviate staining.

In general, the withdrawal resistance of copper, other alloy, and polymer-coated nails is comparable with that of common steel wire nails when pulled soon after driving.

Driving

The resistance of nails to withdrawal is generally greatest when they are driven perpendicular to the grain of the wood. When a bright nail is driven parallel to the wood fibers (that is, into the end of the piece) withdrawal resistance in wood ranges between 50% to 75% of the resistance obtained when the nail is driven perpendicular to the grain. The ratio between the immediate end- and side-grain withdrawal loads is nearly constant for all specific gravities. In contrast to the immediate withdrawal case, nails pulled after a time interval or after moisture content changes experience a decreased load in both side and end grain. For most species the decrease in the side grain withdrawal load is greater than in the end grain; therefore the resulting end- to side-grain ratio is larger.

Toe nailing, a common method of joining wood framework, involves slant driving a nail or group of nails through the end or edge of an attached member and into a main member. Toe nailing requires greater skill in assembly than does ordinary end nailing but provides joints of greater strength and stability. Tests show that the maximum strength of toenailed joints under lateral and uplift loads is obtained by (a) using the largest nail that will not cause excessive splitting, (b) allowing an end distance (distance from the end of the attached member to the point of initial nail entry) of approximately one-third the length of the nail, (c) driving the nail at a slope of 30° with the attached member, and (d) burying the full shank of the nail but avoiding excessive mutilation of the wood from hammer blows.

The results of withdrawal tests with multiple nail joints in which the piece attached is pulled directly away from the main member show that slant driving is usually superior to straight driving when nails are driven into dry wood and pulled immediately, and decidedly superior when nails are driven into green or partially dry wood that is allowed to season for a month or more. However, the loss in depth of penetration due to slant driving may, in some types of joints, offset the advantages of slant nailing. Cross slant driving of groups of nails through the side grain is usually somewhat more effective than parallel-slant driving through the end grain.

Nails driven into lead holes with a diameter slightly smaller (approximately 90%) than the nail shank have somewhat greater withdrawal resistance than nails driven without lead holes. Lead holes also prevent or reduce splitting of the wood, particularly for dense species.

Clinching

The withdrawal resistance of smooth-shank, clinched nails is considerably greater than that of unclinched nails. The point of a clinched nail is bent over where the nail protrudes through the side member. The ratio between the loads for clinched and unclinched nails varies enormously, depending upon the moisture content of the wood when the nail is driven and withdrawn, the species of wood, the size of nail, and the direction of clinch with respect to the grain of the wood.

In dry or green wood, a clinched nail provides 45% to 170% more withdrawal resistance than an unclinched nail when withdrawn soon after driving. In green wood that seasons after a nail is driven, a clinched nail gives 250% to 460% greater withdrawal resistance than an unclinched nail. However, this improved strength of a clinched-nail joint does not justify the use of green lumber, because the joints may loosen as the lumber seasons. Furthermore, laboratory tests were made with single nails, and the effects of drying, such as warping, twisting, and splitting, may reduce the efficiency of a joint that has more than one nail. Clinching of nails is generally confined to such construction as boxes and crates and other container applications.

Nails clinched across the grain have approximately 20% more resistance to withdrawal than nails clinched along the grain.

Fastening of Plywood

The nailing characteristics of plywood are not greatly different from those of solid wood except for plywood’s greater resistance to splitting when nails are driven near an edge. The nail withdrawal resistance of plywood is 15% to 30% less than that of solid wood of the same thickness. The reason is that fiber distortion is less uniform in plywood than in solid wood. For plywood less than 12.5 mm (1/2 in.) thick, the greater splitting resistance tends to offset the lower withdrawal resistance compared with solid wood. The withdrawal resistance per unit length of penetration decreases as the number of plies per unit length increases. The direction of the grain of the face ply has little influence on the withdrawal resistance from the face near the end or edge of a piece of plywood. The direction of the grain of the face ply may influence the pull-through resistance of staples or nails with severely modified heads, such as T-heads. Fastener design information for plywood is available from APA–The Engineered Wood Association.

Allowable Loads

The preceding discussion dealt with maximum withdrawal loads obtained in short-time test conditions. For design, these loads must be reduced to account for variability, duration-of-load effects, and safety. A value of one-sixth the average maximum load has usually been accepted as the allowable load for long-time loading conditions. For normal duration of load, this value may be increased by 10%. Normal duration of load is defined as a load of 10-year duration.

Lateral Resistance

Pre-1991

Test loads at joint slips of 0.38 mm (0.015 in.) (approximate proportional limit load) for bright common wire nails in lateral resistance driven into the side grain (perpendicular to the wood fibers) of seasoned wood are expressed by the empirical equation

$$p = KD^{3/2} \tag{8-2}$$

where p is lateral load per nail, K a coefficient, and D diameter of the nail. Values of coefficient K are listed in Table 8–4 for ranges of specific gravity of hardwoods and softwoods. The loads given by the equation apply only where the side member and the member holding the nail point are of approximately the same density. The thickness of the side member should be about one-half the depth of penetration of the nail in the member holding the point.

The ultimate lateral nail loads for softwoods may approach 3.5 times the loads expressed by the equation, and for hardwoods they may be 7 times as great. The joint slip at maximum load, however, is more than 20 times 0.38 mm (0.015 in.). This is demonstrated by the typical load–slip

Table 8–4. Coefficients for computing test loads for fasteners in seasoned wood^a (pre-1991)

Specific gravity range ^b	Lateral load coefficient K (metric (inch–pound))		
	Nails ^c	Screws	Lag screws
Hardwoods			
0.33–0.47	50.04 (1,440)	23.17 (3,360)	26.34 (3,820)
0.48–0.56	69.50 (2,000)	31.99 (4,640)	29.51 (4,280)
0.57–0.74	94.52 (2,720)	44.13 (6,400)	34.13 (4,950)
Softwoods			
0.29–0.42	50.04 (1,440)	23.17 (3,360)	23.30 (3,380)
0.43–0.47	62.55 (1,800)	29.79 (4,320)	26.34 (3,820)
0.48–0.52	76.45 (2,200)	36.40 (5,280)	29.51 (4,280)

^aWood with a moisture content of 15%.

^bSpecific gravity based on oven-dry weight and volume at 12% moisture content.

^cCoefficients based on load at joint slip of 0.38 mm (0.015 in.)

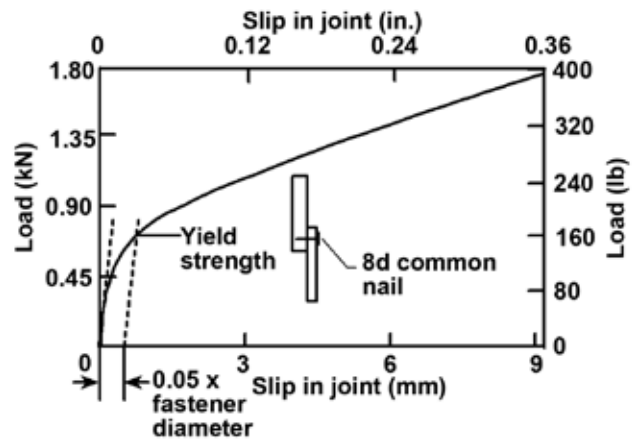

Figure 8–4. Typical relation between lateral load and slip in the joint and 5% offset definition.

curve shown in Figure 8–4. To maintain a sufficient ratio between ultimate load and the load at 0.38 mm (0.015 in.), the nail should penetrate into the member holding the point by not less than 10 times the nail diameter for dense woods (specific gravity greater than 0.61) and 14 times the diameter for low-density woods (specific gravity less than 0.42). For species having densities between these two ranges, the penetration may be found by straight line interpolation.

Post-1991

The yield model theory selects the worst case of yield modes based on different possibilities of wood bearing and nail bending. It does not account for nail head effects, friction between the main and side member, or axial forces transmitted along the length of the fastener. A description of the various combinations is given in Figure 8–5. Mode I is a wood bearing failure in either the main or side member; mode II is a rotation of the fastener in the joint without bending; modes III and IV are a combination of wood bearing failure and one or more plastic hinge yield formations in the fastener. Modes I_m and II have not been

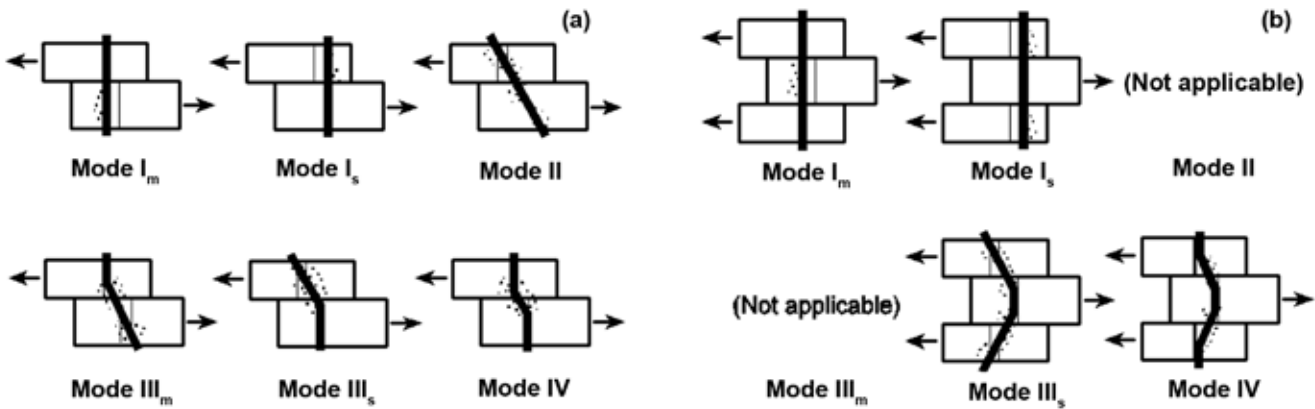

Figure 8–5. Various combinations of wood-bearing and fastener-bending yields for (a) two-member connections and (b) three-member connections.

Table 8–5. The 5% offset lateral yield strength (*Z*) for nails and screws for a two-member joint

Mode	<i>Z</i> value for nails	<i>Z</i> value for screws
I _s	$Dt_s F_{es}$	$Dt_s F_{es}$
III _m	$\frac{k_1 D p F_{em}}{1 + 2R_e}$	—
III _s	$\frac{k_2 D t_s F_{em}}{2 + R_e}$	$\frac{k_3 D t_s F_{em}}{2 + R_e}$
IV	$D^2 \sqrt{\frac{2F_{em}F_{yb}}{3(1 + R_e)}}$	$D^2 \sqrt{\frac{1.75F_{em}F_{yb}}{3(1 + R_e)}}$

Definitions

- D* nail, spike, or screw diameter, mm (in.) (for annularly threaded nails, *D* is thread-root diameter; for screws, *D* is either the shank diameter or the root diameter if the threaded portion of the screw is in the shear plane)
- F_{em}* dowel bearing stress of main member (member holding point), MPa (lb in⁻²)
- F_{es}* dowel bearing stress of side member, MPa (lb in⁻²)
- F_{yb}* bending yield stress of nail, spike, or screw, MPa (lb in⁻²)
- p* penetration of nail or spike in main member, mm (in.)
- t_s* thickness of side member, mm (in.)
- Z* offset lateral yield strength
- $R_e = F_{em}/F_{es}$

$$k_1 = -1 + \sqrt{2(1 + R_e) + \frac{2F_{yb}(1 + 2R_e)D^2}{3F_{em}D^2}}$$

$$k_2 = -1 + \sqrt{\frac{2(1 + R_e)}{R_e} + \frac{2F_{yb}(2 + R_e)D^2}{3F_{em}t_s^2}}$$

$$k_3 = -1 + \sqrt{\frac{2(1 + R_e)}{R_e} + \frac{F_{yb}(2 + R_e)D^2}{2F_{em}t_s^2}}$$

observed in nail and spike connections. The yield model theory is applicable to all types of dowel fasteners (nails, screws, bolts, lag screws), and thus the wood bearing capacity is described by a material property called the dowel bearing strength.

The yield mode equations (Table 8–5) are entered with the dowel bearing strength and dimensions of the wood members and the bending yield strength and diameter of the fastener.

The dowel bearing strength of the wood is experimentally determined by compressing a dowel into a wood member. The strength basis is the load representing a 5% diameter offset on the load–deformation curve (Fig. 8–4). Dowel bearing strength *F_e* (MPa, lb in⁻²) is empirically related to specific gravity *G* by

$$F_e = 114.5G^{1.84} \quad (\text{metric}) \quad (8-3a)$$

$$F_e = 16,600G^{1.84} \quad (\text{inch–pound}) \quad (8-3b)$$

where specific gravity is based on oven-dry weight and volume.

Bending yield strengths for the common nails are determined by ASTM F 1575 tests with typical values ranging between 551 MPa (80,000 lb in⁻²) and 689 MPa (100,000 lb in⁻²) for common nails. Smaller diameter nails have higher bending yield strength due to surface hardening during fabrication.

Spacing

End distance, edge distance, and spacing of nails should be such as to prevent unusual splitting. As a general rule, nails should be driven no closer to the edge of the side member than one-half its thickness and no closer to the end than the thickness of the piece. Smaller nails can be driven closer to the edges or ends than larger ones because they are less likely to split the wood.

Grain Direction Effects

The lateral load for side-grain nailing applies whether the load is in a direction parallel to the grain of the pieces joined or at right angles to it. When nails are driven into the end grain (parallel with the wood fibers), limited data on softwood species indicate that their maximum resistance to lateral displacement is about two-thirds that for nails driven into the side grain. Although the average proportional limit loads appear to be about the same for end- and side-grain nailing, the individual results are more erratic for end-grain nailing, and the minimum loads approach only 75% of corresponding values for side-grain nailing.

Moisture Content Effects

Nails driven into the side grain of unseasoned wood give maximum lateral resistance loads approximately equal to those obtained in seasoned wood, but the lateral resistance loads at 0.38 mm (0.015 in.) joint slip are somewhat less. To prevent excessive deformation, lateral loads obtained for seasoned wood should be reduced by 25% for unseasoned wood that will remain wet or be loaded before seasoning takes place.

When nails are driven into green wood, their lateral proportional limit loads after the wood has seasoned are also less than when they are driven into seasoned wood and loaded. The erratic behavior of a nailed joint that has undergone one or more moisture content changes makes it difficult to establish a lateral load for a nailed joint under these conditions. Structural joints should be inspected at intervals, and if it is apparent that the joint has loosened during drying, the joint should be reinforced with additional nails.

Deformed-Shank Nails

Deformed-shank nails carry somewhat higher maximum lateral loads than do the same pennyweight common wire nails, but both perform similarly at small distortions in the joint. It should be noted that the same pennyweight deformed-shank nail has a different diameter than that of the common wire nail. These nails often have higher bending yield strength than common wire nails, resulting in higher lateral strength in modes III and IV.

Lateral Load–Slip Models

A considerable amount of work has been done to describe, by mathematical models, the lateral load–slip curve of nails. These models have become important because of their need as input parameters for advanced methods of structural analysis.

One theoretical model, which considers the nail to be a beam supported on an elastic foundation (the wood), describes the initial slope of the curve:

$$\delta = P \left[2(L_1 + L_2) - \frac{(J_1 - J_2)^2}{(K_1 + K_2)} \right] \tag{8-4}$$

Table 8–6. Expressions for factors in Equation (8–4)

Factor	Expression ^a
L_1	$\frac{\lambda_1}{k_1} \frac{\sinh \lambda_1 a \cosh \lambda_1 a - \sin \lambda_1 a \cos \lambda_1 a}{\sinh^2 \lambda_1 a - \sin^2 \lambda_1 a}$
L_2	$\frac{\lambda_2}{k_2} \frac{\sinh \lambda_2 b \cosh \lambda_2 b - \sin \lambda_2 b \cos \lambda_2 b}{\sinh^2 \lambda_2 b - \sin^2 \lambda_2 b}$
J_1	$\frac{\lambda_1^2}{k_1} \frac{\sinh^2 \lambda_1 a + \sin^2 \lambda_1 a}{\sinh^2 \lambda_1 a - \sin^2 \lambda_1 a}$
J_2	$\frac{\lambda_2^2}{k_2} \frac{\sinh^2 \lambda_2 b + \sin^2 \lambda_2 b}{\sinh^2 \lambda_2 b - \sin^2 \lambda_2 b}$
K_1	$\frac{\lambda_1^3}{k_1} \frac{\sinh \lambda_1 a \cosh \lambda_1 a + \sin \lambda_1 a \cos \lambda_1 a}{\sinh^2 \lambda_1 a - \sin^2 \lambda_1 a}$
K_2	$\frac{\lambda_2^3}{k_2} \frac{\sinh \lambda_2 b \cosh \lambda_2 b + \sin \lambda_2 b \cos \lambda_2 b}{\sinh^2 \lambda_2 b - \sin^2 \lambda_2 b}$

^a $k_1 = k_{01}d$ and $k_2 = k_{02}d$, where k_1 and k_2 are the foundation moduli of members 1 and 2, respectively.

where P is the lateral load and δ is the joint slip. The factors $L_1, L_2, J_1, J_2, K_1,$ and K_2 (Table 8–6) are combinations of hyperbolic and trigonometric functions of the quantities $\lambda_1 a$ and $\lambda_2 b$ in which a and b are the depth of penetration of the nail in members 1 and 2, respectively. For smooth round nails,

$$\lambda = 2 \sqrt[4]{\frac{k_0}{\pi E D^3}} \tag{8-5}$$

where k_0 is elastic bearing constant, D nail diameter, and E modulus of elasticity of the nail. For seasoned wood, the elastic bearing constant k_0 (N mm⁻³, lb in⁻³) has been shown to be related to average species specific gravity G if no lead hole is used by

$$k_0 = 582G \quad (\text{metric}) \tag{8-6a}$$

$$k_0 = 2,144,000G \quad (\text{inch–pound}) \tag{8-6b}$$

If a prebored lead hole equal to 90% of the nail diameter is used,

$$k_0 = 869G \quad (\text{metric}) \tag{8-7a}$$

$$k_0 = 3,200,000G \quad (\text{inch–pound}) \tag{8-7b}$$

Other empirically derived models attempt to describe the entire load–slip curve. Two such expressions are

$$P = A \log_{10}(1 + B\delta) \tag{8-8a}$$

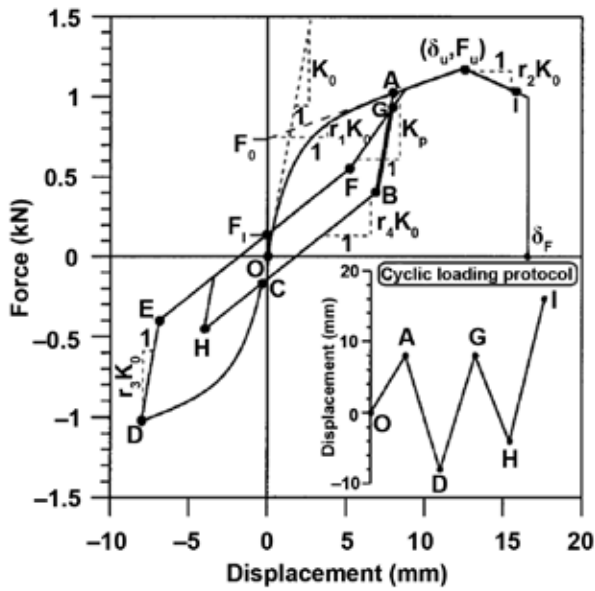

Figure 8-6. Load deformation curve for nails for a specific cyclic loading protocol.

ous monotonic fastener load deformation model to a specific cyclic loading protocol as shown in Figure 8-6, where load–displacement paths OA and CD follow the monotonic envelope curve as expressed by Equation (8-8b). All other paths are assumed to exhibit a linear relationship between force and deformation. Unloading off the envelope curve follows a path such as AB with stiffness r_3K_0 . Here, both the connector and wood are unloading elastically. Under continued unloading, the response moves onto path BC, which has reduced stiffness r_4K_0 . Along this path, the connector loses partial contact with the surrounding wood because of permanent deformation that was produced by previous loading, along path OA in this case. The slack response along this path characterizes the pinched hysteresis displayed by dowel connections under cyclic loading. Loading in the opposite direction for the first time forces the response onto the envelope curve CD. Unloading off this curve is assumed elastic along path DE, followed by a pinched response along path EF, which passes through the zero-displacement intercept F_1 , with slope r_4K_0 . Continued reloading follows path F_G with degrading stiffness K_p . Hysteretic fastener models are not single analytical expressions and are typically used in computer models.

Table 8-7. Sizes of common wire spikes

Size	Length (mm (in.))	Diameter (mm (in.))
10d	76.2 (3)	4.88 (0.192)
12d	82.6 (3-1/4)	4.88 (0.192)
16d	88.9 (3-1/2)	5.26 (0.207)
20d	101.6 (4)	5.72 (0.225)
30d	114.3 (4-1/2)	6.20 (0.244)
40d	127.0 (5)	6.68 (0.263)
50d	139.7 (5-1/2)	7.19 (0.283)
60d	152.4 (6)	7.19 (0.283)
5/16 in.	177.8 (7)	7.92 (0.312)
3/8 in.	215.9 (8-1/2)	9.53 (0.375)

where the parameters A and B are empirically fitted, and a second model, which includes a load reducing behavior,

$$P = (P_0 + r_1K_0\delta)(1 - e^{-K_0\delta/P_0}) \quad \delta \leq \delta_u \quad (8-8b)$$

$$P = P_u + r_2K_0[\delta - \delta_u] \quad \delta_u \leq \delta \leq \delta_F$$

where the parameters K_0 , r_1 , r_2 , and P_0 are empirically determined; δ_u is deformation at ultimate load, and δ_F is deformation at failure.

The previous two expressions represent fastener loading deformation response for monotonic loading. Recently, the load–deformation behavior of nails subjected to cyclic load has become of interest. The behavior of wood structures to dynamic or repeated loading condition from high wind or earthquakes is strongly linked to nail fastener models that consider the reversal of loading as an extension of the previ-

Spikes

Common wire spikes are manufactured in the same manner as common wire nails. They have either a chisel point or a diamond point and are made in lengths of 76 to 305 mm (3 to 12 in.). For corresponding lengths in the range of 76 to 152 (3 to 6 in.), they have larger diameters (Table 8-7) than common wire nails, and beyond the 60d size they are usually designated by diameter.

The withdrawal and lateral resistance equations and limitations given for common wire nails are also applicable to spikes, except that in calculating the withdrawal load for spikes, the depth of penetration is taken as the length of the spike in the member receiving the point, minus two-thirds the length of the point.

Staples

Different types of staples have been developed with various modifications in points, shank treatment and coatings, gauge, crown width, and length. These fasteners are available in clips or magazines for use in pneumatically operated portable staplers. Most factors that affect the withdrawal and lateral loads of nails similarly affect the loads on staples. The withdrawal resistance, for example, varies almost directly with the circumference and depth of penetration when the type of point and shank are similar to nails. Thus, Equation (8-1) has been used to predict the withdrawal load for one leg of a staple, but no verification tests have been done.

The load in lateral resistance varies approximately as the 3/2 power of the diameter when other factors, such as quality of metal, type of shank, and depth of penetration, are similar to nails. The diameter of each leg of a two-legged

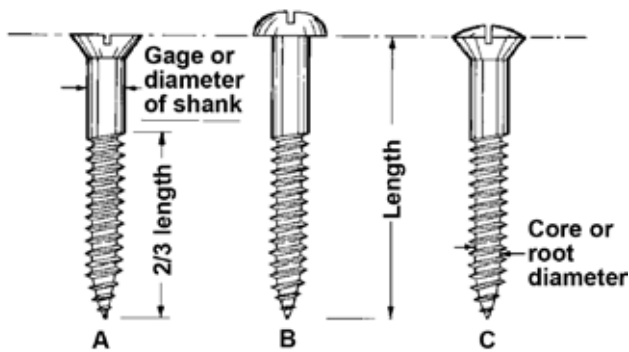

Figure 8–7. Common types of wood screws: A, flathead; B, roundhead; and C, ovalhead.

staple must therefore be about two-thirds the diameter of a nail to provide a comparable load. Equation (8–2) has been used to predict the lateral resistance of staples. However, yield model theory equations have not yet been experimentally verified for staples.

In addition to the immediate performance capability of staples and nails as determined by test, factors such as corrosion, sustained performance under service conditions, and durability in various uses should be considered in evaluating the relative usefulness of a stapled connection.

Drift Bolts

A drift bolt (or drift pin) is a long pin of iron or steel, with or without head or point. It is driven into a bored hole through one timber and into an adjacent one, to prevent the separation of the timbers connected and to transmit lateral load. The hole in the second member is drilled sufficiently deep to prevent the pin from hitting the bottom.

The ultimate withdrawal load of a round drift bolt or pin from the side grain of seasoned wood is given by

$$p = 45.51G^2DL \quad (\text{metric}) \quad (8-9a)$$

$$p = 6,600G^2DL \quad (\text{inch-pound}) \quad (8-9b)$$

where p is the ultimate withdrawal load (N, lb), G specific gravity based on the oven-dry weight and volume at 12% moisture content of the wood, D diameter of the drift bolt (mm, in.), and L length of penetration of the bolt (mm, in.). (The NDS uses oven-dry weight and volume as a basis.)

This equation provides an average relationship for all species, and the withdrawal load for some species may be above or below the equation values. It also presumes that the bolts are driven into prebored holes having a diameter 3.2 mm (1/8 in.) less than the bolt diameter.

Data are not available on lateral resistance of drift bolts. The yield model should provide lateral strength prediction, but the model has not been experimentally verified for drift bolts. Designers have used bolt data and design methods

based on experience. This suggests that the load for a drift bolt driven into the side grain of wood should not exceed, and ordinarily should be taken as less than, that for a bolt of the same diameter. Bolt design values are based on the thickness of the main member in a joint. Thus the depth of penetration of the drift bolt must be greater than or equal to the main-member thickness on which the bolt design value is based. However, the drift bolt should not fully penetrate its joint.

Wood Screws

The common types of wood screws have flat, oval, or round heads. The flathead screw is most commonly used if a flush surface is desired. Ovalhead and roundhead screws are used for appearance, and roundhead screws are used when countersinking is objectionable. The principal parts of a screw are the head, shank, thread, and core (Fig. 8–7). The root diameter for most sizes of screws averages about two-thirds the shank diameter. Wood screws are usually made of steel, brass, other metals, or alloys, and may have specific finishes such as nickel, blued, chromium, or cadmium. They are classified according to material, type, finish, shape of head, and diameter or gauge of the shank.

Current trends in fastenings for wood also include tapping or self-drilling screws. Tapping screws have threads the full length of the shank and may have some advantage for certain specific uses. Self-drilling screws have a drill-shaped tip to cut through both wood and steel material, eliminating the need for pre-drilling.

Withdrawal Resistance

Experimental Loads

The resistance of wood screw shanks to withdrawal from the side grain of seasoned wood varies directly with the square of the specific gravity of the wood. Within limits, the withdrawal load varies directly with the depth of penetration of the threaded portion and the diameter of the screw, provided the screw does not fail in tension. The screw will fail in tension when its strength is exceeded by the withdrawal strength from the wood. The limiting length to cause a tension failure decreases as the density of the wood increases since the withdrawal strength of the wood increases with density. The longer lengths of standard screws are therefore superfluous in dense hardwoods.

The withdrawal resistance of type A tapping screws, commonly called sheet metal screws, is in general about 10% greater than that for wood screws of comparable diameter and length of threaded portion. The ratio between the withdrawal resistance of tapping screws and wood screws varies from 1.16 in denser woods, such as oak, to 1.05 in lighter woods, such as redwood.

Ultimate test values for withdrawal loads of wood screws inserted into the side grain of seasoned wood may be expressed as

$$p = 108.25G^2DL \quad (\text{metric}) \quad (8-10a)$$

Chapter 8 Fastenings

$$p = 15,700G^2 DL \quad (\text{inch-pound}) \quad (8-10b)$$

where p is maximum withdrawal load (N, lb), G specific gravity based on oven-dry weight and volume at 12% moisture content, D shank diameter of the screw (mm, in.), and L length of penetration of the threaded part of the screw (mm, in.). (The NDS uses oven-dry weight and volume as a basis.) These values are based on reaching ultimate load in 5- to 10-min.

This equation is applicable when screw lead holes have a diameter of about 70% of the root diameter of the threads in softwoods, and about 90% in hardwoods.

The equation values are applicable to the screw sizes listed in Table 8-8. (Shank diameters are related to screw gauges.)

For lengths and gauges outside these limits, the actual values are likely to be less than the equation values.

The withdrawal loads of screws inserted in the end grain of wood are somewhat erratic, but when splitting is avoided, they should average 75% of the load sustained by screws inserted in the side grain.

Lubricating the surface of a screw with soap or similar lubricant is recommended to facilitate insertion, especially in dense woods, and it will have little effect on ultimate withdrawal resistance.

Fastening of Particleboard

Tapping screws are commonly used in particleboard where withdrawal strength is important. Care must be taken when tightening screws in particleboard to avoid stripping the threads. The maximum amount of torque that can be applied to a screw before the threads in the particleboard are stripped is given by

$$T = 3.16 + 0.0096X \quad (\text{metric}) \quad (8-11a)$$

$$T = 27.98 + 1.36X \quad (\text{inch-pound}) \quad (8-11b)$$

where T is torque (N-m, in-lb) and X is density of the particleboard (kg m^{-3} , lb ft^{-3}). Equation (8-11) is for 8-gauge screws with a depth of penetration of 15.9 mm (5/8 in.). The maximum torque is fairly constant for lead holes of 0% to 90% of the root diameter of the screw.

Ultimate withdrawal loads P (N, lb) of screws from particleboard can be predicted by

$$P = KD^{1/2}(L - D/3)^{5/4}G^2 \quad (8-12)$$

where D is shank diameter of the screw (mm, in.), L depth of embedment of the threaded portion of the screw (mm, in.), and G specific gravity of the board based on oven-dry weight and volume at current moisture content. For metric measurements, $K = 41.1$ for withdrawal from the face of the

Table 8-8. Screw sizes appropriate for Equation (8-10)

Screw length (mm (in.))	Gauge limits
12.7 (1/2)	1 to 6
19.0 (3/4)	2 to 11
25.4 (1)	3 to 12
38.1 (1-1/2)	5 to 14
50.8 (2)	7 to 16
63.5 (2-1/2)	9 to 18
76.2 (3)	12 to 20

board and $K = 31.8$ for withdrawal from the edge; for inch-pound measurements, $K = 2,655$ for withdrawal from the face and $K = 2,055$ for withdrawal from the edge. Equation (8-12) applies when the setting torque is between 60% to 90% of T (Eq. (8-11)).

Withdrawal resistance of screws from particleboard is not significantly different for lead holes of 50% to 90% of the root diameter. A higher setting torque will produce a somewhat higher withdrawal load, but there is only a slight difference (3%) in values between 60% to 90% setting torques (Eq. (8-11)). A modest tightening of screws in many cases provides an effective compromise between optimizing withdrawal resistance and stripping threads.

Equation (8-12) can also predict the withdrawal of screws from fiberboard with $K = 57.3$ (metric) or 3,700 (inch-pound) for the face and $K = 44.3$ (metric) or 2,860 (inch-pound) for the edge of the board.

Lateral Resistance

Pre-1991

The proportional limit loads obtained in tests of lateral resistance for wood screws in the side grain of seasoned wood are given by the empirical equation

$$p = KD^2 \quad (8-13)$$

where p is lateral load, D diameter of the screw shank, and K a coefficient depending on the inherent characteristics of the wood species. Values of screw shank diameters for various screw gauges are listed in Table 8-9.

Values of K are based on ranges of specific gravity of hardwoods and softwoods and are given in Table 8-4. They apply to wood at about 15% moisture content. Loads computed by substituting these constants in the equation are expected to have a slip of 0.18 to 0.25 mm (0.007 to 0.010 in.), depending somewhat on the species and density of the wood.

Equation (8-13) applies when the depth of penetration of the screw into the block receiving the point is not less than seven times the shank diameter and when the side

Table 8–9. Screw shank diameters for various screw gauges

Screw number or gauge	Diameter (mm (in.))
4	2.84 (0.112)
5	3.18 (0.125)
6	3.51 (0.138)
7	3.84 (0.151)
8	4.17 (0.164)
9	4.50 (0.177)
10	4.83 (0.190)
11	5.16 (0.203)
12	5.49 (0.216)
14	6.15 (0.242)
16	6.81 (0.268)
18	7.47 (0.294)
20	8.13 (0.320)
24	9.45 (0.372)

member and the main member are approximately of the same density. The thickness of the side member should be about one-half the depth of penetration of the screw in the member holding the point. The end distance should be no less than the side member thickness, and the edge distances no less than one-half the side member thickness.

This depth of penetration (seven times shank diameter) gives an ultimate load of about four times the load obtained by the equation. For a depth of penetration of less than seven times the shank diameter, the ultimate load is reduced about in proportion to the reduction in penetration, and the load at the proportional limit is reduced somewhat less rapidly. When the depth of penetration of the screw in the holding block is four times the shank diameter, the maximum load will be less than three times the load expressed by the equation, and the proportional limit load will be approximately equal to that given by the equation. When the screw holds metal to wood, the load can be increased by about 25%.

For these lateral loads, the part of the lead hole receiving the shank should be the same diameter as the shank or slightly smaller; that part receiving the threaded portion should be the same diameter as the root of the thread in dense species or slightly smaller than the root in low-density species.

Screws should always be turned in. They should never be started or driven with a hammer because this practice tears the wood fibers and injures the screw threads, seriously reducing the load carrying capacity of the screw.

Post-1991

Screw lateral strength is determined by the yield model theory (Table 8–5). Modes I, III, and IV failures may occur (Fig. 8–5). The dowel bearing strength values are based on the same specific gravity equation used to establish values for nails (Eq. (8–3)). Further discussion of screw lateral

strength is found in ASCE Manual No. 84, *Mechanical Connections in Wood Structures*.

Lag Screws

Lag screws are commonly used because of their convenience, particularly where it would be difficult to fasten a bolt or where a nut on the surface would be objectionable. Commonly available lag screws range from about 5.1 to 25.4 mm (0.2 to 1 in.) in diameter and from 25.4 to 406 mm (1 to 16 in.) in length. The length of the threaded part varies with the length of the screw and ranges from 19.0 mm (3/4 in.) with the 25.4- and 31.8-mm (1- and 1-1/4-in.) screws to half the length for all lengths greater than 254 mm (10 in.). Lag screws have a hexagonal-shaped head and are tightened by a wrench (as opposed to wood screws, which have a slotted head and are tightened by a screw driver). The following equations for withdrawal and lateral loads are based on lag screws having a base metal average tensile yield strength of about 310.3 MPa (45,000 lb in⁻²) and an average ultimate tensile strength of 530.9 MPa (77,000 lb in⁻²).

Withdrawal Resistance

The results of withdrawal tests have shown that the maximum direct withdrawal load of lag screws from the side grain of seasoned wood may be computed as

$$p = 125.4G^{3/2}D^{3/4}L \quad (\text{metric}) \quad (8-14a)$$

$$p = 8,100G^{3/2}D^{3/4}L \quad (\text{inch-pound}) \quad (8-14b)$$

where p is maximum withdrawal load (N, lb), D shank diameter (mm, in.), G specific gravity of the wood based on oven-dry weight and volume at 12% moisture content, and L length (mm, in.) of penetration of the threaded part. (The NDS use oven-dry weight and volume as a basis.) Equation (8–14) was developed independently of Equation (8–10) but gives approximately the same results.

Lag screws, like wood screws, require prebored holes of the proper size (Fig. 8–8). The lead hole for the shank should be the same diameter as the shank. The diameter of the lead hole for the threaded part varies with the density of the wood: For low-density softwoods, such as the cedars and white pines, 40% to 70% of the shank diameter; for Douglas-fir and Southern Pine, 60% to 75%; and for dense hardwoods, such as oaks, 65% to 85%. The smaller percentage in each range applies to lag screws of the smaller diameters and the larger percentage to lag screws of larger diameters. Soap or similar lubricants should be used on the screw to facilitate turning, and lead holes slightly larger than those recommended for maximum efficiency should be used with long screws.

In determining the withdrawal resistance, the allowable tensile strength of the lag screw at the net (root) section should not be exceeded. Penetration of the threaded part to a distance about seven times the shank diameter in the

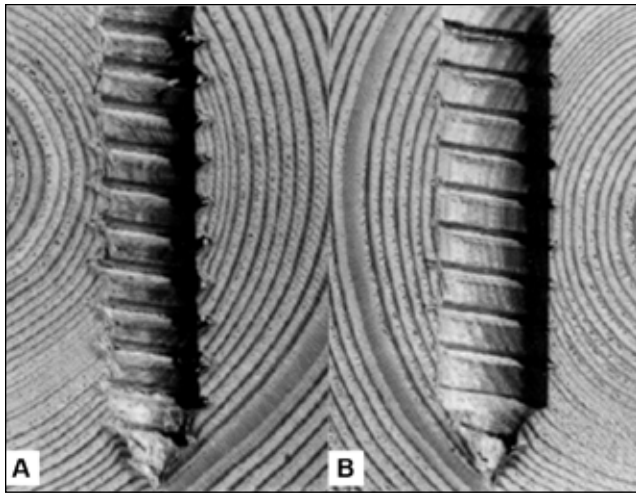

Figure 8-8. A, Clean-cut, deep penetration of thread made by lag screw turned into a lead hole of proper size, and B, rough, shallow penetration of thread made by lag screw turned into oversized lead hole.

denser species (specific gravity greater than 0.61) and 10 to 12 times the shank diameter in the less dense species (specific gravity less than 0.42) will develop approximately the ultimate tensile strength of the lag screw. Penetrations at intermediate densities may be found by straight-line interpolation.

The resistance to withdrawal of a lag screw from the end-grain surface of a piece of wood is about three-fourths as great as its resistance to withdrawal from the side-grain surface of the same piece.

Lateral Resistance

Pre-1991

The experimentally determined lateral loads for lag screws inserted in the side grain and loaded parallel to the grain of a piece of seasoned wood can be computed as

$$p = KD^2 \quad (8-15)$$

where p is proportional limit lateral load (N, lb) parallel to the grain, K a coefficient depending on the species specific gravity, and D shank diameter of the lag screw (mm, in.). Values of K for a number of specific gravity ranges can be found in Table 8-4. These coefficients are based on average results for several ranges of specific gravity for hardwoods and softwoods. The loads given by this equation apply when the thickness of the side member is 3.5 times the shank diameter of the lag screw, and the depth of penetration in the main member is seven times the diameter in the harder woods and 11 times the diameter in the softer woods. For other thicknesses, the computed loads should be multiplied by the factors listed in Table 8-10.

The thickness of a solid wood side member should be about one-half the depth of penetration in the main member.

Table 8-10. Multiplication factors for loads computed from Equation (8-15)

Ratio of thickness of side member to shank diameter of lag screw	Factor
2	0.62
2.5	0.77
3	0.93
3.5	1.00
4	1.07
4.5	1.13
5	1.18
5.5	1.21
6	1.22
6.5	1.22

Table 8-11. Multiplication factors for loads applied perpendicular to grain computed from Equation (8-15) with lag screw in side grain of wood

Shank diameter of lag screw (mm (in.))	Factor
4.8 (3/16)	1.00
6.4 (1/4)	0.97
7.9 (5/16)	0.85
9.5 (3/8)	0.76
11.1 (7/16)	0.70
12.7 (1/2)	0.65
15.9 (5/8)	0.60
19.0 (3/4)	0.55
22.2 (7/8)	0.52
25.4 (1)	0.50

When the lag screw is inserted in the side grain of wood and the load is applied perpendicular to the grain, the load given by the lateral resistance equation should be multiplied by the factors listed in Table 8-11.

For other angles of loading, the loads may be computed from the parallel and perpendicular values by using the Hankinson formula for determining the bearing strength of wood at various angles to the grain,

$$N = \frac{PQ}{P \sin^2 \theta + Q \cos^2 \theta} \quad (8-16)$$

where P is load or stress parallel to the grain, Q load or stress perpendicular to the grain, and N load or stress at an inclination θ with the direction of the grain.

Values for lateral resistance as computed by the preceding methods are based on complete penetration of the unthreaded shank into the side member but not into the main member. When the shank penetrates the main member, the permitted increases in loads are given in Table 8-12.

Table 8–12. Permitted increases in loads when lag screw unthreaded shank penetrates foundation member

Ratio of penetration of shank into foundation member to shank diameter	Increase in load (%)
1	8
2	17
3	26
4	33
5	36
6	38
7	39

When lag screws are used with metal plates, the lateral loads parallel to the grain may be increased 25%, provided the plate thickness is sufficient so that the bearing capacity of the steel is not exceeded. No increase should be made when the applied load is perpendicular to the grain.

Lag screws should not be used in end grain, because splitting may develop under lateral load. If lag screws are so used, however, the loads should be taken as two-thirds those for lateral resistance when lag screws are inserted into side grain and the loads act perpendicular to the grain.

The spacings, end and edge distances, and net section for lag screw joints should be the same as those for joints with bolts (discussed later) of a diameter equal to the shank diameter of the lag screw.

Lag screws should always be inserted by turning with a wrench, not by driving with a hammer. Soap, beeswax, or other lubricants applied to the screw, particularly with the denser wood species, will facilitate insertion and prevent damage to the threads but will not affect performance of the lag screw.

Post-1991

Lag screw lateral strength is determined by the yield model theory table similar to the procedure for bolts. Modes I, III, and IV yield may occur (Fig. 8–5). The dowel bearing strength values are based on the same parallel- and perpendicular-to-grain specific gravity equations used to establish values for bolts.

For other angles of loading, the dowel bearing strength values for use in the yield model are determined by the Hankinson equation, where P and Q are the values of dowel bearing parallel and perpendicular to grain, respectively.

Bolts

Bearing Stress of Wood under Bolts

The bearing stress under a bolt is computed by dividing the load on a bolt by the product LD , where L is the length of a

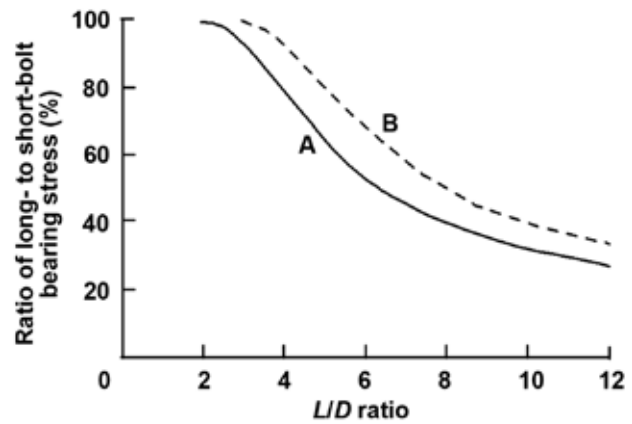

Figure 8–9. Variation in bolt-bearing stress at the proportional limit parallel to grain with L/D ratio. Curve A, relation obtained from experimental evaluation; curve B, modified relation used for establishing design loads.

bolt in the main member and D is the bolt diameter. Basic parallel-to-grain and perpendicular-to-grain bearing stresses have been obtained from tests of three-member wood joints where each side member is half the thickness of the main member. The side members were loaded parallel to grain for both parallel- and perpendicular-to-grain tests. Prior to 1991, bearing stress was based on test results at the proportional limit; since 1991, bearing stress is based on test results at a yield limit state, which is defined as the 5% diameter offset on the load–deformation curve (similar to Fig. 8–4).

The bearing stress at proportional limit load is largest when the bolt does not bend, that is, for joints with small L/D values. The curves of Figures 8–9 and 8–10 show the reduction in proportional limit bolt-bearing stress as L/D increases. The bearing stress at maximum load does not decrease as L/D increases, but remains fairly constant, which means that the ratio of maximum load to proportional limit load increases as L/D increases. To maintain a fairly constant ratio between maximum load and design load for bolts, the relations between bearing stress and L/D ratio have been adjusted as indicated in Figures 8–9 and 8–10.

The proportional limit bolt-bearing stress parallel to grain for small L/D ratios is approximately 50% of the small clear crushing strength for softwoods and approximately 60% for hardwoods. For bearing stress perpendicular to the grain, the ratio between bearing stress at proportional limit load and the small clear proportional limit stress in compression perpendicular to grain depends upon bolt diameter (Fig. 8–11) for small L/D ratios.

Species compressive strength also affects the L/D ratio relationship, as indicated in Figure 8–10. Relatively higher bolt proportional-limit stress perpendicular to grain is obtained with wood low in strength (proportional limit stress of 3,930 kPa (570 lb in⁻²) than with material of high strength

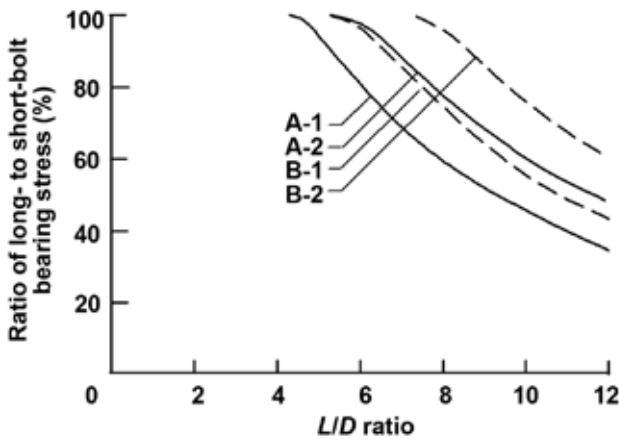

Figure 8–10. Variation in bolt-bearing stress at the proportional limit perpendicular to grain with L/D ratio. Relations obtained from experimental evaluation for materials with average compression perpendicular stress of 7,860 kPa (1,140 lb in⁻²) (curve A-1) and 3,930 kPa (570 lb in⁻²) (curve A-2). Curves B-1 and B-2, modified relations used for establishing design loads.

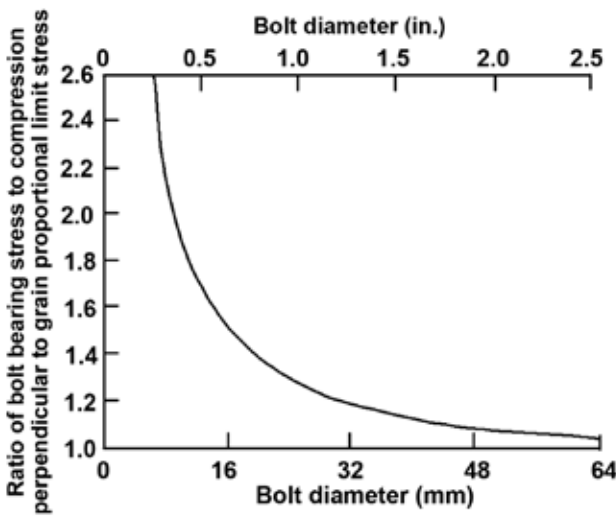

Figure 8–11. Bearing stress perpendicular to the grain as affected by bolt diameter.

(proportional limit stress of 7,860 kPa (1,140 lb in⁻²)). This effect also occurs for bolt-bearing stress parallel to grain, but not to the same extent as for perpendicular-to-grain loading.

The proportional limit bolt load for a three-member joint with side members half the thickness of the main member may be estimated by the following procedures.

For parallel-to-grain loading, (a) multiply the species small clear compressive parallel strength (Tables 5–3, 5–4, or 5–5) by 0.50 for softwoods or 0.60 for hardwoods, (b) multiply

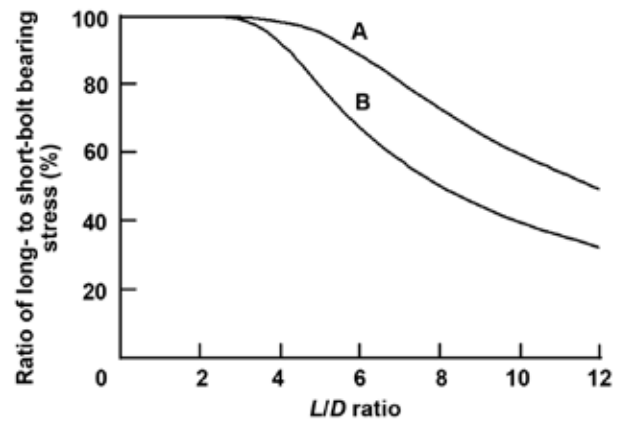

Figure 8–12. Variation in the proportional limit bolt-bearing stress parallel to grain with L/D ratio. Curve A, bolts with yield stress of 861.84 MPa (125,000 lb in⁻²); curve B, bolts with yield stress of 310.26 MPa (45,000 lb in⁻²).

this product by the appropriate factor from Figure 8–9 for the L/D ratio of the bolt, and (c) multiply this product by LD .

For perpendicular-to-grain loading, (a) multiply the species compression perpendicular-to-grain proportional limit stress (Tables 5–3, 5–4, or 5–5) by the appropriate factor from Figure 8–11, (b) multiply this product by the appropriate factor from Figure 8–10, and (c) multiply this product by LD .

Loads at an Angle to the Grain

For other angles of loading, the dowel bearing strength values for use in the yield model are determined by the Hankinson equation, where P and Q are the values of dowel bearing parallel and perpendicular to grain, respectively.

Steel Side Plates

When steel side plates are used, the bolt-bearing stress parallel to grain at joint proportional limit is approximately 25% greater than that for wood side plates. The joint deformation at proportional limit is much smaller with steel side plates. If loads at equivalent joint deformation are compared, the load for joints with steel side plates is approximately 75% greater than that for wood side plates. Pre-1991 design criteria included increases in connection strength with steel side plates; post-1991 design criteria include steel side plate behavior in the yield model equations.

For perpendicular-to-grain loading, the same loads are obtained for wood and steel side plates.

Bolt Quality

Both the properties of the wood and the quality of the bolt are factors in determining the strength of a bolted joint. The percentages given in Figures 8–9 and 8–10 for calculating bearing stress apply to steel machine bolts with a yield stress of 310 MPa (45,000 lb in⁻²). Figure 8–12 indicates the

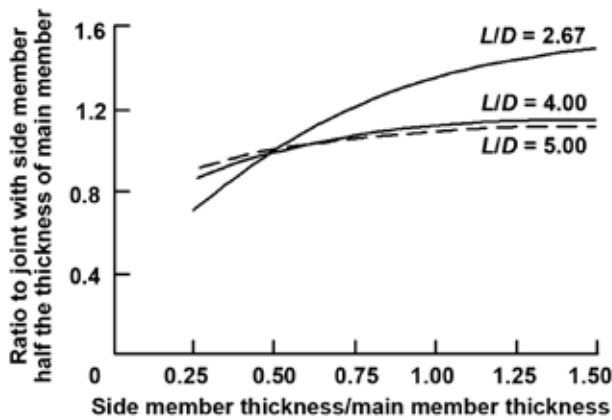

Figure 8–13. Proportional limit load related to side member thickness for three-member joints. Center member thickness was 50.8 mm (2 in.).

increase in bearing stress parallel to grain for bolts with a yield stress of 862 MPa (125,000 lb in⁻²).

Effect of Member Thickness

The proportional limit load is affected by the ratio of the side member thickness to the main member thickness (Fig. 8–13).

Pre-1991 design values for bolts are based on joints with the side member half the thickness of the main member. The usual practice in design of bolted joints is to take no increase in design load when the side members are greater than half the thickness of the main member. When the side members are less than half the thickness of the main member, a design load for a main member that is twice the thickness of the side member is used. Post-1991 design values include member thickness directly in the yield model equations.

Two-Member, Multiple-Member Joints

In pre-1991 design, the proportional limit load was taken as half the load for a three-member joint with a main member the same thickness as the thinnest member for two-member joints.

For four or more members in a joint, the proportional limit load was taken as the sum of the loads for the individual shear planes by treating each shear plane as an equivalent two-member joint.

Post-1991 design for joints with four or more members also results in values per shear plane. Connection strength for any number of members is conservatively found by multiplying the value for the weakest shear plane by the number of shear planes.

Spacing, Edge, and End Distance

The center-to-center distance along the grain should be at least four times the bolt diameter for parallel-to-grain loading. The minimum center-to-center spacing of bolts in

the across-the-grain direction for loads acting through metal side plates and parallel to the grain need only be sufficient to permit the tightening of the nuts. For wood side plates, the spacing is controlled by the rules applying to loads acting parallel to grain if the design load approaches the bolt-bearing capacity of the side plates. When the design load is less than the bolt-bearing capacity of the side plates, the spacing may be reduced below that required to develop their maximum capacity.

When a joint is in tension, the bolt nearest the end of a timber should be at a distance from the end of at least seven times the bolt diameter for softwoods and five times for hardwoods. When the joint is in compression, the end margin may be four times the bolt diameter for both softwoods and hardwoods. Any decrease in these spacings and margins will decrease the load in about the same ratio.

For bolts bearing parallel to the grain, the distance from the edge of a timber to the center of a bolt should be at least 1.5 times the bolt diameter. This margin, however, will usually be controlled by (a) the common practice of having an edge margin equal to one-half the distance between bolt rows and (b) the area requirements at the critical section. (The critical section is that section of the member taken at right angles to the direction of load, which gives the maximum stress in the member based on the net area remaining after reductions are made for bolt holes at that section.) For parallel-to-grain loading in softwoods, the net area remaining at the critical section should be at least 80% of the total area in bearing under all the bolts in the particular joint under consideration; in hardwoods it should be 100%.

For bolts bearing perpendicular to the grain, the margin between the edge toward which the bolt pressure is acting and the center of the bolt or bolts nearest this edge should be at least four times the bolt diameter. The margin at the opposite edge is relatively unimportant.

The aforementioned prescriptive spacing recommendations are based on experimental information and have been found to be sufficient for a majority of designed connections. There is still a need to validate the design spacing using a mechanics-based method that considers wood strength. The prescriptive spacing requirement may not agree with the strength-based method, and the large spacing requirement should be used. One method for the design of fastener joints loaded in tension parallel to grain is highlighted in appendix E of the *National Design Specification for Wood Construction*.

Effect of Bolt Holes

The bearing strength of wood under bolts is affected considerably by the size and type of bolt holes into which the bolts are inserted. A bolt hole that is too large causes nonuniform bearing of the bolt; if the bolt hole is too small, the wood will split when the bolt is driven. Normally, bolts should fit so that they can be inserted by tapping lightly with a

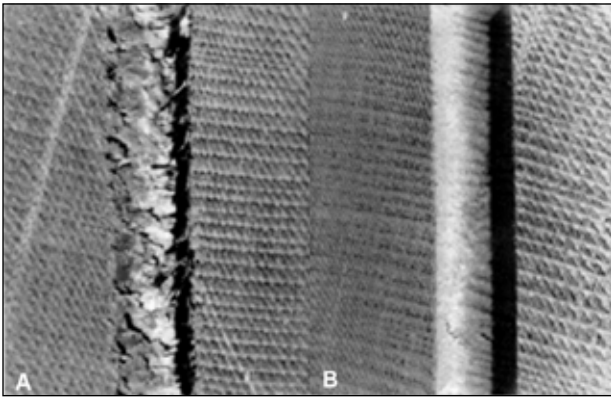

Figure 8-14. Effect of rate of feed and drill speed on the surface condition of bolt holes drilled in Sitka spruce. A, hole was bored with a twist drill rotating at a peripheral speed of 7.62 m min^{-1} (300 in min^{-1}); feed rate was 1.52 m/min (60 in min^{-1}). B, hole was bored with the same drill at a peripheral speed of 31.75 m min^{-1} ($1,250 \text{ in min}^{-1}$); feed rate was 50.8 mm min^{-1} (2 in min^{-1}).

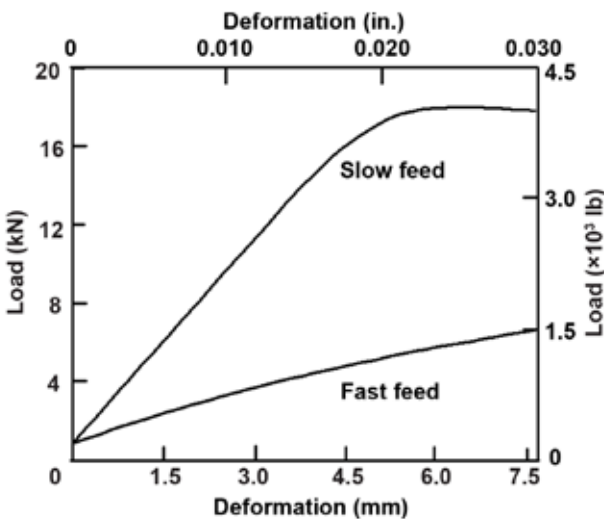

Figure 8-15. Typical load–deformation curves showing the effect of surface condition of bolt holes, resulting from a slow feed rate and a fast feed rate, on the deformation in a joint when subjected to loading under bolts. The surface conditions of the bolt holes were similar to those illustrated in Figure 8-14.

wood mallet. In general, the smoother the hole, the higher the bearing values will be (Fig. 8-14). Deformations accompanying the load are also less with a smoother bolt-hole surface (Fig. 8-15).

Rough holes are caused by using dull bits and improper rates of feed and drill speed. A twist drill operated at a peripheral speed of approximately 38 m min^{-1} ($1,500 \text{ in min}^{-1}$) produces uniformly smooth holes at moderate feed rates.

The rate of feed depends upon the diameter of the drill and the speed of rotation but should enable the drill to cut, rather than tear, the wood. The drill should produce shavings, not chips.

Proportional limit loads for joints with bolt holes the same diameter as the bolt will be slightly higher than for joints with a 1.6-mm (1/16-in.) oversized hole. However, if drying takes place after assembly of the joint, the proportional limit load for snug-fitting bolts will be considerably less due to the effects of shrinkage.

Pre-1991 Allowable Loads

The following procedures are used to calculate allowable bolt loads for joints with wood side members, each half the thickness of the main member.

Parallel to Grain—The starting point for parallel-to-grain bolt values is the maximum green crushing strength for the species or group of species. Procedures outlined in ASTM D 2555 are used to establish a 5% exclusion value. The exclusion value is divided by a factor of 1.9 to adjust to a 10-year normal duration of load and provide a factor of safety. This value is multiplied by 1.20 to adjust to a seasoned strength. The resulting value is called the basic bolt-bearing stress parallel to grain.

The basic bolt-bearing stress is then adjusted for the effects of L/D ratio. Table 8-13 gives the percentage of basic stress for three classes of species. The particular class for the species is determined from the basic bolt-bearing stress as indicated in Table 8-14. The adjusted bearing stress is further multiplied by a factor of 0.80 to adjust to wood side plates. The allowable bolt load in pounds is then determined by multiplying by the projected bolt area, LD .

Perpendicular to Grain—The starting point for perpendicular-to-grain bolt values is the average green proportional limit stress in compression perpendicular to grain. Procedures in ASTM D 2555 are used to establish compression perpendicular values for groups of species. The average proportional limit stress is divided by 1.5 for ring position (growth rings neither parallel nor perpendicular to load during test) and a factor of safety. This value is then multiplied by 1.20 to adjust to a seasoned strength and by 1.10 to adjust to a normal duration of load. The resulting value is called the basic bolt-bearing stress perpendicular to grain.

The basic bolt-bearing stress is then adjusted for the effects of bolt diameter (Table 8-15) and L/D ratio (Table 8-13). The allowable bolt load is then determined by multiplying the adjusted basic bolt-bearing stress by the projected bolt area, LD .

Post-1991 Yield Model

The empirical design approach used prior to 1991 was based on a tabular value for a single bolt in a wood-to-wood, three-member connection where the side members are each

Table 8–13. Percentage of basic bolt-bearing stress used for calculating allowable bolt loads

Ratio of bolt length to diameter (L/D)	L/D adjustment factor by class ^a						
	Parallel to grain			Perpendicular to grain			
	1	2	3	1	2	3	4
1	100.0	100.0	100.0	100.0	100.0	100.0	100.0
2	100.0	100.0	100.0	100.0	100.0	100.0	100.0
3	100.0	100.0	99.0	100.0	100.0	100.0	100.0
4	99.5	97.4	92.5	100.0	100.0	100.0	100.0
5	95.4	88.3	80.0	100.0	100.0	100.0	100.0
6	85.6	75.8	67.2	100.0	100.0	100.0	96.3
7	73.4	65.0	57.6	100.0	100.0	97.3	86.9
8	64.2	56.9	50.4	100.0	96.1	88.1	75.0
9	57.1	50.6	44.8	94.6	86.3	76.7	64.6
10	51.4	45.5	40.3	85.0	76.2	67.2	55.4
11	46.7	41.4	36.6	76.1	67.6	59.3	48.4
12	42.8	37.9	33.6	68.6	61.0	52.0	42.5
13	39.5	35.0	31.0	62.2	55.3	45.9	37.5

^aClass determined from basic bolt-bearing stress according to Table 8–14.

Table 8–14. L/D adjustment class associated with basic bolt-bearing stress

Loading direction	Basic bolt-bearing stress for species group (MPa (lb in ⁻²))		L/D adjustment (Table 8–13)
	Softwoods	Hardwoods	
Parallel	<7.93 (<1,150)	<7.33 (<1,063)	1
	7.93–10.37 (1,150–1,504)	7.33–9.58 (1,063–1,389)	2
	>10.37 (>1,504)	>9.58 (>1,389)	3
Perpendicular	<1.31 (<190)	<1.44 (<209)	1
	1.31–2.00 (190–290)	1.44–2.20 (209–319)	2
	2.00–2.59 (291–375)	2.21–2.84 (320–412)	3
	>2.59 (>375)	>2.84 (>412)	4

Table 8–15. Factors for adjusting basic bolt-bearing stress perpendicular to grain for bolt diameter when calculating allowable bolt loads

Bolt diameter (mm (in.))	Adjustment factor
6.35 (1/4)	2.50
9.53 (3/8)	1.95
12.70 (1/2)	1.68
15.88 (5/8)	1.52
19.05 (3/4)	1.41
22.23 (7/8)	1.33
25.40 (1)	1.27
31.75 (1-1/4)	1.19
38.10 (1-1/2)	1.14
44.45 (1-3/4)	1.10
50.80 (2)	1.07
63.50 (2-1/2)	1.03
>76.20 (>3 or over)	1.00

a minimum of one-half the thickness of the main member. The single-bolt value must then be modified for any variation from these reference conditions. The theoretical approach, after 1991, is more general and is not limited to these reference conditions.

The theoretical approach is based on work done in Europe (Johansen 1949) and is referred to as the European Yield Model (EYM). The EYM describes a number of possible yield modes that can occur in a dowel-type connection (Fig. 8–5). The yield strength of these different modes is determined from a static analysis that assumes the wood and the bolt are both perfectly plastic. The yield mode that results in the lowest yield load for a given geometry is the theoretical connection yield load.

Equations corresponding to the yield modes for a three-member joint are given in Table 8–16. (Equations for two-member allowable values are given in the NDS.) The nominal single-bolt value is dependent on the joint geometry (thickness of main and side members), bolt diameter and bending yield strength, dowel bearing strength, and direction of load to the grain. The equations are equally valid

Table 8–16. The 5% offset yield lateral strength (Z) for three-member bolted joints

Mode	Z value for three-member bolted joint
Mode I _m	$\frac{Dt_m F_{em}}{K_\theta}$
Mode I _s	$\frac{2Dt_s F_{es}}{K_\theta}$
Mode III _s	$\frac{2k_4 Dt_s F_{em}}{(2 + R_e) K_\theta}$
Mode IV	$\frac{2D^2}{K_\theta} \sqrt{\frac{2F_{em} F_{yb}}{3(1 + R_e)}}$

Definitions

- D* nominal bolt diameter, mm (in.)
- F_{em}* dowel bearing strength of main (center) member, MPa (lb in⁻²)
- F_{es}* dowel bearing strength of side members, MPa (lb in⁻²)
- F_{yb}* bending yield strength of bolt, MPa (lb in⁻²)
- K_θ* 1 + θ/360
- t_m* thickness of main (center) member, mm (in.)
- t_s* thickness of side member, mm (in.)
- Z* nominal single bolt design value
- θ angle of load to grain (degrees)
- R_e* = *F_{em}*/*F_{es}*

$$k_4 = -1 + \sqrt{\frac{2(1 + R_e)}{R_e} + \frac{2F_{yb}(2 + R_e)D^2}{3F_{em}t_s^2}}$$

for wood or steel side members, which is taken into account by thickness and dowel bearing strength parameters. The equations are also valid for various load-to-grain directions, which are taken into account by the *K_θ* and *F_e* parameter.

The dowel bearing strength is a material property not generally familiar to structural designers. The dowel bearing strength of the wood members is determined from tests that relate species specific gravity and dowel diameter to bearing strength. Empirical equations for these relationships are as follows:

Parallel to grain

$$F_e = 77.2G \quad (\text{metric}) \quad (8-17a)$$

$$F_e = 11,200G \quad (\text{inch-pound}) \quad (8-17b)$$

Perpendicular to grain

$$F_e = 212.0G^{1.45} D^{-0.5} \quad (\text{metric}) \quad (8-18a)$$

$$F_e = 6,100G^{1.45} D^{-0.5} \quad (\text{inch-pound}) \quad (8-18b)$$

where *F_e* is dowel bearing strength (MPa, lb in⁻²), *G* specific gravity based on oven-dry weight and volume, and *D* bolt diameter (mm, in.).

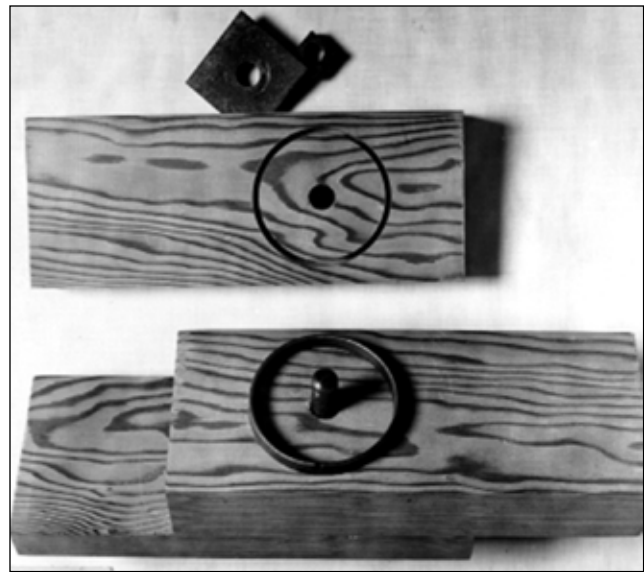

Figure 8–16. Joint with split-ring connector showing connector, precut groove, bolt, washer, and nut.

For other angles of loading, the dowel bearing strength values for use in the yield model are determined by the Hankinson equation, where *P* and *Q* are the values of dowel bearing parallel and perpendicular to grain, respectively.

Connector Joints

Several types of connectors have been devised that increase joint bearing and shear areas by utilizing rings or plates around bolts holding joint members together. The primary load-carrying portions of these joints are the connectors; the bolts usually serve to prevent transverse separation of the members but do contribute some load-carrying capacity.

The strength of the connector joint depends on the type and size of the connector, the species of wood, the thickness and width of the member, the distance of the connector from the end of the member, the spacing of the connectors, the direction of application of the load with respect to the direction of the grain of the wood, and other factors. Loads for wood joints with steel connectors—split ring (Fig. 8–16) and shear plate (Fig. 8–17)—are discussed in this section. These connectors require closely fitting machined grooves in the wood members.

Parallel-to-Grain Loading

Tests have demonstrated that the density of the wood is a controlling factor in the strength of connector joints. For split-ring connectors, both maximum load and proportional limit load parallel to grain vary linearly with specific gravity (Figs. 8–18 and 8–19). For shear plates, the maximum load and proportional limit load vary linearly with specific gravity for the less dense species (Figs. 8–20 and 8–21). In the higher density species, the shear strength of the bolts becomes the controlling factor. These relations were

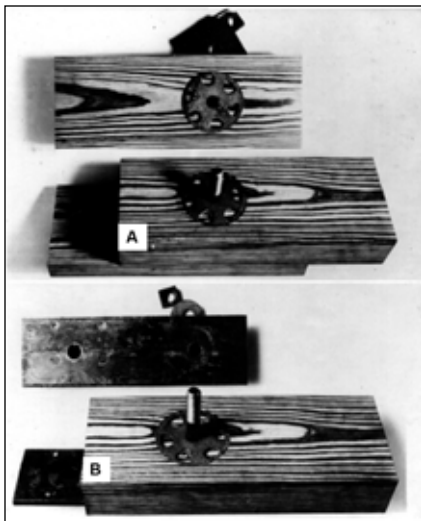

Figure 8-17. Joints with shear-plate connectors with (A) wood side plates and (B) steel side plates.

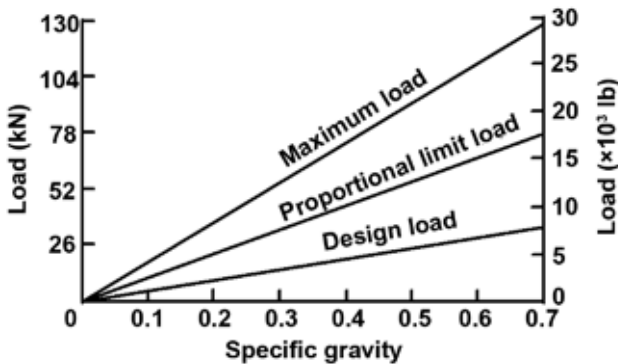

Figure 8-18. Relation between load bearing parallel to grain and specific gravity (ovendry weight, volume at test) for two 63.5-mm (2-1/2-in.) split rings with a single 12.7-mm (1/2-in.) bolt in air-dry material. Center member was thickness 101.6 mm (4 in.) and side member thickness was 50.8 mm (2 in.).

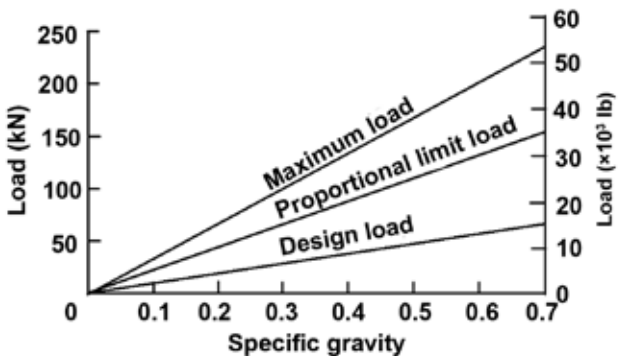

Figure 8-19. Relation between load bearing parallel to grain and specific gravity (ovendry weight, volume at test) for two 101.6-mm (4-in.) split rings and a single 19.1-mm- (3/4-in.-) diameter bolt in air-dry material. Center member thickness was 127.0 mm (5 in.) and side member thickness was 63.5 mm (2-1/2 in.).

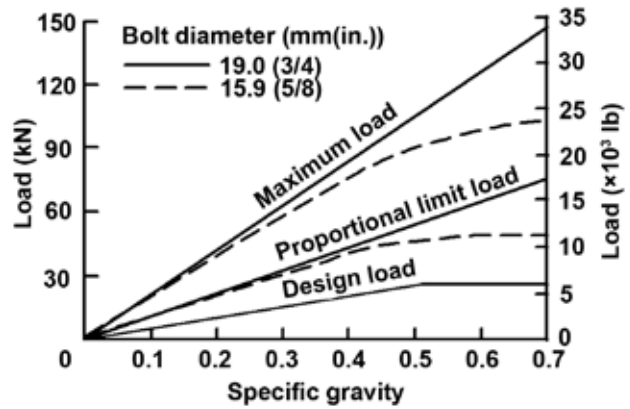

Figure 8-20. Relation between load bearing parallel to grain and specific gravity (ovendry weight, volume at test) for two 66.7-mm (2-5/8-in.) shear plates in air-dry material with steel side plates. Center member thickness was 76.2 mm (3 in.).

obtained for seasoned members, approximately 12% moisture content.

Perpendicular-to-Grain Loading

Loads for perpendicular-to-grain loading have been established using three-member joints with the side members loaded parallel to grain. Specific gravity is a good indicator of perpendicular-to-grain strength of timber connector joints. For split-ring connectors, the proportional limit loads perpendicular to grain are 58% of the parallel-to-grain proportional limit loads. The joint deformation at proportional limit is 30% to 50% more than for parallel-to-grain loading.

For shear-plate connectors, the proportional limit and maximum loads vary linearly with specific gravity (Figs. 8-22 and 8-23). The wood strength controls the joint strength for all species.

Design Loads

Design loads for parallel-to-grain loading have been established by dividing ultimate test loads by an average factor of 4. This gives values that do not exceed five-eighths of the proportional limit loads. The reduction accounts for variability in material, a reduction to long-time loading, and a factor of safety. Design loads for normal duration of load are 10% higher.

For perpendicular-to-grain loading, ultimate load is given less consideration and greater dependence placed on load at proportional limit. For split rings, the proportional limit load is reduced by approximately half. For shear plates, the design loads are approximately five-eighths of the proportional limit test loads. These reductions again account for material variability, a reduction to long-time loading, and a factor of safety.

Design loads are presented in Figures 8-18 to 8-23. In practice, four wood species groups have been established, based

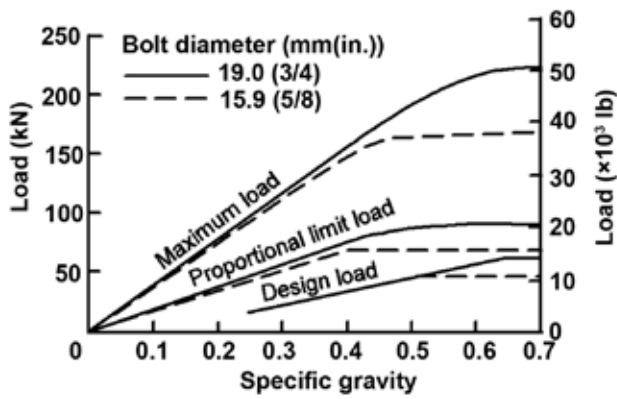

Figure 8-21. Relation between load bearing parallel to grain and specific gravity (ovendry weight, volume at test) for two 101.6-mm (4-in.) shear plates in air-dry material with steel side plates. Center member thickness was 88.9 mm (3-1/2 in.).

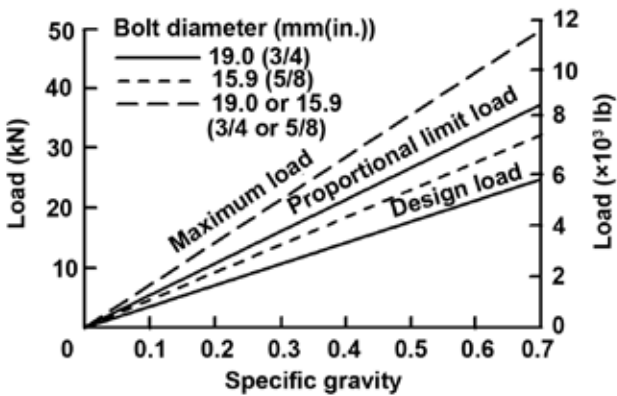

Figure 8-22. Relation between load bearing perpendicular to grain and specific gravity (ovendry weight, volume at test) for two 66.7-mm (2-5/8-in.) shear plates in air-dry material with steel side plates. Center member thickness was 76.2 mm (3 in.).

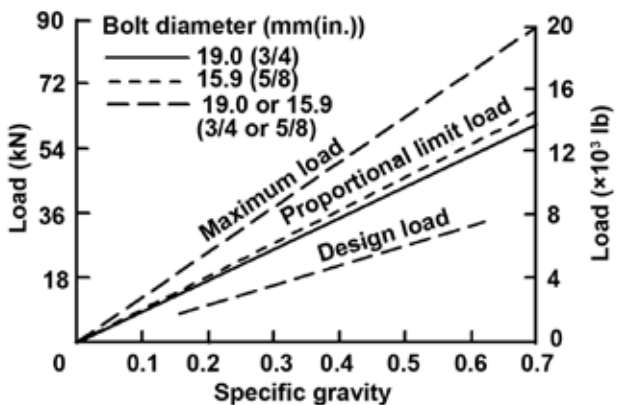

Figure 8-23. Relation between load bearing perpendicular to grain and specific gravity (ovendry weight, volume at test) for two 101.6-mm (4-in.) shear plates in air-dry material with steel side plates. Center member thickness was 88.9 mm (3-1/2 in.).

Table 8-17. Species groupings for connector loads^a

Connector	Species or species group		
Group 1	Aspen	Basswood	Cottonwood
	Western redcedar	Balsam fir	White fir
	Eastern hemlock	Eastern white pine	Ponderosa pine
	Sugar pine	Western white pine	Engelmann spruce
Group 2	Chestnut	Yellow-poplar	Baldcypress
	Yellow-cedar	Port-Orford-cedar	Western hemlock
	Red pine	Redwood	Red spruce
Group 3	Sitka spruce	White spruce	
	Elm, American	Elm, slippery	Maple, soft
	Sweetgum	Sycamore	Tupelo
Group 4	Douglas-fir	Larch, western	Southern Pine
	Ash, white	Beech	Birch
	Elm, rock	Hickory	Maple, hard
	Oak		

^aGroup 1 woods provide the weakest connector joints; group 4 woods, the strongest.

primarily on specific gravity, and design loads assigned for each group. Species groupings for connectors are presented in Table 8-17. The corresponding design loads (for long-continued load) are given in Table 8-18. The *National Design Specification for Wood Construction* gives design values for normal-duration load for these and additional species.

Modifications

Some factors that affect the loads of connectors were taken into account in deriving the tabular values. Other varied and extreme conditions require modification of the values.

Steel Side Plates

Steel side plates are often used with shear-plate connectors. The loads parallel to grain have been found to be approximately 10% higher than those with wood side plates. The perpendicular-to-grain loads are unchanged.

Exposure and Moisture Condition of Wood

The loads listed in Table 8-18 apply to seasoned members used where they will remain dry. If the wood will be more or less continuously damp or wet in use, two-thirds of the tabulated values should be used. The amount by which the loads should be reduced to adapt them to other conditions of use depends upon the extent to which the exposure favors decay, the required life of the structure or part, the frequency and thoroughness of inspection, the original cost and the cost of replacements, the proportion of sapwood and durability of the heartwood of the species (if untreated), and the character and efficacy of any treatment. These factors should be evaluated for each individual design. Industry recommendations for the use of connectors when the condition of the lumber is other than continuously wet or continuously dry are given in the *National Design Specification for Wood Construction*.

Table 8–18. Design loads for one connector in a joint^a

Connector	Minimum thickness of wood member (mm (in.))		Minimum width all members (mm (in.))	Load (N (lb))							
				Group 1 woods		Group 2 woods		Group 3 woods		Group 4 woods	
	With one connector only	With two connectors in opposite faces, one bolt ^b		At 0° angle to grain	At 90° angle to grain	At 0° angle to grain	At 90° angle to grain	At 0° angle to grain	At 90° angle to grain	At 0° angle to grain	At 90° angle to grain
Split ring											
63.5-mm (2-1/2-in.) diameter, 19.0 mm (3/4 in.) wide, with 12.7-mm (1/2-in.) bolt	25 (1)	51 (2)	89 (3-1/2)	7,940 (1,785)	4,693 (1,055)	9,274 (2,085)	5,471 (1,230)	11,032 (2,480)	6,561 (1,475)	12,789 (2,875)	7,673 (1,725)
101.6-mm (4-in.) diameter, 25.4 mm (1 in.) wide, with 19.0-mm (3/4-in.) bolt	38 (1-1/2)	76 (3)	140 (5-1/2)	15,324 (3,445)	8,874 (1,995)	17,726 (3,985)	10,275 (2,310)	21,262 (4,780)	12,344 (2,775)	24,821 (5,580)	14,390 (3,235)
Shear plate											
66.7-mm (2-5/8-in.) diameter, 10.7 mm (0.42 in.) wide, with 19.0-mm (3/4-in.) bolt	38 (1-1/2)	67 (2-5/8)	89 (3-1/2)	8,407 (1,890)	4,871 (1,095)	9,742 (2,190)	5,649 (1,270)	11,699 (2,630)	6,784 (1,525)	11,854 (2,665)	7,918 (1,780)
101.6-mm (4-in.) diameter, 16.2 mm (0.64 in.) wide, with 19.0-mm or 22.2-mm (3/4- or 7/8-in.) bolt	44 (1-3/4)	92 (3-5/8)	140 (5-1/2)	12,677 (2,850)	7,362 (1,655)	14,701 (3,305)	8,518 (1,915)	17,637 (3,965)	10,231 (2,300)	20,573 (4,625)	11,943 (2,685)

^aThe loads apply to seasoned timbers in dry, inside locations for a long-continued load. It is also assumed that the joints are properly designed with respect to such features as centering of connectors, adequate end distance, and suitable spacing. Group 1 woods provide the weakest connector joints, group 4 woods the strongest. Species groupings are given in Table 8–17.

^bA three-member assembly with two connectors takes double the loads indicated.

Ordinarily, before fabrication of connector joints, members should be seasoned to a moisture content corresponding as nearly as practical to that which they will attain in service. This is particularly desirable for lumber for roof trusses and other structural units used in dry locations and in which shrinkage is an important factor. Urgent construction needs sometimes result in the erection of structures and structural units employing green or inadequately seasoned lumber with connectors. Because such lumber subsequently dries out in most buildings, causing shrinkage and opening the joints, adequate maintenance measures must be adopted. The maintenance for connector joints in green lumber should include inspection of the structural units and tightening of all bolts as needed during the time the units are coming to moisture equilibrium, which is normally during the first year.

Grade and Quality of Lumber

The lumber for which the loads for connectors are applicable should conform to the general requirements in regard to quality of structural lumber given in the grading rule books of lumber manufacturers’ associations for various commercial species.

The loads for connectors were obtained from tests of joints whose members were clear and free from checks, shakes,

and splits. Cross grain at the joint should not be steeper than 1 in 10, and knots in the connector area should be accounted for as explained under Net Section.

Loads at Angle with Grain

The loads for the split-ring and shear-plate connectors for angles of 0° to 90° between direction of load and grain may be obtained by the Hankinson equation (Eq. (8–16)).

Thickness of Member

The relationship between loads for different thicknesses of lumber is based on test results for connector joints. The least thickness of member given in Table 8–18 for the various sizes of connectors is the minimum to obtain optimum load. The loads listed for each type and size of connector are the maximum loads to be used for all thicker lumber. The loads for wood members of thicknesses less than those listed can be obtained by the percentage reductions indicated in Figure 8–24. Thicknesses below those indicated by the curves should not be used.

When one member contains a connector in only one face, loads for thicknesses less than those listed in Table 8–18 can be obtained by the percentage reductions indicated in Figure 8–24 using an assumed thickness equal to twice the actual member thickness.

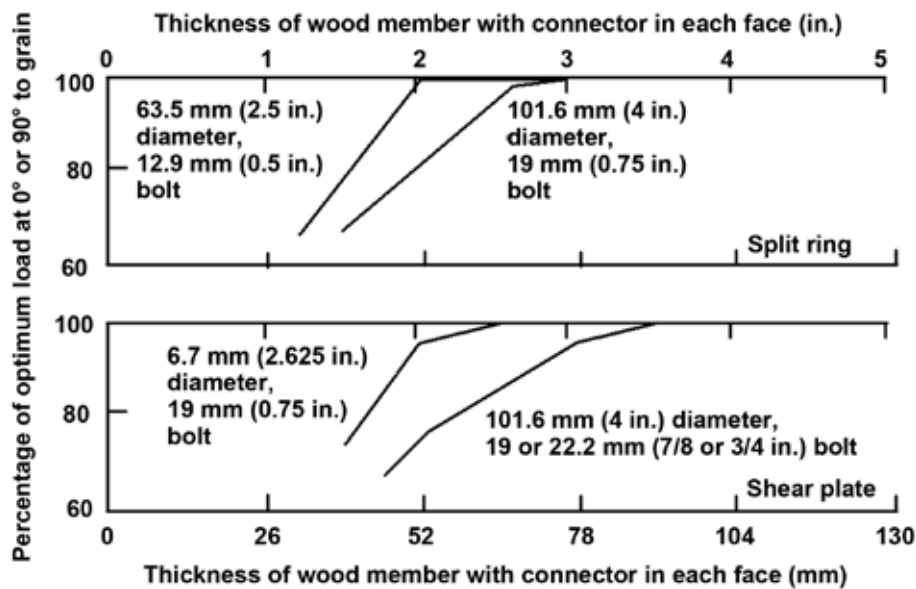

Figure 8–24. Effect of thickness of wood member on the optimum load capacity of a timber connector.

Width of Member

The width of member listed for each type and size of connector is the minimum that should be used. When the connectors are bearing parallel to the grain, no increase in load occurs with an increase in width. When they are bearing perpendicular to the grain, the load increases about 10% for each 25-mm (1-in.) increase in width of member over the minimum widths required for each type and size of connector, up to twice the diameter of the connectors. When the connector is placed off center and the load is applied continuously in one direction only, the proper load can be determined by considering the width of member as equal to twice the edge distance (the distance between the center of the connector and the edge of the member toward which the load is acting). The distance between the center of the connector and the opposite edge should not, however, be less than half the permissible minimum width of the member.

Net Section

The net section is the area remaining at the critical section after subtracting the projected area of the connectors and bolt from the full cross-sectional area of the member. For sawn timbers, the stress in the net area (whether in tension or compression) should not exceed the stress for clear wood in compression parallel to the grain. In using this stress, it is assumed that knots do not occur within a length of half the diameter of the connector from the net section. If knots are present in the longitudinal projection of the net section within a length from the critical section of one-half the diameter of the connector, the area of the knots should be subtracted from the area of the critical section.

In laminated timbers, knots may occur in the inner laminations at the connector location without being apparent from the outside of the member. It is impractical to ensure that there are no knots at or near the connector. In laminated construction, therefore, the stress at the net section is limited to the compressive stress for the member, accounting for the effect of knots.

End Distance and Spacing

The load values in Table 8–18 apply when the distance of the connector from the end of the member (end distance e) and the spacing s between connectors in multiple joints are not factors affecting the strength of the joint (Fig. 8–25A). When the end distance or spacing for connectors bearing parallel to the grain is less than that required to develop the full load, the proper reduced load may be obtained by multiplying the loads in Table 8–18 by the appropriate strength ratio given in Table 8–19. For example, the load for a 102-mm (4-in.) split-ring connector bearing parallel to the grain, when placed 178 mm or more (7 in. or more) from the end of a Douglas-fir tension member that is 38 mm (1-1/2 in.) thick is 21.3 kN (4,780 lb). When the end distance is only 133 mm (5-1/4 in.), the strength ratio obtained by direct interpolation between 178 and 89 mm (7 and 3-1/2 in.) in Table 8–19 is 0.81, and the load equals 0.81 times 21.3 (4,780) or 17.2 kN (3,870 lb).

Placement of Multiple Connectors

Preliminary investigations of the placement of connectors in a multiple-connector joint, together with the observed behavior of single-connector joints tested with variables that simulate those in a multiple-connector joint, are the basis for some suggested design practices.

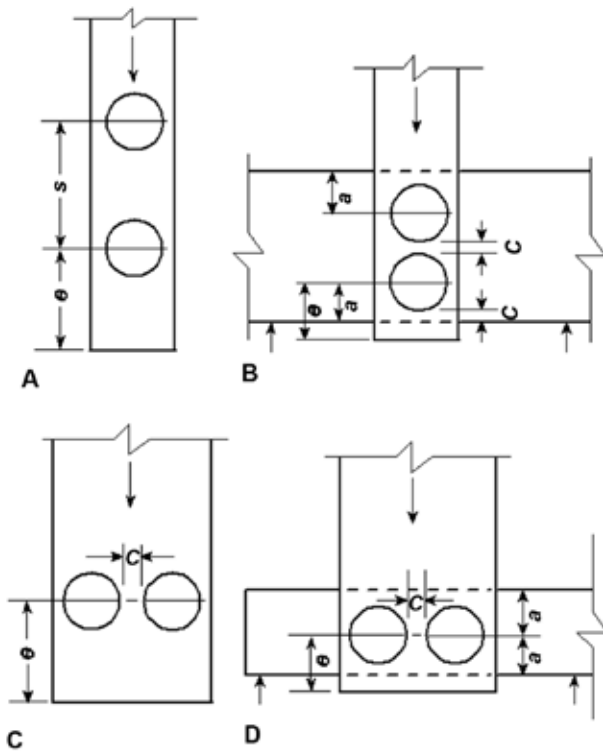

Figure 8–25. Types of multiple-connector joints: A, joint strength depends on end distance e and connector spacing s ; B, joint strength depends on e , clear c , and edge a distances; C, joint strength depends on end e and clear c distances; D, joint strength depends on end e , clear c , and edge a distances.

When two or more connectors in the same face of a member are in a line at right angles to the grain of the member and are bearing parallel to the grain (Fig. 8–25C), the clear distance c between the connectors should not be less than 12.7 mm (1/2 in.). When two or more connectors are acting perpendicular to the grain and are spaced on a line at right angles to the length of the member (Fig. 8–25B), the rules for the width of member and edge distances used with one connector are applicable to the edge distances for multiple connectors. The clear distance c between the connectors should be equal to the clear distance from the edge of the member toward which the load is acting to the connector nearest this edge.

In a joint with two or more connectors spaced on a line parallel to the grain and with the load acting perpendicular to the grain (Fig. 8–25D), the available data indicate that the load for multiple connectors is not equal to the sum of the loads for individual connectors. Somewhat more favorable results can be obtained if the connectors are staggered so that they do not act along the same line with respect to the grain of the transverse member. Industry recommendations for various angle-to-grain loadings and spacings are given in the *National Design Specification for Wood Construction*.

Cross Bolts

Cross bolts or stitch bolts placed at or near the end of members joined with connectors or at points between connectors will provide additional safety. They may also be used to reinforce members that have, through change in moisture content in service, developed splits to an undesirable degree.

Multiple-Fastener Joints

When fasteners are used in rows parallel to the direction of loading, total joint load is unequally distributed among fasteners in the row. Simplified methods of analysis have been developed to predict the load distribution among the fasteners in a row below the proportional limit. These analyses indicate that the elastic load distribution is a function of (a) the extensional stiffness EA of the joint members, where E is modulus of elasticity and A is gross cross-sectional area, (b) the fastener spacing, (c) the number of fasteners, and (d) the single-fastener load–deformation characteristics.

Theoretically, the two end fasteners carry a majority of the load. For example, in a row of six bolts, the two end bolts will carry more than 50% of the total joint load. Adding bolts to a row tends to reduce the load on the less heavily loaded interior bolts. The most even distribution of bolt loads occurs in a joint where the extensional stiffness of the main member is equal to that of both splice plates. Increasing the fastener spacing tends to put more of the joint load on the end fasteners. Load distribution tends to be worse for stiffer fasteners.

The actual load distribution in field-fabricated joints is difficult to predict. Small misalignment of fasteners, variations in spacing between side and main members, and variations in single-fastener load–deformation characteristics can cause the load distribution to be different than predicted by the theoretical analyses.

For design purposes, modification factors for application to a row of bolts, lag screws, or timber connectors have been developed based on the theoretical analyses. Tables are given in the *National Design Specification for Wood Construction*.

A design equation was developed to replace the double entry required in the *National Design Specification for Wood Construction* tables. This equation was obtained by algebraic simplification of the Lantos analysis that these tables are based on:

$$C_g = \left[\frac{m(1-m^{2n})}{n[(1+R_{EA}m^n)(1+m)-1+m^{2n}]} \right] \left(\frac{1+R_{EA}}{1-m} \right) \quad (8-19)$$

where C_g is modification factor, n number of fasteners in a row, R_{EA} the lesser of $(E_s A_s)/(E_m A_m)$ or $(E_m A_m)/(E_s A_s)$, E_m modulus of elasticity of main member, E_s modulus of elasticity of side members, A_m gross cross-sectional area of main member, A_s sum of gross cross-sectional areas of side

Table 8–19. Strength ratio for connectors for various longitudinal spacings and end distances^a

Connector diameter (mm (in.))	Spacing ^c (mm (in.))		End distance ^b (mm (in.))		
			Tension member	Compression member	End distance strength ratio
Split-ring					
63.5 (2-1/2)	171.4+ (6-3/4+)	100	139.7+ (5-1/2+)	101.6+ (4+)	100
63.5 (2-1/2)	85.7 (3-3/8)	50	69.8 (2-3/4)	63.5 (2-1/2)	62
101.6 (4)	228.6+ (9+)	100	177.8+ (7+)	139.7+ (5-1/2+)	100
101.6 (4)	123.8 (4-7/8)	50	88.9 (3-1/2)	82.6 (3-1/4)	62
Shear-plate					
66.7 (2-5/8)	171.4+ (6-3/4+)	100	139.7+ (5-1/2+)	101.6+ (4+)	100
66.7 (2-5/8)	85.7 (3-3/8)	50	69.8 (2-3/4)	63.5 (2-1/2)	62
101.6 (4)	228.6+ (9+)	100	177.8+ (7+)	139.7+ (5-1/2+)	100
101.6 (4)	114.3 (4-1/2)	50	88.9 (3-1/2)	82.6 (3-1/4)	62

^aStrength ratio for spacings and end distances intermediate to those listed may be obtained by interpolation and multiplied by the loads in Table 8–18 to obtain design load. The strength ratio applies only to those connector units affected by the respective spacings or end distances. The spacings and end distances should not be less than the minimum shown.

^bEnd distance is distance from center of connector to end of member (Fig. 8–25A).

^cSpacing is distance from center to center of connectors (Fig. 8–25A).

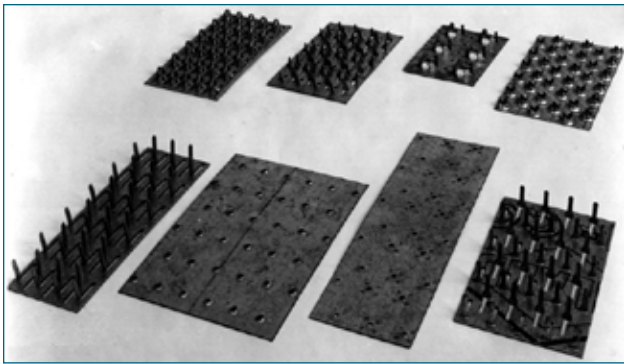

Figure 8–26. Some typical metal plate connectors.

members, $m = u - \sqrt{u^2 - 1}$, $u = 1 + \gamma(s/2)(1/E_m A_m + 1/E_s A_s)$, s center-to-center spacing between adjacent fasteners in a row, and γ load/slip modulus for a single fastener connection. For 102-mm (4-in.) split-ring or shear-plate connectors,

$$\gamma = 87,560 \text{ kN m}^{-1} \text{ (500,000 lb in}^{-1}\text{)}$$

For 64-mm (2-1/2-in.) split ring or 67-mm (2-5/8-in.) split ring or shear plate connectors,

$$\gamma = 70,050 \text{ kN m}^{-1} \text{ (400,000 lb in}^{-1}\text{)}$$

For bolts or lag screws in wood-to-wood connections,

$$\begin{aligned} \gamma &= 246.25 D^{1.5} && \text{(metric)} \\ &= 180,000 D^{1.5} && \text{(inch–pound)} \end{aligned}$$

For bolts or lag screws in wood-to-metal connections,

$$\begin{aligned} \gamma &= 369.37 D^{1.5} && \text{(metric)} \\ &= 270,000 D^{1.5} && \text{(inch–pound)} \end{aligned}$$

where D is diameter of bolt or lag screw.

Metal Plate Connectors

Metal plate connectors, commonly called truss plates, have become a popular means of joining, especially in trussed rafters and joists. These connectors transmit loads by means of teeth, plugs, or nails, which vary from manufacturer to manufacturer. Examples of such plates are shown in Figure 8–26. Plates are usually made of light-gauge galvanized steel and have an area and shape necessary to transmit the forces on the joint. Installation of plates usually requires a hydraulic press or other heavy equipment, although some plates can be installed by hand.

Basic strength values for plate connectors are determined from load–slip curves from tension tests of two butted wood members joined with two plates. Some typical curves are shown in Figure 8–27. Design values are expressed as load per tooth, nail, plug, or unit area of plate. The smallest value as determined by two different means is the design load for normal duration of load: (1) the average load of at least five specimens at 0.38-mm (0.015-in.) slip from plate to wood member or 0.76-mm (0.030-in.) slip from member to member is divided by 1.6; (2) the average ultimate load of at least five specimens is divided by 3.0.

The strength of a metal plate joint may also be controlled by the tensile or shear strength of the plate.

Joist Hangers

Joist hangers have become a popular means of joining wood-based joists to header beams or columns. Hangers are usually made of light-gauge steel or welded from plate steel with shape and configuration necessary to transmit forces through the joint. Loads are transmitted from the joist to the hanger primarily through direct bearing of the joist, but for the uplift forces, load transfer is due to lateral loading of fasteners. How loads are transferred from the hanger to

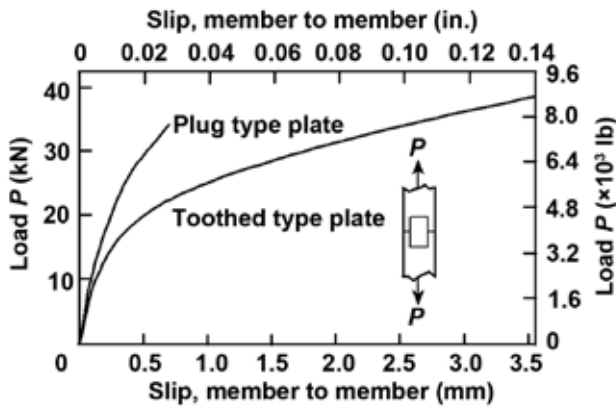

Figure 8-27. Typical load-slip curves for two types of metal plate connectors loaded in tension.

the header differs depending on whether the joist hanger is a face mount or top mount. Face-mount hangers transmit loads through lateral loading of dowel-type fasteners; top-mount hangers transmit loads by bearing on the top of the header and lateral loading of the dowel type fasteners. Design of the joist hanger varies from manufacturer to manufacturer. Examples of such plates are shown in Figure 8-28.

Design loads are limited to the lowest values determined by experiment or by calculations. By experiment, design loads for joist hangers are determined from tests in which a joist is loaded at midspan and supported by two joist hangers attached to headers, following ASTM D 7147 procedures. The smallest value as determined by two different means is the test design load for normal duration of load: (1) the average load at 3.2-mm (0.125-in.) deformation between the joist and header of at least six specimens and (2) the average ultimate load of at least six specimens divided by 3.0 or the least ultimate load for lower than six replicates divided by 3.0. Design loads for calculations are also highlighted in ASTM D 7147.

Fastener Head Embedment

The bearing strength of wood under fastener heads is important in such applications as the anchorage of building framework to foundation structures. When pressure tends to pull the framing member away from the foundation, the fastening loads could cause tensile failure of the fastenings, withdrawal of the fastenings from the framing member, or



Figure 8-28. Typical joist hanger connectors.

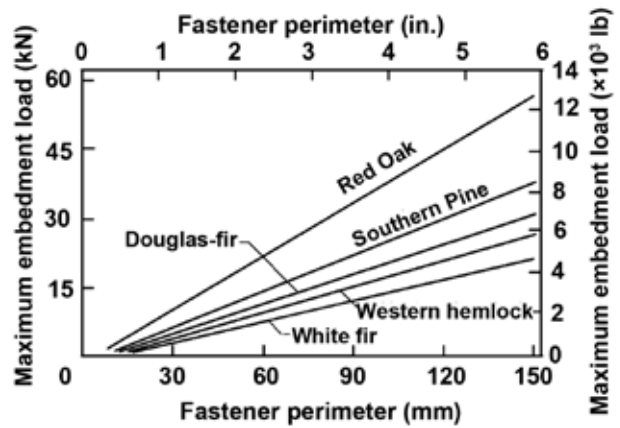

Figure 8-29. Relation between maximum embedment load and fastener perimeter for several species of wood.

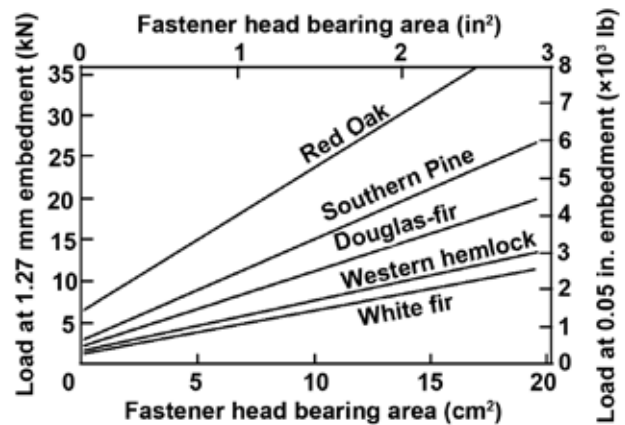

Figure 8-30. Relation between load at 1.27-mm (0.05-in.) embedment and fastener bearing area for several species.

embedment of the fastener heads in the member. The fastener head could even be pulled completely through.

The maximum load for fastener head embedment is related to the fastener head perimeter, whereas loads at low embedments (1.27 mm (0.05 in.)) are related to the fastener head bearing area. These relations for several species at 10% moisture content are shown in Figures 8-29 and 8-30.

When annularly threaded nails are used for withdrawal applications, fastener head embedment or pull-through can be a limiting condition and should be considered in design.

Literature Cited

Johansen, K.W. 1949. Theory of timber connections. Zurich, Switzerland: Publication of International Association for Bridge and Structural Engineering. 9: 249–262.

Additional References

AF&PA. 2005. National design specification for wood construction. Washington, DC: American Forest & Paper Association.

Anderson, L.O. 1959. Nailing better wood boxes and crates. Agric. Handb. 160. Washington, DC: U.S. Department of Agriculture.

Anderson, L.O. 1970. Wood-frame house construction. Agric. Handb. 73 (rev.). Washington, DC: U.S. Department of Agriculture.

ASCE. 1996. Mechanical connections in wood structures. Washington, DC: American Society of Civil Engineers.

ASTM. [Current edition]. West Conshohocken, PA: American Society for Testing and Materials.

ASTM D 1761–88. Standard test methods for mechanical fasteners in wood.

ASTM D 2555–96. Standard methods for establishing clear wood strength values.

ASTM D 5652–95. Standard test methods for bolted connections in wood and wood-base products.

ASTM D 7147–05 Standard specifications for testing and establishing allowable loads of joist hangers.

ASTM F 547. Standard terminology of nails for use with wood and wood-base materials.

ASTM F 1575–03 Standard test method for determining bending yield moment of nails.

ASTM F 1667. Specification for driven fasteners: nails, spiker, staples.

Cramer, C.O. 1968. Load distribution in multiple-bolt tension joints. Proc. Pap. 5939. Journal of Structural Division, American Society of Civil Engineers. 94(ST5): 1101–1117.

Doyle, D.V.; Scholten, J.A. 1963. Performance of bolted joints in Douglas-fir. Res. Pap. FPL 2. Madison, WI: U.S. Department of Agriculture, Forest Service, Forest Products Laboratory.

Eckelman, C.A. 1975. Screw holding performance in hardwoods and particleboard. Forest Products Journal. 25(6): 30–35.

Fairchild, I.J. 1926. Holding power of wood screws. Technol. Pap. 319. Washington, DC: U.S. National Bureau of Standards.

Folz, B.; Filiatrault, A. 2001. Cyclic analysis of wood shear walls. ASCE Journal of Structural Engineering. 127(4): 433–441.

FPL. 1962. General observations on the nailing of wood. FPL Tech. Note 243. Madison, WI: U.S. Department of Agriculture, Forest Service, Forest Products Laboratory.

FPL. 1964. Nailing dense hardwoods. Research Note FPL–037. Madison, WI: U.S. Department of Agriculture, Forest Service, Forest Products Laboratory.

FPL. 1965. Nail withdrawal resistance of American woods. Res. Note FPL–RN–033. Madison, WI: U.S. Department of Agriculture, Forest Service, Forest Products Laboratory.

Goodell, H.R.; Philipps, R.S. 1944. Bolt-bearing strength of wood and modified wood: effect of different methods of drilling bolt holes in wood and plywood. FPL Report 1523. Madison, WI: U.S. Department of Agriculture, Forest Service, Forest Products Laboratory.

Jordan, C.A. 1963. Response of timber joints with metal fasteners to lateral impact loads. FPL Rep. 2263. Madison, WI: U.S. Department of Agriculture, Forest Service, Forest Products Laboratory.

Kuenzi, E.W. 1951. Theoretical design of a nailed or bolted joint under lateral load. FPL Rep. 1951. Madison, WI: U.S. Department of Agriculture, Forest Service, Forest Products Laboratory.

Kurtenacker, R.S. 1965. Performance of container fasteners subjected to static and dynamic withdrawal. Res. Pap. FPL 29. Madison, WI: U.S. Department of Agriculture, Forest Service, Forest Products Laboratory.

Lantos, G. 1969. Load distribution in a row of fasteners subjected to lateral load. Madison, WI: Wood Science. 1(3): 129–136.

Markwardt, L.J. 1952. How surface condition of nails affects their holding power in wood. FPL Rep. D1927. Madison, WI: U.S. Department of Agriculture, Forest Service, Forest Products Laboratory.

Markwardt, L.J.; Gahagan, J.M. 1930. Effect of nail points on resistance to withdrawal. FPL Rep. 1226. Madison, WI: U.S. Department of Agriculture, Forest Service, Forest Products Laboratory.

Markwardt, L.J.; Gahagan, J.M. 1952. Slant driving of nails. Does it pay? Packing and Shipping. 56(10): 7–9,23,25.

McLain, T.E. 1975. Curvilinear load-slip relations in laterally-loaded nailed joints. Fort Collins, CO: Department of Forestry and Wood Science, Colorado State University. Ph.D. dissertation.

Newlin, J.A.; Gahagan, J.M. 1938. Lag screw joints: their behavior and design. Tech. Bull. 597. Washington, DC: U.S. Department of Agriculture.

- NPA. 1968. Screw holding of particleboard. Tech. Bull. 3. Washington, DC: National Particleboard Association.
- Perkins, N.S.; Landsem, P.; Trayer, G.W. 1933. Modern connectors for timber construction. Washington, DC: U.S. Department of Commerce, National Committee on Wood Utilization, and U.S. Department of Agriculture, Forest Service.
- Rammer, D.R.; Mendez, A.M. 2008. Withdrawal strength of post-frame ring shank nails. *Frame Building News*. April. p. 59–67.
- Rammer, D.R.; Zelinka, S.L. 2004. Review of end grain nail withdrawal research. Gen. Tech. Rep. FPL–GTR–151. Madison, WI: U.S. Department of Agriculture, Forest Service, Forest Products Laboratory.
- Rammer, D.R.; Winistorfer, S.G.; Bender, D.A. 2001. Withdrawal strength of threaded nails. *Journal of Structural Engineering*. 127(4): 442–449. April.
- Scholten, J.A. 1944. Timber-connector joints, their strength and design. Tech. Bull. 865. Washington, DC: U.S. Department of Agriculture.
- Scholten, J.A. 1946. Strength of bolted timber joints. FPL Report R1202. Madison, WI: U.S. Department of Agriculture, Forest Service, Forest Products Laboratory.
- Scholten, J.A. 1950. Nail-holding properties of southern hardwoods. *Southern Lumberman*. 181(2273): 208–210.
- Scholten, J.A.; Molander, E.G. 1950. Strength of nailed joints in frame walls. *Agricultural Engineering*. 31(11): 551–555.
- Skulteti, M.J.; Bender, D.A.; Winistorfer, S.G.; Pollock, D.G. 1997. Withdrawal strength of ring-shank nails embedded in southern pine lumber. *Transactions of the ASAE, American Society of Agricultural Engineers*. 40(2): 451–456. February.
- Soltis, L.A.; Wilkinson, T.L. 1987. Bolted connection design. Gen. Tech. Rep. FPL–GTR–54. Madison, WI: U.S. Department of Agriculture, Forest Service, Forest Products Laboratory.
- Stern, E.G. 1940. A study of lumber and plywood joints with metal split-ring connectors. Bull. 53. State College, PA: Pennsylvania Engineering Experiment Station.
- Stern, E.G. 1950. Nails in end-grain lumber. *Timber News and Machine Woodworker*. 58(2138): 490–492.
- Trayer, G.W. 1932. Bearing strength of wood under bolts. Tech. Bull. 332. Washington, DC: U.S. Department of Agriculture.
- Truss Plate Institute. [N.d.] Design specification for metal plate connected wood trusses. TPI–78. Madison, WI: Truss Plate Institute.
- Wilkinson, T.L. 1971. Bearing strength of wood under embedment loading of fasteners. Res. Pap. FPL 163. Madison, WI: U.S. Department of Agriculture, Forest Service, Forest Products Laboratory.
- Wilkinson, T.L. 1971. Theoretical lateral resistance of nailed joints. *Proceedings of American Society of Civil Engineering, Journal of Structural Division*. ST5(97): (Pap. 8121): 1381–1398.
- Wilkinson, T.L. 1978. Strength of bolted wood joints with various ratios of member thicknesses. Res. Pap. FPL 314. Madison, WI: U.S. Department of Agriculture, Forest Service, Forest Products Laboratory.
- Wilkinson, T.L. 1980. Assessment of modification factors for a row of bolts or timber connectors. Res. Pap. FPL 376. Madison, WI: U.S. Department of Agriculture, Forest Service, Forest Products Laboratory.
- Wilkinson, T.L. 1991. Bolted connection allowable loads based on the European yield model. Madison, WI: U.S. Department of Agriculture, Forest Service, Forest Products Laboratory.
- Wilkinson, T.L. 1991. Dowel bearing strength. Res. Pap. FPL–RP–505. Madison, WI: U.S. Department of Agriculture, Forest Service, Forest Products Laboratory.
- Wilkinson, T.L.; Laatsch, T.R. 1970. Lateral and withdrawal resistance of tapping screws in three densities of wood. *Forest Products Journal*. 20(7): 34–41.
- Zahn, J.J. 1991. Design equation for multiple-fastener wood connections. New York, NY: *Journal of Structural Engineering, American Society of Civil Engineers*. Vol. 117(11): 3477–3485. November.
- Zelinka, S.L.; Rammer, D.R. Corrosion rates of fasteners in treated wood exposed to 100% relative humidity. *Journal of Materials in Civil Engineering, American Society of Civil Engineers*. 21(12): 758–763. December.

Structural Analysis Equations

Douglas R. Rammer, Research General Engineer

Contents

Deformation Equations 9-1
Axial Load 9-1
Bending 9-1
Combined Bending and Axial Load 9-3
Torsion 9-4
Stress Equations 9-4
Axial Load 9-4
Bending 9-4
Combined Bending and Axial Load 9-6
Torsion 9-7
Stability Equations 9-7
Axial Compression 9-7
Bending 9-8
Interaction of Buckling Modes 9-9
Literature Cited 9-10
Additional References 9-10

Equations for deformation and stress, which are the basis for tension members and beam and column design, are discussed in this chapter. The first two sections cover tapered members, straight members, and special considerations such as notches, slits, and size effect. A third section presents stability criteria for members subject to buckling and for members subject to special conditions.

Note that this chapter focuses primarily on presenting fundamental mechanics-based equations. For design procedures, the reader is encouraged to contact appropriate industry trade associations or product manufacturers. Current design information can be readily obtained from their web sites, technical handbooks, and bulletins.

Deformation Equations

Equations for deformation of wood members are presented as functions of applied loads, moduli of elasticity and rigidity, and member dimensions. They may be solved to determine minimum required cross-sectional dimensions to meet deformation limitations imposed in design. Average moduli of elasticity and rigidity are given in Chapter 5. Consideration must be given to variability in material properties and uncertainties in applied loads to control reliability of the design.

Axial Load

The deformation of an axially loaded member is not usually an important design consideration. More important considerations will be presented in later sections dealing with combined loads or stability. Axial load produces a change of length given by

$$\delta = \frac{PL}{AE} \quad (9-1)$$

where δ is change of length, L length, A cross-sectional area, E modulus of elasticity (E_L when grain runs parallel to member axis), and P axial force parallel to grain.

Bending

Straight Beam Deflection

The deflection of straight beams that are elastically stressed and have a constant cross section throughout their length is given by

$$\delta = \frac{k_b WL^3}{EI} + \frac{k_s WL}{GA'} \quad (9-2)$$

where δ is deflection, W total beam load acting perpendicular to beam neutral axis, L beam span, k_b and k_s constants

Table 9-1. Values of k_b and k_s for several beam loadings

Loading	Beam ends	Deflection at	k_b	k_s
Uniformly distributed	Both simply supported	Midspan	5/384	1/8
	Both clamped	Midspan	1/384	1/8
Concentrated at midspan	Both simply supported	Midspan	1/48	1/4
	Both clamped	Midspan	1/192	1/4
Concentrated at outer quarter span points	Both simply supported	Midspan	11/768	1/8
	Both simply supported	Load point	1/96	1/8
Uniformly distributed	Cantilever, one free, one clamped	Free end	1/8	1/2
Concentrated at free end	Cantilever, one free, one clamped	Free end	1/3	1

dependent upon beam loading, support conditions, and location of point whose deflection is to be calculated, I beam moment of inertia, A' modified beam area, E beam modulus of elasticity (for beams having grain direction parallel to their axis, $E = E_L$), and G beam shear modulus (for beams with flat-grained vertical faces, $G = G_{LT}$, and for beams with edge-grained vertical faces, $G = G_{LR}$). Elastic property values are given in Tables 5-1 and 5-2 (Chap. 5). The first term on the right side of Equation (9-2) gives the bending deflection and the second term the shear deflection. Values of k_b and k_s for several cases of loading and support are given in Table 9-1.

The moment of inertia I of the beams is given by

$$I = \frac{bh^3}{12} \quad \text{for beam of rectangular cross section} \quad (9-3)$$

$$= \frac{\pi d^4}{64} \quad \text{for beam of circular cross section}$$

where b is beam width, h beam depth, and d beam diameter. The modified area A' is given by

$$A' = \frac{5}{6}bh \quad \text{for beam of rectangular cross section} \quad (9-4)$$

$$= \frac{9}{40}\pi d^2 \quad \text{for beam of circular cross section}$$

If the beam has initial deformations such as bow (lateral bend) or twist, these deformations will be increased by the bending loads. It may be necessary to provide lateral or torsional restraints to hold such members in line. (See Interaction of Buckling Modes section.)

Tapered Beam Deflection

Figures 9-1 and 9-2 are useful in the design of tapered beams. The ordinates are based on design criteria such as span, loading, difference in beam height ($h_c - h_0$) as required by roof slope or architectural effect, and maximum allowable deflection, together with material properties. From this, the value of the abscissa can be determined and the smallest beam depth h_0 can be calculated for comparison with that given by the design criteria. Conversely, the deflection of a beam can be calculated if the value of the abscissa is known. Tapered beams deflect as a result of shear deflection in addition to bending deflections (Figs. 9-1 and 9-2), and this

shear deflection Δ_s can be closely approximated by

$$\Delta_s = \frac{3WL}{20Gbh_0} \quad \text{for uniformly distributed load} \quad (9-5)$$

$$= \frac{3PL}{10Gbh_0} \quad \text{for midspan-concentrated load}$$

The final beam design should consider the total deflection as the sum of the shear and bending deflection, and it may be necessary to iterate to arrive at final beam dimensions. Equations (9-5) are applicable to either single-tapered or double-tapered beams. As with straight beams, lateral or torsional restraint may be necessary.

Effect of Notches and Holes

The deflection of beams is increased if reductions in cross-section dimensions occur, such as by holes or notches. The deflection of such beams can be determined by considering them of variable cross section along their length and appropriately solving the general differential equations of the elastic curves, $EL(d^2y/dx^2) = M$, to obtain deflection expressions or by the application of Castigliano's theorem. (These procedures are given in most texts on strength of materials.)

Effect of Time: Creep Deflections

In addition to the elastic deflections previously discussed, wood beams usually sag in time; that is, the deflection increases beyond what it was immediately after the load was first applied. (See the discussion of creep in Time under Load in Chap. 5.)

Green timbers, in particular, will sag if allowed to dry under load, although partially dried material will also sag to some extent. In thoroughly dried beams, small changes in deflection occur with changes in moisture content but with little permanent increase in deflection. If deflection under longtime load with initially green timber is to be limited, it has been customary to design for an initial deflection of about half the value permitted for longtime deflection. If deflection under longtime load with initially dry timber is to be limited, it has been customary to design for an initial deflection of about two-thirds the value permitted for longtime deflection.

Water Ponding

Ponding of water on roofs already deflected by other loads can cause large increases in deflection. The total short-term

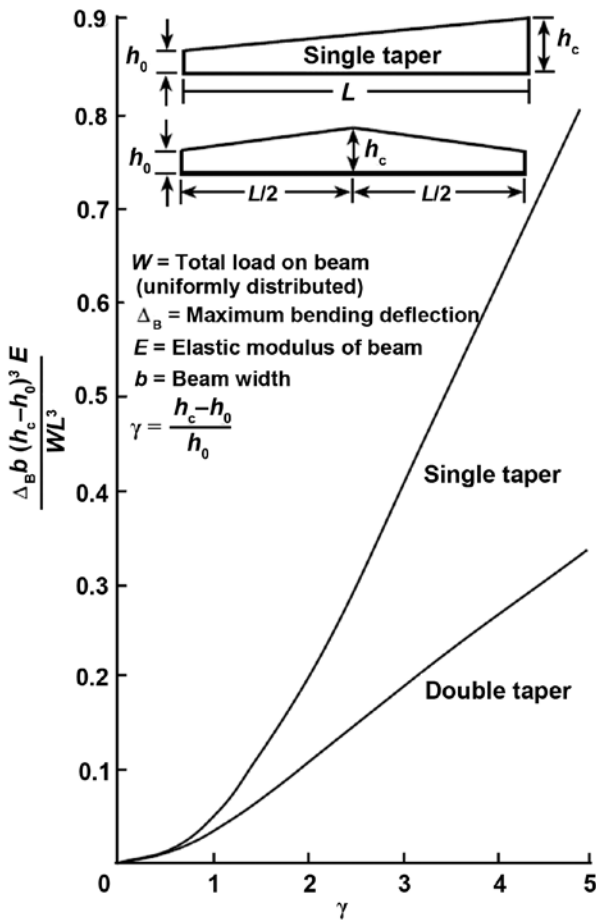

Figure 9-1. Graph for determining tapered beam size based on deflection under uniformly distributed load.

deflection Δ due to design load plus ponded water can be closely estimated by

$$\Delta = \frac{\Delta_0}{1 - S/S_{cr}} \quad (9-6)$$

where Δ_0 is deflection due to design load alone, S beam spacing, and S_{cr} critical beam spacing (Eq. (9-31)).

Combined Bending and Axial Load

Concentric Load

Addition of a concentric axial load to a beam under loads acting perpendicular to the beam neutral axis causes increase in bending deflection for added axial compression and decrease in bending deflection for added axial tension. The deflection under combined loading at midspan for pin-ended members can be estimated closely by

$$\Delta = \frac{\Delta_0}{1 \pm P/P_{cr}} \quad (9-7)$$

where the plus sign is chosen if the axial load is tension and the minus sign if the axial load is compression, Δ is midspan deflection under combined loading, Δ_0 beam midspan deflection without axial load, P axial load, and

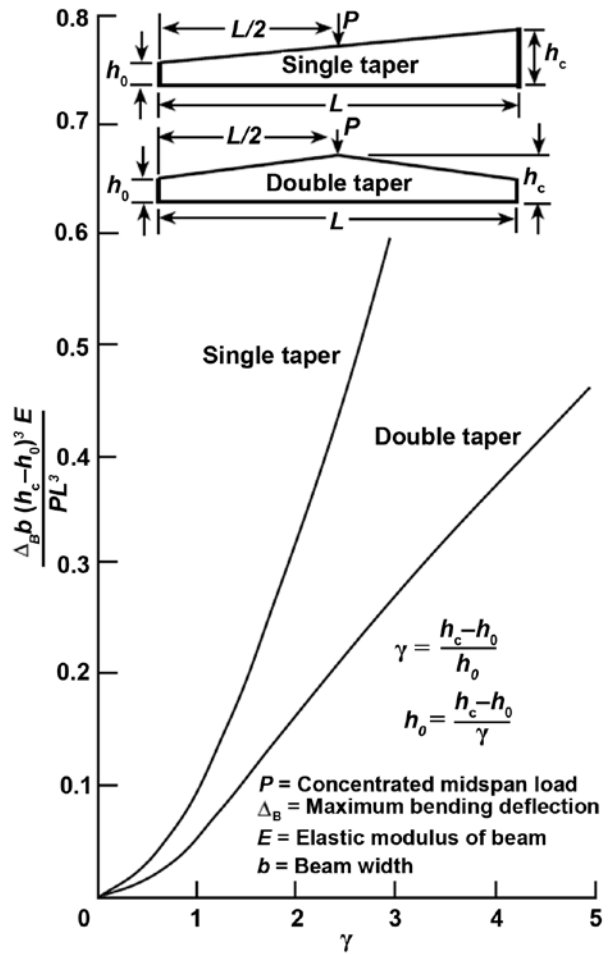

Figure 9-2. Graph for determining tapered beam size on deflection under concentrated midspan load.

P_{cr} a constant equal to the buckling load of the beam under axial compressive load only (see Axial Compression in Stability Equations section.) based on flexural rigidity about the neutral axis perpendicular to the direction of bending loads. This constant appears regardless of whether P is tension or compression. If P is compression, it must be less than P_{cr} to avoid collapse. When the axial load is tension, it is conservative to ignore the P/P_{cr} term. (If the beam is not supported against lateral deflection, its buckling load should be checked using Eq. (9-35).)

Eccentric Load

If an axial load is eccentrically applied to a pin-ended member, it will induce bending deflections and change in length given by Equation (9-1). Equation (9-7) can be applied to find the bending deflection by writing the equation in the form

$$\delta_b + \epsilon_0 = \frac{\epsilon_0}{1 \pm P/P_{cr}} \quad (9-8)$$

where δ_b is the induced bending deflection at midspan and ϵ_0 the eccentricity of P from the centroid of the cross section.

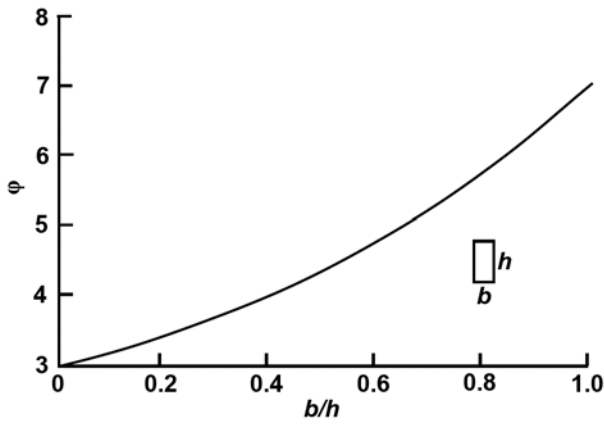

Figure 9-3. Coefficient ϕ for determining torsional rigidity of rectangular member (Eq. (9-11)).

Torsion

The angle of twist of wood members about the longitudinal axis can be computed by

$$\theta = \frac{TL}{GK} \quad (9-9)$$

where θ is angle of twist in radians, T applied torque, L member length, G shear modulus (use $\sqrt{G_{LR}G_{LT}}$, or approximate G by $E_L/16$ if measured G is not available), and K a cross-section shape factor. For a circular cross section, K is the polar moment of inertia:

$$K = \frac{\pi D^4}{32} \quad (9-10)$$

where D is diameter. For a rectangular cross section,

$$K = \frac{hb^3}{\phi} \quad (9-11)$$

where h is larger cross-section dimension, b is smaller cross-section dimension, and ϕ is given in Figure 9-3.

Stress Equations

The equations presented here are limited by the assumption that stress and strain are directly proportional (Hooke’s law) and by the fact that local stresses in the vicinity of points of support or points of load application are correct only to the extent of being statically equivalent to the true stress distribution (St. Venant’s principle). Local stress concentrations must be separately accounted for if they are to be limited in design.

Axial Load

Tensile Stress

Concentric axial load (along the line joining the centroids of the cross sections) produces a uniform stress:

$$f_t = \frac{P}{A} \quad (9-12)$$

where f_t is tensile stress, P axial load, and A cross-sectional area.

Short-Block Compressive Stress

Equation (9-12) can also be used in compression if the member is short enough to fail by simple crushing without deflecting laterally. Such fiber crushing produces a local “wrinkle” caused by microstructural instability. The member as a whole remains structurally stable and able to bear load.

Bending

The strength of beams is determined by flexural stresses caused by bending moment, shear stresses caused by shear load, and compression across the grain at the end bearings and load points.

Straight Beam Stresses

The stress due to bending moment for a simply supported pin-ended beam is a maximum at the top and bottom edges. The concave edge is compressed, and the convex edge is under tension. The maximum stress is given by

$$f_b = \frac{M}{Z} \quad (9-13)$$

where f_b is bending stress, M bending moment, and Z beam section modulus (for a rectangular cross section, $Z = bh^2/6$; for a circular cross section, $Z = \pi D^3/32$).

This equation is also used beyond the limits of Hooke’s law with M as the ultimate moment at failure. The resulting pseudo-stress is called the “modulus of rupture,” values of which are tabulated in Chapter 5. The modulus of rupture has been found to decrease with increasing size of member. (See Size Effect section.)

The shear stress due to bending is a maximum at the centroidal axis of the beam, where the bending stress happens to be zero. (This statement is not true if the beam is tapered—see following section.) In wood beams this shear stress may produce a failure crack near mid-depth running along the axis of the member. Unless the beam is sufficiently short and deep, it will fail in bending before shear failure can develop; but wood beams are relatively weak in shear, and shear strength can sometimes govern a design. The maximum shear stress is

$$f_s = k \frac{V}{A} \quad (9-14)$$

where f_s is shear stress, V vertical shear force on cross section, A cross-sectional area, and $k = 3/2$ for a rectangular cross section or $k = 4/3$ for a circular cross section.

Tapered Beam Stresses

For beams of constant width that taper in depth at a slope less than 25° , the bending stress can be obtained from Equation (9-13) with an error of less than 5%. The shear stress, however, differs markedly from that found in uniform beams. It can be determined from the basic theory presented

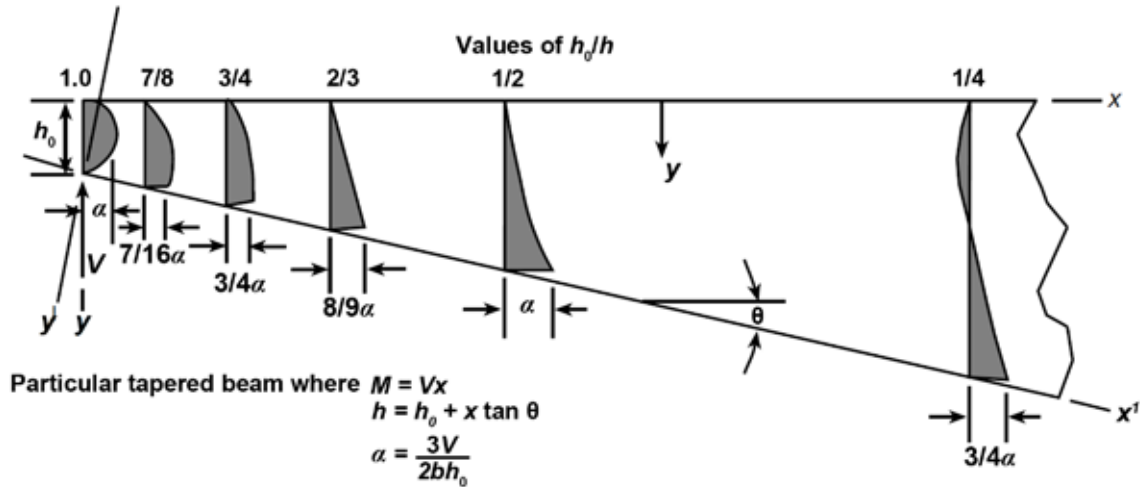

Figure 9-4. Shear stress distribution for a tapered beam.

by Maki and Kuenzi (1965). The shear stress at the tapered edge can reach a maximum value as great as that at the neutral axis at a reaction.

Consider the example shown in Figure 9-4, in which concentrated loads farther to the right have produced a support reaction V at the left end. In this case the maximum stresses occur at the cross section that is double the depth of the beam at the reaction. For other loadings, the location of the cross section with maximum shear stress at the tapered edge will be different.

For the beam depicted in Figure 9-4, the bending stress is also a maximum at the same cross section where the shear stress is maximum at the tapered edge. This stress situation also causes a stress in the direction perpendicular to the neutral axis that is maximum at the tapered edge. The effect of combined stresses at a point can be approximately accounted for by an interaction equation based on the Henky-von Mises theory of energy due to the change of shape. This theory applied by Norris (1950) to wood results in

$$\frac{f_x^2}{F_x^2} + \frac{f_{xy}^2}{F_{xy}^2} + \frac{f_y^2}{F_y^2} = 1 \quad (9-15)$$

where f_x is bending stress, f_y stress perpendicular to the neutral axis, and f_{xy} shear stress. Values of F_x , F_y , and F_{xy} are corresponding stresses chosen at design values or maximum values in accordance with allowable or maximum values being determined for the tapered beam. Maximum stresses in the beam depicted in Figure 9-4 are given by

$$\begin{aligned} f_x &= \frac{3M}{2bh_0^2} \\ f_{xy} &= f_x \tan \theta \\ f_y &= f_x \tan^2 \theta \end{aligned} \quad (9-16)$$

Substitution of these equations into the interaction Equation (9-15) will result in an expression for the moment capacity

M of the beam. If the taper is on the beam tension edge, the values of f_x and f_y are tensile stresses.

Example: Determine the moment capacity (newton-meters) of a tapered beam of width $b = 100$ mm, depth $h_0 = 200$ mm, and taper $\tan \theta = 1/10$. Substituting these dimensions into Equation (9-16) (with stresses in pascals) results in

$$\begin{aligned} f_x &= 375M \\ f_{xy} &= 37.5M \\ f_y &= 3.75M \end{aligned}$$

Substituting these into Equation (9-15) and solving for M results in

$$M = \frac{1}{3.75 \left[10^4/F_x^2 + 10^2/F_{xy}^2 + 1/F_y^2 \right]^{1/2}}$$

where appropriate allowable or maximum values of the F stresses are chosen.

Size Effect

The modulus of rupture (maximum bending stress) of wood beams depends on beam size and method of loading, and the strength of clear, straight-grained beams decreases as size increases. These effects were found to be describable by statistical strength theory involving “weakest link” hypotheses and can be summarized as follows: For two beams under two equal concentrated loads applied symmetrical to the midspan points, the ratio of the modulus of rupture of beam 1 to the modulus of rupture of beam 2 is given by

$$\frac{R_1}{R_2} = \left[\frac{h_2 L_2 (1 + ma_2/L_2)}{h_1 L_1 (1 + ma_1/L_1)} \right]^{1/m} \quad (9-17)$$

where subscripts 1 and 2 refer to beam 1 and beam 2, R is modulus of rupture, h beam depth, L beam span, a distance between loads placed $a/2$ each side of midspan, and m a constant. For clear, straight-grained Douglas-fir beams, $m = 18$. If Equation (9-17) is used for beam 2 size (Chap. 5)

loaded at midspan, then $h_2 = 5.08$ mm (2 in.), $L_2 = 71.112$ mm (28 in.), and $a_2 = 0$ and Equation (9–17) becomes

$$\frac{R_1}{R_2} = \left[\frac{361.29}{h_1 L_1 (1 + m a_1 / L_1)} \right]^{1/m} \quad (\text{metric}) \quad (9-18a)$$

$$\frac{R_1}{R_2} = \left[\frac{56}{h_1 L_1 (1 + m a_1 / L_1)} \right]^{1/m} \quad (\text{inch-pound}) \quad (9-18b)$$

Example: Determine modulus of rupture for a beam 10 in. deep, spanning 18 ft, and loaded at one-third span points compared with a beam 2 in. deep, spanning 28 in., and loaded at midspan that had a modulus of rupture of 10,000 lb in⁻². Assume $m = 18$. Substituting the dimensions into Equation (9–18) produces

$$R_1 = 10,000 \left[\frac{56}{2,160(1 + 6)} \right]^{1/18} = 7,330 \text{ lb in}^{-2}$$

Application of the statistical strength theory to beams under uniformly distributed load resulted in the following relationship between modulus of rupture of beams under uniformly distributed load and modulus of rupture of beams under concentrated loads:

$$\frac{R_u}{R_c} = \left[\frac{(1 + 18a_c / L_c) h_c L_c}{3.876 h_u L_u} \right]^{1/18} \quad (9-19)$$

where subscripts u and c refer to beams under uniformly distributed and concentrated loads, respectively, and other terms are as previously defined.

Shear strength for non-split, non-checked, solid-sawn, and glulam beams also decreases as beam size increases. A relationship between beam shear τ and ASTM shear block strength τ_{ASTM} , including a stress concentration factor for the re-entrant corner of the shear block, C_f , and the shear area A , is

$$\tau = \frac{1.9 C_f \tau_{ASTM}}{A^{1/5}} \quad (\text{metric}) \quad (9-20a)$$

$$\tau = \frac{1.3 C_f \tau_{ASTM}}{A^{1/5}} \quad (\text{inch-pound}) \quad (9-20b)$$

where τ is beam shear (MPa, lb in⁻²), C_f stress concentration factor, τ_{ASTM} ASTM shear block strength (MPa, lb in⁻²), and A shear area (cm², in²).

This relationship was determined by empirical fit to test data. The shear block re-entrant corner concentration factor is approximately 2; the shear area is defined as beam width multiplied by the length of beam subjected to shear force.

Effect of Notches, Slits, and Holes

In beams having notches, slits, or holes with sharp interior corners, large stress concentrations exist at the corners. The local stresses include shear parallel to grain and tension perpendicular to grain. As a result, even moderately low loads can cause a crack to initiate at the sharp corner and propagate along the grain. An estimate of the crack-initiation load

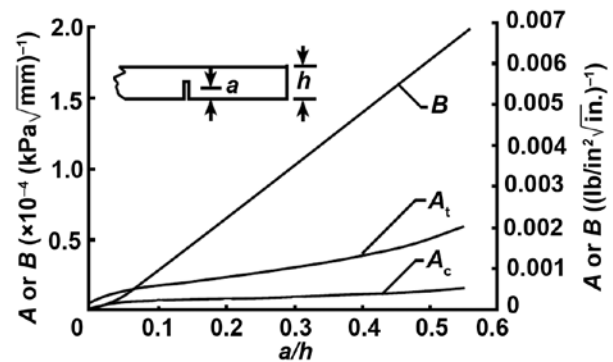

Figure 9–5. Coefficients A and B for crack-initiation criterion (Eq. (9–21)).

can be obtained by the fracture mechanics analysis of Murphy (1979) for a beam with a slit, but it is generally more economical to avoid sharp notches entirely in wood beams, especially large wood beams, since there is a size effect: sharp notches cause greater reductions in strength for larger beams. A conservative criterion for crack initiation for a beam with a slit is

$$\sqrt{h} \left[A \left(\frac{6M}{bh^2} \right) + B \left(\frac{3V}{2bh} \right) \right] = 1 \quad (9-21)$$

where h is beam depth, b beam width, M bending moment, and V vertical shear force, and coefficients A and B are presented in Figure 9–5 as functions of a/h , where a is slit depth. The value of A depends on whether the slit is on the tension edge or the compression edge. Therefore, use either A_t or A_c as appropriate. The values of A and B are dependent upon species; however, the values given in Figure 9–5 are conservative for most softwood species.

Effects of Time: Creep Rupture, Fatigue, and Aging

See Chapter 5 for a discussion of fatigue and aging. Creep rupture is accounted for by duration-of-load adjustment in the setting of allowable stresses, as discussed in Chapters 5 and 7.

Water Ponding

Ponding of water on roofs can cause increases in bending stresses that can be computed by the same amplification factor (Eq. (9–6)) used with deflection. (See Water Ponding in the Deformation Equations section.)

Combined Bending and Axial Load

Concentric Load

Equation (9–7) gives the effect on deflection of adding an end load to a simply supported pin-ended beam already bent by transverse loads. The bending stress in the member is modified by the same factor as the deflection:

$$f_b = \frac{f_{b0}}{1 \pm P/P_{cr}} \quad (9-22)$$

Chapter 9 Structural Analysis Equations

where the plus sign is chosen if the axial load is tension and the minus sign is chosen if the axial load is compression, f_b is net bending stress from combined bending and axial load, f_{b0} bending stress without axial load, P axial load, and P_{cr} the buckling load of the beam under axial compressive load only (see Axial Compression in the Stability Equations section), based on flexural rigidity about the neutral axis perpendicular to the direction of the bending loads. This P_{cr} is not necessarily the minimum buckling load of the member. If P is compressive, the possibility of buckling under combined loading must be checked. (See Interaction of Buckling Modes.)

The total stress under combined bending and axial load is obtained by superposition of the stresses given by Equations (9-12) and (9-22).

Example: Suppose transverse loads produce a bending stress f_{b0} tensile on the convex edge and compressive on the concave edge of the beam. Then the addition of a tensile axial force P at the centroids of the end sections will produce a maximum tensile stress on the convex edge of

$$f_{t \max} = \frac{f_{b0}}{1 + P/P_{cr}} + \frac{P}{A}$$

and a maximum compressive stress on the concave edge of

$$f_{c \max} = \frac{f_{b0}}{1 + P/P_{cr}} - \frac{P}{A}$$

where a negative result would indicate that the stress was in fact tensile.

Eccentric Load

If the axial load is eccentrically applied, then the bending stress f_{b0} should be augmented by $\pm P\epsilon_0/Z$, where ϵ_0 is eccentricity of the axial load.

Example: In the preceding example, let the axial load be eccentric toward the concave edge of the beam. Then the maximum stresses become

$$f_{t \max} = \frac{f_{b0} - P\epsilon_0/Z}{1 + P/P_{cr}} + \frac{P}{A}$$

$$f_{c \max} = \frac{f_{b0} - P\epsilon_0/Z}{1 + P/P_{cr}} - \frac{P}{A}$$

Torsion

For a circular cross section, the shear stress induced by torsion is

$$f_s = \frac{16T}{\pi D^3} \quad (9-23)$$

where T is applied torque and D diameter. For a rectangular cross section,

$$f_s = \frac{T}{\beta hb^2} \quad (9-24)$$

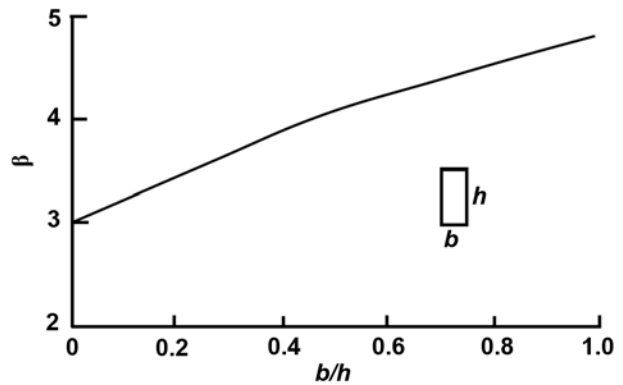

Figure 9-6. Coefficient β for computing maximum shear stress in torsion of rectangular member (Eq. (9-24)).

where T is applied torque, h larger cross-section dimension, and b smaller cross-section dimension, and β is presented in Figure 9-6.

Stability Equations

Axial Compression

For slender members under axial compression, stability is the principal design criterion. The following equations are for concentrically loaded members. For eccentrically loaded columns, see Interaction of Buckling Modes section.

Long Columns

A column long enough to buckle before the compressive stress P/A exceeds the proportional limit stress is called a “long column.” The critical stress at buckling is calculated by Euler’s formula:

$$f_{cr} = \frac{\pi^2 E_L}{(L/r)^2} \quad (9-25)$$

where E_L is elastic modulus parallel to the axis of the member, L unbraced length, and r least radius of gyration (for a rectangular cross section with b as its least dimension, $r = b/\sqrt{12}$, and for a circular cross section, $r = d/4$). Equation (9-25) is based on a pinned-end condition but may be used conservatively for square ends as well.

Short Columns

Columns that buckle at a compressive stress P/A beyond the proportional limit stress are called “short columns.” Usually the short column range is explored empirically, and appropriate design equations are proposed. Material of this nature is presented in *USDA Technical Bulletin 167* (Newlin and Gahagan 1930). The final equation is a fourth-power parabolic function that can be written as

$$f_{cr} = F_c \left[1 - \frac{4}{27\pi^4} \left(\frac{L}{r} \sqrt{\frac{F_c}{E_L}} \right)^4 \right] \quad (9-26)$$

where F_c is compressive strength and remaining terms are defined as in Equation (9-25). Figure 9-7 is a graphical representation of Equations (9-25) and (9-26).

Short columns can be analyzed by fitting a nonlinear function to compressive stress-strain data and using it in place of Hooke's law. One such nonlinear function proposed by Ylinen (1956) is

$$\varepsilon = \frac{F_c}{E_L} \left[c \frac{f}{F_c} - (1-c) \log_e \left(1 - \frac{f}{F_c} \right) \right] \quad (9-27)$$

where ε is compressive strain, f compressive stress, c a constant between 0 and 1, and E_L and F_c are as previously defined. Using the slope of Equation (9-27) in place of E_L in Euler's formula (Eq. (9-25)) leads to Ylinen's buckling equation

$$f_{cr} = \frac{F_c + f_e}{2c} - \sqrt{\left(\frac{F_c + f_e}{2c} \right)^2 - \frac{F_c f_e}{c}} \quad (9-28)$$

where F_c is compressive strength and f_e buckling stress given by Euler's formula (Eq. (9-25)). Equation (9-28) can be made to agree closely with Figure 9-7 by choosing $c = 0.97$.

Comparing the fourth-power parabolic function Equation (9-26) to experimental data indicates the function is non-conservative for intermediate L/r range columns. Using Ylinen's buckling equation with $c = 0.8$ results in a better approximation of the solid-sawn and glued-laminated data, whereas $c = 0.9$ for strand lumber seems appropriate.

Built-Up and Spaced Columns

Built-up columns of nearly square cross section with the lumber nailed or bolted together will not support loads as great as if the lumber were glued together. The reason is that shear distortions can occur in the mechanical joints.

If built-up columns are adequately connected and the axial load is near the geometric center of the cross section, Equation (9-28) is reduced with a factor that depends on the type of mechanical connection. The built-up column capacity is

$$f_{cr} = K_f \left[\frac{F_c + f_e}{2c} - \sqrt{\left(\frac{F_c + f_e}{2c} \right)^2 - \frac{F_c f_e}{c}} \right] \quad (9-29)$$

where F_c , f_e , and c are as defined for Equation (9-28). K_f is the built-up stability factor, which accounts for the efficiency of the connection; for bolts, $K_f = 0.75$, and for nails, $K_f = 0.6$, provided bolt and nail spacing requirements meet design specification approval.

If the built-up column is of several spaced pieces, the spacer blocks should be placed close enough together, lengthwise in the column, so that the unsupported portion of the spaced member will not buckle at the same or lower stress than that of the complete member. "Spaced columns" are designed with previously presented column equations, considering

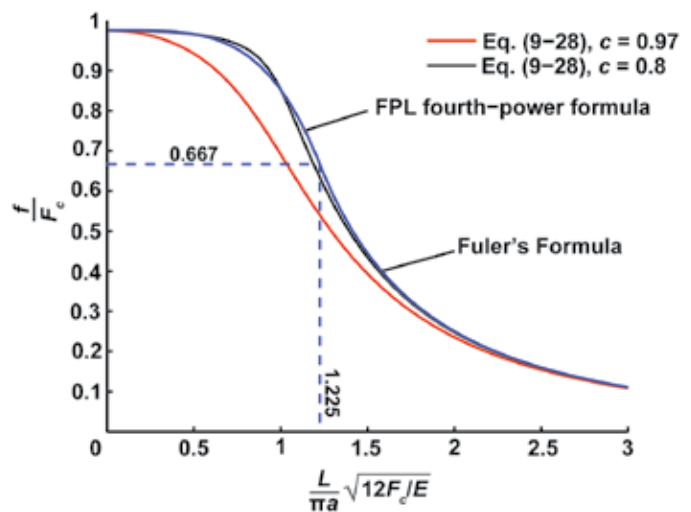

Figure 9-7. Graph for determining critical buckling stress of wood columns.

each compression member as an unsupported simple column; the sum of column loads for all the members is taken as the column load for the spaced column.

Columns with Flanges

Columns with thin, outstanding flanges can fail by elastic instability of the outstanding flange, causing wrinkling of the flange and twisting of the column at stresses less than those for general column instability as given by Equations (9-25) and (9-26). For outstanding flanges of cross sections such as I, H, +, and L, the flange instability stress can be estimated by

$$f_{cr} = 0.044E \frac{t^2}{b^2} \quad (9-30)$$

where E is column modulus of elasticity, t thickness of the outstanding flange, and b width of the outstanding flange. If the joints between the column members are glued and reinforced with glued fillets, the instability stress increases to as much as 1.6 times that given by Equation (9-30).

Bending

Beams are subject to two kinds of instability: lateral-torsional buckling and progressive deflection under water ponding, both of which are determined by member stiffness.

Water Ponding

Roof beams that are insufficiently stiff or spaced too far apart for their given stiffness can fail by progressive deflection under the weight of water from steady rain or another continuous source. The critical beam spacing S_{cr} is given by

$$S_{cr} = \frac{m\pi^4 EI}{\rho L^4} \quad (9-31)$$

where E is beam modulus of elasticity, I beam moment of inertia, ρ density of water (1,000 kg m⁻³, 0.0361 lb in⁻³), L beam length, and $m = 1$ for simple support or $m = 16/3$ for

Table 9–2. Effective length for checking lateral–torsional stability of beams^a

Support	Load	Effective length L_e
Simple support	Equal end moments	L
	Concentrated force at center	$\frac{0.742L}{1 - 2h/L}$
	Uniformly distributed force	$\frac{0.887L}{1 - 2h/L}$
Cantilever	Concentrated force at end	$\frac{0.783L}{1 - 2h/L}$
	Uniformly distributed force	$\frac{0.489L}{1 - 2h/L}$

^aThese values are conservative for beams with a width-to-depth ratio of less than 0.4. The load is assumed to act at the top edge of the beam.

fixed-end condition. To limit the effect of ponding, the beam spacing must be less than S_{cr} .

Lateral–Torsional Buckling

Because beams are compressed on the concave edge when bent under load, they can buckle by a combination of lateral deflection and twist. Because most wood beams are rectangular in cross section, the equations presented here are for rectangular members only. Beams of I, H, or other built-up cross section exhibit a more complex resistance to twisting and are more stable than the following equations would predict.

Long Beams—Long slender beams that are restrained against axial rotation at their points of support but are otherwise free to twist and to deflect laterally will buckle when the maximum bending stress f_b equals or exceeds the following critical value:

$$f_{bcr} = \frac{\pi^2 E_L}{\alpha^2} \tag{9-32}$$

where α is the slenderness factor given by

$$\alpha = \sqrt{2\pi^4 \frac{EI_y}{GK} \frac{\sqrt{L_e h}}{b}} \tag{9-33}$$

where EI_y is lateral flexural rigidity equal to $E_L hb^3/12$, h is beam depth, b beam width, GK torsional rigidity defined in Equation (9–9), and L_e effective length determined by type of loading and support as given in Table 9–2. Equation (9–32) is valid for bending stresses below the proportional limit.

Short Beams—Short beams can buckle at stresses beyond the proportional limit. In view of the similarity of Equation (9–32) to Euler’s formula (Eq. (9–25)) for column buckling, it is recommended that short-beam buckling be analyzed by

using the column buckling criterion in Figure 9–7 applied with α in place of L/r on the abscissa and f_{bcr}/F_b in place of f_{cr}/F_c on the ordinate. Here F_b is beam modulus of rupture.

Effect of Deck Support—The most common form of support against lateral deflection is a deck continuously attached to the top edge of the beam. If this deck is rigid against shear in the plane of the deck and is attached to the compression edge of the beam, the beam cannot buckle. In regions where the deck is attached to the tension edge of the beam, as where a beam is continuous over a support, the deck cannot be counted on to prevent buckling and restraint against axial rotation should be provided at the support point.

If the deck is not very rigid against in-plane shear, as for example standard 38-mm (nominal 2-in.) wood decking, Equation (9–32) and Figure 9–7 can still be used to check stability except that now the effective length is modified by dividing by θ , as given in Figure 9–8. The abscissa of this figure is a deck shear stiffness parameter τ given by

$$\tau = \frac{SG_D L^2}{EI_y} \tag{9-34}$$

where EI_y is lateral flexural rigidity as in Equation (9–33), S beam spacing, G_D in-plane shear rigidity of deck (ratio of shear force per unit length of edge to shear strain), and L actual beam length. This figure applies only to simply supported beams. Cantilevers with the deck on top have their tension edge supported and do not derive much support from the deck.

Interaction of Buckling Modes

When two or more loads are acting and each of them has a critical value associated with a mode of buckling, the combination can produce buckling even though each load is less than its own critical value.

The general case of a beam of unbraced length l_e includes a primary (edgewise) moment M_1 , a lateral (flatwise) moment M_2 , and axial load P . The axial load creates a secondary moment on both edgewise and flatwise moments due to the deflection under combined loading given by Equation (9–7). In addition, the edgewise moment has an effect like the secondary moment effect on the flatwise moment.

The following equation contains two moment modification factors, one on the edgewise bending stress and one on the flatwise bending stress that includes the interaction of biaxial bending. The equation also contains a squared term for axial load to better predict experimental data:

$$\left(\frac{f_c}{F_c}\right)^2 + \frac{f_{b1} + 6(e_1/d_1)f_c(1.234 - 0.2340_{c1})}{\theta_{c1}F'_{b1}} + \frac{f_{b2} + 6(e_2/d_2)f_c(1.234 - 0.2340_{c2})}{\theta_{c2}F'_{b2}} \leq 1.0 \tag{9-35}$$

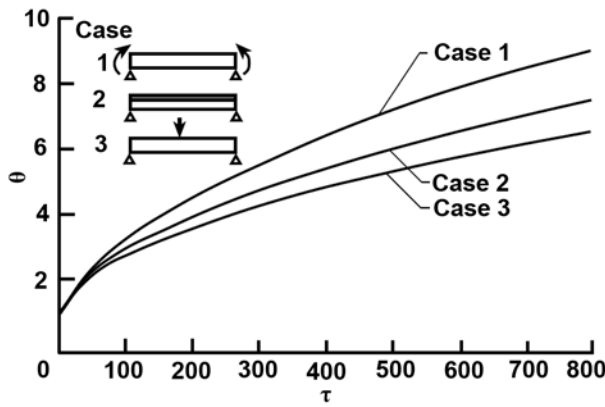

Figure 9–8. Increase in buckling stress resulting from attached deck; simply supported beams. To apply this graph, divide the effective length by θ .

where f is actual stress in compression, edgewise bending, or flatwise bending (subscripts c, b1, or b2, respectively), F buckling strength in compression or bending (a single prime denotes the strength is reduced for slenderness), e/d ratio of eccentricity of the axial compression to member depth ratio for edgewise or flatwise bending (subscripts 1 or 2, respectively), and θ_c moment magnification factors for edgewise and flatwise bending, given by

$$\theta_{c1} = 1 - \left(\frac{f_c}{F'_{c1}} + \frac{S}{S_{cr}} \right) \quad (9-36)$$

$$\theta_{c2} = 1 - \left(\frac{f_c}{F'_{c2}} + \frac{f_{b1} + 6(e_1/d_1)f_c}{F'_{b1}} \right) \quad (9-37)$$

$$F'_{c1} = \frac{0.822E}{(l_{e1}/d_1)^2} \quad (9-38)$$

$$F'_{c2} = \frac{0.822E}{(l_{e2}/d_2)^2} \quad (9-39)$$

$$F'_{b1} = \frac{1.44E d_2}{l_e d_1} \quad (9-40)$$

where l_e is effective length of member and S and S_{cr} are previously defined ponding beam spacing.

Literature Cited

Maki, A.C.; Kuenzi, E.W. 1965. Deflection and stresses of tapered wood beams. Res. Pap. FPL–RP–34. Madison, WI: U.S. Department of Agriculture, Forest Service, Forest Products Laboratory. 56 p.

Murphy, J.F. 1979. Using fracture mechanics to predict failure of notched wood beams. In: Proceedings of first international conference on wood fracture; 1978 August 14–16; Banff, AB. Vancouver, BC: Forintek Canada Corporation. 159: 161–173.

Newlin, J.A.; Gahagan, J.M. 1930. Tests of large timber columns and presentation of the Forest Products

Laboratory column formula. Tech. Bull. 167. Madison, WI: U.S. Department of Agriculture, Forest Service, Forest Products Laboratory. 44 p.

Norris, C.B. 1950. Strength of orthotropic materials subjected to combined stresses. Rep. 1816. Madison, WI: U.S. Department of Agriculture, Forest Service, Forest Products Laboratory. 40 p.

Ylinen, A. 1956. A method of determining the buckling stress and the required cross-sectional area for centrally loaded straight columns in elastic and inelastic range. Zurich, Switzerland: Publication of the IABSA (International Association for Bridge and Structural Engineering). Vol. 16.

Additional References

ASTM. [Current edition]. Standard methods for testing clear specimens of timber. ASTM D 143–94. West Conshohocken, PA: American Society for Testing and Materials.

Bohannon, B. 1966. Effect of size on bending strength of wood members. Res. Pap. FPL–RP–56. Madison, WI: U.S. Department of Agriculture, Forest Service, Forest Products Laboratory. 30 p.

Gerhardt, T.D.; Liu, J.Y. 1983. Orthotropic beams under normal and shear loading. American Society of Civil Engineers (ASCE). Journal of Engineering Mechanics. 109(2): 394–410.

Kuenzi, E.W.; Bohannon, B. 1964. Increases in deflection and stress caused by ponding of water on roofs. Forest Products Journal. 14(9): 421–424.

Liu, J.Y. 1980. Shear strength of wood beams: a Weibull analysis. American Society of Civil Engineers (ASCE). Journal of Structural Division. 106(ST10): 2035–2052.

Liu, J.Y. 1981. Shear strength of tapered wood beams. American Society of Civil Engineers (ASCE). Journal of Structural Division. 107(ST5): 719–731.

Liu, J.Y. 1982. A Weibull analysis of wood member bending strength. Transactions, American Society of Mechanical Engineers. Journal of Mechanical Design. 104: 572–579.

Liu, J.Y. 1984. Evaluation of the tensor polynomial strength theory for wood. Journal of Composite Materials. 18(3): 216–226. (May).

Liu, J.Y.; Cheng, S. 1979. Analysis of orthotropic beams. Res. Pap. FPL–RP–343. Madison, WI: U.S. Department of Agriculture, Forest Service, Forest Products Laboratory. 37 p.

Malhorta, S.K.; Sukumar, A.P. 1989. A simplified procedure for built-up wood compression members. Annual conference. St. John's, Newfoundland: Canadian Society for Civil Engineering: 1–18 (June).

Newlin, J.A.; Trayer, G.W. 1924. Deflection of beams with special reference to shear deformations. Rep. 180.

Chapter 9 Structural Analysis Equations

Washington, DC: U.S. National Advisory Committee on Aeronautics. 18 p.

Rammer, D.R.; Soltis, L.A. 1994. Experimental shear strength of glued-laminated beams. Res. Rep. FPL–RP–527. Madison, WI: U.S. Department of Agriculture, Forest Service, Forest Products Laboratory. 40 p.

Rammer, D.R.; Soltis, L.A.; Lebow, P.K. 1996. Experimental shear strength of unchecked solid sawn Douglas-fir. Res. Pap. FPL–RP–553. Madison, WI: U.S. Department of Agriculture, Forest Service, Forest Products Laboratory. 35 p.

Soltis, L.A.; Rammer, D.R. 1997. Bending to shear ratio approach to beam design. *Forest Products Journal*. 47(1): 104–108.

Trayer, G.W. 1930. The torsion of members having sections common in aircraft construction. Rep. 334. Washington, DC: U.S. National Advisory Committee on Aeronautics. 49 p.

Trayer, G.W.; March, H.W. 1931. Elastic instability of members having sections common in aircraft construction. Rep. 382. Washington, DC: U.S. National Advisory Committee on Aeronautics. 38 p.

Zahn, J.J. 1973. Lateral stability of wood beam-and-deck systems. *American Society of Civil Engineers (ASCE). Journal of Structural Division*. 99(ST7): 1391–1408.

Zahn, J.J. 1986. Design of wood members under combined loads. *American Society of Civil Engineers (ASCE). Journal of Structural Engineering*. 112(ST9): 2109–2126.

Zahn, J.J. 1988. Combined-load stability criterion for wood beam-columns. *American Society of Civil Engineers (ASCE). Journal of Structural Engineering*. 114(ST11): 2612–2628.

Adhesives with Wood Materials

Bond Formation and Performance

Charles R. Frihart, Research Chemist

Christopher G. Hunt, Research Chemist

Contents

Surface Properties of Wood for Bonding 10–2
Lumber Surfaces 10–2
Veneer Surfaces 10–3
Chemical Interference to Bonding 10–4
Bonding of Wood Composite Products and Nonwood Materials 10–5
Physical Properties of Wood for Bonding 10–5
Density and Porosity 10–5
Moisture Content and Dimensional Changes 10–6
Adhesives 10–8
Composition 10–8
Strength and Durability 10–9
Selection 10–10
Health and Safety 10–14
Bonding Process 10–14
Moisture Content Control 10–14
Surface Preparation 10–15
Spreading of Adhesive 10–15
Assembly and Pressing 10–16
Post-Cure Conditioning 10–17
Bonded Joints 10–18
Edge-Grain Joints 10–18
End-Grain Joints 10–18
End-to-Edge-Grain Joints 10–18
Construction Joints 10–19
Testing and Performance 10–19
Analytical, Chemical, and Mechanical Testing of Polymers 10–19
Mechanical Testing of Bonded Assemblies 10–20
Short- and Long-Term Performance 10–21
Product Quality Assurance 10–22
Standards 10–22
References 10–23

Adhesive bonding of wood plays an increasing role in the forest products industry and is a key factor for efficiently utilizing our timber resource. The main use of adhesives is in the manufacture of building materials, including plywood, oriented strandboard, particleboard, fiberboard, structural composite lumber, doors, windows and frames, and factory-laminated wood products. Adhesives are also used in the assembly of furniture and cabinets, manufacture of engineered wood products, and construction of residential and commercial structures.

Adhesives transfer and distribute loads between components, thereby increasing the strength and stiffness of wood products. Effective transfer of stress from one member to another depends on the strength of the links in an imaginary chain across the adhesive-bonded joint (Fig. 10–1). Thus, the performance of a bonded joint depends on how well the complex factors that contribute to the properties of the individual links (wood, adhesive, and interphase regions of wood and adhesive) are controlled during product assembly, which ultimately determines the strength of the chain.

Adhesion involves both mechanical and chemical factors that control the adhesive's ability to hold together two wood surfaces. Because wood is porous, one mechanism of adhesion is mechanical interlocking. Effective mechanical interlocking takes place when an adhesive penetrates beyond the surface debris and damaged fibers into sound wood two to six cells deep. Further penetration into the cell wall microstructure increases the mechanical interlocking and the surface area for adhesive contact with the wood. With many adhesives, the most durable, water-resistant bonds develop when the adhesive flows deeply into cell cavities and infiltrates inside the cell walls. The standard for excellent bonds is that the wood breaks away from the adhesive joint and that the bond strength is equal to the strength of the solid wood.

Attractive forces between molecules of adhesive and wood contribute greatly to adhesion. Although covalent bonds—chemical bonds between the adhesive and wood—seem plausible with some adhesives, no evidence exists that they contribute to the strength of adhesive bonds. However, intermolecular attractive forces, such as Van der Waal's forces,

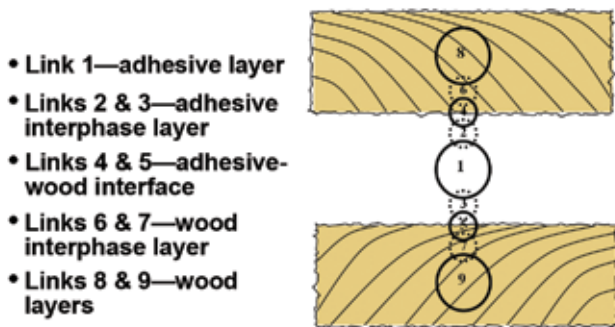

Figure 10–1. Imaginary links of adhesive bond between two pieces of wood using the schematic from Marra (1980).

dipole–dipole forces, and hydrogen bonding, occur so frequently that they must be very important for bond strength, especially given the high contact area of the adhesive with the wood. With some wood surfaces, such as teak, wood extractives can interfere with the direct adhesive contact, leading to a chemically weak boundary effect and poor bond strength.

For maximum adhesive bond strength, the liquid adhesive must “wet” the wood surface, flowing over and penetrating into the wood. Molecules of adhesive must come into direct contact with molecules of wood to provide the best mechanical interlock and intermolecular attraction between adhesive and wood. Wood surfaces may appear to be smooth and flat, but microscopic examination shows peaks, valleys, and crevices littered with loose fibers and other debris. Such surface conditions cause air pockets and blockages that prevent complete wetting by the adhesive and introduce stress concentrations when the adhesive has cured. In addition, different characteristics of wood (such as grain angle, natural defects, and extractives) lead to widely different surface energies, roughness, and chemistry. (Surface wetting is discussed in more detail in the section on Chemical Interference to Bonding.) In addition to wetting, or completely covering these different surfaces, adhesives must be fluid enough to flow into the microscopic holes, or capillary structure, of wood. Pressure enhances wetting by forcing liquid adhesive to flow over the surfaces, displace air blockages, and penetrate to the sound wood.

The adhesive bond forms once the adhesive solidifies, but full strength may take from hours to days to develop. The applied adhesive changes from liquid to solid by one or more of three mechanisms: (a) loss of solvent from adhesive through evaporation and diffusion into the wood, (b) cooling of a molten adhesive, or (c) chemical polymerization into cross-linked structures that resist softening on heating. Because water is a common carrier for most wood adhesives, loss of water and chemical polymerization often occur simultaneously.

Surface Properties of Wood for Bonding

Because adhesives bond by surface attachment, the physical and chemical conditions of the wood’s surface are extremely important to satisfactory bond performance. The wood surface should be smooth, flat, and free of machine marks and other surface irregularities, including planer skips and crushed, torn, or chipped grain. The surface should be free of burnishes, exudates, oils, dirt, and other debris that form a weak boundary between the adhesive and the wood.

Both mechanical and chemical properties of a wood surface influence the quality of adhesive bonds. Wood whose surface is highly fractured or crushed cannot form a strong bond even if the adhesive forms a strong bond with the surface. The weak wood underneath the surface is the weak link in the chain and the location of failure in the bonded assembly. In other cases, poor bond strength is due to chemical properties of the surface. Sometimes natural extractives, overdrying, or chemicals added to modify the wood alter the surface chemistry enough to harm adhesive bond performance. Physical deterioration and chemical contamination interfere with essential wetting, flow, and penetration of adhesive, and contamination sometimes interferes with the cure of the adhesive and resulting cohesive strength of the bond.

Lumber Surfaces

Surfacing or resurfacing the wood within 24 h before bonding removes extractives and provides a more wettable surface. Surfacing also removes any unevenness that may have occurred from changes in moisture content. Parallel and flat surfaces allow the adhesive to flow freely and form a uniformly thin layer that is essential to optimal adhesive performance.

Experience and testing have proven that a smooth, knife-cut surface is best for bonding. Surfaces made using saws are usually rougher than those made using planers and jointers. However, surfaces sawn with special blades on properly set straight-line ripsaws are satisfactory for both structural and nonstructural joints. Furniture manufacturers commonly use precision sawing of wood joints rather than two-step sawing and jointing to reduce costs for labor, equipment, and material. Unless the saws and feed works are well maintained, however, joints made with sawed surfaces will be weaker and less uniform in strength than those made with sharp planer or jointer knives. Dull cutting edges of planer or jointer knives crush and burnish the cells on the wood surface. Not only are these cells weaker, they also inhibit adhesive wetting and penetration. Damage to the surface can be revealed by wiping a very wet rag over a portion of the surface, waiting for a minute or more, removing any remaining water with a dry paper towel, and comparing the roughness of the wet and dry surfaces. If the wetted area

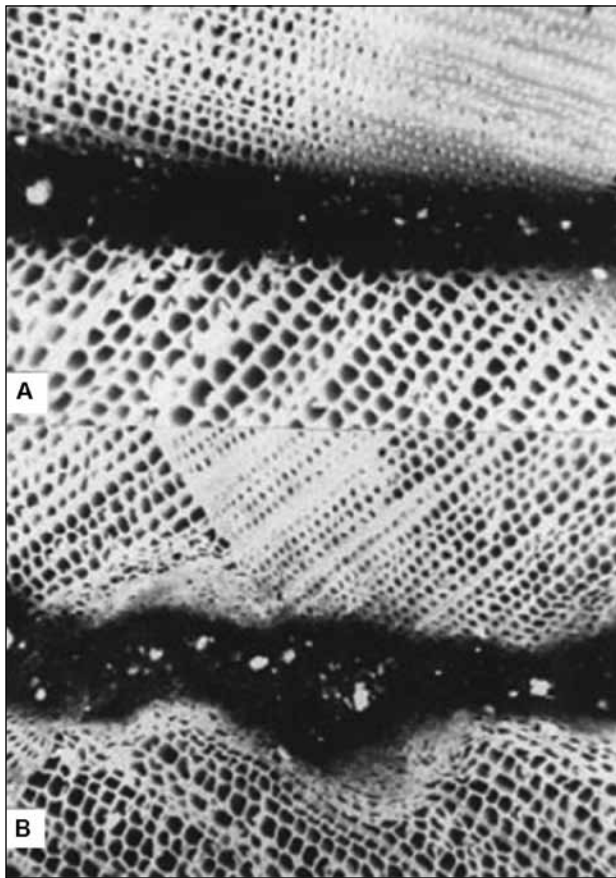

Figure 10–2. Cross sections of bonded joints involving undamaged and damaged Douglas-fir surfaces. The dark area at the center of micrograph is the adhesive bondline. Image A involves two undamaged surfaces from planing with sharp knife (120×) and shows open wood cells with their distinct walls. Image B involves two damaged surfaces abrasively planed with 36-grit sandpaper and shows crushed cells with their indistinct walls in and adjacent to the bondline.

is much rougher than the dry area, then the machining has damaged the surface. A weak joint results if the adhesive does not completely penetrate crushed cells to restore their original strength.

Abrasive planing with grit sizes from 24 to 60 causes surface and subsurface crushing of wood cells. The adhesive industry typically recommends 60–80-grit sanding as acceptable for wood bonding as this equates to 24 to 30 knife marks per inch when planing. Generally, anything above 200 grit fuzzes the wood surface and is not recommended. Figure 10–2 shows bondlines of undamaged, knife-planed Douglas-fir lumber (A) compared with bondlines between surfaces damaged by abrasive planing (B). Such damaged surfaces are inherently weak and result in poor

bond strength. If abrasive planing is to be used before bonding, belts must be kept clean and sharp, and sanding dust must be removed completely from the surface. However, abrasive planing is not recommended for structural joints that will be subjected to high swelling and shrinkage stresses from water soaking and drying.

Veneer Surfaces

The desired properties of wood veneer are essentially similar to those of lumber, but manufacturing processes, including cutting, drying, and laminating into plywood, can drastically change physical and chemical surface properties of veneer. Special knowledge and attention to these properties are required to ensure good wetting and penetration of the adhesive.

Rotary-cut veneer is produced by rotating a log by its ends against a knife, which results in continuous sheets of flat-grain veneer. As the knife peels veneer from the log, the knife forces the veneer away from the log at a sharp angle, fracturing (checking) the veneer on the knife side. The checked side is commonly called the loose side, and the opposite side without checking is called the tight side. When rotary-cut veneer is used for faces in plywood, the loose side should be bonded and the tight side finished. Otherwise, open checks in the faces produce imperfections in the finish. Adhesive overpenetration into lathe checks usually is not a problem if the adhesive spread rate is set correctly.

Sliced veneer is produced in long strips by moving a squared log, called a flitch, against a knife. As in rotary cutting, the knife forces the veneer away from the flitch at a sharp angle, causing fine checking of the veneer on the knife side. This checked surface will show imperfections in a finished surface, so the loose side should be bonded and the tight side finished. For book-matched face veneers, where grain patterns of adjacent veneers are near mirror images, half the veneers will be loosely cut and must be finished so the veneer must be cut as tightly as possible. Generally, hardwood face veneers are sliced to reveal the most attractive grain patterns.

Sawn veneer is produced in long narrow strips from flitches that have been selected and sawn for attractive grain patterns. The two sides of sawn veneer are free from knife checks, so either surface may be bonded with satisfactory results.

Veneer is dried promptly after cutting, using continuous, high-temperature dryers that are heated with either steam or hot gases from wood-residue- or gas-fired burners. Drying temperatures range from 170 to 230 °C (330 to 446 °F) for short periods. Drying to very low moisture levels at very high temperatures or at moderate temperatures for prolonged periods inactivates the veneer surfaces, causing poor wetting of veneer and hence poor bonding. Residues deposited on veneer surfaces from incomplete

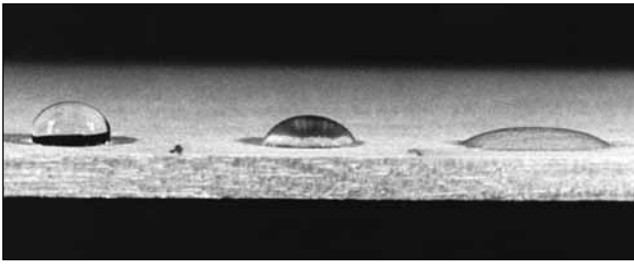

Figure 10–3. A simple water drop test shows differences in wettability of yellow birch veneer surface. Three drops were applied to surface simultaneously and then photographed after 30 s. Left drop retained a large contact angle on aged and unsanded surface; center drop had a smaller contact angle and improved wettability after the surface was renewed by two passes with 320-grit sandpaper; right drop showed a small contact angle and good wettability after four passes with the sandpaper.

combustion of gases and fuel oils can cause serious adhesion problems in plywood production.

Veneer selected for its attractive appearance, or for use in sanded grades of plywood, should be uniform in thickness, smooth, and flat; be free from deep checks, knots, holes, and decay; and have face grain suitable for the intended face grade. For lower grade plywood, defect standards are not as strict. For example, loosely cut veneer with many deep checks and large defects is suitable for structural plywood, but this veneer requires more adhesive than does tightly cut veneer.

Chemical Interference to Bonding

Chemical interference that reduces the bondability of wood is more complicated and more difficult to detect than the mechanical weakening of wood surfaces. This interference can be from natural causes (migration of extractives to the surface), inadvertent wood alteration (overdrying of the wood surface), or intentional alteration (wood modification). A simple water test can reveal much about the state of a wood surface and any difficulties for wetting and bonding with an adhesive. This test allows estimation of the degree of surface inactivation of veneer towards wetting and penetration by placing a drop of water on the wood surface and observing how fast the drop spreads over the wood. A drop of water is placed in an area on the earlywood of a flat-grain surface that does not have checks or splits. A surface with good wettability and penetrability will absorb the drop within 20 s. If the drop spreads out but some water remains on the surface after 40 s, then the surface has good wettability and poor penetration, and may be difficult to bond. If after 40 s the water drop retains much of its original shape with little spreading, then bonding problems from surface inactivation (poor wettability and penetrability) is a certainty.

Figure 10–3 shows how the inactivated surface of veneer can be removed by sanding of the surface to allow the droplet to flow into a wider droplet on the surface instead of staying as a bead.

Extractives on wood surfaces contribute to surface inactivation through both physical and chemical means. Most wood adhesives are waterborne; therefore, they do not properly wet and penetrate extractive-covered surfaces. Particularly troublesome extractives are pitch, especially in the southern pines and Douglas-fir, and oil, such as in teak. When subjected to high temperatures during processing, extractives migrate to the surface where they concentrate and physically block adhesive contact with wood. Furthermore, pitchy and oily extractives are hydrophobic (that is, they repel water). The acidity of extractives of some Southeast Asian hardwoods and oak species can interfere with the chemical cure of some adhesives. In contrast, alkaline extractives can retard normal polymerization of an acid-cured adhesive, such as urea-formaldehyde, which would compromise the integrity of the adhesive film and bond.

Overdrying and overheating interfere with adhesion by causing extractives to diffuse to the surface, by reorienting surface molecules and exposing the less polar portion, by oxidizing or pyrolyzing the wood, or by irreversibly closing the larger micropores of cell walls. Airborne chemical contaminants can also inactivate a wood surface.

To reduce decay, wood is treated with a variety of preservatives, including creosote, pentachlorophenol, chromated copper arsenate (CCA), copper azole, ammoniacal copper quat, and boron compounds. These treatments generally decrease the ability of the adhesive to wet the wood; the effect is greater with some treatments than others. Poor wetting reduces contact area and thus bond strength between adhesive and wood. In addition, some treatments are known to alter the curing of adhesives. By understanding the properties of these modified woods, adhesive companies have been able to alter the adhesives and bonding process to provide sufficiently durable products.

The most common fire-retarding chemicals used for wood are inorganic salts based on phosphorous, nitrogen, and boron. These acid salts release acid at elevated temperatures to decrease flammable volatiles and increase char in wood, thereby effectively reducing flame spread. The elevated temperature and moisture conditions of hot-press curing can release some of these acids, inhibiting the cure of alkaline phenolic adhesives. Alkaline resins can still make durable bonds after some of these treatments by priming the wood with certain alkaline aqueous solutions or by selecting resins of appropriate molecular-size distribution.

Chemical modification of wood by acetylation drastically reduces moisture-related dimensional changes and the rate of biodeterioration. Acetic anhydride reacts with the

hydroxyl groups of wood. The conversion of hydroxyl groups to acetyl groups results in a lower affinity for water. Room-temperature-curing resorcinolic and acid-catalyzed phenolic hot-press adhesives develop durable bonds to acetylated wood. Most other wood adhesives develop poorer bonds with acetylated wood than with untreated wood.

Bonding of Wood Composite Products and Nonwood Materials

The surfaces of wood composites such as plywood, oriented strandboard, particleboard, fiberboard, and hardboard generally have poor wettability relative to that of freshly cut, polar wood surfaces. Surfaces of these materials may appear glazed, indicating that they have been inactivated by pressing at high temperatures. During hot pressing, resinous extractives and added waxes migrate to the surface, adhesive on the outer surfaces of particles and fibers cures, and caul release agents remain on the surfaces—all of which reduce wetting by waterborne wood adhesives. Surfaces of composite products typically are more difficult to bond than surfaces of solid wood products. Lightly sanding with 320-grit sandpaper often improves adhesion to composite panel products having poor wettability (Fig. 10–3). Too much sanding can create an uneven surface and perhaps produce too much loose-fiber debris that can interfere with adhesion. Furthermore, the internal strength of composites often limits the strength of adhesive bonds.

Products incorporating wood composites bonded to metal or plastic are becoming more common because of property and cost advantages, but they present special challenges. Metal foils and plastic films laminated to wood composites do not require high cohesive strength for indoor applications, but the adhesives still must be compatible with both the wood and nonwood surfaces. If a structural bond is required between wood and metal or plastic, then only epoxy, polyurethane, and isocyanate-based adhesives may be sufficiently compatible. Even then, good adhesion often requires cleaning of the nonwood surfaces to remove contaminants or applying coupling agents, primers, or other special treatments to chemically activate the surfaces.

The difficulty with bonding metals to wood is usually metal surface inactivation. The surface energy of clean metals is higher than that of wood, but with exposure to air, metals quickly adsorb contaminants and form metal oxides to produce a low-energy, weak boundary layer at the surface. A series of cleaning procedures is required to regenerate the high-energy surface and create microscale roughness necessary for structural bonding. Steps in surface preparation may include abrasion by sandblasting, cleaning with liquid or vapor organic solvents, alkaline washing, chemical etching, and/or priming with adhesive solutions or coupling agents.

Plastic surfaces are difficult to bond because they are generally low energy, nonpolar, and hydrophobic. Plastics are

organic polymers that may be either thermoplastic (soften on heating) or thermosetting (cross-linked and resist softening on heating). Thermoplastics generally are not as strong and stiff as wood, but the properties of thermoset materials approximate and even exceed the mechanical properties of wood. When plastics containing fibrous reinforcing materials such as fiberglass are bonded to woods, strength and stiffness of the composite materials can be greater than that of wood. Reinforced plastics that are effectively bonded to wood offer strong and cost-effective structural composites. Traditional waterborne wood adhesives do not bond well to plastics because they are polar and hydrophilic. Epoxies, polyurethanes, and isocyanate-based adhesives are capable of bonding many plastics to wood. Adhesion to plastic surfaces occurs primarily by physical intermolecular attraction forces and, in some cases, hydrogen bonding. Abrading and chemical etching of plastic surfaces increase adhesion by providing some mechanical interlocking. Coupling agents have molecules that are capable of reacting with both the adhesive and the surface, making them particularly useful for bridging dissimilar materials. Plasma treatment of plastic surfaces can clean and activate surfaces for enhanced adhesion. Grafting of monomers onto cleaned plastic surfaces by means of plasma polymerization creates a polar surface that is more compatible with adhesives.

Physical Properties of Wood for Bonding

Density and Porosity

Surface properties are not the only factors to control bonding in wood. Bond quality is also affected by the bulk physical properties of wood, particularly density, porosity, moisture content, strength, and swelling–shrinking properties.

Solid wood cell walls have a density of $1,500 \text{ kg m}^{-3}$ (94 lb ft^{-3}), regardless of the wood species. However, density varies greatly with void volume and thickness of cell walls between wood species and within a species, and between earlywood and latewood growth (as discussed in Chap. 3). High-density wood has thick walls and small lumina, whereas low-density wood has thin walls and large lumina. Thus, higher density wood contains more material per unit of volume and can carry more load.

Adhesively bonded wood assemblies typically increase in strength with wood density up to a range of 700 to 800 kg m^{-3} (44 to 50 lb ft^{-3}) (moisture content 12%). Below this level, adhesion is usually easy and the strength of the wood limits the assembly strength. Above this level, high-strength joints with high wood failure are hard to produce consistently. Wood failure refers to the percentage of the total failure area that is wood, rather than adhesive. High wood failure is preferred because the load design values can be based upon the known wood strength and not reduced because of the quality of the bondline.

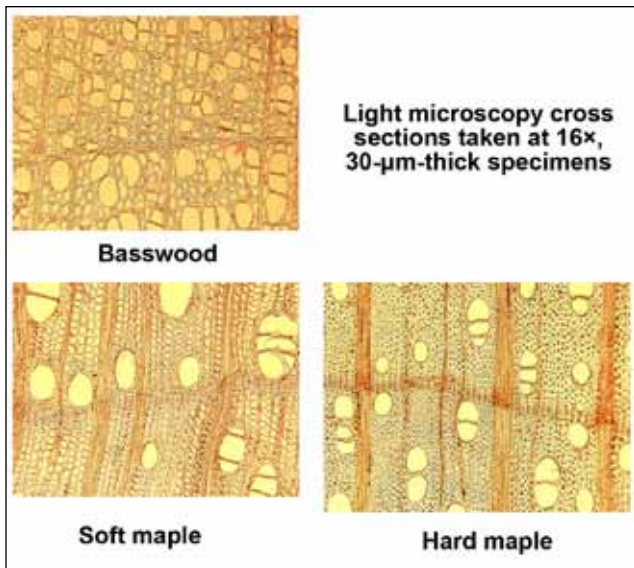

Figure 10–4. Cross sections of three different species showing openness of cellular structure. Basswood is in the “bond easily” category in Table 10–1, soft maple “bond well,” and hard maple “bond satisfactorily.” The more easily bonded wood has greater lumen volume for adhesive penetration and less cell wall volume. The lower density of the basswood compared with the hard maple makes the wood weak, and therefore less force can be applied to the bondline.

High-density woods are difficult to bond for several reasons. Because of their thicker cell walls and smaller diameter lumens, adhesives do not easily penetrate into the wood, limiting mechanical interlock to less than two cells deep. Much greater pressure is required to compress stronger, stiffer, high-density wood to bring contact between wood surfaces and adhesive. Higher concentration of extractives that may interfere with the cure of adhesives is common in high-density species, particularly domestic oaks and imported tropical hardwoods. High-density woods are strong and allow high loads to be placed upon the bondline. Finally, high-density woods tend to swell and shrink more with changes in moisture content than do low-density woods.

Density is perhaps a crude indicator, but as previously noted, it is useful for estimating the bondability of a great variety of wood species. Table 10–1 categorizes commonly used domestic and imported species according to their relative ease of bonding. The bondability categories for domestic woods are based on the average strength of side-grain joints of lumber as determined in laboratory tests and industrial experience. The laboratory tests included animal, casein, starch, urea-formaldehyde, and resorcinol-formaldehyde adhesives. The categories for imported woods are based on information found in the literature on bond strength, species properties, extractives content, and industrial experience.

In most cases, fewer data are available for imported woods than domestic woods. Beware that a species that bonds poorly with one adhesive may develop much better bonds with another adhesive. A similar type of adhesive with somewhat different working, penetration, curing, and even strength properties can often dramatically improve bondability of a given species. Adhesive suppliers quite often adjust adhesive formulations to solve specific adhesion problems.

Wood density and anatomy control wood porosity, which usually affects penetration and bond performance. To attain the highest joint strength, the adhesive must penetrate and interlock several cells deep into sound, undamaged cell structure. In wood, porosity varies according to the grain direction. End-grain surfaces are many times more porous than radial or tangential surfaces. Adhesives penetrate so easily into the open lumens along the grain that overpenetration often occurs when gluing end-grain. This overpenetration is a primary reason why it is so difficult to form strong, load-bearing bonds in butt joints. Across the grain, paths for adhesive flow are fewer and smaller, so overpenetration generally is not a problem with a properly formulated adhesive.

The porosity and resulting adhesive flow into wood varies greatly, both between hardwoods and softwoods and within each of these groups. In Figure 10–4, cross-section micrographs demonstrate the large differences in lumen volume between three diffuse-porous hardwood species. Softwoods have longitudinal tracheid lumens connected by bordered pits. Pits are the small openings between fibers that permit lateral transfer of fluids in living trees. Adhesives might use the network of pits to penetrate deeply, even in tangential and radial directions. In hardwoods, the thin-walled, relatively large longitudinal vessels have porous end walls, so adhesive can penetrate deeply along the end grain. Where two vessels are in lateral contact, multiple inter-vessel pitting can occur, which allows for lateral flow between vessels. The remaining thick-walled fibers have relatively few pits for lateral transfer of adhesive. Some species, such as red oaks, have large numbers of radially oriented rays that can allow excessive flow and overpenetration. Adhesives provided for customers who use large volume are specifically formulated for hardwoods or softwoods, and for specific species within the groups, and have adjustable properties for specific manufacturing situations.

Moisture Content and Dimensional Changes

Water occurs naturally in living trees and affects wood properties and adhesive bond strength dramatically. Depending on extractives levels and wood chemistry, wood can typically take up 25% to 30% of its dry weight in water. The point at which wood cannot adsorb any more water is called the fiber saturation point. As wood dries below the fiber saturation point, it begins to shrink and become stiffer. Above the fiber saturation point, excess water simply fills lumens and makes wood heavier. Wood in service will

Table 10–1. Categories of selected wood species according to ease of bonding

U.S. hardwoods	U.S. softwoods	Imported woods	
Bond easily^a			
Alder	Fir	Balsa	Hura
Aspen	White	Cativo	Purpleheart
Basswood	Grand	Courbaril	Roble
Cottonwood	Noble	Determa ^b	
Chestnut, American	Pacific		
Magnolia	Pine		
Willow, black	Eastern white		
	Western white		
	Redcedar, western		
	Redwood		
	Spruce, Sitka		
Bond well^c			
Butternut	Douglas-fir	Afromosia	Meranti (lauan)
Elm	Larch, western ^d	Andiroba	Light red
American	Pine	Angelique	White
Rock	Sugar	Avodire	Yellow
Hackberry	Ponderosa	Banak	Obeche
Maple, soft	Redcedar, eastern	Iroko	Okoume
Sweetgum		Jarrah	Opepe
Sycamore		Limba	Peroba rosa
Tupelo		Mahogany	Sapele
Walnut, black		African	Spanish-cedar
Yellow-poplar		American	Sucupira
			Wallaba
Bond satisfactorily^e			
Ash, white	Yellow-cedar	Angelin	Meranti (lauan), dark red
Beech, American	Port-Orford-cedar	Azobe	Pau marfim
Birch	Pines, southern	Benge	Parana-pine
Sweet		Bubinga	Pine
Yellow		Karri	Caribbean
Cherry			Radiata
Hickory			Ramin
Pecan			
True			
Madrone			
Maple, hard			
Oak			
Red ^b			
White ^b			
Bond with difficulty^f			
Osage-orange		Balata	Keruing
Persimmon		Balau	Lapacho
		Greenheart	Lignumvitae
		Kaneelhart	Rosewood
		Kapur	Teak

^aBond very easily with adhesives of a wide range of properties and under a wide range of bonding conditions.

^bDifficult to bond with some phenol-formaldehyde adhesives.

^cBond well with a fairly wide range of adhesives under a moderately wide range of bonding conditions.

^dWood from butt logs with high extractive content is difficult to bond.

^eBond satisfactorily with good-quality adhesives under well-controlled bonding conditions.

^fSatisfactory results require careful selection of adhesives and very close control of bonding conditions; may require special surface treatment.

shrink and swell as it loses and gains moisture from the air; under typical indoor conditions, wood contains 5% to 12% moisture. The shrinking and swelling (dimensional changes) are different for the three principal directions in wood. Longitudinal dimensional change (along the grain, or up and down in the standing tree) is the least and amounts to less than 1% between fiber saturation and oven-dry. Tangential dimensional change is the greatest, typically 6% to 12%, while radial dimensional change is typically about half of the tangential movement. Wood with low density tends to have the smallest dimensional change. Chapter 4 provides a detailed discussion of wood–moisture relations.

Wood dimensional changes that accompany changes in moisture content have broad-ranging and important consequences on the performance of bonded joints. As wood in bonded assemblies swells and shrinks, stresses develop that can damage the adhesive bond or wood. Damage may occur when moisture content changes in adjacent pieces of wood that have different swelling or shrinkage coefficients. This can arise with different species, different heartwood, sapwood, or juvenile wood content, or grain type, such as radial grain bonded to tangential or end grain bonded to cross grain. Even more stressful is when only one part of an assembly changes moisture content. Dimensional changes associated with water are a common cause of adhesive failure. Moisture-driven stresses can be minimized by bonding pieces of wood with compatible grain directions and low shrinkage coefficients and by bonding at the moisture content expected during service.

The moisture in wood combined with water in adhesive will greatly influence the wetting, flow, penetration, and cure of waterborne wood adhesives. In general, optimum adhesive properties occur when the wood is between 6% and 14% moisture content. Special formulations are often used outside this range. Aqueous adhesives tend to dry out when applied to wood below 6% moisture content. Wood absorbs water from the adhesive so quickly that adhesive flow and penetration into the wood are drastically inhibited, even under high pressure. Wood may become so dry below 3% moisture content that it temporarily resists wetting.

Wood with too much moisture is also difficult to bond with normal waterborne adhesives. Water and low-molecular-weight portions of the adhesive migrate less effectively into wet wood cell walls than into drier cell walls. This leaves the adhesive more runny and prone to squeeze-out when pressure is applied. The extra adhesive mobility can also lead to overpenetration and starvation of the bond. In many adhesives, low-molecular-weight components infiltrating the cell walls are necessary for long-term durability. Control of moisture content is particularly critical when adhesive is cured in a hot press because the excess moisture turns to high-pressure steam inside the product. This pressurized steam can blast channels through the wood product or cause

large internal voids, called blows, in panel products. Even if blows do not occur, excess moisture within thermosetting adhesives can prevent complete cross linking, thereby weakening the adhesive. Appropriate moisture content levels of wood for bonding by hot-press methods are well known, as are target moisture content levels for wood products throughout the United States. However, controlling moisture content during bonding of wood materials is not always easy (as discussed in the Moisture Content Control section).

Adhesives

Composition

During the 20th century, wood adhesives shifted from natural to synthetic organic polymers. A polymer is a large molecule constructed of many small repeated units. Natural polysaccharide and protein polymers in blood, hide, casein, soybean, starch, dextrin, and other biomass have been used as adhesives for centuries. These polymers are still in use today, although they have been largely replaced by petrochemical and natural-gas-based systems. The first wood adhesives based on synthetic polymers were produced commercially during the 1930s. Synthetic polymers can be made stronger, more rigid, and more durable than wood, and they generally have much greater water resistance than do traditional adhesives from natural polymers. However, recent advances in biomass-based adhesives have made them more competitive with fossil-fuel-based adhesives than are traditional ones.

Whether a synthetic adhesive is thermoplastic or thermosetting has a major influence on its performance in service. Thermoplastics are long-chain polymers that soften and flow on heating and then harden again upon cooling. They generally have less resistance to heat, moisture, and long-term static loading than do thermosetting polymers. Common thermoplastic adhesives for wood include poly(vinyl acetate) emulsions, elastomeric, contact, and hot-melts. Thermosetting polymers make excellent structural adhesives because they undergo irreversible chemical change when cured, and on reheating, they do not soften and flow again. They form cross-linked polymers that can have high strength, have resistance to moisture and other chemicals, and are rigid enough to support high, long-term static loads without deforming. Phenol-formaldehyde, resorcinol-formaldehyde, melamine-formaldehyde, urea-formaldehyde, isocyanate, and epoxy adhesives are examples of thermosetting polymers.

When delivered, adhesives usually contain a mixture of several chemically active and inert materials, each added for specific properties such as working characteristics, strength properties, shelf life, or durability. Solvents dissolve or disperse adhesive polymers, act as carriers of polymer and additives, aid in wetting, and control flow and penetration of

the adhesive. Water is the carrier for most wood adhesives, primarily because water readily absorbs into wood, is inexpensive, and does not have adverse effects on the environment. Organic solvents are still used with elastomeric and contact adhesives, although waterborne adhesive systems are becoming more important in these markets as well. Reinforcing fibers, mostly inert organics, can enhance mechanical properties of the adhesive film, especially toughness, impact resistance, and shrinkage. Fillers of both organic and inorganic origins contribute to rheological control of the fluid system, particularly in reducing the spreading and penetrating of the adhesive into wood. Extenders are like fillers, in that they control flow and working characteristics, but are different in that they do not reduce bond strength.

Certain chemicals are added to plasticize adhesive polymers, enhance tackiness, improve heat resistance, or lower costs. Plasticizers, for example dibutyl phthalate, are used to soften the brittle vinyl acetate homopolymer in poly(vinyl acetate) emulsion adhesives. This is necessary to facilitate adhesive spreading and formation of a flexible adhesive film from the emulsion at and below room temperature. Phenolic polymers are used as tackifiers and adhesion promoters in neoprene and nitrile rubber contact adhesives. Reactive polymeric fortifiers, such as melamine-formaldehyde, can be substituted into urea-formaldehyde adhesives to improve resistance to moisture and heat. Substituting phenol-formaldehyde for resorcinol-formaldehyde reduces adhesive costs without sacrificing adhesive strength and durability.

Catalysts are chemicals used to accelerate the rate of chemical reaction of polymeric components. Acids, bases, salts, peroxides, and sulfur compounds are a few examples of catalysts. Catalysts do not become a part of the reacted compound; they simply increase the rate of reaction. Usually, hardeners are added to base polymers as reactive components, and they do become a part of the reacted compound. Examples are an amine hardener added to epoxy and formaldehyde added to resorcinol—both produce cross-linking reactions to solidify the adhesive. For curing urea-formaldehyde and melamine-formaldehyde adhesives, hardeners are actually catalysts in that they cure the adhesive but do not become part of the polymer. Other chemicals, such as antioxidants, acid scavengers, preservatives, wetting agents, defoamers, or colorants, may be added to control or eliminate some of the less desirable characteristics of certain adhesive formulations.

Strength and Durability

Table 10–2 loosely classifies adhesives according to how much load they can bear and how long they can sustain the load without deforming when exposed to water, heat, or other environmental conditions. In building construction, adhesives that contribute strength and stiffness to the structure during its life are considered structural. These adhesives generally are stronger and stiffer than the wood that they

bond. Structural bonds are critical because bond failure could result in serious damage to the structure or its occupants. Examples of structural applications include glued-laminated beams, prefabricated I-joists, and stressed-skin panels. Structural adhesives that maintain their strength and rigidity under the most severe cyclic water saturation and drying are considered fully exterior adhesives. Adhesives that degrade faster than wood under severe conditions, particularly water exposure, are considered interior adhesives. Between exterior and interior adhesives are the intermediate adhesives, which maintain strength and rigidity in short-term water soaking but deteriorate faster than wood during long-term exposure to water and heat. Unfortunately, adhesives that are the strongest, most rigid, and most resistant to deterioration in service are typically the least tolerant of wide variations in wood surface condition, wood moisture content, and assembly conditions, including pressures, temperatures, and curing conditions.

Semistructural adhesives impart strength and stiffness to an adhesive-bonded assembly, and in some instances, they may be as strong and rigid as wood. However, semistructural adhesives generally do not withstand long-term static loading without deformation. They are capable of short-term exposure to water although some do not withstand long-term saturation, hence their limited exterior classification. Another semistructural adhesive application is the nailed–glued assembly where failure of the bond would not cause serious loss of structural integrity because the load would be carried by mechanical fasteners.

Nonstructural adhesives typically support the dead weight of the material being bonded and can equal the strength and rigidity of wood in the dry condition. On exposure to water or high humidity, most nonstructural adhesives continue to support the weight of the material sufficiently, though a few lose the ability to transfer load. A major market for nonstructural adhesives is furniture assembly.

Elastomeric construction adhesives are categorized as nonstructural but are normally used for field assembly of panelized floor and wall systems in the light-frame construction industry. These adhesive joints are much stiffer than mechanically fastened joints, resulting in stiffer panels. In addition to the adhesive, mechanical fasteners are used to carry the load in case of adhesive failure.

Some adhesives listed in Table 10–2 could be easily included in more than one category because they can be formulated for a broad range of applications. Isocyanate and polyurethane adhesives are examples. Polymeric methylene diphenyl diisocyanate, with a low molecular weight, develops highly durable bonds in structural strandboard, even though strandboard products deteriorate from swelling and shrinkage stresses. One-part polyurethane adhesives have highly durable adhesive films, but as molecular weight

Table 10–2. Wood adhesives categorized according to their expected structural performance at various levels of environmental exposure^{a,b}

Structural integrity	Service environment	Adhesive type
Structural	Fully exterior (withstands long-term water soaking and drying)	Phenol-formaldehyde
		Resorcinol-formaldehyde
		Phenol-resorcinol-formaldehyde
		Emulsion polymer isocyanate
Limited exterior (withstands short-term water soaking)	Interior (withstands short-term high humidity)	Melamine-formaldehyde
		Isocyanate
		Melamine-urea-formaldehyde
Semistructural	Limited exterior	Epoxy
		Polyurethane
Nonstructural	Interior	Urea-formaldehyde
		Casein
		Cross-linked poly(vinyl acetate)
		Cross-linked soybean
		Poly(vinyl acetate)
		Animal
Elastomeric construction		
Elastomeric contact		
Hot-melt		
Starch		

^aAssignment of an adhesive type to only one structural/service environment category does not exclude certain adhesive formulations from falling into the next higher or lower category.

^bPriming wood surfaces with hydroxymethylated resorcinol coupling agent improves resistance to delamination of epoxy, isocyanate, emulsion polymer isocyanate, melamine and urea, phenolic, and resorcinolic adhesives in exterior service environment, particularly bonds to treated lumber.

increases, adhesion to porous wood generally decreases and bonds become increasingly susceptible to deterioration from swelling and shrinkage stresses. Soybean-based adhesives have limited wet strength on their own, but cross-linking agents can be added to increase water resistance.

Selection

Many factors need to be considered when selecting the best adhesive for a particular application. The adhesive must be applied, wet the surface, penetrate into the wood, cure, and maintain strength for sufficient time under different loads and environmental conditions. Table 10–3 describes the typical form, properties, preparation, and uses of many adhesive families, though considerable variation may occur within each family. A manufacturer and adhesive supplier should completely review the product, its intended service environment, and all production processes and equipment before choosing an appropriate adhesive. Whatever the approach to adhesive selection might be, the following points are important.

Strength—The amount of load the adhesive will be required to carry must be considered.

Durability—The kind of environment the bond will be exposed to (liquid water, humidity, heat, cold, chemicals, light, loading level) and the length of exposure will determine durability.

Wetting—As discussed in the introduction, the chemistry of the surface and adhesive must be compatible. A waterborne adhesive on an oily surface is unlikely to spread out unless the adhesive contains surfactants, organic solvents, or other materials to help it spread and make molecular contact with the surface.

Timing—Several timing factors must be considered. Pot life relates to the duration of time before the adhesive is applied to the wood. Open time is the time between applying the adhesive and joining the pieces. Closed time refers to the time between joining the pieces and applying pressure. Clamp time is determined by the duration of set time until the finished piece can be unclamped. Increasing temperature usually shortens set and cure time. Emulsion polymer isocyanates set very rapidly, which is an advantage in wood I-beam assembly. After hot or cold pressing, adhesives typically need hours or weeks to completely cure.

Consistency—The consistency, or viscosity, of the adhesive must be compatible with the application equipment, whether it be brush, spatula, extruder, curtain coater, spray, or powder metering device. In addition, the adhesive must be fluid enough to enter the void spaces in the wood but not so fluid that most of the adhesive is squeezed out of the bondline, causing a starved joint.

Mixing—If water, a hardener, catalyst, filler, or extender must be mixed with a resin, appropriate equipment must be available.

Table 10–3. Working and strength properties of adhesives, with typical uses

Type	Form and color	Preparation and application	Strength properties	Typical uses
Natural origin				
Animal, protein	Solid and liquid; brown to white bondline	Solid form added to water, soaked, and melted; adhesive kept warm during application; liquid form applied directly; both pressed at room temperature; bonding process must be adjusted for small changes in temperature	High dry strength; low resistance to water and damp atmosphere	Assembly of furniture and stringed instruments; repairs of antique furniture
Blood, protein	Solid and partially dried whole blood; dark red to black bondline	Mixed with cold water, lime, caustic soda, and other chemicals; applied at room temperature; pressed either at room temperature or 120 °C (250 °F) and higher	High dry strength; moderate resistance to water and damp atmosphere and to microorganisms	Interior-type softwood plywood, sometimes in combination with soybean adhesive; mostly replaced by phenolic adhesive
Casein, protein	Powder with added chemicals; white to tan bondline	Dissolved in water under basic conditions; applied and pressed at room temperature	High dry strength; moderate resistance to water, damp atmospheres, and high temperatures; not suitable for exterior uses	Mainly in interior doors, especially fire doors; used in laminated timbers
Cross-linked soybean, protein	Powder or dispersion with added chemicals; white to tan, similar color in bondline	Either dissolve the solid in water with other added chemicals or use a pre-dispersed soy, mix with cross linker prior to application; cured in hot press at 120 to 150 °C (250 to 300 °F)	Good dry strength and decent resistance to water and damp atmospheres; good resistance to elevated temperatures	Decorative plywood for interior use, laminated flooring, particleboard, and oriented strandboard
Lignins and tannins	Powder or liquid; may be blended with phenolic adhesive; dark brown bondline	Blended with extender and filler by user; adhesive cured in hot-press 130 to 150 °C (266 to 300 °F) similar to phenolic adhesive	Good dry strength; moderate to good wet strength; durability improved by blending with phenolic adhesive	Partial replacement for phenolic adhesive in composite and plywood panel products
Soybean, protein	Powder with added chemicals; white to tan, similar color in bondline	Mixed with cold water, lime, caustic soda, and other chemicals; applied and pressed at room temperatures, but more frequently hot pressed when blended with blood adhesive	Moderate to low dry strength; moderate to low resistance to water and damp atmospheres; moderate resistance to intermediate temperatures	Decorative plywood for interior use; combinations with phenolics gives good moisture durability
Synthetic origin				
Cross-linked poly(vinyl acetate) emulsion	Liquid, similar to poly(vinyl acetate) emulsions but includes copolymers capable of cross linking with a separate catalyst; white to tan with colorless bondline	Liquid emulsion mixed with catalyst; cure at room temperature or at elevated temperature in hot press and radio-frequency press	High dry strength; improved resistance to warm temperatures and moisture, particularly long-term performance in moist environment	Interior and exterior doors; molding and architectural woodwork; cellulosic overlays
Elastomeric contact	Viscous liquid, typically neoprene or styrene-butadine elastomers in organic solvent or water emulsion; tan to yellow	Liquid applied directly to both surfaces, partially dried after spreading and before pressing; roller-pressing at room temperature produces instant bonding	Strength develops immediately upon pressing, increases slowly over a period of weeks; dry strengths much lower than those of conventional wood adhesives; low resistance to water and damp atmospheres; adhesive film readily yields under static load	On-the-job bonding of decorative tops to kitchen counters; factory lamination of wood, paper, metal, and plastic sheet materials

Table 10–3. Working and strength properties of adhesives, with typical uses—con.

Type	Form and color	Preparation and application	Strength properties	Typical uses
Elastomeric mastic (construction adhesive)	Putty-like consistency, synthetic or natural elastomers in organic solvent or latex emulsions; tan, yellow, gray	Mastic extruded in bead to framing members by caulking gun or like pressure equipment; nailing required to hold materials in place during setting and service	Strength develops slowly over several weeks; dry strength lower than conventional wood adhesives; resistant to water and moist atmospheres; tolerant of outdoor assembly conditions; gap-filling; nailing required to ensure structural integrity	Lumber to plywood or strandboard in floor and wall systems; laminating gypsum board and rigid foam insulating; assembly of panel system in manufactured homes
Emulsion polymer isocyanate	Liquid emulsion and separate isocyanate hardener; white with hardener; colorless bondline	Emulsion and hardener mixed by user; reactive on mixing with controllable pot-life and curing time; cured at room and elevated temperatures; radio-frequency curable; high pressure required	High dry and wet strength; very resistant to water and damp atmosphere; very resistant to prolonged and repeated wetting and drying; adheres to metals and plastics	Laminated beams for interior and exterior use; lamination of plywood to steel metals and plastics; doors and architectural materials
Epoxy	Liquid resin and hardener supplied as two parts; completely reactive, mainly solvent-free; clear to amber; colorless bondline	Resin and hardener mixed by user; reactive with limited pot-life; cured at room or elevated temperatures; only low pressure required for bond development	High dry and wet strength to wood, metal, glass, and plastic; formulations for wood resist water and damp atmospheres; delaminate with repeated wetting and drying; gap-filling	Laminating veneer and lumber in cold-molded wood boat hulls; assembly of wood components in aircraft; lamination of architectural railings and posts; repair of laminated wood beams and architectural building components; laminating sports equipment; general purpose home and shop
Hot melt	Solid blocks, pellets, ribbons, rods, or films; solvent-free; white to tan; near colorless bondline	Solid form melted for spreading; bond formed on solidification; requires special application equipment for controlling melt and flow	Develops strength quickly on cooling; lower strength than conventional wood adhesives; moderate resistance to moisture; gap-filling with minimal penetration	Edge-banding of panels; plastic lamination; patching; film and paper overlays; furniture assembly; general purpose home and shop
Isocyanate	Liquid containing monomers and oligomers of methylene diphenyl diisocyanate; light brown liquid and clear bondline	Adhesive applied directly by spray; reactive with water; requires high temperature and high pressure for best bond development in flakeboards	High dry and wet strength; very resistant to water and damp atmosphere; adheres to metals and plastics	Flakeboards; particleboard, strand-wood products
Melamine- and melamine-urea-formaldehyde	Powder with blended catalyst; may be blended up to 40% with urea; white to tan; colorless bondline	Dissolved in water; cured in hot press with platens at 120 to 150 °C (250 to 300 °F) and lower internal temperatures; particularly suited for fast curing in high-frequency presses	High dry and wet strength; very resistant to water and damp atmospheres	Melamine–urea-formaldehyde primary adhesive for durable bonds in hardwood plywood; end-jointing and edge-gluing of lumber; and scarf joining softwood plywood, ultra-low emitting form-aldehyde adhesive for particleboard and fiberboard

Table 10–3. Working and strength properties of adhesives, with typical uses—con.

Type	Form and color	Preparation and application	Strength properties	Typical uses
Phenol-formaldehyde	Liquid, powder, and dry film; dark red bondline	Liquid blended with extenders and fillers by user; film inserted directly between laminates; liquid or powder applied directly to flakes in composites; all formulations cured in hot press at 120 to 150 °C (250 to 300 °F) up to 200 °C (392 °F) in flakeboards	High dry and wet strength; very resistant to water and damp atmospheres; more resistant than wood to high temperatures and chemical aging	Primary adhesive for exterior softwood plywood, flakeboard, hardboard, and low emission particleboard
Poly(vinyl acetate) emulsion	Liquid ready to use; often polymerized with other polymers; white to tan to yellow; colorless bondline	Liquid applied directly; pressed at room temperatures and in high-frequency press	High dry strength; low resistance to moisture and elevated temperatures; joints yield under continued stress	Furniture; flush doors; plastic laminates; panelized floor and wall systems in manufactured housing; general purpose in home and shop
Polyurethane	Low viscosity liquid to high viscosity mastic; supplied as one-part or two-part systems; completely reactive; color varies from clear to brown; colorless bondline	Adhesive applied directly to one surface, preferably to water-misted surface; reactive with moisture on surface and in air; cures at room temperature; high pressure required, but mastic required only pressure from nailing	High dry and wet strength; resistant to water and damp atmosphere; limited resistance to prolonged and repeated wetting and drying; gap-filling	General purpose home and shop; construction adhesive for panelized floor and wall systems; laminating plywood to metal and plastic sheet materials; specialty laminates; installation of gypsum board
Resorcinol- and phenol-resorcinol-formaldehyde	Liquid resin and powdered hardener supplied as two parts; phenol may be copolymerized with resorcinol; dark red bondline	Liquid mixed with powdered or liquid hardener; resorcinol adhesives cure at room temperatures; phenol-resorcinols cure at temperatures from 21 to 66 °C (70 to 150 °F)	High dry and wet strength; very resistant to moisture and damp atmospheres; more resistant than wood to high temperature and chemical aging	Primary adhesives for laminated timbers and assembly joints that must withstand severe service conditions
Urea-formaldehyde	Powder and liquid forms; may be blended with melamine or other more durable resins; white to tan resin with colorless bondline	Powder mixed with water, hardener, filler, and extender by user; some formulations cure at room temperatures, others require hot pressing at about 120 °C (250 °F) for plywood and 210 °C (410 °F) for fiberboard and particleboard; curable with high-frequency heating	High dry and wet strength; moderately durable under damp atmospheres; moderate to low resistance to temperatures in excess of 50 °C (122 °F)	Hardwood plywood; furniture; medium density fiberboard; particleboard; underlayment; flush doors; furniture cores

Pressure—Pressure is applied to joints to ensure close contact between the parts. Typically, most wood adhesives do not fill gaps well and so require high pressure. Pressure also helps the adhesive to wet and penetrate the wood surface by forcing it into the void spaces of wood. However, too high a pressure, such that the adhesive largely squeezes out, should be avoided.

Temperature—The adhesive should work under different temperature conditions. The temperature of the surrounding environment can affect adhesive pot life, duration of open time, and curing. Phenol-formaldehyde, melamine-formaldehyde, urea-formaldehyde, and isocyanate adhesives must be cured at high temperatures and require expensive, heated presses. Some of these are cured within minutes in

expensive, high-frequency, heated presses. Emulsion polymer isocyanates, poly(vinyl acetate), epoxy, polyurethanes, and resorcinol-containing adhesives cure well at room temperatures.

Moisture content—Many adhesives need low wood moisture content to penetrate the wood. However, isocyanates and polyurethanes are less sensitive and may even perform better at higher moisture contents.

Color and finishing properties—In furniture and interior millwork where appearance is critical, adhesive color, ability to absorb stains and finishes, and freedom from bleeding and staining are critical factors. Adhesives used in the furniture industry are usually formulated to produce a tan or colorless joint.

Ease and simplicity—One-part adhesives, such as poly(vinyl acetate), one-part polyurethane, hot-melt, and phenol-formaldehyde, are the simplest to use because there is no chance for error in weighing and mixing components. Waterborne adhesives are easy to clean up. Two- or multiple-part adhesives require careful measuring and mixing of components and often require special solvents for cleanup after bonding. High water resistance often means more difficult cleanup when cured.

Cost—Given that adhesives are more expensive than the wood, the cost of adhesive and cost of related application equipment and labor must all be considered.

Safety and environment—Many adhesives cure by chemical reactions and therefore are hazardous in the uncured state. Even waterborne adhesives can have organic chemical components that evaporate, causing health concerns for workers and consumers. Frequently, adhesives are toxic to the skin or give off toxic fumes. Formaldehyde hardener for resorcinol, phenol, melamine, and urea adhesives is a severe irritant. Amine hardeners in some epoxy adhesives are strong skin sensitizers. Chemical sensitivity can be caused by repeated exposure to uncured adhesives. State and Federal regulations continue to require adhesives suppliers to reduce air emissions. In recent years, the cost of organic solvents and the cost of recovering volatiles to prevent air pollution have increased. Substitute waterborne systems can be less expensive because of the low cost of the water solvent; however, raising of the wood grain, slower drying, and final product performance must be considered.

Health and Safety

Uncured adhesives can be harmful and require safety precautions, while cured adhesives are usually safe for human contact. A notable exception is urea-formaldehyde adhesive, which can release low concentrations of formaldehyde gas from bonded wood products, especially under hot, moist conditions. **Formaldehyde** can react with proteins of the body to cause irritation and inflammation of membranes of eyes, nose, and throat, and may be a carcinogen. Driven by regulations mandating lower formaldehyde emissions, considerable research has led to new adhesive formulations with significantly reduced levels of formaldehyde emissions in both manufacturing operations and bonded wood products. New standards in the United States and other countries have reduced the acceptable upper limit for formaldehyde emissions. Phenol(resorcinol)-formaldehyde adhesives, which are used to manufacture plywood, strandboard, and laminated beams, also contain formaldehyde. However, the highly durable phenol-formaldehyde, resorcinol-formaldehyde, and phenol-resorcinol-formaldehyde polymers do not chemically break down in service; thus, no detectable formaldehyde is released. Although not quite as durable in bond strength as the phenolics, melamine-formaldehyde polymers do not break down to yield formaldehyde. New ultra-low emitting formaldehyde (**ULEF**) adhesives are formulated

to reduce formaldehyde emissions. Poly(vinyl acetate), isocyanate, and soy adhesives address the formaldehyde issue by being no added formaldehyde (**NAF**). Unless detailed knowledge of the safety of the adhesive is available, it should be assumed that uncured adhesives can be harmful at high concentrations or with chronic exposure.

Diisocyanates are sensitizers that are capable of causing occupational asthma. They also are highly reactive chemicals that polymerize rapidly on contact with strong alkali, mineral acids, and water. Because polymeric methylene diphenyl diisocyanate (pMDI) adhesives develop strong and durable bonds to wood, they have gained acceptance in composite wood products. Any isocyanate is potentially hazardous if mishandled, but the low vapor pressure of pMDI adhesives coupled with adequate ventilation to remove airborne pMDI on dust particles permits manufacturing plants to operate safely. Emulsion polymerized isocyanates (EPI) and polyurethanes also contain the reactive isocyanate group, and so chronic contact with these uncured adhesives should be avoided. Properly cured isocyanate adhesives are not considered hazardous in bonded wood products.

Thermoplastic adhesives are generally of low toxicity, but any added **solvents** may be toxic. Construction and contact adhesives contain organic solvents with low flash points. When used in small, unventilated spaces, the solvent can accumulate in the air and cause an explosion if ignited. Some adhesive producers offer less flammable formulations based on chlorinated solvents. Solvents in these adhesives are generally toxic, but harmful effects can be avoided by providing adequate ventilation and following the manufacturer's safety instructions.

Health and safety regulations require that toxic and hazardous chemicals have a visible label to warn of their dangers. **Material safety data sheets** (MSDS) or instructions are provided with adhesive products to advise of proper handling procedures, protective gear and clothing, and procedures for dealing with spills and fire and to offer guidance for first-aid and professional treatment of injuries. The statements made in this book concerning the safety of adhesives and effects on the health of the user are general and not meant to be all-inclusive. The user should consult the MSDS and follow the manufacturer's instructions and precautions before using any adhesive.

Bonding Process

Moisture Content Control

After wood and adhesive selection, the next most important factor contributing to trouble-free service of adhesive bonds is control of wood moisture content before and during the bonding process. Moisture content strongly affects the final strength and durability of joints, development of surface checks in wood, and dimensional stability of the bonded assembly. Large changes in moisture content after bonding

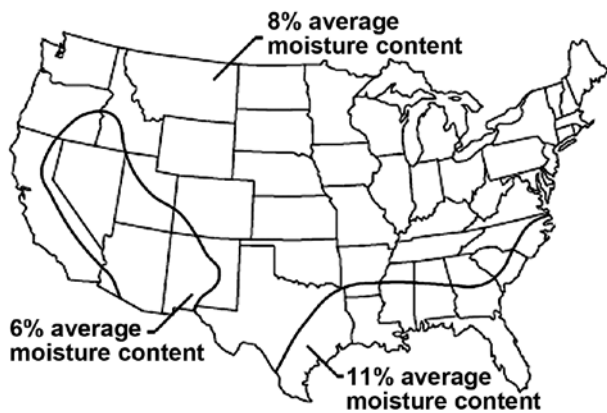

Figure 10–5. Average equilibrium moisture content (EMC) for wood in building interiors in U.S. regions.

will cause shrinking or swelling that can seriously weaken both wood and joint and can cause warping, twisting, and surface irregularities. Wood should not be bonded at high moisture content, particularly high-density wood that has a large coefficient of shrinkage, unless the in-service moisture content is also expected to be high.

The moisture content of wood products should be targeted to the equilibrium moisture content (EMC) that the product will experience in service. The regional average EMC values of wood in building interiors are shown in Figure 10–5. The average moisture content for most of the United States is 8%. Average moisture content increases to 11% along the Atlantic and Gulf coastal regions; in the arid southwest, the EMC is relatively low at 6%. The moisture content of wood outdoors averages near 12% and ranges from 7% to 14% in most of the United States. During winter in the northern states, heating of indoor air that is normally dry lowers wood EMC to 4% to 5% but can raise the moisture levels within the walls. Furniture manufactured in the southeast at 11% EMC, then sold or moved to northern states where EMC drops to 4%, may experience some splitting, delamination of joints, or other noticeable appearance defects. Manufacturers of bonded wood products must be aware of these regional and seasonal variations to condition the wood and bond it at moisture content levels consistent with regional service conditions.

Wood should be dry enough so that even if moisture is added during bonding, the moisture content of the product is at about the level expected for the assembly in service. In lumber laminates, the proportion of glue to wood is so low that a waterborne adhesive adds only 1% to 2% to the total moisture content of the laminate. In particleboard or fiberboard, however, the water in the adhesive can be 3% to 7% of the wood weight. During hot pressing, some water evaporates when the board is removed from the press; to minimize deformation and prevent steam blisters or blows, the total moisture content of the assembly should not exceed 10%. Lumber moisture content of 6% to 7%, assuming 1%

to 2% will be added by aqueous adhesives, is satisfactory for cold pressing of furniture and interior millwork. Lumber laminated for exterior use should contain 10% to 12% moisture before bonding. Moisture content of 3% to 5% in veneer at the time of hot pressing is satisfactory for hardwood plywood intended for furniture and interior millwork and for softwood plywood intended for construction and industrial uses.

Lumber that has been kiln dried to the approximate average moisture content intended for bonding may nonetheless vary in moisture content level between boards and within individual boards. Large differences in moisture content between adjacent boards result in considerable stress on the common joint as the boards equalize toward a common moisture content. Best results are achieved when differences in moisture content are not greater than about 5% for lower density species and 2% for high-density species.

Surface Preparation

The section Surface Properties of Wood for Bonding covers the detailed relationships between surface condition and adhesive bond performance. Wood surfaces are best prepared for maximum adhesive wetting, flow, and penetration by removing all materials that might interfere with bond formation to sound wood. Ideally, wood should be knife-planed within 24 h of adhesive spreading. However, other surfacing methods have been used successfully for certain types of bonded joints, including sawing for furniture and millwork, knife-cutting for veneer, and abrasive-planing for panels. All methods must produce smooth, flat, parallel surfaces, free from machining irregularities, such as burnishes, skips, and crushed, torn, and chipped grain. Properly planed flat surfaces help ensure uniform adhesive spread rate.

Spreading of Adhesive

Regardless of method used for lamination, the purpose in spreading the adhesive is to distribute uniformly an adequate amount of adhesive over the bonding area, so that under pressure, the adhesive will flow into a uniformly thin layer. The amount of adhesive needed will depend on wood species, surface quality of wood, moisture content, type of adhesive, temperature and humidity of the air, assembly time, and application of adhesive to one or both surfaces. Adhesives can be spread by hand with brush, roller, or bead-extruder, but in manufacturing, adhesives are applied mechanically, such as by roll-spreader, extruder, curtain-coater, or spray. Instead of applying a uniform film, extruders apply continuous, uniformly spaced beads of discreet diameter and flow rate (Fig. 10–6). Figure 10–7 shows the use of a pressurized extruder in the field to apply a single bead of elastomeric construction adhesive to joists for a plywood floor system.

For composite manufacturing involving flakes, strands, particles, or fibers, the adhesive is applied as a slow stream or as droplets using a spray nozzle or spinning disc, and then

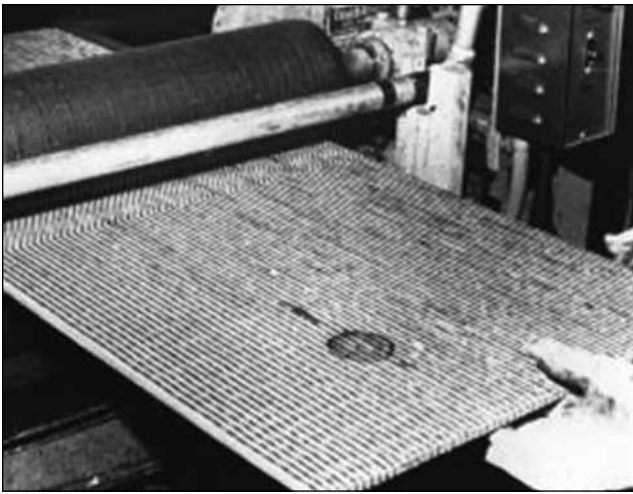

Figure 10–6. An extruder applies continuous and uniformly sized and spaced beads of adhesive to veneer for laminating into laminated veneer lumber (LVL).



Figure 10–7. A pressurized extruder applies a single bead of elastomeric construction adhesive to floor joists for assembly of a plywood floor system.

distributed with a drum blender, kneader, or tube blender. These binder adhesives hold the product together by a series of joints similar to spot welds rather than a continuous film. Microscopic analysis of droplet size and distribution illustrates adhesive distribution and its influence on board properties.

Assembly and Pressing

Adhesive viscosity is important during application, open time, closed time, and pressing. Sometimes keeping the viscosity correct throughout this process requires balancing a variety of factors. The relationship between ad-

hesive viscosity and bonding pressure is illustrated in Figure 10–8. Viscosity strongly affects wetting, flow, penetration, and, particularly, transfer of adhesive to opposing wood surfaces when pressure is applied to the assembly. Adhesive viscosity depends upon type of adhesive, type and quantity of solvent, age of adhesive mixture, and temperature. After application, adhesive viscosity will change depending on the amount of adhesive spread; species, moisture content, and temperature of wood; temperature and humidity of surrounding air; and evaporation and absorption of solvent. When the adhesive-covered surfaces remain open before assembly (open assembly), the adhesive thickens by losing solvent to the air by evaporation and to the wood by absorption. Bringing the adhesive-covered surfaces together (closed assembly) stops evaporation but not absorption. Cold-setting waterborne wood adhesives lose water by absorption and evaporation, so that viscosity steadily increases until the adhesives eventually set. Thermosetting waterborne adhesives also dry out, but they continue to flow to some extent in the presence of heat, eventually hardening by chemical reaction.

Pressure during bond assembly serves several useful purposes by

- forcing trapped air from the joint,
- bringing adhesive into molecular contact with the wood surfaces,
- forcing adhesive to penetrate into the wood structure for more effective surface adhesion and mechanical interlocking,
- squeezing the adhesive into a thin film, and
- holding the assembly in position while the adhesive cures.

If pressure is too high, however, the adhesive can be forced so deeply into (or in some cases out of) the wood that there is insufficient adhesive to fill the bondline. These conditions of overpenetration and excess squeeze-out result in a starved joint and produce inferior bond strength (Fig. 10–8). Overpenetration is especially common in low-density woods, whereas excess squeeze-out is common in high-density woods. The strongest joints are made with moderately high clamping pressure for the wood density, using adhesive with viscosity high enough to avoid overpenetration and excess squeeze-out at that pressure.

Low pressures near 0.7 MPa (100 lb in⁻²) are suitable for low-density wood because the surfaces easily conform to each other, thus ensuring intimate contact between adhesive and wood. High pressures up to 1.7 MPa (247 lb in⁻²) are required for the highest density woods, which are difficult to compress. Small areas of flat, well-planed surfaces can be bonded satisfactorily at lower pressures.

Because adhesives become thicker after they are applied to the wood and some start to cure immediately, assembly times can be very important. Some adhesives require time

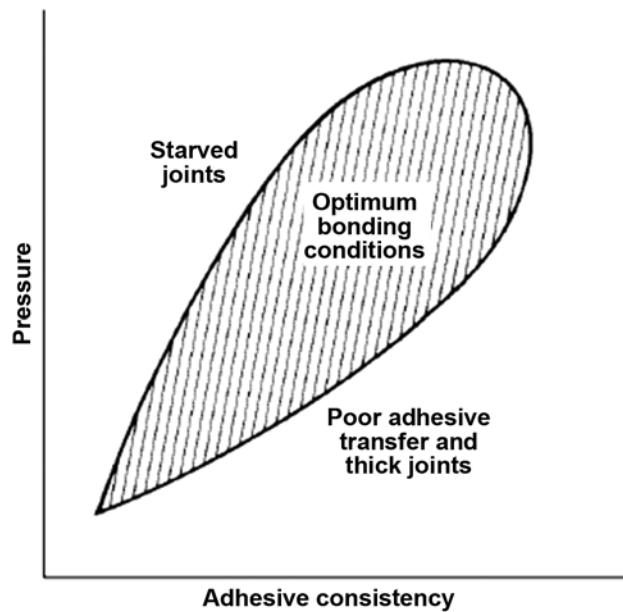

Figure 10-8. Relationship between adhesive consistency and bonding pressure for affect on bond formation using thermosetting adhesive.

before pressing to allow solvents to evaporate or adsorb into the wood, so that the adhesive is thick enough to avoid overpenetration when pressure is applied. On the other hand, adhesives that dry or cure too much before pressing do not transfer, or wet the opposite surface, resulting in thick, weak bondlines.

Bonded material should be kept under pressure until the adhesive is strong enough to resist any forces that may cause parts to shift or open gaps in the bondline. When cold-pressing lumber under normal conditions, this stage can be reached in as little as 15 min or as long as 24 h, depending on adhesive temperature and curing characteristics and the absorptive characteristics of the wood. During hot pressing, the time under pressure varies with temperature of platens, thickness of the assembly and species of wood, and adhesive formulation. Typical hot-pressing times are 2 to 15 min, and up to 30 min for very thick laminates. High-frequency heating can reduce the time under pressure to less than 3 min. High-power radio frequency energy can travel through wood but is strongly absorbed by the water in adhesives, causing selective heating of the adhesive. High-frequency curing is commonly used for bonding lumber; forming end- and edge-grain joints; patching, scarfing, and fingerjointing plywood; and manufacturing various panel products. With high frequency, press times can be shorter than 30 s, as with parquet production using 4- by 10- by 2-mm plies. Careful control of power and press time is essential to prevent arcing, or to control the more common problem of steam pressure that could blow apart the product.

With the stiff structural adhesives (phenol-, resorcinol-, melamine-formaldehyde), the strongest bonds generally

have bondlines between 0.08 and 0.15 mm (1/32 and 1/16 in.) thick. Thinner bondlines do not effectively transfer stresses, particularly stresses from moisture-induced dimensional changes. As these bondlines become thicker, they become weaker and fracture more easily. These adhesives also contain solvents, which cause the adhesive to shrink upon curing and even leave voids. Thick bondlines result from inadequate pressure or incorrect adhesive consistency. When rough, warped, or poorly mated surfaces are joined, pressure will be uneven along the bondline. As a result, the adhesive flow from the areas of very high pressure to those of little to no pressure will result in very thick bondlines. Both the starved and thick areas of the bondline lead to weak bonds.

For composites, the adhesive must have enough strength to withstand the steam pressure inside the panel as the applied press pressure is released. If the adhesive is not sufficiently strong, the internal steam pressure will cause a large delamination (blow) within the product. As the size of the composite increases, there is less relative area for steam escape and the chance of delamination increases. Dry wood, high solids adhesives, less adhesive with better distribution, and faster curing adhesives can decrease the problem of delamination.

Post-Cure Conditioning

In the process of bonding edge-grain joints, the wood in the joint absorbs moisture from the adhesive, then swells. If the bonded assembly is surfaced before this excess moisture is evaporated or absorbed uniformly, more wood is removed along the swollen joint than elsewhere. Later, when the added moisture evaporates, the wood in the joint shrinks beneath the surface. These sunken bondlines become very conspicuous under a high-gloss finish. This is particularly important when using adhesives containing large amounts of water. Moisture can be redistributed by conditioning the bonded assembly for 24 h at 70 °C (158 °F), for 4 days at 50 °C (122 °F), or at least 7 days at room temperature before surfacing. In each case, the relative humidity must be adjusted to prevent drying the wood below the target moisture content.

Conditioning to the moisture content of service is especially important for plywood, veneers, and other composites made of thin layers. During room-temperature bonding, water often needs to be removed, which can be done by controlling humidity on a time schedule. If room-temperature-bonded products are dried too much, warping, checking, and debonding increase markedly. Softwood plywood is often very dry after hot pressing, which can be corrected by spraying the hot panels and stacking them tightly to allow the moisture to diffuse uniformly. This process also restores some of the panel thickness lost by compression during hot pressing and apparently minimizes warping in service. Many composite panels need time after pressing for the adhesive to cure completely and for the moisture to equilibrate throughout the panel.

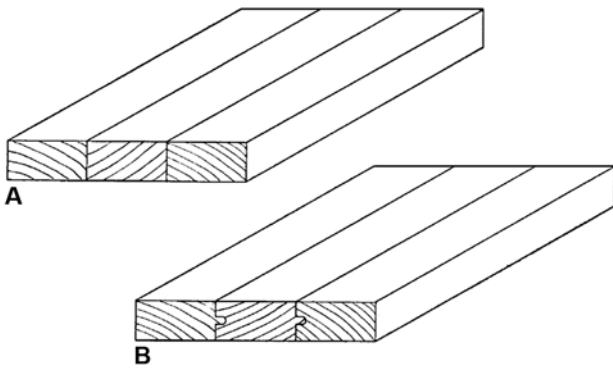

Figure 10-9. Edge-grain joints: A, plain; B, tongue-and-groove.

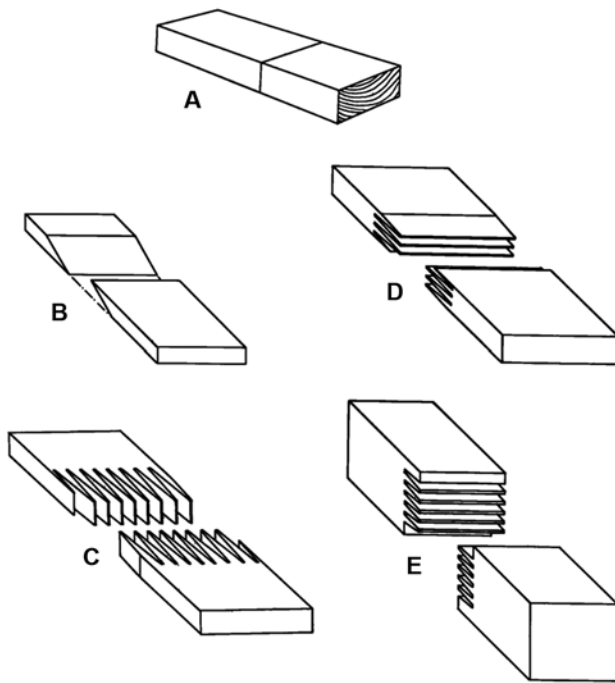

Figure 10-10. End-grain joints: A, butt; B, plain scarf; C, vertical structural fingerjoint; D, horizontal structural fingerjoint; E, nonstructural fingerjoint.

Bonded Joints

Edge-Grain Joints

Edge-grain joints (Fig. 10-9A) can be almost as strong as the wood in shear parallel to the grain, tension across the grain, and cleavage. The tongue-and-groove joint (Fig. 10-9B) and other shaped edge-grain joints have a theoretical strength advantage because of greater surface area than the straight, edge-grain joints, but they do not produce higher strength. The theoretical advantage is lost, wholly or partly, because the shaped sides of the two mating surfaces cannot be machined precisely enough to produce the perfect fit that will distribute pressure uniformly over the entire joint area. Because of poor contact, the effective

bonding area and strength can actually be less in a shaped joint than on a flat surface. Tongue-and-groove and other shaped joints have the advantage that the parts can be quickly aligned in clamps or presses. A shallow-cut tongue-and-groove is just as useful in this respect as a deeper cut, and less wood is wasted.

End-Grain Joints

It is practically impossible to make end-grain butt joints (Fig. 10-10A) strong enough to meet the requirements of ordinary service with conventional bonding techniques. Even with special techniques, butt joints reach only about 25% of the tensile strength of the wood parallel-to-grain. To approximate the tensile strength of clear solid wood, a scarf joint or fingerjoint (Fig. 10-10B-E) should have a surface area at least 10 times greater than the cross-sectional area of the piece, because wood is approximately 10 times stronger in tension than in shear. Joints cut with a slope of 1 in 12 or flatter (12 times the cross-sectional area) produce the highest strength. In plywood scarf and finger joints, a slope of 1 in 8 (8 times the cross-sectional area) is typical for structural products. For nonstructural, low-strength joints, these requirements are unnecessary.

When fingerjoints are cut with a high slope, such as 1 in 12, the tip thickness must be no greater than 0.8 mm (1/32 in.). A thickness of 0.4 to 0.8 mm (1/64 to 1/32 in.) is about the practical minimum for machined tips. Sharper tips are possible using dies that are forced into the end grain of the board.

Fingerjoints can be cut with the profile showing either on the wide face (vertical joint) (Fig. 10-10C) or on the edge (horizontal joint) (Fig. 10-10E). Vertical joints have greater area for designing shapes of fingers but require a longer cutting head with more knives. Vertical joints also cure faster than horizontal joints in high-frequency heating. A nonstructural fingerjoint, with fingers much shorter than in the two structural fingerjoints, is shown in Figure 10-10E.

A well-manufactured scarf, finger, or lap joint in end grain can have up to 90% of the tensile strength of clear wood and exhibit behavior much like that of clear wood. However, the cycles-to-failure for a well-manufactured end joint are often lower than for clear wood.

End-to-Edge-Grain Joints

It is difficult to design a plain end-to-edge-grain joint (Fig. 10-11A) capable of carrying appreciable loading. As a result, it is necessary to design these joints with interlocking surfaces so that edge grain of the interlocking piece bonds to the edge grain of the adjoining piece. Increasing the joint surface area also helps by providing more bondline to transfer load. Some examples of strong connections are dowels, mortise and tenons, and rabbets (Fig. 10-11). Because wood swells so much more across the grain than along the grain, moisture changes in these joints produce large internal stresses. All end-to-edge-grain joints should be protected from changes in moisture content in service.

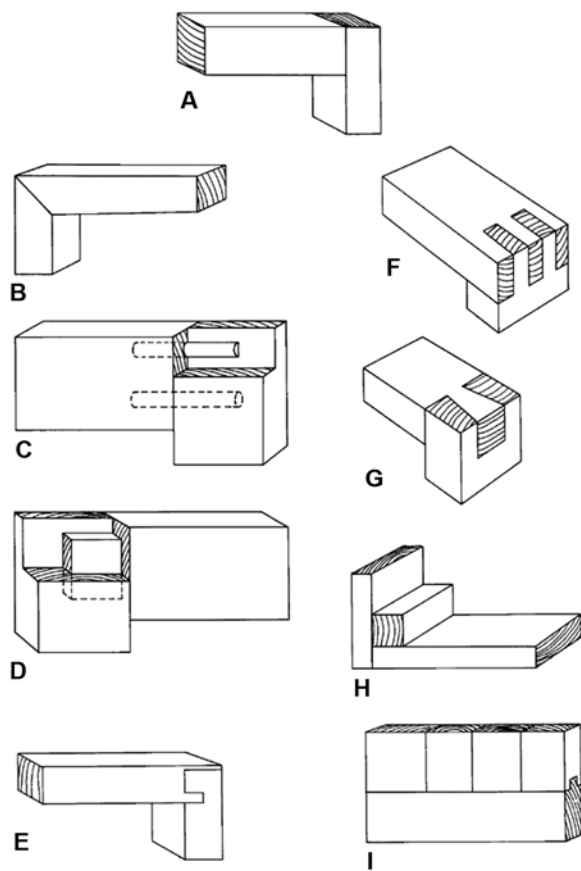

Figure 10-11. End-to-edge-grain joints: A, plain; B, miter; C, dowel; D, mortise and tenon; E, dado tongue and rabbet; F, slip or lock corner; G, dovetail; H, blocked; I, tongue-and-groove.

Construction Joints

Elastomeric construction adhesives are commonly used in the light-frame construction industry for field assembly of panelized floor and wall systems. Structural panels are bonded to floor joists and wall studs with mastic adhesives that have the unique capability of bridging gaps up to 6.5 mm (1/4 in.) between rough and poorly fitting surfaces (Fig. 10-12). Without any premixing, the adhesive is extruded in a bead along framing members with a hand-held caulking gun or a pressurized dispenser similar to that shown in Figure 10-7. Nails or screws provide the only pressure for bonding, and they hold materials in position while the adhesive sets. Elastomerics are also uniquely tolerant of the temperature and moisture content variations at field construction sites. Although they do not deliver the strength and durability of conventional structural adhesives, elastomerics are strong and flexible enough to give long-term performance under most conditions of installation and service.

Construction adhesives enable a nailed or screwed floor system to act to some degree as a composite assembly with increased stiffness. Greater stiffness permits joists to be longer and spaced more widely, with one layer of plywood



Figure 10-12. Gap-filling construction adhesive in field-assembled plywood floor system.

subflooring replacing two. Floors are less bouncy with fewer squeaks and nail pops or screw pulls. However, structural design of the composite assembly is based only on the increased stiffness of nailed or screwed panel and framing materials. The strength contributed by the adhesive cannot be factored into the engineering design but provides increased value to the homeowner.

Testing and Performance

Testing is necessary to ensure that adhesively bonded materials hold together within a given service environment for the life of the structure. Many methods are available to test bonding performance, particularly for bonded assemblies. Generally, these testing methods attempt to predict how bonded joints are likely to perform in a specific loading mode (shear, tensile, creep) in an assembly at specific temperature and moisture conditions for a specific time.

Most performance tests are short term. They are based on chemical, mechanical, and rheological laboratory tests of adhesive polymers, adhesives, and bonds. Intermediate-term tests of products that are conducted in pilot operations and field experiments are integrated with short-term laboratory tests in an effort to extrapolate these data into long-term performance. Long-term tests of bonded assemblies under actual environmental exposures are conducted, but this information may not be available for 10 to 30 years. Therefore, short-term tests are extensively used to predict long-term performance. As we learn the relationships between chemical structure and mechanical performance, and as companies are under continued pressure to launch new products, the reliance on short-term testing is increasing.

Analytical, Chemical, and Mechanical Testing of Polymers

Although many methods of characterizing adhesives are available, this section only briefly mentions some of the most important and common methods.

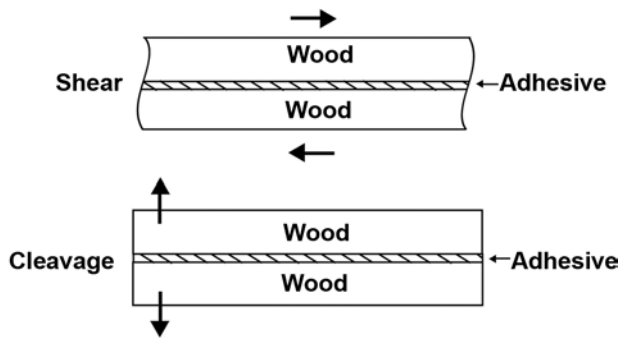

Figure 10–13. Failure modes of adhesive bonds.

Nuclear magnetic resonance (NMR) spectroscopy and other spectroscopic techniques help characterize the molecular structures of adhesive polymers. Molecular size distribution is commonly measured by gel permeation chromatography (GPC), also known as size exclusion chromatography (SEC). Differential scanning calorimetry (DSC) and gel times provide information on rates of chemical curing reactions. The rheological properties of curing and cured adhesives are characterized by dynamic mechanical analysis (DMA) and torsional-braid analysis (TBA). Sophisticated fracture mechanics techniques are used to measure toughness of adhesive bonds as they fail in a cleavage mode. High-magnification microscopes, including scanning electron microscope, transmission electron microscope, and atomic force microscope, enable scientists to see wood and adhesive surfaces in minute detail before, during, and after fracture. Fluorescent and confocal microscopes provide excellent information on adhesive distribution, adhesive penetration, and bond fracture surfaces because of their ability to distinguish between wood and adhesive.

Although much can be learned from measurements of chemical, mechanical, and rheological properties of polymers and adhesives before their application to wood, no correlation between laboratory test and product performance is perfect. There is no substitute for testing performance in bonded assemblies prepared with specific adhesives and materials and tested under specific loading modes, environmental conditions, and duration of loading. When adhesives are formulated through a blend of scientific analysis and art of formulation, they are tested for strength and durability in the laboratory and field, usually by industry-accepted standard test methods and product specifications.

Mechanical Testing of Bonded Assemblies

In an attempt to promote communication and understanding, there are many standardized test methods for evaluating and comparing the performance of different materials. Most test methods, specifications, and practices for adhesives and bonded assemblies are consensus standards. ASTM International publishes a book of standard methods each year (ASTM [Current edition]). Several trade associations have

their own specifications and performance standards that apply to their specific wood products. The Federal government also has specifications that are used by the General Services Administration to purchase products. In all test modes, specific materials, conditions of materials and testing, and testing procedures are completely specified to ensure repeatability and enable valid comparisons of data.

Two basic failure modes, shear and cleavage, are commonly used to test adhesive bonds to determine strength levels during impact, flexure, fatigue, and creep under long-term stress (Fig. 10–13). The following describes the basic stress modes in adhesive-bonded joints:

- Shear, resulting from forces applied parallel to the bondline, either in compression or tension
- Cleavage, resulting from forces applied perpendicular to the bondline. These forces may be applied by a wedge or other crack-opening device, by pulling on a double cantilever beam, or by pulling two faces apart, such as in a section of particleboard. Tensile loads often result in cleavage failures.

As the names imply, impact, fatigue, and creep are tests that pertain to the rate at which loads are applied. Standard testing is done so that load continues to increase until failure, typically occurring between 1 and 5 min. Impact loads are sudden; for example, hitting a specimen with a swinging arm. Fatigue is the loss in strength from repeated loading and unloading to reflect bond deterioration from mechanical stresses. Sometimes, environmental stresses such as moisture and temperature are added as well. Creep loads are static loads applied for long times, from a few days to years, usually under extreme environmental conditions.

The common measures used to estimate potential performance of bonded wood joints are strength, wood failure, and delamination. The highest performance level after exposure to severe environmental conditions is bond strength greater than wood strength, wood failure in more than 85% of the bonded area, and less than 5% or 8% delamination of the joint, for softwoods and hardwoods, respectively. These performance values reflect how wood, adhesive, and environmental exposure interact in response to loading.

Exceeding the strength of wood is an essential performance criterion, often more important than measured shear strength. Percentage wood failure is the amount of wood that fails as a percentage of the area of the bonded joint. In general, strong and durable bonds give high wood failure and fracture deep into the grain of the wood. If wood failure is shallow with only wood fibers remaining attached to the adhesive film, bond strength and probably durability are lacking. Thus, a consistently high level of wood failure, above 75% in some standards and above 85% in others, means that the shear strength associated with these bonds is a good estimate of the load-carrying capability of the joint.

High levels of wood failure in a wet and hot environment suggest that the adhesive bond is as strong as the wood. If cycles of alternate wetting and drying were included with cycles of wet and hot conditions, then high wood failure would indicate even more durable bonds. High wood failure in shear tests of water-saturated bonds is also a strong indicator of bond durability. Wood failure is considered a valid measure of bond strength only to solid wood, not to reconstituted products made of bonded wood particles.

High shear strength and high wood failure are not sufficient indicators of bond durability. Delamination is an indicator of how well the bonded joint withstands severe swelling and shrinking stresses in the presence of high moisture and heat. Delamination is the separation between laminates because of adhesive failure, either in the adhesive or at the interface between adhesive and wood. If adhesives are able to resist delaminating forces, any wood failure will occur adjacent to the bondline, but not within the adhesive. Delamination of adhesives in structural laminated wood products exposed to the cyclic delamination test in ASTM D 2559 cannot exceed 5% in softwoods and 8% in hardwoods.

Bonds in structural assemblies are expected to exceed the strength of the wood, so in traditional design of joints, adhesive strength has been ignored. Traditionally, adhesives that are not as strong as the wood simply have not been used in structural applications because methods for determining allowable mechanical properties of adhesives for engineering design had not been developed. One such method now exists—ASTM D 5574.

Short- and Long-Term Performance

In the short term, mechanical properties of wood, adhesives, and bonded products vary with specific environmental exposure. In most cases, all properties decrease as temperature and moisture levels increase. Strength and stiffness may return to their original levels if the yield points of the materials are not exceeded while under load. Wood properties degrade faster under heat and moisture than do rigid thermosetting adhesives like resorcinol-, phenol-, and melamine-formaldehyde, but this is not true for urea-formaldehyde. Therefore, evaluating short-term performance of products made with these adhesives is simply a matter of testing bonds at room temperature in dry and wet conditions. With increased moisture and/or heat, thermoplastic adhesives such as poly(vinyl acetate), elastomers, hot-melts, pressure-sensitive adhesives, soy and casein tend to lose stiffness and strength more rapidly than does wood. These adhesives must be tested dry, dry after water soaking, and after prolonged exposure to high humidity environments. In addition, some specifications require testing bonded structural and nonstructural products at elevated temperatures similar to what might be encountered in roofs or enclosed shipping containers. A short-term dead-load test at elevated temperatures may also be required. Adhesive specifications for structural products such as laminated beams and

plywood require high minimum strength and wood failure values after several different water exposure tests. Adhesive bonds in laminated beams must show very little delamination after exposure to severe cyclic moisture content and temperature changes.

Long-term deterioration of wood, adhesives, and bonded products is determined by the levels of temperature, moisture, and stress, and, in some instances, by concentrations of chemicals and presence of microorganisms. Long-term performance is the ability of a product to resist loss of a measured mechanical property over the time of exposure. A durable bonded product is one that shows no greater loss of properties during its life in service than does solid wood of the same species and quality.

Many adhesives in bonded products have decades of documented performance in many environments. Thus, it is possible to predict with a high degree of certainty the long-term performance of similar products. Well-designed and well-made joints with any of the commonly used wood-working adhesives will retain their strength indefinitely if the moisture content of the wood does not exceed approximately 15% and if the temperature remains within the range of human comfort. However, some adhesives deteriorate when exposed either intermittently or continuously to temperatures greater than 38 °C (100 °F) for long periods. Low temperatures seem to have no significant effect on strength of bonded joints.

Products made with phenol-formaldehyde, resorcinol-formaldehyde, and phenol-resorcinol-formaldehyde adhesives have proven to be more durable than wood when exposed to warm and humid environments, water, alternate wetting and drying, and even temperatures high enough to char wood. These adhesives are adequate for use in products that are exposed to the weather indefinitely (Fig. 10–14).

Well-made products with melamine-, melamine-urea-, and urea-formaldehyde resin adhesives have proven to be less durable than wood. Melamine-formaldehyde is only slightly less durable than phenol-formaldehyde or resorcinol-formaldehyde and is considered acceptable for structural products. Although considered less durable, melamine-urea-formaldehyde is also accepted in structural products at a melamine:urea ratio of 60:40. Urea-formaldehyde resin is susceptible to deterioration by heat and moisture (Fig. 10–14).

Products bonded with poly(vinyl acetate) and protein-based adhesives will not withstand prolonged exposure to water or repeated high–low moisture content cycling in bonds of high-density woods. However, if properly formulated, these adhesives are durable in a normal interior environment. The use of poly(vinyl acetate) adhesives is prohibited for some structural applications.

Some isocyanate, epoxy, polyurethane, emulsion polymer isocyanates, and cross-linked poly(vinyl acetate) adhesives

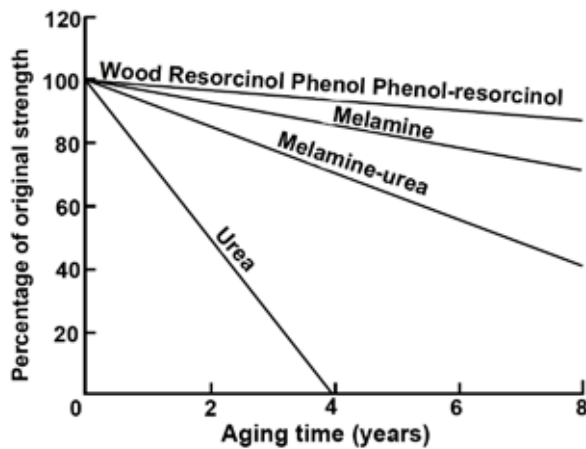

Figure 10–14. Relative rates of deterioration of bond strength of small specimens exposed directly to weather.

are durable enough to use on lower density species even under exterior conditions, but for most of these adhesives, exterior exposure must be limited. Some elastomer-based adhesives may be durable enough for limited exposure to moisture with lower density species in nonstructural applications or in structural applications when used in conjunction with approved nailing schedules. Polyurethane adhesives that chemically cure and remain flexible are among the most durable construction adhesives.

New adhesives do not have a history of long-term performance in service environments, so accelerated laboratory exposures that include cycles of heat, moisture, and stress are used to estimate long-term performance. However, laboratory exposures cannot duplicate the actual conditions of a service environment. Estimates of long-term performance can be obtained by exposing specimens outdoors for up to 30 years. Outdoor exposures may be intensified by facing specimens south at an angle perpendicular to the noonday sun and by establishing exposure sites in regions with the most extreme service environments, for example, southern coastal and arid southwestern regions. Only four long-term laboratory aging methods have been standardized, and none specifies minimum performance levels because the bonded product is the item that must meet code standards. Therefore, performance of any new adhesive or bonded product must be compared with performance of established adhesives or products tested in the same laboratory exposure.

Product Quality Assurance

After the short- and long-term performance of a product has been established, maintenance of the manufacturing process to ensure that the product will be made and perform at that level is the major concern of a quality-assurance program, which consists of three parts:

1. Establishing limits on bonding process factors that will ensure acceptable joints and product

2. Monitoring production processes and bond quality in joints and product
3. Detecting unacceptable joints and product, determining the cause, and correcting the problem

The structural panel, laminated-beam, particleboard, mill-work, and other industrial trade associations have established quality-assurance programs that effectively monitor the joint and product performance at the time of manufacture for compliance with voluntary product standards. Product performance is usually evaluated immediately after manufacture by subjecting specimens from the product to a series of swell–shrink cycles. The treatments are more rigorous for products intended for exterior exposure. For example, exterior softwood plywood is subjected to two boil–dry cycles, while interior plywood is subjected to a single soak–dry cycle at room temperature. After exposure, specimens are evaluated for delamination, percentage wood failure, or both. Test results are compared with the minimum requirement in the trade association’s standards. Lengthy experience and correlations between exterior performance and accelerated laboratory tests have shown that products with at least the minimum values will probably perform satisfactorily in service. If the product meets the requirement, it is certified by the association as meeting the standard for satisfactory performance.

Standards

AITC. [Current edition]. Inspection manual for structural glued laminated timber, AITC 200. Englewood, CO: American Institute of Timber Construction.

ANSI/AITC. [Current edition]. American national standard for wood products—structural glued laminated timber, ANSI/AITC A190.1. Englewood, CO: American Institute of Timber Construction.

APA. [Current edition]. Performance standards and policies for structural-use panels, APA PRP–108. Tacoma, WA: APA–The Engineered Wood Association.

APA. [Current edition]. U.S. product standard PS1-07 for construction and industrial plywood with typical APA trademarks. Tacoma, WA: APA–The Engineered Wood Association.

ASTM. [Current edition]. Annual book of ASTM standards, Vol. 15.06 Adhesives. West Conshohocken, PA: American Society for Testing and Materials. *Many of the standards are related to wood bonding for specific types of applications.*

CPA. [Current edition.] Particleboard, ANSI A208.1. Leesburg, VA: Composite Panel Association.

CPA. [Current edition]. Medium density fiberboard. ANSI A208.2. Leesburg, VA: Composite Panel Association.

Hardwood Plywood & Veneer Association. [Current edition]. American national standard for hardwood and decorative plywood, ANSI/HPVA HP-1. Reston, VA.

References

- Blomquist, R.F.; Christiansen, A.W.; Gillespie, R.H.; Myers, G.E., eds. 1984. Adhesive bonding of wood and other structural materials. Clark C. Heritage memorial series on wood, Vol. 3. Educational modules for material science and engineering (EMMSE). University Park, PA: Pennsylvania State University. 436 p.
- Blomquist, R.F.; Vick, C.B. 1977. Adhesives for building construction. In: Skeist, I., ed. Handbook of adhesives, 2nd ed. New York, NY: Van Nostrand Reinhold Company.
- Bryant, B.S. 1977. Wood adhesion. In: Skeist, I., ed. Handbook of adhesives, 2nd ed. New York, NY: Van Nostrand Reinhold Company. 25 p.
- Caster, R.W. 1980. Correlation between exterior exposure and automatic boil test results. In: John, W.E.; Gillespie, R.H., eds. Proceedings of a symposium, Wood adhesives—research, application, needs; 1980 September 23–25; Madison, WI: U.S. Department of Agriculture, Forest Service, Forest Products Laboratory.
- Christiansen, A.W. 1990. How overdrying wood reduces its bonding to phenol-formaldehyde adhesives: a critical review of the literature. Part I. Physical responses. Wood Fiber Science. 22(4): 441–459.
- Christiansen, A.W. 1991. How overdrying wood reduces its bonding to phenol-formaldehyde adhesives: a critical review of the literature. Part II. Chemical reactions. Wood Fiber Science. 23(1): 69–84.
- Collett, B.M. 1972. A review of surface and interfacial adhesion in wood science and related fields. Wood Science Technology. 6(1): 1–42.
- Dunky, M. 2003. Adhesives in the wood industry. In: Pizzi, A.; Mittal, K.L., eds. Handbook of adhesive technology, 2nd ed. 887–956.
- Dunky, M.; Pizzi, A. 2003. Wood adhesives. In: Dillard, D.A.; Pocius, A.V., eds. Adhesion science and engineering, Vol. 2: Issue surfaces, chemistry and applications. 1039–1103.
- Frihart, C.R. 2005. Wood adhesion and adhesives. In: Rowell, R.M., ed. Handbook of wood chemistry and wood composites. Boca Raton, FL: Taylor & Francis. 215–278.
- Gillespie, R.H. 1965. Accelerated aging of adhesives in plywood-type joints. Forest Products Journal. 15(9): 369–378.
- Gillespie, R.H. 1981. Wood composites. In: Oliver, J.F., ed. Adhesion in cellulose and wood-based composites. New York: Plenum Press. 167–189.
- Gillespie, R.H.; River, B.H. 1975. Durability of adhesives in plywood: dry-heat effects by rate-process analysis. Forest Products Journal. 25(7): 26–32.
- Gillespie, R.H.; River, B.H. 1976. Durability of adhesives in plywood. Forest Products Journal. 26(10): 21–25.
- Gillespie, R.H.; Countryman, D.; Blomquist, R.F. 1978. Adhesives in building construction. Agric. Handb. 516. Washington, DC: U.S. Department of Agriculture, Forest Service. 165 p.
- Hoyle, R.J. 1976. Designing wood structures bonded with elastomeric adhesives. Forest Products Journal. 26(3): 28–34.
- Jarvi, R.A. 1967. Exterior glues for plywood. Forest Products Journal. 17(1): 37–42.
- Jokerst, R.W. 1981. Finger-jointed wood products. Res. Pap. FPL–RP–382. Madison, WI: U.S. Department of Agriculture, Forest Service, Forest Products Laboratory. 24 p.
- Lambuth, A.L. 1977. Bonding tropical hardwoods with phenolic adhesives. In: Proceedings, IUFRO meeting on processing of tropical hardwoods. 1977 October 2–9; Merida, Venezuela: Laboratorio Nacional de Productos Forestales.
- Marra, A.A. 1980. Applications of wood bonding. In: R.F. Bloomquist, A.W. Christiansen, R.H. Gillespie, and G.E. Myers, eds. Adhesive bonding of wood and other structural materials, Chapter IX. EMMSE Project, Pennsylvania State University, University Park, PA. 365–418.
- Marra, A.A. 1992. Technology of wood bonding—principles in practice. New York, NY: Van Nostrand Reinhold. 454 p.
- McGee, W.D.; Hoyle, R.J. 1974. Design method for elastomeric adhesive bonded wood joist-deck systems. Wood Fiber Science. 6(2): 144–155.
- Miller, R.S. 1990. Adhesives for building construction. In: Skeist, I., ed. Handbook of adhesives, 3rd ed. New York, NY: Van Nostrand Reinhold Company.
- Murmanis, L.; River, B.H.; Stewart, H.A. 1986. Surface and subsurface characteristics related to abrasive-planing conditions. Wood Fiber Science. 18(1): 107–117.
- Pizzi, A., ed. 1983. Wood adhesives chemistry and technology. New York, NY: Marcel Dekker, Inc. 364 p. Vol. 1.
- Pizzi, A., ed. 1989. Wood adhesives chemistry and technology. New York, NY: Marcel Dekker, Inc. 416 p. Vol. 2.
- Pizzi, A. 1994. Advanced wood adhesives technology. New York, NY: Marcel Dekker, Inc. 304 p.
- Pizzi, A.; Mittal, K.L. 2003. Handbook of adhesive technology. 2nd ed. New York, NY: Marcel Dekker, Inc. 672 p.
- River, B.H. 1973. Mastic construction adhesives in fire exposure. Res. Pap. FPL–RP–198. Madison, WI: U.S.

- Department of Agriculture, Forest Service, Forest Products Laboratory. 16 p.
- River, B.H. 1981. Behavior of construction adhesives under long-term load. Res. Pap. FPL–RP–400. Madison, WI: U.S. Department of Agriculture, Forest Service, Forest Products Laboratory. 16 p.
- River, B.H. 1984. Accelerated, real-time aging for 4 construction adhesives. *Adhesives Age*. (2): 16–21.
- River, B.H. 1994. Fracture of adhesive-bonded wood joints. In: Pizzi, A; Mittal, K.L., eds. *Handbook of adhesive technology*. New York, NY: Marcel Dekker, Inc. 27 p. Chapter 9.
- River, B.H.; Okkonen, E.A. 1991. Delamination of edge-glued wood panels—moisture effects. Res. Note FPL–RN–0259. Madison, WI: U.S. Department of Agriculture, Forest Service, Forest Products Laboratory. 11 p.
- River, B.H.; Gillespie, R.H.; Vick, C.B. 1991. Wood as an adherend. In: Minford, J.D., ed. *Treatise on adhesion and adhesives*. New York, NY: Marcel Dekker, Inc. 230 p. Vol. 7.
- Selbo, M.L. 1975. Adhesive bonding of wood. Tech. Bull. 1512. Washington, DC: U.S. Department of Agriculture, Forest Service. 129 p.
- Sellers, T., Jr. 1985. *Plywood and adhesive technology*. New York, NY: Marcel Dekker, Inc. 661 p.
- Skeist, I., ed. 1977. *Handbook of adhesives*. 2nd ed. New York, NY: Van Nostrand Reinhold. 921 p.
- Skeist, I., ed. 1990. *Handbook of adhesives*. 3rd ed. New York, NY: Van Nostrand Reinhold. 779 p.
- Vick, C.B. 1971. Elastomeric adhesives for field-gluing plywood floors. *Forest Products Journal*. 21(8): 34–42.
- Vick, C.B. 1994. Phenolic adhesive bonds to aspen veneers treated with amino-resin fire retardants. *Forest Products Journal*. 44(1): 33–40.
- Vick, C.B. 1995. Coupling agent improves durability of PRF bonds to CCA-treated Southern Pine. *Forest Products Journal*. 45(3): 78–84.
- Vick, C.B. 1996. Hydroxymethylated resorcinol coupling agent for enhanced adhesion of epoxy and other thermosetting adhesives to wood. In: Christiansen, A.W.; Conner, A.H., eds. *Wood adhesives 1995. Proceedings of a symposium; 1995 June 29–30; Portland, OR*. Proc. 7296. Madison, WI: Forest Products Society.
- Vick, C.B.; Rowell, R.M. 1990. Adhesive bonding of acetylated wood. *International Journal of Adhesion and Adhesives*. 10(4): 263–272.
- Vick, C.B.; DeGroot, R.C.; Youngquist, J. 1990. Compatibility of nonacidic waterborne preservatives with phenol-formaldehyde adhesive. *Forest Products Journal*. 40(2): 16–22.

Wood-Based Composite Materials

Panel Products, Glued-Laminated Timber, Structural Composite Lumber, and Wood–Nonwood Composite Materials

Nicole M. Stark, Research Chemical Engineer

Zhiyong Cai, Supervisory Research Materials Engineer

Charles Carll, Research Forest Products Technologist

Contents

Scope	11–2
Conventional Wood-Based Composite Panels	11–2
Elements	11–2
Adhesives	11–3
Additives	11–5
Plywood	11–5
Oriented Strandboard	11–7
Particleboard	11–10
Fiberboard	11–12
Speciality Composite Materials	11–15
Performance and Standards	11–15
Glulam Timber	11–17
Advantages	11–17
Types of Glulam Combinations	11–17
Standards and Specifications	11–18
Manufacture	11–19
Structural Composite Lumber	11–20
Laminated Veneer Lumber	11–21
Parallel Strand Lumber	11–21
Laminated Strand Lumber and Oriented Strand Lumber	11–21
Advantages and Uses	11–21
Standards and Specifications	11–22
Wood–Nonwood Composite Materials	11–22
Inorganic-Bonded Composite Materials	11–23
Wood–Thermoplastic Composite Materials	11–25
Literature Cited	11–26

The term composite is being used in this chapter to describe any wood material adhesively bonded together. Wood-based composites encompass a range of products, from fiberboard to laminated beams. Wood-based composites are used for a number of nonstructural and structural applications in product lines ranging from panels for interior covering purposes to panels for exterior uses and in furniture and support structures in buildings (Fig. 11–1). Maloney (1986) proposed a classification system to logically categorize the array of wood-based composites. The classification in Table 11-1 reflects the latest product developments.

The basic element for wood-based composites is the fiber, with larger particles composed of many fibers. Elements used in the production of wood-based composites can be made in a variety of sizes and shapes. Typical elements include fibers, particles, flakes, veneers, laminates, or lumber. Figure 11–2 shows the variation and relative size of wood elements. Element size and geometry largely dictate the product manufactured and product performance. Performance standards are in place for many conventional wood-based composite products (Table 11–2).

A variety of wood sources are appropriate for use in wood-based composites. Wood with localized defects (such as knots) can often be used effectively in wood-based composites. Reducing wood with defects to wood elements mitigates the influence of these characteristics in the manufactured products. Recovered wood from construction waste or industrial manufacturing processes, and wood derived from small-diameter timber, forest residues, or exotic and invasive species, may also be effectively used in wood-based composites. Because natural wood properties vary among species, between trees of the same species, and between pieces from the same tree, solid wood cannot match composite products in the uniformity and range of properties that can be controlled.

Table 11–1. Classification of wood-based composites^a**Veneer-based material**

Plywood
Laminated veneer lumber (LVL)
Parallel-strand lumber (PSL)

Laminates

Glue-laminated timbers
Overlaid materials
Laminated wood–nonwood composites^b
Multiwood composites (COM-PLY^c)

Composite material

Fiberboard (low-, medium-, or high-density)
Cellulosic fiberboard
Hardboard
Particleboard
Waferboard
Flakeboard
Oriented strandboard (OSB)
Laminated strand lumber (LSL)
Oriented strand lumber (OSL)

Wood–nonwood composites

Wood fiber–polymer composites
Inorganic-bonded composites

^aAdapted from Maloney (1986).

^bPanels or shaped materials combined with nonwood materials such as metal, plastic, and fiberglass.

^cRegistered trademark of APA–The Engineered Wood Association.

Scope

This chapter gives an overview of the general types and composition of wood-based composite products and the materials and processes used to manufacture them. It describes conventional wood-based composite panels and structural composite materials intended for general construction, interior use, or both. This chapter also describes wood–nonwood composites. Mechanical properties of these types of composites are presented and discussed in Chapter 12. Because wood-based composites come in a variety of forms, we briefly describe several of the most common commercial products.

This chapter is organized into three sections. The first section covers conventional wood-based composite panels. Materials, adhesives, and additives common to conventional wood-based composites are summarized. Specific products addressed include panel products such as plywood, oriented strandboard, particleboard, and fiberboard. Specialty composites are also discussed. The second section covers structural composite lumber, including glued-laminated timber, laminated veneer lumber, parallel strand lumber, laminated strand lumber, and oriented strand lumber. Wood–nonwood composites are discussed in the third section, including inorganic-bonded composites and wood–thermo-plastic composites. Books have been written about each of



Figure 11–1. Wood-based composites used in the new Centennial Research Facility at the Forest Products Laboratory. Glulam timbers support composite I-joists and plywood sheathing. (Photo by Steve Schmieding, Forest Products Laboratory.)

these categories, and the constraints of this chapter necessitate that the discussion be general and brief. References are provided for more detailed information.

Conventional Wood-Based Composite Panels

Conventional wood-based composites are manufactured products made primarily from wood with only a few percent resin and other additives. A useful way to classify conventional wood-based composites based on specific gravity, density, raw material, and processing methods is shown in Figure 11–3, which presents an overview of the most common types of commercial panel products discussed in this chapter and a quick reference to how these composite materials compare with solid wood from the standpoint of density and general processing considerations. The raw material classifications of fibers, particles, and veneers are shown on the left y-axis. Specific gravity and density are shown on the top and bottom horizontal axes (x-axes), respectively. The right y-axis, wet and dry processes, describes in general terms the processing method used to produce a particular product. Selection of wood elements, adhesives, and processing techniques all contribute to product performance. Figure 11–4 shows examples of some commercial wood-based composites.

Elements

The primary component of wood-based composites is the wood element, often 94% or more by mass. Common elements for conventional wood-based composites include veneers, strands, particles, and fibers. The physical characteristics of common elements can be seen in Figure 11–5. Properties of composite materials can be changed by changing the size and geometry of the elements and by combining, reorganizing, or stratifying elements.

Table 11–2. Commercial product or performance standards for wood-based composites

Product category	Applicable standard	Name of standard	Source
Plywood	PS 1–07	Voluntary product standard PS 1–07 construction and industrial plywood	NIST 2007
	PS 2–04	Voluntary product standard PS 2–04 performance standard for wood-based structural-use panels	NIST 2004
	HP–1–2004	Voluntary product standard HP–1–2004 hardwood and decorative plywood	HPVA 2004
Oriented strandboard (OSB)	PS 2–04	Voluntary product standard PS 2–04 performance standard for wood-based structural-use panels	NIST 2004
Particleboard	ANSI A 208.1–2009	Particleboard standard	CPA 2009a
Fiberboard	ANSI A 208.2–2009	MDF standard	CPA 2009b
	ANSI A 135.4–2004	Basic hardboard	CPA 2004a
	ANSI A 135.5–2004	Pre-finished hardboard paneling	CPA 2004b
	ANSI A 135.6–2006	Hardboard siding	CPA 2006
	ASTM C 208–08a	Cellulosic fiberboard	ASTM 2008c
Glued-laminated timber (glulam)	ANSI/AITC 190.1	American National Standard for Wood Products—structural glued-laminated timber	AITC 2007a
Structural composite lumber (including laminated veneer lumber (LVL), laminated strand lumber (LSL), and parallel strand lumber (PSL))	ASTM D 5456–07	Standard specification for evaluation of structural composite lumber products	ASTM 2008b

Adhesives

Bonding in most conventional wood-based composites is provided by thermosetting (heat-curing) adhesive resins. Chapter 9 provides a more thorough discussion of thermoset adhesive resins. Commonly used resin–binder systems include phenol-formaldehyde, urea-formaldehyde, melamine-formaldehyde, and isocyanate.

Phenol-Formaldehyde

Phenol-formaldehyde (PF) resins are typically used in the manufacture of construction plywood and oriented strandboard where exposure to weather during construction is a concern. Other moisture exposure situations, such as temporary weather exposure, occasional plumbing leaks, or wet foot traffic, may also necessitate the use of PF resins. PF resins are commonly referred to as phenolic resins. Phenolic resins are relatively slow-curing compared with other thermosetting resins. In hot-pressed wood-based composites, use of phenolic resin necessitates longer press times and higher press temperatures. Hot-stacking of pressed material shortly after emergence from the press is a fairly common

industrial practice, used to attain adequate resin cure without greatly extending press time. Significant heat exposure associated with pressing of phenolic-bonded composites commonly results in a noticeable reduction in their hygroscopicity. Cured phenolic resins remain chemically stable at elevated temperatures. Their bonds also are sometimes referred to as being “boil-proof” because of their ability to maintain composite dimensional and mechanical properties under wet conditions. The inherently darker color of PF resin compared with other resins may make them aesthetically unsuitable for product applications such as interior paneling and furniture.

Urea-Formaldehyde

Urea-formaldehyde (UF) resins are typically used in the manufacture of products used in interior applications, primarily particleboard and medium-density fiberboard (MDF), because moisture exposure leads to a breakdown of the bond-forming reactions. Excessive heat exposure will also result in chemical breakdown of cured UF resins, therefore UF-bonded panels are typically cooled after emergence

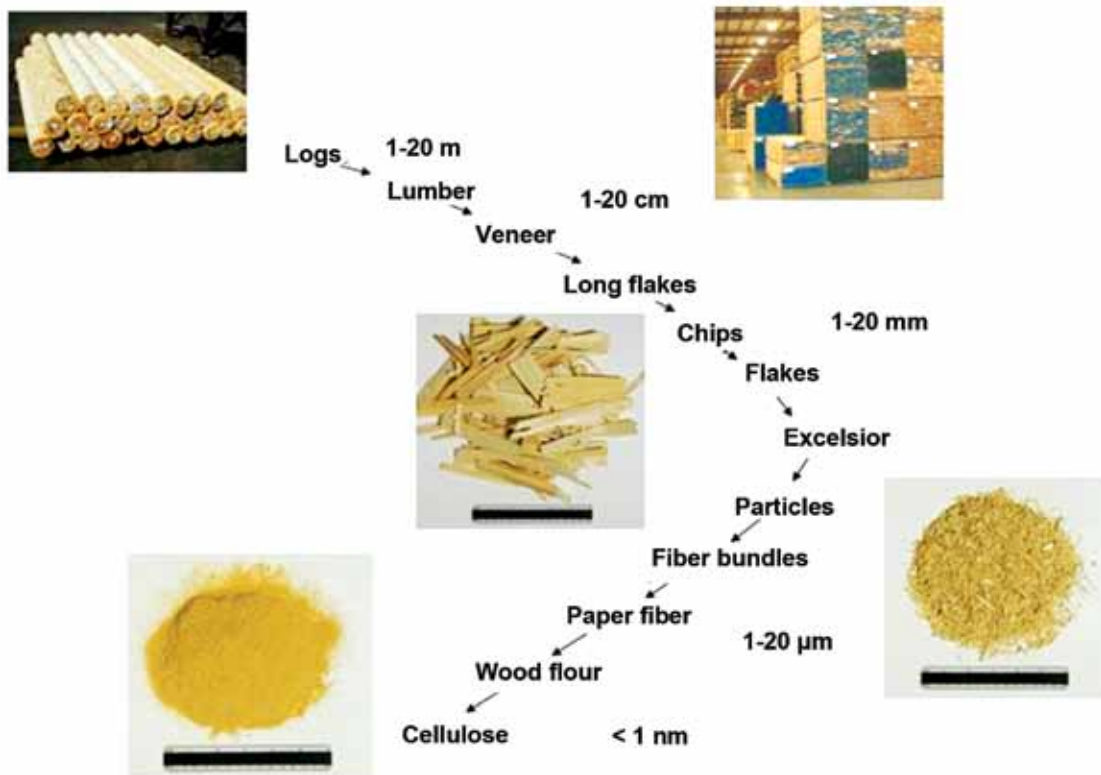

Figure 11–2. Basic wood elements, from largest to smallest (Kretschmann and others 2007).

from the press. Advantages of UF resins include lower curing temperatures than PF resins and ease of use under a variety of curing conditions. UF resins are the lowest cost thermosetting adhesive resins. They offer light color, which often is a requirement in the manufacture of decorative products. However, the release of formaldehyde from products bonded with UF is a growing health concern.

Melamine-Formaldehyde

Melamine-formaldehyde (MF) resins are used primarily for decorative laminates, paper treating, and paper coating. They are typically more expensive than PF resins. MF resins may, despite their high cost, be used in bonding conventional wood-based composites. MF resins are often used in combination with UF. MF–UF resins are used when an inconspicuous (light color) adhesive is needed and when greater water resistance than can be attained with UF resin is required.

Isocyanates

The isocyanate wood adhesive is a polymeric methylene diisocyanate (pMDI). It is used as an alternative to PF resin, primarily in composite products fabricated from strands. pMDI resins are typically more costly than PF resins but have more rapid cure rates and will tolerate higher moisture contents in the wood source. pMDI resin is sometimes used in core layers of strand-based composites, with slower-curing PF resin used in surface layers. Facilities that use

pMDI are required to take special precautionary protective measures because the uncured resin can result in chemical sensitization of persons exposed to it. Cured pMDI resin poses no recognized health concerns.

Bio-Based Adhesives

Bio-based adhesives, primarily protein glues, were widely used prior to the early 1970s in construction plywood. In the mid-1970s, they were supplanted by PF adhesives, on the basis of the superior bond durability provided by phenolics. The move toward “green” products has led to a renewed interest in bio-based adhesives. Several soy-protein-based resin systems, with bond durabilities similar to those provided by PF resins, have recently been developed and commercialized. Durable adhesive systems may also be derived from tannins or from lignin. Tannins are natural phenol compounds that are present in the bark of a number of tree species. The tannins can be extracted from bark, modified, and reacted with formaldehyde to produce an intermediate polymer that is a satisfactory thermosetting adhesive. Lignin-based resins have also been developed from spent pulping liquor, which is generated when wood is pulped for paper or chemical feedstocks. In the manufacture of wet-process fiberboard, lignin, which is an inherent component of lignocellulosic material, is frequently used as binder (Suchsland and Woodson 1986), although “natural” lignin bonding is sometimes augmented with small amounts of PF resin.

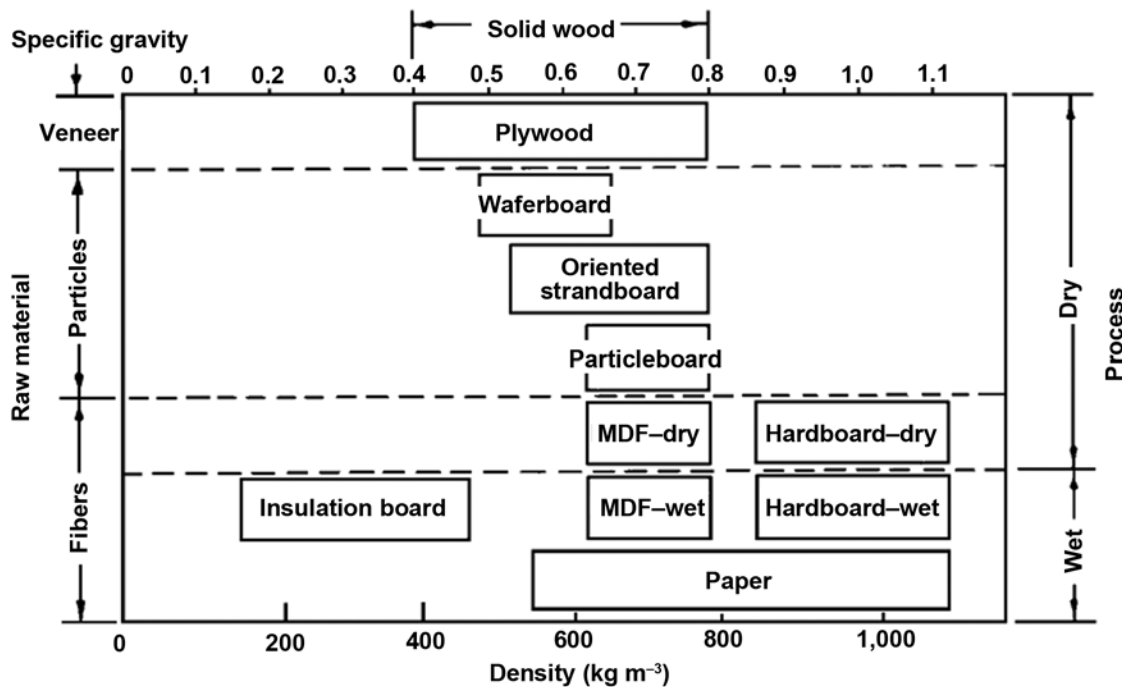

Figure 11-3. Classification of wood composite panels by particle size, density, and process (Suchsland and Woodson 1986). Note that insulation board is now known as cellulosic fiberboard.

Resin Choice

Often a particular resin will dominate for a particular product, but each has its advantages. Factors taken into account include materials to be bonded together, moisture content at time of bonding, mechanical property and durability requirements of the composite products, anticipated end-use of the product, and resin system costs.

PF, UF, and pMDI resins systems are expected to remain the dominant adhesives used for bonded wood-based composites. However, cost and reliable availability of petrochemicals may affect the relative predominance of PF, UF, and pMDI adhesives versus bio-based adhesives. More stringent regulation concerning emissions from formaldehyde-containing products (driven by concern over indoor air quality) may affect the continued commercial predominance of UF resin in interior products. For example, the California Air Resources Board (CARB) has established formaldehyde emission standards that cover hardwood plywood, particleboard, and MDF. As a result, bio-based adhesive and resin systems may gain market share compared with petroleum-based synthetic resins.

Additives

A number of additives are used in the production of conventional composite products. The most common additive is wax, which is used to provide products with some resistance to liquid water absorption. In flake-, particle-, and fiberboard products, wax emulsions provide limited-term

water resistance and dimensional stability when the board is wetted. Even small amounts (0.5% to 1%) act to retard the rate of liquid water pickup for limited time periods. These improved short-term water penetration properties are important for ensuring the success of subsequent secondary gluing operations and for providing protection upon accidental wetting of the product during and after construction. The addition of wax has practically no effect on water vapor sorption or dimensional changes associated with changes in humidity. Other additives used for specialty products include preservatives, moldicides, and fire retardants. Composites containing additives are more thoroughly discussed in the section on Specialty Composite Materials.

Plywood

Plywood is a panel product built up wholly or primarily of sheets of veneer called plies. It is constructed with an odd number of layers with the grain direction of adjacent layers oriented perpendicular to one another. A layer can consist of a single ply or of two or more plies laminated with their grain direction parallel. A panel can contain an odd or even number of plies but always an odd number of layers. The outside plies are called faces, or face and back plies. Inner plies are plies other than the face or back plies. The outer layers and all odd-numbered layers have their grain direction oriented parallel to the long dimension of the panel. The grain in even-numbered layers is perpendicular to the length of the panel. Inner plies whose grain direction runs parallel to that of the faces are termed "centers" whereas inner plies

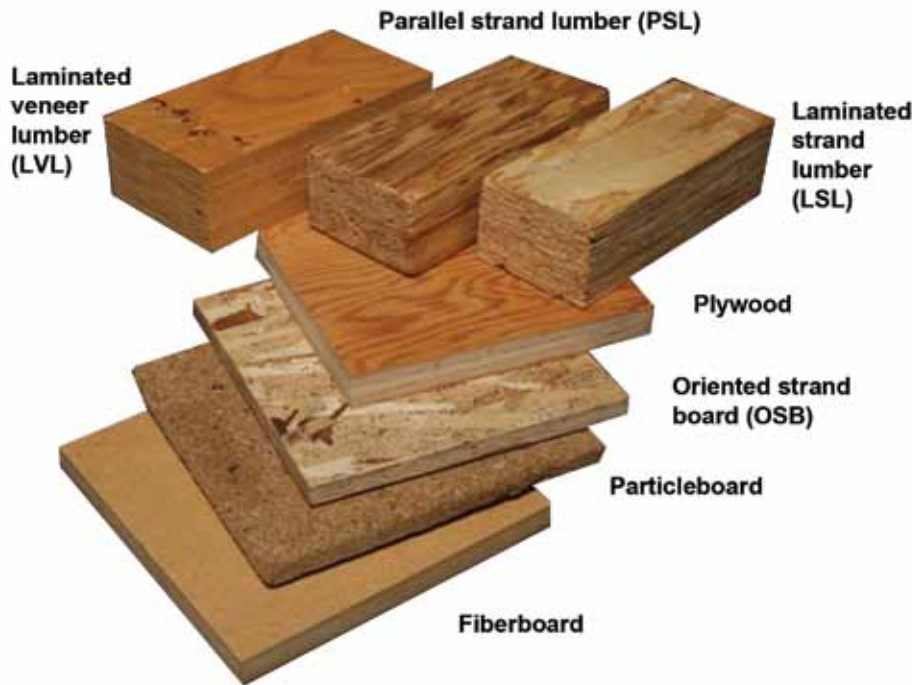

Figure 11–4. Examples of various composite products. From top left, clockwise: LVL, PSL, LSL, plywood, OSB, particleboard, and fiberboard.



Figure 11–5. Common wood elements used in wood-based composites from top left, clockwise: shavings, sawdust, fiber, large particles, wafers, and strands.

whose grain direction runs perpendicular to that of the faces are termed “crossbands.” To distinguish the number of plies (individual sheets of veneer in a panel) from the number of layers (number of times the grain orientation changes), panels are sometimes described as three-ply, three-layer or four-ply, three-layer, etc. The center layer may be veneer, lumber, particleboard, or fiberboard; however, all-veneer construction is most common in construction and industrial plywood.

Plywood panels are used in various applications, including construction sheathing, furniture, and cabinet panels.

Plywood is also used as a component in other engineered wood products and systems in applications such as prefabricated I-joists, box beams, stressed-skin panels, and panelized roofs.

Characteristics

The properties of plywood depend on the quality of the veneer plies, the order of layers, the adhesive used, and the degree to which bonding conditions are controlled during production. The durability of the adhesive-to-wood bond depends largely on the adhesive used but also on control of bonding conditions and on veneer quality. The grade of the panel depends upon the quality of the veneers used, particularly of the face and back.

Plywood panels have significant bending strength both along the panel and across the panel, and the differences in strength and stiffness along the panel length versus across the panel are much smaller than those differences in solid wood. Plywood also has excellent dimensional stability along its length and across its width. Minimal edge-swelling makes plywood a good choice for adhesive-bonded tongue-and-groove joints, even where some wetting is expected. Unlike most panels fabricated from particles, it undergoes minimal irreversible thickness swelling if wetted. The alternating grain direction of its layers makes plywood resistant to splitting, allowing fasteners to be placed very near the edges of a panel. In uses where internal knotholes and voids may pose a problem, such as in small pieces, plywood can be ordered with a solid core and face veneers.

Classes of Plywood

Two classes of plywood are commonly available, covered by separate standards: (a) construction and industrial plywood and (b) hardwood and decorative plywood.

Most construction and industrial plywood used in the United States is produced domestically, and U.S. manufacturers export some material. The bulk of construction and industrial plywood is used where performance is more important than appearance. However, some grades of construction and industrial plywood are made with faces selected primarily for appearance and are used either with clear natural finishes or lightly pigmented finishes. Construction and industrial plywood has traditionally been made from softwoods such as Douglas-fir and southern yellow pine. However, true firs, western hemlock, and western pines are also used (Bowyer and others 2007). A large number of hardwoods qualify for use under the standard. PF resin is the primary adhesive type used in construction and industrial plywood. Construction and industrial plywood is categorized by exposure capability and grade using Voluntary Product Standard PS 1-07 (NIST 2007).

Hardwood and decorative plywood is made of many different species, both in the United States and overseas. Well over half of all panels used in the United States are imported. Hardwood plywood is normally used in applications including decorative wall panels and furniture and cabinet panels where appearance is more important than strength. Most of the production is intended for interior or protected uses, although a very small proportion is made with adhesives suitable for exterior service, such as in marine applications. A substantial portion of all hardwood plywood is available completely finished. Hardwood and decorative plywood is categorized by species and characteristics of face veneer, bond durability, and composition of center layers (veneer, lumber, particleboard, MDF, or hardboard) (HP-1-2004, HPVA 2004).

Exposure Capability

Construction and industrial plywood is classified as either Exposure 1 or Exterior in Voluntary Product Standard PS 1-07 (NIST 2007). Exposure 1 plywood is intended for applications not permanently exposed to weather, whereas Exterior plywood is suitable for repeated wetting and drying, or long-term exposure to weather. Bond quality of plywood of either bond classification (Exposure 1 or Exterior) is evaluated by the same test procedure, but a higher level of performance in the test procedure is required for Exterior plywood. The test procedure involves water saturation, boiling, and high-temperature exposure (in excess of boiling temperature). The majority of construction and industrial plywood sold in North America is of Exposure 1 classification. Exposure 1 panels may undergo rain-wetting during building construction but will be protected from wetting after the building is enclosed.

Two exposure classes of hardwood and decorative plywood are recognized by ANSI/HPVA HP-1-2004, Exterior and Interior. The standard actually lists two different Exterior classes, Technical and Type I, but the bond performance requirements for these classes, as determined by test procedures outlined in the standard, are the same.

Plywood Grades

Plywood grades may indicate the intended use, a type of surface treatment, or the grades of the face and back veneers, and in some cases, a combination of these. Agencies that provide quality certification services for plywood mills have coined their own trademarked grade names for specified end uses through proprietary product standards. Grade stamps are used to identify plywood products (Figs. 11-6 and 11-7). An example of plywood CARB third-party identification is also shown in Figure 11-7.

Veneer quality is a factor in construction and industrial plywood based on visually observable characteristics. Knots, decay, splits, insect holes, surface roughness, number of surface repairs, and other defects are considered. Veneer species and characteristics are also a major factor in categorization of hardwood and decorative plywood.

Specialty Plywood Panels

Plywood is easily pressure-treated with waterborne preservatives and fire retardants. Because plywood is not prone to irreversible thickness swelling, its bond integrity is unaffected by pressure treatment with waterborne chemicals. Treatment is typically performed by commercial entities specializing in treatment rather than by the plywood manufacturer. Treatments for plywood have been standardized (AWPA 2007a,b). This allows specification by reference to a commercial standard. Special grades of plywood are produced for specific uses such as boat construction, concrete form work, or special exterior applications such as highway signage.

Oriented Strandboard

Oriented strandboard (OSB) is an engineered structural-use panel manufactured from thin wood strands bonded together with water-resistant resin, typically PF or pMDI. It is used extensively for roof, wall, and floor sheathing in residential and commercial construction. The wood strands typically have an aspect ratio (strand length divided by width) of at least 3. OSB panels are usually made up of three layers of strands, the outer faces having longer strands aligned in the long-direction of the panel and a core layer that is counter-aligned or laid randomly using the smaller strands or fines. The orientation of different layers of aligned strands gives OSB its unique characteristics, including greater bending strength and stiffness in the oriented or aligned direction. Control of strand size, orientation, and layered construction allows OSB to be engineered to suit different uses.

OSB technology and the raw material used originally evolved from waferboard technology, for which aspen was

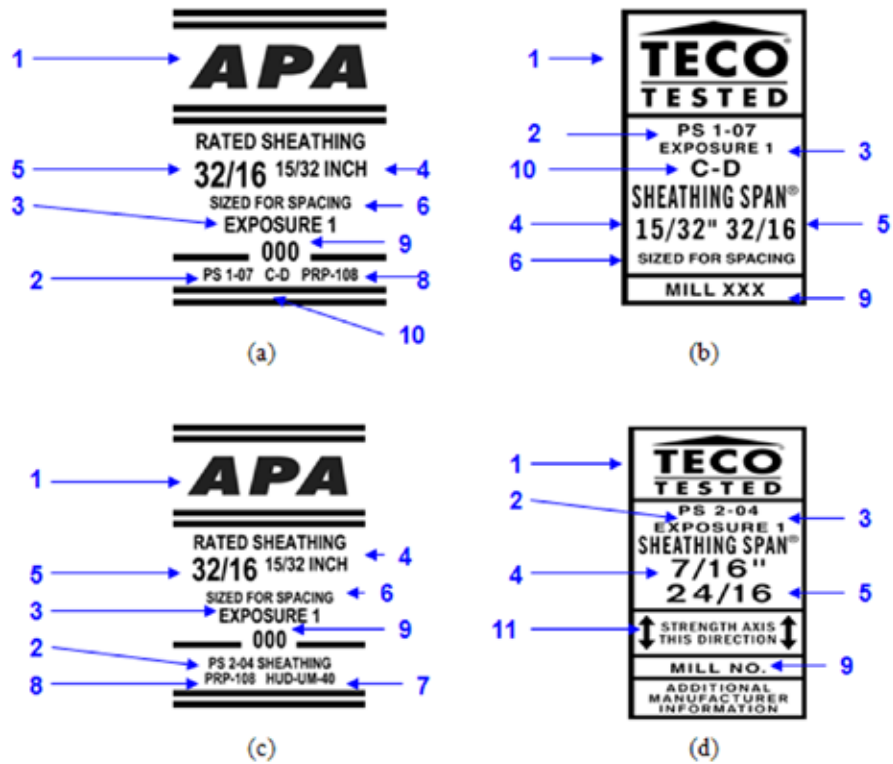

- 1) Third-party inspection agency
- 2) Conformance to indicated product standard
- 3) Exposure durability classification
- 4) Thickness
- 5) Span rating
- 6) Denotes panels that have been sized to allow for spacing of panel edges during installation to reduce the possibility of buckling
- 7) Recognition as a quality assurance agency
- 8) Performance rated panel standard indicating structural-use panel test procedures
- 9) Manufacturing mill identification number
- 10) Grade of face and core veneers
- 11) Strength axis (OSB only)

Figure 11–6. Typical grade stamps for plywood and OSB. (Courtesy of TECO, Sun Prairie, Wisconsin, and APA–The Engineered Wood Association, Tacoma, Washington. Used by permission.)

the predominant wood species used. As the industry learned to control strand size, placement, and orientation, the performance and utility of OSB products improved to the point that their performance was similar to that of structural plywood. As a result, product acceptance and the industry expanded as OSB began to replace softwood plywood in construction applications.

Raw Materials

In North America, aspen is the predominant wood used for OSB. Species other than aspen, such as Southern Pine, spruce, birch, yellow-poplar, sweetgum, sassafras, and beech, are also suitable raw materials for OSB production. High-density species such as beech and birch are often mixed with low-density species such as aspen to maintain panel properties (Bowyer and others 2007).

Manufacturing Process

To manufacture OSB, debarked logs are sliced into long, thin wood elements called strands. The strands are dried, blended with resin and wax, and formed into thick, loosely consolidated mats that are pressed under heat and pressure into large panels. Figure 11–8 shows an OSB manufacturing process. A more detailed description of each individual manufacturing step follows.

During stranding, logs are debarked and then sent to a soaking pond or directly to the stranding process. Long log disk or ring stranders are commonly used to produce wood strands typically measuring 114 to 152 mm (4.5 to 6 in.) long, 12.7 mm (0.5 in.) wide, and 0.6 to 0.7 mm (0.023 to 0.027 in.) thick. Green strands are stored in wet bins and dried in a traditional triple-pass dryer, a single-pass dryer, a

<p>FORMALDEHYDE EMISSION 0.05 PPM MEETS CARB ATCM PHASE 2 REQUIREMENTS</p> <p>2 →</p> <p>LAY UP 16 3.6 MM THICK HP-SG-96</p> <p>3 ↗</p>	<p>SIMULATED ← 4 DECORATIVE FINISH ON PLYWOOD</p> <p>1 ↙</p>  <p>5 → MILL 000 SPECIALTY GRADE ← 6</p>	<p>FLAME SPREAD CLASS C 200 OR LESS ASTM E84 ← 7</p> <p>BOND LINE TYPE II ← 8 ANSI/HPVA HP-1-2004 ← 9</p>
---	--	---

DESIGNATION KEY

1. **HPVA Laboratory Registered Trademark** - Hardwood Plywood & Veneer Association; CARB TPC-8.
2. **Formaldehyde Emissions Classification** - in accordance with *ASTM E1333 Standard Test Method for Determining Formaldehyde Concentrations in Air and Emissions Rates from Wood Products Using a Large Chamber*. Demonstrates compliance below California Air Resource Board (CARB), U.S. Department of Housing and Urban Development (HUD), and other approved regulations and standards on air emissions
3. **Structural Layup Description** – meets structural panel attributes as outlined in HPVA design guide *HP-SG-96, Structural Design Guide for Hardwood Plywood Wall Panels*
4. **Face Species or Finish Type** (not required for specialty or simulated finishes)
5. **HPVA Mill Number**
6. **Face/Back Veneer Grade** (grade of back follows face for industrial panels and is optional for specialty grade panels)
7. **Flame Spread Index Classification** - in accordance with *ASTM E84 Standard Test Method for Surface Burning Characteristics of Building Materials*
8. **Plywood Bond Line Type** – Type I (interior), Type II (exterior)
9. **ANSI/HPVA HP-1-2004** - Standard Governing Manufacture

SAMPLE HPVA TPC-8 CARB Certification Label:

<p>HARDWOOD PLYWOOD & VENEER ASSOCIATION</p>	
 <p>ARB TPC-8 MILL 000</p> <p>COMPANY NAME LOCATION</p> <p>PRODUCT LOT NUMBER:</p>	<p>INDUSTRIAL HARDWOOD PLYWOOD <u>ARB TPC-8 Certified</u></p> <hr/> <p>MEETS CARB ATCM</p> <p>FORMALDEHYDE EMISSIONS PHASE 2 0.05 PPM</p>

Figure 11–7. Typical grade stamps for hardwood plywood. (Courtesy of Hardwood Plywood & Veneer Association, Reston, Virginia. Used by permission.)

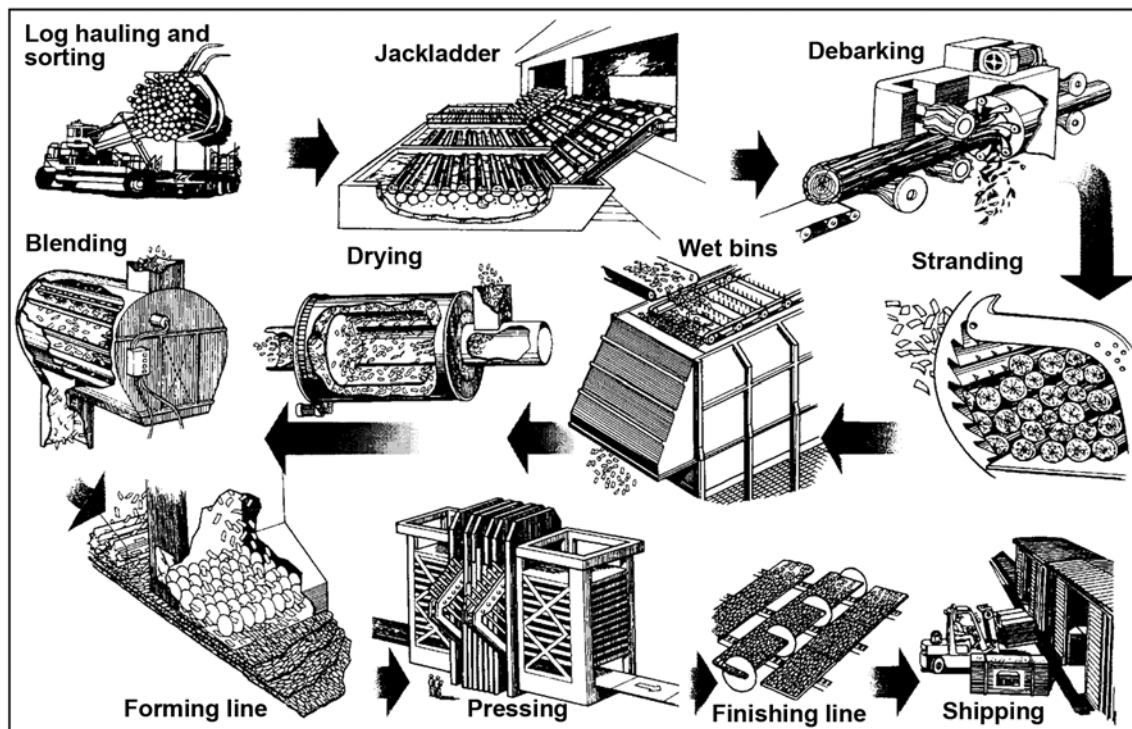

Figure 11-8. Schematic of OSB manufacturing process. (Courtesy of TECO, Sun Prairie, Wisconsin. Used by permission.)

combination triple-pass/single-pass dryer, or a three-section conveyor dryer. A recent development is a continuous chain dryer, in which the strands are laid on a chain mat that is mated with an upper chain mat and the strands are held in place as they move through the dryer. New drying techniques allow the use of longer strands, reducing surface inactivation of strands, and lowering dryer outfeed temperatures. Dried strands are screened and sent to dry bins.

Dried strands are blended with adhesive and wax in a highly controlled operation, with separate rotating blenders used for face and core strands. Typically, different resin formulations are used for face and core layers. Face resins may be liquid or powdered phenolics, whereas core resins may be phenolics or isocyanates. Several different resin application systems are used; spinning disk resin applicators are the most common.

The strands with adhesive applied are sent to mat formers. Mat formers take on a number of configurations, ranging from electrostatic equipment to mechanical devices containing spinning disks to align strands along the panel's length and star-type cross-orienters to position strands across the panel's width. All formers use the long and narrow characteristic of the strand to place it between spinning disks or troughs before it is ejected onto a moving screen or conveyor belt below the forming heads. Oriented layers of strands within the mat are dropped sequentially onto a moving conveyor. The conveyor carries the loose, layered mat into the press.

Once the mat is formed, it is hot-pressed. Hot-pressing consolidates the mat by heating it at 177 to 204 °C (350 to 400 °F), which cures the resin in 3–5 minutes. As many as sixteen 3.7- by 7.3-m (12- by 24-ft) panels may be formed simultaneously in a multiple-opening press. A more recent development is the continuous press which presses the mat between rollers as it is conveyed.

OSB Grade Marks and Product Certification

OSB that has been grade marked is manufactured to comply with voluntary industry product performance standards. Inspection or certification programs also generally require that the quality control system of a production plant meet specified criteria. OSB panels conforming to product performance standards are marked with grade stamps (Fig. 11-6).

Particleboard

Particleboard is produced by mechanically reducing the wood raw material into small particles, applying adhesive to the particles, and consolidating a loose mat of the particles with heat and pressure into a panel product. The particleboard industry initially used cut flakes as a raw material. However, economic concerns prompted development of the ability to use sawdust, planer shavings, and to a lesser extent, mill residues and other waste materials. To manufacture particleboard with good strength, smooth surfaces, and equal swelling, manufacturers ideally use a homogeneous raw material.

Chapter 11 Wood-Based Composite Materials

Particleboard is typically made in layers. But unlike OSB, the faces of particleboard usually consist of fine wood particles and the core is made of coarser material. The result is a smoother surface for laminating, overlaying, painting, or veneering. Particleboard is readily made from virtually any wood material and from a variety of agricultural residues. Low-density insulating or sound-absorbing particleboard can be made from kenaf core or jute stick. Low-, medium-, and high-density panels can be produced with cereal straw, which has been used in North America. Rice husks are commercially manufactured into medium- and high-density products in the Middle East.

All other things being equal, reducing lignocellulosic materials to particles requires less energy than reducing the same material into fibers. However, particleboard is generally not as strong as fiberboard because the fibrous nature of lignocellulosics (that is, their high aspect ratio) is not exploited as well. Particleboard is widely used in furniture, where it is typically overlaid with other materials for decorative purposes. It is the predominant material used in ready-to-assemble furniture. Particleboard can also be used in flooring systems, in manufactured houses, and as underlayment. Thin panels can also be used as a paneling substrate. Since most applications are interior, particleboard is usually bonded with a UF resin, although PF and MF resins are sometimes used for applications requiring more moisture resistance.

Manufacturing Process

Manufacturing particleboard is a dry process. The steps involved in particleboard manufacturing include particle preparation, particle classification and drying, adhesive application, mat formation, pressing, and finishing.

Standard particleboard plants use combinations of hogs, chippers, hammermills, ring flakers, ring mills, and attrition mills to obtain particles. Particles are classified and separated to minimize negative effect on the finished product. Very small particles (fines) increase particle surface area and thus increase resin requirements. Oversized particles can adversely affect the quality of the final product because of internal flaws in the particles. While some particles are classified through the use of air streams, screen classification methods are the most common. In screen classification, the particles are fed over a vibrating flat screen or a series of screens. The screens may be wire cloth, plates with holes or slots, or plates set on edge. Particles are typically conveyed by mechanical means. Sometimes damp conditions are maintained to reduce break-up of particles during conveying.

Desirable particles have a high degree of slenderness (long, thin particles), no oversize particles, no splinters, and no dust. Depending on the manufacturing process and board

configurations, specifications for the ideal particle size are different. For a common three-layer board, core particles are longer and surface particles shorter, thinner, and smaller. For a five-layer board, the particles for the intermediate layer between surface and core are long and thin, which builds a good carrier for the fine surface and gives the boards high bending strength and stiffness. Particleboard used for quality furniture uses much smaller core particles. The tighter core gives a better quality edge which allows particleboard to compete more favorably with MDF.

The raw materials (or furnish) do not usually arrive at the plant at a low enough moisture content for immediate use. Furnish that arrives at the plant can range from 10% to 200% dry basis moisture content. For use with liquid resins, for example, the furnish must be reduced to about 2% to 7% moisture content. The moisture content of particles is critical during hot-pressing operations and depends on whether resin is to be added dry or as a solution or emulsion. The moisture content of materials leaving the dryers is usually in the range of 4% to 8%. The main methods used to dry particles are rotary, disk, and suspension drying. A triple-pass rotary dryer consists of a large horizontal, heated, rotating drum. Operating temperatures depend on the moisture content of the incoming furnish. The drum is set at a slight angle, and material is fed into the high end and discharged at the low end. A series of flights forces the furnish to flow from one end to the other three times before being discharged. The rotary movement of the drum moves the material from input to output.

Frequently used resins for particleboard include UF and, to a much lesser extent, PF, MF, and isocyanates. The type and amount of resin used for particleboard depends on the type of product desired. Based on the weight of dry resin solids and oven-dry weight of the particles, the overall resin content can range between 4% and 10%, but usually ranges between 6% and 9% for UF resins. The resin content of the outer layers is usually higher (about 8% to 15%) than that of the core (about 4% to 8%). UF resin is usually introduced in water solutions containing about 50% to 65% solids. Besides resin, wax is added to improve short-term moisture resistance. The amount of wax ranges from 0.3% to 1% based on the oven-dry weight of the particles.

After the particles have been prepared, they are laid into an even and consistent mat to be pressed into a panel. This is accomplished in batch mode or by continuous formation. The batch system traditionally employs a caul or tray on which a deckle frame is placed. The mat is formed by the back-and-forth movement of a tray or hopper feeder. The production of three-layer boards requires three or more forming stations.

In more common continuous mat-forming systems the particles are distributed in one or several layers on traveling

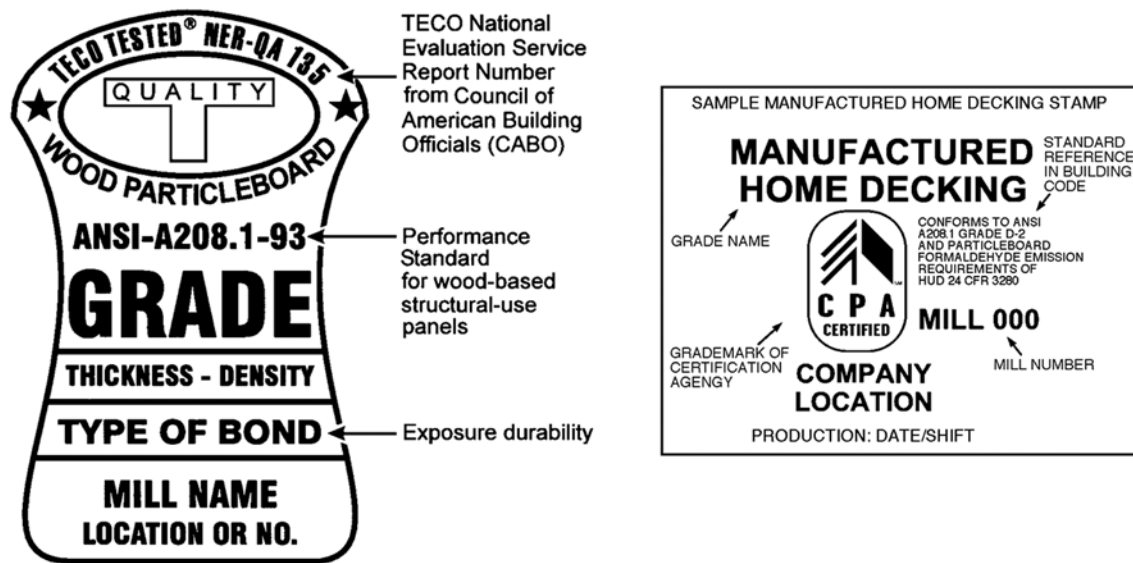

Figure 11-9. Examples of grade stamps for particleboard. (Courtesy of TECO, Sun Prairie, Wisconsin, and Composite Panel Association, Leesburg, Virginia. Used by permission.)

cauls or on a moving belt. Mat thickness is controlled volumetrically. Batch-formed or continuous-formed mats are often pre-pressed to reduce mat height and help consolidate the mat for pressing.

After pre-pressing, the mats are hot-pressed into panels. Presses can be divided into platen and continuous types. Further development in the industry has made possible the construction of presses for producing increasingly larger panel sizes in both single- and multi-opening presses. Both of these types of presses can be as wide as 3.7 m (12 ft). Multi-opening presses can be as long as 10 m (33 ft), and continuous presses, up to 30 m (100 ft) long.

After pressing, panels are trimmed to obtain the desired length and width and to square the edges. Trim losses usually amount to 0.5% to 8%, depending on the size of the panel, the process employed, and the control exercised. Trimmers usually consist of saws with tungsten carbide tips. After trimming, the panels are sanded or planed prior to packaging and shipping. Particleboards may also be veneered or overlaid with other materials to provide a decorative surface, or they may be finished with lacquer or paint. Treatments with fire-resistant chemicals are also available.

Particleboard Grade Marks and Product Certification

A grade mark on particleboard ensures that the product has been periodically tested for compliance with voluntary industry product performance standards. Inspection or certification programs also generally require that the quality control system of a production plant meets strict criteria. Particleboard panels conforming to these product performance standards are marked with grade stamps (Fig. 11-9).

Fiberboard

The term fiberboard includes hardboard, medium-density fiberboard (MDF), and cellulosic fiberboard. Several things differentiate fiberboard from particleboard, most notably the physical configuration of the wood element. Because wood is fibrous by nature, fiberboard exploits the inherent strength of wood to a greater extent than does particleboard.

To make fibers for composites, bonds between the wood fibers must be broken. Attrition milling, or refining, is the easiest way to accomplish this. During refining, material is fed between two disks with radial grooves. As the material is forced through the preset gap between the disks, it is sheared, cut, and abraded into fibers and fiber bundles. Refiners are available with single- or double-rotating disks, as well as steam-pressurized and unpressurized configurations.

Refining can be augmented by steaming or chemical treatments. Steaming the lignocellulosic weakens the lignin bonds between the cellulosic fibers. As a result, fibers are more readily separated and are usually less damaged than fibers processed by dry processing methods. Chemical treatments, usually alkali, are also used to weaken the lignin bonds. Although treatments help increase fiber quality and reduce energy requirements, they may also reduce yield and modify the fiber chemistry. For MDF, steam-pressurized refining is typical.

Fiberboard is normally classified by density and can be made by either dry or wet processes (Fig. 11-3). Dry processes are applicable to boards with high density (hardboard) and medium density (MDF). Wet processes are applicable to both high-density hardboard and low-density

cellulosic fiberboard. The following subsections briefly describe the manufacturing of high- and medium-density dry-process fiberboard, wet-process hardboard, and wet-process low-density cellulosic fiberboard. Suchsland and Woodson (1986) and Maloney (1993) provide more detailed information.

Dry-Process Fiberboard

Dry-process fiberboard is made in a similar fashion to particleboard. Resin (UF or MF–UF) and other additives are applied to the fibers by spraying in short-retention blenders or introduced as wet fibers are fed from the refiner into a blow-line dryer. Alternatively, some fiberboard plants add the resin in the refiner. The adhesive-coated fibers are then air-laid into a mat for subsequent pressing, much the same as mat formation for particleboard.

Pressing procedures for dry-process fiberboard differ somewhat from particleboard procedures. After the fiber mat is formed, it is typically pre-pressed in a band press. The densified mat is then trimmed by disk cutters and transferred to caul plates for the hardboard pressing operation; for MDF, the trimmed mat is transferred directly to the press. Many dry-formed boards are pressed in multi-opening presses. Continuous pressing using large, high-pressure band presses is also gaining in popularity. Panel density is constantly monitored by moisture sensors using infrared light as an indicator of panel quality.

MDF is frequently used in place of solid wood, plywood, and particleboard in many furniture applications. It is also used for interior door skins, mouldings, and interior trim components. ANSI A208.2 classifies MDF by physical and mechanical properties, and identifies dimensional tolerances and formaldehyde emission limits (CPA 2009b). An example of an MDF formaldehyde emissions certification tag is shown in Figure 11–10.

Wet-Process Hardboard

Wet-process hardboards differ from dry-process fiberboards in several significant ways. First, water is used as the fiber distribution medium for mat formation. The technology is really an extension of paper manufacturing technology. Secondly, some wet-process boards are made without additional binders. If the lignocellulosic contains sufficient lignin and if lignin is retained during the refining operation, lignin can serve as the binder. Under heat and pressure, lignin will flow and act as a thermosetting adhesive, enhancing the naturally occurring hydrogen bonds.

Refining is an important step for developing strength in wet-process hardboards. The refining operation must also yield a fiber of high “freeness” (that is, it must be easy to remove water from the fibrous mat). The mat is typically formed on a Fourdrinier wire, like papermaking, or on cylinder formers. The wet process employs a continuously traveling mesh screen, onto which the soupy pulp flows rapidly and

smoothly. Water is drawn off through the screen and then through a series of press rolls.

Wet-process hardboards are pressed in multi-opening presses heated by steam. The press cycle consists of three phases and lasts 6 to 15 min. The first phase is conducted at high pressure, and it removes most of the water while bringing the board to the desired thickness. The primary purpose of the second phase is to remove water vapor. The third phase is relatively short and results in the final cure. A maximum pressure of about 5 MPa (725 lb in⁻²) is used in the first and third phases. Heat is essential during pressing to induce fiber-to-fiber bond. A high temperature of up to 210 °C (410 °F) is used to increase production by causing faster vaporization of the water. Insufficient moisture removal during pressing adversely affects strength and may result in “springback” or blistering.

Wet-formed composite technology has lost market share compared with dry-formed technology over the past few decades because of processing speed and perceived environmental issues related to process water. However, wet-formed technology does offer unique opportunities for forming geometric shapes that yield enhanced structural performance and decrease weight, elimination of fiber drying prior to forming, and reduced need for adhesive resins. It also greatly increases the ability to use recovered paper and some other woody fibers. Recent advances in process wastewater recycling and remediation also bode well for wet-formed technologies. Wet-formed composite technology may become more important because of reduced energy demands, increased composite structural performance and decreased weight, and the virtual elimination of (or drastic reduction in) process water concerns.

Several treatments are used to increase dimensional stability and mechanical performance of hardboard. Heat treatment, tempering, and humidification may be done singularly or in conjunction with one another. Heat treatment—exposure of pressed fiberboard to dry heat—improves dimensional stability and mechanical properties, reduces water adsorption, and improves interfiber bonding. Tempering is the heat treatment of pressed boards, preceded by the addition of oil. Tempering improves board surface hardness, resistance to abrasion, scratching, scarring, and water. The most common oils used include linseed oil, tung oil, and tall oil. Humidification is the addition of moisture to bring the board moisture content to levels roughly equivalent to those anticipated in its end-use environment. Air of high humidity is forced through the stacks where it provides water vapor to the boards. Another method involves spraying water on the back side of the board. Typical hardboard products are prefinished paneling, house siding, floor underlayment, and concrete form board. A typical grade stamp for hardboard siding is shown in Figure 11–11.

Sample Bundle Tag for non-EPP MDF Certified to ANSI A208.2-2009.

**COMPLIES WITH ANSI A208.1-2009 AND
CALIFORNIA 93120 PHASE 1 FORMALDEHYDE
EMISSION LIMITS**



MILL 000

CALIFORNIA ARB APPROVED THIRD PARTY CERTIFIER TPC-1

**MANUFACTURER'S NAME
LOCATION
PRODUCTION SHIFT/CREW
PRODUCTION LOT/BATCH**

**Figure 11–10. Example of MDF formaldehyde emissions certification tag.
(Courtesy of Composite Panel Association, Leesburg, Virginia. Used by
permission.)**

Cellulosic Fiberboard

Cellulosic fiberboards are low-density, wet-laid panel products. In the manufacture of cellulosic fiberboard, the need for refining and screening is a function of the raw material available, the equipment used, and the desired end-product. Cellulosic fiberboards typically do not use a binder, and they rely on hydrogen bonds to hold the board components together. Sizing agents are usually added to the furnish (about 1%) to provide the finished board with a modest degree of water resistance and dimensional stability.

As in the manufacture of wet-process hardboard, cellulosic fiberboard manufacture is a modification of papermaking. A thick fibrous sheet is made from a low-consistency pulp suspension in a process known as wet felting. Felting can be accomplished through use of a deckle box, Fourdrinier screen, or cylinder screen. A deckle box is a bottomless frame that is placed over a screen. A measured amount of pulp suspension is put in the box and a vacuum is applied to remove most of the water. The use of a Fourdrinier screen for felting is similar to that for papermaking, except that line speeds are reduced to 8 to 18 m min⁻¹ (25 to 60 ft min⁻¹).

Cellulosic fiberboard formed in a deckle box is cold-pressed to remove the free water after the mat is formed. Compression rollers on the Fourdrinier machines squeeze

out the free water. The wet mats are then dried to the final moisture content. Dryers may be a continuous tunnel or a multideck arrangement. The board is generally dried in stages at temperatures ranging from 120 to 190 °C (248 to 374 °F). Typically, about 2 to 4 h is required to reduce moisture content to about 1% to 3%.

After drying, some boards are treated for specific applications. Boards may be given tongue-and-groove or shiplap edges or grooved to produce a plank effect. Other boards are laminated by means of asphalt to produce roof insulation.

Cellulosic fiberboard products include sound-deadening board, insulation boards, structural and nonstructural sheathings, backer board, and roof decking in various thicknesses. An example of a grade mark stamp for these cellulosic fiberboard products conforming to ASTM C 208 (ASTM 2008c) is shown in Figure 11–12.

Finishing Techniques

Several techniques are used to finish fiberboard: trimming, sanding, surface treatment, punching, and embossing. Trimming consists of reducing products into standard sizes and shapes. Generally, double-saw trimmers are used to saw the panels. Trimmers consist of overhead-mounted saws or multiple saw drives. If thickness tolerance is critical, hardboard

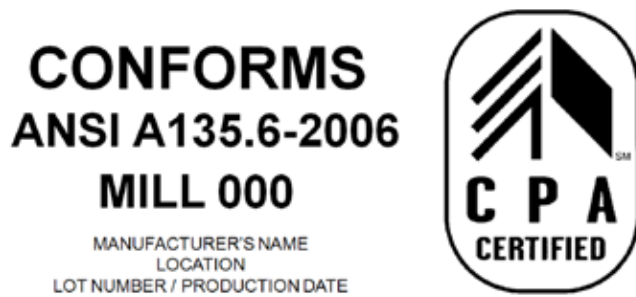

Figure 11–11. Typical grade stamp for hardboard siding. (Courtesy of Composite Panel Association, Leesburg, Virginia. Used by permission.)



Figure 11–12. Typical grade stamp for cellulose fiberboard. (Courtesy American Fiberboard Association, Palatine, Illinois. Used by permission.)

is sanded prior to finishing. S1S (smooth on one side) panels require this process. Sanding reduces thickness variation and improves surface paintability. Single-head, wide-belt sanders are used with 24- to 36-grit abrasive. Surface treatments improve the appearance and performance of boards. Panels are cleaned by spraying with water and then dried at about 240 °C (464 °F) for 30 s. Panel surfaces are then modified with paper overlay, paint, or stain or are printed directly on the panel. Punching changes panels into perforated sheets used as peg board. Embossing consists of pressing the unconsolidated mat of fibers with a textured form. This process results in a slightly contoured panel surface that can enhance the resemblance of the panel to that of sawn or weathered wood, brick, and other materials.

Specialty Composite Materials

Special-purpose composite materials are produced to obtain enhanced performance properties such as water resistance, mechanical strength, acidity control, and fire, decay, and insect resistance. Overlays and veneers can also be added to enhance both structural properties and appearance (Fig. 11–13).

Water-Repellant Composites

Sizing agents are used to increase the water repellency of wood-based composites. Sizing agents cover the surface of fibers, reduce surface energy, and increase fiber hydrophobicity. Sizing agents can be applied in two ways. In the first method, water is used as a medium to ensure thorough mixing of sizing and fiber. The sizing is precipitated from the water and is fixed to the fiber surface. In the second method, the sizing is applied directly to the fibers.

Common sizing agents include rosin, wax, and asphalt. Rosin is obtained from living pine trees, from pine stumps, and as a by-product of kraft pulping of pines. Rosin is added in amounts of less than 3% solids based on dry fiber weight. Waxes are high-molecular-weight hydrocarbons derived from crude oil. Wax is used in solid form in dry-process fiberboard production. For wet processes, wax is added in solid form or as an emulsion. Wax tends to lower strength properties to a greater extent than rosin does. Asphalt is also used to increase water resistance, especially in low-density wet-process cellulosic fiberboard. Asphalt is a black–brown solid or semi-solid material that liquefies when heated. Asphalt is added to the process water as an emulsion and precipitated onto fiber by the addition of alum.

Flame-Retardant Composites

Two general application methods are available for improving the fire performance of composites with fire-retardant chemicals. One method consists of pressure impregnating the wood with waterborne or organic solvent-borne fire retardant chemicals (AWPA 2007a). The second method consists of applying fire-retardant chemical coatings to the wood surface. The pressure impregnation method is usually more effective and longer lasting; however, this technique is standardized only for plywood. It is not generally used with structural flake, particle, or fiber composites, because it can cause swelling that permanently damages the wood–adhesive bonds in the composite and results in the degradation of some physical and mechanical properties of the composite. For wood in existing constructions, surface application of fire-retardant paints or other finishes offers a possible method to reduce flame spread.

Preservative-Treated Composites

Composites can be protected from attack by decay fungi and harmful insects by applying selected chemicals as wood preservatives. The degree of protection obtained depends on the kind of preservative used and the ability to achieve proper penetration and retention of the chemicals. Wood preservatives can be applied using pressurized or non-pressurized processes (AWPA 2007b). As in the application of fire-retardant chemicals, the pressurized application of wood preservatives is generally performed after manufacture and is standardized for plywood. Post-manufacture pressurized treatments are not standardized for all types of flake, particle, or fiber composite due to the potential for swelling. Preservatives can be added during the composite manufacturing process, but the preservative must be resistant to vaporization during hot pressing. Proprietary flakeboard and fiberboard products with incorporated nonvolatile preservatives have been commercialized. Common preservative treatments include ammoniacal copper quat (ACQ), copper azol (CA), and boron compounds.

Performance and Standards

Standards for conventional wood-based composite products are typically established under a series of internationally



Figure 11–13. Medium-density fiberboard with veneer overlay. Edges can be shaped and finished as required by end product.

accredited consensus review processes involving users, producers, and general interests. Then, commercial wood composites are manufactured to conform to these commercial product or performance standards (Table 11–2). These product or performance standards are cited in the International Building Code (IBC) and other similar documents. The IBC is the model building code produced by the International Code Council (ICC), a non-profit organization established in 1994 dedicated to developing a single set of comprehensive and coordinated construction codes. Since the adoption of the first edition of the IBC in 2000, most building codes in the U.S. are based on the IBC. Previously, there were three model code organizations that produced model codes with largely regional acceptance. The ICC also produces the International Residential Code (IRC) and other related model code documents.

The ICC–Evaluation Service (ICC–ES) issues advisory reports on their evaluation of building products, components, methods, and materials for their compliance with the IBC. The ICC–ES was created in 2003 with the merger of the four existing evaluation services. ICC–ES also issues ICC–ES Acceptance Criteria documents for specific types of products that specify the performance criteria and the data that needs to be submitted for the evaluations. These evaluation reports and the acceptance criteria documents are available on the web site of the ICC–ES (www.icc-es.org).

Types of Product Standards

Product standards may be classified as manufacturing standards or performance standards. The best example of a manufacturing method standard is Voluntary Product Standard PS 1–07 for construction and industrial plywood (NIST 2007). Specifications in the standard include which wood species and grades of veneer may be used, what repairs are permissible, and how repairs must be made. Limited performance-based evaluations may also be specified in manufacturing standards for issues relating to adhesive durability and strength.

Standard PS 2–04 (NIST 2004) is a performance-based standard because it applies to all structural-use wood-based panels, including plywood and OSB. This standard includes performance requirements and test methods suitable for a given application (qualification) and also require that properties of a qualified product remain in control during production over time (certification). With respect to plywood, the PS 2–04 standard is not a replacement for PS 1–07, which contains necessary veneer-grade and adhesive-bond requirements as well as lay-up provisions, but it is broad enough to also include many plywood grades not covered under PS 1–07. PS 2–04 specifies that certification be performed by an independent third party.

The American National Standards for particleboard and MDF (ANSI A208.1 and A208.2 respectively) are sponsored by the Composite Panel Association (CPA) in Leesburg, Virginia (CPA 2009a, b). These performance standards require the composite products to show certain minimally acceptable physical and mechanical properties. The test requirements give some indication of product quality, but the tests were not specifically developed to correlate with performance of whole panels in specific end uses.

Role of Standards in Construction

Conventional wood-based composite panels and lumber elements manufactured in conformance with product standards (Table 11–2) are approved under the International Building Code. These wood-based composites can be used for construction applications such as sheathing for roofs, sub-flooring, and walls. Similarly, many types of wood-based composite lumber can be used for joists, purlins, stringers, beams, and columns.

Design properties and basic installation guidelines of structural-use panels have become standardized by the ICC. The ICC requires independent third-party certification of these panels, and several such third-party certification agencies exist, such as APA–The Engineered Wood Association (www.apawood.org) and TECO (www.tecotested.com). These agencies and others offer a variety of technical information on the proper selection, design, and installation of structural-use panels.

Plywood panels conforming to PS 1–07 are marked with grade stamps (Fig. 11–6a,b). Flake-based composites, such as OSB, are usually marketed as conforming to a product standard for sheathing or single-layer sub-flooring or underlayment and are also marked with grade stamps (Fig. 11–6c,d).

Structural-use panels are also span-rated. Span ratings refer to on-center spacing of support members (expressed in inches), with the long panel dimension (in plywood this is the same direction as the face grain) placed across the supports, assuming that there are at least two spans (a minimum of three supports). Span-rating of construction plywood and OSB simplifies materials specification in light-frame

construction by allowing specification without resorting to specific structural engineering design calculations. Panels in PS 2–04 are designated by application (wall, roof, sub-floor, or single floor) and by span rating. Specification by application and span is more convenient for builders than specification by species or species group, veneer grade, and panel thickness. A panel may be suitable for use as either roof sheathing or sub-flooring, with different span ratings for the two applications. Such panels will have a dual span-rating, the first (and larger) number indicating allowable span when used as roof sheathing, the second number indicating the allowable span when used as sub-flooring.

Glulam Timber

Structural glued-laminated timber (glulam) is one of the oldest glued engineered wood products. Glulam is an engineered, stress-rated product that consists of two or more layers of lumber that are glued together with the grain of all layers, which are referred to as laminations, parallel to the length. Glulam is defined as a material that is made from suitably selected and prepared pieces of wood either in a straight or curved form, with the grain of all pieces essentially parallel to the longitudinal axis of the member. The maximum lamination thickness permitted is 50 mm (2 in.), and the laminations are typically made of standard 25- or 50-mm- (nominal 1- or 2-in.-) thick lumber. North American standards require that glulam be manufactured in an approved manufacturing plant. Because the lumber is joined end to end, edge to edge, and face to face, the size of glulam is limited only by the capabilities of the manufacturing plant and the transportation system.

Douglas Fir–Larch, Southern Pine, Hem–Fir, and Spruce–Pine–Fir (SPF) are commonly used for glulam in the United States. Nearly any species can be used for glulam timber, provided the mechanical and physical properties are suitable and gluing properties acceptable. Industry standards cover many softwoods and hardwoods, and procedures are in place for including other species.

Advantages

Compared with sawn timbers as well as other structural materials, glulam has several distinct advantages. These include size capability, architectural effects, seasoning, variation of cross sections, grades, and effect on the environment.

Size Capabilities

Glulam offers the possibility of manufacturing structural timbers that are much larger than the trees from which the component lumber was sawn. In the past, the United States had access to large trees that could produce relatively large sawn timbers. However, the present trend is to harvest smaller diameter trees on much shorter rotations, and nearly all new sawmills are built to accommodate relatively small logs. By combining the lumber in glulam, the production of

large structural elements is possible. Straight members up to 30 m (100 ft) long are not uncommon, and some span up to 43 m (140 ft). Sections deeper than 2 m (7 ft) have been used. Thus, glulam offers the potential to produce large timbers from small trees.

Architectural Effects

By curving lumber during the manufacturing process, a variety of architectural effects can be obtained with glulam that are impossible or very difficult with other materials (Fig. 11–14). The degree of curvature is controlled by the thickness of the laminations. Thus, glulam with moderate curvature is generally manufactured with standard 19-mm- (nominal 1-in.-) thick lumber. Low curvatures are possible with standard 38-mm (nominal 2-in.) lumber, whereas 13 mm (1/2 in.) or thinner material may be required for very sharp curves. As noted later in this chapter, the radius of curvature is limited to between 100 and 125 times the lamination thickness.

Seasoning Advantages

The lumber used in the manufacture of glulam must be seasoned or dried prior to use, so the effects of checking and other drying defects are minimized. This allows design on the basis of seasoned wood, which permits greater design values than can be assigned to unseasoned timber.

Varying Cross Sections

Structural elements can be designed with varying cross sections along their length as determined by strength and stiffness requirements. Similarly, arches often have varying cross sections as determined by design requirements.

Varying Grades

One major advantage of glulam is that a large quantity of lower grade lumber can be used within the less highly stressed laminations of the beams. Grades are often varied within the beams so that the highest grades are used in the highly stressed laminations near the top and bottom edges, with the lower grades used in the inner section (toward the center) of the beams. Species can also be varied to match the structural requirements of the laminations.

Types of Glulam Combinations

Bending Members

The configuring of various grades of lumber to form a glulam cross section is commonly referred to as a glulam combination. Glulam combinations subjected to flexural loads, called bending combinations, were developed to provide the most efficient and economical section for resisting bending stress caused by loads applied perpendicular to the wide faces of the laminations. This type of glulam is commonly referred to as a horizontally laminated member. Lower grades of laminating lumber are commonly used for the center portion of the combination, or core, where bending stress is low, while a higher grade of material is placed



Figure 11–14. Erected in 1934 at the Forest Products Laboratory in Madison, Wisconsin, this building is one of the first constructed with glued-laminated timbers arched, designed, and built using engineering principles.

on the outside faces where bending stress is relatively high. To optimize the bending stiffness of this type of glulam member, equal amounts of high-quality laminations on the outside faces should be included to produce a “balanced” combination. To optimize bending strength, the combination can be “unbalanced” with more high-quality laminations placed on the tension side of the member compared with the quality used on the compression side. For high-quality lumber placed on the tension side of the glulam combination, stringent requirements are placed on knot size, slope of grain, and lumber stiffness.

For compression-side laminations, knot size and slope-of-grain requirements are less stringent and only lumber stiffness is given high priority. In the case where the glulam member is used over continuous supports, the combination would need to be designed as a balanced member for strength and stiffness because of the exposure of both the top and bottom of the beam to tensile stresses. The knot and slope-of-grain requirements for this type of combination are generally applied equally to both the top and bottom laminations.

Axial Members

Glulam axial combinations were developed to provide the most efficient and economical section for resisting axial forces and flexural loads applied parallel to the wide faces of the laminations. Members having loads applied parallel to the wide faces of the laminations are commonly referred to as vertically laminated members. Unlike the practice for bending combinations, the same grade of lamination is used throughout the axial combination. Axial combinations may also be loaded perpendicular to the wide face of the

laminations, but the nonselective placement of material often results in a less efficient and less economical member than does the bending combination. As with bending combinations, knot and slope-of-grain requirements apply based on whether the axial member will be used as a tension or compression member.

Curved Members

Efficient use of lumber in cross sections of curved glulam combinations is similar to that in cross sections of straight, horizontally laminated combinations. Tension and compression stresses are analyzed as tangential stresses in the curved portion of the member. A unique behavior in these curved members is the formation of radial stresses perpendicular to the wide faces of the laminations. As the radius of curvature of the glulam member decreases, the radial stresses formed in the curved portion of the beam increase. Because of the relatively low strength of lumber in tension perpendicular-to-the-grain compared with tension parallel-to-the-grain, these radial stresses become a critical factor in designing curved glulam combinations. Curved members are commonly manufactured with standard 19- and 38-mm- (nominal 1- and 2-in.-) thick lumber. Naturally, the curvature that is obtainable with the standard 19-mm- (nominal 1-in.-) thick lumber will be sharper than that for the standard 38-mm- (nominal 2-in.-) thick lumber.

Tapered Straight Members

Glulam beams are often tapered to meet architectural requirements, provide pitched roofs, facilitate drainage, and lower wall height requirements at the end supports. The taper is achieved by sawing the member across one or more laminations at the desired slope. It is recommended that the taper cut be made only on the compression side of the glulam member, because violating the continuity of the tension-side laminations would decrease the overall strength of the member.

Standards and Specifications

Manufacture

The ANSI/AITC A190.1 standard of the American National Standards Institute (AITC 2007a) contains requirements for the production, testing, and certification of structural glulam timber in the United States. A standard for glulam poles, ANSI O5.2 (ANSI 2006), addresses special requirements for utility uses.

Derivation of Design Values

ASTM D 3737 (ASTM 2008a) covers procedures to establish design values for structural glulam timber. Properties considered include bending, tension, compression parallel to grain, modulus of elasticity, horizontal shear, radial tension, and compression perpendicular to grain.

Design Values and Procedures

Manufacturers of glulam timber have standardized the target design values in bending for beams. For softwoods, these design values are given in AITC 117, “Standard Specifications for Structural Glued-Laminated Timber of Softwood Species” (AITC 2004a). This specification contains design values and recommended modification of stresses for the design of glulam timber members in the United States. A comparable specification for hardwoods is AITC 119, “Standard Specifications for Structural Glued-Laminated Timber of Hardwood Species” (AITC 1996). For additional design information, see the *Timber Construction Manual* (AITC 2004b).

Manufacture

The manufacture of glulam timber must follow recognized national standards to justify the specified engineering design values. When glulam is properly manufactured, both the quality of the wood and the adhesive bonds should demonstrate a balance in structural performance.

The ANSI/AITC standard A190.1 (AITC 2007a) has a two-phase approach to all phases of manufacturing. First is the qualification phase, in which all equipment and personnel critical to the production of a quality product are thoroughly examined by a third-party agency and the strength of samples of glued joints is determined. In the second phase, after successful qualification, daily quality assurance procedures and criteria are established, which are targeted to keep each of the critical phases of the process under control. An employee is assigned responsibility for supervising the daily testing and inspection. The third-party agency makes unannounced visits to the plants to monitor the manufacturing process and the finished product and to examine the daily records of the quality assurance testing.

The manufacturing process can be divided into four major parts: (a) drying and grading the lumber, (b) end jointing the lumber, (c) face bonding, and (d) finishing and fabrication. In instances where the glulam will be used in high-moisture-content conditions, the member must also be pressure-treated with preservative.

A final critical step in ensuring the quality of glulam is protection of the glulam timber during transit and storage.

Lumber Drying and Grading

To minimize dimensional changes following manufacture and to take advantage of the increased structural properties assigned to lumber compared with large sawn timbers, the lumber must be properly dried prior to glulam manufacture. This generally means kiln drying. Matching the moisture content of the glulam timber at the time of manufacture to that which it will attain in application minimizes shrinkage and swelling, the main causes of checking. Most manufacturers use a continuous in-line moisture meter to check the

moisture content of each piece of lumber as it enters the manufacturing process. Pieces that have a high moisture level are removed and redried.

Grading standards published by the regional lumber grading associations describe the characteristics that are permitted in various grades of lumber. Manufacturing standards for glulam timber describe the combination of lumber grades necessary for specific design values (AITC 117) (AITC 2004). The rules for visually graded lumber are based entirely upon the characteristics that are readily apparent. The lumber grade description consists of limiting characteristics for knot sizes, slope of grain, wane, and several other characteristics.

Manufacturers generally purchase graded lumber and verify the grades through visual inspection of each piece and, if E-rated, testing of a sample. To qualify the material for some of the higher design stresses for glulam timber, manufacturers must also conduct additional grading for material to be used in the tension zone of certain beams. Another option is to purchase lumber manufactured under a quality assurance system that meets the required tensile strength. Another option practiced by at least one manufacturer has been to use laminated veneer lumber (LVL) to provide the required tensile strength.

End Jointing

To manufacture glulam timber in lengths beyond those commonly available for lumber, laminations must be made by end jointing lumber to the proper length. The most common end joint, a fingerjoint, is about 28 mm (1.1 in.) long. Other configurations are also acceptable, provided they meet specific strength and durability requirements. The advantages of fingerjoints are that they require only a short length of lumber to manufacture (thus reducing waste) and continuous production equipment is readily available. Well-made joints are critical to ensure adequate performance of glulam timber. Careful control at each stage of the process—determining lumber quality, cutting the joint, applying the adhesive, mating, applying end pressure, and curing—is necessary to produce consistent high strength joints.

Face Bonding

The assembly of laminations into full-depth members is another critical stage in manufacture. To obtain clear, parallel, and glueable surfaces, laminations must be planed to strict tolerances. The best procedure is to plane the two wide faces of the laminations just prior to the gluing process. This ensures that the final assembly will be rectangular and that the pressure will be applied evenly. Adhesives that have been pre-qualified are then spread, usually with a glue extruder. Phenol resorcinol is the most commonly used adhesive for face gluing, but other adhesives that have been adequately evaluated and proven to meet performance and durability requirements may also be used.

The laminations are then assembled into the required layout; after the adhesive is given the proper open assembly time, pressure is applied. The most common method for applying pressure is with clamping beds; the pressure is applied with either a mechanical or hydraulic system. This results in a batch-type process, and the adhesive is allowed to cure at room temperature from 6 to 24 h. Some newer automated clamping systems include continuous hydraulic presses and radio-frequency curing to shorten the face gluing process from hours to minutes. Upon completion of the face bonding process, the adhesive is expected to have attained 90% or more of its bond strength. During the next few days, curing continues, but at a much slower rate.

The face bonding process is monitored by controls in the lumber planing, adhesive mixing, and adhesive spreading and clamping processes. Performance is evaluated by conducting shear tests on samples cut off as end trim from the finished glulam timber. Thus, the adhesive bonds are expected to develop nearly the full strength of the wood soon after manufacture.

Finishing and Fabrication

After the glulam timber is removed from the clamping system, the wide faces are planed to remove the adhesive that has squeezed out between adjacent laminations and to smooth out any slight irregularities between the edges of adjacent laminations. As a result, the finished glulam timber is slightly narrower than nominal dimension lumber. The remaining two faces of the member can be lightly planed or sanded.

The appearance requirements of the beam dictate the additional finishing necessary at this point. Historically, three classifications of finishing have been included in the industry standard, AITC 110: Industrial, Architectural, and Premium (AITC 2001). Industrial appearance is generally applicable when appearance is not a primary concern, such as industrial plants and warehouses. Architectural appearance is suitable for most applications where appearance is an important requirement. Premium appearance is the highest classification. The primary difference among these classifications is the amount of knot holes and occasional planer skips that are permitted. A recently introduced classification, called Framing, consists of hit-and-miss planing and permits a significant amount of adhesive to remain on the surface. This finishing is intended for uses that require one member to have the same width as the lumber used in manufacture for framing into walls. These members are often covered in the finished structure.

The next step in the manufacturing process is fabrication, where the final cuts are made, holes are drilled, connectors are added, and a finish or sealer is applied, if specified. For various members, different degrees of prefabrication are done at this point. Trusses may be partially or fully

assembled. Moment splices can be fully fabricated, then disconnected for transportation and erection. End sealers, surface sealers, primer coats, and wrapping with waterproof paper or plastic all help to stabilize the moisture content of the glulam timber between the time it is manufactured and installed. The extent of protection necessary depends upon the end use and must be specified.

Preservative Treatment

In instances where the moisture content of the finished glulam timber will approach or exceed 20% (in most exterior and some interior uses), the glulam timber should be preservative-treated following AITC 109 (AITC 2007b). Three main types of preservatives are available: creosote, oilborne, and waterborne. Creosote and oilborne preservatives are applied to the finished glulam timbers. Some light oil solvent treatments can be applied to the lumber prior to gluing, but the suitability must be verified with the manufacturer. Waterborne preservatives are best applied to the lumber prior to the laminating and manufacturing process because they can lead to excessive checking if applied to large finished glulam timbers.

Structural Composite Lumber

Structural composite lumber (SCL) was developed in response to the increasing demand for high-quality lumber at a time when it was becoming difficult to obtain this type of lumber from the forest resource. Structural composite lumber products are characterized by smaller pieces of wood glued together into sizes common for solid-sawn lumber.

One type of SCL product is manufactured by laminating veneer with all plies parallel to the length. This product is called laminated veneer lumber (LVL) and consists of specially graded veneer. Another type of SCL product consists of strands of wood or strips of veneer glued together under high pressures and temperatures. Depending upon the component material, this product is called laminated strand lumber (LSL), parallel strand lumber (PSL), or oriented strand lumber (OSL). These types of SCL products can be manufactured from raw materials, such as aspen or other underutilized species, that are not commonly used for structural applications. Different widths of lumber can be ripped from SCL for various uses. Compared with similar size solid-sawn lumber, SCL often provides a stronger, more reliable structural member that can often span greater distances and has less dimensional change.

Structural composite lumber is a growing segment of the engineered wood products industry. It is used as a replacement for lumber in various applications and in the manufacture of other engineered wood products, such as prefabricated wood I-joists, which take advantage of engineering design values that can be greater than those commonly assigned to sawn lumber.

Laminated Veneer Lumber

Work in the 1940s on LVL targeted the production of high-strength parts for aircraft structures using Sitka spruce veneer. Research on LVL in the 1970s was aimed at defining the effects of processing variables for veneer up to 12.7 mm (1/2 in.) thick. Since the 1990s, production of LVL uses veneers 3.2 to 2.5 mm (1/8 to 1/10 in.) thick, which are hot pressed with phenol-formaldehyde adhesive into lengths from 2.4 to 18.3 m (8 to 60 ft) or more. Today LVL is commonly used as the flanges in composite I-joists.

Veneer for the manufacture of LVL must be carefully selected for the product to achieve the desired engineering properties. Veneers are often sorted using ultrasonic testing to ensure that the finished product will have the desired engineering properties.

End joints between individual veneers may be staggered along the product to minimize their effect on strength. These end joints may be butt joints, or the veneer ends may overlap for some distance to provide load transfer. Some producers provide structural end joints in the veneers using either scarf or fingerjoints. LVL may also be made in 2.4-m (8-ft) lengths, having no end joints in the veneer; longer pieces are then formed by end-jointing these pieces to create the desired length.

Sheets of LVL are commonly produced in 0.6- to 1.2-m (2- to 4-ft) widths in a thickness of 38 mm (1.5 in.). Continuous presses can be used to form a potentially endless sheet, which is cut to the desired length. Various widths of lumber can be manufactured at the plant or the retail facility.

Parallel Strand Lumber

Parallel strand lumber (PSL) is defined as a composite of wood strand elements with wood fibers oriented primarily along the length of the member. The least dimension of the strands must not exceed 6.4 mm (0.25 in.), and the average length of the strands must be a minimum of 150 times the least dimension. PSL is a proprietary product, sold as Paral-lam[®]. It is often used for large beams and columns, typically as a replacement of solid-sawn lumber or glulam.

Parallel strand lumber is manufactured using veneer about 3 mm (1/8 in.) thick, which is then clipped into strands about 19 mm (3/4 in.) wide. These strands are commonly at least 0.6 m (24 in.) long. The manufacturing process was designed to use the material from roundup of the log in the veneer cutting operation as well as other less than full-width veneer (Fig. 11–15). Thus, the process can utilize waste material from a plywood or LVL operation. Species commonly used for PSL include Douglas-fir, southern pines, western hemlock, and yellow-poplar, but there are no restrictions on using other species.

The strands are coated with a waterproof structural adhesive, commonly phenol-resorcinol formaldehyde, and oriented in a press using special equipment to ensure proper

orientation and distribution. The pressing operation results in densification of the material, and the adhesive is cured using microwave technology. Billets larger than those of LVL are commonly produced; a typical size is 0.28 by 0.48 m (11 by 19 in.). This product can then be sawn into smaller pieces, if desired. As with LVL, a continuous press is used so that the length of the product is limited by handling restrictions.

Laminated Strand Lumber and Oriented Strand Lumber

Laminated strand lumber (LSL) and oriented strand lumber (OSL) products are an extension of the technology used to produce oriented strandboard (OSB) structural panels. The products have more similarities than differences. The main difference is that the aspect ratio of strands used in LSL is higher than for OSB (AF&PA 2006). One type of LSL uses strands that are about 0.3 m (12 in.) long, which is somewhat longer than the strands commonly used for OSB. Waterproof adhesives are used in the manufacture of LSL. One type of product uses an isocyanate type of adhesive that is sprayed on the strands and cured by steam injection. This product needs a greater degree of alignment of the strands than does OSB and higher pressures, which result in increased densification. Both LSL and OSL are proprietary products; LSL is sold as TimberStrand[®]. Applications such as studs and millwork are common.

Advantages and Uses

In contrast with sawn lumber, the strength-reducing characteristics of SCL are dispersed within the veneer or strands and have much less effect on strength properties. Thus, relatively high design values can be assigned to strength properties for both LVL and PSL. Whereas both LSL and OSL have somewhat lower design values, they have the advantage of being produced from a raw material that need not be in a log size large enough for peeling into veneer. All SCL products are made with structural adhesives and are dependent upon a minimum level of strength in these bonds.

All SCL products are made from veneers or strands that are dried to a moisture content that is slightly less than that for most service conditions. Thus, little change in moisture content will occur in many protected service conditions. When used indoors, this results in a product that is less likely to warp or shrink in service. However, the porous nature of both LVL and PSL means that these products can quickly absorb water unless they are provided with some protection.

All types of SCL products can be substituted for sawn lumber products in many applications. Laminated veneer lumber is used extensively for scaffold planks and in the flanges of prefabricated I-joists, which take advantage of the relatively high design properties. Both LVL and PSL beams are used as headers and major load-carrying elements in construction. The LSL and OSL products are used for band joists in

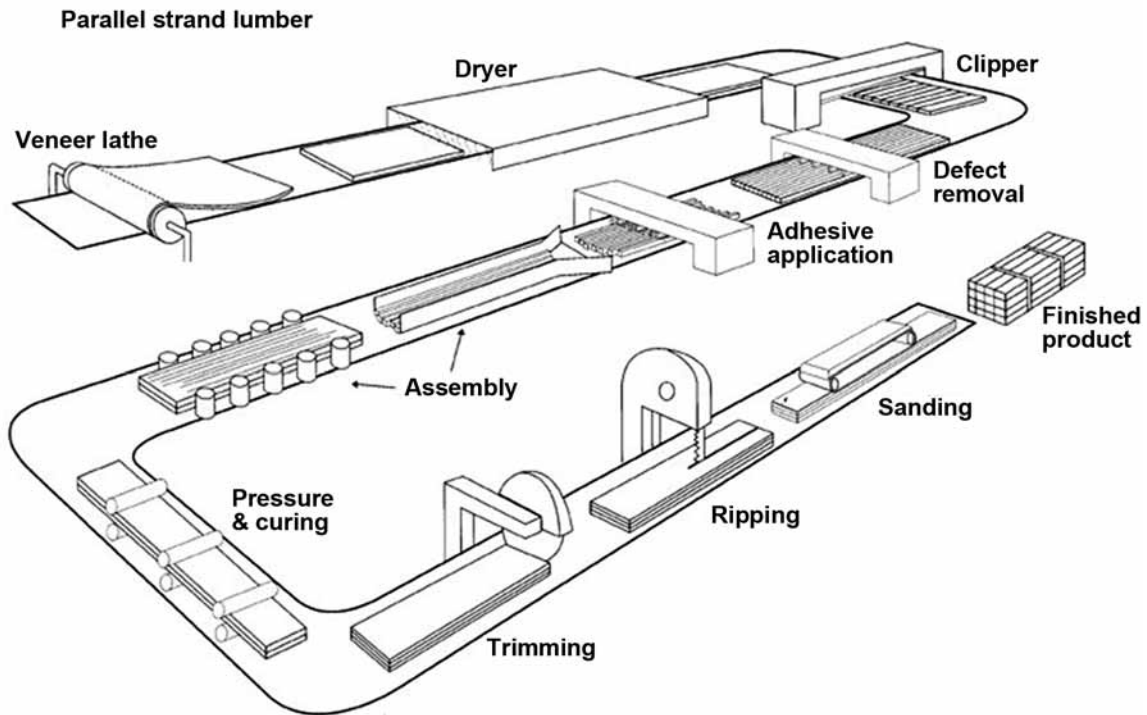

Figure 11–15. Generalized process for manufacturing PSL. (Courtesy of iLevel by Weyerhaeuser, Federal Way, Washington. Used by permission.)

floor construction and as substitutes for studs and rafters in wall and roof construction. Various types of SCL are also used in a number of nonstructural applications, such as the manufacture of windows and doors.

Standards and Specifications

The ASTM D 5456 (ASTM 2008b) standard provides methods to develop design properties for SCL products as well as requirements for quality assurance during production. Each manufacturer of SCL products is responsible for developing the required information on properties and ensuring that the minimum levels of quality are maintained during production. An independent inspection agency is required to monitor the quality assurance program.

Unlike lumber, no standard grades or design stresses have been established for SCL. Each manufacturer may have unique design properties and procedures. Thus, the designer should consult information provided by the manufacturer.

Wood–Nonwood Composite Materials

Wood may be combined with inorganic materials and with plastics to produce composite products with unique properties. Wood–nonwood composites typically contain wood elements suspended in a matrix material (for example in fiber-reinforced gypsum board, or in thermoplastic material), in which the proportion of wood elements may account for less than 60% of product mass.

The primary impetus for developing such products has come from one or more of the following research and development goals:

- Develop “green” or “environmentally benign” products with enhanced sustainability.
- Reduce material costs by combining a lower cost material (acting as a filler or extender) with an expensive material.
- Develop products that can utilize recycled materials and be recyclable in themselves.
- Produce composite products that exhibit specific properties that are superior to those of the component materials alone (for example, increased strength-to-weight ratio, improved abrasion resistance, enhance resistance to fire, decay, and insects).

Composites made from wood and other non-wood materials create enormous opportunities to match product performance to end-use requirements. The following discussion includes the most common type of wood–nonwood composites: inorganic-bonded and wood–thermoplastic composites.

Inorganic-Bonded Composite Materials

Inorganic-bonded wood composites have a long and varied history that started with commercial production in Austria in 1914. They are now used in many countries in the world, mostly in panel form. Applications include panel products, siding, roofing tiles, and precast building members.

Chapter 11 Wood-Based Composite Materials

Inorganic-bonded wood composites are molded products or boards that contain between 10% and 70% by weight wood particles or fibers and conversely 90% to 30% inorganic binder. Acceptable properties of an inorganic-bonded wood composite can be obtained only when the wood particles are fully encased, and the binder is a continuous matrix material. This differs considerably from conventional wood-based composites, where flakes or particles are “spot welded” by a binder applied as a finely distributed spray or powder. Because of this difference and because hardened inorganic binders have a higher density than most thermosetting resins, the required amount of inorganic binder per unit volume of composite material is much higher than that of resin-bonded wood composites. The properties of inorganic-bonded wood composites are significantly influenced by the amount and type of the inorganic binder and the wood element as well as the density of the composites.

Inorganic-bonded composites include gypsum-bonded, cement-bonded, and ceramic-bonded composites. Magnesia and Portland cement are the most common cement binders. Gypsum and magnesia cement are sensitive to moisture, and their use is generally restricted to interior applications. Composites bonded with Portland cement are more durable than those bonded with gypsum or magnesia cement and are used in both interior and exterior applications. Inorganic-bonded composites are made by blending wood elements with inorganic materials in the presence of water and allowing the inorganic material to cure or “set up” to make a rigid composite. Some inorganic-bonded composites are very resistant to deterioration by decay fungi, insects, and vermin. Most have appreciable fire resistance.

An advantage of inorganic-bonded composites is that their manufacture is adaptable to either end of the cost and technology spectrum. This is facilitated by the fact that no heat is required to cure the inorganic material. This versatility makes inorganic-bonded composites ideally suited to a variety of lignocellulosic materials. With a very small capital investment, satisfactory inorganic-bonded lignocellulosic composite building materials can be produced on a small scale using mostly unskilled labor. If the market for such composites increases, technology can be introduced to increase manufacturing throughput. The labor force can be trained concurrently with the gradual introduction of more sophisticated technology.

Gypsum-Bonded Composite Materials

Paper-faced gypsum boards have been widely used since the 1950s for the interior lining of walls and ceilings. They are commonly called drywall because they often replaced wet plaster systems. These panels are critical for good fire ratings in walls and ceilings. Paper-faced gypsum boards also find use as exterior wall sheathing. Gypsum sheathing panels are primarily used in commercial construction, usually over steel studding, and are distinguished from gypsum dry-

wall by their water repellent additives in the paper facings and gypsum core. The facings of drywall and of gypsum sheathing panels are adhered to the gypsum core, providing the panels with impact resistance, and bending strength and stiffness. The paper facings of gypsum panels are derived from recycled paper fiber.

An alternative to adhered facings is to incorporate lignocellulosic fiber (typically recycled paper fiber) in the gypsum core to make what are termed fiber-reinforced gypsum panels. In the production process, a paste of gypsum and water is mixed with the recycled paper fiber and extruded into a panel without facings. Shortly after formation, the panel is dried in an oven. Bonding occurs between the gypsum and the fiber as hydrate crystals form.

Fiber-reinforced gypsum panels are typically stronger and more resistant to abrasion and indentation than paper-faced drywall panels and also have a moderate fastener-holding capability. They are marketed for use as interior finish panels (drywall). Additives can provide a moderate degree of water resistance, for use as sheathing panels, floor underlayment, roof underlayment, or tile-backer board.

Cement-Bonded Composite Materials

The properties of cement-bonded composites are influenced by wood element characteristics (species, size, geometry, chemical composition), cement type, wood–water–cement ratio, environmental temperature, and cure time (Jorge and others 2004). They are heavier than conventional wood-based composites but lighter than concrete. Therefore they can replace concrete in construction, specifically in applications that are not subjected to loads. Wood–cement composites provide an option for using wood residues, or even agricultural residues. However, species selection can be important because many species contain sugars and extractives that retard the cure of cement (Bowyer and others 2007).

Magnesia-Cement-Bonded Composite Materials

Fewer boards bonded with magnesia cement have been produced than Portland-cement-bonded panels, mainly because of price. However, magnesia cement does offer some manufacturing advantages over Portland cement. First, the various sugars in lignocellulosics do not have as much effect on the curing and bonding. Second, magnesia cement is more tolerant of high water content during production. This opens up possibilities to use lignocellulosics not amenable to Portland cement composites, without leaching or other modification, and to use alternative manufacturing processes and products. Although composites bonded with magnesia cement are considered water sensitive, they are much less so than gypsum-bonded composites.

One successful application of magnesia cement is a low-density panel made for interior ceiling and wall applications. In the production of this panel product, wood wool (excelsior) is laid out in a low-density mat. The mat is then sprayed



Figure 11–16. Commercial cement-bonded composite panel. (Courtesy of Ty-Mawr Lime Ltd., UK. Used by permission.)

with an aqueous solution of magnesia cement, pressed, and cut into panels (Fig. 11–16).

Other processes have been suggested for manufacturing magnesia-cement-bonded composites. For example, a slurry of magnesia cement, water, and lignocellulosic fiber may be sprayed onto existing structures as fireproofing. Extrusion into a pipe-type profile or other profiles is also possible.

Portland-Cement-Bonded Composite Materials

The most widely used cement-bonded composites are those bonded with Portland cement. Portland cement, when combined with water, reacts in a process called hydration to solidify into a solid stone-like mass and bind aggregate materials. Successfully marketed Portland-cement-bonded composites consist of both low-density products made with excelsior and high-density products made with particles and fibers.

Low-density products may be used as interior ceiling and wall panels in commercial buildings. In addition to the advantages described for low-density magnesia-bonded composites, low-density composites bonded with Portland cement offer sound control and can be decorative. In some parts of the world, these panels function as complete wall and roof decking systems. The exterior of the panels is coated with stucco, and the interior is plastered. High-density panels can be used as flooring, roof sheathing, fire doors, load-bearing walls, and cement forms. Fairly complex shapes, such as decorative roofing tiles or non-pressure pipes, can be molded or extruded.

The largest volume of cement-bonded wood-based composite materials manufactured in North America is fiber-cement siding. Fiber-cement siding incorporates delignified wood fiber into a Portland cement matrix.

Problems and Solutions of Cement-Bonded Composite Materials

The use of cement for wood-based composites involves limitations and tradeoffs. Embrittlement of the lignocellulosic component is known to occur and is caused by the alkaline environment provided by the cement matrix. In addition, hemicellulose, starch, sugar, tannins, and lignin, each to a varying degree, affect the cure rate and ultimate strength of these composites. To make strong and durable composites, measures must be taken to ensure long-term stability of the lignocellulosic in the cement matrix. To overcome these problems, various schemes have been developed. The most common is leaching, whereby the lignocellulosic is soaked in water for 1 or 2 days to extract some of the detrimental components. However, in some parts of the world, the water containing the leachate is difficult to dispose of. Low water-cement ratios are helpful, as is the use of curing accelerators like calcium carbonate. Conversely, low-alkali cements have been developed, but they are not readily available throughout the world. Two other strategies involve the use of natural pozzolans and carbon dioxide treatment.

Pozzolans—Pozzolans are defined as siliceous or siliceous and aluminous materials that can react chemically with calcium hydroxide (slaked lime) at normal temperatures in the presence of water to form cement compounds. Some common pozzolanic materials include volcanic ash, fly ash, rice husk ash, and condensed silica fume. All these materials can react with lime at normal temperatures to make a natural water-resistant cement.

In general, when pozzolans are blended with Portland cement, they increase the strength of the cement but slow the cure time. More importantly, pozzolans decrease the alkalinity of the product.

Carbon Dioxide Treatment—In the manufacture of a cement-bonded lignocellulosic composite, the cement hydration process normally requires from 8 to 24 h to develop sufficient board strength and cohesiveness to permit the release of consolidation pressure. By exposing the cement to carbon dioxide, the initial hardening stage can be reduced to less than 5 min. This phenomenon results from the chemical reaction of carbon dioxide with calcium hydroxide to form calcium carbonate and water.

Reduction of initial cure time of the cement-bonded lignocellulosic composite is not the only advantage of using carbon dioxide injection. Certain species of wood have various amounts of sugars and tannins that interfere with the hydration or setting of Portland cement. Research has shown that the use of carbon dioxide injection reduces the likelihood that these compounds will inhibit the hydration process,

thus allowing the use of a wider range of species. In addition, research has demonstrated that composites treated with carbon dioxide can be twice as stiff and strong as untreated composites (Geimer and others 1992). Finally, carbon-dioxide-treated composites do not experience efflorescence (migration of calcium hydroxide to surface of material), so the appearance of the surface of the final product is not changed over time.

Ceramic-Bonded Composite Materials

In the last few years a new class of inorganic binders, non-sintered ceramic inorganic binders, has been developed. These non-sintered ceramic binders are formed by an acid–base aqueous reaction between a divalent or trivalent oxide and an acid phosphate or phosphoric acid. The reaction slurry hardens rapidly, but the rate of setting can be controlled. With suitable selection of oxides and acid-phosphates, a range of binders may be produced. Recent research suggests that phosphates may be used as adhesives, cements, or surface augmentation materials to manufacture wood-based composites (Jeong and Wagh 2003, Wagh and Jeong 2003).

As adhesives, the reaction slurry resulting from the acid–base reaction may be used as an adhesive similar to the current polymer resins. Thus, phosphate adhesives can be used to coat individual fibers and form a composite by binding the fibers to each other. The adhesives will behave much like current polymer resins and may be used with existing equipment. The binder content is typically 15% to 20 % by weight.

As a cement, phosphate binders can be used to produce bulk composites. When conventional cement is used in fiber-based products, typical cement loading is approximately 30% or higher; phosphate cements may be used in a similar manner. The slurry formed by the acid–base reaction may be mixed with fiber or any other extender to produce solid composites (Jeong and Wagh 2003).

Phosphate binders may also be used for coating wood-based composite panels to enhance surface properties. The phosphate slurry is very smooth; thin (<1 mm) coatings can be applied, suitable for providing fire or water resistance.

Wood–Thermoplastic Composite Materials

In North America and Europe, wood elements have been combined with thermoplastics for several decades. However, it is only in the past decade that wood–thermoplastic composites have become a widely recognized commercial product in construction, automotive, furniture, and other consumer applications (Oksman Niska and Sain 2008). Commercialization in North America has been primarily due to penetration into the construction industry, first as decking and window profiles, followed by railing, siding, and roofing. Interior molding applications are also receiving attention. The automotive industry in Europe has been a leader

in using wood–thermoplastic composites for interior panel parts and is leading the way in developing furniture applications. Manufacturers in Asia are targeting the furniture industry, in addition to interior construction applications. Continued research and development will expand the available markets and each application will penetrate the global marketplace.

Materials

Broadly defined, a thermoplastic softens when heated and hardens when cooled. Thermoplastics selected for use with wood generally melt or soften at or below the thermal degradation temperature of the wood element, normally 200 to 220 °C (392 to 428 °F). These thermoplastics include polypropylene, polystyrene, vinyls, and low- and high-density polyethylenes.

The term wood–thermoplastic composites is broad, and the class of materials can include fibers derived from wood or other natural sources. Geographical location often dictates the raw material choice. In North America, wood is the most common raw material, in Europe natural fibers such as jute, hemp, and kenaf are preferred, while rice hull flour and bamboo fiber are typical in Asia. The wood is incorporated as either fiber bundles with low aspect ratio (wood flour) or as single fibers with higher aspect ratio (wood fiber). Wood flour is processed commercially, often from post-industrial materials such as planer shavings, chips, and sawdust. Several grades are available depending upon wood species and particle size. Wood fibers, although more difficult to process than wood flour, can lead to superior composite properties and act more as a reinforcement than as a filler. A wide variety of wood fibers are available from both virgin and recycled resources.

Other materials can be added to affect processing and product performance of wood–thermoplastic composites. These additives can improve bonding between the thermoplastic and wood component (for example, coupling agents), product performance (impact modifiers, ultraviolet (UV) light stabilizers, flame retardants), and processability (lubricants).

Wood–thermoplastic composites are of two main types. In the first type, the wood element serves as a reinforcing agent or filler in a continuous thermoplastic matrix. In the second type, the thermoplastic serves as a binder to the wood elements much like conventional wood-based composites. The presence or absence of a continuous thermoplastic matrix may also determine the processability of the composite material. In general, if the matrix is continuous, conventional thermoplastic processing equipment may be used to process composites; however, if the matrix is not continuous, other processes may be required. For the purpose of discussion, we present two scenarios—composites with high and low thermoplastic content.

Composite Materials with High Thermoplastic Content

The vast majority of commercially available wood–thermoplastic composites have high thermoplastic content. In composites with high thermoplastic content, the thermoplastic component is a continuous matrix and the wood element serves as a reinforcement or filler. The wood content is typically less than 60% by weight. In the great majority of reinforced thermoplastic composites available commercially, inorganic materials (for example, glass, clays, and minerals) are used as reinforcements or fillers. Wood-based materials offer some advantages over inorganic materials: they are lighter, much less abrasive, and renewable. Wood elements reinforce the thermoplastic by stiffening and strengthening and can improve thermal stability of the product compared with that of unfilled material.

The manufacture of thermoplastic composites is usually a two-step process. The raw materials are first mixed together in one step, and the composite blend is then formed into a product in the second step. The combination of these steps is called in-line processing, and the result is a single processing step that converts raw materials to end products. In-line processing can be very difficult because of control demands and processing trade-offs. As a result, it is often easier and more economical to separate the processing into a compounding step and a forming step (Clemons 2002).

Compounding is the feeding and dispersing of the wood element in a molten thermoplastic to produce a homogeneous material. Various additives are added and moisture is removed during compounding. Compounding may be accomplished using either batch mixers (for example, internal and thermokinetic mixers) or continuous mixers (for example, extruders and kneaders).

The compounded material can be immediately pressed or shaped into an end product while still in its molten state or pelletized into small, regular pellets for future reheating and forming. The most common types of product-forming methods for wood–thermoplastic composites involve forcing molten material through a die (sheet or profile extrusion) or into a cold mold (injection molding), or pressing in calenders (calendering) or between mold halves (thermoforming and compression molding). Most wood–thermoplastic composites in North America are formed using profile extrusion. Products such as decking, siding, railings, and window profiles readily lend themselves to extrusion through a two-dimensional die (Fig. 11–17). Injection-molded applications such as consumer household goods and furniture parts are gaining importance (Fig. 11–18). Thermoforming or compression molding is the forming method of choice for the automotive industry.

Several factors must be considered when processing wood with thermoplastics. Moisture can disrupt many thermoplastic processes, resulting in poor surface quality, voids, and unacceptable parts. Either materials must be



Figure 11–17. Extruded wood–thermoplastic composites being evaluated for a siding application (Clemons and Stark 2007).

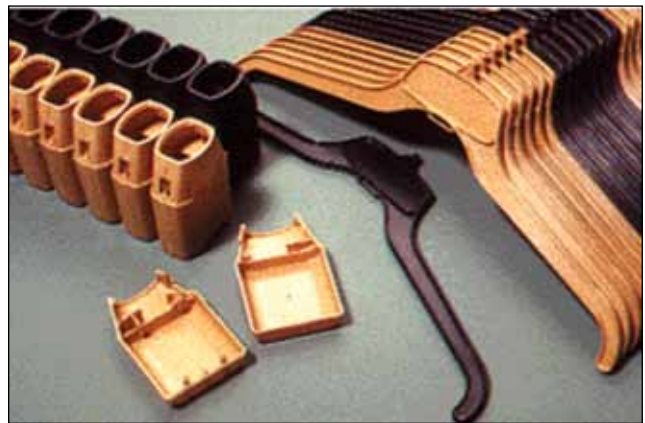

Figure 11–18. Injection-molded wood–thermoplastic composites in a variety of shapes and forms.

pre-dried or vented equipment must be used to remove moisture. The low thermal degradation temperature of wood must also be considered. As a general rule, melt temperatures should be kept below 200 °C (392 °F), except for short periods. Higher temperatures can result in the release of volatiles, discoloration, odor, and embrittlement of the wood component. Although processing wood flour in thermoplastics is relatively easy, the low bulk density and difficulty of dispersing fibrous materials in thermoplastics is more difficult. More intensive mixing and the use of special feeding equipment may be necessary to handle longer fibers.

Composite Materials with Low Thermoplastic Content

In composites with low thermoplastic content, the thermoplastic component is not continuous, acting more as a binder for the fiber much the same way as binders in conventional wood-based composites. Thermoplastic content is typically

Chapter 11 Wood-Based Composite Materials

less than 30% by weight. In their simplest form, lignocellulosic particles or fibers can be dry-blended with thermoplastic granules, flakes, or fibers and pressed into panel products. An alternative is to use the thermoplastic in the form of a textile fiber. The thermoplastic textile fiber enables a variety of lignocellulosics to be incorporated into a low-density, non-woven, textile-like mat. The mat may be a product in itself, or it may be consolidated into a high-density product.

Because the thermoplastic component remains molten when hot, different pressing strategies must be used than when thermosetting binders are used. Two options have been developed to accommodate these types of composites. In the first, the material is placed in the hot press at ambient temperature. The press then closes and consolidates the material, and heat is used to melt the thermoplastic component, which flows around the lignocellulosic component. The press is then cooled, “freezing” the thermoplastic so that the composite can be removed from the press. Alternatively, the material can be first heated in an oven or hot press. The hot material is then transferred to a cool press where it is quickly consolidated and cooled to make a rigid panel. Some commercial nonstructural wood–thermoplastic composite panels are made in this way.

Literature Cited

- AF&PA. 2006. Structural composite lumber & glued laminated timber awareness guide. Washington, DC: American Forest & Paper Association.
- AITC. 1996. Standard specifications for structural glued laminated timber of hardwood species. AITC 119. Centennial, CO: American Institute of Timber Construction.
- AITC. 2001. Standard appearance grades for structural glued laminated timber. AITC 110. Centennial, CO: American Institute of Timber Construction.
- AITC. 2004a. Standard specifications for structural glued laminated timber of softwood species. AITC 117. Centennial, CO: American Institute of Timber Construction.
- AITC. 2004b. Timber Construction Manual. American Institute of Timber Construction. 5th ed. New York: John Wiley & Sons.
- AITC. 2007a. Standard for wood products: structural glue-laminated timber. ANSI/AITC 190.1. Centennial, CO: American Institute of Timber Construction.
- AITC. 2007b. Standard for preservative treatment of structural glued laminated timber. AITC 109. Centennial, CO: American Institute of Timber Construction.
- ANSI. 2006. Structural glued laminated timber for utility structures. ANSI 05.2. New York: American National Standards Institute.
- ASTM. 2008a. ASTM D 3737–08. Standard practice for establishing allowable properties for structural glued laminated timber (glulam). Annual Book of ASTM Standards. Philadelphia, PA: American Society for Testing and Materials.
- ASTM. 2008b. ASTM D 5456–03. Standard specification for structural composite lumber. Annual Book of ASTM Standards. Philadelphia, PA: American Society for Testing and Materials.
- ASTM. 2008c. ASTM C 208–08a. Standard specification for cellulosic fiber insulating board. Annual Book of ASTM Standards. Philadelphia, PA: American Society for Testing and Materials.
- AWPA. 2007a. Commodity specification H: fire retardants. AWP Standard U–1: USS: User standard for treated wood. Birmingham, AL: American Wood Protection Association.
- AWPA. 2007b. Commodity specification F: wood composites. AWP Standard U–1: USS: User standard for treated wood. Birmingham, AL: American Wood Protection Association.
- Bowyer, J.L.; Shmulsky, R.; Haygreen, J.G. 2007. Forest Products and Wood Science. 5th ed. Ames, IA: Blackwell Publishing Professional. 558 p.
- Clemons, C.M. 2002. Wood-plastic composites in the United States: the interfacing of two industries. Forest Products Journal. 52(6): 10–18.
- Clemons, C.; Stark, N. 2007. Use of saltcedar and Utah juniper as fillers in wood-plastic composites. Res. Pap. FPL RP–641. Madison, WI: U.S. Department of Agriculture, Forest Service, Forest Products Laboratory. 17 p.
- CPA. 2004a. Basic hardboard. ANSI A 135.4–2004. Leesburg, VA: Composite Panel Association.
- CPA. 2004b. Prefinished hardboard paneling. ANSI A 135.5–2004. Leesburg, VA: Composite Panel Association.
- CPA. 2006. Hardboard siding. ANSI A 135.6–2006. Leesburg, VA: Composite Panel Association.
- CPA. 2009a. Particleboard. ANSI A 208.1–2009. Leesburg, VA: Composite Panel Association.
- CPA. 2009b. Medium density fiberboard (MDF). ANSI A 208.2–2009. Leesburg, VA: Composite Panel Association.
- Geimer, R.L.; Souza, M.R.; Moslemi, A.A.; Simatupang, M.H. 1992. Carbon dioxide application for rapid production of cement particleboard. In: Moslemi, A., ed. Proceedings, inorganic bonded wood and fiber composite materials conference. Spokane, WA. September 27–30, 1992.
- HPVA. 2004. American national standard for hardwood and decorative plywood. ANSI/HPVA HP–1–2004. Reston, VA: Hardwood Plywood & Veneer Association.
- IRC. 2009. International residential code for one- and two-family dwellings. Washington, DC: International Code Council.

- Jeong, S.; Wagh, A. 2003. Cementing the gap between ceramics, cements and polymers. *Materials Technology*. 18(3): 162–168.
- Jorge, F.C.; Pereira, C.; Ferreira, J.M.F. 2004. Wood-cement composites: a review. *Holz als Roh-und Werkstoff*. 62: 370–377.
- Kretschmann, D.E.; Winandy, J.; Clausen, C.; Wiemann, M.; Bergman, R.; Rowell, R.; Zerbe, J.; Beecher, J.; White, R.; McKeever, D.; Howard, J. 2007. Wood. In: *Kirk-Othmer Encyclopedia of Chemical Technology*. New York: John Wiley & Sons, Inc. 60 p.
- Maloney, T.M. 1986. Terminology and products definitions—a suggested approach to uniformity worldwide. In: *Proceedings, 18th international union of forest research organization world congress; September*. Ljubljana: Yugoslavia. IUFRO World Congress Organizing Committee.
- Maloney, T.M. 1993. *Modern particleboard and dry-process fiberboard manufacturing*. San Francisco, CA: Miller Freeman Publishing, Inc. 681 p.
- NIST. 2004. Voluntary product standard PS 2–04. Performance standard for wood-based structural-use panels. National Institute of Standards and Technology. Gaithersburg, MD: U.S. Department of Commerce.
- NIST. 2007. Voluntary product standard PS 1–07. Structural plywood. National Institute of Standards and Technology. Gaithersburg, MD: U.S. Department of Commerce.
- Oksman Niska, K.; Sain, M., eds. 2008. *Wood-polymer composites*. Cambridge, UK: Woodhead Publishing, Ltd. 384 p.
- Suchsland, O.; Woodson, G.E. 1986. Fiberboard manufacturing practices in the United States. *Agric. Handb.* 640. Washington, DC: U.S. Department of Agriculture. 263 p.
- Wagh, A.S.; Jeong, S.Y. 2003. Chemically bonded phosphate ceramics: I, a dissolution model of formation. *Journal of the American Ceramic Society*. 86(11): 1838–44.

Mechanical Properties of Wood-Based Composite Materials

Zhiyong Cai, Supervisory Research Materials Engineer

Robert J. Ross, Supervisory Research General Engineer

Contents

Elastic Properties 12–2
Modulus of Elasticity 12–2
Shear Modulus 12–3
Strength Properties 12–3
Panel Products 12–3
Plywood 12–3
Oriented Strandboard (OSB) 12–4
Particleboard 12–4
Hardboard 12–4
Medium-Density Fiberboard 12–5
Timber Elements/Structural Composite Lumber 12–5
Glued-Laminated Timber 12–5
Structural Composite Lumber 12–6
Wood–Nonwood Composites 12–7
Wood–Plastic Composite 12–7
Inorganic-Bonded Composites 12–9
Testing Standards 12–9
Literature Cited 12–10

The term *composite* is used to describe any wood material bonded together with adhesives. The current product mix ranges from fiberboard to laminated beams and components. In this chapter, wood-based composite materials are classified into the following categories: panel products (plywood, oriented strandboard (OSB), particleboard, fiberboard, medium-density fiberboard (MDF), hardboard); structural timber products (glued-laminated timber (glulam), laminated veneer lumber (LVL), laminated strand lumber, parallel strand lumber); and wood–nonwood composites (wood fiber–thermoplastics, inorganic-bonded composites).

Wood-based composites are used for a number of structural and nonstructural applications. Product lines include panels for both interior and exterior uses, furniture components, and support structures in buildings. Knowledge of the mechanical properties of these products is of critical importance to their proper use.

Wood-based composites are made from a wide range of materials—from fibers obtained from underutilized small-diameter or plantation trees to structural lumber. Regardless of the raw material used in their manufacture, wood-based composites provide uniform and predictable in-service performance, largely as a consequence of standards used to monitor and control their manufacture. The mechanical properties of wood composites depend upon a variety of factors, including wood species, forest management regimes (naturally regenerated, intensively managed), the type of adhesive used to bind the wood elements together, geometry of the wood elements (fibers, flakes, strands, particles, veneer, lumber), and density of the final product (Cai 2006).

A wide range of engineering properties are used to characterize the performance of wood-based composites. Mechanical properties are typically the most frequently used to evaluate wood-based composites for structural and nonstructural applications. Elastic and strength properties are the primary criteria to select materials or to establish design or product specifications. Elastic properties include modulus of elasticity (MOE) in bending, tension, and compression. Strength properties usually reported include modulus of rupture (MOR, bending strength), compression strength parallel to surface, tension strength parallel to surface, tension strength perpendicular to surface (internal bond strength), shear strength, fastener holding capacity, and hardness. Model

Table 12–1. Static bending properties of different wood and wood-based composites

Material	Specific gravity	Static bending properties			
		Modulus of elasticity		Modulus of rupture	
		GPa	($\times 10^6$ lb in ⁻²)	MPa	(lb in ⁻²)
Clear wood					
White oak	0.68	12.27	(1.78)	104.80	(15,200)
Red maple	0.54	11.31	(1.64)	92.39	(13,400)
Douglas-fir (Coastal)	0.48	13.44	(1.95)	85.49	(12,400)
Western white pine	0.38	10.07	(1.46)	66.88	(9,700)
Longleaf pine	0.59	13.65	(1.98)	99.97	(14,500)
Panel products					
Hardboard	0.9–1.0	3.10–5.52	(0.45–0.80)	31.02–56.54	(4,500–8,200)
Medium-density fiberboard	0.7–0.9	3.59	(0.52)	35.85	(5,200)
Particleboard	0.6–0.8	2.76–4.14	(0.40–0.60)	15.17–24.13	(2,200–3,500)
Oriented strandboard	0.5–0.8	4.41–6.28	(0.64–0.91)	21.80–34.70	(3,161–5,027)
Plywood	0.4–0.6	6.96–8.55	(1.01–1.24)	33.72–42.61	(4,890–6,180)
Structural timber products					
Glued-laminated timber	0.4–0.6	9.00–14.50	(1.30–2.10)	28.61–62.62	(4,150–9,080)
Laminated veneer lumber	0.4–0.7	8.96–19.24	(1.30–2.79)	33.78–86.18	(4,900–12,500)
Wood–nonwood composites					
Wood plastic		1.53–4.23	(0.22–0.61)	25.41–52.32	(3,684–7,585)

building codes in the United States stipulate that plywood used for structural applications such as subflooring and sheathing must meet the requirements of certain U.S. Department of Commerce standards. Voluntary Product Standard PS 1–07 for construction and industrial plywood (NIST 2007) and Performance Standard PS 2–04 for wood-based structural-use panels (NIST 2004) spell out the ground rules for manufacturing plywood and establishing plywood or OSB properties, respectively. These standards have evolved over time from earlier documents (O’Halloran 1979, 1980; APA 1981) and represent a consensus opinion of the makers, sellers, and users of plywood products as well as other concerned parties.

Many of the questions that arise with wood-based composites have to do with their mechanical properties, especially how properties of one type of material compare with those of clear wood and other wood products. Although an extensive review that compares all properties of wood-based materials and products is beyond the scope of this chapter, Table 12–1 provides some insight to how static bending properties of these materials vary and how their properties compare with those of solid, clear wood. Although the mechanical properties of most wood composites might not be as high as those of solid wood, they provide very consistent and uniform performance.

The mechanical property data presented in this chapter were obtained from a variety of reports of research conducted to develop basic property information for a wide range of wood-based composite materials. The wood-based composites industry is very dynamic, with changes occurring frequently in the manufacture of these materials and corresponding changes in design information. Consequently,

this chapter primarily focuses on presenting fundamental mechanical property information for wood-based composite materials. *For design procedures and values, the reader is encouraged to contact the appropriate industry trade association or product manufacturers. Current design information can be readily obtained from their websites, technical handbooks, and bulletins.*

The organization of this chapter follows closely that of Chapter 5. Basic mechanical property information is presented following a brief background discussion of these products. A discussion of performance and testing standards covering their manufacture and use is also presented.

Elastic Properties

Modulus of Elasticity

Elasticity implies that deformations produced by low stress below the proportional limit are completely recoverable after loads are removed. When loaded to stress levels above the proportional limit, plastic deformation or failure occurs. Typically, the stress–strain curve for wood-based composites is linear below the proportional limit. The slope of the linear curve is the MOE. In compression or tensile tests, this slope is sometime referred to as Young’s modulus to differentiate it from bending MOE. Bending MOE is a measure of the resistance to bending deflection, which is relative to the stiffness. Young’s modulus is a measure of resistance to elongation or shortening of a member under tension or compression. The procedure to determine MOE is fully described in ASTM D 1037 for fiber- and particle-based panel products, ASTM D 3043 for structural wood-based panels, ASTM D 5456 for structural composite lumber products,

ASTM D 7031 for wood–plastic composites, and ASTM D 7341 for glulam products.

Shear Modulus

Shear modulus, also called modulus of rigidity, indicates the resistance to deflection of a member caused by shear stresses. Shear stress is different from tension or compression stress in that it tends to make one side of a member slip past the other side of a member adjacent to it. There are two main types of shear in different planes of wood-based panels: interlaminar shear and edgewise shear or shear through-the-thickness. Interlaminar shear is also commonly called planar shear (or rolling shear, or horizontal shear) in plywood panels to describe stress that acts between the veneers that are glued with grain direction in adjacent pieces perpendicular to one another. For example, when the plywood panel is loaded in the middle with its two ends simply supported, the layers or veneers tend to slip horizontally past each other as the panel bends. The glue-bonding between the laminates of veneers resists the slipping and often dictates the panel stiffness. Edgewise shear is also commonly called racking shear. The moduli of rigidity vary within and between species, resin application, moisture content, and specific gravity. The procedure to determine different shear moduli for fiber- and particle-based panels is described in ASTM D 1037 and for structural panels in ASTM D 3044.

Strength Properties

Strength refers to the maximum stress that can be developed in a member due to applied loads prior to failure. Mechanical properties most commonly measured and represented as “strength properties” for design include modulus of rupture in bending, tension strength parallel-to-surface, tension strength perpendicular-to-surface, compression strength parallel-to-surface, shear strength, fastener holding strength, and hardness. Strength tests are typically made on specimens at moisture equilibrium under prescribed conditions or after soaking. The procedures to determine strengths for wood-based composites are described in ASTM D 1037, ASTM D 3044, ASTM D 5456, ASTM D 3737, and ASTM D 7031.

Modulus of rupture reflects the maximum load-carrying capacity of a member in bending and is proportional to maximum moment borne by the specimen. Modulus of rupture is an accepted measure of strength, although it is not a true stress because the formula by which it is computed is valid only to the elastic limit (McNatt 1973).

Tension strength parallel-to-surface is the maximum stress sustained by a specimen from a test with tension forces applied parallel to the surface. Tests are made with the long dimension of the specimen cut both parallel and perpendicular to the long dimension of the board to determine the strength in each of the primary panel directions.

Tension strength perpendicular-to-surface (internal bond strength) is the maximum stress sustained by a specimen from a test with tension forces applied perpendicular to the surface. Tests are made on specimens in the dry condition to determine the resistance of the specimen to delamination or splitting in the direction perpendicular to the plane of the board.

Compression strength parallel-to-surface is the maximum stress sustained by a specimen from a test with compression forces applied parallel to the surface. Tests are made with the long dimension of the specimen cut both parallel and perpendicular to the long dimension of the board to determine the material’s resistance to crushing in each of the primary panel directions.

Interlaminar shear (planar shear) indicates the ability to resist internal slipping of one layer upon another within the panel. It is used to describe the glue line or bonding performance inside or between the test materials.

Hardness is measured as resistance to indentation using a modified Janka hardness test, measured by the load required to embed an 11.3-mm (0.444-in.) diameter ball to one-half its diameter.

Fastener holding strength is the maximum resistance to separate or withdraw a fastener in a plane normal to the testing face. It usually contains three tests: nail withdrawal, nail-head pull-through, and direct screw withdrawal.

Panel Products

Plywood

Plywood is separated into two general classes: (a) construction and industrial plywood and (b) hardwood and decorative plywood. Construction and industrial plywood are covered by Product Standard PS 1–07 (NIST 2007), and hardwood and decorative plywood are covered by American National Standard ANSI/HPVA–1–2004 (HPVA 2004). Each standard recognizes different exposure durability classifications, which are primarily based on moisture resistance of the adhesive and the grade of veneer used. In addition, model building codes require that plywood manufacturers be inspected and their products certified for conformance to PS 1–07, PS 2–04, APA PRP–108, or TECO PRP–133 (TECO 1991) by qualified independent third-party agencies on a periodic unannounced basis. With PS 1–07, as long as a plywood panel is manufactured using the veneer grades, adhesive, and construction established in the standard’s prescriptive requirements, the panel is by definition acceptable.

All hardwood plywood represented as conforming to American National Standard ANSI/HPVA–1–2004 (HPVA 2004) is identified by one of two methods: by marking each panel with the Hardwood Plywood & Veneer Association (HPVA) plywood grade stamp or by including a written statement with this information with the order or shipment.

Table 12–2. Selected properties of plywood sheathing products^a

Species	Specific gravity	Static bending									
		MOE		MOR		Fiber stress at proportional limit		Rail shear strength		Glue line shear strength	
		GPa	($\times 10^6$ lb in ⁻²)	MPa	(lb in ⁻²)	GPa	(lb in ⁻²)	MPa	(lb in ⁻²)	MPa	(lb in ⁻²)
Baldcypress	0.50	7.58	(1.10)	39.23	(5,690)	29.4	(4,260)	5.6	(805)	2.7	(389)
Douglas-fir	0.53	7.45	(1.08)	41.37	(6,000)	39.3	(5,700)	3.8	(556)	1.4	(207)
Lauan	0.44	7.43	(1.08)	33.72	(4,890)	28.1	(4,070)	4.3	(628)	1.3	(192)
Western redcedar	0.41	8.55	(1.24)	37.37	(5,420)	33.3	(4,830)	4.6	(674)	1.7	(240)
Redwood	0.41	6.96	(1.01)	42.61	(6,180)	37.4	(5,420)	5.3	(769)	1.5	(220)
Southern Pine	0.57	7.70	(1.12)	37.09	(5,380)	26.2	(3,800)	5.5	(800)	1.6	(233)

^aFrom Biblis (2000).

If design calculations are desired, a design guide is provided by the APA–The Engineered Wood Association in *Plywood Design Specification* (PDS) and APA Technical Note N375B (APA 1995a,b). The design guide contains tables of grade stamp references, section properties, and allowable stresses for plywood used in construction of buildings and similar structures. Table 12–2 shows selected properties of various species of plywood.

Oriented Strandboard (OSB)

Oriented strandboard is an engineered, structural-use panel manufactured from thin wood strands bonded together with water-resistant adhesive under heat and pressure. It is used extensively for roof, wall, and floor sheathing in residential and commercial construction. Design capacities of performance-rated products, which include OSB and waferboard, can be determined by using procedures outlined in Technical Note N375B (APA 1995a). In this reference, allowable design strength and stiffness properties, as well as nominal thickness and section properties, are specified based on the span rating of the panel. Additional adjustment factors based on panel grade and construction are also provided. Table 12–3 shows selected properties of OSB obtained from the literature.

Under PS 2–04, a manufacturer is required to enter into an agreement with an accredited testing agency to demonstrate that its panels conform to the requirements of the chosen standard. The manufacturer must also maintain an in-plant quality control program in which panel properties are regularly checked, backed by a quality assurance program administered by an independent third-party. The third-party agency must visit the mill on a regular unannounced basis. The agency must confirm that the in-plant quality control program is being maintained and that panels meet the minimum requirements of the standard.

Particleboard

Particleboard is typically made in three layers. The faces of the board consist of fine wood particles, and the core is

made of the coarser material (Chap. 11). Particleboard is used for furniture cores and case goods, where it is typically overlaid with other materials for decorative purposes. Particleboard can be used in flooring systems, in manufactured houses, for stair treads, and as underlayment. Requirements for grades of particleboard and particleboard flooring products are specified by the American National Standard for Particleboard A208.1-1999 (CPA 1999). Table 12–4 represents some of selected properties of different particleboard manufacturers.

Hardboard

Basic hardboard physical properties for selected products are presented in ANSI A135.4–2004 (CPA 2004a). The uses for hardboard can generally be grouped as construction, furniture and furnishings, cabinet and store work, appliances, and automotive and rolling stock. Typical hardboard products are prefinished paneling (ANSI A135.5–2004 (CPA 2004b)), house siding (ANSI A135.6–2006 (CPA 2006)), floor underlayment, and concrete form board. Table 12–5 shows selected physical and mechanical properties of hardboard from different manufacturers. Hardboard siding products come in a great variety of finishes and textures (smooth or embossed) and in different sizes. For application purposes, the Composite Panel Association (CPA) classifies siding into three basic types:

Lap siding—boards applied horizontally, with each board overlapping the board below it

Square edge panels—siding intended for vertical application in full sheets

Shiplap edge panel siding—siding intended for vertical application, with the long edges incorporating shiplap joints

The type of panel dictates the application method. The CPA administers a quality conformance program for hardboard for both panel and lap siding. Participation in this program is voluntary and is open to all (not restricted to CPA members). Under this program, hardboard siding products are

Table 12–3. Selected properties of oriented strandboard (OSB) products

Reference	Species	Mill no.	Specific gravity	Bending MOE				Bending MOR				Internal bond	
				Parallel		Perpendicular		Parallel		Perpendicular			
				GPa	($\times 10^6$ lb in ⁻²)	GPa	($\times 10^6$ lb in ⁻²)	MPa	(lb in ⁻²)	MPa	(lb in ⁻²)	MPa	(lb in ⁻²)
Biblis (1989)	Southern Pine	1	0.80	4.41	(0.640)	2.89	(0.419)	23.8	(3,445)	24.2	(3,515)	0.57	(83)
		2	0.70	4.78	(0.694)	2.61	(0.378)	26.0	(3,775)	22.1	(3,205)	0.28	(41)
		3	0.68	5.75	(0.834)	3.17	(0.460)	32.0	(4,645)	23.8	(3,445)	0.32	(47)
Pu and others (1992)	Southern Pine	4	0.51	4.41	(0.640)	2.40	(0.348)	21.8	(3,161)	25.4	(3,685)	0.23	(34)
		5	0.60	5.67	(0.822)	2.61	(0.378)	27.8	(4,039)	27.1	(3,925)	0.28	(41)
	Aspen	6	0.58	4.41	(0.640)	2.97	(0.431)	23.9	(3,473)	28.7	(4,165)	0.26	(38)
		7	0.65	6.28	(0.911)	2.03	(0.294)	32.2	(4,672)	30.4	(4,405)	0.43	(62)
		8	0.66	5.69	(0.825)	1.92	(0.278)	31.6	(4,584)	32.0	(4,645)	0.41	(60)
		9	0.74	6.31	(0.915)	2.79	(0.404)	34.7	(5,027)	33.7	(4,885)	0.34	(50)
Wang and others (2003a)	Southern Pine	10	0.63	5.01	(0.726)	2.26	(0.327)	30.2	(4,379)	16.8	(2,436)	0.36	(52)
		11	0.66	5.30	(0.769)	2.32	(0.336)	28.1	(4,075)	14.4	(2,088)	0.43	(62)
		12	0.67	5.12	(0.742)	2.56	(0.371)	30.7	(4,452)	21.1	(3,060)	0.32	(46)
		13	0.66	4.91	(0.712)	2.24	(0.325)	28.3	(4,104)	19.8	(2,871)	0.38	(55)
	Hardwood mixture	14	0.68	5.15	(0.747)	1.77	(0.257)	26.9	(3,901)	11.8	(1,711)	0.28	(40)
		15	0.67	5.87	(0.851)	1.40	(0.204)	33.9	(4,916)	7.8	(1,131)	0.23	(33)
	Aspen	16	0.70	6.73	(0.976)	2.25	(0.326)	36.9	(5,351)	15.8	(2,291)	0.45	(66)
		17	0.63	6.50	(0.943)	3.10	(0.450)	38.0	(5,510)	21.5	(3,118)	0.28	(41)
		18	0.62	7.90	(1.146)	3.10	(0.450)	38.8	(5,626)	23.2	(3,364)	0.46	(66)
		19	0.61	6.10	(0.885)	2.50	(0.363)	30.7	(4,452)	19.7	(2,857)	0.34	(49)
20		0.61	6.50	(0.943)	1.80	(0.261)	35.5	(5,148)	13.7	(1,987)	0.25	(36)	
21	0.66	6.75	(0.979)	2.45	(0.356)	37.3	(5,409)	19.3	(2,799)	0.38	(55)		
22	0.63	5.80	(0.840)	2.40	(0.348)	26.9	(3,901)	17.9	(2,596)	0.40	(58)		

Table 12–4. Selected properties of industrial particleboard products^a

Mill	Moisture content (%)	Specific gravity	Static bending properties				Tensile properties				Internal bond	
			Modulus of elasticity		Modulus of rupture		Modulus of elasticity		Ultimate tensile stress			
			GPa	($\times 10^6$ lb in ⁻²)	MPa	(lb in ⁻²)	GPa	($\times 10^6$ lb in ⁻²)	MPa	(lb in ⁻²)	MPa	(lb in ⁻²)
A	8.7	0.71	3.0	(0.44)	16.8	(2,430)	2.2	(0.32)	7.72	(1,120)	0.79	(115)
B	9.1	0.72	3.5	(0.51)	20.6	(2,990)	2.6	(0.38)	9.38	(1,360)	1.07	(155)
C	9.8	0.76	3.5	(0.51)	18.9	(2,740)	2.3	(0.34)	8.27	(1,200)	1.00	(145)
H	8.0	0.77	4.0	(0.58)	22.8	(3,310)	3.0	(0.44)	10.89	(1,580)	1.17	(170)
J	8.5	0.72	3.0	(0.43)	17.2	(2,500)	1.9	(0.28)	7.45	(1,080)	0.45	(65)
K	9.1	0.68	2.8	(0.40)	15.2	(2,206)	1.6	(0.23)	5.58	(810)	0.31	(45)
L	9.3	0.62	3.2	(0.46)	17.0	(2,470)	1.8	(0.26)	6.69	(970)	0.48	(70)
M	9.7	0.65	3.6	(0.52)	18.9	(2,740)	2.2	(0.32)	8.07	(1,170)	0.69	(100)
N	8.3	0.60	3.1	(0.45)	17.0	(2,470)	3.7	(0.54)	8.00	(1,160)	0.31	(45)

^aFrom McNatt (1973).

tested by an independent laboratory in accordance with product standard ANSI A135.6.

Medium-Density Fiberboard

Minimum property requirements for MDF are specified by the American National Standard for MDF, ANSI A208.2-2002 (CPA 2002), and some of selected properties are given in Table 12–6 from different manufacturers. Medium-density fiberboard is frequently used in furniture applications. It is also used for interior door skins, moldings, flooring

substrate, and interior trim components (Cai and others 2006, Youngquist and others 1993).

Timber Elements/Structural Composite Lumber

Glued-Laminated Timber

Structural glued-laminated timber (glulam) is an engineered, stress-rated product that consists of two or more layers of lumber that are glued together with the grain of all layers,

Table 12–5. Selected properties of hardboard products^a

Mill	Type of hardboard	Moisture content (%)	Specific gravity	Modulus of elasticity		Modulus of rupture		Ultimate tensile stress		Internal bond	
				GPa	($\times 10^6$ lb in ⁻²)	MPa	(lb in ⁻²)	MPa	(lb in ⁻²)	MPa	(lb in ⁻²)
A	1/8-in.	4.6	0.9	3.83	(556)	31.44	(4,560)	23.24	(3,370)	1.24	(180)
B	standard	6.5	1.02	4.36	(633)	33.92	(4,920)	23.17	(3,360)	2.76	(400)
C		5.2	0.94	4.20	(609)	45.85	(6,650)	37.58	(5,450)	2.17	(315)
D		5.6	0.9	3.32	(482)	38.75	(5,620)	28.61	(4,150)	1.55	(225)
E		6.5	0.95	3.55	(515)	47.50	(6,890)	32.96	(4,780)	3.52	(510)
F		7.7	0.91	3.23	(468)	37.85	(5,490)	25.72	(3,730)	1.93	(280)
B	1/4-in.	6.4	1.02	4.45	(645)	33.85	(4,910)	22.61	(3,280)	1.86	(270)
E	standard	6.0	0.90	3.88	(563)	38.96	(5,650)	23.65	(3,430)	1.65	(240)
A	1/4-in. tempered	4.9	0.99	5.30	(768)	53.02	(7,690)	31.58	(4,580)	1.79	(260)
F	1/4-in. tempered	6.9	0.98	5.14	(745)	55.57	(8,060)	30.61	(4,440)	1.86	(270)

^aFrom McNatt and Myers (1993).

Table 12–6. Selected properties of medium-density fiberboard products^a

Mill no.	Density (g cm ⁻³)	Modulus of rupture		Modulus of elasticity		Internal bond		Screw-holding edge		Capacity face	
		MPa	(lb in ⁻²)	GPa	($\times 10^6$ lb in ⁻²)	MPa	(lb in ⁻²)	kg	(lb)	kg	(lb)
1	0.73	33.6	(4,873)	3.21	(466)	0.86	(125)	117	(257)	148	(326)
2	0.90	34.0	(4,932)	3.97	(576)	0.94	(136)	147	(325)	185	(407)
3	0.79	23.2	(3,366)	2.98	(432)	1.94	(282)	150	(330)	202	(445)
4	0.82	39.3	(5,703)	4.38	(635)	0.83	(121)	114	(252)	148	(326)
5	0.95	24.6	(3,565)	3.56	(517)	0.92	(133)	184	(405)	231	(509)
6	0.80	36.4	(5,278)	3.99	(578)	0.71	(103)	143	(315)	183	(404)
7	0.77	37.4	(5,421)	3.94	(572)	1.23	(179)	163	(360)	210	(464)
8	0.71	35.2	(5,107)	3.34	(485)	1.09	(158)	147	(324)	189	(416)

^aFrom Suchsland and others (1979).

which are referred to as laminations, parallel to the length. Table 12–7 provides some selected properties of glulam products from different research studies.

Douglas–Fir–Larch, Southern Pine, yellow-cedar, Hem–Fir, and Spruce–Pine–Fir are commonly used for glulam in the United States. Nearly any species can be used for glulam timber, provided its mechanical and physical properties are suitable and it can be properly glued. Industry standards cover many softwoods and hardwoods, and procedures are in place for using other species.

Manufacturers of glulam timber have standardized the target design values in bending for beams. For softwoods, these design values are given in “Standard for Wood Products: Structural Glued-Laminated Timber” (AITC 2007). This specification contains design values and recommended modification of stresses for the design of glulam timber members in the United States. The *National Design Specification for Wood Construction* (NDS) summarizes the design information in ANSI/AITC 190.1 and defines the practice to be

followed in structural design of glulam timbers (AF&PA 2005). APA–The Engineered Wood Association has also developed design values for glulam under National Evaluation Report 486, which is recognized by all the building codes.

Structural Composite Lumber

Structural composite lumber (SCL) products are characterized by smaller pieces of wood glued together into sizes common for solid-sawn lumber. One type of SCL product is manufactured by laminating veneer with all plies parallel to the length. This product is called laminated veneer lumber (LVL) and consists of specially graded veneer. Another type of SCL product consists of strands of wood or strips of veneer glued together under high pressures and temperatures. Depending upon the component material, this product is called laminated strand lumber (LSL), parallel strand lumber (PSL), or oriented strand lumber (OSL).

In contrast with sawn lumber, the strength-reducing characteristics of SCL are dispersed within the veneer or strands and have much less of an effect on strength properties. Thus,

Table 12–7. Selected properties of glulam products

Reference	Species	Moisture content (%)	Number of laminations	Static bending properties			
				Modulus of elasticity		Modulus of rupture	
				GPa	($\times 10^6$ lb in ⁻²)	MPa	(lb in ⁻²)
Manbeck and others (1993)	Red maple	12	8	12.3	(1.78)	62.6	(9,080)
		12	12	12.2	(1.77)	55.0	(7,980)
		12	16	12.3	(1.78)	54.2	(7,860)
Moody and others (1993)	Yellow poplar	8.2	8	13.0	(1.89)	55.6	(8,060)
		7.5	12	13.4	(1.94)	52.1	(7,560)
		8	17	12.3	(1.79)	45.3	(6,570)
Shedlauskus and others (1996)	Red oak	12.8	8	13.0	(1.88)	60.5	(8,770)
		11.1	18	12.8	(1.86)	46.0	(6,670)
Janowiak and others (1995)	Red maple	12.6	12	12.2	(1.77)	55.0	(7,980)
		8.9	5	12.8	(1.86)		
		8.9	5	12.9	(1.87)	45.7	(6,630)
Hernandez and others (2005)	Ponderosa pine	8.8	8	9.44	(1.37)	31.4	(4,560)
		8.8	13	9.07	(1.32)	29.6	(4,290)
Hernandez and Moody (1992)	Southern Pine	—	10	14.1	(2.04)	61.7	(8,950)
		—	17	13.5	(1.96)	49.8	(7,230)
Marx and Moody (1981 a,b)	Southern Pine	10	4, 8, 10	11.2	(1.63)	46.5	(6,740)
		10	4, 8, 11	10.8	(1.56)	33.9	(4,920)
	Douglas-fir–larch	11	4, 8, 12	13.9	(2.02)	47.2	(6,840)
		11	4, 8, 13	13.6	(1.97)	40.7	(5,910)
Moody (1974)	Southern Pine	11.8	17	9.3	(1.35)	28.6	(4,150)
		11.9	17	10.3	(1.49)	31.4	(4,560)

relatively high design values can be assigned to strength properties for both LVL and PSL. Whereas both LSL and OSB have somewhat lower design values, they have the advantage of being produced from a raw material that need not be in a log size large enough for peeling into veneer.

All types of SCL products can be substituted for sawn lumber products in many applications. Laminated veneer lumber is used extensively for scaffold planks and in the flanges of prefabricated I-joists. Both LVL and PSL beams are used as headers and major load-carrying elements in construction. The LSL and OSB products are used for band joists in floor construction and as substitutes for studs and rafters in wall and roof construction. Various types of SCL are also used in a number of nonstructural applications, such as the manufacture of windows and doors. Table 12–8 provides some selected properties of LVL products from different research studies.

Wood–Nonwood Composites

Wood–Plastic Composite

The use of wood–plastic composite lumber in North America has experienced tremendous growth in the past decade, largely because of residential construction applications.

Common applications in North America include decking, railings, window profiles, roof tiles, and siding. These lumber products are generally manufactured using profile extrusion. Some generalizations can be made regarding the performance of wood–plastic composites, but there are exceptions. Flexural and tensile properties of wood–plastic composite lumber generally fall between those of solid wood lumber and unfilled plastics. Most commercial wood–plastic composites are considerably less stiff than solid wood but are stiffer than unfilled plastic (Clemons 2002). Compared with solid wood lumber, wood–plastic composites have better decay resistance and dimensional stability when exposed to moisture. Compared with unfilled plastics, wood–plastic composites are stiffer and have better dimensional stability when exposed to changes in temperature.

Table 12–9 shows mechanical properties of unfilled polypropylene and several wood–polypropylene composites. One of the primary reasons to add wood filler to unfilled plastics is to improve stiffness. Strength of the unfilled plastic can also increase but only if the wood component acts as reinforcement with good bonding between the two components. Table 12–9 illustrates how wood–plastic composite properties can vary with changing variables. For example, adding wood fiber instead of wood flour to polypropylene

Table 12-8. Selected properties of laminated veneer lumber for structural composite lumber products

Reference	Species	Static bending properties						Tensile properties				
		Modulus of elasticity			Modulus of rupture			Modulus of elasticity		Ultimate tensile stress		
		Edge	Flat	Edge	Flat	Edge	Flat	GPa	MPa	($\times 10^6$) lb in ⁻²	MPa	(lb in ⁻²)
		($\times 10^6$) GPa	($\times 10^6$) lb in ⁻²	MPa	(lb in ⁻²)	MPa	(lb in ⁻²)	GPa	MPa	($\times 10^6$) lb in ⁻²	MPa	(lb in ⁻²)
Bohlen (1974)	Douglas-fir	—	—	—	—	—	—	15.2	28.99	(2.20)	28.99	(4,205)
Youngquist and others (1984)	Douglas-fir	—	—	—	—	—	—	14.0–15.0	28.1–39.0	(2.03–2.17)	28.1–39.0	(4,080–5,650)
								11.1–12.4	18.3–38.1	(1.61–1.80)	18.3–38.1	(2,660–5,520)
Jung (1982)	Douglas-fir	15.5–19.2	(2.25–2.79)	15.4–19.3	(2.23–2.80)	58.0–71.7	(8,420–10,400)	15.6–20.3	37.9–46.2	(2.27–2.94)	37.9–46.2	(5,500–6,700)
Kunesh (1978)	Douglas-fir	15.9	(2.31)	16.1	(2.34)	—	—	14.1	44.4	(2.04)	44.4	(6,435)
Koch (1973)	Southern Pine	13.2	(1.91)	0.0	0.00	64.2	(9,310)	—	—	—	—	—
Moody (1972)	Douglas-fir	—	—	—	—	—	—	14.3	37.6	(2.07)	37.6	(5,450)
	Southern Pine	—	—	—	—	—	—	13.5	34.6	(1.96)	34.6	(5,025)
Moody and Peters (1972)	Southern Pine	14.1	(2.04)	14.7	(2.13)	80.8	(11,720)	86.0	—	—	—	—
Wang and others (2003b)	Red maple	10.8	(1.56)	11.3	(1.64)	83.3	(12,081)	—	—	—	—	—
Hindman and others (2006)	Southern Pine	15.8	(2.29)	17.4	(2.54)	—	—	—	—	—	—	—
Kretschmann and others (1993)	Douglas-fir	9.0–12.8	(1.30–1.86)	9.0–13.7	(1.30–1.98)	37.9–67.9	(5,500–9,850)	8.5–12.8	20.8–49.1	(1.24–1.86)	20.8–49.1	(3,020–7,100)
	Southern Pine	9.8–13.7	(1.34–1.98)	8.8–13.0	(1.27–1.89)	51.9–70.3	(7,530–10,190)	9.6–13.6	36.6–51.2	(1.39–1.97)	36.6–51.2	(5,310–7,430)

Table 12–9. Selected properties of wood–plastic products^a

Composite	Specific gravity	Tensile properties				Flexural properties				Izod impact energy (J m ⁻¹)	
		Strength		Modulus		Strength		Modulus		Notched	Unnotched
		MPa	(lb in ⁻²)	GPa	(×10 ⁶ lb in ⁻²)	MPa	(lb in ⁻²)	GPa	(×10 ⁶ lb in ⁻²)		
Polypropylene (PP)	0.90	28.5	(4,134)	1.53	(0.22)	38.30	(5,555)	1.19	(0.17)	20.9	656
PP + 40% wood flour	1.05	25.4	(3,684)	3.87	(0.56)	44.20	(6,411)	3.03	(0.44)	22.2	73
PP + 40% wood flour + 3% coupling agent	1.05	32.3	(4,685)	4.10	(0.59)	53.10	(7,702)	3.08	(0.45)	21.2	78
PP + 40% wood fiber	1.03	28.2	(4,090)	4.20	(0.61)	47.90	(6,947)	3.25	(0.47)	23.2	91
PP + 40% wood fiber + 3% coupling agent	1.03	52.3	(7,585)	4.23	(0.61)	72.40	(10,501)	3.22	(0.47)	21.6	162

^aFrom Stark and Rowlands (2003).

improved the strength and stiffness. Generally, adding a coupling agent to the mix also improved mechanical properties. Adding wood to polypropylene was not without tradeoffs. Impact resistance of such composites decreased compared with that of unfilled polypropylene.

In addition to these commercial deck products, wood–plastic composites are being developed for structural applications such as foundation elements, deck substructures, industrial decking, and shoreline structures (Bender and others 2006). Table 12–10 shows the range of average mechanical properties of extruded wood–plastic composites by polymer type. In general, polyvinylchloride and polyethylene formulations produce higher mechanical properties than those produced from polyethylene alone. Formulations that use coupling agents with either polypropylene or high-density polyethylene result in improved strength, stiffness, and reduced moisture absorption properties.

Properties of wood–plastic composites can vary greatly depending upon such variables as type, form, weight fractions of constituents, type of additives, and processing methods (Stark and Rowlands 2003, Wolcott and others 2006). Because formulations from each commercial manufacture are proprietary, design data should be obtained directly from the manufacturer.

Inorganic-Bonded Composites

Inorganic-bonded wood composites are molded products or boards that contain between 10% and 70% by weight wood particles or fibers and conversely 90% to 30% inorganic binder. Acceptable properties of an inorganic-bonded wood composite can be obtained only when the wood particles are fully encased with the binder to make a coherent material. This differs considerably from the technique used to manufacture thermosetting-resin-bonded boards, where flakes or

particles are “spot welded” by a binder applied as a finely distributed spray or powder. Because of this difference and because hardened inorganic binders have a higher density than that of most thermosetting resins, the required amount of inorganic binder per unit volume of composite material is much higher than that of resin-bonded wood composites. The properties of inorganic-bonded wood composites are significantly influenced by the amount and nature of the inorganic binder and the woody material as well as the density of the composites.

Inorganic binders fall into three main categories: gypsum, magnesia cement, and Portland cement. Gypsum and magnesia cement are sensitive to moisture, and their use is generally restricted to interior applications. Composites bonded with Portland cement are more durable than those bonded with gypsum or magnesia cement and are used in both interior and exterior applications. Inorganic-bonded composites are made by blending proportionate amounts of lignocellulosic fiber with inorganic materials in the presence of water and allowing the inorganic material to cure or “set up” to make a rigid composite. All inorganic-bonded composites are very resistant to deterioration, particularly by insects, vermin, and fire. Typical properties of low-density cement-wood composite fabricated using an excelsior-type particle are shown in Table 12–11.

Testing Standards

The physical and mechanical properties of wood-based composite materials are usually determined by standard ASTM test methods. The following are the commonly used methods described in ASTM (2009):

ASTM C 208–08. Standard specification for cellulosic fiber insulating board.

Table 12–10. Selected properties of extruded wood–plastic products

Composite	Tensile strength (MPa (lb in ⁻²))	Compression strength (MPa (lb in ⁻²))	Bending strength (GPa (×10 ⁶ lb in ⁻²))	Bending modulus (MPa (lb in ⁻²))	Shear strength (MPa (lb in ⁻²))	Dowel bearing strength (MPa (lb in ⁻²))
Polypropylene (PP) ^{a, b}	20.0 (2,900)	55.2 (8,000)	3.49–5.97 (0.506–0.866)	22.2–60.8 (3,220–8,820)	22.0 (3,190)	84.8 (12,300)
High-density polyethylene (HDPE) ^c	5.5–15.2 (800–2,200)	11.7–26.9 (1,700–3,900)	1.79–5.17 (0.260–0.750)	10.3–25.5 (1,500–3,700)	7.79–10.3 (1,130–1,500)	35.7 (5,180)
Polyvinylchloride (PVC) ^c	25.1 (3,640)	61.2 (8,880)	4.81–7.58 (0.697–1.100)	35.9–54.5 (5,200–7,900)	20.2 (2,930)	72.4–128.2 (10,500–18,600)

^aFrom Slaughter (2004).^bFrom Kobbe (2005).^cFrom Wolcott (2001).**Table 12–11. General properties of low-density cement–wood composite fabricated using an excelsior-type particle^{a, b}**

Property	Value range (MPa (lb in ⁻²))	
	Low	High
Bending strength	1.7 (250)	5.5 (800)
Modulus of elasticity	621 (90,000)	1,241 (180,000)
Tensile strength	0.69 (100)	4.1 (600)
Compression strength	0.69 (100)	5.5 (800)
Shear ^c	0.69 (100)	1.4 (200)
<i>E/G</i> ratio ^d	40.0	100.0

^aData present compilation of raw data from a variety of sources for range of board properties. Variables include cement–wood mix, particle configuration, density, and forming and curing method.^bSpecific gravity range from 0.5 to 1.0.^cShear strength data are limited to small samples having a specific gravity of 0.5 to 0.65.^d*E/G* is ratio of bending modulus of elasticity to shear modulus. For wood, this ratio is about 16.

ASTM D 1037–06a. Standard test methods for evaluating the properties of wood-based fiber and particle panel materials.

ASTM D 2718–00 (2006). Standard test method for structural panels in planar shear (rolling shear).

ASTM D 2719–89 (2007). Standard test methods for structural panels in shear through-the-thickness.

ASTM D 3043–00 (2006). Standard test methods of testing structural panels in flexure.

ASTM D 3044–94 (2006). Standard test method for shear modulus of wood-based structural plywood.

ASTM D 3500–90 (2003). Standard test methods for structural panels in tension.

ASTM D 3501–05a. Standard test methods of testing plywood in compression.

ASTM D 3737–08. Standard practice for establishing allowable properties for structural glued laminated timber (glulam).

ASTM D 5456–09. Specification for evaluation of structural composite lumber products.

ASTM D 7031–04. Standard guide for evaluating mechanical and physical properties of wood-plastic composite products.

ASTM D 7032–08. Standard specification for establishing performance ratings for wood-plastic composite deck boards and guardrail systems.

ASTM D 7341–09. Standard practice for establishing characteristic values for flexural properties of structural glued laminated timber by full-scale testing.

ASTM E 1333–96 (2002). Test method for determining formaldehyde concentration in air and emission rate from wood products using a large chamber.

Literature Cited

- AF&PA. 2005. Guideline—wood I-joist ASD manual for engineering wood construction. ANSI/AF&PA NDS–2005. National Design Specification® (NDS®) for Wood Construction. Washington, DC: American Forest & Paper Association.
- AITC. 2007. Standard for wood products: structural glued-laminated timber. ANSI/AITC 190.1–2007. Centennial, CO: American Institute of Timber Construction.
- APA. 1981. Performance standards and policies for APA structural use panels. Tacoma, WA: American Plywood Association. 1 p.
- APA. 1991. Performance standards and policies for structural use panels. APA PRP–108. Tacoma, WA: APA – The Engineered Wood Association.
- APA. 1995a. Design capacities of APA performance-rated structural-use panels. Tech. Note N375 B. Tacoma, WA: APA – The Engineered Wood Association. 12 p.
- APA. 1995b. Plywood design specification. Tacoma, WA: APA – The Engineered Wood Association. 10 p.
- ASTM. 2007. Annual book of ASTM standards. Philadelphia, PA: American Society for Testing and Materials.

Chapter 12 Mechanical Properties of Wood-Based Composite Materials

- Bender, D.A.; Wolcott, M.P.; Dolan, J.D. 2006. Structural design and applications with wood-plastic composites. *Wood Design Focus*. 16(3): 13–16.
- Biblis, E.J. 1989. Properties of commercial OSB from three Southern Pine mills. *Forest Products Journal*. 39(1): 55–57.
- Biblis, E.J. 2000. Effect of weathering on surface quality and structural properties of six species of untreated commercial plywood siding after 6 years of exposure in Alabama. *Forest Products Journal*. 50(5): 47–50.
- Bohlen, J.C. 1974. Tensile strength of Douglas-fir laminated-veneer lumber. *Forest Products Journal*. 24(1): 54–58.
- Cai, Z. 2006. Selected properties of MDF and flakeboard overlaid with fiberglass mats. *Forest Products Journal*. 56(11/12): 142–146.
- Cai, Z.; Muehl, J.H.; Winandy, J.E. 2006. Effects of panel density and mat moisture content on processing medium density fiberboard. *Forest Products Journal*. 56(10): 20–25.
- Clemons, C.M. 2002. Wood-plastic composites in the United States: the interfacing of two industries. *Forest Products Journal*. 52(6): 10–18.
- CPA. 1999. Particleboard standard. ANSI A 208.1–1999. Leesburg, VA: Composite Panel Association.
- CPA. 2002. MDF standard. ANSI A 208.2–2002. Leesburg, VA: Composite Panel Association.
- CPA. 2004a. Basic hardboard. ANSI A 135.4–2004. Leesburg, VA: Composite Panel Association.
- CPA. 2004b. Prefinished hardboard paneling. ANSI A 135.5–2004. Leesburg, VA: Composite Panel Association.
- CPA. 2006. Hardboard siding. ANSI A 135.6–2006. Leesburg, VA: Composite Panel Association.
- Hernandez, R.; Moody, R.C. 1992. Improved performance of Southern Pine structural glued-laminated timber. Res. Pap. FPL–RP–514. Madison, WI: U.S. Department of Agriculture, Forest Service, Forest Products Laboratory. 22 p.
- Hernandez, R.; Green, D.W.; Kretschmann, D.E.; Verrill, S.P. 2005. Improved utilization of small-diameter ponderosa pine in glulam timber. Res. Pap. FPL–RP–625. Madison, WI: U.S. Department of Agriculture, Forest Service, Forest Products Laboratory. 38 p.
- Hindman, D.P.; Janowiak, J.J.; Manbeck, H.B. 2006. Comparison of ASTM D 198 and five-point bending for elastic constant ratio determination. *Forest Products Journal*. 56(7/8): 85–90.
- HPVA. 2004. American national standard for hardwood and decorative plywood. ANSI/HPVA–1–2004. Reston, VA: Hardwood Plywood & Veneer Association. 35 p.
- Janowiak, J.J.; Manbeck, H.B.; Hernandez, R.; Moody, R.C.; Blankenhorn, P.R.; Labosky, P. 1995. Efficient utilization of red maple in glued-laminated timber beams. Res. Pap. FPL–RP–541. Madison, WI: U.S. Department of Agriculture, Forest Service, Forest Products Laboratory. 23 p.
- Jung, J. 1982. Properties of parallel-laminated veneer from stress-wave tested veneers. *Forest Products Journal*. 32(7): 30–35.
- Kobbe, R.G. 2005. Creep behavior of a wood-polypropylene composite. MS Thesis. Pullman, WA: Washington State University. 96 p.
- Koch, P. 1973. Structural lumber laminated from 1/4-inch rotary-peeled Southern Pine veneer. *Forest Products Journal*. 23(7):17–25.
- Kretschmann, D.E.; Moody, R.C.; Pellerin, R.F.; Bendtsen, B.A.; Cahill, J.M.; McAlister, R.H.; Sharp, D.W. 1993. Effect of various proportions of juvenile wood on laminated veneer lumber. Res. Pap. FPL–RP–521. Madison, WI: U.S. Department of Agriculture, Forest Service, Forest Products Laboratory. 35 p.
- Kunesh, R.H. 1978. MICRO-LAM: structural laminated veneer lumber. *Forest Products Journal*. 28(7): 41–44.
- Manbeck, H.B.; Janowiak, J.J.; Blankenhorn, P.R.; Labosky, P.; Moody, R.C.; Hernandez, R. 1993. Red maple glulam timber beam performance. FPL–RP–519. Madison, WI: U.S. Department of Agriculture, Forest Service, Forest Products Laboratory. 32 p.
- Marx, C.M.; Moody, R.C. 1981a. Bending strength of shallow glued-laminated beams of a uniform grade. Res. Pap. FPL–RP–380. Madison, WI: U.S. Department of Agriculture, Forest Service, Forest Products Laboratory. 19 p.
- Marx, C.M.; Moody, R.C. 1981b. Strength and stiffness of small glued-laminated beams with different qualities of tension laminations. Res. Pap. FPL–RP–381. Madison, WI: U.S. Department of Agriculture, Forest Service, Forest Products Laboratory. 48 p.
- McNatt, J.D. 1973. Basic engineering properties of particleboard. Res. Pap. FPL–206. Madison, WI: U.S. Department of Agriculture, Forest Service, Forest Products Laboratory.
- McNatt, J.D. Myers, G. 1993. Selected properties of commercial high-density hardboards. *Forest Products Journal*. 43(4): 59–62.
- Moody, R.C. 1972. Tensile strength of lumber laminated from 1/8-inch-thick veneers. Res. Pap. FPL–RP–181. Madison, WI: U.S. Department of Agriculture, Forest Service, Forest Products Laboratory. 28 p.
- Moody, R.C. 1974. Flexural strength of glued-laminated timber beams containing coarse-grain Southern Pine lumber. Res. Pap. FPL–222. Madison, WI: U.S. Department of Agriculture, Forest Service, Forest Products Laboratory. 42 p.

- Moody, R.C.; Peters, C.C. 1972. Strength properties of rotary knife-cut laminated Southern Pine. FPL–RP–178. Madison, WI: U.S. Department of Agriculture, Forest Service, Forest Products Laboratory. 1 p.
- Moody, R.C.; Hernandez, R.; Davalos, J.F.; Sonti, S.S. 1993. Yellow poplar glulam timber beam performance. Res. Pap. FPL–RP–520. Madison, WI: U.S. Department of Agriculture, Forest Service, Forest Products Laboratory. 30 p.
- NIST. 2004. Voluntary product standard PS 2–04. Performance standard for wood-base structural-use panels. National Institute of Standards and Technology. Gaithersburg, MD: U.S. Department of Commerce.
- NIST. 2007. Voluntary product standard PS 1–07. Construction and industrial plywood. National Institute of Standards and Technology. Gaithersburg, MD: U.S. Department of Commerce.
- O’Halloran, M.R. 1979. Development of performance specifications for structural panels in residential markets. *Forest Products Journal*. 29(12): 21–26.
- O’Halloran, M.R. 1980. The performance approach to acceptance of building products. In: *Proceedings, 14th Washington State University particleboard symposium*. Pullman, WA: 77–84.
- Pu, J.; Tang, R.C.; Davis, W.C. 1992. Creep behavior of commercial oriented strandboard under high relative humidity. *Forest Products Journal*. 42(4): 49–54.
- Shedlauskas, J.P.; Manbeck, H.B.; Janowiak, J.J.; Hernandez, R.; Moody, R.C.; Labosky, P., Jr.; Blankenhorn, P.R. 1996. Efficient use of red oak for glued-laminated beams. *Transactions of ASAE*. 39(1): 203–209.
- Slaughter, A.E. 2004. Design and fatigue of a structural wood–plastic composite. MS Thesis. Pullman, WA: Washington State University. 150 p.
- Stark, N.M.; Rowlands, R.E. 2003. Effects of wood fiber characteristics on mechanical properties of wood/polypropylene composites. *Wood Fiber Science*. 35(2): 167–174.
- Suchsland, O.; Lyon, D.E.; Short, P.E. 1979. Selected properties of commercial medium-density fiberboard. *Forest Products Journal*. 29(9): 45–49.
- TECO. 1991. Performance standards and policies for structural-use panels. TECO PRP–133. Eugene, OR: Timber Engineering Company.
- Wang, S.; Gu, H.; Neimsuwan, T.; Wang, S.G. 2003a. Layer thickness swell and related properties of commercial OSB products: a comparative study. In: *Proceedings, 37th international particleboard and composite materials symposium*. 2003 April 7–10. Pullman, WA: Washington State University. 65–76.
- Wang, X.; Ross, R.J.; Brashaw, B.K.; Verhey, S.A.; Forsman, J.W.; Erickson, J.R. 2003b. Flexural properties of laminated veneer lumber manufactured from ultrasonically rated red maple veneer. A pilot study. Res. Note FPL–RN–0288. Madison, WI: U.S. Department of Agriculture, Forest Service, Forest Products Laboratory. 5 p.
- Wolcott, M.P. 2001. Final report: engineered wood composites from naval waterfront facilities. Contract Noo014-97-C-0395. Arlington, VA: Office of Naval Research.
- Wolcott, M.P.; Smith, P.M.; Englund, K.R. 2006. Technology and market issues driving wood–plastic product development. *Wood Design Focus*. 16(3): 3–5.
- Youngquist, J.A.; Laufenberg, T.L.; Bryant, B.S. 1984. End jointing of laminated veneer lumber for structural use. *Forest Products Journal*. 34(11/12): 25–32.
- Youngquist, J.A.; Myers, G.E.; Muehl, J.M. 1993. Composites from recycled wood and plastics. Final Rep., U.S. Environmental Protection Agency, Project IAG DW12934608–2. Madison, WI: U.S. Department of Agriculture, Forest Service, Forest Products Laboratory. 3 p.

Drying and Control of Moisture Content and Dimensional Changes

Richard Bergman, Research Forest Products Technologist

Contents

- Determination of Moisture Content 13–1
 - Oven-Drying Method 13–2
 - Electrical Method 13–2
- Recommended Moisture Content 13–3
 - Timbers 13–3
 - Lumber 13–3
 - Glued Wood Products 13–3
- Drying of Wood 13–5
 - Air Drying 13–6
 - Accelerated Air Drying and Pre-Drying 13–6
 - Kiln Drying 13–6
 - Drying Mechanism 13–6
 - Drying Stresses 13–7
 - Dry Kilns 13–8
 - Kiln Schedules 13–8
 - Drying Defects 13–9
 - Moisture Content of Dried Lumber 13–11
- Moisture Control during Transit and Storage 13–13
 - Plywood and Structural Items 13–14
 - Finish and Factory Lumber 13–14
- Dimensional Changes in Wood 13–15
 - Estimation Using Dimensional Change Coefficient 13–15
 - Calculation Based on Green Dimensions 3–17
- Design Factors Affecting Dimensional Change 13–17
 - Framing Lumber in House Construction 13–17
 - Heavy Timber Construction 13–18
 - Interior Finish 13–18
 - Flooring 13–18
- Wood Care and Installation during Construction 13–18
 - Lumber and Trusses 13–18
 - Exterior Trim and Millwork 13–19
 - Finished Flooring 13–19
 - Interior Trim 13–19
 - Plastering 13–19
- Literature Cited 13–19

In the living tree, wood contains large quantities of water. As green wood dries, most of the water is removed. The moisture remaining in the wood tends to come to equilibrium with the relative humidity of the surrounding air. Correct drying, handling, and storage of wood will minimize moisture content changes that might occur after drying when the wood is in service. If moisture content is controlled within reasonable limits by such methods, major problems from dimensional changes can usually be avoided.

The discussion in this chapter is concerned with moisture content determination, recommended moisture content values, drying methods, methods of calculating dimensional changes, design factors affecting such changes in structures, and moisture content control during transit, storage, and construction. Data on green moisture content, fiber saturation point, shrinkage, and equilibrium moisture content are given with information on other physical properties in Chapter 4.

Wood in service is always undergoing slight changes in moisture content. These changes that result from daily humidity changes are often small and usually of no consequence. Changes that occur because of seasonal variation, although gradual, tend to be of more concern. Protective coatings can retard dimensional changes in wood but do not prevent them. In general, no significant dimensional changes will occur if wood is fabricated or installed at a moisture content corresponding to the average atmospheric conditions to which it will be exposed. When incompletely dried material is used in construction, some minor dimensional changes can be tolerated if the proper design is used.

Determination of Moisture Content

The amount of moisture in wood is ordinarily expressed as a percentage of wood mass when oven-dried. Four methods of determining moisture content are covered in ASTM D 4442 (ASTM 2007). Two of these—the oven-drying and the electrical methods—are described in this chapter.

The oven-drying method has been the most universally accepted method for determining moisture content, but it is slow and necessitates cutting the wood. In addition, the oven-drying method may give values slightly greater than true moisture content with woods containing volatile extrac-

tives. The electrical method is rapid, does not require cutting the wood, and can be used on wood installed in a structure. However, considerable care must be taken to use and interpret the results correctly. Use of the electrical method is generally limited to moisture content values less than 30%.

Oven-Drying Method

In the oven-drying method, specimens are taken from representative boards or pieces of a quantity of lumber. With lumber, obtain the specimens at least 500 mm (20 in.) from the end of the pieces. They should be free from knots and other irregularities, such as bark and pitch pockets. Specimens from lumber should be full cross sections and 25 mm (1 in.) long. Specimens from larger items may be representative sectors of such sections or subdivided increment borer or auger chip samples. Convenient amounts of chips and particles can be selected at random from larger batches, with care taken to ensure that the sample is representative of the batch. Select veneer samples from four or five locations in a sheet to ensure that the sample average will accurately indicate the average of the sheet.

To prevent drying or uptake of moisture, weigh each specimen immediately. If the specimen cannot be weighed immediately, place it in a plastic bag or tightly wrapped in metal foil to protect it from moisture change until it can be weighed. After weighing, place the specimen in an oven heated to 101 to 105 °C (214 to 221 °F), and keep it there until no appreciable weight change occurs in 4-h weighing intervals. A lumber section 25 mm (1 in.) along the grain will reach a constant weight in 12 to 48 h. Smaller specimens will take less time. The constant or oven-dry mass and the (original) mass of the specimen when cut are used to determine the percentage of moisture content (MC) using the formula

$$MC(\%) = \frac{\text{Mass when cut} - \text{Ovendry mass}}{\text{Ovendry mass}} \times 100 \quad (13-1)$$

Electrical Method

The electrical method of determining the moisture content of wood uses the relationships between moisture content and measurable electrical properties of wood, such as conductivity (or its inverse, resistivity), dielectric constant, or power-loss factor. These properties vary in a definite and predictable way with changing moisture content, but correlations are not perfect. Therefore, moisture determinations using electrical methods are always subject to some uncertainty.

Electric moisture meters are available commercially and are based on each of these properties and identified by the property measured. Conductance-type (or resistance) meters measure moisture content in terms of the direct current conductance of the specimen. Dielectric-type meters are of

two types. Those based principally on dielectric constant are called capacitance or capacitive admittance meters; those based on loss factor are called power-loss meters.

The principal advantages of the electrical method compared with the oven-drying method are speed and convenience. Only a few seconds are required for the determination, and the piece of wood being tested is not cut or damaged, except for driving electrode needle points into the wood when using conductance-type meters. Thus, the electrical method is adaptable to rapid sorting of lumber on the basis of moisture content, measuring the moisture content of wood installed in a building, or establishing the moisture content of a quantity of lumber or other wood items, when used in accordance with ASTM D 4442.

For conductance meters, needle electrodes (pins) of various lengths are driven into the wood. The two general types of electrodes are insulated and uninsulated. Uninsulated electrodes will sense the lowest resistance (highest conductance) along their length, thus highest moisture content level. Moisture gradients between the surface and the interior can lead to confusion; therefore, insulating the electrode except the tip is useful to show moisture gradients. If the wood is wetter near the center than the surface, which is typical for drying wood, the reading will correspond to the depth of the tip of the insulated electrodes. If a meter reading increases as the electrodes are being driven in, then the moisture gradient is typical. In this case, drive the pins about one-fifth to one-fourth the thickness of the wood to reflect the average moisture content of the entire piece. Dried or partially dried wood sometimes regains moisture in the surface fibers from rewetting therefore the surface moisture content is greater than that of the interior. An example of this is when dried wood is rained on. In this case, the meter with the uninsulated pins will read the higher moisture content surface, possibly causing a significant deviation from the average moisture content. To guard against this problem, electrodes with insulated shanks have been developed. They measure moisture content of only the wood at the tips of the electrodes.

Dielectric-type meters are fitted with surface contact electrodes designed for the type of specimen material being tested. The electric field from these electrodes penetrates well into the specimen, but with a strength that decreases rapidly with depth of penetration. For this reason, the surface layers of the specimen influence the readings of dielectric (pinless) meters predominantly, and the meter reading may not adequately represent the material near the core if there is a large moisture content gradient.

To obtain accurate moisture content values, use each instrument in accordance with its manufacturer's instructions. The electrodes should be appropriate for the material being tested and properly oriented according to the meter manufacturer's instructions. Take the readings after inserting

the electrode. Apply a species correction supplied with the instrument when appropriate. Make temperature corrections if the temperature of the wood differs considerably from the temperature of calibration used by the manufacturer. Approximate corrections for conductance-type (resistance) meters are made by adding or subtracting about 0.5% for each 5.6 °C (10 °F) the wood temperature differs from the calibration temperature. Add the correction factors to the readings for temperatures less than the calibration temperature and subtract from the readings for temperatures greater than the calibration temperature. Temperature corrections for older dielectric meters are rather complex and are best made from published charts (James 1988). Newer dielectric meters perform this temperature calibration internally, although newer dielectric meters require a specific gravity adjustment.

Although some meters have scales that go up to 120%, the range of moisture content that can be measured reliably is 4% to about 30% for commercial dielectric meters and about 6% to 30% for resistance meters. The precision of the individual meter readings decreases near the limits of these ranges. Readings greater than 30% must be considered only qualitative. When the meter is properly used on a quantity of lumber dried to a constant moisture content below fiber saturation, the average moisture content from the corrected meter readings should be within 1% of the true average.

Recommended Moisture Content

Install wood at the moisture content levels that the wood will experience in service. This minimizes the seasonal variation in moisture content, thus dimensional changes, after installation, avoiding problems such as floor buckling or cracks in furniture. The in-service moisture content of exterior wood (siding, wood trim) primarily depends on the outdoor relative humidity and exposure to rain or sun. The in-service moisture content of interior wood primarily depends on indoor relative humidity, which in turn is a complex function of moisture sources, ventilation rate, dehumidification (for example, air conditioning), and outdoor humidity conditions.

Recommended values for interior wood presented in this chapter are based on measurements in well-ventilated buildings without unusual moisture sources and without air conditioning. In air-conditioned buildings, moisture conditions depend largely on the proper sizing of the air-conditioning equipment. Installing wood in basements or over a crawl space may experience moisture contents greater than the range given. Wood in insulated walls or roofs and attics may experience moisture contents greater or less than the range. Nevertheless, the recommended values for installation provide a useful guideline.

Timbers

Ideally, dry solid timbers to the average moisture content the material will reach in service. Although this optimum is possible with lumber less than 76 mm (3 in.) thick, it is seldom practical to obtain fully dried timbers, thick joists, and planks. When thick solid members are used, some shrinkage of the assembly should be expected. In the case of built-up assemblies, such as roof trusses, it may be necessary to tighten bolts or other fastenings occasionally to maintain full bearing of the connectors as the members shrink.

Lumber

Match the recommended moisture content of wood as closely as is practical to the equilibrium moisture content (EMC) conditions in service. Table 13–1 shows the EMC conditions in outdoor exposure in various U.S. cities for each month. The EMC data are based on the average relative humidity and temperature data (30 or more years) available from the National Climatic Data Center of the National Oceanic and Atmospheric Administration. The relative humidity data are the averages of the morning and afternoon values. In most cases, these values are representative of the EMC attained by the wood. However, in some locations, early morning relative humidity may occasionally reach 100%. Under these conditions, condensation may occur on the wood surface, therefore surface fibers will exceed the EMC. The moisture content requirements are more exacting for finished lumber and wood products used inside heated and air-conditioned buildings than those for lumber used outdoors or in unheated buildings. For various areas of the United States, the recommended moisture content values for wood used inside heated buildings are shown in Figure 13–1. Values and tolerances for both interior and exterior uses of wood in various forms are given in Table 13–2. If the average moisture content is within 1% of that recommended and all pieces fall within the individual limits, the entire lot is probably satisfactory (Simpson 1998).

General commercial practice is to kiln dry wood for some products, such as flooring and furniture, to a slightly lower moisture content than service conditions demand. This anticipates a moderate increase in moisture content during processing, transportation, and construction. This practice is intended to ensure uniform distribution of moisture among the individual pieces. Common grades of softwood lumber and softwood dimension lumber are not normally dried to the moisture content values indicated in Table 13–2. Dry lumber, as defined in the American Softwood Lumber Standard, has a maximum moisture content of 19%. Some industry grading rules provide for an even lower maximum. For example, to be grade marked KD 15, the maximum moisture content permitted is generally 15%.

Glued Wood Products

When veneers are bonded with cold-setting adhesives to make plywood, they take up comparatively large

Table 13-1. Equilibrium moisture content for outside conditions in several U.S. locations prior to 1997

		Equilibrium moisture content ^a (%)											
State	City	Jan.	Feb.	Mar.	Apr.	May	June	July	Aug.	Sept.	Oct.	Nov.	Dec.
AK	Juneau	16.5	16.0	15.1	13.9	13.6	13.9	15.1	16.5	18.1	18.0	17.7	18.1
AL	Mobile	13.8	13.1	13.3	13.3	13.4	13.3	14.2	14.4	13.9	13.0	13.7	14.0
AZ	Flagstaff	11.8	11.4	10.8	9.3	8.8	7.5	9.7	11.1	10.3	10.1	10.8	11.8
AZ	Phoenix	9.4	8.4	7.9	6.1	5.1	4.6	6.2	6.9	6.9	7.0	8.2	9.5
AR	Little Rock	13.8	13.2	12.8	13.1	13.7	13.1	13.3	13.5	13.9	13.1	13.5	13.9
CA	Fresno	16.4	14.1	12.6	10.6	9.1	8.2	7.8	8.4	9.2	10.3	13.4	16.6
CA	Los Angeles	12.2	13.0	13.8	13.8	14.4	14.8	15.0	15.1	14.5	13.8	12.4	12.1
CO	Denver	10.7	10.5	10.2	9.6	10.2	9.6	9.4	9.6	9.5	9.5	11.0	11.0
DC	Washington	11.8	11.5	11.3	11.1	11.6	11.7	11.7	12.3	12.6	12.5	12.2	12.2
FL	Miami	13.5	13.1	12.8	12.3	12.7	14.0	13.7	14.1	14.5	13.5	13.9	13.4
GA	Atlanta	13.3	12.3	12.0	11.8	12.5	13.0	13.8	14.2	13.9	13.0	12.9	13.2
HI	Honolulu	13.3	12.8	11.9	11.3	10.8	10.6	10.6	10.7	10.8	11.3	12.1	12.9
ID	Boise	15.2	13.5	11.1	10.0	9.7	9.0	7.3	7.3	8.4	10.0	13.3	15.2
IL	Chicago	14.2	13.7	13.4	12.5	12.2	12.4	12.8	13.3	13.3	12.9	14.0	14.9
IN	Indianapolis	15.1	14.6	13.8	12.8	13.0	12.8	13.9	14.5	14.2	13.7	14.8	15.7
IA	Des Moines	14.0	13.9	13.3	12.6	12.4	12.6	13.1	13.4	13.7	12.7	13.9	14.9
KS	Wichita	13.8	13.4	12.4	12.4	13.2	12.5	11.5	11.8	12.6	12.4	13.2	13.9
KY	Louisville	13.7	13.3	12.6	12.0	12.8	13.0	13.3	13.7	14.1	13.3	13.5	13.9
LA	New Orleans	14.9	14.3	14.0	14.2	14.1	14.6	15.2	15.3	14.8	14.0	14.2	15.0
ME	Portland	13.1	12.7	12.7	12.1	12.6	13.0	13.0	13.4	13.9	13.8	14.0	13.5
MA	Boston	11.8	11.6	11.9	11.7	12.2	12.1	11.9	12.5	13.1	12.8	12.6	12.2
MI	Detroit	14.7	14.1	13.5	12.6	12.3	12.3	12.6	13.3	13.7	13.5	14.4	15.1
MN	Minneapolis-St. Paul	13.7	13.6	13.3	12.0	11.9	12.3	12.5	13.2	13.8	13.3	14.3	14.6
MS	Jackson	15.1	14.4	13.7	13.8	14.1	13.9	14.6	14.6	14.6	14.1	14.3	14.9
MO	St. Louis	14.5	14.1	13.2	12.4	12.8	12.6	12.9	13.3	13.7	13.1	14.0	14.9
MT	Missoula	16.7	15.1	12.8	11.4	11.6	11.7	10.1	9.8	11.3	12.9	16.2	17.6
NE	Omaha	14.0	13.8	13.0	12.1	12.6	12.9	13.3	13.8	14.0	13.0	13.9	14.8
NV	Las Vegas	8.5	7.7	7.0	5.5	5.0	4.0	4.5	5.2	5.3	5.9	7.2	8.4
NV	Reno	12.3	10.7	9.7	8.8	8.8	8.2	7.7	7.9	8.4	9.4	10.9	12.3
NM	Albuquerque	10.4	9.3	8.0	6.9	6.8	6.4	8.0	8.9	8.7	8.6	9.6	10.7
NY	New York	12.2	11.9	11.5	11.0	11.5	11.8	11.8	12.4	12.6	12.3	12.5	12.3
NC	Raleigh	12.8	12.1	12.2	11.7	13.1	13.4	13.8	14.5	14.5	13.7	12.9	12.8
ND	Fargo	14.2	14.6	15.2	12.9	11.9	12.9	13.2	13.2	13.7	13.5	15.2	15.2
OH	Cleveland	14.6	14.2	13.7	12.6	12.7	12.7	12.8	13.7	13.8	13.3	13.8	14.6
OK	Oklahoma City	13.2	12.9	12.2	12.1	13.4	13.1	11.7	11.8	12.9	12.3	12.8	13.2
OR	Pendleton	15.8	14.0	11.6	10.6	9.9	9.1	7.4	7.7	8.8	11.0	14.6	16.5
OR	Portland	16.5	15.3	14.2	13.5	13.1	12.4	11.7	11.9	12.6	15.0	16.8	17.4
PA	Philadelphia	12.6	11.9	11.7	11.2	11.8	11.9	12.1	12.4	13.0	13.0	12.7	12.7
SC	Charleston	13.3	12.6	12.5	12.4	12.8	13.5	14.1	14.6	14.5	13.7	13.2	13.2
SD	Sioux Falls	14.2	14.6	14.2	12.9	12.6	12.8	12.6	13.3	13.6	13.0	14.6	15.3
TN	Memphis	13.8	13.1	12.4	12.2	12.7	12.8	13.0	13.1	13.2	12.5	12.9	13.6
TX	Dallas-Ft. Worth	13.6	13.1	12.9	13.2	13.9	13.0	11.6	11.7	12.9	12.8	13.1	13.5
TX	El Paso	9.6	8.2	7.0	5.8	6.1	6.3	8.3	9.1	9.3	8.8	9.0	9.8
UT	Salt Lake City	14.6	13.2	11.1	10.0	9.4	8.2	7.1	7.4	8.5	10.3	12.8	14.9
VA	Richmond	13.2	12.5	12.0	11.3	12.1	12.4	13.0	13.7	13.8	13.5	12.8	13.0
WA	Seattle-Tacoma	15.6	14.6	15.4	13.7	13.0	12.7	12.2	12.5	13.5	15.3	16.3	16.5
WI	Madison	14.5	14.3	14.1	12.8	12.5	12.8	13.4	14.4	14.9	14.1	15.2	15.7
WV	Charleston	13.7	13.0	12.1	11.4	12.5	13.3	14.1	14.3	14.0	13.6	13.0	13.5
WY	Cheyenne	10.2	10.4	10.7	10.4	10.8	10.5	9.9	9.9	9.7	9.7	10.6	10.6

^aEMC values were determined from the average of 30 or more years of relative humidity and temperature data available from the National Climatic Data Center of the National Oceanic and Atmospheric Administration.

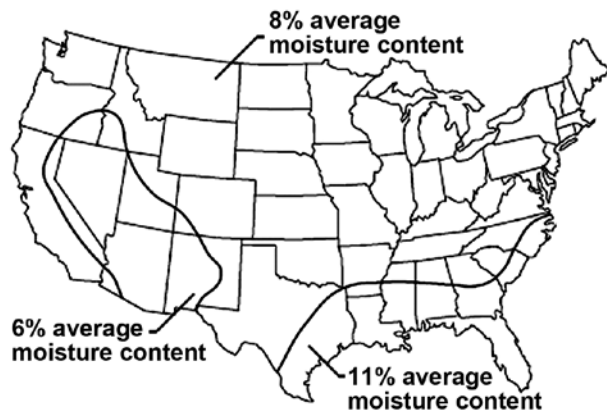

Figure 13–1. Recommended average moisture content for interior use of wood products in various areas of the United States.

quantities of moisture. To keep the final moisture content low and to minimize the need for re-drying the plywood, the initial moisture content of the veneer should be as low as practical. However, dry veneer is brittle and difficult to handle without damage, so the minimum practical moisture content is about 4%. Freshly glued plywood intended for interior service should be dried to the moisture content values given in Table 13–2.

Hot-pressed plywood and other board products, such as particleboard and hardboard, usually do not have the same moisture content as lumber. The high temperatures used in hot presses cause these products to assume a lower moisture content for a given relative humidity. Because this lower equilibrium moisture content varies widely, depending on the specific type of hot-pressed product, it is recommended that such products be conditioned at 30% to 40% relative humidity for interior use and 65% for exterior use.

Lumber used in the manufacture of large laminated members should be dried to a moisture content slightly less than the moisture content expected in service. This is done so

that the moisture adsorbed from the adhesive will not cause the moisture content of the product to exceed the service value. The range of moisture content between laminations assembled into a single member should not exceed 5 percentage points.

Although laminated members are often massive and respond rather slowly to changes in environmental conditions, it is desirable to follow the recommendations in Table 13–2 for moisture content at time of installation.

Drying of Wood

Drying is required for wood to be used in most products. Dried lumber has many advantages over green lumber for producers and consumers. Removal of excess water reduces weight, thus shipping and handling costs. Proper drying reduces shrinking and swelling of wood while in use to manageable amounts under all but extreme conditions of relative humidity or rewetting such as flooding. As wood dries, most of its strength properties increase, as well as its electrical and thermal insulating properties. Properly dried lumber can be cut to precise dimensions and machined more easily and efficiently; wood parts can be more securely fitted and fastened together with nails, screws, bolts, and adhesives; warping, splitting, checking, and other harmful effects of uncontrolled drying are largely eliminated; and paint, varnish, and other finishes are more effectively applied and maintained. Wood must be relatively dry before gluing or treating with decay-preventing and fire-retardant chemicals.

The key to successful and efficient drying is control of the drying process. Timely application of optimum or at least adequate temperature, relative humidity, and air circulation conditions is critical. Uncontrolled drying leads to drying defects that can adversely affect the serviceability and economics of the product. The usual strategy is to dry as fast as the particular species, thickness, and end-product requirements allow without damaging the wood. Slower drying can be uneconomical and can introduce the risk of stain.

Table 13–2. Recommended moisture content values for various wood products at time of installation

Use of wood	Recommended moisture content (%) for areas in the United States					
	Most areas of the United States		Dry southwestern area ^a		Damp, warm coastal area ^a	
	Average ^b	Individual pieces	Average ^b	Individual pieces	Average ^b	Individual pieces
Interior: woodwork, flooring, furniture, wood trim	8	6–10	6	4–9	11	8–13
Exterior: siding, wood trim, sheathing, laminated timbers	12	9–14	9	7–12	12	9–14

^aMajor areas are indicated in Figure 13–1.

^bTo obtain a realistic average, test at least 10% of each item. If the quantity of a given item is small, make several tests. For example, in an ordinary dwelling containing 60 floor joists, at least six tests should be made on joists selected at random.

Softwood lumber intended for framing in construction is usually targeted for drying to an average moisture content of 15%, not to exceed 19%. Softwood lumber for many appearance grade uses is dried to a lower moisture content of 10% to 12% and to 7% to 9% for furniture, cabinets, and millwork. Hardwood lumber for framing in construction, although not in common use, should also be dried to an average moisture content of 15%, not to exceed 19%. Hardwood lumber for furniture, cabinets, and millwork is usually dried to 6% to 8% moisture content.

Lumber drying is usually accomplished by some combination of air drying, accelerated air drying or pre-drying, and kiln drying. Wood species, initial moisture content, lumber thickness, economics, and end use are often the main factors in determining the details of the drying process.

Air Drying

The main purpose of air drying lumber is to evaporate as much of the water as possible before end use or prior to kiln-drying. Air drying lumber down to 20% to 25% moisture content prior to kiln-drying is common. Sometimes, depending on a mill's scheduling, air drying may be cut short at a higher moisture content before the wood is sent to the dry kiln. Air drying saves energy costs and reduces required dry kiln capacity. Limitations of air drying are generally associated with uncontrolled drying. The drying rate is very slow during the cold winter months. At other times, hot, dry winds may increase degrade and volume losses as a result of severe surface checking and end splitting. End coating may alleviate end checking and splitting. Warm, humid periods with little air movement may encourage the growth of fungal stains, as well as aggravate chemical stains. Another limitation of air drying is the high cost of carrying a large inventory of high value lumber for extended periods. Air drying time to 20% to 25% moisture content varies widely, depending on species, thickness, location, and the time of year the lumber is stacked. Some examples of extremes for 25-mm- (1-in.-) thick lumber are 15 to 30 days for some of the low-density species, such as pine, spruce, red alder, and soft maple, stacked in favorable locations and favorable times of the year; 200 to 300 days for slow-drying species, such as sinker hemlock and pine, oak, and birch, in northern locations and stacked at unfavorable times of the year. Details of important air-drying considerations, such as lumber stacking and air drying yard layout, are covered in *Air Drying of Lumber: A Guide to Industry Practices* (Rietz and Page 1971).

Accelerated Air Drying and Pre-Drying

The limitations of air drying have led to increased use of technology that reduces drying time and introduces some control into drying (green) wood. Accelerated air drying involves the use of fans to force air through lumber piles in a shed. This protects the lumber from the elements and improves air circulation compared with air drying, thus

improving quality. Heat is sometimes added to reduce the relative humidity and slightly increase the shed temperature to aid drying. Pre-dryers take this acceleration and control a step further by providing control of both temperature and relative humidity and providing forced air circulation in a completely enclosed compartment. Typical conditions in a pre-dryer are 27 to 38 °C (80 to 100 °F) and 65% to 85% relative humidity.

Kiln Drying

In kiln drying, higher temperatures and faster air circulation are used to significantly increase the drying rate. Specific kiln schedules have been developed to control temperature and relative humidity in accordance with the moisture content and stress situation within the wood, thus minimizing shrinkage-caused defects (Boone and others 1988).

Drying Mechanism

Water in wood normally moves from high to low zones of moisture content, which means that the surface of the wood must be drier than the interior if moisture is to be removed. Drying can be broken down into two phases: movement of water from the interior to the wood surface and evaporation of water from the surface. The surface fibers of most species reach moisture equilibrium with the surrounding air soon after drying begins. This is the beginning of the development of a typical moisture gradient (Fig. 13–2), that is, the difference in moisture content between the inner and outer portions of a board. If air circulation is too slow, a longer time is required for the wood surface to reach moisture equilibrium. This is one reason why air circulation is so important in kiln drying. If air circulation is too slow, the drying rate is also slower than necessary and mold could develop on the surface of lumber. If drying is too fast, electrical energy in running the fans is wasted, and in certain species, surface checking and other drying defects can develop if relative humidity and air velocity are not coordinated.

Water moves through the interior of wood as a liquid or vapor through various air passageways in the cellular structure of the wood, as well as through the wood cell walls. Moisture moves in these passageways in all directions, both across and with the grain. In general, lighter species dry faster than heavier species because the structure of lighter wood contains more openings per unit volume, and moisture moves through air faster than through wood cell walls. Water moves by two main mechanisms: capillary action (liquid) and diffusion of bound water (vapor). Capillary action causes the free water to flow through cell cavities and the small passageways that connect adjacent cell cavities. Diffusion of bound water moves moisture from areas of high concentration to areas of low concentration. Diffusion in the longitudinal direction is about 10 to 15 times faster than radial or tangential diffusion, and radial diffusion is somewhat faster than tangential diffusion. This explains why flatsawn lumber generally dries faster than quartersawn lumber. Al-

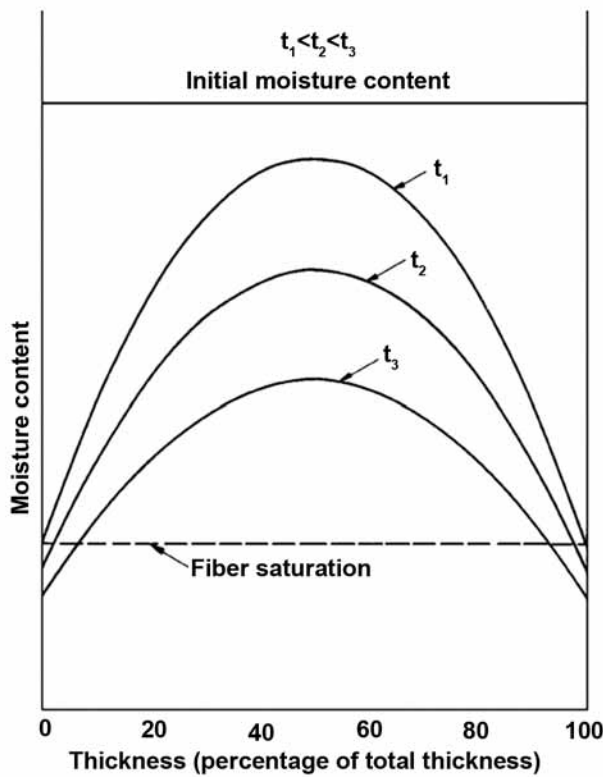

Figure 13-2. Typical moisture gradient in lumber during drying at time increasing from t_1 to t_3 .

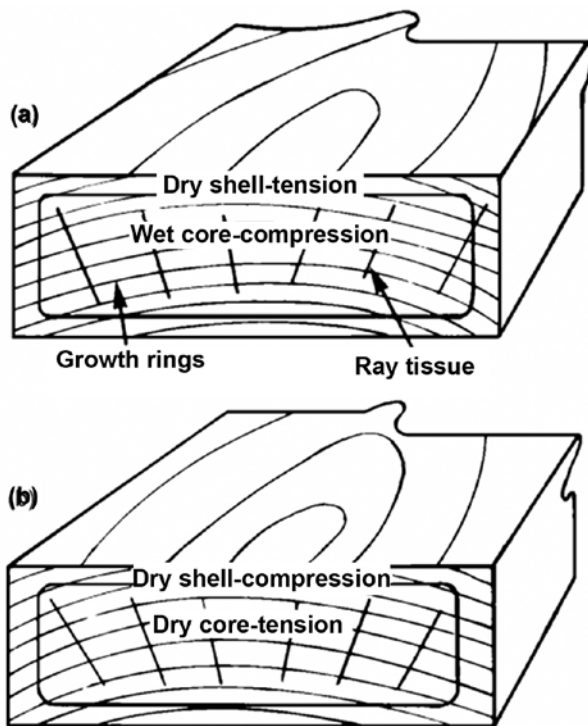

Figure 13-3. End view of board showing development of drying stresses (a) early and (b) later in drying.

though longitudinal diffusion is much faster than diffusion across the grain, it generally is not of practical importance in lumber that is many times longer than it is thick. In addition, a direct result of longitudinal diffusion may be end-checking or splitting without proper care.

Because chemical extractives in heartwood plug up passageways, moisture generally moves more freely in sapwood than in heartwood; thus, sapwood generally dries faster than heartwood. However, the heartwood of many species is lower in moisture content than is the sapwood. Thus heartwood can reach final moisture content as fast as the sapwood.

The rate at which moisture moves in wood depends on the relative humidity of the surrounding air, the steepness of the moisture gradient, and the temperature of the wood. Lower relative humidity increases capillary flow. Low relative humidity also stimulates diffusion by lowering the moisture content at the surface, thereby steepening the moisture gradient and increasing the diffusion rate. The greater the temperature of the wood, the faster moisture will move from the wetter interior to the drier surface, thus the steeper the moisture gradient. If relative humidity is too low in the early stages of drying, excessive shrinkage may occur, resulting in surface and end checking. If the temperature is too high, collapse, honeycomb, or strength reduction can occur.

Drying Stresses

Drying stresses are the main cause of nonstain-related drying defects. Understanding these stresses provides a means for minimizing and recognizing the damage they can cause. The cause of drying stresses is the differential shrinkage between the outer part of a board (the shell) and the interior part (the core) that can result in drying defects. Early in drying, the fibers in the shell dry first and begin to shrink. However, the core has not yet begun to dry and shrink; consequently, the core prevents the shell from shrinking fully. Thus, the shell goes into tension and the core into compression (Fig. 13-3). If the shell dries too rapidly, it is stressed beyond the elastic limit and dries in a permanently stretched (set) condition without attaining full shrinkage. Sometimes surface cracks, or checks, occur from this initial stage of drying and can be a serious defect for many uses. As drying progresses, the core begins to dry and attempts to shrink. However, the shell is set in a permanently expanded condition and prevents normal shrinkage of the core. This causes the stresses to reverse; the core goes into tension and the shell into compression. The change in the shell and core stresses and in the moisture content level during drying is shown in Figure 13-4. These internal tension stresses may be severe enough to cause internal cracks (honeycomb).

Differential shrinkage caused by differences in radial, tangential, and longitudinal shrinkage is a major cause of warp. The distortions shown in Figure 4-3 in Chapter 4 are due to differential shrinkage. When juvenile or reaction wood is present on one edge or face of a board and normal wood is

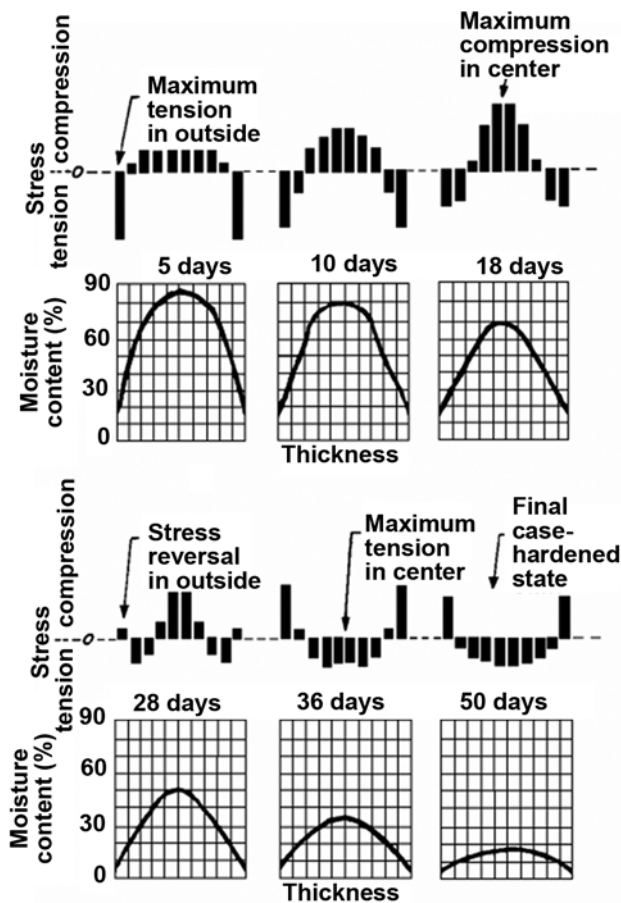

Figure 13-4. Moisture-stress relationship during six stages of kiln drying 50-mm- (2-in.-) thick red oak.

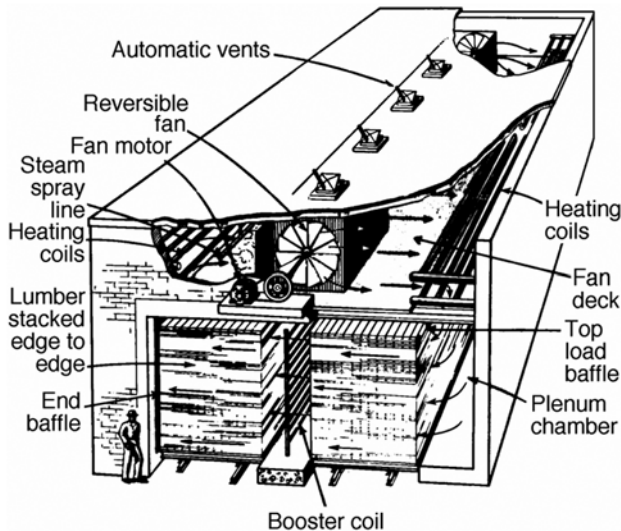

Figure 13-5. Lineshaft, double-track, compartment kiln with alternately opposing fans. Vents are over fan shaft between fans. Vent on high pressure side of fans becomes fresh air inlet when direction of circulation is reversed.

present on the opposite side, the difference in their longitudinal shrinkage can also cause warp.

Dry Kilns

Most dry kilns are thermally insulated compartments designed for a batch process in which the kiln is completely loaded with lumber in one operation and the lumber remains stationary during the entire drying cycle. Temperature and relative humidity are kept as uniform as possible throughout the kiln and can be controlled over a wide range. As the wood dries, kiln temperature and relative humidity change based on a schedule that takes into account the moisture content or the drying rate, or both, of the lumber. All dry kilns use some type of forced-air circulation, with air moving through the lumber perpendicular to the length of the lumber and parallel to the spacers (stickers) that separate each layer of lumber in a stack. This forced-air circulation allows for uniform air flow in the dry kiln.

Three general types of kilns are in common use. One is the track-loaded type (Fig. 13-5), where lumber is stacked on kiln trucks that are rolled in and out of the kiln on tracks. Most softwood lumber in the United States is dried in this kiln type. Another major type is the package-loaded kiln (Fig. 13-6), where individual stacks of lumber are fork-lifted into place in the kiln. Package-loaded kilns are commonly used for drying hardwood lumber. Indirect-steam heat is common for these two types although softwood lumber kilns are sometimes directly heated using combustion gases from burning fuel. A third common type of kiln, usually package loaded, is the dehumidification kiln. Instead of venting humid air to remove water, as the other two types of kilns do, water is removed by condensation on cold dehumidifier coils (Fig. 13-7).

Kiln Schedules

A kiln schedule is a carefully developed compromise between the need to dry lumber as fast as possible for economic efficiency and the need to avoid severe drying conditions that will lead to drying defects. A kiln schedule is a series of temperatures and relative humidities that are applied at various stages of drying. In most schedules, the temperature is gradually increased and the relative humidity decreased, thus lowering the EMC. The schedule for Southern Pine structural lumber is an exception to this general rule. This is lumber usually dried at a constant temperature and relative humidity. Temperatures are chosen to balance the highest drying rate with the avoidance of objectionable drying defects. The stresses that develop during drying are the limiting factor in determining the kiln schedule. The schedule must be developed so that the drying stresses do not exceed the strength of the wood at any given temperature and moisture content. Otherwise, the wood will crack either on the surface or internally or be crushed by forces that collapse the wood cells. Wood generally becomes stronger as the moisture content decreases, and to a lesser

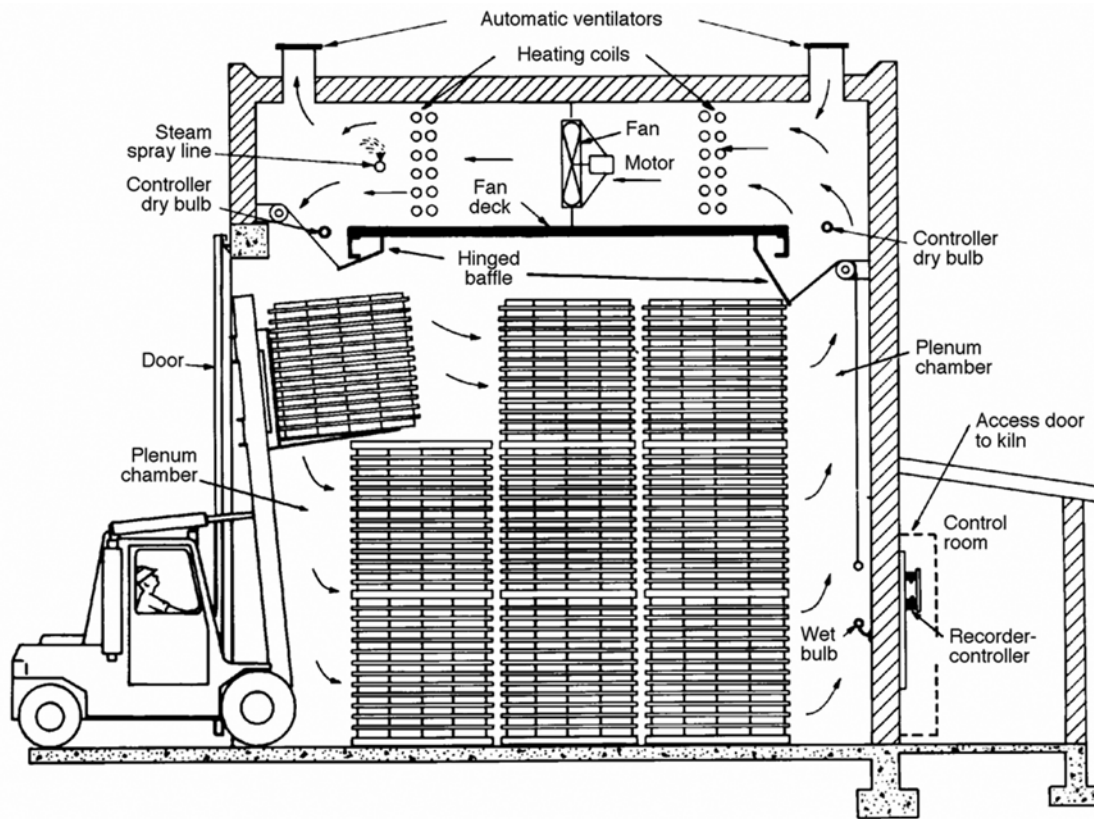

Figure 13–6. Package-loaded kiln with fans connected directly to motors.

extent, it becomes weaker as temperature increases. The net result is that as wood dries it becomes stronger because of the decreasing moisture content and can tolerate higher drying temperatures and lower relative humidities without cracking. This is a fortunate circumstance because as wood dries, its drying rate decreases at any given temperature, and the ability to increase drying temperature helps maintain a reasonably fast drying rate. Thus, rapid drying is achieved in kilns by the use of temperatures as high as possible and relative humidities as low as possible.

Drying schedules vary by species, thickness, grade, moisture content, and end use of lumber. The two general types of kiln schedules are moisture content schedules and time-based schedules. Most hardwood lumber is dried by moisture content schedules. This means that the temperature and relative humidity conditions are changed according to the percentage moisture content of the lumber during drying. A typical hardwood schedule might begin at 49 °C (120 °F) and 80% relative humidity when the lumber is green. By the time the lumber has reached 15% moisture content, the temperature is as high as 82 °C (180 °F). A typical hardwood drying schedule is shown in Table 13–3. Some method of monitoring moisture content during drying is required for schedules based on moisture content. One common method is the use of kiln samples that are periodically weighed, usually manually but potentially remotely with load cells.

Alternatively, imbedded electrodes in sample boards sense the change in electrical conductivity with moisture content. This system is limited to moisture content values less than 30% (Simpson 1991, Denig and others 2000).

Softwood kiln schedules generally differ from hardwood schedules in that changes in kiln temperature and relative humidity are made at predetermined times rather than moisture content levels. Examples of time-based schedules, both conventional temperature (<100 °C (<212 °F)) and high temperature (>110 °C (>230 °F)), are given in Table 13–3. Some hardwoods used as structural lumber also use a time-based schedule as shown in Table 13–3 (Simpson and Wang 2001, Ross and Erickson 2005).

Drying Defects

Most drying defects or problems that develop in wood products during drying can be classified as fracture or distortion, warp, or discoloration. Defects in any one of these categories are caused by an interaction of wood properties with processing factors. Wood shrinkage is mainly responsible for wood ruptures and distortion of shape. Cell structure and chemical extractives in wood contribute to defects associated with uneven moisture content, undesirable color, and undesirable surface texture. Drying temperature is the most important processing factor because it can be responsible for defects in each category.

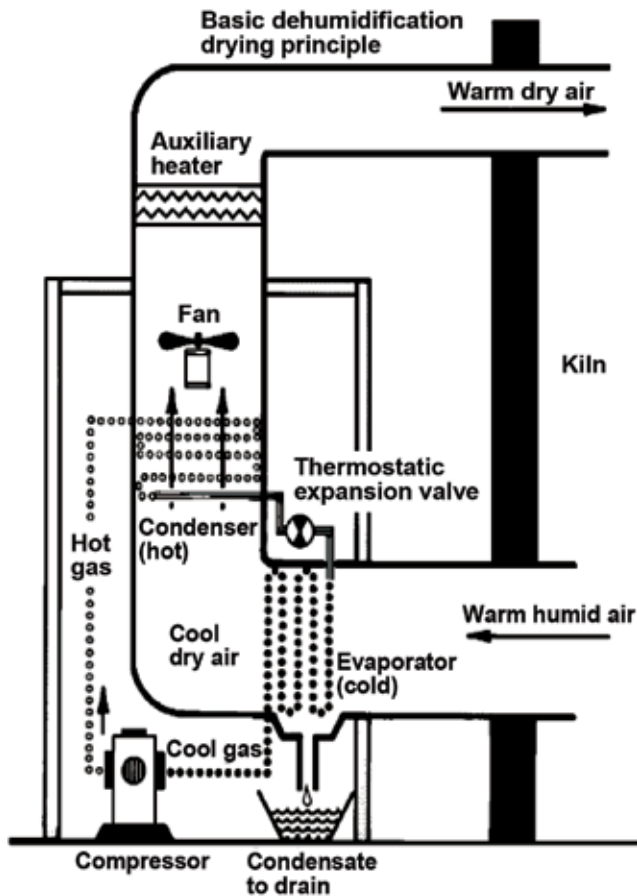
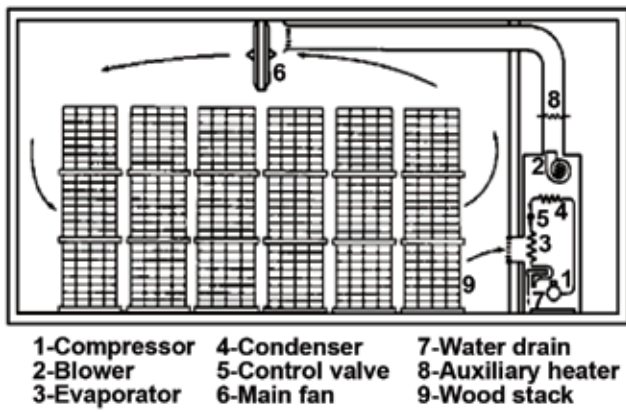

Figure 13-7. A typical dehumidification kiln (top) and dehumidification drying system (bottom).

Fracture or Distortion

Surface checks occur early in drying when the shell of a board is stressed in tension enough to fracture the wood. These checks occur most often on the face of flatsawn boards and are illustrated in Figure 13-8. End checks (Fig. 13-9) are similar to surface checks but appear on the ends of boards and logs. End checks occur because the rapid longitudinal movement of moisture causes the end to dry very quickly and develop high stresses, therefore

fracturing. End coatings, on either the log or freshly sawn (green) lumber, are an effective preventative measure. Collapse is a distortion, flattening, or crushing of wood cells. In severe cases (Fig. 13-10), collapse usually shows up as grooves or corrugations, a washboarding effect. Less severe collapse shows up as excessive thickness shrinkage and may not be a serious problem. Honeycomb (Fig. 13-11) is an internal crack that occurs in the later stages of kiln drying when the core of a board is in tension. This internal defect is caused when the core is still at a relatively high moisture content and drying temperatures are too high for too long during this critical drying period. It may go unnoticed until the lumber is machined. Nondestructive testing methods, using speed of sound, have been found to be effective in detecting the presence of these cracks in dried lumber. Knots may loosen during drying because of the unequal shrinkage between the knot and the surrounding wood (Fig. 13-12).

Warp

Warp in lumber is any deviation of the face or edge of a board from flatness or any edge that is not at right angles to the adjacent face or edge. Warp can be traced to two causes: (a) differences between radial, tangential, and longitudinal shrinkage in the piece as it dries or (b) growth stresses. Warp is aggravated by irregular or distorted grain and the presence of abnormal types of wood, such as juvenile and reaction wood. The six major types of warp are bow, crook, twist, oval, diamond, and cup (Fig. 13-13).

Discoloration

Discoloration impairs the use of dried wood products, particularly when the end use requires a clear, natural finish. Unwanted discoloration can develop in the tree, during storage of logs and green lumber, or during drying. The two general types of discoloration are chemical and fungal.

Chemical discoloration is the result of oxidative and enzymatic reactions with chemical compounds in wood. Discolorations range from pinkish, bluish, and yellowish hues through gray and reddish brown to dark brown shades. Brown stain in pines and darkening in many hardwoods is a common problem when drying temperatures are too high (Fig. 13-14). A deep grayish-brown chemical discoloration can occur in many hardwood species if initial drying is too slow or too high of an initial kiln temperature (Fig. 13-15) (Wiemann and others 2009).

Fungal stains, often referred to as blue or sap stain, are caused by fungi that grow in the sapwood (Fig. 13-16). Blue-stain fungi do not cause decay of the sapwood, and fungi generally do not grow in heartwood. Blue stain can develop if initial drying is too slow.

Another common type of stain develops under stickers (Fig. 13-17). This stain results from contact of the sticker with the board. Sticker stains (sometimes called shadow) are imprints of the sticker that are darker or lighter than the wood between the stickers and can be caused by either chemical or fungal action, or both.

Table 13–3. Typical dry kiln schedules for lumber**Moisture-content-based schedule for 25-mm (1-in.) (4/4) black walnut, dried to 7% moisture content**

Moisture content (%)	Temperature (°C (°F))		Relative humidity (%)	Equilibrium moisture content (%)
	Dry-bulb	Wet-bulb		
Above 50	49.0 (120)	45.0 (113)	80	14.4
50 to 40	49.0 (120)	43.5 (110)	72	12.1
40 to 35	49.0 (120)	40.5 (105)	60	9.6
35 to 30	49.0 (120)	35.0 (95)	40	6.5
30 to 25	54.5 (130)	32.0 (90)	22	4.0
25 to 20	60.0 (140)	32.0 (90)	15	2.9
20 to 15	65.5 (150)	37.5 (100)	18	3.2
15 to 7	82.2 (180)	54.4 (130)	27	3.7
Equalize	82.2 (180)	58.3 (137)	30	3.8
Condition	82.2 (180)	76.7 (170)	79	11.1

Time-based schedule for 25- to 50-mm (1- to 2-in.) (4/4 to 8/4) Douglas-fir, upper grades, dried to 12% moisture content

Time (h)	Temperature (°C (°F))		Relative humidity (%)	Equilibrium moisture content (%)
	Dry-bulb	Wet-bulb		
0 to 12	76.5 (170)	73.5 (164)	86	14.1
12 to 24	76.5 (170)	71.0 (160)	78	11.4
24 to 48	79.5 (175)	71.0 (160)	69	9.1
48 to 72	82.2 (180)	71.0 (160)	62	7.7
72 to 96	82.2 (180)	60.0 (140)	36	4.5

or until dry

High-temperature schedule for 50- by 100-mm to 50- by 250-mm (2- by 4-in. to 2- by 10-in.) Southern Pine, dried to 15% moisture content

Time (h)	Temperature (°C (°F))		Relative humidity (%)	Equilibrium moisture content (%)
	Dry-bulb	Wet-bulb		
0 until dry	116 (240)	82.2 (180)	29	2.5

Time-based schedule for 50- by 150-mm (2- by 6-in.) sugar maple, dried to 15% moisture content in 5 days

Time (h)	Temperature (°C (°F))		Relative humidity (%)	Equilibrium moisture content (%)
	Dry-bulb	Wet-bulb		
0 to 24	71.0 (160)	67.2 (153)	84	14.1
24 to 48	71.0 (160)	65.6 (150)	78	12.1
48 to 60	71.0 (160)	62.8 (145)	69	10.1
60 to 72	71.0 (160)	57.2 (135)	52	7.4
72 to 84	76.7 (170)	54.4 (130)	35	4.9
84 to 115	82.2 (180)	54.4 (130)	27	3.7

Moisture Content of Dried Lumber

Although widely used, the trade terms “shipping dry,” “air dry,” and “kiln dry” may not have identical meanings as to moisture content in the different producing regions. Despite the wide variations in the use of these terms, they are sometimes used to describe dried lumber. The following statements, which are not exact definitions, outline these categories.

Shipping Dry

Shipping dry means lumber that has been partially dried to prevent stain or mold during brief periods of transit; ideally the outer 3.2 mm (1/8 in.) is dried to 25% or less moisture content (McMillen 1978).

Air Dry

Air dry means lumber dried by exposure to the air outdoors or in a shed or by forced circulation of air that has not been



Figure 13-8. Surface checking on white oak 5/4 lumber.



Figure 13-11. Red cedar timber end shows honey-comb (top). Surface of the timber shows no honey-comb (bottom).



Figure 13-9. End checking in red pine logs.



Figure 13-10. Severe collapse in western redcedar.

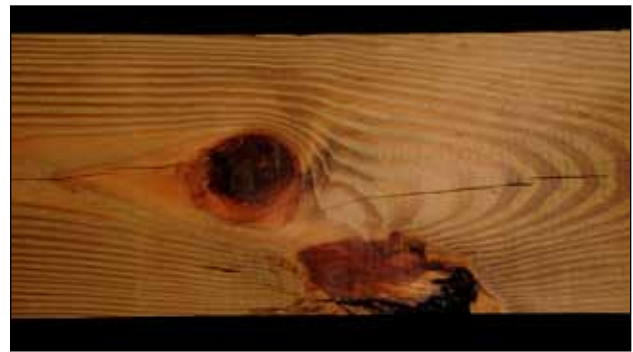

Figure 13-12. Large knot in treated Southern Pine.

heated above 49 °C (120 °F). Commercial air-dry stock generally has an average moisture content low enough for rapid kiln drying or rough construction use. Moisture content is generally in the range of 20% to 25% for dense hardwoods and 15% to 20% for softwoods and low-density hardwoods. Extended exposure can bring standard 19- and 38-mm (nominal 1- and 2-in.) lumber within one or two percentage points of the average exterior equilibrium moisture content of the region. For much of the United States, the minimum moisture content of thoroughly air-dried lumber is 12% to 15%.

Kiln Dry

Kiln dry means lumber that has been dried in a kiln or by some special drying method to an average moisture content

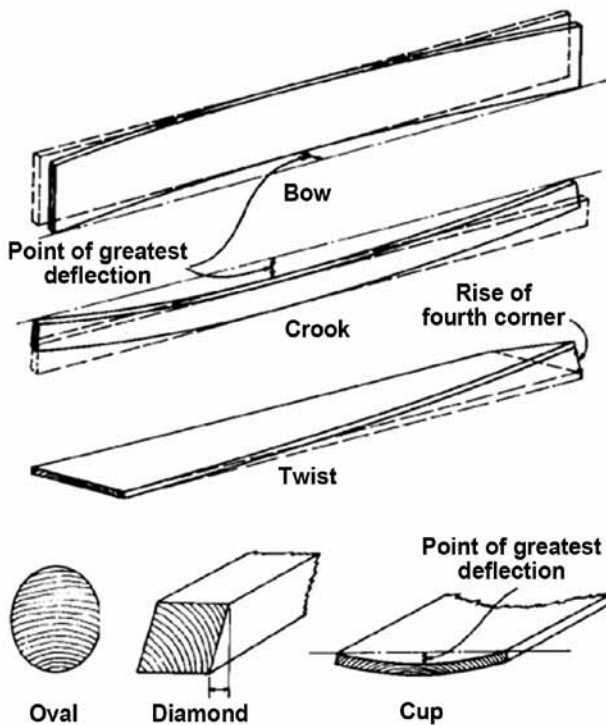

Figure 13-13. Various types of warp that can develop in boards during drying.

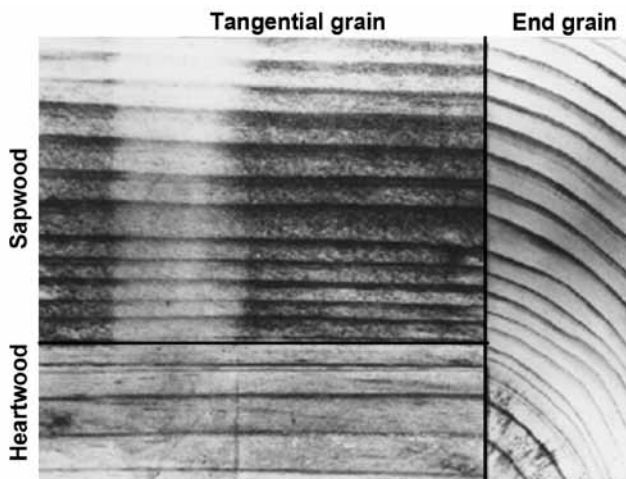

Figure 13-14. Brown sapwood stain in Southern Pine lumber.

specified or understood to be suitable for a certain use. The average moisture content should have upper and lower tolerance limits, and all values should fall within these limits. If the moisture contents fall outside these limits, use the dry kiln to equalize the lumber until the moisture is inside these limits. Kiln-dried softwood dimension lumber generally has an average moisture content of 19% or less; the average moisture content for many other softwood uses is 10% to 20%. Hardwood and softwood lumber for furniture,



Figure 13-15. Soft maple sapwood boards (surface, end, edge) showing patches of oxidative stain.

cabinetry, and millwork usually has a final moisture content of 6% to 8% and can be specified to be free of drying stresses. Drying stresses built up during the drying cycle are relieved by conditioning inside the dry kiln. The importance of suitable moisture content values is recognized, and provisions covering them are now incorporated in some softwood standards as grading rules. Moisture content values in the general grading rules may or may not be suitable for a specific use; if not, a special moisture content specification should be made (USDC 2005).

Moisture Control during Transit and Storage

Lumber and other wood items may change in moisture content and dimension while awaiting shipment, during fabrication, in transit, and in storage.

When standard 19-mm (nominal 1-in.) dry softwood lumber is shipped in tightly closed boxcars, shipping containers, or trucks or in packages with complete and intact wrappers, average moisture content changes for a package can generally be held to 0.2% or less per month. In holds or between decks of ships, dry material usually adsorbs about 1.5% moisture during normal shipping periods. If green material is included in the cargo, the moisture regain of the dry lumber may be doubled. On the top deck, if unprotected from the elements, the moisture regain can be as much as 7%.

When standard 19-mm (nominal 1-in.) softwood lumber, kiln dried to 8% or less, is piled solid under a good pile roof in a yard in warm, humid weather, average moisture content of a pile can increase at the rate of about 2% per month during the first 45 days. A moisture uptake rate of about 1% per month can then be sustained throughout a humid season. Comparable initial and sustaining moisture uptake rates are about 1% per month in open (roofed) sheds and 0.3% per month in closed sheds. Stock piled for a year in an open



Figure 13–16. Sap stain in Ponderosa Pine. Color ranges from bluish gray to black.

shed in a western location increased 2.7% on the inside of solid piles and 3.5% on the outside of the piles. Protect all manufactured stock from precipitation and spray, because liquid water on a solid pile tends to be absorbed by the wood instead of evaporating. The extent to which additional control of the storage environment is required depends upon the final use of the wood and the corresponding moisture content recommendations. It is important to determine the moisture content of all stock when received. If moisture content is not as specified or required, stickered storage in an appropriate condition could ultimately bring the stock within the desired moisture content range. If a large degree of moisture change is required, the stock must be redried (Rietz 1978).

Plywood and Structural Items

It is good practice to open-pile green or partially dried lumber and timbers using stickers and protect from sunshine and precipitation by a tight roof. Framing lumber and plywood with 20% or less moisture content can be solid-piled (no stickers) in a shed that has good protection against sunshine and direct or wind-driven precipitation. However, a better practice for stock with greater than 12% moisture content is

the use of stickered piling to bring moisture content more in line with the moisture content in use. Dry lumber piled solid in the open for relatively short periods with a minimum pile cover of waterproofed paper whenever possible. Because keeping rain out completely is difficult, storing solid-piled lumber in the open for long periods is not recommended. If framing lumber must be stored in the open for a long time, pile on stickers with good base support and cover the piles. Re-pile using stickers for solid-piled material that has become wet again is good practice.

Finish and Factory Lumber

Keep kiln-dried items such as exterior finish, siding, and exterior millwork in a closed unheated shed. Place material on supports raised above the floor, at least 150 mm (6 in.) high if the floor is paved or 300 mm (12 in.) if not paved. Interior trim, flooring, cabinet work, and lumber for processing into furniture should be stored in a room or closed shed where relative humidity is controlled. In addition, store kiln-dried and machined hardwood dimension or softwood cut stock under controlled humidity conditions.

Dried and machined hardwood dimension or softwood lumber intended for remanufacture should also be stored under controlled humidity conditions. Under uncontrolled conditions, the ends of such stock may attain a higher moisture content than the rest of the stock. Then, when the stock is straight-line ripped or jointed before edge gluing, subsequent shrinkage will cause splitting or open glue joints at the ends of panels. The simplest way to reduce relative humidity in storage areas of all sizes is to heat the closed space to a temperature slightly higher than that of the outside air. Dehumidifiers can be used in small, well-enclosed spaces.

If the heating method is used, and there is no source of moisture except that contained in the air, the equilibrium moisture content can be maintained by increasing the temperature of the storage area greater than the outside temperature by the amounts shown in Table 13–4. When a dehumidifier is used, monitor or control if needed the average temperature in the storage space. Select the proper relative humidity in Table 4–2 in Chapter 4 to give the desired average moisture content. Wood in a factory awaiting or following manufacture can become too dry if the area is heated to 21 °C (70 °F) or greater when the outdoor temperature is low. This often occurs in the northern United States during the winter. Under such circumstances, exposed ends and surfaces of boards or cut pieces will tend to dry to the low equilibrium moisture content condition, causing shrinkage and warp. In addition, an equilibrium moisture content of 4% or more below the moisture content of the core of freshly crosscut boards can cause end checking. Simple remedies are to cover piles of partially manufactured items with plastic film and lower the shop temperature during non-work hours. Increased control can be obtained in critical shop and



Figure 13–17. Sticker stain in sapwood of sugar maple after planing.

storage areas by humidification. In warm weather, cooling can increase relative humidity and dehumidification may be necessary (FPL 1972).

Dimensional Changes in Wood

Dry wood undergoes small changes in dimension with normal changes in relative humidity. More humid air will cause slight swelling, and drier air will cause slight shrinkage. These changes are considerably smaller than those involved with shrinkage from the green condition. Equation (13–2) can be used to approximate dimensional changes caused by shrinking and swelling by using the total shrinkage coefficient from green to oven-dry. However, the equation assumes that the shrinkage–moisture content relationship is linear. Figure 4–4 (Chap. 4) shows that this is not the case, so some error is introduced. The error is in the direction of

underestimating dimensional change, by about 5% of the true change. Many changes of moisture content in use are over the small moisture content range of 6% to 14%, where the shrinkage–moisture content relationship is linear (Chap. 4, Fig. 4–4). Therefore, a set of shrinkage coefficients based on the linear portion of the shrinkage–moisture content curve has been developed (Table 13–5). Estimating approximate changes in dimension using this simple equation utilizes these dimensional change coefficients, from Table 13–5, when moisture content remains within the range of normal use. (Dimensional changes are further discussed in Chaps. 4 and 7.)

Estimation Using Dimensional Change Coefficient

The change in dimension within the moisture content limits of 6% to 14% can be estimated satisfactorily by using a dimensional change coefficient based on the dimension at 10% moisture content:

$$\Delta D = D_1 [C_T (M_F - M_1)] \quad (13-2)$$

where ΔD is change in dimension, D_1 dimension in units of length at start of change, C_T dimensional change coefficient tangential direction (for radial direction, use C_R), M_F moisture content (%) at end of change, and M_1 moisture content (%) at start of change.

Values for C_T and C_R , derived from total shrinkage values, are given in Table 13–5. When $M_F < M_1$, the quantity $(M_F - M_1)$ will be negative, indicating a decrease in dimension; when greater, it will be positive, indicating an increase in dimension.

As an example, assuming the width of a flat-grained white fir board is 232 mm (9.15 in.) at 8% moisture content, its change in width at 11% moisture content is estimated as

$$\begin{aligned} \Delta D &= 232[0.00245(11 - 8)] \\ &= 232(0.00735) \\ &= 1.705 \text{ mm} \end{aligned}$$

$$\begin{aligned} \Delta D &= 9.15[0.00245(11 - 8)] \\ &= 9.15[0.00735] \\ &= 0.06725 \text{ or } 0.067 \text{ in.} \end{aligned}$$

Table 13–4. Increase in storage area temperature above outside temperature to maintain the desired wood moisture content

Outside relative humidity (%)	Temperature differential (°C (°F)) for desired wood moisture content						
	6%	7%	8%	9%	10%	11%	12%
90	18.3 (33)	16.1 (29)	12.8 (23)	10.0 (18)	8.3 (15)	6.1 (11)	5.0 (9)
80	16.7 (30)	13.9 (25)	10.5 (19)	7.8 (14)	6.1 (11)	4.4 (8)	3.3 (6)
70	13.9 (25)	11.1 (20)	8.3 (15)	5.6 (10)	3.9 (7)	2.2 (4)	1.7 (3)
60	11.1 (20)	8.3 (15)	5.0 (9)	3.3 (6)	1.7 (3)	—	—
50	8.3 (15)	5.6 (10)	2.8 (5)	0.6 (1)	—	—	—

Table 13–5. Dimensional change coefficients (C_R , radial; C_T , tangential) for shrinking or swelling within moisture content limits of 6% to 14%

Species	Dimensional change coefficient ^a		Species	Dimensional change coefficient ^a	
	C_R	C_T		C_R	C_T
Hardwoods					
Alder, red	0.00151	0.00256	Honeylocust	0.00144	0.00230
Apple	0.00205	0.00376	Locust, black	0.00158	0.00252
Ash, black	0.00172	0.00274	Madrone, Pacific	0.00194	0.00451
Ash, Oregon	0.00141	0.00285	Magnolia, cucumbertree	0.00180	0.00312
Ash, pumpkin	0.00126	0.00219	Magnolia, southern	0.00187	0.00230
Ash, white	0.00169	0.00274	Magnolia, sweetbay	0.00162	0.00293
Ash, green	0.00169	0.00274	Maple, bigleaf	0.00126	0.00248
Aspen, quaking	0.00119	0.00234	Maple, red	0.00137	0.00289
Basswood, American	0.00230	0.00330	Maple, silver	0.00102	0.00252
Beech, American	0.00190	0.00431	Maple, black	0.00165	0.00353
Birch, paper	0.00219	0.00304	Maple, sugar	0.00165	0.00353
Birch, river	0.00162	0.00327	Oak, black	0.00123	0.00230
Birch, yellow	0.00256	0.00338	Red Oak, commercial	0.00158	0.00369
Birch, sweet	0.00256	0.00338	Red oak, California	0.00123	0.00230
Buckeye, yellow	0.00123	0.00285	Red oak: water, laurel, willow	0.00151	0.00350
Butternut	0.00116	0.00223	White Oak, commercial	0.00180	0.00365
Catalpa, northern	0.00085	0.00169	White oak, live	0.00230	0.00338
Cherry, black	0.00126	0.00248	White oak, Oregon white	0.00144	0.00327
Chestnut, American	0.00116	0.00234	White oak, overcup	0.00183	0.00462
Cottonwood, black	0.00123	0.00304	Persimmon, common	0.00278	0.00403
Cottonwood, eastern	0.00133	0.00327	Sassafras	0.00137	0.00216
Elm, American	0.00144	0.00338	Sweetgum	0.00183	0.00365
Elm, rock	0.00165	0.00285	Sycamore, American	0.00172	0.00296
Elm, slippery	0.00169	0.00315	Tanoak	0.00169	0.00423
Elm, winged	0.00183	0.00419	Tupelo, black	0.00176	0.00308
Elm, cedar	0.00183	0.00419	Tupelo, water	0.00144	0.00267
Hackberry	0.00165	0.00315	Walnut, black	0.00190	0.00274
Hickory, pecan	0.00169	0.00315	Willow, black	0.00112	0.00308
Hickory, true	0.00259	0.00411	Willow, Pacific	0.00099	0.00319
Holly, American	0.00165	0.00353	Yellow-poplar	0.00158	0.00289
Softwoods					
Baldcypress	0.00130	0.00216	Pine, eastern white	0.00071	0.00212
Cedar, yellow-	0.00095	0.00208	Pine, jack	0.00126	0.00230
Cedar, Atlantic white-	0.00099	0.00187	Pine, loblolly	0.00165	0.00259
Cedar, Eastern Red	0.00106	0.00162	Pine, pond	0.00165	0.00259
Cedar, incense	0.00112	0.00180	Pine, lodgepole	0.00148	0.00234
Cedar, northern white- ^b	0.00101	0.00229	Pine, Jeffrey	0.00148	0.00234
Cedar, Port-Orford-	0.00158	0.00241	Pine, longleaf	0.00176	0.00263
Cedar, western red ^b	0.00111	0.00234	Pine, ponderosa	0.00133	0.00216
Douglas-fir, Coast-type	0.00165	0.00267	Pine, red	0.00130	0.00252
Douglas-fir, Interior north	0.00130	0.00241	Pine, shortleaf	0.00158	0.00271
Douglas-fir, Interior west	0.00165	0.00263	Pine, slash	0.00187	0.00267
Fir, balsam	0.00099	0.00241	Pine, sugar	0.00099	0.00194
Fir, California red	0.00155	0.00278	Pine, Virginia	0.00144	0.00252
Fir, noble	0.00148	0.00293	Pine, western white	0.00141	0.00259
Fir, Pacific silver	0.00151	0.00327	Redwood, old-growth ^b	0.00120	0.00205
Fir, subalpine	0.00088	0.00259	Redwood, second-growth ^b	0.00101	0.00229
Fir, grand	0.00112	0.00245	Spruce, black	0.00141	0.00237
Fir, white	0.00112	0.00245	Spruce, Engelmann	0.00130	0.00248

Table 13–5. Dimensional change coefficients (C_R , radial; C_T , tangential) for shrinking or swelling within moisture content limits of 6% to 14%—con.

Species	Dimensional change coefficient ^a			Dimensional change coefficient ^a	
	C_R	C_T		C_R	C_T
Hemlock, eastern	0.00102	0.00237	Spruce, red	0.00130	0.00274
Hemlock, western	0.00144	0.00274	Spruce, white	0.00130	0.00274
Larch, western	0.00155	0.00323	Spruce, Sitka	0.00148	0.00263
			Tamarack	0.00126	0.00259
Imported Woods					
Andiroba, crabwood	0.00137	0.00274	Light red “Philippine mahogany”	0.00126	0.00241
Angelique	0.00180	0.00312	Limba	0.00151	0.00187
Apitong, keruing ^b	0.00243	0.00527	Mahogany ^b	0.00172	0.00238
(all <i>Dipterocarpus</i> spp.)			Meranti	0.00126	0.00289
Avodire	0.00126	0.00226	Obeche	0.00106	0.00183
Balsa	0.00102	0.00267	Okoume	0.00194	0.00212
Banak	0.00158	0.00312	Parana, pine	0.00137	0.00278
Cativo	0.00078	0.00183	Paumarfim	0.00158	0.00312
Cuangare	0.00183	0.00342	Primavera	0.00106	0.00180
Greenheart ^b	0.00390	0.00430	Ramin	0.00133	0.00308
Iroko ^b	0.00153	0.00205	Santa Maria	0.00187	0.00278
Khaya	0.00141	0.00201	Spanish-cedar	0.00141	0.00219
Kokrodua ^b	0.00148	0.00297	Teak ^b	0.00101	0.00186
Lauans: dark red	0.00133	0.00267			
“Philippine mahogany”					

^aPer 1% change in moisture content, based on dimension at 10% moisture content and a straight-line relationship between moisture content at which shrinkage starts and total shrinkage. (Shrinkage assumed to start at 30% for all species except those indicated by footnote b.)

^bShrinkage assumed to start at 22% moisture content.

Then, dimension at end of change

$$D_1 + \Delta D = 232 + 1.7 \quad (= 9.15 + 0.067)$$

$$= 233.7 \text{ mm} \quad (= 9.217 \text{ in.})$$

The thickness of the same board at 11% moisture content can be estimated by using the coefficient $C_R = 0.00112$.

Because commercial lumber is often not perfectly flatsawn or quartersawn, this procedure will probably overestimate width shrinkage and underestimate thickness shrinkage. Note also that if both a size change and percentage moisture content are known, Equation (13–2) can be used to calculate the original moisture content.

Calculation Based on Green Dimensions

Approximate dimensional changes associated with moisture content changes greater than 6% to 14%, or when one moisture content value is outside of those limits, can be calculated by

$$\Delta D = \frac{D_1(M_F - M_1)}{30(100)/S_T - 30 + M_1} \quad (13-3)$$

where S_T is tangential shrinkage (%) from green to oven-dry (Chap. 4 Tables 4–3 and 4–4) (use radial shrinkage S_R when appropriate).

Neither M_1 nor M_F should exceed 30%, the assumed moisture content value when shrinkage starts for most species.

Design Factors Affecting Dimensional Change

Framing Lumber in House Construction

Ideally, house framing lumber should be dried to the moisture content it faces in use to minimize dimensional changes as a result of frame shrinkage. This ideal condition is difficult to achieve, but some drying and shrinkage of the frame may take place without being visible or causing serious defects after the house is completed. If, at the time the wall and ceiling finish is applied, the moisture content of the framing lumber is not more than about 5% above that which it will reach in service, there will be little or no evidence of defects caused by shrinkage of the frame. For heated houses in cold climates, joists over heated basements, studs, and ceiling joists may reach a moisture content as low as 6% to 7% (Table 13–2). In mild climates, the minimum moisture content will be greater.

The most common signs of excessive shrinkage are cracks in plastered walls, truss rise, open joints, and nail pops in dry-wall construction; distortion of door openings; uneven floors; and loosening of joints and fastenings. The extent of vertical shrinkage after the house is completed is proportional to the depth of wood used as supports in a horizontal position, such as girders, floor joists, and plates. After all,

shrinkage occurs primarily in the width and thickness of members, not the length.

Thoroughly consider the type of framing best suited to the whole building structure. Methods should be chosen that will minimize or balance the use of wood across the grain in vertical supports. These involve variations in floor, wall, and ceiling framing. The factors involved and details of construction are covered extensively in *Wood-Frame House Construction* (Sherwood and Stroh 1991).

Heavy Timber Construction

In heavy timber construction, a certain amount of shrinkage is to be expected. A column that bears directly on a wood girder can result in a structure settling as a result of the perpendicular-to-grain shrinkage of the girder. If not provided for in the design, shrinkage may cause weakening of the joints or uneven floors or both. One means of eliminating part of the shrinkage in mill buildings and similar structures is to use metal post caps; the metal in the post cap separates the upper column from the lower column. The same thing is accomplished by bolting wood corbels (tassels or braggers) to the side of the lower column to support the girders.

When joist hangers are installed, the top of the joist should be above the top of the girder; otherwise, when the joist shrinks in the stirrup, the floor over the girder will be higher than that bearing upon the joist. Heavy planking used for flooring should be near 12% moisture content to minimize openings between boards as they approach moisture equilibrium. When standard 38- or 64-mm (nominal 2- or 3-in.) joists are nailed together to provide a laminated floor of greater depth for heavy design loads, the joist material should be somewhat less than 12% moisture content if the building is to be heated.

Interior Finish

Normal seasonal changes in the moisture content of interior finish are not enough to cause serious dimensional change if the woodwork was properly installed. Large members, such as ornamental beams, cornices, newel posts, stair stringers, and handrails, should be built up from comparatively small pieces. Wide door and window trim and base should be hollow-backed. Backband trim, if mitered at the corners, should be glued and splined before erection; otherwise butt joints should be used for the wide faces. Design and install large, solid pieces, such as wood paneling, so that the panels are free to move across the grain. Narrow widths are preferable.

Flooring

Flooring is usually dried to the moisture content expected in service so that shrinking and swelling are minimized and buckling or large gaps between boards do not occur. For basement, large hall, or gymnasium floors, however, leave enough space around the edges to allow for some expansion.

Wood Care and Installation during Construction

Lumber and Trusses

Although it is good housekeeping practice, lumber is often not protected from the weather at construction sites. Lumber is commonly placed on the ground in open areas near the building site as bulked and strapped packages. Place supports under such packages that elevate the packages at least 150 mm (6 in.) off the ground to prevent wetting from mud and ground water. In addition, cover the packages with plastic tarpaulins for protection from rain.

Pile lumber that is green or nearly green on stickers under a roof for additional drying before building into the structure. The same procedure is required for lumber treated with a waterborne preservative but not fully re-dried. Prefabricated building parts, such as roof trusses, sometimes lie unprotected on the ground at the building site. In warm, rainy weather, moisture regain can result in fungal staining. Wetting of the lumber also results in swelling, and subsequent shrinkage of the framing may contribute to structural distortions. Extended storage of lumber at moisture contents greater than 20% without drying can allow decay to develop.

If framing lumber has a greater moisture content when installed than that recommended in Table 13–2, shrinkage can be expected. Framing lumber, even thoroughly air-dried stock, will generally have a moisture content greater than that recommended when it is delivered to the building site. If carelessly handled in storage at the site, the lumber can take up more moisture. Builders can schedule their work so an appreciable amount of drying can take place during the early stages of construction. This minimizes the effects of additional drying and shrinkage after completion. When the house has been framed, sheathed, and roofed, the framing is so exposed that in time it can dry to a lower moisture content than could be found in yard-dried lumber. The application of the wall and ceiling finish is delayed while wiring and plumbing are installed. If this delay is about 30 days in warm, dry weather, the framing lumber should lose enough moisture so that any additional drying in place will be minimal. In cool, damp weather, or if wet lumber is used, the period of exposure should be extended. Checking moisture content of door and window headers and floor and ceiling joists at this time with an electric moisture meter is good practice. When these members approach an average of 12% moisture content, interior finish and trim can normally be installed. Closing the house and using the heating system will hasten the rate of drying.

Before the wall finish is applied, the frame should be examined and defects that may have developed during drying, such as warped or distorted studs, shrinkage of lintels (header) over openings, or loosened joints, should be corrected.

Exterior Trim and Millwork

Exterior trim, such as cornice and rake mouldings, fascia boards, and soffit material, is typically installed before the shingles are laid. Protect trim, siding, and window and door frames on the site by storing in the house or garage until time of installation. Although items such as window frames and sashes are usually treated with some type of water-repellent preservative to resist absorption of water, store in a protected area if they cannot be installed soon after delivery. Wood siding is often received in packaged form and can ordinarily remain in the package until installation.

Finished Flooring

Cracks develop in flooring if the material takes up moisture either before or after installation, then shrinks when the building is heated. Such cracks can be greatly reduced by observing the following practices:

- Specify flooring manufactured according to association rules and sold by dealers that protect the material properly during storage and delivery.
- Measure random pieces of flooring using a non-penetrating meter to ensure moisture content is correct upon arrival and prior to installation.
- Have flooring delivered after masonry and plastering are completed and fully dry, unless a dry storage space is available.
- Install the heating plant before flooring is delivered.
- Break open flooring bundles and expose all sides of flooring to the atmosphere inside the structure.
- Close up the house at night and increase the temperature about 8 °C (15 °F) greater than the outdoor temperature for about 3 days before laying the floor.
- If the house is not occupied immediately after the floor is laid, keep the house closed at night or during damp weather and supply some heat if necessary.

Better and smoother sanding and finishing can be done when the house is warm and the wood has been kept dry (FPL 1961).

Interior Trim

In a building under construction, average relative humidity will be greater than that in an occupied house because of the moisture that evaporates from wet concrete, brickwork, plaster, and even the structural wood members. The average temperature will be lower because workers prefer a lower temperature than is common in an occupied house. Under such conditions, the interior trim tends to have greater moisture content during construction than it will have during occupancy.

Before the interior trim is delivered, the outside doors and windows should be kept closed at night. In this way, interior conditions are held as close as possible to the higher

temperature and lower humidity that ordinarily occurs during the day. Such protection may be sufficient during dry warm weather, but during damp or cool weather, it is highly desirable to heat the house, particularly at night. Whenever possible, the heating plant should be placed in the house before the interior trim is installed, to be available for supplying the necessary heat. Portable heaters can also be used. Keep the inside temperature during the night about 8 °C (15 °F) greater than the outside temperature but not below about 21 °C (70 °F) during the summer or 17 °C (62 °F) when the outside temperature is below freezing.

After buildings have thoroughly dried, less heat is needed, but unoccupied houses, new or old, should have some heat during the winter. A temperature of about 8 °C (15 °F) greater than the outside temperature and above freezing at all times will keep the woodwork, finish, and other parts of the house from being affected by dampness or frost.

Plastering

During a plastering operation in a moderate-sized, six-room house, approximately 450 kg (1,000 lb) of water is used, all of which must dissipate before the house is ready for the interior finish. Adequate ventilation removes the evaporated moisture and keeps it from being adsorbed by the framework. In houses plastered in cold weather, the excess moisture can also cause paint to blister on exterior finish and siding. During warm, dry weather, with the windows wide open, the moisture will be gone within a week after the final coat of plaster is applied. During damp, cold weather, the heating system or portable heaters are used to prevent freezing of plaster and to hasten its drying. Provide adequate ventilation constantly because a large volume of air is required to carry away the amount of water involved. Even in the coldest weather, the windows on the side of the house away from the prevailing winds should be opened 50 to 75 mm (2 to 3 in.), preferably from the top.

Literature Cited

ASTM. 2007. Standard test methods for direct moisture content measurement of wood and wood-base materials. Standard D 4442. West Conshohocken, PA: ASTM International.

Boone, R.S.; Kozlik, C.J.; Bois, P.J.; Wengert, E.M. 1988. Dry kiln schedules for commercial woods: temperate and tropical. Gen. Tech. Rep. FPL-GTR-57. Madison, WI: U.S. Department of Agriculture, Forest Service, Forest Products Laboratory. 158 p.

Denig, J.; Wengert E.M.; Simpson, W.T. 2000. Drying hardwood lumber. Gen. Tech. Rep. FPL-GTR-118. Madison, WI: U.S. Department of Agriculture, Forest Service, Forest Products Laboratory. 138 p.

FPL. 1961. Wood floors for dwellings. Agric. Handb. 204. Washington, DC: U.S. Department of Agriculture, Forest Service. 44 p.

- FPL. 1972. Methods of controlling humidity in woodworking plants. Res. Note FPL–RN–0218. Madison, WI: U.S. Department of Agriculture, Forest Service, Forest Products Laboratory. 6 p.
- James, W.L. 1988. Electric moisture meters for wood. Gen. Tech. Rep. FPL–GTR–6. Madison, WI: U.S. Department of Agriculture, Forest Service, Forest Products Laboratory. 17 p.
- McMillen, J.M. 1978. Overseas protection of logs and lumber. Madison, WI: U.S. Department of Agriculture, Forest Service, Forest Products Laboratory. 4 p.
- Rietz, R.C. 1978. Storage of lumber. Agric. Handb. 531. Washington, DC: U.S. Department of Agriculture. 63 p.
- Rietz, R.C.; Page, R.H. 1971. Air drying of lumber: A guide to industry practices. Agric. Handb. 402. Washington, DC: U.S. Department of Agriculture. 120 p.
- Ross, R.J.; Erickson, J.R. 2005. Undervalued Hardwoods for Engineered Materials and Components. Forest Products Society. Madison, WI. 144 p.
- Sherwood, G.E.; Stroh, R.C. 1991. Wood-frame house construction. Agric. Handb. 73. Washington, DC: U.S. Department of Agriculture. 268 p.
- Simpson, W.T., ed. 1991. Dry kiln operator's manual. Agric. Handb. 188. Washington, DC: U.S. Department of Agriculture, Forest Service, Forest Products Laboratory. 274 p.
- Simpson, W.T. 1998. Equilibrium moisture content of wood in outdoor locations in the United States and worldwide. Res. Note FPL–RN–268. Madison, WI: U.S. Department of Agriculture, Forest Service, Forest Products Laboratory. 11 p.
- Simpson, W.T.; Wang, X. 2001. Time-based kiln drying schedule for sugar maple for structural uses. Res. Note FPL–RN–0279. Madison, WI: USDA Forest Service, Forest Products Laboratory. 4 p.
- USDC. 2005. American softwood lumber standard. NIST Voluntary Product Standard PS 20–05. Washington, DC: U.S. Department of Commerce. 50 p.
- Wiemann, M.C.; Bergman, R.D.; Knaebe, M.; Bowe, S.A. 2009. Exploring methods for prevention of oxidative stain in soft maple. Res. Pap. FPL–RP–654. Madison, WI: U.S. Department of Agriculture, Forest Service, Forest Products Laboratory. 6 p.

Biodeterioration of Wood

Carol A. Clausen, Supervisory Research Microbiologist

Contents

Fungus Damage and Control	14–1
Molds and Fungal Stains	14–1
Chemical Stains	14–2
Decay	14–3
Prevention of Mold, Stain, and Decay	14–6
Bacteria	14–9
Insect Damage and Control	14–9
Beetles	14–9
Termites	14–11
Carpenter Ants	14–13
Carpenter Bees	14–13
Marine Borer Damage and Control	14–13
Shipworms	14–13
Pholads	14–14
<i>Limnoria</i> and <i>Sphaeroma</i>	14–14
Protection from Marine Borers	14–14
References	14–15

Under proper conditions, wood will give centuries of service. However, under conditions that permit the development of wood-degrading organisms, protection must be provided during processing, merchandising, and use.

The organisms that can degrade wood are principally fungi, insects, bacteria, and marine borers.

Molds, most sapwood stains, and decay are caused by fungi, which are microscopic, thread-like microorganisms that must have organic material to live. For some of them, wood offers the required food supply. The growth of fungi depends on suitably mild temperatures, moisture, and air (oxygen). Chemical stains, although they are not caused by organisms, are mentioned in this chapter because they resemble stains caused by fungi.

Insects also may damage wood and in many situations must be considered in protective measures. Termites are the major insect enemy of wood, but on a national scale, they are a less serious threat than fungi.

Bacteria in wood ordinarily are of little consequence, but some may make the wood excessively absorptive. In addition, some may cause strength losses over long periods of exposure, particularly in forest soils.

Marine borers can attack susceptible wood rapidly in salt water harbors, where they are the principal cause of damage to piles and other wood marine structures.

Wood degradation by organisms has been studied extensively, and many preventive measures are well known and widely practiced. By taking ordinary precautions with the finished product, the user can contribute substantially to ensuring a long service life.

Fungus Damage and Control

Fungus damage to wood may be traced to three general causes: (a) lack of suitable protective measures when storing logs or bolts; (b) improper seasoning, storing, or handling of the raw material produced from the log; and (c) failure to take ordinary simple precautions in using the final product. The incidence and development of molds, decay, and stains caused by fungi depend heavily on temperature and moisture conditions (Fig. 14–1).

Molds and Fungal Stains

Molds and fungal stains are confined to a great extent to sapwood and are of various colors. The principal fungal

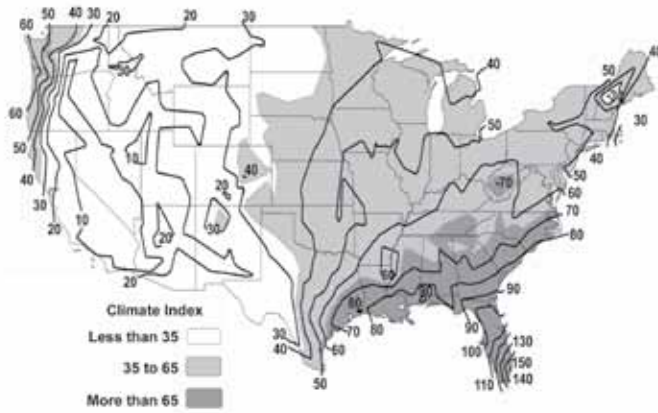

Figure 14–1. Climate index for decay hazard. Higher numbers indicate greater decay hazard.

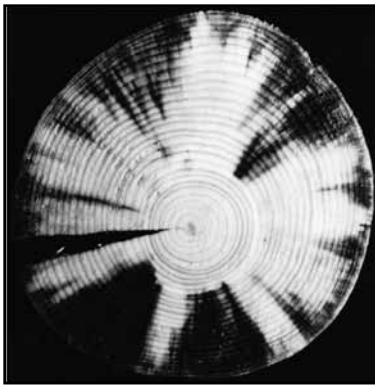

Figure 14–2. Typical radial penetration of log by stain. The pattern is a result of more rapid penetration by the fungus radially (through the ray) than tangentially.

stains are usually referred to as sap stain or blue stain. The distinction between molding and staining is made primarily on the basis of the depth of discoloration. With some molds and the lesser fungal stains, there is no clear-cut differentiation. Typical sap stain or blue stain penetrates into the sapwood and cannot be removed by surfacing. Also, the discoloration as seen on a cross section of the wood often appears as pie-shaped wedges oriented radially, corresponding to the direction of the wood rays (Fig. 14–2). The discoloration may completely cover the sapwood or may occur as specks, spots, streaks, or patches of various intensities of color. The so-called blue stains, which vary from bluish to bluish black and gray to brown, are the most common, although various shades of yellow, orange, purple, and red are sometimes encountered. The exact color of the stain depends on the infecting organisms and the species and moisture condition of the wood. The fungal brown stain mentioned here should not be confused with chemical brown stain.

Mold discolorations usually become noticeable as fuzzy or powdery surface growths, with colors ranging from light shades to black. Among the brighter colors, green and yellowish hues are common. On softwoods, though the fungus may penetrate deeply, the discoloring surface growth often can easily be brushed or surfaced off. However, on large-

pored hardwoods (for example, oaks), the wood beneath the surface growth is commonly stained too deeply to be surfaced off. The staining tends to occur in spots of various concentration and size, depending on the kind and pattern of the superficial growth.

Under favorable moisture and temperature conditions, staining and molding fungi may become established and develop rapidly in the sapwood of logs shortly after they are cut. In addition, lumber and such products as veneer, furniture stock, and millwork may become infected at any stage of manufacture or use if they become sufficiently moist. Freshly cut or unseasoned stock that is piled during warm, humid weather may be noticeably discolored within 5 or 6 days. Recommended moisture control measures are given in Chapter 13.

Ordinarily, stain and mold fungi affect the strength of the wood only slightly; their greatest effect is usually confined to strength properties that determine shock resistance or toughness (Chap. 5). They increase the absorbency of wood, and this can cause over-absorption of glue, paint, or wood preservative during subsequent processing. Increased porosity also makes wood more wettable, which can lead to subsequent colonization by typical wood-decay fungi.

Stain- and mold-infected stock is practically unimpaired for many uses in which appearance is not a limiting factor, and a small amount of stain may be permitted by standard grading rules. Stock with stain and mold may not be entirely satisfactory for siding, trim, and other exterior millwork because of its greater water absorbency. Also, incipient decay may be present, though inconspicuous, in the discolored areas. Both of these factors increase the possibility of decay in wood that is rain-wetted unless the wood has been treated with a suitable preservative.

Chemical Stains

Nonmicrobial or chemical stains are difficult to control and represent substantial loss in wood quality. These stains, which should not be confused with fungal brown stain, include a variety of discolorations in wood that are often promoted by slow drying of lumber and warm to hot temperatures. Such conditions allow naturally occurring chemicals in wood to react with air (enzymatic oxidation) to form a new chemical that is typically dark in color. Common chemical stains include (a) interior sapwood graying, prevalent in oak, hackberry, ash, and maple, (b) brown stain in softwoods, and (c) pinking and browning in the interior of light-colored woods such as maple. Another common discoloration, iron stain, is caused by the interaction of iron with tannins in wood. Iron stain is more prevalent in hardwoods (for example, oak and many tropical hardwoods) and in some softwoods such as Douglas-fir. Control is achieved by eliminating the source of iron.

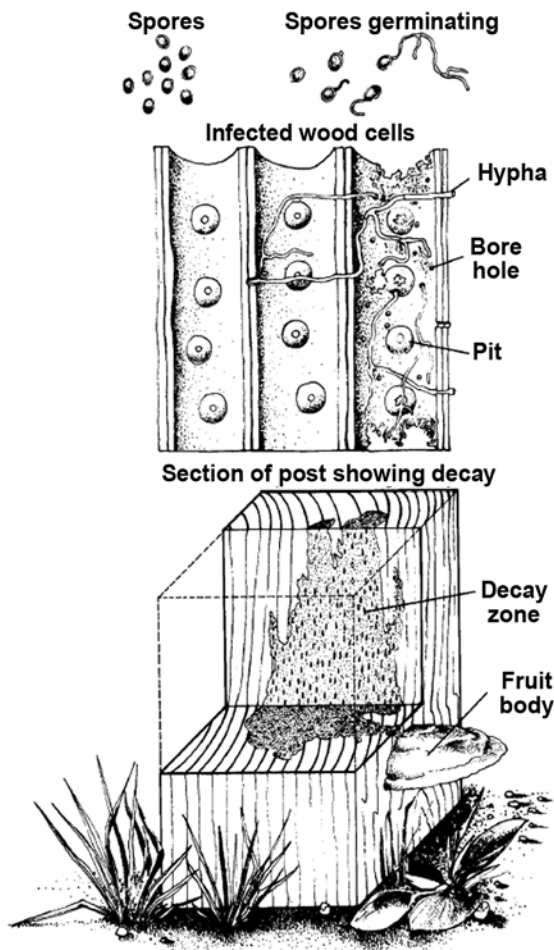

Figure 14-3. The decay cycle (top to bottom). Thousands of spores produced in a fungal fruiting body are distributed by wind or insects. On contacting moist, susceptible wood, spores germinate and fungal hyphae create new infections in the wood cells. In time, serious decay develops that may be accompanied by formation of new fruiting bodies.

Decay

Decay-producing fungi may, under conditions that favor their growth, attack either heartwood or sapwood in most wood species (Fig. 14-3). The result is a condition designated as decay, rot, dote, or doze. Fresh surface growths of decay fungus may appear as fan-shaped patches (Fig. 14-4), strands, or root-like structures that are usually white or brown in color. Sometimes fruiting bodies are produced that take the form of mushrooms, brackets, or crusts. The fungus, in the form of microscopic, threadlike strands called hyphae, permeates the wood and uses parts of it as food. Some fungi live largely on cellulose, whereas others use lignin and cellulose.

Certain decay fungi colonize the heartwood (causing heart rot) and rarely the sapwood of living trees, whereas others confine their activities to logs or manufactured products,



Figure 14-4. Mycelial fans on a wood door.

such as sawn lumber, structural timbers, poles, and ties. Most fungi that attack trees cease their activities after the trees have been cut, as do the fungi causing brown pocket (peck) in baldcypress or white pocket in Douglas-fir and other conifers. Relatively few fungi continue their destruction after the trees have been cut and worked into products and then only if conditions remain favorable for their growth. Although heartwood is more susceptible to decay than is sapwood in living trees, for many species, the sapwood of wood products is more susceptible to decay than is the heartwood.

Most decay can progress rapidly at temperatures that favor growth of plant life in general. For the most part, decay is relatively slow at temperatures below 10 °C (50 °F) and above 35 °C (95 °F). Decay essentially ceases when the temperature drops as low as 2 °C (35 °F) or rises as high as 38 °C (100 °F).

Serious decay occurs only when the moisture content of the wood is above the fiber saturation point (average 30%). Only when previously dried wood is contacted by water in the form of rain or condensation or is in contact with wet ground will the fiber saturation point be reached. By itself, the water vapor in humid air will not wet wood sufficiently to support significant decay, but it will permit development of some mold fungi. Fully air-dried wood usually will have a moisture content not exceeding 20% and should provide a reasonable margin of safety against fungal damage. Thus, wood will not decay if it is kept air dry, and decay already present from prior infection will not progress.

Wood can be too wet for decay as well as too dry. If the wood is water-soaked, the supply of air to the interior of a piece may not be adequate to support development of typical decay fungi. For this reason, foundation piles buried beneath the water table and logs stored in a pond or under a suitable system of water sprays are not subject to decay by typical wood-decay fungi.

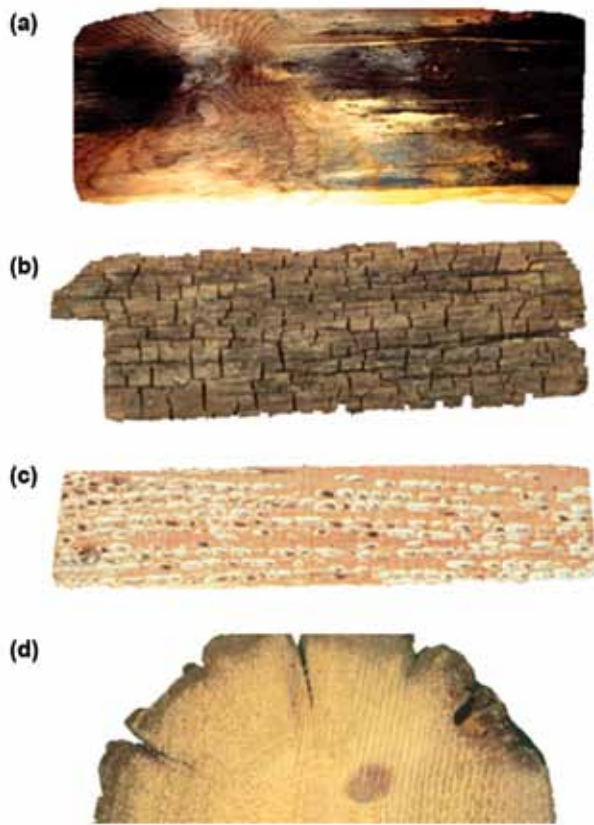

Figure 14–5. Representative samples of four common types of fungal growth on wood: (a) mold discoloration; (b) brown rotted pine (note the dark color and cubical checking in the wood); (c) white rot in maple (note the bleached appearance); (d) soft-rotted preservative-treated pine utility pole (note the shallow depth of decay).

The early or incipient stages of decay are often accompanied by a discoloration of the wood, which can be difficult to recognize but is more evident on freshly exposed surfaces of unseasoned wood than on dry wood. Abnormal mottling of the wood color, with either unnatural brown or bleached areas, is often evidence of decay infection. Many fungi that cause heart rot in the standing tree produce incipient decay that differs only slightly from the normal color of the wood or gives a somewhat water-soaked appearance to the wood.

Typical or late stages of decay are easily recognized, because the wood has undergone definite changes in color and properties, the character of the changes depending on the organism and the substances it removes.

Two kinds of major decay fungi are recognized: brown rot and white rot. With brown-rot fungi, only the cellulose is extensively removed, the wood takes on a browner color, and it can crack across the grain, shrink, collapse, and be crushed into powder (Fig. 14–5). With white-rot fungi, both lignin and cellulose usually are removed, the wood may lose color and appear “whiter” than normal, it does not crack across the grain, and until severely degraded, it retains its

outward dimensions, does not shrink or collapse, and often feels spongy (Fig. 14–5). Brown-rot fungi commonly colonize softwoods, and white-rot fungi commonly occur on hardwoods, but both brown- and white-rot fungi occasionally colonize both types of wood.

Brown, crumbly rot, in the dry condition, is sometimes called dry rot, but the term is incorrect because wood must be damp to decay, although it may become dry later. A few fungi, however, have water-conducting strands; such fungi are capable of carrying water (usually from the soil) into buildings or lumber piles, where they moisten and rot wood that would otherwise be dry. They are sometimes referred to technically as dry-rot fungi or water-conducting fungi. The latter term better describes the true situation because these fungi, like the others, must have water.

A third and generally less important kind of decay is known as soft rot. Soft rot is caused by fungi related to the molds rather than those responsible for brown and white rot. Soft rot typically is relatively shallow, primarily affecting the outer surface of wood; the affected wood is greatly degraded and often soft when wet, but immediately beneath the zone of rot, the wood may be firm (Fig. 14–5). Because soft rot usually is rather shallow, it is most damaging to relatively thin pieces of wood such as slats in cooling towers. It is favored by wet situations but is also prevalent on surfaces that have been alternately wet and dry over a substantial period. Heavily fissured surfaces, familiar to many as weathered wood, generally have been quite degraded by soft-rot fungi.

Decay Resistance of Wood

The heartwood of common native species of wood has various degrees of natural decay resistance. Untreated sapwood of essentially all species has low resistance to decay and usually has a short service life under conditions favoring decay. The natural decay resistance of heartwood is greatly affected by differences in preservative qualities of the wood extractives, the attacking fungus, and the conditions of exposure. Considerable differences in service life can be obtained from pieces of wood cut from the same species, even the same tree, and used under apparently similar conditions. There are further complications because, in a few species, such as the spruces and the true firs (not Douglas-fir), heartwood and sapwood are so similar in color that they cannot be easily distinguished.

Precise ratings of decay resistance of heartwood of different species are not possible because of differences within species and the variety of service conditions to which wood is exposed. However, broad groupings of many native species, based on service records, laboratory tests, and general expertise, are helpful in choosing heartwood for use under conditions favorable to decay. Groupings by natural resistance of some domestic and imported wood species to decay fungi are shown in Table 14–1, which ranks the heartwood of a grouping of species according to decay resistance. The

Table 14–1. Grouping of some domestic and imported woods according to average heartwood decay resistance^a

Very resistant	Resistant	Moderately resistant	Slightly or nonresistant
Domestic			
Black locust	Baldcypress, old growth	Baldcypress, young growth	Alder, red
Mulberry, red	Catalpa	Cherry, black	Ashes
Osage-orange	Cedar	Douglas-fir	Aspens
Yew, Pacific	Atlantic white	Honey locust	Beech
	Eastern redcedar	Larch, western	Birches
	Incense	Pine, eastern white, old growth	Buckeye
	Northern white	Pine, longleaf, old growth	Butternut
	Port-Orford	Pine, slash, old growth	Cottonwood
	Western redcedar	Redwood, young growth	Elms
	Yellow	Tamarack	Basswood
	Chestnut		Firs, true
	Cypress, Arizona		Hackberry
	Junipers		Hemlocks
	Mesquite		Hickories
	Oaks, white ^b		Magnolia
	Redwood, old growth		Maples
	Sassafras		Pines (other than those listed) ^b
	Walnut, black		Spruces
			Sweetgum
			Sycamore
			Tanoak
			Willows
			Yellow-poplar
Imported			
Angelique	Aftotmosia (Kokrodua)	Andiroba	Balsa
Azobe	Apamate (Roble)	Avodire	Banak
Balata	Balau ^b	Benge	Cativo
Goncalo alves	Courbaril	Bubinga	Ceiba
Greenheart	Determa	Ehie	Hura
Ipe (lapacho)	Iroko	Ekop	Jelutong
Jarrah	Kapur	Keruing ^b	Limba
Lignumvitae	Karri	Mahogany, African	Meranti, light red ^b
Purpleheart	Kempas	Meranti, dark red ^b	Meranti, yellow ^b
Teak, old growth	Mahogany, American	Mersawa ^b	Meranti, white ^b
	Manni	Sapele	Obeche
	Spanish-cedar	Teak, young growth	Okoume
	Sucupira	Tornillo	Parana pine
	Wallaba		Ramin
			Sande
			Sepitir
			Seraya, white

^aDecay resistance may be less for members placed in contact with the ground and/or used in warm, humid climates.

Substantial variability in decay resistance is encountered with most species, and limited durability data were available for some species listed. Use caution when using naturally durable woods in structurally critical or ground-contact applications.

^bMore than one species included, some of which may vary in resistance from that indicated.

extent of variations in decay resistance of individual trees or wood samples of a particular species is much greater for most of the more resistant species than for the slightly or nonresistant species.

Natural resistance of wood to fungi is important only where conditions conducive to decay exist or may develop. Where decay hazard exists, heartwood of a species in the resistant category generally gives satisfactory service for wood used above-ground, while those in the very resistant category

generally give satisfactory performance in contact with the ground. Heartwood of species in the other two categories will usually require some form of preservative treatment. For mild decay conditions, a simple preservative treatment—such as a short soak in preservative after all cutting and boring operations are complete—may be adequate for wood low in decay resistance. For more severe decay hazards, pressure treatment is often required. Even the very decay-resistant species may require preservative treatment for important structural uses or other uses where failure would

endanger life or require expensive repairs. When selecting naturally decay-resistant wood species for applications where conditions are conducive to decay, it is important to utilize heartwood. Marketable sizes of some species are primarily second growth and contain a high percentage of sapwood. Consequently, substantial quantities of heartwood lumber of these species are not available. If wood is subjected to severe decay conditions, pressure-treated wood, rather than resistant heartwood, is generally recommended. Preservative treatments and methods are discussed in Chapter 15.

Effect of Decay on Strength of Wood

Decay initially affects toughness, or the ability of wood to withstand impacts. This is generally followed by reductions in strength values related to static bending. Eventually, all strength properties are seriously reduced.

Strength losses during early stages of decay can be considerable, depending to a great extent upon the fungi involved and, to a lesser extent, upon the type of wood undergoing decay. In laboratory tests, losses in toughness ranged from 6% to >50% by the time 1% weight loss had occurred in the wood as a result of fungal attack. By the time weight losses resulting from decay have reached 10%, most strength losses may be expected to exceed 50%. At such weight losses (10% or less), decay is detectable only microscopically. It may be assumed that wood with visually discernible decay has been greatly reduced in all strength values.

Prevention of Mold, Stain, and Decay

Logs, Poles, Piles, and Ties

The wood species, geographic region, and time of year determine what precautions must be taken to avoid serious damage from fungi in logs, poles, piles, ties, and similar thick products during seasoning or storage. In dry climates, rapid surface seasoning of poles and piles will retard development of mold, stain, and decay. The bark is peeled from the pole and the peeled product is decked on high skids or piled on high, well-drained ground in the open to air-dry. In humid regions, such as the Gulf States, these products often do not air-dry fast enough to avoid losses from fungi. Pre-seasoning treatments with approved preservative solutions can be helpful in these circumstances.

For logs, rapid conversion into lumber or storage in water or under a water spray (Fig. 14–6) is the surest way to avoid fungal damage. Preservative sprays promptly applied to the wood will protect most timber species during storage for 2 to 3 months, except in severe decay hazard climates, such as in Mississippi (Fig. 14–1). For longer storage, an end coating is needed to prevent seasoning checks, through which infection can enter the log.

Lumber

Growth of decay fungi can be prevented in lumber and other wood products by rapidly drying them to a moisture content of 20% or less and keeping them dry. Standard air-



Figure 14–6. Spraying logs with water protects them against fungal stain and decay.



Figure 14–7. A sanitary, well-drained air-drying yard.

drying practices will usually dry the wood fast enough to protect it, particularly if the protection afforded by drying is supplemented by dip or spray treatment of the stock with an EPA-approved fungicidal solution. Successful control by this method depends not only upon immediate and adequate treatment but also upon proper handling of the lumber after treatment. However, kiln drying is the most reliable method of rapidly reducing moisture content.

Air-drying yards should be kept as sanitary and as open as possible to air circulation (Fig. 14–7). Recommended practices include locating yards and sheds on well-drained ground; removing debris (which serves as a source of infection) and weeds (which reduce air circulation); and employing piling methods that permit rapid drying of the lumber and protect against wetting. Storage sheds should be constructed and maintained to prevent significant wetting of the stock. Ample roof overhang on open sheds is desirable. In areas where termites or water-conducting fungi may be troublesome, stock to be held for long periods should be set on foundations high enough so that the wood can be inspected from beneath.

The user's best assurance of receiving lumber free from decay other than light stain is to buy stock marked by a lumber association in a grade that eliminates or limits such

Chapter 14 Biodeterioration of Wood

quality-reducing features. Surface treatment for protection at the drying yard is only temporarily effective. Except for temporary structures, lumber to be used under conditions conducive to decay should be all heartwood of a naturally durable wood species or should be adequately treated with a wood preservative (Chap. 15).

Buildings

The lasting qualities of properly constructed wood buildings are apparent in all parts of the country. Serious decay problems are almost always a sign of faulty design or construction, lack of reasonable care in the handling the wood, or improper maintenance of the structure.

Construction principles that ensure long service and avoid decay in buildings include (a) building with dry lumber, free of incipient decay and not exceeding the amounts of mold and blue stain permitted by standard grading rules; (b) using construction details and building designs that will keep exterior wood and wood-based building components dry and that will promote their drying if they become wet; (c) using wood treated with a preservative or heartwood of a decay-resistant species for parts exposed to aboveground decay hazards; and (d) using pressure-treated wood for the high hazard situation associated with ground contact.

A building site that is dry or for which drainage is provided will reduce the possibility of decay. Grading around the building is an important consideration, as is adequate planning for management of roof runoff (Chap. 17). Stumps, wood debris, stakes, or wood concrete forms are frequently subject to decay if left under or near a building and may become a source for decay infestation for the building.

Wet or infected wood should not be enclosed until it is thoroughly dried. Wet wood includes green (unseasoned) lumber, lumber that has been inadequately dried, or dried lumber that has been rewetted as a result of careless storage and handling. Wood can become infected because of improper handling at the sawmill or retail yard or after delivery to the job site.

Untreated wood parts of substructures should not be permitted to contact the soil. Minimums of 200 mm (8 in.) clearance between soil and framing and 150 mm (6 in.) between soil and siding are recommended. Where frequent hard rains occur, a foundation height above grade of 300 to 460 mm (12 to 18 in.) is advocated. An exception may be made for certain temporary constructions. If contact with soil is unavoidable, the wood should be pressure treated (Chap. 15).

Sill plates and other wood resting on a concrete slab foundation generally should be pressure treated and protected by installing a moisture-resistant membrane, such as polyethylene, beneath the slab. Girder and joist openings in masonry walls should be big enough to ensure an air space around the ends of these wood members. If the members are below the outside soil level, moisture proofing the outer face of the wall is essential.

In buildings without basements but with crawl spaces, wetting of the floor framing and sheathing by condensation may result in serious decay damage. The primary source of condensation is soil moisture. Isolating the crawl space from soil moisture can be achieved by laying a barrier such as polyethylene on the soil. To facilitate inspection of the crawl space, a minimum 460-mm (18-in.) clearance should be left under wood joists.

Wood and wood-based building components should also be protected from rain during construction. Continuous protection from rainwater or condensation in walls and roofs will prevent the development of decay. Thus, design, work quality, and maintenance of wall and roofing systems are critical, particularly at roof edges and points where roofs interface with walls. A fairly wide roof overhang (0.6 m (2 ft)) with gutters and downspouts that are kept free of debris is desirable.

The use of sound, dry lumber is equally important for the interior of buildings. Primary sources for interior moisture are humidity and plumbing leaks. Interior humidity control is discussed in Chapter 17. Plumbing leaks can result in serious decay problems within buildings, particularly if they are undetected for long periods.

Where service conditions in a building are such that the wood cannot be kept dry, the use of preservative-treated wood (Chap. 15) or heartwood of a durable species is advised. Examples include porches, exterior steps, and decking platforms and such places as textile mills, pulp and paper mills, and cold storage plants.

In making repairs necessitated by decay, every effort should be made to correct the moisture condition that led to the damage. If the condition cannot be corrected, all infected parts should be replaced with preservative-treated wood or with all-heartwood lumber of a naturally decay-resistant wood species. If the sources of moisture that caused the decay are entirely eliminated, it is necessary only to replace the weakened wood with dry lumber.

Other Structures and Products

In general, the principles underlying the prevention of mold, stain, or decay damage to veneer, plywood containers, boats, and other wood products and structures are similar to those described for buildings—dry the wood rapidly and keep it dry, or treat it with approved protective and preservative solutions. Interior grades of plywood should not be used where the plywood will be exposed to moisture; the adhesives, as well as the wood, may be damaged by fungi and bacteria and degraded by moisture. With exterior-type panels, joint construction should be carefully designed to prevent the entrance and entrapment of rainwater.

In treated bridge or wharf timbers, checking may occur and may expose untreated wood to fungal attack. Annual in-place treatment of these checks will provide protection from

Table 14–2. Types of damage caused by wood-attacking insects

Type of damage	Description	Causal agent	Damage	
			Begins	Ends
Pin holes	0.25 to 6.4 mm (1/100 to 1/4 in.) in diameter, usually circular Tunnels open:			
	Holes 0.5 to 3 mm (1/50 to 1/8 in.) in diameter, usually centered in dark streak or ring in surrounding wood	Ambrosia beetles	In living trees and unseasoned logs and lumber	During seasoning
	Holes variable sizes; surrounding wood rarely dark stained; tunnels lined with wood-colored substance	Timber worms	In living trees and unseasoned logs and lumber	Before seasoning
	Tunnels usually packed with fine sawdust: Exit holes 0.8 to 1.6 mm (1/32 to 1/16 in.) in diameter; in sapwood of large-pored hardwoods; loose floury sawdust in tunnels	Lyctid powder-post beetles	During or after seasoning	Reinfestation continues until sapwood destroyed
	Exit holes 1.6 to 3 mm (1/16 to 1/8 in.) in diameter; primarily in sapwood, rarely in heartwood; tunnels loosely packed with fine sawdust and elongate pellets	Anobiid powder-post beetles	Usually after wood in use (in buildings)	Reinfestation continues; progress of damage very slow
	Exit holes 2.5 to 7 mm (3/32 to 9/32 in.) in diameter; primarily sapwood of hardwoods, minor in softwoods; sawdust in tunnels fine to coarse and tightly packed	Bostrichid powder-post beetles	Before seasoning or if wood is rewetted	During seasoning or redrying
Grub holes	Exit holes 1.6 to 2 mm (1/16 to 1/12 in.) in diameter; in slightly damp or decayed wood; very fine sawdust or pellets tightly packed in tunnels	Wood-boring weevils	In slightly damp wood in use	Reinfestation continues while wood is damp
	3 to 13 mm (1/8 to 1/2 in.) in diameter, circular or oval			
	Exit holes 3 to 13 mm (1/8 to 1/2 in.) in diameter; circular; mostly in sapwood; tunnels with coarse to fibrous sawdust or it may be absent	Roundheaded borers (beetles)	In living trees and unseasoned logs and lumber	When adults emerge from seasoned wood or when wood is dried
	Exit holes 3 to 13 mm (1/8 to 1/2 in.) in diameter; mostly oval; in sapwood and heartwood; sawdust tightly packed in tunnels	Flatheaded borers (beetles)	In living trees and unseasoned logs and lumber	When adults emerge from seasoned wood or when wood is dried
	Exit holes ~6 mm (~1/4 in.) in diameter; circular; in sapwood of softwoods, primarily pine; tunnels packed with very fine sawdust	Old house borers (a roundheaded borer)	During or after seasoning	Reinfestation continues in seasoned wood in use
	Exit holes perfectly circular, 4 to 6 mm (1/6 to 1/4 in.) in diameter; primarily in softwoods; tunnels tightly packed with coarse sawdust, often in decay softened wood	Woodwasps	In dying trees or fresh logs	When adults emerge from seasoned wood, usually in use, or when kiln-dried
Network of galleries	Nest entry hole and tunnel perfectly circular ~13 mm (~1/2 in.) in diameter; in soft softwoods in structures	Carpenter bees	In structural timbers, siding	Nesting reoccurs annually in spring at same and nearby locations
	Systems of interconnected tunnels and chambers	Social insects with colonies		
	Walls look polished; spaces completely clean of debris	Carpenter ants	Usually in damp partly decayed, or soft-textured wood in use	Colony persists unless prolonged drying of wood occurs
	Walls usually speckled with mud spots; some chambers may be filled with “clay” Chambers contain pellets; areas may be walled off by dark membrane	Subterranean termites Dry-wood termites (occasionally damp wood termites)	In wood structures	Colony persists
Pitch pocket Black check	Openings between growth rings containing pitch	Various insects	In living trees	In tree
	Small packets in outer layer of wood	Grubs of various insects	In living trees	In tree
Pith fleck	Narrow, brownish streaks	Fly maggots or adult weevils	In living trees	In tree
Gum spot	Small patches or streaks of gum-like substances	Grubs of various insects	In living trees	In tree
Ring distortion	Double growth rings or incomplete annual layers of growth	Larvae of defoliating insects or flatheaded cambium borers	In living trees	In tree
	Stained area more than 25.4 mm (1 in.) long introduced by insects in trees or recently felled logs	Staining fungi	With insect wounds	With seasoning

Chapter 14 Biodeterioration of Wood

decay. Similarly, pile tops may be protected by treatment with a wood preservative followed by application of a suitable capping compound or shield.

Wood boats present certain problems that are not encountered in other uses of wood. The parts especially subject to decay are the stem, knighthead, transom, and frameheads, which can be reached by rainwater from above or condensation from below. Frayed surfaces are more likely to decay than are exposed surfaces, and in salt water service, hull members just below the weather deck are more vulnerable than those below the waterline. Recommendations for avoiding decay include (a) using only heartwood of durable species, free of infection, and preferably below 20% moisture content; (b) providing and maintaining ventilation in the hull and all compartments; (c) keeping water out as much as is practicable, especially fresh water; and (d) where it is necessary to use sapwood or nondurable heartwood, impregnating the wood with an approved preservative and treating the fully cut, shaped, and bored wood before installation by soaking it for a short time in preservative solution. Where such mild soaking treatment is used, the wood most subject to decay should also be flooded with an approved preservative at intervals of 2 or 3 years. During subsequent treatment, the wood should be dry so that joints are relatively loose.

Bacteria

Most wood that has been wet for a considerable length of time probably will contain bacteria. The sour smell of logs that have been held under water for several months, or of lumber cut from them, manifests bacterial action. Usually, bacteria have little effect on wood properties, except over long periods, but some may make the wood excessively absorptive. This can result in excessive absorption of moisture, adhesive, paint, or preservative during treatment or use. This effect has been a problem in the sapwood of millwork cut from pine logs that have been stored in ponds. There also is evidence that bacteria developing in pine veneer bolts held under water or sprayed with water may cause noticeable changes in the physical character of the veneer, including some strength loss. Additionally, a mixture of different bacteria and fungi was found capable of accelerating decay of treated cooling tower slats and mine timbers.

Insect Damage and Control

The more common types of damage caused by wood-attacking insects are shown in Table 14-2 and Figure 14-8. Methods of controlling and preventing insect attack of wood are described in the following paragraphs.

Beetles

Bark beetles may damage the surface of the components of logs and other rustic structures from which the bark has not been removed. These beetles are reddish brown to black and

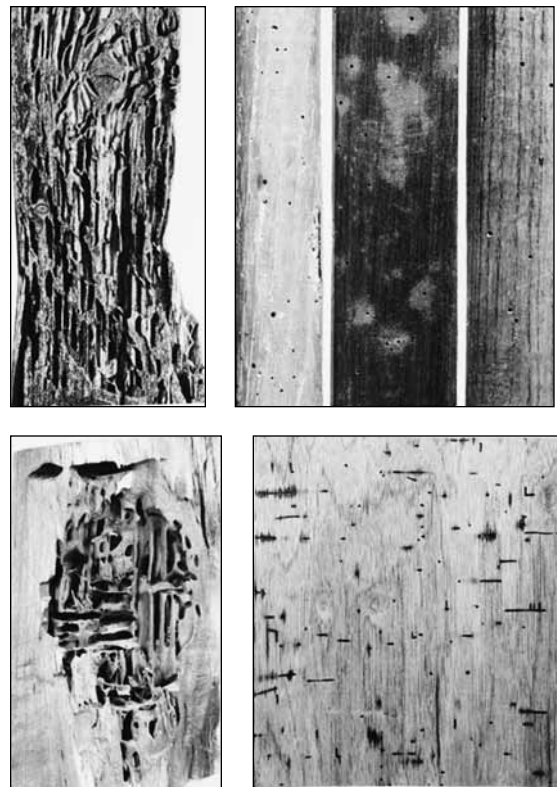

Figure 14-8. Types of insect damage most likely to occur in a building. Upper left—Termite attack; feeding galleries (often parallel to the grain) contain excrement and soil. Upper right—Powder-post beetle attack; exit holes usually filled with wood flour and not associated with discolored wood. Lower left—Carpenter ant attack; nesting galleries usually cut across grain and are free of residue. Lower right—Beetle attack; feeding galleries (made in the wood while green) free of residue and surrounding wood darkly stained.

vary in length from approximately 1.5 to 6.5 mm (1/16 to 1/4 in.) They bore through the outer bark to the soft inner part, where they make tunnels in which they lay their eggs. In making tunnels, bark beetles push out fine brownish-white sawdust-like particles. If many beetles are present, their extensive tunneling will loosen the bark and permit it to fall off in large patches, making the structure unsightly.

To avoid bark beetle damage, logs may be debarked rapidly, sprayed with an approved insecticidal solution, stored in water or under a water spray, or cut during the dormant season (October or November, for instance). If cut during this period, logs should immediately be piled off the ground and arranged for good air movement to promote rapid drying of the inner bark. This should occur before the beetles begin to fly in the spring. Drying the bark will almost always prevent damage by insects that prefer freshly cut wood.

Ambrosia beetles, roundheaded and flatheaded borers, and some powder-post beetles that get into freshly cut timber

can cause considerable damage to wood in rustic structures and some manufactured products. Certain beetles may complete development and emerge several years after the wood is dry, often raising a question as to the origin of the infestation.

Proper cutting practices, rapid debarking, storing under water, and spraying with an approved chemical solution, as recommended for bark beetles, will control these insects. Damage by ambrosia beetles can be prevented in freshly sawn lumber by dipping the product in a chemical solution. The addition of one of the sap-stain preventives approved for controlling molds, stains, and decay will keep the lumber bright. Powder-post beetles attack both hardwoods and softwoods and both freshly cut and seasoned lumber and timber. Powder-post damage is indicated by holes made in the surface of the wood by the winged adults as they emerge and by the fine powder that may fall from the wood. The powder-post beetles that cause most of the damage to dry hardwood lumber belong to the genus *Lyctus*. They attack the sapwood of ash, hickory, oak, and other large-pored hardwoods as it begins to season. Eggs are laid in pores of the wood, and the larvae burrow through the wood, making tunnels from 1.5 to 2 mm (1/16 to 1/12 in.) in diameter, which they leave packed with a fine powder. Species of anobiid beetles colonize coniferous materials.

Susceptible hardwood lumber used for manufacturing purposes should be protected from powder-post beetle attack as soon as it is sawn and when it arrives at the plant. An approved insecticide applied in water emulsion to the green lumber will provide protection. Such treatment may be effective even after the lumber is kiln dried, until it is surfaced. Heat sterilization is another way to kill insects in green lumber. To effectively kill insects in lumber or timbers, heat sterilization requires that the center of the wood be held at 56 °C (133 °F) for 30 min. The time required to reach that temperature is highly variable and depends on thickness of boards, dimension of timbers, and moisture content of the wood (Chap. 20). For example, heating time increases with increasing board thickness or increasing cross-sectional dimension.

Good plant sanitation is extremely important in alleviating the problem of infestation. Proper sanitation measures can often eliminate the necessity for other preventative steps. Damage to manufactured items frequently is traceable to infestation that occurred before the products were placed on the market, particularly if a finish is not applied to the surface of the items until they are sold. Once wood is infested, the larvae will continue to develop, even though the surface is subsequently painted, oiled, waxed, or varnished.

When selecting hardwood lumber for building or manufacturing purposes, any evidence of powder-post infestation should not be overlooked, because the beetles may continue to be active long after the wood is put to use. Heat steriliza-

tion under conditions that ensure the center of the wood will be held at 56 °C (133 °F) for 30 min will effectively kill insects in infested lumber. Those conditions vary with moisture content, size, and dimension of wood—see Chapter 20 for further information on heat sterilization. A 3-min soaking in a petroleum oil solution containing an insecticide is also effective for checking infestation or preventing attack on lumber up to standard 19 mm (nominal 1 in.) thick. Small dimension stock also can be protected by brushing or spraying with approved chemicals. For infested furniture or finished woodwork in a building, the same insecticides may be used, but they should be dissolved in refined petroleum oil, such as mineral spirits. Because *Lyctus* beetles lay their eggs in the open pores of wood, infestation can be prevented by covering the entire surface of each piece of wood with a suitable finish.

Powder-post beetles in the family Anobiidae, depending on the species, infest hardwoods and softwoods. Their life cycle takes 2 to 3 years, and they require wood moisture content around 15% or greater for viable infestation. Therefore, in most modern buildings, the wood moisture content is generally too low for anobiids. When ventilation is inadequate or in more humid regions of the United States, wood components of a building can reach the favorable moisture conditions for anobiids. This is especially a problem in air-conditioned buildings where water condenses on cooled exterior surfaces. Susceptibility to anobiid infestation can be alleviated by lowering the moisture content of wood through improved ventilation and the judicious use of insulation and vapor barriers. Insecticides registered for use against these beetles are generally restricted for exterior applications to avoid potential safety hazards indoors. Wood being reused or recycled from older structures often has lyctid or anobiid larvae in it. Such wood should be fumigated or kiln dried before use in another structure.

Beetles in the family Bostrichidae and weevils in the family Curculionidae are associated with wood moisture contents favorable for wood-infesting fungi because they may benefit nutritionally from the fungi. Thus, protection against these insects consists of the same procedures as for protection against wood-decay fungi.

A roundheaded beetle, commonly known as the old house borer, causes damage to seasoned, coniferous building materials. The larvae reduce the sapwood to a powdery or granular consistency and make a ticking sound while at work. When mature, the beetles make an oval hole approximately 6.5 mm (1/4 in.) in diameter in the surface of the wood and emerge. Anobiid powder-post beetles, which make holes 1.6 to 3.2 mm (1/16 to 1/8 in.) in diameter, also cause damage to pine joists. Infested wood should be drenched with a solution of one of the currently recommended insecticides in a highly penetrating solvent. Beetles nesting in wood behind plastered or paneled walls can be eliminated through fumigation of the building by a licensed operator.



Figure 14–9. A, the northern limit of recorded damage done by subterranean termites in the United States; B, the northern limit of damage done by dry-wood termites.

Termites

Termites superficially resemble ants in size, general appearance, and habit of living in colonies. About 56 species are known in the United States. From the standpoint of their methods of attack on wood, termites can be grouped into two main classes: (a) ground-inhabiting or subterranean termites and (b) wood-inhabiting or nonsubterranean termites.

Subterranean Termites

Subterranean termites are responsible for most of the termite damage to wood structures in the United States. This damage can be prevented. Subterranean termites are more prevalent in the southern than in the northern states, where low temperatures do not favor their development (Fig. 14–9). The hazard of infestation is greatest (a) beneath buildings without basements that were erected on a concrete slab foundation or were built over a crawl space that is poorly drained and lacks a moisture barrier (see Chap. 17) and (b) in any substructure wood component close to the ground or an earth fill (for example, an earth-filled porch).

Subterranean termites develop their colonies and maintain their headquarters in the ground. They build their tunnels through earth and around obstructions to reach the wood they need for food. They also must have a constant source of moisture, whether from the wood on which they are feeding or the soil where they nest. The worker members of the colony cause destruction of wood. At certain seasons of the year, usually spring, male and female winged forms swarm from the colony, fly a short time, lose their wings, mate, and if successful in locating a suitable home, start new colonies. The appearance of “flying ants” or their shed wings is an indication that a termite colony may be near and causing serious damage. Not all “flying ants” are termites; therefore, suspicious insects should be identified before investing in eradication (Fig. 14–10).

Subterranean termites normally do not establish themselves in buildings by being carried there in lumber; they primarily

Termites

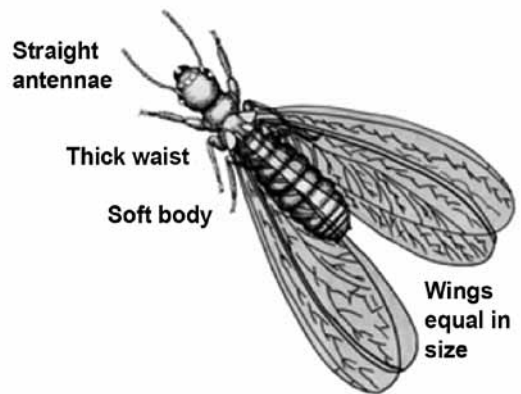

Ants

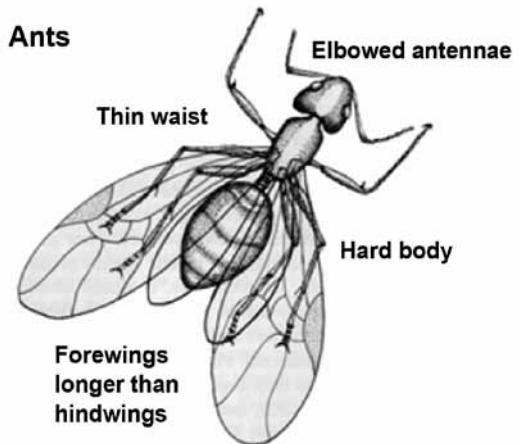

Figure 14–10. A, winged termite; B, winged ant (both greatly enlarged). The wasp waist of the ant and the long wings of the termite are distinguishing characteristics.

enter from ground nests after the building has been constructed. An introduced species, the Formosan termite, is adept at initiating aboveground infestations and nests in structures where wood remains wet for prolonged periods, such as from roof leaks. Telltale signs of subterranean termite presence are the earthen tubes or runways built by these insects over the surfaces of the foundation or other exposed areas to reach the wood above. Another sign is the swarming of winged adults early in the spring or fall. In the wood itself, the termites make galleries that generally follow the grain, leaving a shell of sound wood to conceal their activities. Because the galleries seldom show on the wood surfaces, probing with a pick or knife is advisable if the presence of termites is suspected.

The best protection for wood in areas where subterranean termites are prevalent is to prevent the termites from gaining hidden access to a building. The foundations should be of concrete, pressure-treated wood, or other material through which the termites cannot penetrate. With brick, stone, or concrete block, cement mortar should be used because termites can work through some other kinds of mortar. Also,

it is a good precaution to cap the foundation with 100 mm (4 in.) of reinforced concrete. Posts supporting floor girders should, if they bear directly on the ground, be of concrete. If there is a basement, it should be floored with concrete. Untreated posts in such a basement should rest on concrete piers extending a few inches above the basement floor. However, pressure-treated posts can rest directly on the basement floor. With the crawl-space type of foundation, wood floor joists should be kept at least 460 mm (18 in.) and girders 300 mm (12 in.) from the earth with a polyethylene vapor barrier covering exposed soil and extending partially up the foundation wall. Moisture condensation on the floor joists and subflooring, which may cause conditions favorable to decay and contribute to infestation by termites, can be avoided by covering the soil below with a moisture barrier and assuming proper drainage of rainwater away from all sides of a structure by managing rain and roof runoff with gutters, downspouts, and proper grading around the foundation. All concrete forms, stakes, stumps, and wastewood should be removed from the building site because they are possible sources of infestation. Generally, the precautions effective against subterranean termites are also helpful against decay.

The principal method of protecting buildings in high termite areas is to thoroughly treat the soil adjacent to the foundation walls and piers beneath the building with a soil insecticide. When concrete slab floors are laid directly on the ground, all soil under the slab should be treated with an approved insecticide before the concrete is poured. Furthermore, insulation containing cellulose that is used as a filler in expansion joints should be impregnated with an approved chemical toxic to termites. Sealing the top 13 mm (1/2 in.) of the expansion joint with roofing-grade coal-tar pitch also provides effective protection from ground-nesting termites. Several soil treatments and insecticidal bait control methods are currently available. Information on current control methods is available from national pest control operator associations. These organizations should be consulted to take advantage of the latest technology in termite control.

To control termites already in a building, contact between the termite colony in the soil and the woodwork must be broken. This can be done by blocking the runways from soil to wood, treating the soil, repairing leaks that keep wood within the structure wet (for example, plumbing leaks), or some combination of these techniques. Possible reinfestation can be guarded against by frequent inspections for signs of termites.

Nonsubterranean Termites

In the United States, nonsubterranean termites have been found only in a narrow strip of territory extending from central California around the southern edge of the continental United States to Virginia (Fig. 14–9) and in the West Indies and Hawaii. Their principal damage is confined to an area in southern California, to parts of southern Florida, notably

Key West, and to the islands of Hawaii. They also are a localized problem in Arizona and New Mexico.

The nonsubterranean termites, especially the dry-wood type, do not multiply as rapidly as the subterranean termites and have a somewhat different colony life and habits. The total amount of destruction they cause in the United States is much less than that caused by the subterranean termites. The ability of dry-wood termites to live in dry wood without outside moisture or contact with the ground, however, makes them a definite menace in the regions where they occur. Their destruction is not rapid, but they can thoroughly riddle timbers with their tunneling if allowed to work undisturbed for many years. Nonsubterranean termites are often moved from structure to structure in infested items such as furniture.

In constructing a building in localities where the dry-wood type of nonsubterranean termite is prevalent, it is good practice to inspect the lumber carefully to see that it was not infested before arrival at the building site. If the building is constructed during the swarming season, the lumber should be watched during the course of construction, because infestation by colonizing pairs can easily take place. Because paint is a good protection against the entrance of dry-wood termites, exposed wood (except that which is preservative treated) should be kept covered with a paint film. Fine screen should be placed over any openings to the interior unpainted parts of the building. As in the case of ground-nesting termites, dead trees, old stumps, posts, or wood debris of any kind that could serve as sources of infestation should be removed from the premises.

If a building is infested with dry-wood termites, badly damaged wood should be replaced. If the wood is only slightly damaged or is difficult to replace, further termite activity can be arrested by injecting a small amount of an approved pesticidal dust or liquid formulation into each nest. Current recommendations for such formulations can be found from state pest control associations. Buildings heavily infested with nonsubterranean termites can be successfully fumigated. This method is quicker than the use of poisonous liquids and dusts and does not require finding all of the colonies. However, it does not prevent the termites from returning because no poisonous residue is left in the tunnels. Fumigation is very dangerous and should be conducted only by licensed professional fumigators. Infested pieces of furniture, picture frames, and other small pieces can be individually fumigated, heated, or placed in a freezer for a short time. In localities where dry-wood termites do serious damage to posts and poles, the best protection for these and similar forms of outdoor timbers is full-length pressure treatment with a preservative.

Naturally Termite-Resistant Woods

Only a limited number of woods grown in the United States offer any marked degree of natural resistance to termite

attack. The close-grained heartwood of California redwood has some resistance, especially when used above ground. Very resinous heartwood of Southern Pine is practically immune to attack, but it is not available in large quantities and is seldom used.

Carpenter Ants

Carpenter ants are black or brown. They usually occur in stumps, trees, or logs but sometimes damage poles, structural timbers, or buildings. One form is easily recognized by its giant size relative to other ants. Carpenter ants use wood for shelter rather than for food, usually preferring wood that is naturally soft or has been made soft by decay. They may enter a building directly by crawling or may be carried there in firewood. If left undisturbed, they can, in a few years, enlarge their tunnels to the point where replacement or extensive repairs are necessary. The parts of dwellings they frequent most often are porch columns, porch roofs, window sills, and sometimes the wood plates in foundation walls. They often nest in hollow-core doors. The logs of rustic cabins are also attacked.

Precautions that prevent attack by decay and termites are usually effective against carpenter ants. Decaying or infested wood, such as logs, stumps, or retaining walls, should be removed from the premises, and crevices present in the foundation or woodwork of the building should be sealed. Particularly, leaks in porch roofs should be repaired because the decay that may result makes the wood more desirable to the ants.

When carpenter ants are found in a structure, any badly damaged timbers should be replaced. Because the carpenter ant needs high humidity in its immature stages, alterations in the construction may also be required to eliminate moisture from rain or condensation. In wood not sufficiently damaged to require replacement, the ants can be killed by injection of approved insecticide into the nest galleries. Carpenter ant nests are relatively easy to find because they keep their internal nest sites very clean and free of debris. As particles of wood are removed to create galleries or as pieces of insects that have been fed upon accumulate, the debris is removed from the nest and then accumulates below the nest opening.

Carpenter Bees

Carpenter bees resemble large bumblebees, but the top of their abdomen is hairless, causing their abdomens to shine, unlike bumblebees. The females make large (13-mm- (1/2-in.-) diameter) tunnels into unfinished soft wood for nests. They partition the hole into cells; each cell is provided with pollen and nectar for a single egg. Because carpenter bees reuse nesting sites for many years, a nesting tunnel into a structural timber may be extended several feet and have multiple branches. In thin wood, such as siding, the holes may extend the full thickness of the wood. They nest in wood that has been finished with a stain or thin paint film, or light preservative salt treatments, as well as in bare wood.

A favorite nesting site is in unfinished exterior wood not directly exposed to sunlight (for example, the undersides of porch roofs, and grape arbors).

Control is aimed at discouraging the use of nesting sites in and near buildings. The tunnel may be injected with an insecticide labeled for bee control and plugged with caulk. Treating the surface around the entry hole will discourage reuse of the tunnel during the spring nesting period. A good paint film or pressure preservative treatment protects exterior wood surfaces from nesting damage. Bare interior wood surfaces, such as in garages, can be protected by screens and tight-fitting doors.

Marine Borer Damage and Control

Damage by marine-boring organisms to wood structures in salt or brackish waters is practically a worldwide problem. Evidence of attack is sometimes found in rivers even above the region of brackishness. The rapidity of attack depends upon local conditions and the kinds of borers present. Along the Pacific, Gulf, and South Atlantic Coasts of the United States, attack is rapid, and untreated pilings may be completely destroyed in a year or less. Along the coast of the New England States, the rate of attack is slower because of cold water temperatures but is still sufficiently rapid to require protection of wood where long life is desired. The principal marine borers from the standpoint of wood damage in the United States are described in this section. Control measures discussed in this section are those in use at the time this handbook was revised. Regulations should be reviewed at the time control treatments are being considered so that approved practices will be followed.

Shipworms

Shipworms are the most destructive of the marine borers. They are mollusks of various species that superficially are worm-like in form. The group includes several species of *Teredo* and several species of *Bankia*, which are especially damaging. These mollusks are readily distinguishable on close observation but are all very similar in several respects. In the early stages of their life, they are minute, free-swimming organisms. Upon finding suitable lodgment on wood, they quickly develop into a new form and bury themselves in the wood. A pair of boring shells on the head grows rapidly in size as the boring progresses, while the tail part or siphon remains at the original entrance. Thus, the animal grows in length and diameter within the wood but remains a prisoner in its burrow, which it lines with a shell-like deposit. It lives on the wood borings and the organic matter extracted from the sea water that is continuously being pumped through its system. The entrance holes never grow large, and the interior of wood may be completely honeycombed and ruined while the surface shows only slight perforations. When present in great numbers, shipworms grow only a few centimeters before the wood is so completely occupied that growth is stopped. However, when not



Figure 14–11. *Limnoria* damage to piling.

crowded, they can grow to lengths of 0.3 to 1.2 m (1 to 4 ft) depending on the species.

Pholads

Another group of wood-boring mollusks is the pholads, which clearly resemble clams and therefore are not included with the shipworms. They are entirely encased in their double shells. The *Martesia* are the best-known species, but another well-known group is the *Xylophaga*. Like the shipworms, the *Martesia* enter the wood when they are very small, leaving a small entrance hole, and grow larger as they burrow into the wood. They generally do not exceed 64 mm (2-1/2 in.) long and 25 mm (1 in.) in diameter but are capable of doing considerable damage. Their activities in the United States appear to be confined to the Gulf Coast, San Diego, and Hawaii.

Limnoria and *Sphaeroma*

Another distinct group of marine borers are crustaceans, which are related to lobsters and shrimp. The principal borers in this group are species of *Limnoria* and *Sphaeroma*. Their attack differs from that of the shipworms and the *Martesia* in that the bore hole is quite shallow; the result is that the wood gradually is thinned from the surface inward through erosion by the combined action of the borers and water erosion. Also, the *Limnoria* and *Sphaeroma* do not become imprisoned in the wood but may move freely from place to place.

Limnoria are small, 3 to 4 mm (1/8 to 1/6 in.) long, and bore small burrows in the surface of wood. Although they can change their location, they usually continue to bore in one place. When great numbers of *Limnoria* are present, their burrows are separated by very thin walls of wood that are easily eroded by the motion of the water or damaged by objects floating upon it. This erosion causes the *Limnoria* to burrow continually deeper; otherwise, the burrows would probably not become greater than 51 mm (2 in.) long or 13 mm (1/2 in.) deep. Because erosion is greatest between tide

levels, piles heavily attacked by *Limnoria* characteristically wear within this zone to an hourglass shape (Fig. 14–11). In heavily infested harbors, untreated piling can be destroyed by *Limnoria* within a year.

Sphaeroma are somewhat larger, sometimes reaching a length of 13 mm (1/2 in.) and a width of 6 mm (1/4 in.). In general appearance and size, they resemble the common sow bug or pill bug that inhabits damp places. *Sphaeroma* are widely distributed but are not as plentiful as *Limnoria* and cause much less damage, although damage caused by *Sphaeroma* action resembles that of *Limnoria*. Nevertheless, piles in some structures have been ruined by them. It has been reported that *Sphaeroma* attack salt-treated wood in Florida. Occasionally, they have been found in fresh water.

The average life of well-creosoted structures in areas susceptible to marine borer attack is many times the average life obtained from untreated structures. However, even thorough creosote treatment will not always stop *Martesia*, *Sphaeroma*, and especially *Limnoria*; shallow or erratic creosote penetration affords only slight protection. The spots with poor protection are attacked first, and from there, the borers spread inward and destroy the untreated interior of the pile.

When wood is to be used in salt water, avoidance of cutting or injuring the surface after treatment is even more important than when wood is to be used on land. No cutting or injury of any kind for any purpose should be permitted in the underwater part of the pile. Where piles are cut to grade above the waterline, the exposed surfaces should be protected from decay. This may be accomplished by in-place application of a wood preservative followed by a suitable capping compound.

Protection from Marine Borers

No wood is immune to marine-borer attack, and no commercially important wood of the United States has sufficient marine-borer resistance to justify its use untreated in any important structure in areas where borers are active. The heartwood of several foreign species, such as greenheart, jarrah, azobe, and manbarklak, has shown resistance to marine-borer attack. Service records on these woods, however, do not always show uniform results and are affected by local conditions. Borer damage to wooden marine structures can be prevented, but knowing the type of borer present in the geographic location is important for selection of proper preservative and treatment retention to protect the structure from surface erosion.

Protection of Permanent Structures

The best practical protection for piles in sea water with shipworms and moderate *Limnoria* hazard is heavy treatment with coal-tar creosote or creosote coal-tar solution. Where severe *Limnoria* hazard exists, dual treatment (copper-arsenate-containing waterborne preservatives followed by coal-tar creosote) is recommended. The treatment must be

Chapter 14 Biodeterioration of Wood

thorough, the penetration as deep as possible, and the retention high to give satisfactory results in heavily infested waters. It is best to treat such piles by the full-cell process to refusal; that is, to force in all the preservative the piles can hold without using treatments that cause serious damage to the wood. For highest retentions, it is necessary to air- or kiln-dry the piling before treatment. Details of treatments are discussed in Chapter 15.

The life of treated piles is influenced by the thoroughness of the treatment, the care and diligence used in avoiding damage to the treated shell during handling and installation, and the severity of borer attack. Differences in exposure conditions, such as water temperature, salinity, dissolved oxygen, water depth, and currents, tend to cause wide variations in the severity of borer attack even within limited areas. Service records show average-life figures of 22 to 48 years on well-treated Douglas-fir piles in San Francisco Bay waters. In South Atlantic and Gulf of Mexico waters, creosoted piles are estimated to last 10 to 12 years and frequently much longer. On the North Atlantic Coast, where exposure conditions are less severe, piles can last even longer than the 22- to 48-year life recorded in the San Francisco Bay.

Metal armor and concrete or plastic jacketing have been used with various degrees of success for the protection of marine piles. The metal armor may be in the form of sheets, wire, or nails. Sheathing of piles with copper or muntz metal has been only partially successful, owing to difficulty in maintaining a continuous armor. Theft, mechanical damage from driving, damage by storm or driftwood, and corrosion of sheathing have sooner or later let in the borers, and in only a few cases has long pile life been reported. Attempts during World War II to electroplate wood piles with copper were not successful. Concrete casings are now in greater use than is metal armor, and they appear to provide better protection when high-quality materials are used and carefully applied. Unfortunately, they are readily damaged by ship impact. For this reason, concrete casings are less practical for fender piles than for foundation piles that are protected from mechanical damage.

Jacketing piles by wrapping them with heavy polyvinyl plastic is one form of supplementary protection. If properly applied, the jacketing will kill any borers that may have already become established by creating stagnant water, thereby decreasing oxygen levels in the water that is in contact with the piles. Like other materials, the plastic jacket is subject to mechanical damage.

Protection of Boats

Wood barges have been constructed with planking or sheathing pressure-treated with creosote to protect the hull from marine borers, and the results have been favorable. Although coal-tar creosote is an effective preservative for protecting wood against marine borers in areas of moderate borer hazard, it has disadvantages in many types of boats.

Creosote adds considerably to the weight of the boat hull, and its odor is objectionable to boat crews. In addition, antifouling paints are difficult to apply over creosoted wood.

Antifouling paints that contain copper protect boat hulls against marine-borer attack, but the protection continues only while the coating remains unbroken. Because it is difficult to maintain an unbroken coating of antifouling paint, the U.S. Navy has found it desirable to impregnate the hull planking of some wood boats with certain copper-containing preservatives. Such preservatives, when applied with high retentions (40 kg m^{-3} (2.5 lb ft^{-3})), have some effectiveness against marine borers and should help to protect the hull of a boat during intervals between renewals of the antifouling coating. These copper preservatives do not provide protection equivalent to that furnished by coal-tar creosote; their effectiveness in protecting boats is therefore best assured if the boats are dry docked at regular and frequent intervals and the antifouling coating maintained. The leach-resistant wood preservatives containing copper arsenates have shown superior performance (at a retention of 40 kg m^{-3} (2.5 lb ft^{-3})) to creosote in tests conducted in areas of severe borer hazard.

Plywood as well as plank hulls can be protected against marine borers by preservative treatment. The plywood hull presents a surface that can be covered successfully with a protective membrane of reinforced plastic laminate. Such coverings should not be attempted on wood that has been treated with a preservative carried in oil, because the bond will be unsatisfactory.

References

- Beal, R.H. 1967. Formosan invader. *Pest Control*. 35(2): 13–17.
- Beal, R.H.; Maulderi, J.K.; Jones, S.C. 1983. Subterranean termites, their prevention and control in buildings. *Home & Garden Bull.* 64 (rev.). Washington, DC: U.S. Department of Agriculture. 30 p.
- Cassens, D.L.; Eslyn, W.E. 1981. Fungicides to prevent sapstain and mold on hardwood lumber. *Forest Products Journal*. 31: 39–42.
- Ebeling, W. 1975. Wood destroying insects and fungi. In: *Urban entomology*. Berkeley, CA: University of California, Division of Agriculture Science: 128–216.
- Esenther, G.R.; Beal, R.H. 1979. Termite control: decayed wood bait. *Sociobiology*. 4(2): 215–222.
- Eslyn, W.E.; Clark, J.W. 1976. Appraising deterioration in submerged piling. *Materials und Organismen*. Supplement 3: 43–52.
- Eslyn, W.E.; Clark, J.W. 1979. Wood bridges—decay inspection and control. *Agric. Handb.* 557. Washington, DC: U.S. Department of Agriculture. 32 p.

- Forest Products Society. 1997. Prevention of discolorations in hardwood and softwood logs and lumber. FPS Proceedings 7283. Madison, WI: Forest Products Society. 90 p.
- Greaves, H. 1969. Wood-inhabiting bacteria: general considerations. Commonwealth Scientific and Industrial Research Organization, Forest Products Newsletter 359.
- Hartley, C.; May, C.; 1943. Decay of wood in boats. U.S. Department of Agriculture, Forest Path. Spec. Release 8. U.S. Department of Agriculture, Forest Service. 12 p.
- Highley, T.L. 1995. Comparative durability of untreated wood in use above ground. *International Biodeterioration & Biodegradation*. pp. 409–419.
- Highley, T.L.; Eslyn, W.E. 1982. Using fumigants to control interior decay in waterfront timbers. *Forest Products Journal*. 32: 32–34.
- Highley, T.L.; Scheffer, T.C. 1978. Controlling decay in above-water parts of waterfront structures. *Forest Products Journal*. 28: 40–43.
- Hunt, G.M.; Garratt, G.A. 1967. Wood preservation, 3rd ed. The American Forestry Series. New York: McGraw-Hill Book Company. 457 p.
- Johnson, B.R.; Lebow, S.T. 1996. Relative tolerance of CCA by larvae and adults of the common shipworm, *Bankia gouldi*. *Material und Organismen*. 30(1): 73–78.
- Johnson, B.R.; Rice, S.A. 1990. Protection of wood from marine borers. In: Proceedings, National Marine Research Conference. Wickford, RI. International Marine Institute.
- Jones, E.B.G.; Eltringham, S.K., eds. 1971. Marine borers, fungi and fouling organisms of wood. In: Proceedings of Organization for Economic Cooperation and Development. 1968 March 27–April 3. Paris, France: OECD. 367 p.
- Krishna, K.; Weesner, F.M., eds. 1969. Biology of termites. New York: Academic Press. Vol. I. 598 p.
- Krishna, K.; Weesner, F.M., eds. 1970. Biology of termites. New York: Academic Press. Vol. II. 643 p.
- Lee, K.E.; Wood, T.G. 1971. Termites and soils. New York: Academic Press. 251 p.
- Moore, H.B. 1979. Wood-inhabiting insects in houses: their identification, biology, prevention, and control. Prepared as part of interagency agreement IAA–25–75 between the U.S. Department of Agriculture, Forest Service, and the Department of Housing and Urban Development. Washington, DC: U.S. Department of Agriculture, Forest Service, and the Department of Housing and Urban Development. 133 p.
- Morrell, J.J. 1996. Wood pole maintenance manual. Res. Contribution 15. Corvallis, OR: Forest Research Laboratory, Oregon State University. 55 p.
- Morrell, J.J.; Corden, M.E. 1982. Controlling wood deterioration with fumigants: a review. *Forest Products Journal*. 36(10): 26–34.
- NPCA. 1963. Carpenter bees. Tech. Release 3–63. Dunn Loring, VA: National Pest Control Association.
- NPCA. 1964. The horntails. Tech. Release 14–64. Dunn Loring, VA: National Pest Control Association.
- NPCA. 1976. Carpenter ants. Tech. Release ESPC 052101. Dunn Loring, VA: National Pest Control Association.
- Rietz, R.C. 1978. Storage of lumber. *Agric. Handb.* 531. Washington, DC: U.S. Department of Agriculture. 63 p.
- Roff, J.W.; Cserjesi, A.J.; Swann, G.W. 1980. Prevention of sap stain and mold in packaged lumber. Forintek Canada Corporate Technical Report. 14R. Vancouver, BC: Forintek Canada Corporation.
- Scheffer, T.C. 1972. A climate index for estimating potential decay in wood structures above ground. *Forest Products Journal*. 21(10): 25–31.
- Scheffer, T.C.; Eslyn, W.E. 1976. Winter treatments protect birch roundwood during storage. *Forest Products Journal*. 26: 27–31.
- Scheffer, T.C.; Verrall, A.F. 1973. Principles of protecting wood buildings from decay. Res. Pap. FPL 190. Madison, WI: U.S. Department of Agriculture, Forest Service, Forest Products Laboratory. 56 p.
- Schmidt, E. 1990. Remedial decay treatment with fused borate rods: Recent developments and opportunities. In: Proceedings, first international conference on wood protection with diffusible preservatives: 1989 November; Nashville, TN. Madison, WI: Forest Products Society: 91–92.
- Sherwood, G.E.; TenWolde, A. 1982. Moisture movement and control in light frame structures. *Forest Products Journal*. 32: 69–73.
- Simpson, W.T.; Wang, X.; Verrill, S. 2003. Heat sterilization time of Ponderosa pine and Douglas-fir boards and square timbers. Res. Pap. FPL–RP–607. Madison, WI: U.S. Department of Agriculture, Forest Service, Forest Products Laboratory. 24 p.
- Weesner, F.M. 1965. The termites of the United States, a handbook. Elizabeth, NJ: National Pest Control Association. 70 p.
- Wilcox, W.W. 1978. Review of literature on the effect of early stages of decay on wood strength. *Wood and Fiber*. 9: 252–257.
- Williams, L.H. 1973. Anobiid beetles should be controlled. *Pest Control*. 41(6): 18, 20, 22, 38, 40, 42, 44.
- Zabel, R.A.; Morrell, J.J. 1992. Wood microbiology: Decay and its prevention. San Diego, CA: Academic Press. 476 p.

Wood Preservation

Stan T. Lebow, Research Forest Products Technologist

Contents

Wood Preservatives 15–1
Waterborne Preservatives 15–3
Preservatives with ICC–ES Evaluation Reports 15–9
Oil-Borne or Oil-Type Preservatives 15–10
Treatments for Wood Composites 15–12
Water-Repellent and Nonpressure Treatments 15–12
Selecting Preservatives 15–12
Evaluating New Preservatives 15–13
Preservative Effectiveness 15–13
Effect of Species on Penetration 15–15
Preparation of Wood for Treatment 15–15
Peeling 15–15
Drying 15–16
Conditioning of Green Products 15–17
Incising 15–17
Cutting and Framing 15–18
Application of Preservatives 15–18
Pressure Processes 15–18
Effect on Mechanical Properties 15–20
Nonpressure Processes 15–20
In-Place and Remedial Treatments 15–22
Best Management Practices 15–23
Quality Assurance for Treated Wood 15–25
Treating Conditions and Specifications 15–25
Inspection of Treatment Quality 15–25
Effects on the Environment 15–26
Recycling and Disposal of Treated Wood 15–26
References 15–27

Many commonly used wood species can deteriorate if exposed to conditions that support growth of wood-degrading organisms (see Chap. 14). Wood products can be protected from the attack of decay fungi, harmful insects, or marine borers by applying chemical preservatives. Preservative treatments greatly increase the life of wood structures, thus reducing replacement costs and allowing more efficient use of forest resources. The degree of protection achieved depends on the preservative used and the proper penetration and retention of the chemicals. Some preservatives are more effective than others, and some are more adaptable to certain use requirements. To obtain long-term effectiveness, adequate penetration and retention are needed for each wood species, chemical preservative, and treatment method. Not only are different methods of treating wood available, but treatability varies among wood species—particularly their heartwood, which generally resists preservative treatment more than does sapwood. Although some tree species possess naturally occurring resistance to decay and insects (see Chap. 14), many are in short supply or are not grown in ready proximity to markets.

In considering preservative treatment processes and wood species, the combination must provide the required protection for the conditions of exposure and life of the structure. All these factors are considered by the consensus technical committees in setting reference levels required by the American Wood Protection Association (AWPA, formerly American Wood-Preservers' Association)) and ASTM International (formerly American Society for Testing and Materials). Details are discussed later in this chapter. The characteristics, appropriate uses, and availability of preservative formulations may have changed after preparation of this chapter. For the most current information on preservative formulations, the reader is encouraged to contact the appropriate regulatory agencies, standardization organizations, or trade associations. *Note that mention of a chemical in this chapter does not constitute a recommendation.*

Wood Preservatives

Wood preservatives must meet two broad criteria: (1) They must provide the desired wood protection in the intended end use, and (2) they must do so without presenting unreasonable risks to people or the environment. Because wood preservatives are considered to be a type of pesticide, the U.S. Environmental Protection Agency (EPA) is responsible for their regulation. Federal law requires that before selling or distributing a preservative in the United States,

Synopsis of EPA-approved consumer information sheets for wood treated with CCA, ACZA, creosote, or pentachlorophenol

NOTE: This is only a synopsis of information contained in consumer information sheets. For complete consumer information sheets, contact your treated wood supplier or the website of the Environmental Protection Agency.

Handling Precautions

Avoid frequent or prolonged inhalation of sawdust from treated wood. When sawing, sanding, and machining treated wood, wear a dust mask. Whenever possible, these operations should be performed outdoors to avoid indoor accumulations of airborne sawdust from treated wood. When power-sawing and machining, wear goggles to protect eyes from flying particles. Wear gloves when working with the wood. After working with the wood, and before eating, drinking, toileting, and use of tobacco products, wash exposed areas thoroughly. Avoid frequent or prolonged skin contact with creosote- or pentachlorophenol-treated wood. When handling creosote- or pentachlorophenol-treated wood, wear long-sleeved shirts and long pants and use gloves impervious to the chemicals (for example, gloves that are vinyl coated). Because preservatives or sawdust may accumulate on clothes, they should be laundered before reuse. Wash work clothes separately from other household clothing.

Treated wood should not be burned in open fires or in stoves, fireplaces, or residential boilers, because toxic chemicals may be produced as part of the smoke and ashes. Treated wood from commercial or industrial use (such as construction sites) may be burned only in commercial or industrial incinerators or boilers in accordance with state and Federal regulations. CCA-treated wood can be disposed of with regular municipal trash (municipal solid waste, not yard waste) in many areas. However, state or local laws may be stricter than federal requirements. For more information, please contact the waste management agency for your state.

Use Site Precautions

All sawdust and construction debris should be cleaned up and disposed of after construction. Do not use treated wood under circumstances where the preservative may become a component of food or animal feed. Examples of such sites would be use of mulch from recycled arsenic-treated wood, cutting boards, counter tops, animal bedding, and structures or containers for storing animal feed or human food. Only treated wood that is visibly clean and free of surface residue should be used for patios, decks, and walkways. Do not use treated wood for construction of those portions of beehives which may come into contact with honey. Treated wood should not be used where it may come into direct or indirect contact with drinking water, except for uses involving incidental contact such as docks and bridges.

Logs treated with pentachlorophenol should not be used for log homes. Wood treated with creosote or pentachlorophenol should not be used where it will be in frequent or prolonged contact with bare skin (for example, chairs and other outdoor furniture), unless an effective sealer has been applied. Creosote- and pentachlorophenol-treated wood should not be used in residential, industrial, or commercial interiors except for laminated beams or building components that are in ground contact and are subject to decay or insect infestation and where two coats of an appropriate sealer are applied. Do not use creosote- or pentachlorophenol-treated wood for farrowing or brooding facilities. Wood treated with pentachlorophenol or creosote should not be used in the interiors of farm buildings where there may be direct contact with domestic animals or livestock that may crib (bite) or lick the wood. In interiors of farm buildings where domestic animals or livestock are unlikely to crib (bite) or lick the wood, creosote- or pentachlorophenol-treated wood may be used for building components that are in ground contact and are subject to decay or insect infestation and where two coats of an appropriate sealer are applied. Sealers may be applied at the installation site. Urethane, shellac, latex epoxy enamel, and varnish are acceptable sealers for pentachlorophenol-treated wood. Coal-tar pitch and coal-tar pitch emulsion are effective sealers for creosote-treated wood-block flooring. Urethane, epoxy, and shellac are acceptable sealers for all creosote-treated wood.

a company must obtain registration from EPA. Before registering a new pesticide or new use for a registered preservative, EPA must first ensure that the preservative can be used with a reasonable certainty of no harm to human health and without posing unreasonable risks to the environment. To make such determinations, EPA requires more than 100 different scientific studies and tests from applicants. This chapter discusses only wood preservatives registered by the EPA.

Some preservatives are classified as “restricted use” by the EPA and these can be used only in certain applications and can be applied only by certified pesticide applicators. Restricted use refers to the chemical preservative and not to the treated wood product. The general consumer may buy and use wood products treated with restricted-use pesticides; EPA does not consider treated wood a toxic substance nor is it regulated as a pesticide. Although treated wood is not regulated as pesticide, there are limitations on how some types of treated wood should be used. Consumer Information Sheets (EPA-approved) are available from retailers of creosote-, pentachlorophenol-, and inorganic-arsenical-treated wood products. The sheets provide information about the preservative and the use and disposal of treated-wood products (see Synopsis of EPA-Approved Consumer Information Sheets for Wood Treated with CCA, ACZA, Creosote, or Pentachlorophenol). The commercial wood treater is bound by the EPA regulation and can treat wood only for an end use that is allowed for that preservative. Some preservatives that are not classified as restricted by EPA are available to the general consumer for nonpressure treatments. It is the responsibility of the end user to apply these preservatives in a manner that is consistent with the EPA-approved labeling. Registration of preservatives is under constant review by the EPA, and a responsible State or Federal agency should be consulted as to the current status of any preservative.

Before a wood preservative can be approved for pressure treatment of structural members, it must be evaluated to ensure that it provides the necessary durability and that it does not greatly reduce the strength properties of the wood. The EPA typically does not evaluate how well a wood preservative protects the wood. Traditionally this evaluation has been conducted through the standardization process of the AWP. The AWP Book of Standards lists a series of laboratory and field exposure tests that must be conducted when evaluating new wood preservatives. The durability of test products are compared with those of established durable products and nondurable controls. The results of those tests are then presented to the appropriate AWP subcommittees for review. AWP subcommittees are composed of representatives from industry, academia, and government agencies who have familiarity with conducting and interpreting durability evaluations. Preservative standardization by AWP is a two-step process. If the performance of a new preservative is considered appropriate, it is first listed as a potential preservative. Secondary committee action is needed to have the new preservative listed for specific commodities and to set the required treatment level.

More recently the International Code Council–Evaluation Service (ICC–ES) has evolved as an additional route for gaining building code acceptance of new types of pressure-treated wood. In contrast to AWP, the ICC–ES does not standardize preservatives. Instead, it issues Evaluation Reports that provide evidence that a building product complies with building codes. The data and other information needed to obtain an Evaluation Report are first established as Acceptance Criteria (AC). AC326, which sets the performance criteria used by ICC–ES to evaluate proprietary wood preservatives, requires submittal of documentation accredited third party agencies in accordance with AWP, ASTM, and EN standard test methods. The results of those tests are then reviewed by an evaluation committee to determine if the preservative has met the appropriate acceptance criteria.

Wood preservatives have traditionally been divided into two general classes: (1) Oil-type or oil-borne preservatives, such as creosote and petroleum solutions of pentachlorophenol, and (2) waterborne preservatives that are applied as water solutions or with water as the carrier. Many different chemicals are in each of these classes, and each has different effectiveness in various exposure conditions. Some preservatives can be formulated so that they can be delivered with either water or oil-type carriers. In this chapter, both oil-borne and waterborne preservative chemicals are described as to their potential end uses. Tables 15–1 and 15–2 summarize preservatives and their treatment levels for various wood products.

Waterborne Preservatives

Waterborne preservatives are often used when cleanliness and paintability of the treated wood are required. Formulations intended for use outdoors have shown high resistance

to leaching and very good performance in service. Waterborne preservatives are included in specifications for items such as lumber, timber, posts, building foundations, poles, and piling (Table 15–1). Because water is added to the wood in the treatment process, some drying and shrinkage will occur after installation unless the wood is kiln-dried after treatment.

Copper is the primary biocide in many wood preservative formulations used in ground contact because of its excellent fungicidal properties and low mammalian toxicity (Table 15–3). Because some types of fungi are copper tolerant, preservative formulations often include a co-biocide to provide further protection.

Inorganic arsenicals are a restricted-use pesticide. For use and handling precautions of pressure-treated wood containing inorganic arsenicals, refer to the EPA-approved Consumer Information Sheets.

Acid Copper Chromate (ACC)

Acid copper chromate (ACC) contains 31.8% copper oxide and 68.2% chromium trioxide (AWP P5). The solid, paste, liquid concentrate, or treating solution can be made of copper sulfate, potassium dichromate, or sodium dichromate. Tests on stakes and posts exposed to decay and termite attack indicate that wood well impregnated with ACC generally provides acceptable service. However, some specimens placed in ground contact have shown vulnerability to attack by copper-tolerant fungi. ACC has often been used for treatment of wood in cooling towers. Its current uses are restricted to applications similar to those of chromated copper arsenate (CCA) (Table 15–4). ACC and CCA must be used at low treating temperatures (38 to 66 °C (100 to 150 °F)) because they are unstable at higher temperatures. This restriction may involve some difficulty when higher temperatures are needed to obtain good treating results in woods such as Douglas-fir.

Ammoniacal Copper Zinc Arsenate (ACZA)

Ammoniacal copper zinc arsenate (ACZA) is commonly used on the West Coast of North America for the treatment of Douglas-fir. The penetration of Douglas-fir heartwood is improved with ACZA because of the chemical composition and stability of treating at elevated temperatures. Wood treated with ACZA performs and has characteristics similar to those of wood treated with CCA (Table 15–1).

ACZA should contain approximately 50% copper oxide, 25% zinc oxide, and 25% arsenic pentoxide dissolved in a solution of ammonia in water (AWP P5). The weight of ammonia is at least 1.38 times the weight of copper oxide. To aid in solution, ammonium bicarbonate is added (at least equal to 0.92 times the weight of copper oxide).

ACZA replaced an earlier formulation, ammoniacal copper arsenate (ACA) that was used for many years in the United States and Canada.

Table 15–1. Typical use categories and retentions for preservatives used in pressure treatment of Southern Pine species^a

Preservative	Retentions (kg m ⁻³) ^b for each type of exposure and AWPAs use category designation						
	Interior, dry or damp	Exterior above-ground		Soil or fresh water			
		Vertical, coated	Horizontal	General	Severe/ critical	Very severe/ critical	
	1, 2	3A	3B	4A	4B	4C	4C (piles)
Waterborne: Listed by the AWPAs							
ACC	NL ^c	NL ^c	4.0	8	—	—	—
ACZA	4.0	4.0	4.0	6.4	9.6	9.6	—
ACQ–B	4.0	4.0	4.0	6.4	9.6	9.6	—
ACQ–C	4.0	4.0	4.0	6.4	9.6	9.6	—
ACQ–D	2.4	2.4	2.4	6.4	9.6	9.6	—
CA–B	1.7	1.7	1.7	3.3	5.0	5.0	—
CA–C	1.0	1.0	1.0	2.4	5.0	5.0	—
CBA–A	3.3	3.3	3.3	6.5	9.8	9.8	—
CCA	NL ^c	NL ^c	4	6.4	9.6	9.6	12.8
CX–A	3.3	3.3	3.3	—	—	—	—
CuN (waterborne)	1.12	1.12	1.12	1.76	—	—	—
EL2	0.30	0.30	0.30	—	—	—	—
KDS	3.0	3.0	3.0	7.5	—	—	—
PTI	0.21	0.21	0.21/0.29 ^d	—	—	—	—
SBX	2.8/4.5 ^e	—	—	—	—	—	—
Oil-type: Listed by the AWPAs							
Creosote	128/NR ^f	128.0	128.0	160	160	192	192
Penta P9 Type A Oil	6.4/NR ^f	6.4	6.4	8.0	8.0	8.0	9.6
Penta P9 Type C Oil	6.4/NR ^f	6.4	6.4	8.0	8.0	8.0	9.6
CuN (oilborne)	0.64/NR ^f	0.64	0.64	0.96	1.2	1.2	1.6
Cu8	0.32	0.32	0.32	—	—	—	—
Waterborne: Evaluation reports from ICC Evaluation Service, Inc.							
ESR–1721	0.8	0.8	0.8	2.2	3.6	5.3	5.3
ESR–1980	2.4	2.4	2.4	5.4	9.6	9.6	—
ESR–2067	0.3	0.3	0.3	—	—	—	—
ESR–2240	1.0	1.0	1.0	2.4	3.7	—	—
ESR–2325	1.1	1.1	1.1	2.6	3.8	—	—
ESR–2711	2.1/2.7 ^g	2.1/2.7 ^g	2.1/2.7 ^g	4.5	6.9	—	—

^aSome exceptions exist for specific applications. See AWPAs Standard U1 or ICC ES Evaluation Reports for details on specific applications. See Table 15–2 for seawater applications.

^bTo convert to retention expressed as lb ft⁻³, divide these values by 16.0.

^cNL, not labeled. EPA labeling does not currently permit use of wood newly treated with these preservatives in most applications within these use categories. See Table 15–4 for more details.

^dHigher retention specified if the preservative is used without a stabilizer in the treatment solution.

^eHigher retention for areas with Formosan subterranean termites.

^fNR, not recommended for interior use in inhabited structures.

^g2.1 kg m⁻³ retention limited to decking and specialty use items.

Chromated Copper Arsenate (CCA)

Wood treated with CCA (commonly called green treated) dominated the treated-wood market from the late 1970s until 2004. However, as the result of the voluntary label changes submitted by the CCA registrants, the EPA labeling of CCA currently permits the product to be used for primarily industrial applications (Table 15–4), and CCA-treated products are generally not available at retail lumber yards. CCA can no longer be used for treatment of lumber intended for use in residential decks or playground equipment. It is important to note that existing structures are not affected by

this labeling change and that the EPA has not recommended removing structures built with CCA-treated lumber. These changes were made as part of the ongoing CCA re-registration process, and in light of the current and anticipated market demand for alternative preservatives for nonindustrial applications. Allowable uses for CCA are based on specific commodity standards listed in the 2001 edition of the AWPAs standards. The most important of these allowable uses are based on the standards for poles, piles, and wood used in highway construction. A list of the most common allowable uses is shown in Table 15–4.

Although several formulations of CCA have been used in the past, CCA Type C has been the primary formulation and is currently the only formulation listed in AWWPA standards. CCA-C was found to have the optimum combination of efficacy and resistance to leaching, but the earlier formulations (CCA-A and CCA-B) have also provided long-term protection for treated stakes exposed in Mississippi (Table 15-5). CCA-C has an actives composition of 47.5% chromium trioxide, 34.0% arsenic pentoxide, and 18.5% copper oxide. AWWPA Standard P5 permits substitution of potassium or sodium dichromate for chromium trioxide; copper sulfate, basic copper carbonate, or copper hydroxide

for copper oxide; and arsenic acid, sodium arsenate, or pyroarsenate for arsenic pentoxide.

High retention levels (40 kg m⁻³ (2.5 lb ft⁻³)) of CCA preservative provide good resistance to attack by the marine borers *Limnoria* and *Teredo* (Table 15-2).

Alkaline Copper Quat (ACQ)

Alkaline copper quat (ACQ) has an actives composition of 67% copper oxide and 33% quaternary ammonium compound (quat). Multiple variations of ACQ have been standardized. ACQ type B (ACQ-B) is an ammoniacal copper formulation, ACQ type D (ACQ-D) is an amine copper formulation, and ACQ type C (ACQ-C) is a combined ammoniacal-amine formulation with a slightly different quat compound. The multiple formulations of ACQ allow some flexibility in achieving compatibility with a specific wood species and application. When ammonia is used as the carrier, ACQ has improved ability to penetrate difficult-to-treat wood species. However, if the wood species is readily treatable, such as Southern Pine sapwood, an amine carrier can be used to provide a more uniform surface appearance. Recently ACQ has been formulated using small particles of copper rather than copper solubilized in ethanolamine. These formulations are discussed in more detail in the Preservatives with ICC-ES Evaluation Reports section. Use of particulate copper formulations of ACQ is currently limited to permeable woods (such as species of pine with a high proportion of sapwood), but efforts continue to adapt the treatment to a broader range of wood species.

Alkaline Copper DCOI (ACD)

Alkaline copper DCOI (ACD) is a recently proposed formulation of alkaline copper ethanolamine that utilizes 4,5-dichloro-2-N-octyl-4-isothiazolin-3-one (DCOI) as co-biocide

Table 15-2. Preservative treatment and retention necessary to protect round timber piles from severe marine borer attack^a

Marine borers and preservatives	Retention (kg m ⁻³) ^b	
	Round piles	Sawn materials
<i>Limnoria tripunctata</i> only		
Ammoniacal copper zinc arsenate	40, 24 ^c	40
Chromated copper arsenate	40, 24 ^c	
Creosote	320, 256 ^c	400
<i>Limnoria tripunctata</i> and Pholads (dual treatment)		
First treatment		
Ammoniacal copper zinc arsenate	16, (1.0)	24
Chromated copper arsenate	16, (1.0)	24
Second treatment		
Creosote	320, (20.0)	320
Creosote solution	320, (20.0)	320

^aSee AWWPA Commodity Specification G for more information.
^bTo convert to retention expressed as lb ft⁻³, divide these values by 16.0.
^cLower retention levels are for marine piling used in areas from New Jersey northward on the East Coast and north of San Francisco on the West Coast in the United States.

Table 15-3. Active ingredients in waterborne preservatives used for pressure treatments

Active ingredient	Preservative
Inorganic actives	
Arsenic	ACZA, CCA
Boron	CBA-A, CX-A, SBX, KDS
Chromium	ACC, CCA
Copper	ACC, ACZA, ACQ-B, ACQ-C, ACQ-D, CA-B, CA-C, CBA-A, CCA, CXA, ESR-1721, ESR-1980, ESR-2240, ESR-2325, KDS, KDS-B, ESR-2711
Zinc	ACZA
Organic actives	
Alkylbenzyl dimethyl ammonium compound	ACQ-C
DCOI	EL2, ESR-2711
Didecyl dimethyl ammonium compound	ACQ-B, ACQ-D
HDO: Bis-(N-cyclohexyldiazoniumdioxo)Cu	CX-A
Imdiacloprid	EL2, PTI, ESR-2067
Propiconazole	CA-C, PTI, ESR-1721
Polymeric betaine	KDS, KDS-B
Tebuconazole	PTI, ESR-1721, ESR-2067, ESR-2325

Table 15–4. Generalized examples of products that may still be treated with CCA under conditions of current label language^a

Type of end use still allowed	2001 AWPA standard
Lumber and timbers used in seawater	C2
Land, fresh-water, and marine piles	C3
Utility poles	C4
Plywood	C9
Wood for highway construction	C14
Round, half-round, and quarter-round fence posts	C16
Poles, piles, and posts used as structural members on farms	C16
Members immersed in or frequently splashed by seawater	C18
Lumber and plywood for permanent wood foundations	C22
Round poles and posts used in building construction	C23
Sawn timbers (at least 5 in. thick) used to support residential and commercial structures	C24
Sawn cross-arms	C25
Structural glued-laminated members	C28
Structural composite lumber (parallel strand or laminated veneer lumber)	C33
Shakes and shingles	C34

^aRefer to the EPA or a treated-wood supplier for the most recent definition of allowable uses.

to provide protection against copper-tolerant fungi. The ratio of alkaline copper to DCOI in the formulation ranges from 20:1 to 25:1. The ACD formulation is listed as a preservative in AWPA standards. It has been proposed for both above-ground and ground-contact applications, but at the time this chapter was finalized it had not yet been standardized for treatment of any commodities.

Copper bis(dimethyldithiocarbamate) (CDDC)

Copper bis(dimethyldithiocarbamate) (CDDC) is a reaction product formed in wood as a result of the dual treatment of two separate treating solutions. The first treating solution contains a maximum of 5% bivalent copper–ethanolamine (2-aminoethanol), and the second treating solution contains a minimum of 2.5% sodium dimethyldithiocarbamate (AWPA P5). Although this preservative is not currently commercially available, CDDC-treated wood products are included in the AWPA Commodity Standards for uses such as residential construction.

Copper Azole (CA–B, CA–C and CBA–A)

Copper azole (CA–B) is a formulation composed of amine copper (96%) and tebuconazole (4%). Copper azole (CA–C) is very similar to CA–B, but half the tebuconazole is replaced with propiconazole. The active ingredients in CA–C are in the ratio of 96% amine copper, 2% tebuconazole, and 2% propiconazole. An earlier formulation (CBA–A) also contained boric acid. Although listed as an amine formulation, copper azole may also be formulated with an amine–ammonia formulation. The ammonia may be included when the copper azole formulations are used to treat refractory species, and the ability of such a formulation to adequately treat Douglas-fir has been demonstrated. Inclusion of ammonia, however, is likely to have slight effects on the surface appearance and initial odor of the treated wood.

Copper HDO (CXA)

Copper HDO (CXA) is an amine copper water-based preservative that has been used in Europe and was recently standardized in the United States. The active ingredients are copper oxide, boric acid, and copper–HDO (bis-(N-cyclohexyldiazoniumdioxo copper). The appearance and handling characteristics of wood treated with copper HDO are similar to those of the other amine copper-based treatments. It is also referred to as copper xyligen. Currently, copper HDO is standardized only for applications that are not in direct contact with soil or water.

Copper Naphthenate (Waterborne)

Waterborne copper naphthenate (CuN–W) has an active composition similar to oil-borne copper naphthenate, but the actives are carried in a solution of ethanolamine and water instead of petroleum solvent. Wood treated with the waterborne formulation has a drier surface and less odor than the oil-borne formulation. The waterborne formulation has been standardized for above-ground and some ground-contact applications (Table 15–1).

Inorganic Boron (Borax–Boric Acid)

Borate preservatives are readily soluble in water and highly leachable and should be used only above ground where the wood is protected from wetting. When used above ground and protected from wetting, this preservative is very effective against decay, termites, beetles, and carpenter ants. Inorganic boron (SBX) is listed in AWPA standards for protected applications such as framing lumber. The solid or treating solution for borate preservatives (borates) should be greater than 98% pure, on an anhydrous basis (AWPA P5). Acceptable borate compounds are sodium octaborate, sodium tetraborate, sodium pentaborate, and boric acid. These compounds are derived from the mineral sodium borate, which is the same material used in laundry additives.

Table 15–5. Results of Forest Products Laboratory studies on 38- by 89- by 457-mm (nominal 2- by 4- by 18-in.) Southern Pine sapwood stakes, pressure-treated with commonly used wood preservatives, installed at Harrison Experimental Forest, Mississippi

Preservative	Average retention (kg m ⁻³ (lb ft ⁻³)) ^a	Average life or condition at last inspection
Controls (untreated stakes)		1.8 to 3.6 years
Acid copper chromate	2.08 (0.13)	11.6 years
	2.24 (0.14)	6.1 years
	4.01 (0.25)	80% failed after 40 years
	4.17 (0.26)	80% failed after 60 years
	4.65 (0.29)	4.6 years
	5.93 (0.37)	60% failed after 60 years
	8.01 (0.50)	50% failed after 40 years
	12.18 (0.76)	22% failed after 40 years
Ammoniacal copper arsenate	2.56 (0.16)	16.6 years
	3.52 (0.22)	80% failed after 30 years
	3.84 (0.24)	38.7 years
	4.01 (0.25)	60% failed after 40 years
	7.37 (0.45)	20% failed after 40 years
	8.17 (0.51)	10% failed after 60 years
	15.54 (0.97)	No failures after 60 years
	20.02 (1.25)	No failures after 60 years
Chromated copper arsenate Type I (Type A)	2.40 (0.15)	28.7 years
	3.52 (0.22)	45% failed after 40 years
Type II (Type B)	4.65 (0.29)	30% failed after 60 years
	7.05 (0.44)	10% failed after 40 years
	7.05 (0.44)	20% failed after 60 years
	3.68 (0.23)	30% failed after 40 years
	4.17 (0.26)	No failures after 46 years
Type III (Type C)	5.93 (0.37)	No failures after 46 years
	8.33 (0.52)	No failures after 46 years
	12.66 (0.79)	No failures after 46 years
	16.66 (1.04)	No failures after 46 years
	2.24 (0.14)	No failures after 25 years
	3.20 (0.20)	No failures after 35 years
	4.00 (0.25)	20% failed after 20 years
	4.33 (0.27)	10% failed after 25 years
6.41 (0.40)	No failures after 35 years	
6.41 (0.40)	No failures after 25 years	
9.61 (0.60)	No failures after 35 years	
9.93 (0.62)	No failures after 25 years	
12.66 (0.79)	No failures after 25 years	
Oxine copper (Copper-8-quinolinolate)	0.22 (0.014)	26.9 years
	0.48 (0.03)	27.3 years
AWPA P9 heavy petroleum	0.95 (0.059)	31.3 years
	1.99 (0.124)	No failures after 45 years
Copper naphthenate	0.11% copper in No. 2 fuel oil	15.9 years
	0.29% copper in No. 2 fuel oil	21.8 years
	0.57% copper in No. 2 fuel oil	27.1 years
	0.86% copper in No. 2 fuel oil	29.6 years
Creosote, coal-tar	52.87 (3.3)	24.9 years
	65.68 (4.1)	14.2 years
	67.28 (4.2)	17.8 years
	73.69 (4.6)	21.3 years
	124.96 (7.8)	70% failed after 54-1/2 years
	128.24 (8.0)	90% failed after 60 years
	132.97 (8.3)	50% failed after 46 years
	160.20 (10.0)	90% failed after 55 years
	189.04 (11.8)	50% failed after 60 years

Table 15–5. Results of Forest Products Laboratory studies on 38- by 89- by 457-mm (nominal 2- by 4- by 18-in.) Southern Pine sapwood stakes, pressure-treated with commonly used wood preservatives, installed at Harrison Experimental Forest, Mississippi—con.

Preservative	Average retention (kg m ⁻³ (lb ft ⁻³)) ^a	Average life or condition at last inspection
Creosote, coal-tar (con.)	211.46 (13.2)	20% failed after 54-1/2 years
	232.29 (14.5)	No failures after 55 years
	264.33 (16.5)	10% failed after 60 years
Pentachlorophenol Stoddard solvent (mineral spirits)	2.24 (0.14)	13.7 years
	2.88 (0.18)	15.9 years
	3.20 (0.20)	9.5 years
	3.20 (0.20)	13.7 years
	6.09 (0.38)	80% failed after 39 years
	6.41 (0.40)	15.5 years
	10.73 (0.67)	No failures after 39 years
Heavy gas oil (Mid-United States)	3.20 (0.20)	89% failed after 50 years
	6.41 (0.40)	80% failed after 50 years
	9.61 (0.60)	20% failed after 50 years
No. 4 aromatic oil (West Coast)	3.36 (0.21)	21.0 years
	6.57 (0.41)	70% failed after 50 years
AWPA P9 (heavy petroleum)	1.76 (0.11)	90% failed after 39 years
	3.04 (0.19)	60% failed after 39 years
	4.65 (0.29)	No failures after 39 years
	8.49 (0.53)	No failures after 35 years
	10.73 (0.67)	No failures after 39 years
	10.73 (0.67)	No failures after 39 years
Petroleum solvent controls	64.08 (4.0)	7.6 years
	65.68 (4.1)	4.4 years
	75.29 (4.7)	12.9 years
	123.35 (7.7)	14.6 years
	126.56 (7.9)	90% failed after 50 years
	128.16 (8.0)	19.7 years
	128.16 (8.0)	23.3 years
	128.16 (8.0)	14.6 years
	129.76 (8.1)	3.4 years
	136.17 (8.5)	20.9 years
	157.00 (9.8)	6.3 years
	192.24 (12.0)	17.1 years
	193.84 (12.1)	80% failed after 50 years
310.79 (19.4)	9.1 years	

^aRetention of active ingredients for preservatives and total solvent for petroleum solvent controls.

In addition to pressure treatments, borates are commonly sprayed, brushed, or injected to treat wood in existing structures. They will diffuse into wood that is wet, so these preservatives are often used as a remedial treatment. Borates are widely used for log homes, natural wood finishes, and hardwood pallets.

EL2

EL2 is a waterborne preservative composed of the fungicide 4,5-dichloro-2-N-octyl-4-isothiazolin-3-one (DCOI), the insecticide imidacloprid, and a moisture control stabilizer (MCS). The ratio of actives is 98% DCOI and 2% imidacloprid, but the MCS is also considered to be a necessary component to ensure preservative efficacy. EL2 is currently listed in AWPA standards for above-ground applications only (Table 15–1).

KDS

KDS and KDS Type B (KDS–B) utilize copper and polymeric betaine as the primary active ingredients. The KDS formulation also contains boron, and has an actives composition of 41% copper oxide, 33% polymeric betaine, and 26% boric acid. KDS–B does not contain boron and has an actives composition of 56% copper oxide and 44% polymeric betaine. KDS is listed for treatment of commodities used above ground and for general use in contact with soil or fresh water. It is not listed for soil or fresh water contact in severe exposures. The listing includes treatment of common pine species as well as Douglas-fir and western hemlock. KDS–B is currently in the process of obtaining listings for specific commodities. The appearance of KDS-treated wood is similar to that of wood treated with other

alkaline copper formulations (light green–brown). It has some odor initially after treatment, but this odor dissipates as the wood dries.

Oligomeric Alkylphenol Polysulfide (PXTS)

PXTS is a recently developed and somewhat unusual preservative system. It is an oligomer formed by the reaction of cresylic acid and sulfur chlorides in the presence of excess sulfur. PXTS is a solid at room temperature but becomes a liquid when heated to above approximately 58 °C. It can also be dissolved and diluted in some aromatic and organic chlorinated solvents. PXTS is not currently listed for treatment of any commodities and is currently not commercially available.

Propiconazole and Tebuconazole

Propiconazole and tebuconazole are organic triazole biocides that are effective against wood decay fungi but not against insects (AWPA P5, P8). They are soluble in some organic solvents but have low solubility in water and are stable and leach resistant in wood. Propiconazole and tebuconazole are currently components of waterborne preservative treatments used for pressure-treatment of wood in the United States, Europe, and Canada. They are also used as components of formulations used to provide mold and sapstain protection. Propiconazole is also standardized for use with AWPA P9 Type C or Type F organic solvents.

Propiconazole–Tebuconazole–Imidacloprid (PTI)

PTI is a waterborne preservative solution composed of two fungicides (propiconazole and tebuconazole) and the insecticide imidacloprid. It is currently listed in AWPA standards for above-ground applications only. The efficacy of PTI is enhanced by the incorporation of a water-repellent stabilizer in the treatment solutions, and lower retentions are allowed with the stabilizer (Table 15–1).

Preservatives with ICC–ES Evaluation Reports

Some commercially available waterborne wood preservatives are not standardized by the AWPA. Instead, they have obtained ICC–ES evaluation reports. In this chapter we refer to these preservatives by their Evaluation Report number (Table 15–1).

ESR–1721

ESR–1721 recognizes three preservative formulations. Two are the same formulations of copper azole (CA–B and CA–C) also listed in AWPA standards. The other (referred to here as ESR–1721) uses particulate copper that is ground to sub-micron dimensions and dispersed in the treatment solution. Wood treated with ESR–1721 has a lighter green color than the CA–B or CA–C formulations because the copper is not dissolved in the treatment solution. All three formulations are listed for treatment of commodities used in a range of applications, including contact with soil or freshwater.

Use of ESR–1721 (dispersed copper) is currently limited to easily treated pine species.

ESR–1980

ESR–1980 includes a listing for both the AWPA standardized formulation of ACQ–D and a waterborne, micronized copper version of alkaline copper quat (referred to here as ESR–1980). The formulation is similar to ACQ in that the active ingredients are 67% copper oxide and 33% quaternary ammonium compound. However, in ESR–1980 the copper is ground to sub-micron dimensions and suspended in the treatment solution instead of being dissolved in ethanolamine. The treated wood has little green color because the copper is not dissolved in the treatment solution. The use of the particulate form of copper is currently limited to the more easily penetrated pine species, but efforts are underway to adapt the formulation for treatment of a broader range of wood species. ESR–1980 is listed for treatment of commodities used in both above-ground and ground-contact applications.

ESR–2067

ESR–2067 is an organic waterborne preservative with an actives composition of 98% tebuconazole (fungicide) and 2% imidacloprid (insecticide). The treatment does not impart any color to the wood. It is currently listed only for treatment of commodities that are not in direct contact with soil or standing water.

ESR–2240

ESR–2240 is a waterborne formulation that utilizes finely ground (micronized) copper in combination with tebuconazole in an actives ratio of 25:1. It is listed for above-ground and ground-contact applications. In addition to wood products cut from pine species, ESR–2240 can be used for treatment of hem–fir lumber and Douglas–fir plywood.

ESR–2325

ESR–2325 is another waterborne preservative that utilizes finely ground copper particles and tebuconazole as actives. The ratio of copper to tebuconazole in the treatment solution is 25:1. Its use is currently limited to more readily treated species such as the Southern Pine species group, but Douglas–fir plywood is also listed. ESR–2315 is listed for treatment of wood used above-ground and in contact with soil or fresh water.

ESR–2711

ESR–2711 combines copper solubilized in ethanolamine with the fungicide 4,5-dichloro-2-N-octyl-4-isothiazolin-3-one (DCOI). The ratio of copper (as CuO) to DCOIT ranges from 10:1 to 25:1. The ESR listing provides for both above-ground and ground-contact applications. The appearance of the treated wood is similar to that of wood treated with other formulations utilizing soluble copper, such as ACQ. It is currently only listed for treatment of pine species.

Oil-Borne or Oil-Type Preservatives

Oil-type wood preservatives are some of the oldest preservatives, and their use continues in many applications. Wood does not swell from treatment with preservative oils, but it may shrink if it loses moisture during the treating process. Creosote and solutions with heavy, less volatile petroleum oils often help protect wood from weathering but may adversely influence its cleanliness, odor, color, paintability, and fire performance. Volatile oils or solvents with oil-borne preservatives, if removed after treatment, leave the wood cleaner than do the heavy oils but may not provide as much protection. Wood treated with some preservative oils can be glued satisfactorily, although special processing or cleaning may be required to remove surplus oils from surfaces before spreading the adhesive.

Coal-Tar Creosote and Creosote Solutions

Coal-tar creosote (creosote) is a black or brownish oil made by distilling coal tar that is obtained after high-temperature carbonization of coal. Advantages of creosote are (a) high toxicity to wood-destroying organisms; (b) relative insolubility in water and low volatility, which impart to it a great degree of permanence under the most varied use conditions; (c) ease of application; (d) ease with which its depth of penetration can be determined; (e) relative low cost (when purchased in wholesale quantities); and (f) lengthy record of satisfactory use. Creosote is commonly used for heavy timbers, poles, piles, and railroad ties.

AWPA Standard P1/P13 provides specifications for coal-tar creosote used for preservative treatment of piles, poles, and timber for marine, land, and freshwater use. The character of the tar used, the method of distillation, and the temperature range in which the creosote fraction is collected all influence the composition of the creosote, and the composition may vary within the requirements of standard specifications. Under normal conditions, requirements of these standards can be met without difficulty by most creosote producers.

Coal tar or petroleum oil may also be mixed with coal-tar creosote, in various proportions, to lower preservative costs. AWPA Standard P2 provides specifications for coal-tar solutions. AWPA Standard P3 stipulates that creosote–petroleum oil solution shall consist solely of specified proportions of 50% coal-tar creosote by volume (which meets AWPA standard P1/P13) and 50% petroleum oil by volume (which meets AWPA standard P4). However, because no analytical standards exist to verify the compliance of P3 solutions after they have been mixed, the consumer assumes the risk of using these solutions. These creosote solutions have a satisfactory record of performance, particularly for railroad ties and posts where surface appearance of the treated wood is of minor importance. Compared with straight creosote, creosote solutions tend to reduce weathering and checking of the treated wood. These solutions have a greater tendency to accumulate on the surface of the treated wood (bleed) and penetrate the wood with greater difficulty because they are

generally more viscous than is straight creosote. High temperatures and pressures during treatment, when they can be safely used, will often improve penetration of high-viscosity solutions.

Although coal-tar creosote or creosote solutions are well suited for general outdoor service in structural timbers, creosote has properties that are undesirable for some purposes. The color of creosote and the fact that creosote-treated wood usually cannot be painted satisfactorily make this preservative unsuitable where appearance and paintability are important.

The odor of creosote-treated wood is unpleasant to some people. Also, creosote vapors are harmful to growing plants, and foodstuffs that are sensitive to odors should not be stored where creosote odors are present. Workers sometimes object to creosote-treated wood because it soils their clothes, and creosote vapor photosensitizes exposed skin. With precautions to avoid direct skin contact with creosote, there appears to be minimal danger to the health of workers handling or working near the treated wood. The EPA or the wood treater should be contacted for specific information on this subject.

In 1986, creosote became a restricted-use pesticide, and its use is currently restricted to pressure-treatment facilities. For use and handling of creosote-treated wood, refer to the EPA-approved Consumer Information Sheet.

Freshly creosoted timber can be ignited and burns readily, producing a dense smoke. However, after the timber has seasoned for some months, the more volatile parts of the oil disappear from near the surface and the creosoted wood usually is little, if any, easier to ignite than untreated wood. Until this volatile oil has evaporated, ordinary precautions should be taken to prevent fires. Creosote adds fuel value, but it does not sustain ignition.

Other Creosotes

Creosotes distilled from tars other than coal tar have been used to some extent for wood preservation, although they are not included in current AWPA specifications. These include wood-tar creosote, oil-tar creosote, and water–gas-tar creosote. These creosotes provide some protection from decay and insect attack but are generally less effective than coal-tar creosote.

Pentachlorophenol Solutions

Water-repellent solutions containing chlorinated phenols, principally pentachlorophenol (penta), in solvents of the mineral spirits type, were first used in commercial dip treatments of wood by the millwork industry in about 1931. Commercial pressure treatment with pentachlorophenol in heavy petroleum oils on poles started in about 1941, and considerable quantities of various products soon were pressure treated. AWPA Standard P8 defines the properties of pentachlorophenol preservative, stating that pentachlorophenol solutions for wood preservation shall contain not less

than 95% chlorinated phenols, as determined by titration of hydroxyl and calculated as pentachlorophenol.

AWPA standard P9 defines solvents and formulations for organic preservative systems. The performance of pentachlorophenol and the properties of the treated wood are influenced by the properties of the solvent used. A commercial process using pentachlorophenol dissolved in liquid petroleum gas (LPG) was introduced in 1961, but later research showed that field performance of penta-LPG systems was inferior to penta-P9 systems. Thus, penta-LPG systems are no longer used. The heavy petroleum solvent included in AWPA P9 Type A is preferable for maximum protection, particularly when wood treated with pentachlorophenol is used in contact with the ground. The heavy oils remain in the wood for a long time and do not usually provide a clean or paintable surface.

Because of the toxicity of pentachlorophenol, care is necessary when handling and using it to avoid excessive personal contact with the solution or vapor. Do not use indoors or where human, plant, or animal contact is likely. Pentachlorophenol became a restricted-use pesticide in November 1986 and is currently only available for use in pressure treatment. For use and handling precautions, refer to the EPA-approved Consumer Information Sheet.

The results of pole service and field tests on wood treated with 5% pentachlorophenol in a heavy petroleum oil are similar to those with coal-tar creosote. This similarity has been recognized in the preservative retention requirements of treatment specifications. Pentachlorophenol is effective against many organisms, such as decay fungi, molds, stains, and insects. Because pentachlorophenol is ineffective against marine borers, it is not recommended for the treatment of marine piles or timbers used in coastal waters.

Copper Naphthenate

Copper naphthenate is an organometallic compound formed as a reaction product of copper salts and naphthenic acids that are usually obtained as byproducts in petroleum refining. It is a dark green liquid and imparts this color to the wood. Weathering turns the color of the treated wood to light brown after several months of exposure. The wood may vary from light brown to chocolate brown if heat is used in the treating process. AWPA P8 standard defines the properties of copper naphthenate, and AWPA P9 covers the solvents and formulations for organic preservative systems.

Copper naphthenate is effective against wood-destroying fungi and insects. It has been used commercially since the 1940s and is currently standardized for a broad range of applications (Table 15–1). Copper naphthenate is not a restricted-use pesticide but should be handled as an industrial pesticide. It may be used for superficial treatment, such as by brushing with solutions with a copper content of 1% to 2% (approximately 10% to 20% copper naphthenate).

Water-based formulations of copper naphthenate may also be available.

Oxine Copper (copper-8-quinolinolate)

Oxine copper (copper-8-quinolinolate) is an organometallic compound, and the formulation consists of at least 10% copper-8-quinolinolate, 10% nickel-2-ethylhexanoate, and 80% inert ingredients (AWPA P8). It is accepted as a stand-alone preservative for aboveground use for sapstain and mold control and is also used for pressure treating (Table 15–1). A water-soluble form can be made with dodecylbenzene sulfonic acid, but the solution is corrosive to metals.

Oxine copper solutions are greenish brown, odorless, toxic to both wood decay fungi and insects, and have a low toxicity to humans and animals. Because of its low toxicity to humans and animals, oxine copper is the only EPA-registered preservative permitted by the U.S. Food and Drug Administration for treatment of wood used in direct contact with food. Some examples of its uses in wood are commercial refrigeration units, fruit and vegetable baskets and boxes, and water tanks. Oxine copper solutions have also been used on nonwood materials, such as webbing, cordage, cloth, leather, and plastics.

Zinc Naphthenate

Zinc naphthenate is similar to copper naphthenate but is less effective in preventing decay from wood-destroying fungi and mildew. It is light colored and does not impart the characteristic greenish color of copper naphthenate, but it does impart an odor. Waterborne and solventborne formulations are available. Zinc naphthenate is not widely used for pressure treating.

3-Iodo-2-Propynyl Butyl Carbamate

3-Iodo-2-propynyl butyl carbamate (IPBC) is a fungicide that is used as a component of sapstain and millwork preservatives. It is also included as a fungicide in several surface-applied water-repellent-preservative formulations. Waterborne and solvent-borne formulations are available. Some formulations yield an odorless, treated product that can be painted if dried after treatment. It is listed as a pressure-treatment preservative in the AWPA standards but is not currently standardized for pressure treatment of any wood products. IPBC also may be combined with other fungicides, such as didecyltrimethylammonium chloride in formulations used to prevent mold and sapstain.

IPBC/Permethrin

IPBC is not an effective insecticide and has recently been standardized for use in combination with the insecticide permethrin (3-phenoxybenzyl-(1R,S)-cis, trans-2, 2-dimethyl-3-(2,2-dichlorovinyl) cyclopropanecarboxylate) under the designation IPBC/PER. Permethrin is a synthetic pyrethroid widely used for insect control in agricultural and structural applications. The ratio of IPBC to permethrin in the IPBC/PER varies between 1.5:1 and 2.5:1. The formulation is

carried in a light solvent such as mineral spirits, making it compatible with composite wood products that might be negatively affected by the swelling associated with water-based pressure treatments. The IPBC/PER formulation is intended only for use in above-ground applications. The formulation is listed as a preservative in AWP standards, but at the time this chapter was finalized it had not yet been standardized for treatment of any commodities.

Alkyl Ammonium Compounds

Alkyl ammonium compounds such as didecyldimethylammonium chloride (DDAC) or didecyldimethylammonium carbonate (DDAC)/bicarbonate (DDABC) have some efficacy against both wood decay fungi and insects. They are soluble in both organic solvents and water and are stable in wood as a result of chemical fixation reactions. DDAC and DDABC are currently being used as a component of alkaline copper quat (ACQ) (see section on Waterborne Preservatives) for above-ground and ground-contact applications and as a component of formulations used for sapstain and mold control.

4,5-Dichloro-2-N-Octyl-4-Isothiazolin-3-One (DCOI)

4,5-dichloro-2-N-octyl-4-isothiazolin-3-one (DCOI) is a biocide that is primarily effective against wood decay fungi. It is soluble in organic solvents but not in water, and it is stable and leach resistant in wood. The solvent used in the formulation of the preservative is specified in AWP P9 Type C. DCOI can be formulated to be carried in a waterborne system, and it is currently used as a component in the waterborne preservative EL2. It has also recently been proposed for use as co-biocide in a copper ethanolamine formulation referred to as ACD.

Chlorpyrifos

Chlorpyrifos (CPF) is an organophosphate insecticide that has been widely used for agricultural purposes. It has been standardized by the AWP as a preservative but is not currently used as a component of commercial pressure treatments. Chlorpyrifos is not effective in preventing fungal attack and should be combined with an appropriate fungicidal preservative for most applications.

Treatments for Wood Composites

Many structural composite wood products, such as glued-laminated beams, plywood, and parallel strand and laminated veneer lumber, can be pressure-treated with wood preservatives in a manner similar to lumber. However, flake- or fiber-based composites are often protected by adding preservative during manufacture. A commonly used preservative for these types of composites is zinc borate. Zinc borate is a white, odorless powder with low water solubility that is added directly to the furnish or wax during panel manufacture. Zinc borate has greater leach resistance than the more soluble forms of borate used for pressure treatment and thus can be used to treat composite siding products that are exposed outdoors but partially protected from the weather.

Zinc borate is currently listed in AWP Commodity Standard J for nonpressure treatment of laminated strand lumber, oriented strandboard, and engineered wood siding. The standard requires that these products have an exterior coating or laminate when used as siding. Another preservative that has been used to protect composites is ammoniacal copper acetate, which is applied by spraying the preservative onto the OSB flakes before drying.

Water-Repellent and Nonpressure Treatments

Effective water-repellent preservatives will retard the ingress of water when wood is exposed above ground. These preservatives help reduce dimensional changes in the wood as a result of moisture changes when the wood is exposed to rainwater or dampness for short periods. As with any wood preservative, the effectiveness in protecting wood against decay and insects depends upon the retention and penetration obtained in application. These preservatives are most often applied using nonpressure treatments such as vacuum impregnation, brushing, soaking, or dipping. Preservative systems containing water-repellent components are sold under various trade names, principally for the dip or equivalent treatment of window sash and other millwork. The National Wood Window and Door Association (NWWDA) standard, WDMA I.S. 4–07A, *Water Repellent Preservative Treatment for Millwork*, lists preservative formulations that have met certain requirements, including EPA registration and efficacy against decay fungi.

The AWP Commodity Specification I for nonpressure treatment of millwork and other wood products provides requirements for these nonpressure preservatives but does not currently list any formulations. The preservative must also meet the *Guidelines for Evaluating New Wood Preservatives for Consideration by the AWP* for nonpressure treatment.

Water-repellent preservatives containing oxine copper are used in nonpressure treatment of wood containers, pallets, and other products for use in contact with foods. When combined with volatile solvents, oxine copper is used to pressure-treat lumber intended for use in decking of trucks and cars or related uses involving harvesting, storage, and transportation of foods (AWP P8).

Nonpressure preservatives sold to consumers for household and farm use typically contain copper naphthenate, zinc naphthenate, or oxine copper. Their formulations may also incorporate water repellents.

Selecting Preservatives

The type of preservative applied is often dependent on the requirements of the specific application. For example, direct contact with soil or water is considered a severe deterioration hazard, and preservatives used in these applications must have a high degree of leach resistance and efficacy against a broad spectrum of organisms. These same



Figure 15–1. Field stake test plot at Harrison Experimental Forest in southern Mississippi.

preservatives may also be used at lower retentions to protect wood exposed in lower deterioration hazards, such as above the ground. The exposure is less severe for wood that is partially protected from the weather, and preservatives that lack the permanence or toxicity to withstand continued exposure to precipitation may be effective in those applications. Other formulations may be so readily leachable that they can be used only indoors.

To guide selection of the types of preservatives and loadings appropriate to a specific end use, the AWPAs recently developed use category system (UCS) standards. The UCS standards simplify the process of finding appropriate preservatives and preservative retentions for specific end uses. They categorize treated wood applications by the severity of the deterioration hazard (Table 15–6). The lowest category, Use Category 1 (UC1), is for wood that is used in interior construction and kept dry; UC2 is for interior wood completely protected from the weather but occasionally damp. UC3 is for exterior wood used above ground; UC4 is for wood used in ground contact in exterior applications. UC5 includes applications that place treated wood in contact with seawater and marine borers. Individual commodity specifications then list all the preservatives that are standardized for a specific use category along with the appropriate preservative retention.

Although some preservatives are effective in almost all environments, they may not be well-suited for applications involving frequent human contact or for exposures that present only low to moderate biodeterioration hazards. Additional considerations include cost, potential odor, surface dryness, adhesive bonding, and ease of finish application.

Evaluating New Preservatives

Wood preservatives often need to provide protection from a wide range of wood-attacking organisms (fungi, insects, marine borers, and bacteria). Because they must protect wood in so many ways, and protect wood for a long time period,

evaluating wood treatments requires numerous tests. Some of the most important tests are mentioned here, but they should be considered only as a minimum, and other tests are useful as well. Appendix A of the AWPAs Standards provides detailed guidelines on the types of tests that may be needed to evaluate new wood preservatives.

The *laboratory leaching test* helps to evaluate how rapidly the treatment will be depleted. A treatment needs leach resistance to provide long-term protection. In this test small cubes of wood are immersed in water for 2 weeks.

The *laboratory decay test* is used to challenge the treated wood with certain fungal isolates that are known to aggressively degrade wood. It should be conducted with specimens that have been through the leaching test. The extent of decay in wood treated with the test preservative is compared to that of untreated wood and wood treated with an established preservative. This test can help to determine the treatment level needed to prevent decay.

Field stake evaluations are some of the most informative tests because they challenge the treated wood with a wide range of natural organisms under severe conditions (Fig. 15–1). Stakes are placed into the soil in regions with a warm, wet climate (usually either the southeastern United States or Hawaii). At least two different sites are used to account for differences in soil properties and types of organisms present. The extent of deterioration in wood treated with the test preservative is compared to that of untreated wood and wood treated with an established preservative.

Above-ground field exposures are useful for treatments that will be used to protect wood above ground. Although not as severe as field stake tests, above-ground tests do provide useful information on above-ground durability. Specimens are exposed to the weather in an area with a warm, wet climate (usually either the southeastern United States or Hawaii). The specimens are designed to trap moisture and create ideal conditions for above-ground decay. The extent of deterioration in wood treated with the test preservative is compared to that of untreated wood and wood treated with an established preservative.

Corrosion testing is used to determine the compatibility of the treatment with metal fasteners.

Treatability testing is used to evaluate the ability of a treatment to penetrate deeply into the wood. Shallow surface treatments rarely provide long-term protection because degrading organisms can still attack the interior of the wood.

Strength testing compares the mechanical properties of treated wood with matched, untreated specimens. Treatment chemicals or processes have the potential to damage the wood, making it weak or brittle.

Preservative Effectiveness

Preservative effectiveness is influenced not only by the protective value of the preservative chemical, but also by the

Table 15–6. Summary of use category system developed by the American Wood Protection Association

Use category	Service conditions	Use environment	Common agents of deterioration	Typical applications
UC1	Interior construction Above ground Dry	Continuously protected from weather or other sources of moisture	Insects only	Interior construction and furnishings
UC2	Interior construction Above ground Damp	Protected from weather, but may be subject to sources of moisture	Decay fungi and insects	Interior construction
UC3A	Exterior construction Above ground Coated and rapid water runoff	Exposed to all weather cycles, not exposed to prolonged wetting	Decay fungi and insects	Coated millwork, siding, and trim
UC3B	Ground contact or fresh water Non-critical components	Exposed to all weather cycles, normal exposure conditions	Decay fungi and insects	Fence, deck, and guardrail posts, crossties and utility poles (low decay areas)
UC4A	Ground contact or fresh water Non-critical components	Exposed to all weather cycles, normal exposure conditions	Decay fungi and insects	Fence, deck, and guardrail posts, crossties and utility poles (low decay areas)
UC4B	Ground contact or fresh water Critical components or difficult replacement	Exposed to all weather cycles, high decay potential includes salt-water splash	Decay fungi and insects with increased potential for biodeterioration	Permanent wood foundations, building poles, horticultural posts, crossties and utility poles (high decay areas)
UC4C	Ground contact or fresh water Critical structural components	Exposed to all weather cycles, severe environments, extreme decay potential	Decay fungi and insects with extreme potential for biodeterioration	Land and fresh-water piling, foundation piling, crossties and utility poles (severe decay areas)
UC5A	Salt or brackish water and adjacent mud zone Northern waters	Continuous marine exposure (salt water)	Salt-water organisms	Piling, bulkheads, bracing
UC5B	Salt or brackish water and adjacent mud zone NJ to GA, south of San Francisco	Continuous marine exposure (salt water)	Salt-water organisms, including creosote-tolerant <i>Limnoria tripunctata</i>	Piling, bulkheads, bracing
UC5C	Salt or brackish water and adjacent mud zone South of GA, Gulf Coast, Hawaii, and Puerto Rico	Continuous marine exposure (salt water)	Salt-water organisms, including <i>Martesia</i> , <i>Sphaeroma</i>	Piling, bulkheads, bracing

method of application and extent of penetration and retention of the preservative in the treated wood. Even with an effective preservative, good protection cannot be expected with poor penetration or substandard retention levels. The species of wood, proportion of heartwood and sapwood, heartwood penetrability, and moisture content are among the important variables that influence the results of treatment. For various wood products, the preservatives and retention levels listed in the AWPA Commodity Standards or ICC–ES evaluation reports are given in Table 15–1.

Determining whether one preservative is more effective than another within a given use category is often difficult.

Few service tests include a variety of preservatives under comparable conditions of exposure. Furthermore, service tests may not show a good comparison between different preservatives as a result of the difficulty in controlling for differences in treatment quality. Comparative data under similar exposure conditions, with various preservatives and retention levels, are included in the U.S. Forest Service, Forest Products Laboratory, stake test studies. A summary of these test results is included in Table 15–5. Note, however, that because the stakes used in these studies are treated under carefully controlled conditions, their performance may not reflect variability in performance exhibited by a broad range of commercially treated material.



Figure 15–2. During pressure treatment, preservative typically penetrates only the sapwood. Round members have a uniform treated sapwood shell, but sawn members may have less penetration on one or more faces.

Similar comparisons have been conducted for preservative treatments of small wood panels in marine exposure (Key West, Florida). These preservatives and treatments include creosotes with and without supplements, waterborne preservatives, waterborne preservative and creosote dual treatments, chemical modifications of wood, and various chemically modified polymers. In this study, untreated panels were badly damaged by marine borers after 6 to 18 months of exposure, whereas some treated panels have remained free of attack after 19 years in the sea.

Test results based on seawater exposure have shown that dual treatment (waterborne copper-containing preservatives followed by creosote) is possibly the most effective method of protecting wood against all types of marine borers. The AWP standards have recognized this process as well as the treatment of marine piles with high retention levels of ammoniacal copper zinc arsenate (ACZA) or chromated copper arsenate (CCA). The recommended treatment and retention in kilograms per cubic meter (pounds per cubic foot) for round timber piles exposed to severe marine borer hazard are given in Table 15–2. Poorly treated or untreated heartwood faces of wood species containing “high sapwood” that do not require heartwood penetration (for example, southern pines, ponderosa pine, and red pine) have been found to perform inadequately in marine exposure. In marine applications, only sapwood faces should be allowed for waterborne-preservative-treated pine in direct seawater exposure.

Effect of Species on Penetration

The effectiveness of preservative treatment is influenced by the penetration and distribution of the preservative in the wood. For maximum protection, it is desirable to select species for which good penetration is assured.

In general, the sapwood of most softwood species is not difficult to treat under pressure (Fig. 15–2). Examples of species with sapwood that is easily penetrated when it is well dried and pressure treated are the pines, coastal Douglas-fir,

western larch, Sitka spruce, western hemlock, western red-cedar, northern white-cedar, and white fir (*A. concolor*). Examples of species with sapwood and heartwood somewhat resistant to penetration are the red and white spruces and Rocky Mountain Douglas-fir. Cedar poles are commonly incised to obtain satisfactory preservative penetration. With round members, such as poles, posts, and piles, the penetration of the sapwood is important in achieving a protective outer zone around the heartwood.

The proportion of sapwood varies greatly with wood species, and this becomes an important factor in obtaining adequate penetration. Species within the Southern Pine group are characterized by a large sapwood zone that is readily penetrated by most types of preservatives. In part because of their large proportion of treatable sapwood, these pine species are used for the vast majority of treated products in the United States. Other important lumber species, such as Douglas-fir, have a narrower sapwood band in the living tree, and as a result products manufactured from Douglas-fir have a lower proportion of treatable sapwood.

The heartwood of most species is difficult to treat. There may be variations in the resistance to preservative penetration of different wood species. Table 15–7 gives the relative resistance of the heartwood to treatment of various softwood and hardwood species. Although less treatable than sapwood, well-dried white fir, western hemlock, northern red oak, the ashes, and tupelo are examples of species with heartwood that is reasonably easy to penetrate. The southern pines, ponderosa pine, redwood, Sitka spruce, coastal Douglas-fir, beech, maples, and birches are examples of species with heartwood that is moderately resistant to penetration.

Preparation of Wood for Treatment

For satisfactory treatment and good performance, the wood product must be sound and suitably prepared. Except in specialized treating methods involving unpeeled or green material, the wood should be well peeled and either seasoned or conditioned in the cylinder before treatment. It is also highly desirable that all machining be completed before treatment, including incising (to improve the preservative penetration in woods that are resistant to treatment) and the operations of cutting or boring of holes.

Peeling

Peeling round or slabbed products is necessary to enable the wood to dry quickly enough to avoid decay and insect damage and to permit the preservative to penetrate satisfactorily. Even strips of the thin inner bark may prevent penetration. Patches of bark left on during treatment usually fall off in time and expose untreated wood, thus permitting decay to reach the interior of the member.

Careful peeling is especially important for wood that is to be treated by a nonpressure method. In the more thorough

Table 15–7. Penetration of the heartwood of various softwood and hardwood species^a

Ease of treatment	Softwoods	Hardwoods
Least difficult	Bristlecone pine (<i>Pinus aristata</i>)	American basswood (<i>Tilia americana</i>)
	Pinyon (<i>P. edulis</i>)	Beech (white heartwood) (<i>Fagus grandifolia</i>)
	Pondersosa pine (<i>P. ponderosa</i>)	Black tupelo (blackgum) (<i>Nyssa sylvatica</i>)
	Redwood (<i>Sequoia sempervirens</i>)	Green ash (<i>Fraxinus pennsylvanica</i> var. <i>lanceolata</i>)
		Pin cherry (<i>Prunus pennsylvanica</i>)
		River birch (<i>Betula nigra</i>)
		Red oak (<i>Quercus</i> spp.)
		Slippery elm (<i>Ulmus fulva</i>)
		Sweet birch (<i>Betula lenia</i>)
		Water tupelo (<i>Nyssa aquatica</i>)
Moderately difficult	Baldcypress (<i>Taxodium distichum</i>)	White ash (<i>Fraxinus americana</i>)
	California red fir (<i>Abies magnifica</i>)	Black willow (<i>Salix nigra</i>)
	Douglas-fir (coast) (<i>Pseudotsuga taxifolia</i>)	Chestnut oak (<i>Quercus montana</i>)
	Eastern white pine (<i>Pinus strobus</i>)	Cottonwood (<i>Populus</i> sp.)
	Jack pine (<i>P. banksiana</i>)	Bigtooth aspen (<i>P. grandidentata</i>)
	Loblolly pine (<i>P. taeda</i>)	Mockernut hickory (<i>Carya tomentosa</i>)
	Longleaf pine (<i>P. palustris</i>)	Silver maple (<i>Acer saccharinum</i>)
	Red pine (<i>P. resinosa</i>)	Sugar maple (<i>A. saccharum</i>)
	Shortleaf pine (<i>P. echinata</i>)	Yellow birch (<i>Betula lutea</i>)
	Sugar pine (<i>P. lambertiana</i>)	
Difficult	Western hemlock (<i>Tsuga heterophylla</i>)	
	Eastern hemlock (<i>Tsuga canadensis</i>)	American sycamore (<i>Platanus occidentalis</i>)
	Engelmann spruce (<i>Picea engelmanni</i>)	Hackberry (<i>Celtis occidentalis</i>)
	Grand fir (<i>Abies grandis</i>)	Rock elm (<i>Ulmus thomasi</i>)
	Lodgepole pine (<i>Pinus contorta</i> var. <i>latifolia</i>)	Yellow-poplar (<i>Liriodendron tulipifera</i>)
	Noble fir (<i>Abies procera</i>)	
	Sitka spruce (<i>Picea sitchensis</i>)	
	Western larch (<i>Larix occidentalis</i>)	
Very difficult	White fir (<i>Abies concolor</i>)	
	White spruce (<i>Picea glauca</i>)	
	Alpine fir (<i>Abies lasiocarpa</i>)	American beech (red heartwood) (<i>Fagus grandifolia</i>)
	Corkbark fir (<i>A. lasiocarpa</i> var. <i>arizonica</i>)	American chestnut (<i>Castanea dentata</i>)
	Douglas-fir (Rocky Mountain) (<i>Pseudotsuga taxifolia</i>)	Black locust (<i>Robinia pseudoacacia</i>)
	Northern white-cedar (<i>Thuja occidentalis</i>)	Blackjack oak (<i>Quercus marilandica</i>)
	Tamarack (<i>Larix laricina</i>)	Sweetgum (redgum) (<i>Liquidambar styraciflua</i>)
Western redcedar (<i>Thuja plicata</i>)	White oak (<i>Quercus</i> spp.)	

^aAs covered in MacLean (1952).

processes, some penetration may take place both longitudinally and tangentially in the wood; consequently, small strips of bark are tolerated in some specifications. Processes in which a preservative is forced or permitted to diffuse through green wood lengthwise do not require peeling of the timber. Machines of various types have been developed for peeling round timbers, such as poles, piles, and posts (Fig. 15–3).

Drying

Drying of wood before treatment is necessary to prevent decay and stain and to obtain preservative penetration. However, for treatment with waterborne preservatives by certain diffusion methods, high moisture content levels may be permitted. For treatment by other methods, however, drying before treatment is essential. Drying before treatment opens up the checks before the preservative is applied, thus increasing penetration, and reduces the risk of checks

opening after treatment and exposing unpenetrated wood. Good penetration of heated organic-based preservatives may be possible in wood with a moisture content as high as 40% to 60%, but severe checking while drying after treatment can expose untreated wood.

For large timbers and railroad ties, air drying is a widely used method of conditioning. Despite the increased time, labor, and storage space required, air drying is generally the most inexpensive and effective method, even for pressure treatment. However, wet, warm climatic conditions make it difficult to air dry wood adequately without objectionable infection by stain, mold, and decay fungi. Such infected wood is often highly permeable; in rainy weather, infected wood can absorb a large quantity of water, which prevents satisfactory treatment.

How long the timber must be air dried before treatment depends on the climate, location, and condition of the



Figure 15-3. Machine peeling of poles. The outer bark has been removed by hand, and the inner bark is being peeled by machine. Frequently, all the bark is removed by machine.



Figure 15-4. Deep incising permits better penetration of preservative.

seasoning yard, methods of piling, season of the year, timber size, and species. The most satisfactory seasoning practice for any specific case will depend on the individual drying conditions and the preservative treatment to be used. Therefore, treating specifications are not always specific as to moisture content requirements.

To prevent decay and other forms of fungal infection during air drying, the wood should be cut and dried when conditions are less favorable for fungus development (Chap. 14). If this is impossible, chances for infection can be minimized by prompt conditioning of the green material, careful piling and roofing during air drying, and pretreating the green wood with preservatives to protect it during air drying.

Lumber of all species, including Southern Pine poles, is often kiln dried before treatment, particularly in the southern United States where proper air seasoning is difficult. Kiln drying has the important added advantage of quickly reducing moisture content, thereby reducing transportation charges on poles.

Conditioning of Green Products

Plants that treat wood by pressure processes can condition green material by means other than air and kiln drying. Thus, they avoid a long delay and possible deterioration of the timber before treatment.

When green wood is to be treated under pressure, one of several methods for conditioning may be selected. The steaming-and-vacuum process is used mainly for southern pines, and the Boulton or boiling-under-vacuum process is used for Douglas-fir and sometimes hardwoods.

In the steaming process, the green wood is steamed in the treating cylinder for several hours, usually at a maximum of 118 °C (245 °F). When steaming is completed, a vacuum is immediately applied. During the steaming period, the outer part of the wood is heated to a temperature approaching that of the steam; the subsequent vacuum lowers the boiling point so that part of the water is evaporated or forced out of the wood by the steam produced when the vacuum is applied. The steaming and vacuum periods used depend upon the wood size, species, and moisture content. Steaming and vacuum usually reduce the moisture content of green wood slightly, and the heating assists greatly in getting the preservative to penetrate. A sufficiently long steaming period will also sterilize the wood.

In the Boulton or boiling-under-vacuum method of partial seasoning, the wood is heated in the oil preservative under vacuum, usually at about 82 to 104 °C (180 to 220 °F). This temperature range, lower than that of the steaming process, is a considerable advantage in treating woods that are especially susceptible to injury from high temperatures. The Boulton method removes much less moisture from heartwood than from sapwood.

Incising

Wood that is resistant to penetration by preservatives may be incised before treatment to permit deeper and more uniform penetration. To incise, lumber and timbers are passed through rollers equipped with teeth that sink into the wood to a predetermined depth, usually 13 to 19 mm (1/2 to 3/4 in.). The teeth are spaced to give the desired distribution of preservative with the minimum number of incisions. A machine of different design is required for deeply incising the butts of poles, usually to a depth of 64 mm (2.5 in.) (Fig. 15-4).

Incising is effective because preservatives usually penetrate the wood much farther along the grain than across the grain. The incisions open cell lumens along the grain, which

greatly enhances penetration. Incising is especially effective in improving penetration in the heartwood areas of sawn surfaces.

Incising is practiced primarily on Douglas-fir, western hemlock, and western larch ties and timbers for pressure treatment and on cedar and Douglas-fir poles. Incising can result in significant reductions in strength (Chap. 5).

Cutting and Framing

All cutting and boring of holes should be done prior to preservative treatment. Cutting into the wood in any way after treatment will frequently expose the untreated interior of the timber and permit ready access to decay fungi or insects.

In some cases, wood structures can be designed so that all cutting and framing is done before treatment. Railroad companies have followed this practice and have found it not only practical but economical. Many wood-preserving plants are equipped to carry on such operations as the adzing and boring of crossties; gaging, roofing, and boring of poles; and framing of material for bridges and specialized structures, such as water tanks and barges.

Treatment of the wood with preservative oils results in little or no dimensional change. With waterborne preservatives, however, some change in the size and shape of the wood may occur even though the wood is redried to the moisture content it had before treatment. If precision fitting is necessary, the wood is cut and framed before treatment to its approximate final dimensions to allow for slight surfacing, trimming, and reaming of bolt holes. Grooves and bolt holes for timber connectors are cut before treatment and can be reamed out if necessary after treatment.

Application of Preservatives

Wood-preserving methods are of two general types: (a) pressure processes, in which the wood is impregnated in closed vessels under pressures considerably above atmospheric, and (b) nonpressure processes, which vary widely in the procedures and equipment used.

Pressure Processes

In commercial practice, wood is most often treated by immersing it in a preservative in a high-pressure apparatus and applying pressure to drive the preservative into the wood. Pressure processes differ in details, but the general principle is the same. The wood, on cars or trams, is run into a long steel cylinder, which is then closed and filled with preservative (Fig. 15–5). Pressure forces the preservative into the wood until the desired amount has been absorbed. Considerable preservative is absorbed, with relatively deep penetration. Three pressure processes are commonly used: full cell, modified full cell, and empty cell.

Full Cell

The full-cell (Bethel) process is used when the retention of a maximum quantity of preservative is desired. It is a

standard procedure for timbers to be treated with creosote when protection against marine borers is required. Waterborne preservatives may be applied by the full-cell process if uniformity of penetration and retention is the primary concern. With waterborne preservatives, control over preservative retention is obtained by regulating the concentration of the treating solution.

Steps in the full-cell process are essentially the following:

1. The charge of wood is sealed in the treating cylinder, and a preliminary vacuum is applied for a half-hour or more to remove the air from the cylinder and as much as possible from the wood.
2. The preservative, at ambient or elevated temperature depending on the system, is admitted to the cylinder without breaking the vacuum.
3. After the cylinder is filled, pressure is applied until the wood will take no more preservative or until the required retention of preservative is obtained.
4. When the pressure period is completed, the preservative is withdrawn from the cylinder.
5. A short final vacuum may be applied to free the charge from dripping preservative.

When the wood is steamed before treatment, the preservative is admitted at the end of the vacuum period that follows steaming. When the timber has received preliminary conditioning by the Boulton or boiling-under-vacuum process, the cylinder can be filled and the pressure applied as soon as the conditioning period is completed.

Modified Full Cell

The modified full-cell process is basically the same as the full-cell process except for the amount of initial vacuum and the occasional use of an extended final vacuum. The modified full-cell process uses lower levels of initial vacuum; the actual amount is determined by the wood species, material size, and final retention desired. The modified full-cell process is commonly used for treatment of lumber with waterborne preservatives.

Empty Cell

The objective of the empty-cell process is to obtain deep penetration with a relatively low net retention of preservative. For treatment with oil preservatives, the empty-cell process should always be used if it will provide the desired retention. Two empty-cell processes, the Rueping and the Lowry, are commonly employed; both use the expansive force of compressed air to drive out part of the preservative absorbed during the pressure period.

The Rueping empty-cell process, often called the empty-cell process with initial air, has been widely used for many years in Europe and the United States. The following general procedure is employed:

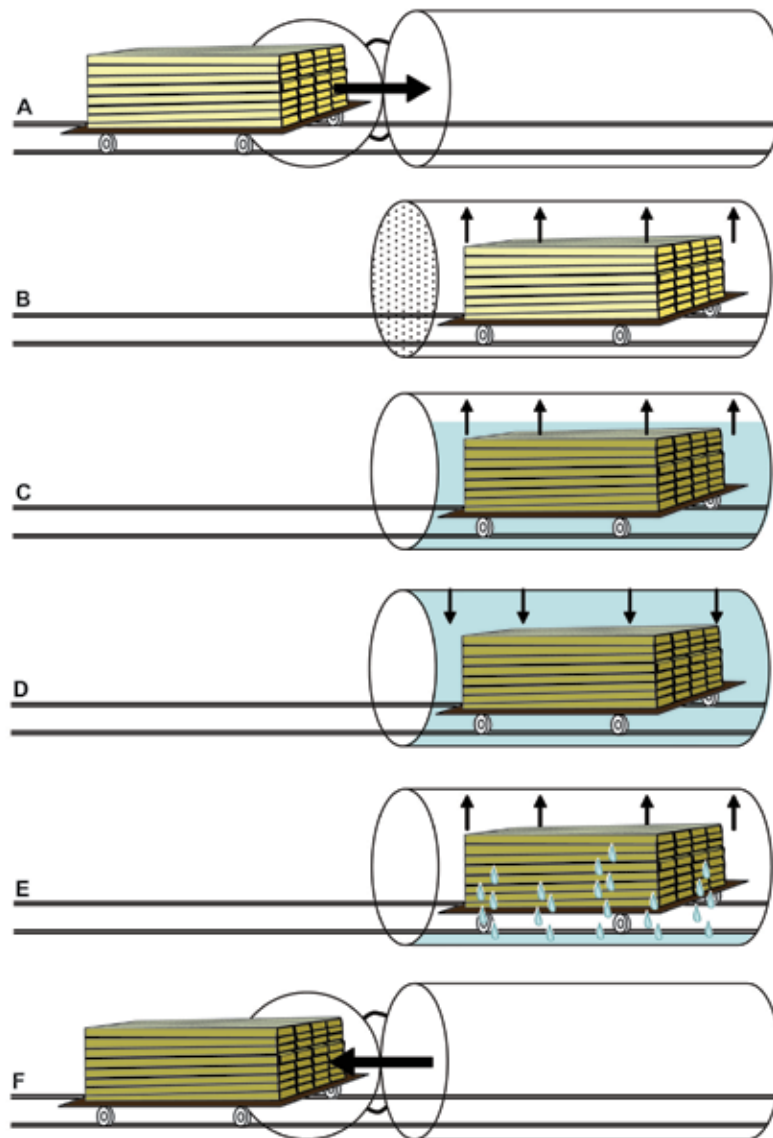

Figure 15-5. Typical steps in pressure treating process: A, untreated wood is placed in cylinder; B, a vacuum is applied to pull air out of the wood; C, the wood is immersed in solution while still under vacuum; D, pressure is applied to force the preservative into the wood; E, preservative is pumped out, and a final vacuum is pulled to remove excess preservative; F, excess preservative is pumped away, and the wood is removed from the cylinder.

1. Air under pressure is forced into the treating cylinder, which contains the charge of wood. The air penetrates some species easily, requiring but a few minutes application of pressure. In treating the more resistant species, common practice is to maintain air pressure from 1/2 to 1 h before admitting the preservative, but the necessity for lengthy air-pressure periods does not seem fully established. The air pressures employed generally range from 172 to 689 kPa (25 to 100 lb in⁻²), depending on the net retention of preservative desired and the resistance of the wood.
2. After the period of preliminary air pressure, preservative is forced into the cylinder. As the preservative is pumped in, the air escapes from the treating cylinder into an equalizing or Rueping tank, at a rate that keeps the pressure constant within the cylinder. When the treating cylinder is filled with preservative, the treating pressure is increased above that of the initial air and is maintained until the wood will absorb no more preservative, or until enough has been absorbed to leave the required retention of preservative in the wood after the treatment.

- At the end of the pressure period, the preservative is drained from the cylinder, and surplus preservative is removed from the wood with a final vacuum. The amount of preservative recovered can be from 20% to 60% of the gross amount injected.

The Lowry is often called the empty-cell process without initial air pressure. Preservative is admitted to the cylinder without either an initial air pressure or a vacuum, and the air originally in the wood at atmospheric pressure is imprisoned during the filling period. After the cylinder is filled with the preservative, pressure is applied, and the remainder of the treatment is the same as described for the Rueping treatment.

The Lowry process has the advantage that equipment for the full-cell process can be used without other accessories that the Rueping process usually requires, such as an air compressor, an extra cylinder or Rueping tank for the preservative, or a suitable pump to force the preservative into the cylinder against the air pressure. However, both processes have advantages and are widely and successfully used.

With poles and other products where bleeding of preservative oil is objectionable, the empty-cell process is followed by either heating in the preservative (expansion bath) at a maximum of 104 °C (220 °F) or a final steaming for a specified time limit at a maximum of 116 °C (240 °F) prior to the final vacuum.

Treating Pressures and Preservative Temperatures

The pressures used in treatments vary from about 345 to 1,723 kPa (50 to 250 lb in⁻²), depending on the species and the ease with which the wood takes the treatment. Most commonly, pressures range from about 862 to 1,207 kPa (125 to 175 lb in⁻²). Many woods are sensitive to high treating pressures, especially when hot. For example, AWPA standards permit a maximum pressure of 1,050 kPa (150 lb in⁻²) in the treatment of redwood, eastern hemlock, and eastern white pine, while the limitation for oak is 1,723 kPa (250 lb in⁻²).

AWPA T1 standard requires that the temperature of creosote and creosote solutions, as well as that of the oil-type preservatives, during the pressure period not be greater than 100 °C (212 °F). For the waterborne preservatives that contain chromium (ACC and CCA), the maximum solution temperature is limited to 50 °C (120 °F) to avoid premature precipitation of the preservative. For most other waterborne preservatives, the maximum solution temperature is 65 °C (150 °F), although a higher limit 93 °C (200 °F) is permitted for inorganic boron solutions.

Effect on Mechanical Properties

Coal-tar creosote, creosote solutions, and pentachlorophenol dissolved in petroleum oils are practically inert to wood and have no chemical influence that would affect its strength.

Chemicals commonly used in waterborne salt preservatives, including chromium, copper, arsenic, and ammonia, are reactive with wood. Thus, these chemicals are potentially damaging to mechanical properties and may also promote corrosion of mechanical fasteners.

Significant reductions in mechanical properties may be observed if the treating and subsequent drying processes are not controlled within acceptable limits. Factors that influence the effect of the treating process on strength include (a) species of wood, (b) size and moisture content of the timbers treated, (c) type and temperature of heating medium, (d) length of the heating period in conditioning the wood for treatment and time the wood is in the hot preservative, (e) post-treatment drying temperatures, and (f) amount of pressure used. Most important of those factors are the severity and duration of the in-retort heating or post-treatment redrying conditions used. The effect of wood preservatives on the mechanical properties of wood is covered in Chapter 5.

Nonpressure Processes

The numerous nonpressure processes differ widely in the penetration and retention levels of preservative attained, and consequently in the degree of protection they provide to the treated wood. When similar retention and penetration levels are achieved, wood treated by a nonpressure method should have a service life comparable to that of wood treated by pressure. Nevertheless, results of nonpressure treatments, particularly those involving surface applications, are not generally as satisfactory as those of pressure treatment. The superficial processes do serve a useful purpose when more thorough treatments are impractical or exposure conditions are such that little preservative protection is required.

Nonpressure methods, in general, consist of (a) surface application of preservatives by brief dipping, (b) soaking in preservative oils or steeping in solutions of waterborne preservatives, (c) diffusion processes with waterborne preservatives, (d) vacuum treatment, and (e) a variety of miscellaneous processes.

Brief Dipping

It is a common practice to treat window sash, frames, and other millwork, either before or after assembly, by dipping the item in a water-repellent preservative.

In some cases, preservative oil penetrates the end surfaces of ponderosa pine sapwood as much as 25 to 76 mm (1 to 3 in.). However, end penetration in such woods as the heartwood of southern pines and Douglas-fir is much less. Transverse penetration of the preservative applied by brief dipping is very shallow, usually less than a millimeter (a few hundredths of an inch). The exposed end surfaces at joints are the most vulnerable to decay in millwork products; therefore, good end penetration is especially advantageous. Dip applications provide very limited protection to wood

used in contact with the ground or under very moist conditions, and they provide very limited protection against attack by termites. However, they do have value for exterior woodwork and millwork that is painted, not in contact with the ground, and exposed to moisture only for brief periods.

Cold Soaking and Steeping

The methods of cold soaking well-seasoned wood for several hours or days in low-viscosity preservative oils or steeping green or seasoned wood for several days in waterborne preservatives have provided a range of success on fence posts, lumber, and timbers.

Pine posts treated by cold soaking for 24 to 48 h or longer in a solution containing 5% of pentachlorophenol in No. 2 fuel oil have shown an average life of 16 to 20 years or longer. The sapwood in these posts was well penetrated, and preservative solution retention levels ranged from 32 to 96 kg m⁻³ (2 to 6 lb in⁻³). Most species do not treat as satisfactorily as do the pines by cold soaking, and test posts of such woods as birch, aspen, and sweetgum treated by this method have failed in much shorter times.

Preservative penetration and retention levels obtained by cold soaking lumber for several hours are considerably better than those obtained by brief dipping of similar species. However, preservative retention levels seldom equal those obtained in pressure treatment except in cases such as sapwood of pines that has become highly absorptive through mold and stain infection.

Steeping with waterborne preservatives has very limited use in the United States but it has been used for many years in Europe. In treating seasoned wood, both the water and the preservative salt in the solution soak into the wood. With green wood, the preservative enters the water-saturated wood by diffusion. Preservative retention and penetration levels vary over a wide range, and the process is not generally recommended when more reliable treatments are practical.

Diffusion Processes

In addition to the steeping process, diffusion processes are used with green or wet wood. These processes employ waterborne preservatives that will diffuse out of the water of the treating solution or paste into the water of the wood.

The double-diffusion process developed by the Forest Products Laboratory has shown very good results in fence post tests and standard 38- by 89-mm (nominal 2- by 4-in.) stake tests, particularly for full-length immersion treatments. This process consists of steeping green or partially seasoned wood first in one chemical solution, then in another. The two chemicals then react in the wood to form a precipitate with low solubility. However, the preservatives evaluated in this process do not currently have EPA registration for use in nonpressure treatments.

Vacuum Process

The vacuum process, or “VAC-VAC” as referred to in Europe, has been used to treat millwork with water-repellent preservatives and construction lumber with waterborne and water-repellent preservatives.

In treating millwork, the objective is to use a limited quantity of water-repellent preservative and obtain retention and penetration levels similar to those obtained by dipping for 3 min. In this treatment, a quick, low initial vacuum is followed by filling the cylinder under vacuum, releasing the vacuum and soaking, followed by a final vacuum. This treatment provides better penetration and retention than the 3-min dip treatment, and the surface of the wood is quickly dried, thus expediting glazing, priming, and painting. The vacuum treatment is also reported to be less likely than dip treatment to leave objectionably high retention levels in bacteria-infected wood referred to as “sinker stock.”

Lumber intended for buildings has been treated by the vacuum process, either with a waterborne preservative or a water-repellent/preservative solution, with preservative retention levels usually less than those required for pressure treatment. The process differs from that used in treating millwork in employing a higher initial vacuum and a longer immersion or soaking period.

In a study by the Forest Products Laboratory, an initial vacuum of -93 kPa (27.5 inHg) was applied for 30 min, followed by a soaking for 8 h, and a final or recovery vacuum of -93 kPa (27.5 inHg) for 2 h. Results of the study showed good penetration of preservative in the sapwood of dry lumber of easily penetrated species such as the pines. However, in heartwood and unseasoned sapwood of pine and heartwood of seasoned and unseasoned coastal Douglas-fir, penetration was much less than that obtained by pressure treatment. Preservative retention was less controllable in vacuum than in empty-cell pressure treatment. Good control over retention levels is possible in vacuum treatment with a waterborne preservative by adjusting concentration of the treating solution.

Miscellaneous Nonpressure Processes

Several other nonpressure methods of various types have been used to a limited extent. Many of these involve the application of waterborne preservatives to living trees. The Boucherie process for the treatment of green, unpeeled poles has been used for many years in Europe. This process involves attaching liquid-tight caps to the butt ends of the poles. Then, through a pipeline or hose leading to the cap, a waterborne preservative is forced under hydrostatic pressure into the pole.

A tire-tube process is a simple adaptation of the Boucherie process used for treating green, unpeeled fence posts. In this treatment, a section of used inner tube is fastened tight around the butt end of the post to make a bag that holds a

solution of waterborne preservative. There are now limitations for application of these processes because of the potential loss of preservative to the soil around the treatment site.

In-Place and Remedial Treatments

In-place treatments may be beneficial both during construction and as part of an inspection and maintenance program. Although cutting or drilling pressure-treated wood during construction is undesirable, it cannot always be avoided. When cutting is necessary, the damage can be partly overcome by a thorough application of copper naphthenate (1% to 2% copper) to the cut surface. This provides a protective coating of preservative on the surface that may slowly migrate into the end grain of the wood. The exposed end-grain in joints, which is more susceptible to moisture absorption, and the immediate area around all fasteners, including drill holes, will require supplemental on-site treatment. A special device is available for pressure-treating bolt holes that are bored after treatment. For treating the end surfaces of piles where they are cut off after driving, at least two generous coats of copper naphthenate should be applied. A coat of asphalt or similar material may be thoroughly applied over the copper naphthenate, followed by some protective sheet material, such as metal, roofing felt, or saturated fabric, fitted over the pile head and brought down the sides far enough to protect against damage to the treatment and against the entrance of storm water. AWPA Standard M4 contains instructions for the care of pressure-treated wood after treatment.

Surface Applications

The simplest treatment is to apply the preservative to the wood with a brush or by spraying. Preservatives that are thoroughly liquid when cold should be selected, unless it is possible to heat the preservative. When practical, the preservative should be flooded over the wood rather than merely painted. Every check and depression in the wood should be thoroughly filled with the preservative, because any untreated wood left exposed provides ready access for fungi. Rough lumber may require as much as 40 L of preservative per 100 m² (10 gallons per 1,000 ft²) of surface, but surfaced lumber requires considerably less. The transverse penetration obtained will usually be less than 2.5 mm (0.1 in.), although in easily penetrated species, end-grain (longitudinal) penetration is considerably greater. The additional life obtained by such treatments over that of untreated wood will be affected greatly by the conditions of service. For wood in contact with the ground, service life may be from 1 to 5 years.

For brush or spray applications, copper naphthenate in oil is the preservative that is most often used. The solution should contain 1% to 2% elemental copper. Copper naphthenate is available as a concentrate or in a ready-to-use solution in gallon and drum containers. Borate solutions can also be sprayed or brushed into checks or splits. However, because they are not fixed to the wood they can be leached during

subsequent precipitation. Borates are sold either as concentrated liquids (typically formulated with glycol) or as powders that can be diluted with water.

Another type of surface treatment is the application of water-soluble pastes containing combinations of copper naphthenate, copper quinolinolate, copper hydroxide, or borates. The theory with these treatments is that the diffusible components (such as boron) will move through the wood, while the copper component remains near the surface of a void or check. These pastes are most commonly used to help protect the ground-line area of poles. After the paste is applied, it is covered with a wrap to hold the paste against the pole and prevent loss into the soil. In bridge piles this type of paste application should be limited to terrestrial piles that will not be continually or frequently exposed to standing water. These pastes may also be effective if used under cap beams or covers to protect exposed end-grain. Reapplication schedules will vary based on the manufacturers recommendations as well as the method and area of application.

Internal Diffusible Treatments

Surface-applied treatments often do not penetrate deeply enough to protect the inner portions of large wooden members. An alternative to surface-applied treatments is installation of internal diffusible chemicals. These diffusible treatments are available in liquid, solid, or paste form and are applied into treatment holes that are drilled deeply into the wood. They are similar (and in some cases identical) to the surface-applied treatments or pastes. Boron is the most common active ingredient, but fluoride and copper have also been used. In timbers, deep holes are drilled perpendicular to the upper face on either side of checks. In round piles, steeply sloping holes are drilled across the grain to maximize the chemical diffusion and minimize the number of holes needed. The treatment holes are plugged with tight fitting treated wooden plugs or removable plastic plugs. Plugs with grease fittings are also available so that the paste can be reapplied without removing the plug.

Solid rod treatments have advantages in environmentally sensitive areas or in applications where the treatment hole can only be drilled at an upward angle. However, the chemical may not diffuse as rapidly or for as great a distance as compared to a liquid form. Solid forms may be less mobile because diffusible treatments require moisture to move through wood. Concentrated liquid borates may also be poured into treatment holes and are sometimes used in conjunction with the rods to provide an initial supply of moisture. When the moisture content falls below 20%, little chemical movement occurs, but fortunately growth of decay fungi is substantially arrested below 30% moisture. Because there is some risk that rods installed in a dry section of a timber would not diffuse to an adjacent wet section, some experience in proper placement of the treatment holes is necessary. The diffusible treatments do not move as far in the wood as do fumigants, and thus the treatment holes must

be spaced more closely. A study of borate diffusion in timbers of several wood species reported that diffusion along the grain was generally less than 12 cm (5 in.), and diffusion across the grain was typically less than 5 cm (2 in.).

Internal Fumigant Treatments

As with diffusibles, fumigants are applied in liquid or solid form in predrilled holes. However, they then volatilize into a gas that moves through the wood. To be most effective, a fumigant should be applied at locations where it will not readily volatilize out of the wood to the atmosphere. When fumigants are applied, the timbers should be inspected thoroughly to determine an optimal drilling pattern that avoids metal fasteners, seasoning checks, and severely rotted wood. In vertical members such as piles, holes to receive liquid fumigant should be drilled at a steep angle (45° to 60°) downward toward the center of the member, avoiding seasoning checks. The holes should be no more than 1.2 m (4 ft) apart and arranged in a spiral pattern. With horizontal timbers, the holes can be drilled straight down or slanted. As a rule, the holes should be extended to within about 5 cm (2 in.) of the bottom of the timber. If strength is not jeopardized, holes can be drilled in a cluster or in pairs to accommodate the required amount of preservative. If large seasoning checks are present, the holes should be drilled on each side of the member to provide better distribution. As soon as the fumigant is injected, the hole should be plugged with a tight-fitting treated wood dowel or removable plastic plug. For liquid fumigants, sufficient room must remain in the treating hole so the plug can be driven without displacing the chemical out of the hole. The amount of fumigant needed and the size and number of treating holes required depends upon the timber size. Fumigants will eventually diffuse out of the wood, allowing decay fungi to recolonize. Fortunately, additional fumigant can be applied to the same treatment hole. Fumigant treatments are generally more toxic and more difficult to handle than are diffusible treatments. Some are classified as restricted-use pesticides by the U.S. EPA.

One of the oldest and most effective fumigants is chloropicrin (trichloronitromethane). Chloropicrin is a liquid and has been found to remain in wood for up to 20 years; however, a 10-year retreatment cycle is recommended, with regular inspection. Chloropicrin is a strong eye irritant and has high volatility. Due to chloropicrin's hazardous nature, it should be used in areas away from buildings permanently inhabited by humans or animals. During application, workers must wear protective gear, including a full face respirator. Methylisothiocyanate (MITC) is the active ingredient in several fumigants, but is also available in a solid-melt form that is 97% active. The solid-melt MITC is supplied in aluminum tubes. After the treatment hole is drilled the cap is removed from the tube, and the entire tube is placed into the whole. This formulation provides ease of handling and application to upward drilled sloping treatment holes. Metham sodium (sodium N-methyldithiocarbamate) is a widely used

liquid fumigant that decomposes in the wood to form the active ingredient MITC. Granular dazomet (tetrahydro-3,5-dimethyl-2-H-1,3,5, thiazidine-6-thione) is applied in a solid granular form that decomposes to a MITC content of approximately 45%. Dazomet is easy to handle but slower to decompose and release MITC than the solid-melt MITC or liquid fumigants. Some suppliers recommend the addition of a catalyst such as copper naphthenate to accelerate the breakdown process.

Best Management Practices

The active ingredients of various waterborne wood preservatives (copper, chromium, arsenic, and zinc) are water soluble in the treating solution but resist leaching when placed into the wood. This resistance to leaching is a result of chemical stabilization (or fixation) reactions that render the toxic ingredients insoluble in water. The mechanism and requirements for the stabilization reactions differ, depending on the type of wood preservative.

For each type of preservative, some reactions occur very rapidly during pressure treatment, while others may take days or even weeks, depending on storage and processing after treatment. If the treated wood is placed in service before these fixation reactions have been completed, the initial release of preservative into the environment may be much greater than if the wood has been conditioned properly.

With oil-type preservatives, preservative bleeding or oozing out of the treated wood is a particular concern. This problem may be apparent immediately after treatment. Such members should not be used in bridges over water or other aquatic applications. In other cases, the problem may not become obvious until after the product has been exposed to heating by direct sunlight. This problem can be minimized by using treatment practices that remove excess preservative from the wood.

Best management practice (BMP) standards have been developed to ensure that treated wood is produced in a way that will minimize environmental concerns. The Western Wood Preservers Institute (WWPI) has developed guidelines for treated wood used in aquatic environments. Although these practices have not yet been adopted by the industry in all areas of the United States, purchasers can require that these practices be followed. Commercial wood treatment firms are responsible for meeting conditions that ensure stabilization and minimize bleeding of preservatives, but persons buying treated wood should make sure that the firms have done so.

Consumers can take steps to ensure that wood will be treated according to the BMPs. Proper stabilization may take time, and material should be ordered well before it is needed so that the treater can hold the wood while it stabilizes. If consumers order wood in advance, they may also be able to store it under cover, allowing further drying and fixation. In general, allowing the material to air dry before it is used is

a good practice for ensuring fixation, minimizing leaching, and reducing risk to construction personnel. With all preservatives, the wood should be inspected for surface residue, and wood with excessive residue should not be placed in service.

CCA

The risk of chemical exposure from wood treated with CCA is minimized after chemical fixation reactions lock the chemical in the wood. The treating solution contains hexavalent chromium, but the chromium reduces to the less toxic trivalent state within the wood. This process of chromium reduction also is critical in fixing the arsenic and copper in the wood. Wood treated with CCA should not be immersed or exposed to prolonged wetting until the fixation process is complete or nearly complete. The rate of fixation depends on temperature, taking only a few hours at 66 °C (150 °F) but weeks or even months at temperatures below 16 °C (60 °F). Some treatment facilities use kilns, steam, or hot-water baths to accelerate fixation.

The BMP guideline for CCA stipulates that the wood should be air seasoned, kiln dried, steamed, or subjected to a hot-water bath after treatment. It can be evaluated with the AWPA chromotropic acid test to determine whether fixation is complete.

ACZA and ACQ–B

The key to achieving stabilization with ACZA and ACQ–B is to allow ammonia to volatilize. This can be accomplished by air or kiln drying. The BMPs require a minimum of 3 weeks of air drying at temperatures higher than 16 °C (60 °F). Drying time can be reduced to 1 week if the material is conditioned in the treatment cylinder. At lower temperatures, kiln drying or heat is required to complete fixation. There is no commonly used method to determine the degree of stabilization in wood treated with ACZA or ACQ–B, although wood that has been thoroughly dried is acceptable. If the wood has a strong ammonia odor, fixation is not complete.

ACQ–C, ACQ–D, and Copper Azole

Proper handling and conditioning of the wood after treatment helps minimize leaching and potential environmental impacts for these preservatives. Amine (and ammonia in some cases) keeps copper soluble in these treatment solutions. The mechanism of copper's reaction in the wood is not completely understood but appears to be strongly influenced by time, temperature, and retention levels. As a general rule, wood that has been thoroughly dried after treatment is properly stabilized.

Copper stabilization in the copper azole CA–B formulation is extremely rapid (within 24 h) at the UC3B retention of 1.7 kg m⁻³ (0.10 lb ft⁻³) but slows considerably at higher retentions unless the material is heated to accelerate fixation.

Pentachlorophenol, Creosote, and Copper Naphthenate

For creosote, the BMPs stipulate use of an expansion bath and final steaming period at the end of the charge.

Expansion Bath—Following the pressure period, the creosote should be heated to a temperature 6 to 12 °C (10 to 20 °F) above the press temperatures for at least 1 h. Creosote should be pumped back to storage and a minimum gauge vacuum of –81 kPa (24 inHg) should be applied for at least 2 h.

Steaming—After the pressure period and once the creosote has been pumped back to the storage tank, a vacuum of not less than –74 kPa (22 inHg) is applied for at least 2 h to recover excess preservative. The vacuum is then released back to atmospheric pressure and the charge is steamed for 2 to 3 h. The maximum temperature during this process should not exceed 116 °C (240 °F). A second vacuum of not less than –74 kPa (22 inHg) is then applied for a minimum of 4 h.

The BMPs for copper naphthenate are similar to those for creosote and pentachlorophenol. The recommended treatment practices for treatment in heavy oil include using an expansion bath, or final steaming, or both, similar to that described for creosote. When No. 2 fuel oil is used as the solvent, the BMPs recommend using a final vacuum for at least 1 h.

Handling and Seasoning of Timber after Treatment

Treated timber should be handled with sufficient care to avoid breaking through the treated shell. The use of pikes, cant hooks, picks, tongs, or other pointed tools that dig deeply into the wood should be prohibited. Handling heavy loads of lumber or sawn timber in rope or cable slings can crush the corners or edges of the outside pieces. Breakage or deep abrasions can also result from throwing or dropping the lumber. If damage results, the exposed areas should be retreated, if possible.

Wood treated with preservative oils should generally be installed as soon as practicable after treatment to minimize lateral movement of the preservative, but sometimes cleanliness of the surface can be improved by exposing the treated wood to the weather for a limited time before installation. Lengthy, unsheltered exterior storage of treated wood before installation should be avoided. Treated wood that must be stored before use should be covered for protection from the sun and weather.

With waterborne preservatives, seasoning after treatment is important for wood that will be used in buildings or other places where shrinkage after placement in the structure would be undesirable. Injecting waterborne preservatives puts large amounts of water into the wood, and considerable shrinkage is to be expected as subsequent seasoning takes place. For best results, the wood should be dried to

approximately the moisture content it will ultimately reach in service. During drying, the wood should be carefully piled and, whenever possible, restrained by sufficient weight on the top of the pile to prevent warping.

Quality Assurance for Treated Wood

Treating Conditions and Specifications

Specifications on the treatment of various wood products by pressure processes have been developed by AWWA. These specifications limit pressures, temperatures, and time of conditioning and treatment to avoid conditions that will cause serious injury to the wood. The specifications also contain minimum requirements for preservative penetration and retention levels and recommendations for handling wood after treatment to provide a quality product. Specifications are broad in some respects, allowing the purchaser some latitude in specifying the details of individual requirements. However, the purchaser should exercise great care so as not to hinder the treating plant operator from doing a good treating job and not to require treating conditions so severe that they will damage the wood.

Penetration and Retention

Penetration and retention requirements are equally important in determining the quality of preservative treatment. Penetration levels vary widely, even in pressure-treated material. In most species, heartwood is more difficult to penetrate than sapwood. In addition, species differ greatly in the degree to which their heartwood may be penetrated. Incising tends to improve penetration of preservative in many refractory species, but those highly resistant to penetration will not have deep or uniform penetration even when incised. Penetration in unincised heartwood faces of these species may occasionally be as deep as 6 mm (1/4 in.) but is often not more than 1.6 mm (1/16 in.).

Experience has shown that even slight penetration has some value, although deeper penetration is highly desirable to avoid exposing untreated wood when checks occur, particularly for important members that are costly to replace. The heartwood of coastal Douglas-fir, southern pines, and various hardwoods, although resistant, will frequently show transverse penetrations of 6 to 12 mm (1/4 to 1/2 in.) and sometimes considerably more.

Complete penetration of the sapwood should be the goal in all pressure treatments. It can often be accomplished in small-size timbers of various commercial woods, and with skillful treatment, it may often be obtained in piles, ties, and structural timbers. Practically, however, the operator cannot always ensure complete penetration of sapwood in every piece when treating large pieces of round material with thick sapwood (such as poles and piles). Therefore, specifications permit some tolerance. For instance, AWWA Processing and Treatment Standard T1 for Southern Pine poles requires that 89 mm (3.5 in.) or 90% of the sapwood thickness be

penetrated for waterborne preservatives. The requirements vary, depending on the species, size, class, and specified retention levels.

Preservative retentions are typically expressed on the basis of the mass of preservative per unit volume of wood within a prescribed assay zone. The retention calculation is not based on the volume of the entire pole or piece of lumber. For example, the assay zone for Southern Pine poles is between 13 and 51 mm (0.5 and 2.0 in.) from the surface. To determine the retention, a boring is removed from the assay zone and analyzed for preservative concentration. The preservatives and retention levels listed in the AWWA Commodity Standards and ICC-ES evaluation reports are shown in Table 15-1. The current issues of these specifications should be referenced for up-to-date recommendations and other details. In many cases, the retention level is different depending on species and assay zone. Higher preservative retention levels are specified for products to be installed under severe climatic or exposure conditions. Heavy-duty transmission poles and items with a high replacement cost, such as structural timbers and house foundations, are required to be treated to higher retention levels. Correspondingly, deeper penetration or heartwood limitations are also necessary for the same reasons. It may be necessary to increase retention levels to ensure satisfactory penetration, particularly when the sapwood is either unusually thick or is somewhat resistant to treatment. To reduce bleeding of the preservative, however, it may be desirable to use preservative-oil retention levels less than the stipulated minimum. Older specifications based on treatment to refusal do not ensure adequate penetration or retention of preservative, should be avoided, and must not be considered as a substitute for results-type specification in treatment.

Inspection of Treatment Quality

AWWA standards specify how charges of treated wood should be inspected to ensure conformance to treatment standards. Inspections are conducted by the treating company and also should be routinely conducted by independent third-party inspection agencies. These third-party agencies verify for customers that the wood was properly treated in accordance with AWWA standards. The U.S. Department of Commerce American Lumber Standard Committee (ALSC) accredits third-party inspection agencies for treated-wood products. Quality control overview by ALSC-accredited agencies is preferable to simple treating plant certificates or other claims of conformance made by the producer without inspection by an independent agency. Updated lists of accredited agencies can be obtained from the ALSC website at www.alsc.org. Each piece of treated wood should be marked with brand, ink stamp, or end-tag that shows the logo of an accredited inspection agency and other information required by AWWA standards (Fig. 15-6). Other important information that should be shown includes the type of preservative, preservative retention, and the intended use category

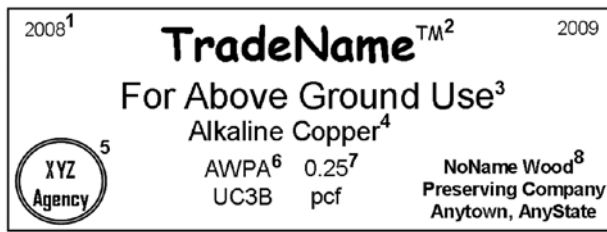

- ¹ Year(s) of treatment
² Tradename of preservative treatment
³ Intended end-use
⁴ Standard name of preservative
⁵ Third party inspection agency
⁶ AWPA Use Category
⁷ Retention of Preservative in wood
⁸ Treating company

Figure 15–6. Typical end tag for preservative-treated lumber conforming to the ALSC accreditation program.

(exposure condition). Purchasers may also elect to have an independent inspector inspect and analyze treated products to ensure compliance with the specifications—recommended for treated-wood products used for critical structures. Railroad companies, utilities, and other entities that purchase large quantities of treated timber usually maintain their own inspection services.

Effects on the Environment

Preservatives intended for use outdoors have mechanisms that are intended to keep the active ingredients in the wood and minimize leaching. Past studies indicate that a small percentage of the active ingredients of all types of wood preservatives leach out of the wood. The amount of leaching depends on factors such as fixation conditions, preservative retention in the wood, product size and shape, type of exposure, and years in service. Ingredients in all preservatives are potentially toxic to a variety of organisms at high concentrations, but laboratory studies indicate that the levels of preservatives leached from treated wood generally are too low to create a biological hazard.

In recent years, several studies have been conducted on preservative releases from structures and on the environmental consequences of those releases. These recent studies of the environmental impact of treated wood reveal several key points. All types of treated wood evaluated release small amounts of preservative components into the environment. These components can sometimes be detected in soil or sediment samples. Shortly after construction, elevated levels of preservative components can sometimes be detected in the water column. Detectable increases in soil and sediment concentrations of preservative components generally are limited to areas close to the structure. Leached preservative components either have low water solubility or react with components of the soil or sediment, limiting their

mobility and limiting the range of environmental contamination. Levels of these components in the soil immediately adjacent to treated structures can increase gradually over the years, whereas levels in sediments tended to decline over time. Research indicates that environmental releases from treated wood do not cause measurable impacts on the abundance or diversity of aquatic invertebrates adjacent to the structures. In most cases, levels of preservative components were below concentrations that might be expected to affect aquatic life. Samples with elevated levels of preservative components tended to be limited to fine sediments beneath stagnant or slow-moving water where the invertebrate community is not particularly intolerant to pollutants.

Conditions with a high potential for leaching and a high potential for metals to accumulate are the most likely to affect the environment (Fig. 15–7). These conditions are most likely to be found in boggy or marshy areas with little water exchange. Water at these sites has low pH and high organic acid content, increasing the likelihood that preservatives will be leached from the wood. In addition, the stagnant water prevents dispersal of any leached components of preservatives, allowing them to accumulate in soil, sediments, and organisms near the treated wood. Note that all construction materials, including alternatives to treated wood, have some type of environmental impact. In addition to environmental releases from leaching and maintenance activities, the alternatives may have greater impacts and require greater energy consumption during production.

Recycling and Disposal of Treated Wood

Treated wood is not listed as a hazardous waste under Federal law, and it can be disposed of in any waste management facility authorized under State and local law to manage such material. State and local jurisdictions may have additional regulations that impact the use, reuse, and disposal of treated wood and treated-wood construction waste, and users should check with State and local authorities for any special regulations relating to treated wood. Treated wood must not be burned in open fires or in stoves, fireplaces, or residential boilers, because the smoke and ashes may contain toxic chemicals.

Treated wood from commercial and industrial uses (construction sites, for example) may be burned only in commercial or industrial incinerators or boilers in accordance with State and Federal regulations. Spent railroad ties treated with creosote and utility poles treated with pentachlorophenol can be burned in properly equipped facilities to generate electricity (cogeneration). As fuel costs and energy demands increase, disposal of treated wood in this manner becomes more attractive. Cogeneration poses more challenges for wood treated with heavy metals, and particularly for wood treated with arsenic. In addition to concerns with emissions, the concentration of metals in the ash requires further processing.



Figure 15–7. Wood preservative leaching, environmental mobility, and effects on aquatic insects were evaluated at this wetland boardwalk in western Oregon.

As with many materials, reuse of treated wood may be a viable alternative to disposal. In many situations treated wood removed from its original application retains sufficient durability and structural integrity to be reused in a similar application. Generally, regulatory agencies also recognize that treated wood can be reused in a manner that is consistent with its original intended end use.

The potential for recycling preservative-treated wood depends on several factors, including the type of preservative treatment and the original use. Researchers have demonstrated that wood treated with heavy metals can be chipped or flaked and reused to form durable panel products or wood–cement composites. However, this type of reuse has not yet gained commercial acceptance. Techniques for extraction and reuse of the metals from treated wood have also been proposed. These include acid extraction, fungal degradation, bacterial degradation, digestion, steam explosion, or some combination of these techniques. All these approaches show some potential, but none is currently economical. In most situations landfill disposal remains the least expensive option. For treated wood used in residential construction, one of the greatest obstacles is the lack of an efficient process for collecting and sorting treated wood. This is less of a problem for products such as railroad ties and utility poles.

References

AWPA. [Current edition]. Annual proceedings. (Reports of preservations and treatment committees containing information on new wood preservatives considered in the development of standards). Birmingham, AL: American Wood Protection Association.

AWPA. 2008. Book of standards. (Includes standards on preservatives, treatments, methods of analysis, and inspection.) Birmingham, AL: American Wood Protection Association.

Archer, K.; Lebow, S.T. 2006. Wood preservation. Second edition. Primary wood processing, principals and practice, Walker, J.C.F. ed. The Netherlands: Springer. 596 p.

Baechler, R.H.; Roth, H.G. 1964. The double-diffusion method of treating wood: a review of studies. *Forest Products Journal*. 14(4): 171–178.

Baechler, R.H.; Blew, J.O.; Roth, H.G. 1962. Studies on the assay of pressure-treated lumber. *Proceedings of American Wood Preservers' Association*. 58: 21–34.

Baechler, R.H.; Gjovik, L.R.; Roth, H.G. 1969. Assay zones for specifying preservative-treated Douglas-fir and Southern Pine timbers. *Proceedings of American Wood Preservers' Association*. 65: 114–123.

Baechler, R.H.; Gjovik, L.R.; Roth, H.G. 1970. Marine tests on combination-treated round and sawed specimens. *Proceedings of American Wood Preservers' Association*. 66: 249–257.

Barnes, M.H., ed. 2007. Wood protection 2006. Publication No. 7229. Madison, WI: Forest Products Society. 388 p.

Blew, J.O.; Davidson, H.L. 1971. Preservative retentions and penetration in the treatment of white fir. *Proceedings of American Wood Preservers' Association*. 67: 204–221.

Boone, R.S.; Gjovik, L.R.; Davidson, H.L. 1976. Treatment of sawn hardwood stock with double-diffusion and modified double-diffusion methods. Res. Pap. FPL–RP–265. Madison, WI: U.S. Department of Agriculture, Forest Service, Forest Products Laboratory.

Brooks, K.M. 2000. Assessment of the environmental effects associated with wooden bridges preserved with creosote, pentachlorophenol or chromated-copper-arsenate. Res. Pap. FPL–RP–587. Madison, WI: U.S. Department of Agriculture, Forest Service, Forest Products Laboratory. 100 p.

Cassens, D.L.; Johnson, B.R.; Feist, W.C.; De Groot, R.C. 1995. Selection and use of preservative-treated wood. Publication N. 7299. Madison, WI: Forest Products Society.

Crawford, D.M.; Woodward, B.M.; Hatfield, C.A. 2002. Comparison of wood preservative in stake tests. 2000 Progress Report. Res. Note FPL–RN–02. Madison, WI: U.S. Department of Agriculture, Forest Service, Forest Products Laboratory.

Eaton, R.A.; Hale, M.D.C. 1993. Wood: decay, pests and protection. New York, NY: Chapman & Hall.

Forest Products Laboratory. Environmental impact of preservative treated wood in a wetland boardwalk. Res. Pap. FPL–RP–582. Madison, WI: U.S. Department of Agriculture, Forest Service, Forest Products Laboratory. 126 p.

- Gaby, L.I.; Gjovik, L.R. 1984. Treating and drying composite lumber with waterborne preservatives: Part I. Short specimen testing. *Forest Products Journal*. 34(2): 23–26.
- Gjovik, L.R.; Baechler, R.H. 1970. Treated wood foundations for buildings. *Forest Products Journal*. 20(5): 45–48.
- Gjovik, L.R.; Davidson, H.L. 1975. Service records on treated and untreated posts. Res. Note FPL–068. Madison, WI: U.S. Department of Agriculture, Forest Service, Forest Products Laboratory.
- Gjovik, L.R.; Johnson, D.B.; Kozak, V.; [and others]. 1980. Biologic and economic assessment of pentachlorophenol, inorganic arsenicals, and creosote. Vol. I: Wood preservatives. Tech. Bull 1658–1. Washington, DC: U.S. Department of Agriculture, in cooperation with State Agricultural Experimental Stations, Cooperative Extension Service, other state agencies and the Environmental Protection Agency.
- Groenier, J.S.; Lebow, S. 2006. Preservative-treated wood and alternative products in the Forest Service. Tech. Rep. 0677–2809–MTDC. Missoula, MT: U.S. Department of Agriculture, Forest Service, Missoula Technology and Development Center. 44 p.
- Hunt, G.M.; Garratt, G.A. 1967. Wood preservation. Third edition. The American Forestry Series. New York, NY: McGraw–Hill.
- ICC–ES. Evaluation Reports, Section 06070–wood treatment. Whittler, CA: ICC Evaluation Service, Inc. www.icc-es.org.
- Johnson, B.R.; Gutzmer, D.I. 1990. Comparison of preservative treatments in marine exposure of small wood panels. Res. Note FPL–RN–0258. Madison, WI: U.S. Department of Agriculture, Forest Service, Forest Products Laboratory.
- Lebow, S. 1996. Leaching of wood preservative components and their mobility in the environment—summary of pertinent literature. Gen. Tech. Rep. FPL–GTR–93. Madison, WI: U.S. Department of Agriculture, Forest Service, Forest Products Laboratory.
- Lebow, S.T.; Foster, D.O. 2005. Environmental concentrations of copper, chromium and arsenic released from a chromated-copper-arsenate (CCA-C) treated wetland boardwalk. *Forest Products Journal*. 55(2): 62–70.
- MacLean, J.D. 1952. Preservation of wood by pressure methods. Agric. Handb. 40. Washington, DC: U.S. Department of Agriculture, Forest Service.
- NFPA. 1982. The all-weather wood foundation. NFPA Tech. Rep. 7. Washington, DC: National Forest Products Association.
- NFPA. 1982. All-weather wood foundation system, design fabrication installation manual. NFPA report. Washington DC: National Forest Products Association.
- Richardson, B.A. 1993. Wood preservation. Second edition. London: Chapman and Hall. 226 p.
- Schlultz, T.P.; Miltz, H.; Freeman, M.H.; Goodell, B.; Nicholas, D.D.; eds. 2008. Development of commercial wood preservatives. ACS Symposium Series 982. Washington, DC: American Chemical Society. 655 p.
- Western Wood Preservers Institute. 2006. Best management practices for the use of treated wood in aquatic environments. Vancouver, WA: Western Wood Preservers Institute. 34 p.
- Western Wood Preservers Institute. 2006. Treated wood in aquatic environments. Vancouver, WA: Western Wood Preservers Institute. 32 p.

Finishing of Wood

R. Sam Williams, Supervisory Research Chemist (Retired)

Contents

Factors Affecting Finish Performance	16–2
Wood Surface Properties	16–2
Wood Products	16–8
Weathering	16–11
Decay and Insects	16–13
Control of Water and Water Vapor	16–13
Compliance of VOC Finishes with Pollution Regulations	16–15
Exterior Wood Finishes	16–16
Weathered Wood as Natural Finish	16–16
Penetrating Wood Finishes	16–16
Film-Forming Finishes	16–21
Application of Finishes, Special Uses	16–24
Porches, Decks, Deck Railings, and Fences	16–24
Treated Wood	16–24
Marine Uses	16–24
Boats	16–25
Panel Products	16–25
Fire-Retardant Coatings	16–25
Back-Priming	16–25
Factory Finishing	16–25
Finish Failure or Discoloration	16–25
Paint Cracking (parallel to grain)	16–26
Peeling and Flaking	16–26
Cross-Grain Cracking	16–26
Water Blisters	16–26
Mill Glaze	16–26
Intercoat Peeling	16–27
Chalking	16–28
Mildew	16–28
Loss of Gloss and Fading	16–29
Water Soluble Extractives	16–29
Blue Stain	16–30
Iron Stain	16–30
Knots	16–31
Pitch	16–31
Finishing Interior Wood	16–32
Type of Finish and Wood Fillers	16–32
Finishes for Wood Floors	16–33
Finishes for Items Used for Food	16–34
Wood Cleaners and Brighteners	16–34
Paint Strippers	16–35
Mechanical Methods	16–35
Chemical Methods	16–36
Lead-Based Paint	16–36
Literature Cited	16–37
Additional References	16–37

Wood finishes (paint, varnish, and stain, for example) give a desired appearance, protect wood surfaces, and provide a cleanable surface. Many people consider *appearance* most important when choosing finishes for wood (lumber and wood composites). However, from a technical aspect, *protection* is most important for wood used outdoors, and providing a *cleanable surface* is most important for wood used indoors. When selecting a finish, one should consider appearance, protection, and cleanability and also how bulk and surface properties of wood affect finish application and performance (how long a finish lasts—its service life).

Wood properties such as density (specific gravity), growth rate, heartwood–sapwood, earlywood–latewood, grain angle, vessels, and texture vary within and across wood species. Wood composites, such as plywood, fiberboard, and oriented strandboard (OSB), have different properties. Of the 18,000 to 25,000 known wood species (exact number varies depending on the grouping of species), approximately 50 are commercial species used in the United States and Canada. Chapters 2–4 give their properties. Of these commercial species, researchers report finishing characteristics for only a few species common to North America, Europe, Japan, and the tropics. However, if one understands how wood properties, finish, and environmental conditions interact, it should be possible to estimate finish performance for most wood species.

Performance depends on choosing an appropriate finish for wood, considering the use conditions, and applying finishes correctly in sufficient amount. For long service life, choose wood products and finishes appropriate for environments where they are used. Indoor use places less stress on finishes than outdoor use. A climate having severe seasonal changes (U.S. Upper Midwest, for example) places greater stress on finishes than does a mild climate (such as the Pacific Northwest).

Guidelines in this chapter explain how to obtain long service life for contemporary finishes on lumber and wood composites used in the United States and Canada. The chapter begins with a review of wood properties important for wood finishing and describes effects of water and weathering on wood and finishes. This background establishes a basis for describing finishes for wood, their application, and common types of finish failures (and ways to avoid them). Publications listed at the end of this chapter provide additional information.

Factors Affecting Finish Performance

Wood surface properties, type of wood product, and weather affect finish performance.

Wood Surface Properties

Wood anatomy, manufacturing processes, moisture content (MC), dimensional change, extractives, and changes as wood ages determine wood surface properties.

Anatomy

Wood species (thus its anatomy) is the primary factor that determines surface properties of wood—properties that affect adhesion and performance of finishes. Wood anatomy determines whether a wood species is a hardwood or softwood, not the density (specific gravity) or its hardness. Finish performance is affected by

- density (overall density, earlywood (EW)–latewood (LW) density difference, and how abruptly density changes at the EW–LW boundary),
- thickness of LW bands,
- ray cells (number and placement),
- vessels (size and location),
- extractives content, and
- growth rate (some species grow faster than others, and environment affects growth rate within a specific species).

Most wood cells (called tracheids in softwoods, fibers in hardwoods) align parallel (axial) to the stem or branch. Softwood tracheids support the tree and transport water and nutrients. Hardwood fibers just support the tree; hardwoods have special cells (vessels) for transporting water and nutrients. Vessel cells are open at each end and stacked to form “pipes.” Axial tracheids and fibers are hollow tubes closed at each end. In softwoods, liquids move in the axial direction by flowing from one tracheid to another through openings called pits. Liquid transport between the bark and center of the stem or branch in hardwoods and softwoods is by ray cells. Figures 16–1 to 16–3 are micrographs showing the orientation of axial and ray cells for white spruce, red oak, and red maple, respectively. Note that the softwood (Fig. 16–1) has no vessels. The large openings are resin canal complexes (common to spruce, pine, larch, and Douglas-fir). Figure 16–2 shows red oak, a ring-porous hardwood. Large-diameter vessels in ring-porous species form along with EW; later in the growing season, the vessels have smaller diameters. Figure 16–3 shows red maple, a diffuse-porous hardwood; small vessels having similar size form throughout the EW and LW. Hardwoods can also be semi-ring porous.

Axial and ray cells form in the cambium, a layer of cells just under the bark. In the early part of the growing season

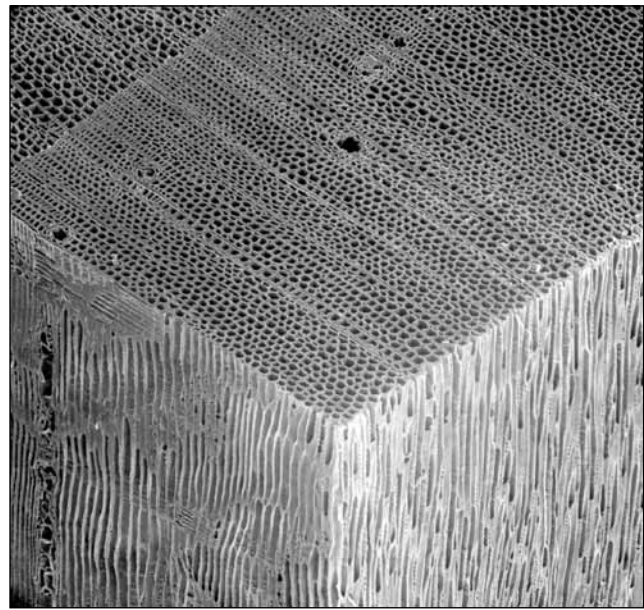

Figure 16–1. Micrograph of white spruce showing gradual transition of cell wall thickness and resin canal complexes. (Micrographs prepared by H.A. Core, W.A. Côté, and A.C. Day. Copyright by N.C. Brown Center for Ultrastructure Studies, College of Environmental Science and Forestry, State University of New York, Syracuse, New York. Used with permission.)

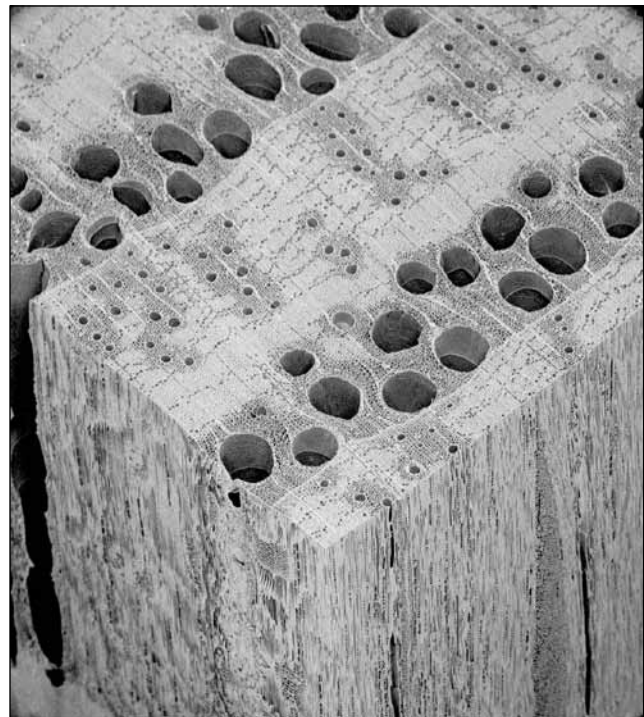

Figure 16–2. Micrograph of red oak showing ring-porous vessels. (Micrographs prepared by H.A. Core, W.A. Côté, and A.C. Day. Copyright by N.C. Brown Center for Ultrastructure Studies, College of Environmental Science and Forestry, State University of New York, Syracuse, New York. Used with permission.)

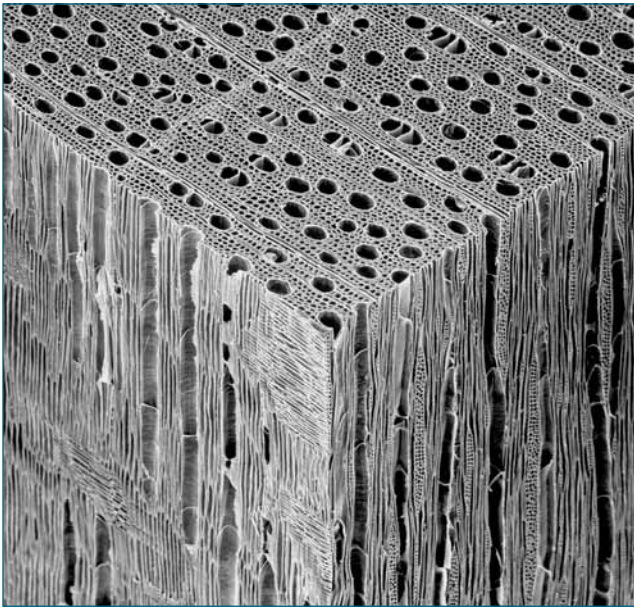

Figure 16–3. Micrograph of red maple showing diffuse-porous vessels. (Micrographs prepared by H.A. Core, W.A. Côté, and A.C. Day. Copyright by N.C. Brown Center for Ultrastructure Studies, College of Environmental Science and Forestry, State University of New York, Syracuse, New York. Used with permission.)

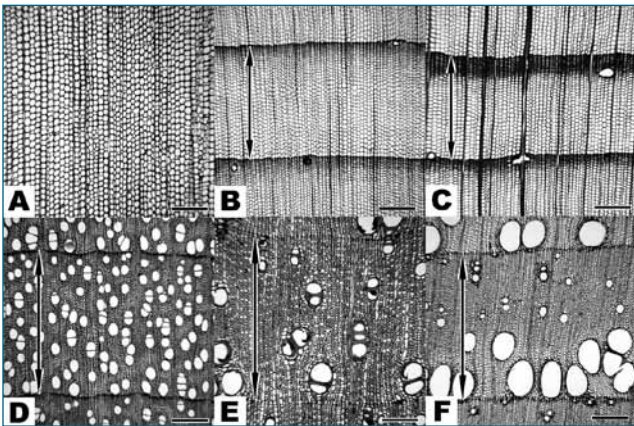

Figure 16–4. Cross-section micrographs of (A) a tropical softwood (*Podocarpus imbricate*), (B) white spruce (*Picea glauca*), (C) Douglas-fir, *Pseudotsuga menziesii* (D) sugar maple (*Acer saccharum*), (E) persimmon (*Diospyros virginiana*), and (F) white ash (*Fraxinus americana*). The arrows show a single growth year for the temperate species.

(temperate species), the cells have large open centers (lumens) and thin cell walls. This is earlywood (also called springwood). As the growing season progresses, cell walls become thicker, forming latewood (also called summerwood). The combination of EW–LW (and vessels in hardwoods) gives annual growth rings. The properties of these growth rings affect the ease with which finishes can be applied (paintability) and how long finishes last (service life).

Cross-section micrographs of three softwoods and hardwoods (Fig. 16–4) show three types of growth characteristics. Softwoods may show “no transition” (no EW–LW boundary, Fig. 16–4a), gradual transition (Fig. 16–4b), or abrupt transition (Fig. 16–4c). Note: the “no transition” softwood is a tropical species (that is, no seasons, therefore no EW–LW transition). Hardwoods may be diffuse porous (Fig. 16–4d), semi-ring porous (Fig. 16–4e), or ring porous (Fig. 16–4f). As a first approximation for explaining finishing characteristics of wood, the various wood species can be grouped into three categories:

- Easy to finish (“no transition” or gradual-transition softwoods and diffuse-porous hardwoods)
- Moderately easy to finish (abrupt-transition softwoods having narrow LW bands and semi-ring-porous hardwoods)
- Difficult to finish (abrupt-transition softwoods having wide LW bands and ring-porous hardwoods)

The important message from wood anatomy is to look at the wood. The six micrographs showing end-grain wood-cell structure do not include all possible combinations of growth rate, grain, and surface texture. When determining paintability, look at grain angles. Look at the width of the LW bands and the transition between them (Fig. 16–5). The blocks show radial and tangential surfaces (that is, vertical- and flat-grain surfaces for six softwoods and quarter-sawn and flat-sawn for two hardwoods). Note the abrupt transitions on the southern yellow pine and Douglas-fir and the gradual transitions on the western redcedar and white pine. Also, note the growth rate and width of the LW bands. Surfaces having abrupt transition, rapid growth rate, and wide LW bands are difficult to finish, particularly on flat-grain wood. Moisture-induced dimensional change increases as wood density increases. Changes are greater for LW than EW. Different dimensional change for abrupt-transition (or ring-porous) species at the EW–LW boundary places stress on coatings.

Shrinkage values given in Table 16–1 were obtained from drying wood from its green state (fiber saturation) to oven-dry (0% MC); swelling rates would be approximately the same. Some species have wide bands of EW and LW. These distinct bands often lead to early paint failure. Wide, prominent bands of LW are characteristic of the southern yellow pines, radiata pine, and Douglas-fir (Fig. 16–5a,b,c), and getting good paint performance is more difficult on these species. In contrast, white pine, redwood, and western redcedar (Fig. 16–5d,e,f) do not have wide LW bands, and these species give excellent paint performance. Diffuse-porous hardwoods such as aspen (Fig. 16–5g) have a fine surface texture and are easy to finish, whereas red oak (Fig. 16–5h) has a highly textured surface and requires surface preparation prior to finishing.

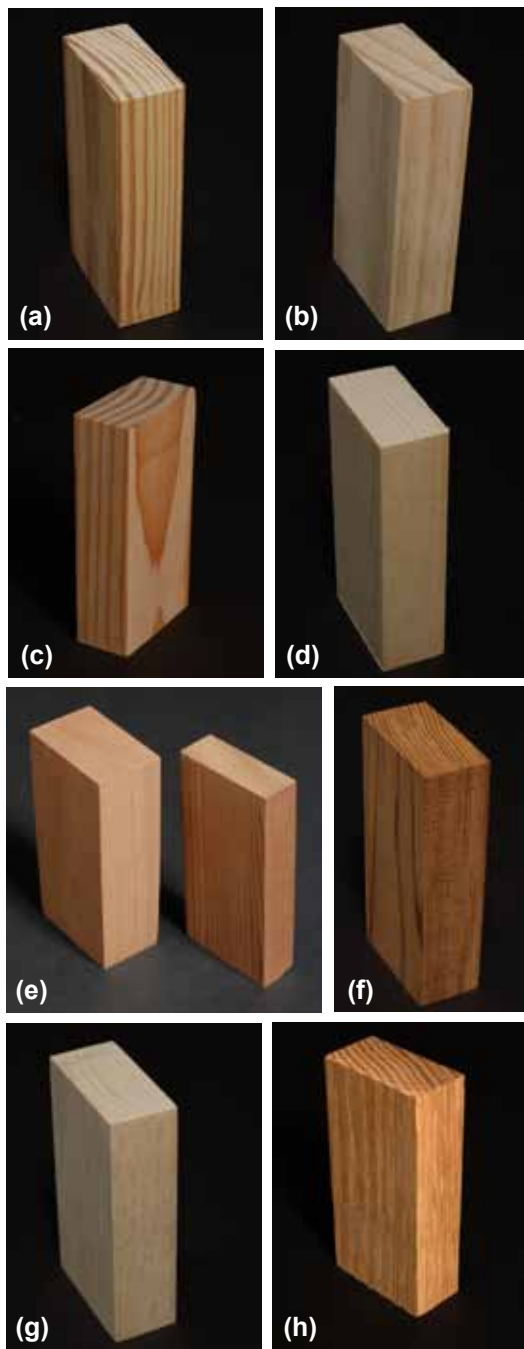

Figure 16–5. Wide LW bands characteristic of (a) the southern yellow pines, (b) radiata pine, and (c) Douglas-fir and narrow LW bands characteristic of (d) white pine, (e) redwood, and (f) western redcedar; (g) and (h) are examples of the difference in surface texture between diffuse-porous and ring-porous hardwoods, respectively; (e) shows examples of second or third growth (left) and old-growth (right) redwood.

Fifty years ago, most exterior siding and trim were vertical-grain heartwood of western redcedar or redwood. All-heartwood vertical-grain grades of these species are still available as resawn bevel siding and lumber and are excellent wood substrates for painting (Table 16–1). Other species are generally available only as flat-grain or a mix of flat- and vertical-grain lumber (for example, western hemlock, eastern white pine, lodgepole pine, eastern white cedar, radiata pine, and southern yellow pine). Finishing characteristics of flat-grain western redcedar and redwood are similar to other low-density wood species having moderate EW–LW transition (such as eastern white pine, eastern white cedar, and yellow poplar) Sawing to yield vertical grain is only practical with fairly large-diameter logs. Species available in small-diameter logs yield mostly flat-grain lumber.

Other wood properties, such as knots, juvenile wood, and extractives, affect wood finishing. Extractives include many chemicals with different solubilities in water, organic solvents, and paint resins (also called binders).

Manufacturing

The axial EW and LW cells in a log yield lumber of various grain angles (Fig. 16–6). At one extreme (board a), the growth rings are perpendicular to the plane of the board; at the other extreme (board c), growth rings are parallel to the plane of the board (although they have an arc). Grain varies between these two extremes. Vertical-grain lumber has a grain angle from 90° (growth rings perpendicular to surface) to approximately 45° . From 45° to the other extreme (board c), lumber is considered flat grain. Board b is different. Lumber cut close to the pith (the center of the log) contains abnormal wood cells. These abnormal cells are juvenile wood and have extremely high longitudinal dimensional change (2%) compared with normal wood (0.1–0.2%). The values are the change from green to oven-dry (see Chap. 4). A 10-ft (3-m) board could shrink 2.4 in. (61 mm). This dimensional instability leads to severe warping and cross-grain checking in lumber containing juvenile wood (see Chap. 5).

The bark side and pith side of flat-grain or flat-sawn lumber have slightly different properties. The pith side is more prone to have raised grain than the bark side, particularly with abrupt-transition wood species (southern yellow pine, Douglas-fir, and oak (Table 16–1)). The bark side tends to check more, and the checking is more pronounced in the LW bands.

Table 16–1. Painting characteristics of common wood species

Wood species	Specific gravity ^a (green/dry)	Shrinkage (%) ^b		Paintability ^c (latex paint)	EW/LW transition ^d	Is LW greater than about 1/3 of GR ^e	Color of heartwood
		Tangential	Radial				
Softwoods							
Baldcypress	0.42/0.46	6.2	3.8	II	A	No	Light brown
Cedars				I			
Incense	0.35/0.37	5.2	3.3	I	G	No	Brown
Northern white	0.29/0.31	4.9	2.2	I	G	No	Light brown
Port-Orford	0.39/0.43	6.9	4.6	I	G	No	Cream
Western red	0.31/0.32	5	2.4	I	G	No	Brown
Alaska yellow	0.42/0.44	6	2.8	I	G	No	Yellow
Douglas-fir ^{f,g}	0.45/0.48	7.6	4.8	III	A	Yes	Pale red
Pines							
Eastern white	0.34/0.35	6.1	2.1	I	G	No	Cream
Ponderosa	0.38/0.42	6.2	3.9	II	A	Yes/No	Cream
Southern ^h	0.47/0.51 ^h	8	5	III	A	Yes	Light brown
Western white	0.36/0.38	7.4	4.1	I	G	No	Cream
Radiata	0.45/0.53	7.0	4.2	III	A	Yes/No	Cream
Redwood ⁱ	0.38/0.40	4.4	2.6	I	A	No	Dark brown
Spruce ^j	0.33/0.35	7.1	3.8	I	G	No	White
Tamarack/larch	0.49/0.53	7.4–9.1	3.7–4.5	II	A	Yes/No	Brown
True fir	0.37/0.39	7.0	3.3	I	G	No	White
Western hemlock	0.42/0.45	7.8	4.2	II	G/A	Yes/No	Pale brown
Hardwoods							
Red alder	0.37/0.41	7.3	4.4	I	D	NA	Pale brown
Ash	0.55/0.60	8	5	III	R	Yes	Light brown
Aspen/cottonwood	0.36/0.40	7.0–9.2	3.5–3.9	I	D	NA	Pale brown
Basswood	0.32/0.37	7.8	5.9	I	D	NA	Cream
Beech	0.56/0.64	11.9	5.5	I	D	NA	Pale brown
Birch	0.55/0.62	9.5	7.3	I	D	NA	Light brown
Butternut	0.36/0.38	6.4	3.4	II	SR	Yes	Light brown
Cherry	0.47/0.50	7.1	3.7	I	D	NA	Brown
Chestnut	0.40/0.43	6.7	3.4	III	R	Yes	Light brown
Elm, American	0.46/0.50	9.5	4.2	III	R	Yes	Brown
Hickory	0.64/0.72	11	7	III	R	Yes	Light brown
Maple, sugar	0.56/0.63	9.9	4.8	I	D	NA	Light brown
Oaks							
White oak group	0.60/0.68	8.8	4.4	III	R	Yes	Brown
Red oak group	0.56/0.63	8.6	4.0	III	R	Yes	Brown
Sweetgum	0.46/0.52	10.2	5.3	I	D	NA	Brown
Sycamore	0.46/0.49	8.4	5	I	D	NA	Pale brown
Walnut	0.51/0.55	7.8	5.5	II	SR	Yes	Dark brown
Yellow-poplar	0.40/0.42	8.2	4.6	I	D	NA	Pale brown

^aSpecific gravity based on weight oven-dry and volume at green or 12% moisture content.

^bDimensional change obtained by drying from green to oven-dry. Values reported here are averages from a variety of sources and are provided for comparative purposes. For more specific values, see Chapter 4.

^cI, easy to finish; III, difficult to finish.

^dA, abrupt-transition softwood; G, gradual-transition softwood; R, ring-porous hardwood; D, diffuse-porous hardwood; SR, semi-ring-porous hardwood.

^eGR, growth ring; NA, not applicable; yes/no, depends on the specimen. In ring-porous hardwoods, the growth rate (number of rings per centimeter or inch) will determine the relative proportions of earlywood and latewood.

^fLumber and plywood.

^gCoastal Douglas-fir.

^hLoblolly, shortleaf; specific gravity of 0.54/0.59 for longleaf and slash.

ⁱRedwood is listed as paintability “I” because its LW band is very narrow.

^jSpruce. Values are for Engelmann spruce; other species are similar.

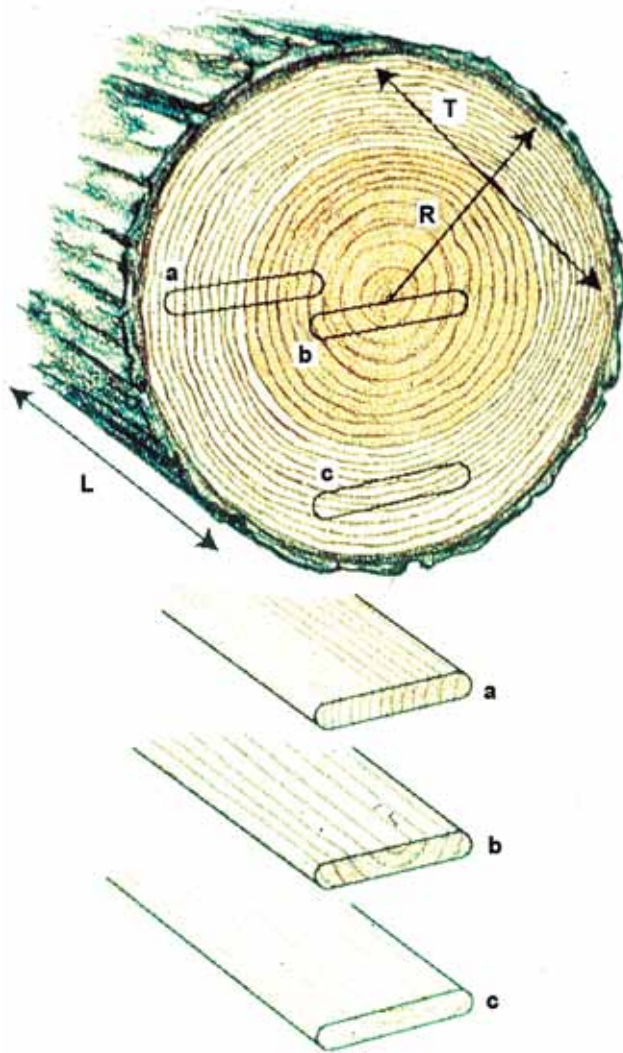

Figure 16-6. Lumber grain affects finish performance: (a) edge-grain (vertical-grain or quarter-sawn) board; (b) edge-grain board containing pith; (c) flat-grain (slash-grain or plain-sawn) board. Arrows show radial (R), tangential (T), and longitudinal (L) orientation of wood grain.

Moisture content

Moisture content (MC) is the amount of water (in any of its forms) contained in wood (see Chap. 4). MC includes water or water vapor absorbed into cell walls and free water within the hollow center of the cells (lumina); it is expressed as weight percentage. The amount of water vapor wood can absorb, depends on wood species; most species can absorb water vapor to increase their mass approximately 30% above an oven-dry MC condition. This water is hydrogen bound within the cell wall matrix of hemicelluloses and, to some extent, cellulose. The limit to the amount of water bound in the wood cell wall is the fiber saturation point.

The amount of water vapor wood absorbs depends on the relative humidity (RH) of the surrounding air. If wood is stored at 0% RH, the MC will eventually approach 0%. If

Moisture

The chemical commonly called water (H_2O) has three states according to temperature and pressure conditions: gas (water vapor or steam), liquid (water), or solid (ice). When water interacts with wood, it can occur in a fourth state (bound water). Moisture is not one of the states of water; it is a term with the power to indicate uncertainty about the water's state, or to refer collectively to water in all its states in wood. For example, some of the moisture in a board at 50% moisture content will occur as liquid water (or ice, depending on the temperature) within cell cavities of the wood, some will occur as water vapor, and some will be bound water (bound within cell walls). Moisture thus accounts for any or all of these states in a single word. In this chapter, the term water designates water in its liquid state.

wood is stored at 100% RH, the MC will eventually reach fiber saturation (approximately 30% moisture). Of course, if kept at a constant RH between these two extremes, wood will stabilize at a MC between 0% and 30%. The RH controls the MC, and when the MC is in balance with the RH, the wood is at its equilibrium moisture content (EMC). This rarely happens because as the RH changes, so does the MC of the wood, and atmospheric RH is continually changing. It varies through daily and seasonal cycles, thus driving the MC of wood through daily and seasonal cycles. See Chapter 4 for more information on MC and EMC.

Finishes cannot change EMC; they affect only the rate at which absorption and desorption occur (see Moisture-Excluding Effectiveness).

Wood outdoors in most areas of the United States cycles around a MC of approximately 12% to 14%. In the Pacific Northwest, average MC can be slightly higher (12% to 16%), and in the Southwest, slightly lower (6% to 9%) (Chap. 13, Tables 13-1 and 13-2). Daily and annual MC may vary from these averages. In general, wood outdoors decreases MC during the summer and increases MC during the winter. (Wood indoors in northern climates increases MC during the summer and decreases MC during the winter. In the south, this distinction is not clear because air conditioning affects indoor RH and thus MC.) Even in humid areas, RH is rarely high enough for a long enough period to bring the MC of wood above 20%. Wood warmed by the sun experiences a virtual RH far below the ambient RH. The surface dries faster than the rest of the lumber. This is why cupping and checking often occur on decking boards; the top surface is much drier than the rest of the board. Shrinkage of the top surface commensurate with this dryness causes cupping and checking parallel to the grain. (Juvenile wood often checks perpendicular to the grain.)

As mentioned, fiber saturation is the limit to the amount of *water vapor* that wood absorbs. *Water vapor* absorbs slowly compared with *liquid water*. *Liquid water* can quickly bring

wood to fiber saturation, and it is the only way to bring the MC of wood above fiber saturation. As wood continues to absorb *liquid water* above its fiber saturation point, the water is stored in the lumen; when water replaces all the air in the lumen, the wood is waterlogged and its MC can be as high as 200%.

Wood can get wet many ways (such as windblown rain, leaks, condensation, dew, and melting ice and snow). The result is always the same—poor performance of wood and finish. Water is usually involved if finishes perform poorly on wood. Even if other factors initially cause poor performance, water accelerates degradation. Fortunately, the MC of lumber can be controlled. However, all too often, this critical factor is neglected during construction and finishing.

Paint wood when its average MC is about that expected to prevail during its service life (approximately 12% for most of the United States and Canada). Painting wood after it acclimates to a MC commensurate with the environment minimizes stress on film-forming finishes. The MC and thus the dimensions of the piece will still fluctuate somewhat, depending on the cyclic changes in atmospheric RH, but the dimensional change should not be excessive. Therefore, film-forming finishes (such as paints) are not stressed and should not fail by cracking.

Most siding and trim is kiln dried to less than 20% MC before shipment, and if it has been kept dry during shipment and storage at the construction site, it should be close to EMC by the time it is finished. If wood gets wet during shipping or storage or at the construction site, a MC of less than 20% is not likely. If wet wood is used, it will dry in service and shrinkage may cause warping, twisting, and checking. If the MC of wood exceeds 20% when the wood is painted, the risk of blistering and peeling is increased. Moreover, water-soluble extractives in species such as redwood and western redcedar may discolor paint.

Plywood, particleboard, hardboard, and other wood composites change MC during manufacture. Frequently, the MC of these materials is not known and may vary depending on the manufacturing process. As with other wood products, condition wood composites prior to finishing.

Dimensional Change

Dimensional change depends on wood species and varies within a particular species. Average shrinkage values obtained by drying wood from its green state to oven dry vary from 2.4% for radial western redcedar to 11.9% for tangential beech (Table 16–1). Dimension in service does not vary to this extent because the MC seldom goes below 6% (Chap. 13, Table 13–1). A film-forming finish would likely decrease this range, but only if the end grain is sealed; unsealed end grain increases MC of painted wood (see Moisture Excluding Effectiveness).

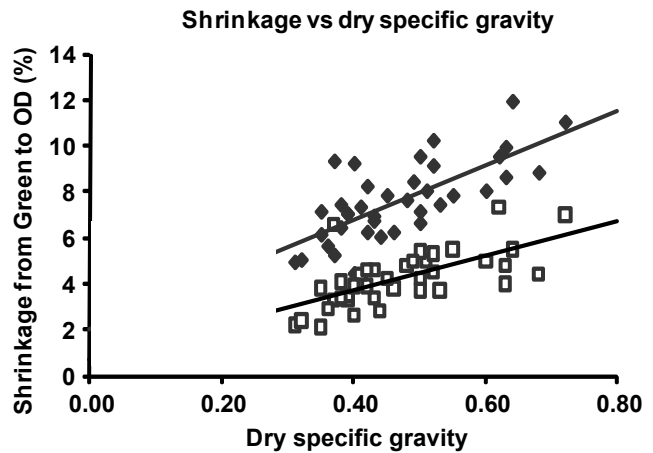

Figure 16–7. Plots of radial (□) and tangential (♦) shrinkage from green to oven dry (OD) as a function of specific gravity for various hardwoods and softwoods from Table 16–1. Lines show least-squares fit.

Wood having little tendency to shrink and swell gives a stable surface for painting. Vertical-grain surfaces are more stable than flat-grain surfaces (Table 16–1, Fig. 16–6), especially outdoors where periodic wetting may produce rapid dimensional change. Wood species having low specific gravity tend to be more dimensionally stable than those having high specific gravity (Fig. 16–7). Low-specific-gravity wood species (that is, those that are more dimensionally stable) hold paint better than high-specific-gravity wood species; however, other factors, such as wood anatomy and manufacturing, also affect paint adhesion.

Wood Extractives

Highly colored extractives occur in heartwood of softwoods such as western redcedar and redwood and hardwoods such as walnut and mahogany. Extractives give heartwood its color, and many extractives are soluble in water. Discoloration of painted or unpainted wood may occur when rain leaches water-soluble extractives from wood. (If indoors, plumbing leaks or high RH can also cause it.) The water carries extractives to wood or paint surfaces and evaporates, leaving extractives as a yellow to reddish brown stain on the surface. Some paints, such as oil-alkyd stain-blocking primers, block leaching of water-soluble extractives.

Wood also contains compounds (resins and oils) that are insoluble in water. Species and growing conditions determine the type and amount of these compounds. For example, many pines contain pitch, and knots of almost all species contain sufficient oils and resins to discolor light-colored paint. These oils and resins are similar chemically to oil-alkyd paints; therefore, oil-alkyd stain-blocking primers cannot block them. Latex-based formulations are also ineffective (see Knots and Pitch).

Shellac (a natural product made from the secretion of lac-producing insects such as *Kerria lacca*) and specially formulated synthetic finishes block extractives bleed from knots. Use shellac or synthetic knot sealers only over knots and paint over them to protect them from water. Blocking diffusion of extractives from knots is difficult, and no easy fix is available other than the extra step of sealing knots before priming. By doing this extra step, you can minimize discoloration of white paint on knotty pine—but it is not easy. If you want white, use knot-free wood. Difficulty sealing knots is the main reason manufacturers cut out the knots to make fingerjointed/edge-glued lumber.

Another option for knots is to use them to accentuate the wood. Use a stain to bring out the color and make the knots a part of the desired appearance.

Wood Products

Six types of wood products are commonly used on the exterior of structures: (1) lumber, (2) plywood, (3) fingerjointed wood, (4) reconstituted wood products (such as hardboard and oriented strandboard (OSB)), (5) wood–plastic composites, and (6) preservative- or fire-retardant-treated wood. Each product has unique characteristics that affect application and performance of finishes.

Lumber

Lumber (such as siding, trim, and decking) for exterior use is available in many species and products, and several publications describe grades:

- “Standard Grading Rules for West Coast Lumber,” West Coast Lumber Inspection Bureau, Portland, Oregon
- “Standard Grading Rules for Canadian Lumber,” National Lumber Grades Authority, New Westminster, British Columbia
- “Western Lumber Grading Rules,” Western Wood Products Association, Portland Oregon
- “Standard Grading Rules for Northeastern Lumber,” Northeastern Lumber Manufacturers Association, Cumberland Maine
- “Standard Grading Rules,” Northern Softwood Lumber Bureau, Cumberland Maine
- “Standard Specifications for Grades of California Redwood Lumber,” Redwood Inspection Service, Pleasant Hill, California
- “Standard Grading Rules for Southern Pine Lumber,” Southern Pine Inspection Bureau, Pensacola Florida

These publications are the basis for selecting wood to meet codes. They give specifications for appearance grades (such as siding and trim) and for structural lumber (such as framing and decking). Western redcedar and redwood are the only species available in vertical-grain grades and saw-textured surfaces (Table 16–1). Southern yellow pine and Douglas-fir plywood are available in saw-textured surfaces.



Figure 16–8. Examples of trade association brochures describing wood products.

Unless specified as vertical grain, the grade contains mostly flat-grain lumber. Lumber used for board and batten, drop, or shiplap siding is frequently flat grain. Bevel siding is commonly produced in several grades. The highest grade of redwood and western redcedar bevel siding is vertical grain and all heartwood. Other grades of redwood and western redcedar may be flat, vertical, or mixed grain and may not be all heartwood. Grade is important because species, grain orientation, and surface texture affect paint-holding characteristics.

Descriptions of grades and pictures of many wood species are contained in brochures published by trade associations (such as Western Red Cedar Lumber Association, California Redwood Association, Western Wood Products Association, Southern Forest Products Association, and Northeast Lumber Manufacturing Association) (Fig. 16–8), and these brochures reference the grade rules. When specifying lumber, refer to the grade rules for the product to ensure that the product meets code requirements and use the association brochures to get an idea of appearance.

Textures (roughness or smoothness) of wood surfaces affect selection, application, and service life of finishes. Until recently, a general rule of thumb for matching substrates to finishes was to paint smooth wood and stain saw-textured wood. This easy rule of thumb no longer applies. Although



Figure 16-9. Early paint failure on plywood caused by penetration of moisture into surface face-checks.



Figure 16-10. Differences in stain from extractives on fingerjointed wood from the white pine group (either eastern or western species) painted with acrylic solid-color stain.

penetrating finishes such as solvent-borne oil-based semitransparent stains last longer on saw-textured wood than on smooth-planed wood, many film-forming finishes such as opaque stains and paints also last longer on saw-textured wood than on smooth-planed wood. Finishes adhere better, film buildup is thicker, and service life of the finish is longer on saw-textured surfaces than smooth-planed surfaces, particularly for flat-grain lumber.

Plywood

As with lumber, species, grain orientation, and surface texture affect finishing of plywood. Manufacturers of softwood plywood use a lathe to peel logs to give flat-grain veneer. Peeling causes small checks parallel to grain. When the face veneer is laid up to form the plywood panel, the side of the veneer having lathe checks is placed interior to give a surface free of checks. However, after plywood is placed

outdoors, wet-dry cycles (swelling and shrinking) cause the checks to propagate to the surface (face checking). Face checking sometimes extends through paint coatings to detract from the appearance and durability of the paint (Fig. 16-9).

Veneer produced by peeling gives flat-grain plywood and it is commonly available with a saw-textured, abrasively planed (smooth), or paper overlay surface. Douglas-fir and southern yellow pine are available saw-textured (Table 16-1). Saw-textured plywood holds paint much better than does smooth plywood. If smooth plywood is to be painted, scuff-sand it with 50-grit sandpaper and use high-quality latex paint. Latex primer and top-coat generally perform better than oil-alkyd paint. Paint performs poorly on smooth plywood if used as siding but reasonably well on smooth plywood in protected areas such as soffits. Resin-treated paper bonded to plywood forms a medium-density overlay (MDO); MDO eliminates cracks caused by lathe checking and provides plywood with excellent paintability, but the edges are still vulnerable to water. Seal the edges with oil-alkyd primer or an edge sealer formulated for this use. Paper over-laid products should not be finished with semitransparent stain or other penetrating finishes. Use film-forming finishes such as paints or solid-color stains and ensure sufficient film thickness (0.004–0.005 in. (0.10–0.13 mm), or 4–5 mils).

APA—The Engineered Wood Association (Tacoma, Washington) provides information on plywood grades and standards (see Chap. 11).

Fingerjointed Lumber

To obtain “knot free” lumber, mills produce lumber that consists of many small pieces of wood edge-glued and fingerjointed at the end-grain (see Chaps. 10 and 12). Although fingerjointed lumber contains no knots or other obvious defects, most mills do not sort wood pieces prior to gluing to give lumber with similar grain orientation and heartwood-sapwood content. A particular board may contain pieces from different trees, and each piece may have different finishing characteristics; therefore, finishing requirements are determined by the most difficult-to-paint component in a fingerjointed board. Fingerjointed lumber is commonly used for fascia boards, interior and exterior trim, siding, windows, and doors. Paint often fails in a “patchwork” manner according to the paintability of various pieces. The board pictured in Figure 16-10 shows extractive bleed on the component to the right, but not on the component to the left.

Some manufacturers decrease variability in fingerjointed lumber. For example, fingerjointed redwood siding is available in clear all-heart vertical grain and clear flat grain.

Finishing fingerjointed lumber requires care to ensure consistent finish performance on the whole board. To hide color



Figure 16–11. Absorption of water causes differential dimensional change of surface flakes to give an uneven surface (telegraphing).

differences of the various pieces, use opaque finishes rather than natural finishes (such as semitransparent stain). As with other wood products, planed surfaces should be scuff-sanded with 50-grit sandpaper prior to priming. Saw-textured lumber should hold paint better than planed lumber.

Particleboard and Similar Reconstituted Wood Products

Reconstituted wood products are made by forming small pieces of wood into large sheets; sheets are cut into 1.2- by 2.4-m (4- by 8-ft) panel products or other sizes such as siding. These products are classified as particleboard or fiberboard, depending upon the nature of the wood component (see Chap. 11).

Particleboard is made from splinters, chips, flakes, strands, or shavings. Flakeboard is a type of particleboard made from large flakes or shavings. Oriented strandboard (OSB) is a refinement of flakeboard; the flakes have a large length-to-width aspect ratio and are laid down in three layers, with the flakes in each layer oriented 90° to each other as are veneers in plywood (see Chap. 11). Most OSB is used inside the external envelope of structures for sheathing and underlayment, however it contains “exterior” adhesives and water repellent. The water repellent gives OSB water resistance while in transit and storage prior to construction. The water repellent does not decrease paint adhesion.

Lumber characteristics, such as grain orientation, specific gravity, grain boundary transition, warping, and splitting, are not considerations with particleboard, but paint applied directly to particleboard performs poorly. Differential dimensional change of surface flakes causes telegraphing, and paint usually cracks and peels (Fig. 16–11). Telegraphing is the formation of an uneven paint surface caused by swelling of flakes and particles under the paint. Telegraphing occurs on all types of particleboard, but not on fiberboard. Adhesive failure leads to loss of flakes from the surface. Figure 16–11 shows painted flakeboard after 3 years outdoors. The area on the left has one coat of acrylic-latex top-coat and

the area on the right has one coat of oil-alkyd primer and acrylic-latex top-coat. The single coat (top-coat only) has failed, and the area having two-coats (primer and top-coat) is starting to fail, particularly over large flakes. Products intended for outdoor use, such as siding, are overlaid with MDO or wood veneer to improve paint performance. Products having MDO can be finished in the same way as other paper-overlaid products. Seal edges with a product specifically formulated for this use, and apply an oil-alkyd primer to give additional water resistance (see Plywood).

When finishing particleboard that does not have a paper overlay, use a three-coat latex paint system on the surface and seal edges as described above. However, do not expect long-term paint performance.

When particleboard or OSB, without an overlay, is used outdoors, it requires a rigorous maintenance schedule (often every 6 to 12 months).

Mechanical pulping produces wood fibers that are dry- or wet-formed into fiberboard (Chap. 11). Hardboard is a dense fiberboard often used for exterior siding. Hardboard is available in 152- to 203-mm (6- to 8-in.) widths as a substitute for solid-wood beveled siding. The surface of fiberboard accepts and holds paint well, and MDO improves paintability. As with particleboard, seal edges with oil-alkyd primer or other suitable sealer.

Wood–Plastic Composites

Wood-plastic composites (WPCs) account for approximately one-fourth of wood decking. Manufacturers combine wood flour, fibers, particles, or a combination, with polyethylene, polyvinyl chloride, or polypropylene and extrude “boards” in various profiles. Wood content and particle size in the boards vary and thus their ability to accept a finish varies. Boards high in wood content with large particle size may accept a finish; boards high in plastic content may not. Finish a small area to ensure the finish will wet the surface. After the finish cures, check adhesion using the tape pull-off test (see Chalking). Plastics are routinely finished in industrial applications, such as car parts, by activating the plastic surface using flame or plasma. This technology is not used on WPCs for the construction industry, because most manufacturers do not expect their products to be finished.

Treated Wood

Wood used in structures fully exposed to the weather, such as in decks and fences (particularly those portions of the structure in ground contact), needs preservative treatment to protect it from decay (rot) and termites. Wood used in marine exposure also requires preservative treatment to protect it from decay and marine borers. For some uses, building codes may require treatment of wood with either preservative or fire-retardant, or both.

Wood is pressure-impregnated with three types of preservatives: (a) preservative oils (such as coal-tar creosote), (b) organic solvent solution (such as pentachlorophenol), and

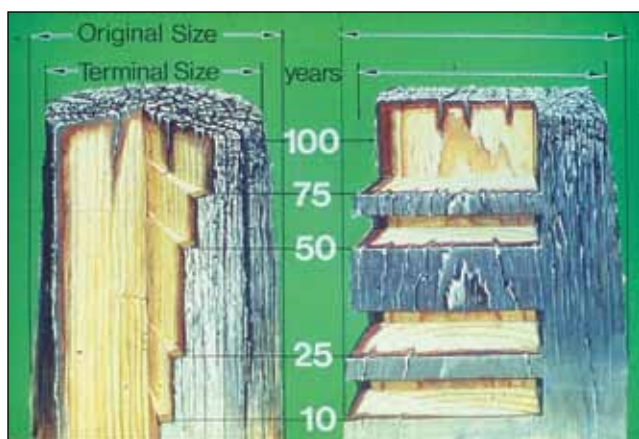

Figure 16–12. Artist's rendition of weathering process of round and square timbers. As cutaway shows, interior wood below surface is relatively unchanged.

(c) waterborne salts (such as copper quaternary ammonium complexes, copper azole, and chromated copper arsenate (CCA)) (Chap. 15). Note: Except for the all-wood foundation, CCA-treated wood is not used in residential construction.

Components for doors and windows are usually dip-treated with a water-repellent preservative (WRP). The American Wood Protection Association sets standards for pressure-impregnated and dip-preservative treatment of wood (AWPA 2008).

Wood treated with waterborne preservatives, such as copper-based systems, can be painted or stained if the wood is clean and dry. Bleed of preservative through finishes, particularly latex-based paints and solid-color stains, can occur if wood is still wet from the preservative treatment. Allow wood to dry before painting; 1 week should be sufficient. Wood treated with coal-tar creosote or other dark oily preservatives is not paintable, except with specially formulated finishes such as two-component epoxy paints; even if the paint adheres to the treated wood, the dark oils tend to discolor paint, especially light-colored paint. Wood treated with a water-repellent preservative, by vacuum-pressure or dipping, is paintable.

Fire-retardant- (FR-) treated wood is generally painted rather than left unfinished because the FR treatment may darken or discolor wood. FR treatment does not generally interfere with adhesion of finishes; however, you should contact the paint manufacturer, the FR manufacturer, and the treating company to ensure that the products are compatible. Some fire retardants may be hygroscopic and cause wood to have high MC. FRs for wood used outdoors are formulated to resist leaching.

Weathering

Weathering is the general term describing outdoor degradation of materials and manifests itself physically and

chemically (for example, cracking and exfoliation of rock, corrosion of metals, and photodegradation of organic materials). Ultraviolet (UV) radiation in sunlight catalyzes photodegradation of organic materials exacerbated by moisture, temperature change, freeze–thaw cycles, abrasion by windblown particles, and growth of microorganisms. Degradation occurs near the surface of wood, wood products, and finishes.

Effect on Wood

Weathering takes many forms depending on the material; wood and wood products initially show color change and slight checking. Leaching of water-soluble extractives, chemical changes, and discoloration of the surface by microorganisms cause color change. As weathering continues, wood develops checks on lateral surfaces and checks and cracks near the ends of boards, and wood fibers slowly erode from the surface. Wood consists of three types of organic components: carbohydrates (cellulose and hemicelluloses), lignin, and extractives. Weathering affects each of these components differently, and physical and chemical changes affect paintability.

Carbohydrates

Carbohydrates (cellulose and hemicelluloses) are polymers of sugars and make up 55% to 65% of wood (Chap. 3). Carbohydrates do not absorb UV radiation and are therefore resistant to UV degradation. However, hemicelluloses and amorphous cellulose readily absorb–desorb moisture; this cyclic wetting and drying may cause different dimensional change for EW/LW bands. Differential dimensional change roughens wood, raises grain, and causes checks, cracks, warping, and cupping. Fewer checks develop in woods with moderate to low specific gravity than in those with high specific gravity; vertical-grain boards develop fewer checks than do flat-grain boards; and vertical-grain boards warp and cup less than do flat-grain boards. To minimize cupping, the width of a board should not exceed eight times its thickness. The tendency to cup increases with the specific gravity and width/thickness ratio.

Lignin

Approximately 20% to 30% of wood is composed of lignin, a polymer that helps bond cellulose and hemicelluloses within cell walls and bonds cells together. The volume between adjacent wood cells (middle lamella) is rich in lignin. If exposed to UV radiation, lignin in the middle lamella, at the surface of wood, begins to degrade within a few hours. The changes are not obvious visually, but they affect the surface chemistry of wood and thus adhesion of finishes. Lignin photodegrades, leaving cellulose fibers loosely attached to the surface. Further weathering causes fibers to be lost from the surface (a process called erosion), but this process is slow. Approximately 6 mm (1/4 in.) of wood is lost in a century (Fig. 16–12). Erosion is slower for most hardwoods and faster for low-density softwoods. Other factors such as

Table 16–2. Erosion of earlywood and latewood on smooth planed surfaces of various wood species after outdoor exposure^a

Wood species	Avg. SG ^b	Erosion (µm) after various exposure times ^c											
		4 years		8 years		10 years		12 years		14 years		16 years	
		LW	EW	LW	EW	LW	EW	LW	EW	LW	EW	LW	EW
Western redcedar plywood	—	170	580	290	920	455	1,095	615	1,165	805	1,355	910	1,475
Redwood plywood	—	125	440	295	670	475	800	575	965	695	1,070	845	1,250
Douglas-fir plywood	—	110	270	190	390	255	500	345	555	425	770	515	905
Douglas-fir	0.46	105	270	210	720	285	905	380	980	520	1,300	500	1,405
Southern Pine	0.45	135	320	275	605	315	710	335	710	445	1,180	525	1,355
Western redcedar	0.31	200	500	595	1,090	765	1,325	970	1,565	1,160	1,800	1,380	1,945
Redwood	0.36	165	405	315	650	440	835	555	965	670	1,180	835	1,385
Loblolly pine	0.66	80	205	160	345	220	490	—	—	—	—	—	—
Western redcedar	0.35	115	495	240	1,010	370	1,225	—	—	—	—	—	—
Southern Pine	0.57	95	330	180	640	195	670	—	—	—	—	—	—
Yellow-poplar	0.47	—	220	—	530	—	640	—	—	—	—	—	—
Douglas-fir	0.48	75	255	175	605	225	590	—	—	—	—	—	—
Red oak	0.57	180	245	340	555	440	750	—	—	—	—	—	—
Ponderosa pine	0.35	130	270	315	445	430	570	Decay	Decay	Decay	Decay	—	—
Lodgepole pine	0.38	105	255	265	465	320	580	475	745	560	810	—	—
Engelmann spruce	0.36	125	320	310	545	390	650	505	795	590	950	—	—
Western hemlock	0.34	145	320	310	575	415	680	515	1,255	600	1,470	—	—
Red alder	0.39	—	295	—	545	—	620	—	920	—	955	—	—

^aData from three studies are shown. Specimens were exposed vertically facing south. Radial surfaces were exposed with the grain vertical. EW denotes earlywood; LW, latewood.

^bSG is specific gravity.

^cAll erosion values are averages of nine observations (three measurements of three specimens).

growth rate, degree of exposure, grain orientation, temperature, and wetting and drying cycles affect erosion rate. Table 16–2 shows erosion rates for several wood species measured over 16 years.

Extractives

Extractives (chemicals in heartwood that give each species its distinctive color) change color when exposed to UV radiation or visible light, and this color change indicates degradation of extractives near the surface. The color change causes wood to lighten or darken. Some wood species change color within minutes of outdoor exposure. Wood also changes color indoors. Ordinary window glass blocks most UV radiation, therefore visible light causes indoor color change. UV stabilizers in finishes do not prevent color change.

Biological Factors

The most common biological factor is mildew, a microorganism that contributes to color change. Mildew does not cause degradation, but it may cause initial graying or an unsightly dark gray or black blotchy appearance. Dark-colored fungal spores and mycelia on the wood surface cause this color. In advanced stages of weathering, after extractives and lignin have been removed leaving a cellulose surface, wood may develop a bright silvery-gray sheen. This sheen on weathered wood occurs most frequently in arid climates or coastal regions (see Mildew).

Algae can also grow on wood, particularly in damp locations; algae is usually green, and it often grows in combination with mildew.

Effect on Paint Adhesion

Wood erosion is slow, but chemical changes occur within a few weeks of outdoor exposure. Badly weathered wood having loosely attached fibers on the surface cannot hold paint. This is not obvious on wood that has weathered for only 2 to 3 weeks. The wood appears unchanged. Research has shown that surface degradation of wood exposed to sunlight for 1, 2, 4, 8, or 16 weeks prior to painting (preweathering) affects service life of subsequently applied paint. The longer the wood preweathered, the shorter the time until the paint began to peel. For boards preweathered 16 weeks, the paint peeled within 3 years; for boards preweathered only 1 week, the paint peeled after 13 years. Panels that were not preweathered showed no sign of peeling after 20 years. Paints were commercial oil-alkyd or acrylic-latex primer with one acrylic-latex top-coat over planed all-heartwood vertical-grain western redcedar. For species with low specific gravity, finish the wood as soon as possible after installation, or better yet, prime it before installation. In other tests using wood species having higher specific gravity (such as Douglas-fir and southern yellow pine), little loss of paint adhesion occurred until boards had been preweathered for 3 to 4 weeks.

Effect on Wood Finishes

Finish resins (ingredients that form films or penetrate wood) are organic polymers, and as with lignin in wood, UV radiation degrades the polymer, causing slow erosion. Erosion rate depends on the resistance of the polymer to UV radiation. Paints and stains based on latex polymers are more resistant to UV radiation than those based on oil-alkyds. UV radiation does not usually degrade paint pigments; therefore, as resin degrades, pigments loosen and erode from the surface. Degraded resin and loose pigments give film-forming finishes a chalky appearance. Pigment erodes from oil-based semitransparent stains to expose wood.

Decay and Insects

Decayed wood does not hold paint. One expects wood used for new construction to be free of decay; contractors can do several things to keep it that way. If possible, paint all end grain surfaces with an oil-alkyd primer (such as ends of siding and trim, brick molding, railings, balustrade, posts, beams, and edges of panel products (plywood, T1-11 siding, medium-density fiberboard, and OSB).

When repainting, inspect wood for decay. Problematic areas include end grain of balustrade, brick molding, siding that butts against a roof, and bottoms of posts on porches. Decay often occurs in the center of wood and the surface can appear sound; probe several areas with an ice pick to ensure the wood is sound. Replace boards having decay. Siding intersecting a sloping roof should have a 2-in. (50-mm) gap between the end grain of the siding and the roof shingles. Check for a finish on the end grain; if there is no finish, treat end grain with a WRP, prime, and top-coat. If there is already a coating on the end grain, keep it painted. End grain of siding that butts directly against roof shingles (a bad practice—see *Structure Design and Construction Practices*) is not accessible for painting, however you can try to wick WRP into the end grain from a wet brush.

Insects seldom cause problems with finishes. However, when repainting a structure, inspect it for termite tunnels and carpenter ants. A termite tunnel is a sure sign of infestation. Presence of carpenter ants may indicate decay in the structure. Carpenter ants do not eat wood, but they often tunnel out decayed areas to build their nests. Note that woodpecker holes often indicate insect infestation.

Control of Water and Water Vapor

Control of liquid water and water vapor requires different types of finishes.

Water Repellents

Water repellents and WRPs retard the absorption of liquid water into wood, particularly at the end grain. They are an excellent treatment for wood used outdoors because they inhibit absorption of rain yet allow wood to dry after rain. WRPs and similar penetrating finishes (tinted clear finishes and oil-based semitransparent stains) have almost no effect

on diffusion of water vapor; that is, they have little effect on the change in wood moisture content caused by changes in RH.

Moisture-Excluding Effectiveness

Moisture-excluding effectiveness (MEE) of a finish is a measure of its resistance to diffusion of water vapor (that is, a measure of the permeability of a coating to water vapor); it is not a measure of water repellency. A coating that blocks all water vapor is 100% effective; however, no coating is impermeable. A coating that excludes water vapor merely slows its absorption or desorption; it cannot change the EMC (Chap. 4). MEE depends on a number of variables: coating film thickness, defects and voids in the film, type and amount of pigment, chemical composition and amount of resin, vapor-pressure gradient across the film, and length of exposure.

Table 16–3 lists coatings and their MEE. Note that maleic-alkyds, two-part polyurethane, and paraffin wax have high MEE. Coatings that retard water vapor diffusion also repel liquid water. Porous paints, such as latex and low-luster (flat) paints, afford little protection against water vapor transmission. They may not repel liquid water, either. In general, a low MEE value also indicates low resistance to absorption to liquid water. These finishes permit entry of water vapor and water from dew and rain unless applied over a nonporous primer (such as oil-alkyd primer). Latex finishes contain surfactants that can encourage absorption of water into the coating and wood, particularly just after the coating has been applied. Most of these surfactants wash out of the coating after a short time. MEE also gives a measure of vapor transmission out of wood. Paint film can inhibit drying (Fig. 16–13). Retardation of drying after periodic wetting of wood causes it to reach a MC where decay can occur. This type of wood paint failure usually occurs on painted fences and porch railings that are fully exposed to weather (Fig. 16–14). Paint coatings usually crack at the joint between two pieces of wood, water enters the wood through these cracks, and the coating slows drying. Priming the end grain of wood used in these applications inhibits water absorption; thus, end-grain priming works with the coating on the lateral surface to keep the wood dry.

Structure Design and Construction Practices

Structure design and construction practices affect finish performance. Design and construct structures to keep water out and to remove it when water gets through the structure envelope. This section summarizes recommendations for improving finish performance.

Large roof overhangs protect siding from rain and dew; gutters and downspouts greatly decrease the amount of water draining down the siding.

Flash all wall and roof penetrations. Shingle the flashing to keep water moving out of the structure. Sealants, caulking compounds, and similar compounds that come in a tube

Table 16-3. Moisture-excluding effectiveness of various finishes on ponderosa pine^a

Finish	No. of coats	Moisture-excluding effectiveness (%)		
		1 day	7 days	14 days
Linseed oil	1	12	0	0
	2	22	0	0
	3	33	2	0
Water repellent ^b	1	12	0	0
	2	46	2	0
	3	78	27	11
Latex flat wall paint (vinyl acrylic resin)	1	5	0	0
	2	11	0	0
	3	22	0	0
Latex primer wall paint (butadiene-styrene resin)	1	78	37	20
	2	86	47	27
	3	88	55	33
Alkyd flat wall paint (soya alkyd)	1	9	1	0
	2	21	2	0
	3	37	5	0
Acrylic latex house primer paint	1	43	6	1
	2	66	14	2
	3	72	20	4
Acrylic latex flat house paint	1	52	12	5
	2	77	28	11
	3	84	39	16
Solid-color latex stain (acrylic resin)	1	5	0	0
	2	38	4	0
	3	50	6	0
Solid-color oil-based stain (linseed oil)	1	45	7	1
	2	84	48	26
	3	90	64	42
Semitransparent oil-based stain (commercial)	1	7	0	0
	2	13	0	0
	3	21	1	0
Alkyd house primer paint (maleic-alkyd resin)	1	85	46	24
	2	93	70	49
	3	95	78	60
Urethane varnish (oil-modified)	1	55	10	2
	2	83	43	23
	3	90	64	44
	4	91	68	51
	5	93	72	57
	6	93	76	62
Polyurethane paint, gloss (two components)	1	91	66	44
	2	94	79	62
	3	96	86	74
Aluminum flake pigmented varnish (oil-modified)	3	98	91	84
	4	98	93	87
Paraffin wax, brushed	1	97	82	69
Paraffin wax, dipped	1	100	97	95

^aSapwood was initially finished and conditioned to 26 °C (80 °F) and 30% RH, then exposed to the same temperature and 90% RH.
^bWRP would be about the same.

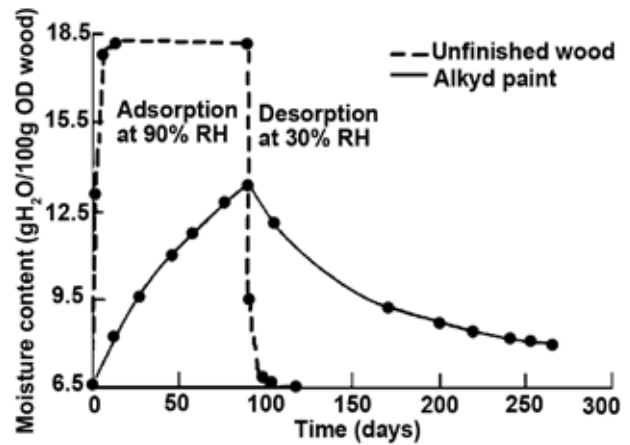

Figure 16-13. Change in moisture content of ponderosa pine sapwood finished with three coats of aluminum-pigmented alkyd paint and exposed to 90% and 30% RH at 26 °C (80 °F), compared with moisture content of unfinished wood.



Figure 16-14. Decay and paint failure in wood railing fully exposed to weather.

need to work in concert with flashing; they are not a substitute for flashing.

Vent clothes dryers, showers, and cooking areas to outside, not to the crawl space or attic. Place an air barrier in exterior walls and top-floor ceilings, and flash penetration through exterior walls (doors, windows, and vents). Vent to soffits if possible. Avoid using humidifiers. If the structure contains a crawl space, cover the soil with a vapor-retarding material such as black plastic or tar paper.

Do not seal the overlap of lap siding.

In northern climates, use an air barrier-vapor retarder on the interior side of all exterior walls and top-floor ceiling to prevent condensation in the walls and attic. In buildings that are air-conditioned most of the year, place the air barrier-vapor retarder on the exterior side.



Figure 16–15. Demonstration of siding installation over a secondary drainage plane (rain screen) showing wall studs, sheathing, water-resistive barrier (WRB), furring strips, and interleaved WRB at the butt joint. Note that the butt joint is centered directly over the furring strip and the underlying stud and the end grain has been sealed.



Figure 16–16. Demonstration of proper and improper z-flashing installation: (top) siding installed with a 9-mm (3/8-in.) gap between the z-flashing and siding to allow water to drain off the siding; (bottom) siding installed without a gap, which gives easy access for water absorption into the siding and thus shows extractives staining.

Prevent moisture-related problems in siding by using rain-screen design (that is, by furring out the siding 9 to 19 mm (3/8 to 3/4 in.) from the sheathing–house wrap) (Fig. 16–15).



Figure 16–17. Shingles installed with insufficient gap later warped when they expanded after getting wet.

Seal all end-grain surfaces with oil-alkyd primer or WRP. Ensure adequate space (approximately 50 mm (2 in.)) between siding and roof shingles in places where a side-wall intersects a roof. Siding and panel products above z-flashing need to be placed approximately 9 to 12 mm (3/8 to 1/2 in.) above the flashing to form a drip edge (Fig. 16–16).

When installing siding or shingles, ensure that the spacing is commensurate with the MC of the wood and the anticipated MC during the service life. Figure 16–17 shows shingles that were spaced too closely and buckled in service. Avoid inside–outside beams and joists. For example, a second-floor floor joist that penetrates a wall to form a porch rafter is destined to have moisture problems and subsequent decay and finish failure. This type of wall penetration is difficult to seal to avoid air movement. Air carries water vapor that condenses in the space between floors or the porch ceiling.

Compliance of VOC Finishes with Pollution Regulations

Volatile organic compounds (VOCs) are organic chemicals in finishes that evaporate as finishes dry and cure. VOCs are air pollutants, and the amount that evaporates for a given amount of solids (such as binder and pigments) in finishes is regulated. Under the 1990 New Clean Air Act, the U.S. Environmental Protection Agency (EPA) required paint companies to decrease the amount of VOCs in their finishes.

Traditional solvent-borne wood finishes containing mineral spirits are no longer available, including oil-based semi-transparent stains, oil- and oil-alkyd-based primers and top-coats, solvent-borne water repellents, and solvent-borne water-repellent preservatives. Solvent-borne finishes are still available, but the solvent systems are more complex than mineral spirits. Prior to VOC regulations, penetrating finishes, such as semitransparent stains, had low solids content



Figure 16–18. Front view of exterior grade of plywood siding after 10 years of exposure. The right-hand portion was exposed to the weather, whereas the left-hand side was covered with a board to give a board-and-batten appearance.

(pigment, oils, and polymers). Reformulated finishes may contain more solids, new types of solvents and co-solvents, or other nontraditional additives. These high-solids formulations are prone to form films rather than penetrate wood.

The paint industry also reformulated latex-based finishes to meet stringent requirements for water-based paints.

Exterior Wood Finishes

Exterior finishes either penetrate wood cell walls or form films on the surface. Penetrating finishes give a more “natural” look to the wood than film-forming finishes—that is, they allow some of the character of wood to show through the finish. In general, the more natural a finish, the less durable it is. This section also discusses weathered wood as a “finish.”

Weathered Wood as Natural Finish

Leaving wood to weather to a natural finish may seem like an inexpensive low-maintenance alternative to finishing, but this approach leads to problems. Wood surfaces erode, some wood species decay, lumber is more prone to split and check, and in most climates in North America, exterior wood develops blotchy mildew growth. To avoid decay, wood must be all heartwood from a decay-resistant species such as redwood or western redcedar and be vertical grain to decrease the potential for splitting, raised grain, and cupping. Only limited areas have a climate conducive to achieving a driftwood-gray appearance as wood weathers naturally; the climate along the coast of New England seems conducive to developing the silvery-gray weathered patina that some people desire. Even when the climatic conditions favor the development of silvery-gray patina, it takes several years to achieve this appearance. Protected areas under the eaves will not weather as fast as areas that are not protected,

which leads to a different appearance at the top and bottom of a wall.

Do not leave composite wood products, such as plywood, unprotected. The surface veneer of plywood can be completely destroyed within 10 years if not protected from weathering. Figure 16–18 shows weathering of unfinished plywood (right); the intact portion of the plywood (left) had been covered with a board to give a board-and-batten appearance.

Penetrating Wood Finishes

Penetrating finishes such as transparent or clear WRPs, lightly colored WRPs, oil-based semitransparent stains, and oils do not form a film on wood. However, semitransparent stains having high-solids content may form a thin film.

Penetration into Wood

Finishes penetrate wood in two ways: flow of liquid into cut cells at the surface and absorption into cell walls.

Lumber is almost never cut aligned with axial wood cells; therefore, the surface has cut axial cells (and of course, ray cells) and, if it is a hardwood, cut vessels. Cut cells and vessels give macroscopic porosity. The diameter of lumina and vessels varies depending on the wood species, but in all species, the hollow spaces formed by cut lumina and vessels are quite large compared with pigment particles and binders in finishes (that is, a high-molecular-weight (MW) latex molecule is small compared with these openings). Any finish can easily flow into cut lumina and vessels.

Penetration of a finish into the cell wall takes place at the molecular scale. The finish or components of the finish absorb into void space of hemicelluloses, amorphous cellulose, and lignin polymers contained in the cell wall. Penetration is excellent for resins having a MW less than 1,000 Daltons. The limit to penetration into these void spaces is a MW of approximately 3,000 Daltons. Natural oils (such as linseed oil and tung oil), solvents, oil-alkyds, and low-MW polymer precursors can penetrate the cell wall and thus modify the properties of cells located near the surface. Cell walls modified with finish typically absorb less water and swell less than do unmodified cell walls.

Traditional solvent-borne finishes such as water-repellent preservatives and solvent-borne oil-based stains can penetrate cell walls. To some extent, some of the excess oil in a long-oil-alkyd primer can penetrate cell walls. High-molecular-weight polymers such as acrylics and vinyl acrylics and pigments are too large to penetrate cell walls and therefore cannot modify cell wall properties. Water in these formulations penetrates the cell wall, but the polymer does not. As water absorbs into wood, it enters the cell wall and hydrogen-bonds to the hemicelluloses and amorphous cellulose to cause swelling. Water absorption causes raised grain, and as a latex finish coalesces, the finish deforms around the raised grain while it is still flexible. Thus, latex finishes are less likely to crack if the surface develops raised grain.

Table 16–4. Suitability and expected service life of finishes for exterior wood surfaces^a

Type of exterior wood surface	Paint and solid-color stain						
	Tinted finishes such as deck finishes		Semitransparent stain		Expected service life ^d (years)		
	Suit-ability	Expected service life ^b (years)	Suit-ability	Expected service life ^c (years)	Suit-ability	Paint	Solid-color stain
Siding							
Cedar and redwood							
Smooth (vertical grain)	Low	1–2	Moderate	2–4	High	10–15	8–12
Smooth (flat grain)	Low	1–2	Moderate	2–4	Moderate	8–12	6–10
Saw-textured	High	2–3	High	4–8	Excellent	15–20	10–15
Pine, fir, spruce							
Smooth (flat grain)	Low	1–2	Low	2–3	Moderate	6–10	6–8
Saw-textured (flat grain)	High	2–3	High	4–7	Moderate	8–12	8–10
Shingles (sawn shingles used on side-walls)	High	2–3	High	4–8	Moderate	6–10	6–8
Plywood							
Douglas-fir and Southern Pine							
Sanded	Low	1–2	Moderate	2–4	Moderate	4–8	4–6
Saw-textured	Low	2–3	High	4–8	Moderate	8–12	6–10
MDO plywood ^e	—	—	—	—	Excellent ^f	12–15	10–15
Hardboard, medium density ^g							
Unfinished	—	—	—	—	High	8–12	6–10
Preprimed	—	—	—	—	High	8–12	6–10
MDO overlay	—	—	—	—	Excellent ^f	10–15	10–15
Decking							
New (smooth-sawn)	High	1–2	Moderate	2–3	Low	—	—
Weathered or saw-textured	High	2–3	High	3–6	Low	—	—
Oriented strandboard	—	—	Low	1–3	Moderate	4–5	4–5

^aEstimates were compiled from observations of many researchers. Expected life predictions are for average location in the contiguous USA; expected life depends on climate and exposure (such as desert, seashore, and deep woods).

^bThe higher the pigment concentration, the longer the service life. Mildew growth on surface usually indicates the need for refinishing.

^cSmooth unweathered surfaces are generally finished with only one coat of stain. Saw-textured or weathered surfaces, which are more adsorptive, can be finished with two coats; second coat is applied while first coat is still wet.

^dExpected service life of an ideal paint system: three coats (one primer and two top-coats). Applying only a two-coat paint system (primer and one top-coat) will decrease the service life to about half the values shown in the table. Top-quality latex top-coat paints have excellent resistance to weathering. Dark colors may fade within a few years.

^eMedium-density overlay (MDO) is painted.

^fEdges are vulnerable to water absorption and need to be sealed.

^gWater-repellent preservatives and semitransparent stains are not suitable for hardboard. Solid-color stains (latex or alkyd) will perform like paints. Paints give slightly better performance because the solids content of paint is higher than that for solid-color stains and thus paints give greater film build for the same volume of finish used.

Penetrating Clear and Lightly Colored (Tinted) Finishes

Penetrating transparent clear finishes have no pigments and the generic names for them are water repellents (WRs) or water-repellent preservatives (WRPs). A typical WR formulation contains 10% resin or drying oil, 1% to 3% wax or other water repellent, and solvent. WRPs contain a fungicide such as 3-iodo-2-propynyl butyl carbamate (IPBC). They were traditionally formulated using turpentine or mineral spirits, but now paint companies formulate them using VOC-compliant solvent and waterborne systems to comply with VOC regulations.

WRPs give wood a bright, golden-tan color close to the original appearance of the wood and are the first step in

protection from weathered wood as a finish. WRPs decrease checking, prevent water staining, and help control mildew growth. The first application of these finishes to smooth-planed lumber lasts approximately one year on exposed lateral wood surfaces; subsequent applications may last longer because weathered boards absorb more finish. WRPs absorb readily into end grain and can last for years to retard water absorption into end grain. WRPs last longer if applied to saw-textured wood.

Few companies manufacture traditional clear WRs and WRPs; almost all WR and WRP formulations are lightly pigmented and contain other additives to extend their service life (Table 16–4). Lightly pigmented finishes perform well on decks. Water- and solvent-borne formulations are available; waterborne formulations may be a water emulsion

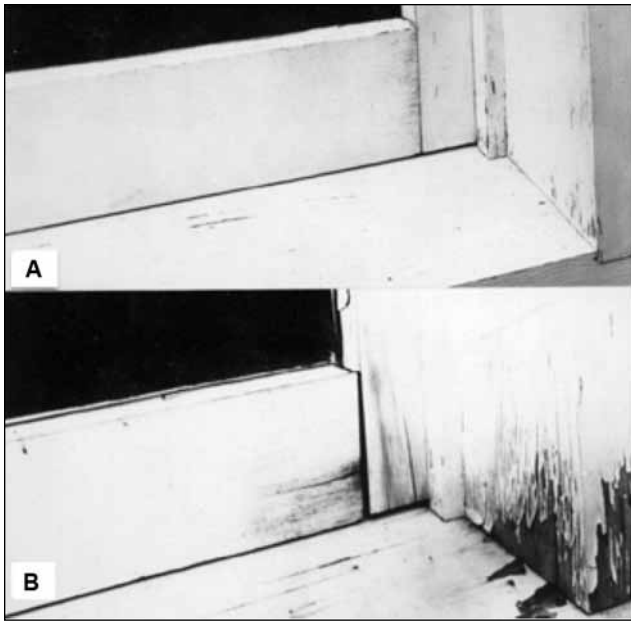

Figure 16–19. Effect of water-repellent preservative treatment after 5 years of outdoor exposure. A, window sash and frame treated with a water-repellent preservative and then painted; B, window sash and frame not treated before painting.

of synthetic polymers. Synthetic polymers do not penetrate the cell wall, but form a thin film, seal the surface, and provide water repellency. Finely ground pigment gives color and partially blocks UV radiation. Pigment, UV stabilizers, and other additives give these finishes a service life of 2 to 3 years, but they lack sufficient pigment to inhibit UV degradation of the wood. As with clear WRPs, they usually contain a preservative to retard mildew growth.

Caution: Fungicides in WRPs and semitransparent stains are toxic and may be herbicides; use caution to avoid skin contact and breathing vapors, and protect plants and the soil around them from accidental contamination.

Prior to changes in finish formulation because of VOC regulation, paint companies formulated solvent-borne WRPs for use as a pretreatment prior to priming. At this time, finding a WRP formulated for this use is difficult. In fact, paint manufacturers seldom honor a finish warranty, if customers apply a WRP prior to using their finish, particularly if a different paint company made the WRP. In spite of decades of research showing the benefits of WRP treatment of wood prior to priming, they are seldom used. Information on WRPs as a wood treatment, prior to priming, is included in this chapter in case a paint manufacturer markets a WRP specially formulated for this use in the future. They are particularly effective for improving the service life of paint on difficult-to-paint wood species and decay-prone areas (Fig. 16–19). Currently available WRPs can be used for sealing end grain

Protect wood and wood-based products from water and sunlight prior to delivery and while stored at the construction site. Avoid contaminating them with dirt, oil, or other contaminants. Finish wood as soon as possible after installing it.

of lumber, edges of plywood, and back-priming and are discussed in several sections of this chapter.

Penetrating finishes that use paraffin oil as the solvent are also available. These formulations penetrate wood, and the oil helps improve water repellency. Paraffin oil is not a volatile solvent; therefore, these finishes comply with air quality requirements. They are usually a good value, because virtually all of what comes in the can ends up in the wood. The service life is approximately 1 year, but they are easy to apply. If an excessive amount is applied, the wood surface may remain oily for a few weeks. Do not use them as a pretreatment prior to applying other finishes.

Application, New Construction

For new construction, the most effective method for applying a WR or WRP is to dip the entire board into the finish (Table 16–5). If finish is roller or spray applied, back brush following application to work the finish into the wood. Finish the back side of siding, particularly for highly colored wood species (see Back-Priming).

When wood is finished following installation, apply liberal amounts of WRP to all end grain areas, edges of panel products, and other areas vulnerable to water, such as the bottoms of doors and window frames. Coverage is approximately $6.1 \text{ m}^2 \text{ L}^{-1}$ ($250 \text{ ft}^2 \text{ gal}^{-1}$) on a smooth surface or $3.7 \text{ m}^2 \text{ L}^{-1}$ ($150 \text{ ft}^2 \text{ gal}^{-1}$) on a saw-textured surface. Smooth wood will usually accept only a single coat; a second coat will not penetrate the wood. WRP treatment lasts longer on saw-textured surfaces than on smooth surfaces because more finish penetrates the wood. As a natural finish, the life expectancy of a WRP is only 1 to 2 years, depending upon the wood and exposure. However, reapplication is easy, particularly on decks and fences.

Refinishing

Clear and lightly colored finishes (penetrating natural finishes such as WRPs and lightly pigmented deck finishes) do not peel; they fade, and if pigmented, the pigments erode. As clear finishes weather, they lose their water repellency, turn gray, and develop mildew. Lightly pigmented finishes lose color. If not blackened by mildew, they can often be prepared for refinishing by removing dirt with a stiff-bristle brush. If discolored by mildew, wash the wood with commercial mildew cleaner or dilute liquid household bleach and detergent prior to refinishing (see Mildew).

Table 16–5. Initial application and maintenance of exterior wood finishes^a

Finish	Application process	Appearance of wood	Maintenance	
			Process	Service life ^b
Water-repellent preservative (WRP)	Brush-apply 1 coat or dip. Apply a second coat only if it will absorb.	Grain visible; wood tan to brown, fades to gray with age	Brush to remove surface dirt; wash to remove mildew	1–3 years
Tinted clear finish (slightly pigmented deck finish)	Brush-apply 1 coat or dip. Apply a second coat only if it will absorb.	Grain and natural color slightly changed	Same as with WRP	2–3 years
Semitransparent stain	Brush-apply 1 coat or dip. Apply a second coat only if it will absorb.	Grain visible; color as desired	Same as with WRP	4–8 years (on saw-textured or weathered wood)
Paint and solid-color stain	Brush-, roller-, or spray-apply primer and 2 top-coats	Grain and natural color obscured	Clean and apply topcoat if old finish is sound; if not sound, remove peeled finish, prime, and apply topcoats ^d	10–20 years for paint ^e ; 6–15 years for solid-color stain ^e

^aCompilation of data from observations of many researchers.

^bVertical exposure; service life depends on surface preparation, climate and exposure, amount and quality of finish, and the wood species and its surface texture.

^cService life of 20 years if primer and two coats of top-quality latex top-coats are used on gradual transition wood species having a saw-textured surface. Dark colors may fade within a few years.

^dIf old finish does not contain lead, sand to feather rough edges of paint surrounding bare areas and areas of weathered wood (see Lead-Based Paint).

^eService life of 15 years if primer and two top-coats are used on saw-textured wood.

Refinish exterior wood when the old finish has worn thin and no longer protects the wood. If all factors are working in concert (good structure design to shed water, effective flashing, paintable wood surface, and end grain sealed), paint degradation is benign weathering of paint to expose the primer or in the case of a penetrating finish, to expose the wood surface. In these cases, there is rarely much surface preparation other than mild washing prior to refinishing. Mildew growth is not paint degradation, but an appearance problem; remove it with a commercial cleaner or bleach–detergent solution. If factors are not working in concert, paint may crack and peel.

Oil-Based Semitransparent Stains

Oil-based semitransparent stains have more pigment than tinted WRPs, and the pigment gives more protection to wood. Stains usually contain a WR and fungicide. Additional pigment maintains color and increases finish service life, but pigments give stain a less natural appearance than lightly colored finishes because they partially hide wood grain and color. Pigment content in semitransparent stains can vary, thus providing a range of UV protection and color. Most people prefer colors that accentuate the natural color of the wood.

Oil or oil-alkyd resin in oil-based semitransparent stains can flow into cut lumina at the wood surface carrying pigment with it. Some resin penetrates the cell wall; the rest remains on the surface and bonds the pigments to the surface.

Semitransparent stains are porous and do not form surface films like paints and solid-color stains; therefore, they will not blister or peel even in the presence of excessive water. Service life varies considerably depending on substrate and amount of pigment (Table 16–4).

Resin and paint manufacturers have tried to achieve the properties of solvent-borne semitransparent stains using waterborne formulations. These finishes achieve a semitransparent appearance by forming a thin coating on the wood.

Recently, paint companies have developed “semipenetrating” stains. Semipenetrating stains partially penetrate the cell wall and form a surface film. This finish is similar to a high-solids oil-based semitransparent stain.

Application, New Construction

Semitransparent stains perform well on saw-textured surfaces. If used on smooth wood, expect approximately half the service life compared with saw-textured surfaces (Table 16–4). They are an excellent finish for weathered wood.

To get consistent application and good penetration of stain, brush-apply oil-based semitransparent penetrating stains. The finish is too fluid to use a roller and spraying leads to an uneven appearance and lap-marks. Brushing works the finish into the wood and evens out the application to minimize lap marks. Lap-marks form when application of a stain overlaps a previously stained area (Fig. 16–20). Prevent lap-marks by staining two or three boards at a time and keeping a wet edge. This method prevents the front edge of the stained area from drying before reaching a logical stopping



Figure 16–20. Lap marks on wood finished with semitransparent stain.

place (corner, door, or window). If possible, work in the shade to slow drying. Coverage is approximately 4.9 to $9.8 \text{ m}^2 \text{ L}^{-1}$ (200 to $400 \text{ ft}^2 \text{ gal}^{-1}$) on smooth wood and from 2.4 to $4.9 \text{ m}^2 \text{ L}^{-1}$ (100 to $200 \text{ ft}^2 \text{ gal}^{-1}$) on saw-textured or weathered wood.

To increase service life of oil-based semitransparent stains on saw-textured or weathered lumber, apply two coats. Apply the first coat keeping a wet edge to prevent lap marks. Then, work on another area so that the first coat can soak into the wood for 20 to 60 min. Apply the second coat before the first dries (wet on wet application). (Again, apply stain keeping a wet edge to prevent lap-marks.) If the first coat dries completely, it seals the wood surface so that the second coat cannot penetrate. About an hour after applying the second coat, use a cloth, sponge, or brush lightly wetted with stain to wipe off excess stain that has not penetrated into the wood. Where stain failed to penetrate, it forms an unsightly shiny surface film. Stir the stain occasionally and thoroughly during application to prevent settling of pigment.

Two coats of semitransparent penetrating stain may last 10 years on saw-textured wood. By comparison, the life expectancy of one coat of stain on new smooth wood is only 2 to 4 years; however, as the stained wood ages, it becomes more porous and subsequent staining lasts longer (Table 16–5).

Semitransparent stain formulations have changed because of VOC regulations. Solvent systems have changed, and the amount of solids has increased. Formulations having high solids may leave excess resin on the surface (particularly the LW) even if the resin has a low MW. If the finish appears shiny an hour after application, the finish has not penetrated the wood. Remove the excess finish on the surface to avoid forming a thin film; thin films crack and peel within a year or two. Even if the wood surface has weathered or is saw-textured, it may not be possible for a second coat of these finishes to absorb into wood.

Caution: Sponges, cloths, and paper towels that are wet with oil-based stain, any other oil or oil-alkyd, or urethane finish are particularly susceptible to spontaneous combustion. To prevent fires, immerse such materials in water and seal in a water-filled air-tight metal container immediately after use.

Refinishing

Oil-based semitransparent penetrating stains degrade by slow erosion of pigments to give a gray slightly weathered appearance. Refinish when wood begins to show before all pigment is lost. Stains do not crack or peel unless excessive stain formed a film. Simply use a dry stiff-bristle brush to remove surface dirt, dust, and loose wood fibers and re-stain. As with clear finishes, remove mildew prior to refinishing. The subsequent application of penetrating stain often lasts longer than the first because it penetrates the porous weathered surface.

If oil-based semitransparent stain did not penetrate properly and formed a film, it may fail by cracking and flaking. In this case, surface preparation may involve scraping and sanding. For wood having a thick film, it may be necessary to remove all the old finish with a paint stripper prior to re-staining. This is a difficult situation; parts of the structure may have areas where the old finish eroded and the surface is weathered; parts may have an intact or peeling film. Oil-based stains do not penetrate areas having a film; film-forming finishes (paint or solid color stain) do not bond to weathered areas. Either remove the finish in places having a film and re-stain or scuff sand the weathered area, scrap and scuff sand the area having a film, and refinish with solid-color stain or paint.

When refinishing semitransparent stains, the stain must penetrate wood. As mentioned above, stain service life varies with exposure (that is, the weathering of the stain); therefore, stain may not penetrate well in some areas. For example, an area under the eaves, even on the south side of a structure, may be relatively unweathered compared with the lower part of the wall. When applying stain to such an area, feather the new stain into the old. If the stain does not penetrate the wood within an hour, remove excess stain to avoid forming shiny spots, which indicate a film. The north side of a structure may not need to be re-stained nearly as often as the south side (northern hemisphere).

Do not apply oil-based semitransparent stains over solid-color stain or paint.

Note: Do not use steel wool or wire brushes to clean wood or to prepare a surface for refinishing because they contaminate the wood with iron. Minute amounts of iron react with tannins in woods like western redcedar, redwood, and oak to yield dark blue–black stains (see Finish Failure or Discoloration).

Oils

Drying oils, such as linseed and tung, are appropriate natural finishes for indoor use and are fine for indoor furniture and other interior uses not subjected to water or high humidity. Oils perform poorly outdoors because they are natural products and therefore provide food for mildew. When used on highly colored woods such as redwood or the cedars, they tend to increase mildew growth. Even if formulated with a mildewcide, they may not give adequate performance outdoors. The original “Madison Formula” for a semitransparent stain could be formulated with up to 60% linseed oil and it contained 5% pentachlorophenol as a mildewcide. Even with this mildewcide, it was prone to develop mildew.

Film-Forming Finishes

In a range of least to most protection from UV radiation and photochemical degradation of wood, film-forming finishes are ranked as follows: clear varnish, pigmented varnish, waterborne latex semitransparent stains, solid-color stains, and paints.

Clear Varnish

Clear varnish is a transparent film-forming finish that enhances the natural beauty and figure of wood. In a book originally published in 1904, A.H. Sabin listed 16 types of varnish (architectural, cabinet, carriage, marine, and piano, to name just a few) (Sabin 1927). These varnishes were a solution of natural resins, linseed or tung oil, or both, and turpentine. In a recent publication, Wicks and others (2007) describe modern varnishes as urethane-modified alkyds. Spar varnish (a combination of novolac phenolics resin and tung and linseed oils) is also available. Urethane-based varnishes have good abrasion resistance and perform well on furniture, floors, and interior woodwork. However, varnish lacks exterior permanence unless protected from direct sunlight; varnishes in direct sunlight generally require refinishing every 1 to 2 years. Varnishes embrittle by exposure to sunlight and develop severe cracking and peeling. They last longer in protected areas, such as soffits, doors protected by porches, or the north side of structures; however, even in protected areas, apply a minimum of three coats. Staining the wood (oil-based semitransparent stain) prior to applying varnish improves its service life; the pigments in the stain decrease the photodegradation of the wood, thus maintaining varnish adhesion. Varnish is a high-maintenance finish and is not generally used on the exterior of structures.

Clear varnish usually fails by a combination of cracking and UV degradation of the wood at the wood–varnish interface. This can be identified by examining the back of a chip of varnish and finding wood fiber attached. Refinishing usually requires scraping, sanding, or power-washing the finish off and then reapplying the finish.

Pigmented Varnish

Finish manufacturers have modified clear varnish to improve exterior performance by adding finely ground inor-

ganic pigments (nanopigments). These pigments partially block UV radiation yet allow much of the visible light to pass through the finish—that is, they appear transparent. The particle size of these pigments is similar to the wavelength of UV radiation (300–400 nm), and much like dust in the atmosphere that blocks UV radiation and blue wavelengths of visible light to make the sun appear red during a sunset, pigments block UV radiation to protect wood. These products perform better than traditional clear varnishes. However, as with clear varnishes, pigmented varnish gives excellent performance in protected areas. The varnish is less prone to peel; degradation initially occurs on the film surface as crazing. Refinishing before the crazing develops into cracks restores the appearance. Eventually, however, the buildup of coats will block visible light and the wood will appear dark.

Varnish can give years of service on outdoor furniture if the furniture is covered with an opaque waterproof cover when not in use. The cover protects the varnished wood from UV degradation and discourages birds from roosting on the furniture. Several coats of varnish eliminate splinters, allow the beauty of the wood to show, and give a cleanable surface.

Waterborne Latex Semitransparent Stains

Waterborne latex semitransparent stains (introduced in the section on Oil-Based Semitransparent Stains) are discussed here because they form films. These finishes are usually an acrylic or modified acrylic and have high MW; the polymers are too large to penetrate the cell wall. Considerable confusion remains concerning penetration of these finishes. As mentioned previously, penetration of a finish into cut lumina on the wood surface is not penetration into wood. Filling the lumen does not modify the wood cells near the surface. Latex semitransparent stains give the look of an oil-based semitransparent stain by forming a thin film.

Whereas oil-based semitransparent stains slowly erode, latex semitransparent stains tend to crack and flake. The film buildup is not sufficient to give performance needed for a film-forming finish. If applied in sufficient coats to give more than a few years performance, they give the appearance of a solid-color stain. Some formulations are modified with oil-alkyds. The oil penetrates the surface, thus improving the performance of the finish. Paint companies continue to improve these formulations; check with paint suppliers for the latest information on new products.

Application, New Construction

Latex-based semitransparent stains should be brush-applied. As with oil-based semitransparent stains, they are susceptible to forming lap marks. Apply the second coat within 2 weeks after the first has dried. Latex-based stains last longer on saw-textured wood.

Refinishing

Scrape areas where the stain has flaked, wash, if necessary, and refinish. As with oil-based semitransparent stains, to avoid an uneven appearance, it may be necessary to feather the new finish into the old in areas where the old stain is still in good condition. Waterborne latex stains form a thin film and may not adhere well to weathered wood.

Solid-Color Stains

Solid-color stains are opaque finishes (also called hiding, heavy-bodied, or blocking stains) that come in many colors and are made with a higher concentration of resin and pigment than are semitransparent penetrating stains; therefore, solid-color stains obscure the natural color and grain of wood. They are available in latex-based (usually acrylic or modified acrylic polymers) and oil-based formulations. Oil and latex solid-color stains are similar to paints; they form a film.

Application

Apply solid-color stains by brush, sprayer, or roller. If using a sprayer or roller, back-brush to even out the application and work the finish into the surface, particularly on saw-textured wood. One coat of solid-color stain is not adequate for smooth wood; apply a sufficient number of coats to give a 0.10–0.13-mm (0.004–0.005-in., or 4–5-mil) dry film thickness. If applied in a single coat to smooth wood, they tend to crack and flake; the film lacks sufficient cohesive strength to accommodate moisture-driven changes in dimension of the substrate. Two coats of solid-color stain applied over a quality latex or oil primer should give service life similar to that of a good paint system on smooth-planed wood. Some manufacturers recommend using the first coat of a solid-color stain as a primer, but primer paint might be better, particularly for wood containing extractives (such as cedar and redwood). On saw-textured wood, sufficient film thickness may be possible with a single coat, but primer and one top-coat will usually give 15 to 20 years service life. Solid-color stains lack abrasion resistance and manufacturers do not generally recommend them for horizontal wood surfaces such as decks.

Refinishing

Solid-color stains can usually be applied over paint. See the following section (Paint) for additional information on refinishing. If the old finish has cracked or peeled, remove it and scuff-sand the wood prior to refinishing.

Paint

Paint appears somewhere on almost all buildings. For example, brick-, vinyl-, and aluminum-sided buildings often have painted wood trim. Paints are highly pigmented film-forming coatings and give the most protection against UV radiation. Paints protect wood surfaces from weathering, conceal some surface defects, provide a cleanable surface, offer many colors, and give high gloss (high gloss is not

possible with stains). Paint is the only finish that can give a bright white appearance. Paint retards penetration of moisture, decreases discoloration by wood extractives, and retards checking and warping of wood. However, paint is not a preservative. It will not prevent decay if conditions are favorable for fungal growth.

Paint is available in two general types: solvent-borne oil-alkyds and waterborne latexes (usually acrylic or vinyl acrylic polymers).

Oil-based paint is a mixture of finely ground inorganic pigment in a resin (binder) with additives to speed curing, improve application, and give mildew resistance. The simplest resin is a drying oil, such as linseed oil. Modern oil-based paints have the drying oil combined with a poly functional alcohol to form an oil-alkyd. Oil-alkyds for wood have excess oil (that is, long-oil-alkyds), making them more flexible than short-oil-alkyds (that is, having a shortage of oil). Oil-alkyds form a film by reacting with oxygen in the air to give a cross-linked polymeric network. Prior to regulation of the amount of organic solvent in oil-alkyds, they contained turpentine or mineral spirits. Modern oil-alkyds have complex solvent systems to meet VOC requirements.

Latex-based paint is also a mixture of finely ground pigment in a resin. The resin is a synthetic polymer, and it coalesces to form a film; these polymers do not react with oxygen. The main solvent is water, with other solvents to keep the polymer flexible while it coalesces. Acrylics and vinyl acrylics are typical resins in wood finishes.

Oil-alkyd or latex primers link wood to top-coats and provide a base for all succeeding top-coats (initial top-coats and refinishing). Primers seal the surface to prevent extractives bleed, provide adhesion between the wood and top-coats, and give color base to even out differences in wood color and top-coat color. Primers flow into void spaces at the wood surface to improve top-coat adhesion and block extractives in species such as redwood and western redcedar. At this time, oil-alkyd primers block extractives better than do latex primers, but paint manufacturers continue to improve latex primers. Oil-alkyd primers block water absorption into end grain and, to a limited extent, can penetrate wood cell walls, thus modifying the surface and improving its dimensional stability. Latex primers do not penetrate cell walls but merely flow into cut cells and vessels. Latex primers do not seal the end grain as well as oil-alkyd primers do. Latex primers are more flexible and stay more flexible; thus, they are less likely to crack as they age. Latex primers are porous and thus permeable to water and water vapor; oil-alkyd paints are less permeable to water and water vapor (Table 16–3).

Latex top-coats can be applied over oil-alkyd primers. Latex paints formulated with acrylic resins are resistant to weathering; they maintain their gloss better than oil-alkyd paints. Oil-alkyd top-coats tend to lose gloss within a year or two

and are prone to embrittle over time. Latex paints (primers and top-coats) permit water cleanup; oil-alkyd paints require organic solvents for cleanup. Sufficient dry film thickness on smooth-planed surfaces obscures wood grain and texture; on saw-textured surfaces, some surface texture remains.

Application, New Construction

On smooth-planed wood, apply a primer and two top-coats to achieve a 0.10–0.13-mm (4–5-mil) dry film thickness; on saw-textured wood, primer and one top-coat may suffice. As with solid-color stains, apply paints with brush, roller, or sprayer. If using a roller or sprayer, back-brush to get an even coating and ensure the finish wets the surface. Apply the first coat of film-forming finishes (paint, latex semitransparent stains, and solid-color stains) within 2 weeks after installing smooth-planed exterior wood products; timely application ensures good paint adhesion. Improve film adhesion to smooth-planed flat-grain products, particularly those species having abrupt grain transition, by wetting the wood to raise the grain and scuff sanding (lightly sanding with 50–80 grit sandpaper) after it dries.

For woods with water-soluble extractives, such as redwood and western redcedar, primers block extractives bleed into the top-coat. Use a primer that is labeled to “block extractives bleed,” usually an oil-alkyd-based paint. Some manufacturers also formulate stain-blocking acrylic-latex primers. Allow latex stain-blocking primer to dry for at least 24 to 48 h before applying the first top-coat. If the primer has not fully coalesced, extractives may bleed into the top-coat. For species, such as pine, that do not tend to have extractives bleed, a quality primer is still necessary to give a good base for top-coats. Follow the application rates recommended by the manufacturer to achieve sufficient film thickness. A uniform primer coating having sufficient thickness distributes wood swelling stresses and thus helps prevent premature paint failure. Primer should cover approximately 6.1 to 7.4 m² L⁻¹ (250 to 300 ft² gal⁻¹) on smooth unfinished wood; coverage is considerably less on saw-textured wood.

Apply two coats of acrylic latex paint over the primer. If applying two top-coats to the entire structure is not practical, consider two top-coats for fully exposed areas on the south and west sides and a single top-coat on other areas. Two top-coats over a properly applied primer should last more than 10 years on smooth wood (Tables 16–4 and 16–5) and many three-coat paint systems in test at FPL have lasted 20 years. To avoid peeling between paint coats, paint manufacturers recommend applying the first top-coat within 2 weeks after the primer and the second top-coat within 2 weeks of the first. If more than 2 weeks elapse between paint coats, it may be necessary to wash the paint with mild detergent and rinse thoroughly. If the primer has been exposed for several months, it may need to be primed again prior to applying the top-coats. However, some primer may not weather as quickly and some top-coats may adhere well to weathered primer; check with manufacturers for information on their products.

Avoid applying oil-alkyd paint to a hot surface in direct sunlight and to a cool surface that the sun will heat within a few hours. The heat causes the surface of the coating to dry, trapping solvent in the film. The trapped solvent forms a “temperature blister,” which usually occurs within a day or two after painting. They do not contain water. Do not cool the surface by spraying with water.

Apply latex-based waterborne paints when the temperature is at least 10 °C (50 °F) and expected to remain above this temperature for 24 h. (The dew point is a good estimate of nighttime low temperature.) Most latex paints do not coalesce properly if the temperature drops below 10 °C (50 °F). Oil-alkyd paint may be applied when the temperature is at least 4 °C (40 °F). Check with paint manufacturers on the temperature requirements because some paints can be applied at lower temperatures than these. As with oil-alkyd paints, avoid painting hot surfaces in direct sunlight. Prior to applying latex paints, the surface can be cooled with water spray and allowed to dry.

Avoid painting late in the afternoon if heavy dew is expected during the night. Water absorption into partially cured oil-alkyds or partially coalesced latexes can cause wrinkling, fading, loss of gloss, and streaking.

Refinishing

In the absence of catastrophic failure such as cracking, flaking, and peeling, solid-color stains and paints slowly erode. A three-coat finish system (0.10–0.13 mm thick) may last 20 years on saw-textured wood. When the top-coats begin to wear thin exposing the primer, reapply one or two new top-coats. One coat may be adequate if the old paint surface is in good condition. Surface preparation merely involves washing the surface to remove mildew, dirt, and chalk. Paint erodes at different rates, depending on the exposure to sunlight; therefore, different sides of a structure do not need to be painted on the same schedule. Paint on the north side lasts twice as long as that on the south side (northern hemisphere). When repainting, coverage should be approximately 9.8 m² L⁻¹ (400 ft² gal⁻¹).

Clean areas that are protected from sun and rain, such as porches, soffits, and walls protected by overhangs. These areas tend to collect dirt that decreases adhesion of new paint. Repainting protected areas every other time the structure is painted usually gives adequate performance.

Do not paint too often. If paint is sound, but discolored with mildew, wash it. It does not need repainting. Frequent repainting may form an excessively thick film; thick oil-based paint is likely to crack across the grain of the wood (see Cross-Grain Cracking). Latex paints seldom develop cross-grain cracking because they are more flexible than are oil-based paints. Since latex paints have replaced oil-based top-coats for most exterior applications, cross-grain cracking is rare except for latex paint applied over thick oil-based

paint. However, too many coats of latex paint can eventually lead to adhesion failure of the primer.

In situations where catastrophic failure has occurred, refinishing paint and solid-color stains may require extensive surface preparation. First, scrape off all loose paint. **In the absence of lead-based paint**, sand areas of exposed wood with 50- to 80-grit sandpaper to remove the weathered surface and to feather the abrupt paint edge. Wash the remaining old paint using a commercial cleaner or a dilute household bleach and detergent solution to remove dirt and mildew and rinse thoroughly (see Mildew). Prime the areas of exposed wood, then top-coat. If the old paint has excessive chalking, it may be necessary to re-prime (see Chalking).

Note: Do not sand lead-based paint. Use special precautions if the old paint contains lead (see Lead-Based Paint).

Table 16–4 summarizes the suitability and expected life of commonly used exterior finishes on several wood species and wood-based products. The information in these tables gives general guidelines. Many factors affect paintability of wood and service life of wood finishes. Table 16–5 summarizes the properties, treatment, and maintenance of exterior finishes.

Application of Finishes, Special Uses

Porches, Decks, Deck Railings, and Fences

Porches get wet from windblown rain; therefore, apply a WRP or primer to end grain of flooring, railings, posts, and balustrade prior to or during construction. Primers and top-coats for porch floors are formulated to resist abrasion.

Decks are usually finished with penetrating clears, lightly pigmented clears, or semitransparent stains. These finishes need more frequent application than does paint but do not need extensive surface preparation, because they seldom fail by cracking and peeling. Limit the application of semitransparent stain to what the surface can absorb. The best application method is by brush; roller and spray application may put too much stain on horizontal surfaces. Unless specially formulated for use on decks, solid-color stains should not be used on decks or porches because they lack abrasion resistance and they tend to fail by peeling.

Like decks, fences are fully exposed to the weather, and some parts (such as posts) are in contact with the ground; therefore, wood decay and termite attack are potential problems. Use lumber pressure-treated with preservatives or naturally durable wood species for all posts and other fence components that are in ground contact. When designing and constructing fences and railings for decks and porches, architects and contractors need to consider protecting exposed end-grain of components to resist water absorption.

Film-forming finishes on fences and railings trap moisture if the end grain is not sealed during construction. Figure 16–14 shows a railing 8 years after construction. Water flowed down the railing and absorbed into the end grain, and the paint kept the wood from drying. If railings are to be painted, seal the end grain or use pressure-treated wood, particularly where decay of wood is a safety hazard (railings on decks and porches high off the ground).

Concerning the service life of naturally durable wood species compared with wood pressure-treated with preservatives, there are no absolute “rules.” However, for in-ground contact uses and structural components of decks and porches (beams, joist, and railings), pressure-treated wood is probably better and may be a code requirement in some areas. The service lives of naturally durable and preservative-treated woods are quite comparable in aboveground exposures, such as decking boards. In selecting wood for porches, decks, and fences, whether preservative treated or a naturally durable species, consider the exposure conditions, design of the structure, properties of the wood, and the finish to be used. Wood weathering can be as much a factor in long-term service life of decks and fences as decay. Protect naturally durable wood species and preservative-treated wood with a finish. Periodic treatment with a penetrating sealer, such as a WRP or lightly pigmented deck finish will decrease checking and splitting. Pigmented finishes retard weathering.

Treated Wood

Copper-based preservatives (copper azole, ammoniacal copper quat (ACQ), ammoniacal copper zinc arsenate (ACZA), chromated copper arsenate (CCA)), creosote, and pentachlorophenol are common factory-applied preservatives. Of these, wood treated with copper azole and ACQ is often used to construct porches, decks, and fences. The treatment has little effect on finishing once the wood has dried; species and grain orientation affect finishing more than preservative treatment does. Waterborne treatments containing copper may maintain a brown color for approximately 2 years. Some copper-based preservatives may have a water repellent included in the treatment to give the treated wood better resistance to weathering. Even if the manufacturer treated the wood with water repellent, maintain it with a finish to extend its service life. People often replace decking because of weathering, not decay.

Creosote and pentachlorophenol are generally used for industrial and commercial applications where applying a finish is not considered practical. Creosote is oily, and wood treated with creosote does not accept a finish. Pentachlorophenol is often formulated in heavy oil. Wood treated with preservatives formulated in oil will not accept a finish.

Marine Uses

The marine environment is particularly harsh on wood because of wind-blown salt spray, abrasion by sand, and direct and reflected UV radiation. Any of the types of finish discussed previously can be used in marine environments.

Chapter 16 Finishing of Wood

WRPs, tinted clears, and oil-based semitransparent stains give some protection; however, a paint system gives the best protection against photochemical degradation. If possible, finish wood with a WRP prior to painting. Consult paint manufacturers for products formulated for marine use.

Note: Any wood in contact with water must be pressure treated to specifications for marine use. Chromated copper arsenate (CCA) is still used in marine environments, and the chromium in the formulation improves the performance of stains and paints.

Boats

Varnish enhances the appearance and protects wood trim on boats (hence the name spar varnish), but it is exposed to more sunlight and water than on structures. Therefore, it needs regular and frequent refinishing. Paint manufacturers recommend three to six coats for best performance.

Applying oil-based semitransparent stain to wood prior to varnishing increases the service life of the varnish, but the stain obscures some of the color of the wood. Keeping the appearance of wood trim bright and new is labor intensive but often well worth the effort.

Finish hulls with marine paint (two-part epoxy- or urethane-paint). Protect areas below the water line with antifouling paint. Consult manufacturers for information on these products.

Panel Products

The edges of panel products such as plywood, OSB, and fiberboard are vulnerable to absorption of water. To minimize edge swelling and subsequent finish peeling, seal the edges of these products with a WRP, oil-alkyd primer, or sealer formulated for this use. The type of edge sealer depends on the surface finish. Prior to staining (oil-based semitransparent stain), seal with the stain or a WRP; prior to painting (paint or solid-color stain), seal with an oil-alkyd primer.

Plywood siding products may have a saw-textured surface (such as T1–11 siding) or a paper overlay (MDO). Saw-textured surfaces may be finished with oil-based semitransparent stain, solid-color stain, or paint. Paint gives the longest service. Paper overlay products will not accept a penetrating finish (such as oil-based semitransparent stain); finish with paint or solid-color stain.

During pressing of OSB and fiberboard panels for exterior use, manufacturers usually include MDO. The panels are cut to give lap siding. The MDO protects the surface from moisture and gives a good surface for film-forming finishes. However, as with plywood, the edges and areas around fasteners are vulnerable to water absorption and need to be sealed.

Fire-Retardant Coatings

Fire-retardant finishes have low surface flammability, and when exposed to fire, they “intumesce” to form an expanded

low-density film. The expanded film insulates the wood from heat and retards combustion. The finishes have additives to promote wood decomposition to charcoal and water rather than flammable vapors.

Back-Priming

Back-priming is applying primer or WRP to the back side of wood (usually siding) before installing it. Back-priming with stain-blocking primer retards extractives staining, particularly run-down extractives bleed. It decreases absorption of water, thus improving dimensional stability. Siding is less likely to cup, an important consideration for flat-grain wood. Improved dimensional stability decreases stress on the finish, thus decreasing paint cracking.

At the time siding is back-primed, seal end grain with oil-alkyd primer. This process has an even greater effect in stopping water absorption than back-priming. Primed end-grain eliminates paint failure near the ends of boards. Prime ends cut during installation.

Factory Finishing

Factory priming hardboard siding has been a standard industry practice for many years, and recently, factory-finished (primer and top-coats) siding, trim, and decking have become common. Factory finishing offers several advantages: avoids finishing during inappropriate weather, gives consistent film thickness, contributes to timely completion of structures, and decreases overall cost. Factory finishing is advantageous in northern climates where exterior finishing is impossible during the winter. Controlled application ensures consistent 0.10 to 0.13 mm (4 to 5 mil) dry film thickness. Siding is normally primed on all sides, including the end grain. When installing factory-finished siding, prime following cross-cuts. Controlled conditions enable many factory finishers to guarantee their products against cracking, peeling, and blistering for 15 years.

Finish Failure or Discoloration

Properly applied to a compatible substrate on a well-designed and constructed structure, finishes rarely fail prematurely. In the absence of finish failure (cracking and peeling) or discoloration (extractives bleed, iron stain, and mildew growth), finishes undergo a slow erosion lasting several years—even decades. This section is about “when things go wrong”.

The most common causes of premature failure of film-forming finish (paint and solid-color stains) are water, weathering of wood prior to painting, inadequate surface preparation, and insufficient film thickness. Structure design, wood species, and grain angle can also affect performance. Topics covered in this section are paint cracking (parallel to grain), cross grain cracking, peeling, intercoat peeling, chalking, mill-glaze, mildew, blue stain, iron stain, and brown stain over knots.

Exterior paint is subject to wetting from rain, dew, and frost. Equally serious is “unseen moisture” (water vapor) that moves from inside to outside structures in cold climates and from outside to inside of air-conditioned buildings in hot climates. Effective air and vapor barriers can minimize water vapor movement (see Chapter 13).

Paint Cracking (parallel to grain)

Cracking parallel to grain occurs on smooth flat-grain lumber, particularly with wood species having abrupt transition between EW and LW bands (such as southern yellow pine, Douglas-fir, and oak). LW bands are compressed into EW during planing. Normal rebound of LW bands after wood is in service causes films to crack along the EW–LW boundary. Other contributing factors are coatings having insufficient thickness and lacking flexibility. If the cracking is not too severe, scuff sand and apply one or two top-coats to give additional film-build.

Peeling and Flaking

Peeling and flaking (adhesion failure between wood and the primer) can have several causes: water, wood weathering, and dimensional change of thick LW bands on flat grain of high-density wood species. Flaking often follows cracking; small cracks in paint caused by raised grain allow water to enter. Flaking is similar to peeling; small pieces of finish peel from the surface usually along an EW–LW boundary. Flaking often occurs with cracking parallel to grain and is attributed to thin films. It can occur with thinly applied film-forming finishes and with oil-based semitransparent stains if they do not absorb properly. Water is the main cause, but other factors can also cause it.

Water speeds the failure by other causes. One cause is weathering of wood prior to primer application. Protect wood from the weather prior to installation and paint it as soon as possible after installing it. Leaving smooth-planed lumber exposed to the weather for as little as 2 weeks decreases its paint-holding properties. If wood was exposed more than 2 weeks, scuff sand it prior to painting. In fact, scuff sanding is always a good idea on planed lumber. The wide bands of LW on flat-grain surfaces hold paint poorly. If possible, flat-grain boards should be installed “bark-side” out to minimize raised grain particularly with wood species having abrupt EW/LW transition. Paint applied to weathered wood often fails over large areas and can be easily diagnosed by inspecting the back side of the peeled paint. Wood fibers are attached to the film clearly showing the grain of the wood.

Priming end grain with oil-alkyd paint eliminates peeling at the ends of boards. Saw-texture greatly improves finish adhesion to all species and grain angles. Paint and solid-color stains adhere quite well to difficult-to-paint wood species such as flat-grain southern yellow pine, Douglas-fir, and radiata pine, if applied to saw-textured surfaces.



Figure 16–21. Water blisters (also called moisture blisters) caused bubble-like deformation of paint film.

Cross-Grain Cracking

Modern waterborne latex finishes seldom fail by cross-grain cracking. If latex finishes crack across the grain, dimensional instability of wood under the finish causes it. For example, cross-grain checking of juvenile wood causes paint to crack. In this case, replace the board and repaint.

If juvenile wood is not to blame, cross-grain cracking usually occurs on structures having thick layers of oil-alkyd paint. If the wood is not the cause of paint failure, remove the old paint and apply new finish to the bare wood. Old paint probably contains lead (see Lead-Based Paint).

Water Blisters

Water Blisters (also called moisture blisters) are bubble-like deformation of paint films (Fig. 16–21). As the name implies, these blisters usually contain water when they form. Water blisters form between the wood substrate and the first coat of paint. After the blisters appear, they may dry out and collapse. Small blisters may disappear completely and large ones may leave rough spots; in severe cases, the paint peels. Oil-alkyd paint recently applied to wet wood is most likely to blister. Old paint films are too rigid to swell and form blisters; they usually crack and peel. Water blisters are not common on latex paint systems.

Minimizing water absorption into wood is the only way to prevent water blisters. Water blisters may occur on siding and trim where rain enters through improperly flashed doors, windows, and vents; they are common near unsealed end grain of siding and trim. Water from ice dams and overflow from blocked gutters can also cause water blisters. Movement of water vapor from the inside of a structure to siding and trim may also cause water blisters. Plumbing leaks, humidifiers, and shower spray are sources of inside water. Minimizing water absorption also prevents decay (rot), warping, and checking of wood.

Mill Glaze

Since the mid-1980s, a condition known as “mill glaze” (also called planer’s glaze) has been reported to cause paint

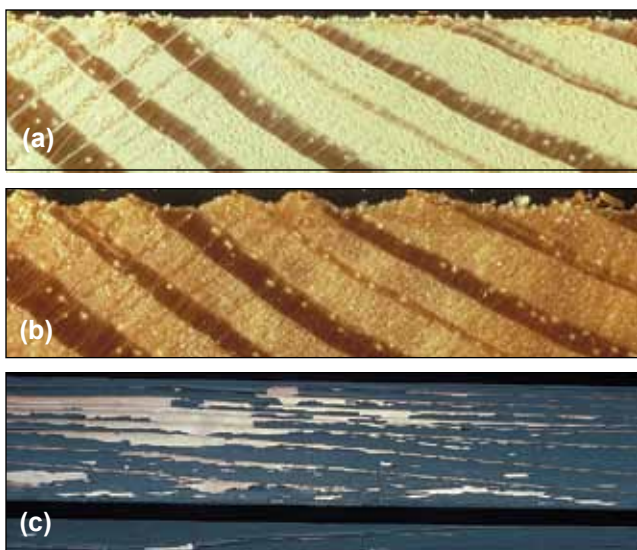

Figure 16-22. (a) Cross-section view of flat-grain southern yellow pine showing dense LW bands crushed into less dense EW directly beneath them; (b) raised grain caused by rebound of LW bands following wetting; (c) a thin coat of film-forming finish applied over a stressed flat-grain surface will crack as the wood rebounds.

failure. Controversy exists over the exact cause of this condition, and many people use it as a catch all for unexplained paint failures. They attributed the paint failure to dull planer blades or excessive heat during planing. However, investigations of reported mill glaze by FPL scientists showed that other factors caused finish failure; scientists were unable to duplicate mill glaze in the laboratory. FPL scientists found three causes for paint failures that others had attributed to “mill glaze”: (1) raised grain under a thin film, particularly on smooth flat-grain lumber, (2) wood weathering prior to application of film-forming finishes, and (3) moisture (usually water). These factors often occurred together.

Paint failure occurred because of raised grain on flat-grain boards, particularly on species having abrupt EW–LW transitions. Planer blades tend to crush dense LW bands into less dense EW that lie directly beneath them on flat-grain surfaces (Fig. 16-22a). Later, when these boards are exposed to moisture, crushed EW absorbs moisture and rebounds, which causes the surface LW bands to protrude from the surface (Fig. 16-22b). A thin coat of film-forming finish applied over a stressed flat-grain surface will crack as the wood rebounds (Fig. 16-22c; see Paint Cracking). Failure is most common on flat-grain siding finished with insufficient film build of oil-based solid-color stain. Thin coatings of oil-based solid-color stain and to some extent waterborne latex stains are weak and do not withstand the stresses caused by raised grain. These low-solids coatings provide only 0.03 to 0.05 mm (1 to 2 mil) of dry-film thickness, whereas a brush-applied three-coat paint system (primer and two top-coats)



Figure 16-23. Intercoat peeling of paint, usually caused by poor preparation of old paint surface or excessive weathering of primer prior to application of top coat.

provides 0.10 to 0.13 mm (4 to 5 mil) of dry-film thickness. Raised grain is less likely to occur with vertical-grain wood because the EW–LW bands are perpendicular to the surface and the EW is not crushed during planing.

Install flat-grain bevel siding saw-textured side out. Saw-textured surfaces do not have LW bands compressed into the EW. The saw-textured side is the side of choice for application of penetrating semitransparent stains and film-forming finishes. The film buildup on the saw-textured side will be greater than on a planed surface, and the film will have greater mechanical adhesion or “bite.”

If flat-grain siding must be installed smooth-side out, remove the planing stresses by wetting the surface, then allow 2 to 3 days for the surface to dry. Scuff-sand the surface with 50- to 80-grit sandpaper and apply primer and two top-coats.

Another paint failure that has been attributed to “mill glaze” is peeling caused by wood weathering prior to applying film-forming finishes (see Weathering, Effect on Paint Adhesion). Water causes paint to peel (see Peeling and Flaking and Water Blisters).

Intercoat Peeling

As the name implies, intercoat peeling is loss of adhesion between coats of finish, usually peeling of a new paint from old paint (Fig. 16-23). It usually occurs within a year of repainting. Prevent intercoat peeling by ensuring that old paint is free of dirt, mildew, and chalk prior to repainting.

Intercoat peeling can also result from allowing too much time between applying primer and top-coat. If more than 2 weeks elapse between applying an oil-based primer and a top-coat, clean the surface before applying the second coat. If the primer (particularly oil-alkyd primers) has weathered for several months, it may be necessary to re-prime prior to applying the top-coats (see Testing for Adhesion).



Figure 16–24. Mildew is most common in shaded, moist, or protected areas (a) on wood and (b) on painted wood.

Chalking

Weathering of paint causes chalking; chalk is a residue of degraded resin and pigments. These degradation products form a fine powder. Some chalking is desirable because it allows the paint to self-clean. However, chalking is objectionable when the degradation products (especially the pigments) wash down a surface having a different color or when it causes premature paint failure through excessive erosion. Most paints chalk to some extent, but chalking is minimal with modern latex paints.

Latex paint or solid-color stain can be applied over existing paint if the old paint is clean and sound (chalk free). Prior to refinishing a chalky surface, scrub it thoroughly with a detergent solution to remove degraded finish residue and dirt. Rinse thoroughly before repainting. To check for excessive chalking, lightly rub the paint surface with a dark (for light-colored paint) or white (for dark-colored paint) cloth. The amount of pigment removed by the cloth is a good indication of chalking. If the surface is still chalky after cleaning, it may need to be primed prior to repainting. Otherwise, the new paint may peel. Before repainting surfaces, conduct a simple test (see Testing for Adhesion).

Testing for Adhesion

After preparing old paint for repainting, repaint a small inconspicuous area and allow it to dry at least overnight. To test for adhesion, firmly press one end of an adhesive bandage onto the repainted surface. Remove the bandage with a snapping action. If the tape is free of paint, the new paint is well-bonded to the old surface and does not need priming or additional cleaning. If the new latex paint adheres to the tape, the old surface is too chalky and needs additional cleaning or priming with an oil-alkyd primer. If both the new latex paint and the old paint coat adhere to the tape, the old paint is not well bonded to the wood and must be removed before repainting. You should test several areas of the structure to determine the extent of poor paint bonds before stripping all the paint.

Mildew

In the absence of catastrophic paint failures described above, mildew is probably the most common problem with finishes. Mildew is the term for fungi that infect wood (Fig. 16–24a) and painted wood (Fig. 16–24b). These microorganisms can live on any surface that supplies a food source from either within the material or from air or liquids that contact the surface. Although the organisms cannot decay wood, they can metabolize some of the extractives in wood and natural oils (such as linseed oil) in finishes. They usually discolor wood or finishes with black deposits and often grow in combination with algae (usually green discoloration).

Mildew may be found anywhere on a building and is common on walls behind trees or shrubs where air movement is restricted and walls stay damp. Mildew may also be associated with dew patterns of structures. Dew forms on parts of structures that cool rapidly, such as eaves, soffits, and ceilings of carports and porches. The dew provides a source of water for mildew.

Mildew can be distinguished from dirt by examining it with a 10× magnifying glass (such as a jeweler’s eye loupe). In the growing stage, when the surface is damp or wet, the fungus has threadlike growth. In the dormant stage, when the surface is dry, the fungus has numerous egg-shaped spores; by contrast, granular particles of dirt appear irregular in size and shape. A simple test for the presence of mildew on wood or paint is to apply a drop or two of liquid household bleach (5% sodium hypochlorite) to the discolored area. The dark color of mildew will usually bleach out in 1 to 2 min. Surface discoloration that does not bleach is probably dirt, extractives bleed, or iron stain. Mildew can grow through a surface coating or under a clear finish. In these cases, it may be difficult to test for or to clean the mildew; the finish protects the mildew from the cleaning solution.

To remove mildew, use a commercial cleaner or a dilute solution of household bleach with detergent. If using household bleach, use as dilute a solution as possible. One part

bleach to five parts water should be adequate. In no case should a mixture stronger than one part bleach to three parts water be necessary. Add a little powdered detergent to help remove the dirt. Do not use liquid detergent because it may contain ingredients that react with bleach to give toxic fumes. Gently scrub the surface with a bristle brush or sponge and rinse thoroughly. Rinse using a garden hose, keeping the water stream pointed down to avoid flooding the back side of siding with water. If using a power-washer, keep the pressure low to avoid damaging the wood and, as with the garden hose, keep the water stream pointed down. Refinish the cleaned surface as soon as it has dried using a finish containing a mildewcide.

Household bleach mildew remover

- 1 part (5%) sodium hypochlorite (household bleach) (1 gallon)
- 3 to 5 parts warm water (3–5 gallons)
- A little powdered household detergent (1/2 cup)

Warning: Do not mix bleach with ammonia or with any detergents or cleansers that contain ammonia. Mixed together, bleach and ammonia form a toxic combination, similar to mustard gas. Many household cleaners contain ammonia, so be careful in selecting the type of cleaner to mix with bleach. Avoid splashing the cleaning solution on yourself or plants.

Loss of Gloss and Fading

Loss of gloss and fading typically occurred with traditional oil-alkyd finishes. Although modern acrylic-based latex finishes do not give the high gloss of an oil-alkyd, they maintain gloss much longer. Some pigments fade more than others; check with the paint manufacturer to ensure that the colors will last. White is always a safe choice. The paint and solid-color service-life estimates given in Tables 16–4 and 16–5 do not take into account loss of gloss and fading. Many dark-colored finishes will fade to give unacceptable performance long before the finish fails.

Water-Soluble Extractives

In many hardwoods and softwoods, the heartwood contains water-soluble extractives. (Sapwood does not contain water-soluble extractives.) Western redcedar and redwood are two common softwoods that contain highly colored water-soluble extractives; extractives give these species their attractive color, but they can also discolor paint. When wood gets wet, water dissolves some extractives; then as the wood dries, water carries water-soluble extractives to the surface. The water evaporates leaving extractives behind as a reddish brown stain. Discoloration shows in two ways: diffused and run-down extractives bleed.

Diffused extractives bleed is caused by (1) water from rain and dew that penetrates a porous or thin paint coating, (2) water that penetrates joints in the siding, railings, or trim,

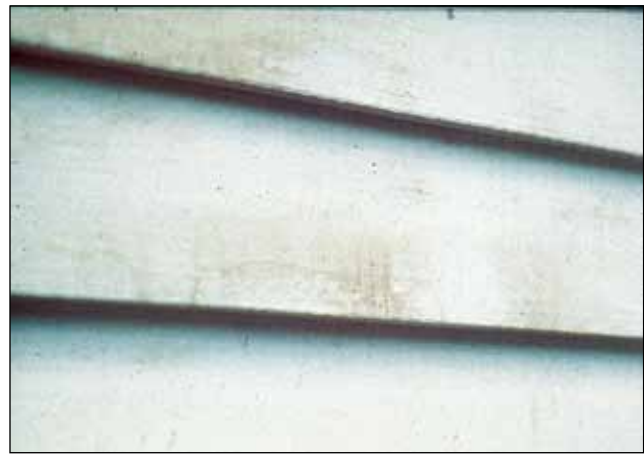

Figure 16–25. High moisture content of wood can cause diffuse extractives bleed, particularly if a stain-blocking primer is not used.



Figure 16–26. Water-soluble extractive discoloration can result from water wetting the back of the siding and then running down the front of the board.

and (3) absorption of water vapor in high humidity areas such as bathrooms, swimming pools, and greenhouses (Fig. 16–25).

Good painting practices prevent diffused extractives bleed. Use an oil-alkyd stain-blocking primer or a latex primer formulated for use over woods like redwood. Do not use porous paints such as flat alkyds or latexes directly over extractive-rich woods. If the wood is already painted and is discolored by extractives, clean the surface and apply a stain-blocking primer. Allow sufficient time for the primer to cure so that it blocks the extractives, and then apply top-coat.

Run-down extractives bleed is caused by (1) water draining behind siding from roof leaks, faulty gutters, or ice dams, (2) condensation of water vapor, originating inside the structure, on the back side of siding, and (3) wind-blown water that wets the back side of siding. The water on the back side of the siding dissolves extractives and runs off of the back



Figure 16–27. Blue stain may infect sapwood.

side of the siding onto the front side of the siding below it, where it evaporates leaving red streaks (Fig. 16–26).

Prevent run-down extractives bleed by (1) fixing roof leaks, maintaining gutters, and preventing ice dams, (2) decreasing condensation or the accumulation of moisture in wall by lowering indoor humidity and installing effective air barriers in wall systems, (3) designing structures having adequate roof overhang to minimize wetting by dew and wind-blown rain, (4) back-priming siding prior to installation with a stain-blocking primer, and (5) using rain-screen construction to vent the back side of siding (see Back-Priming).

By eliminating the cause of extractives bleed, the discoloration will usually weather away in a few months. However, extractives in protected areas (under the eaves, soffits, and porch ceilings) become darker and more difficult to remove with time. In these cases, wash the discolored areas with a mild detergent soon after the problem develops. Paint cleaners containing oxalic acid may remove stains.

Blue Stain

Blue stain is a fungus that can infect sapwood of trees and logs (Fig. 16–27). Insects, such as the pine beetle, may carry it into a living tree. Pine beetle infestation often disrupts the flow of nutrients, thus killing the tree. Sapwood of lumber from beetle-killed trees usually contains blue stain. Blue stain may also infect logs after harvest while the MC is still high. The fungus causes a blue discoloration of the wood, but the organism does not weaken wood structurally. The fungus lacks the enzymes necessary to digest wood polymers; it lives off the unpolymerized sugars in the sapwood (see Chap. 14). Neither commercial mildew cleaners nor household bleach with detergent can remove it. If the color is objectionable, use a pigmented finish to hide it (see Mildew).

Effective control of blue stain takes place prior to using lumber at the construction site: maintain healthy forests,

apply fungicides to logs while in storage prior to cutting lumber, use kiln dry lumber, and keep lumber dry.

Iron Stain

Iron stains occur from rusting of fasteners or by the reaction of iron with tannins in wood. The appearance is different for each of these reactions.

In wood species that lack tannins, iron merely rusts, giving a brown stain to the wood surrounding the fastener. The iron also causes slight degradation of the wood near it (often referred to as “wood sickness”). This discoloration develops over many months or years of exposure.

In those wood species that have tannins, a chemical reaction takes place between the iron and the tannins. Tannins are just one of the many chemicals (extractives) in wood. Species such as the cedars, the oaks, and redwood are rich in tannins. Iron reacts immediately with the tannins to give a blue-black discoloration.

Steel fasteners are the most common source of iron (Fig. 16–28), but traces of iron left from cleaning wood with steel wool or wire brushes cause iron stain. Poor quality galvanized nails corrode easily and, like uncoated steel nails, usually cause unsightly staining of the wood.

If iron stain is a serious problem on a painted surface, countersink the fastener, caulk, spot prime, and top-coat. This costly and time-consuming process is only possible with opaque finishes. Little can be done to give a permanent fix to iron stains on wood having a natural finish. Removing fasteners, cleaning the affected areas with oxalic acid solution, and replacing the fasteners may not give a permanent fix because residual iron left behind continues to cause staining. Removing the fasteners often splits the siding. Using the wrong fastener can be costly—it may become necessary to replace all the siding (Fig. 16–28). Use corrosion-resistant fasteners such as stainless steel rather than risk iron stain, particularly when using natural finishes on wood containing high amounts of tannin (such as western redcedar, redwood, and oak). If using galvanized fasteners, they must be hot-dipped galvanized fasteners meeting ASTM A 153/A specification. Other galvanized fasteners fail. Unfortunately, contractors and their employees may have difficulty recognizing the difference among galvanized fasteners (Fig. 16–28).

Iron stain occurring beneath a finish is extremely difficult to fix. The coating must be removed before the iron stain can be removed. Oxalic acid will remove the blue–black discoloration. Apply a saturated solution (0.5 kg of oxalic acid per 4 L (1 lb gal⁻¹) of hot water) to the stained surface. Many commercial brighteners contain oxalic acid, and these are usually effective for removing iron stains. After removing the stain, wash the surface thoroughly with warm water to remove the oxalic acid. If even minute traces of iron remain, the discoloration will recur.



Figure 16-28. Iron stain on newly installed wood siding. Poor quality galvanized nails corrode easily and, like uncoated steel nails, usually cause unsightly staining of the wood.



Figure 16-29. Pitch flow from wound.

Caution: Oxalic acid is toxic; take care when using it. (It is the poison in rhubarb leaves.)

Knots

Knots in many species contain an abundance of resins and other highly colored compounds. These compounds can sometimes cause paint to peel or turn brown. Eliminating paint discoloration caused by extractives in knots is difficult because some of the extractives are soluble in oil-based primers and diffuse through them. Latex-based formulations do not block them either. Coat the knot with shellac or specially formulated knot sealer. Do not use varnish to seal knots; varnish is not formulated for this use. After sealing knots, apply primer and two top-coats. Knots usually check as wood dries; if the checks form after the wood has been

painted, the checks cause the paint to crack (see Wood Extractives).

Pitch

Pitch and other resins are one of the defense mechanisms that a tree uses to protect itself from harmful pathogens and insects following injury. When a tree's bark is damaged, pitch flows into these areas to protect the wound (Fig. 16-29). Pitch exists as a normal part of the wood of pines (*Pinus* spp.), spruces (*Picea* spp.), larches (*Larix* spp.), and Douglas-firs (*Pseudotsuga* spp.), and it can be found in specialized wound structures called pitch pockets in the wood of most softwood species. Pitch is a solution of natural rosins and turpentine in species such as spruce, pine, and fir. It remains in the lumber from these species. The ease with which it exudes to the surface of lumber depends on the amount of turpentine in which the pitch is dissolved and the temperature (that is, the more turpentine, the more fluid the pitch; the higher the temperature, the more fluid the pitch). Pitch exudation can occur in isolated spots (Fig. 16-30a) or in large pockets or seams (Fig. 16-30b). When pitch bleed occurs, high temperature is the cause. If the temperature at the surface of the wood increases, usually from being exposed to direct sunlight, the pitch oozes to the surface. If the wood is finished, the pitch may exude through the coating or cause the finish to discolor or blister.

The only way to prevent pitch bleed is to remove the turpentine from the wood during lumber processing. Depending on the species, specific kiln schedules can be used to drive off most of the turpentine, thus "fixing" or "setting" the pitch (making it less fluid). However, not all end uses of lumber require pitch to be set; construction grades of lumber, even if kiln-dried, seldom have the pitch set. This is usually not a problem for construction grades because the wood surface is seldom visible. The difficulty occurs with appearance grades of lumber, such as for siding and trim.

Kiln schedules for setting pitch involve higher temperatures and last longer than normal drying schedules. For a complete guide to drying schedules, refer to publications such as the *Dry Kiln Operator's Manual*.

Pitch can be removed in several ways, depending on how fluid it is. If the pitch has not hardened (it still contains a lot of turpentine), remove it with turpentine or mineral spirits. Once it has hardened, scrape it off with a putty knife or paint scraper. However, if the pitch is still soft, such procedures smear it over the surface of wood or paint. Let it harden, and then scrape it off. After removing pitch, sand to bare wood, spot prime, and top-coat. Shellac seals extractives but not pitch. Paint will not prevent future bleeding of pitch during periods of high temperature. If pitch is a recurring problem, it may be necessary to replace the board. One should note that many paints, particularly oil-alkyds, fade as they age and repainting the spots where pitch was removed may show color differences.

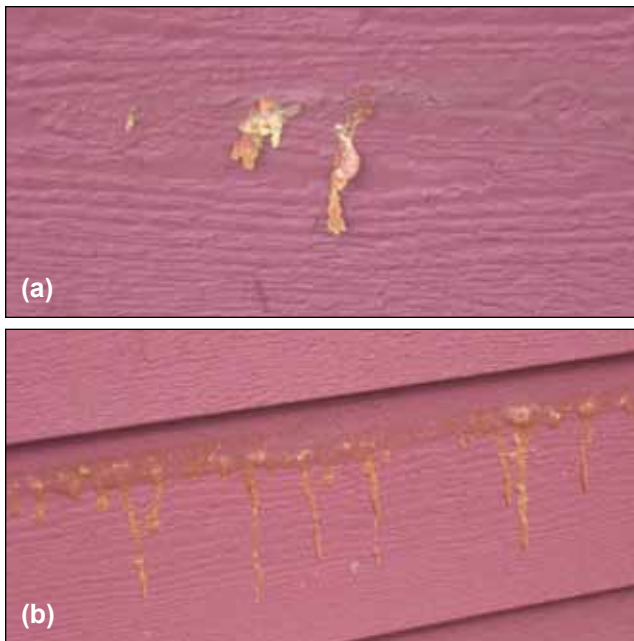

Figure 16–30. (a) Pitch exudation from an isolated spot; (b) pitch exudation from a large pocket or seam.

Finishing Interior Wood

Many finishes and finishing methods are used indoors because of the breadth of wood products and uses—from wood floors to cutting boards. This section includes general information on a few common products used for interior wood finishing and brief subsections on finishing wood floors and kitchen utensils. Many finishing methods exist for just furniture. Factory finishing of furniture is often proprietary and may involve more than a dozen steps. Methods for furniture finishing are not included in this chapter, but most public libraries contain books on furniture finishing. Product literature for furniture finishes often contains recommendations for application. Interior wood products require less protection against water and UV radiation than do exterior wood products, and finishes usually last for decades. However, interior wood products have more exacting standards for appearance and cleanability than do exterior wood products.

As with wood used outdoors, wood changes color as it ages indoors, whether unfinished or finished. In general, dark wood gets lighter and light wood gets darker. Color change is natural aging of newly cut wood and is caused by visible light, not UV radiation associated with outdoor weathering. If removing a picture from paneling shows a color difference (shadowing by the picture), correct it by leaving the wood exposed to light. The color will usually even out within several months. To avoid shadowing, keep all paintings and other wall coverings off paneling until most color change has occurred (usually 2 to 3 months, depending on the light intensity).

Fingerjointed lumber has become common for interior trim. Pieces of wood for fingerjointed lumber often come from different trees having different amounts of extractives. These extractives can discolor finishes, particularly in humid environments such as bathrooms and kitchens (Fig. 16–10). When painting fingerjointed lumber, use a stain-blocking primer to minimize discoloration. In new buildings, allow wood adequate time to reach EMC before finishing.

Types of Finish and Wood Fillers

Opaque Finishes

Interior woodwork, especially wood trim, requires smooth surfaces, consistent color, and a lasting sheen. Therefore, enamels, high-gloss or semi-gloss, are preferable to flat paints. However, the higher the gloss, the more the finish accentuates imperfections such as planer marks, hammer marks, and raised grain. Raised grain is troublesome on flat-grain surfaces having abrupt EW–LW transitions, because planing crushes LW bands into the EW; later, when the MC changes, the EW swells causing raised grain. To obtain a smooth finish, sponge unfinished wood with water to raise the grain, allow it to dry thoroughly, sand, remove surface dust with a tack cloth, and finish.

Stains

Stains accentuate wood grain by absorbing differently into EW, LW, knots, vessels, and flaws. Stains color EW more than LW, reversing the natural color gradation. For uniform color, apply a penetrating sealer (“wash coat”) before applying stain. It impedes stain absorption into the EW. Interior stains are often natural or synthetic dyes dissolved in water or organic solvent. Water-soluble stains give depth to a finish, dry slowly, raise the grain, and require sanding. Solvent-borne stains dry quickly, do not raise the grain, and need little or no sanding. A combination of solvent- and water-borne stains or dyes can give the finish color “depth.”

If stain absorbs into wood unevenly, causing a blotchy appearance, blue-stain fungi or bacteria probably infected the tree prior to cutting for lumber. Blue stain on lumber is easy to see. However, bacteria-infected areas have no color and wood appears normal. Infected areas absorb excessive amounts of stain quickly, giving wood an uneven blotchy appearance. The infection occurs across grain boundaries. This problem is not very common, but should it occur, it cannot be fixed once the stain is applied. If wood is to be used for furniture or fine woodwork, it might be a good idea to check lumber before using it by applying a stain or denatured alcohol to identify infected areas. (Schofield (2008) describes diagnosing blotching and treating boards prior to staining.) Discard pieces on which stain appears blotchy, apply a wash coat to decrease absorption, or use them where they will not show. Sealing the lumber with dewaxed shellac prior to staining may help; commercial sealers are also available.

Fillers

Hardwoods are ring porous, semi-ring porous, or diffuse porous according to size and location of vessels (see Anatomy). Diffuse-porous and semi-ring-porous hardwoods with small vessels may be finished with paints, enamels, and varnishes in the same way as softwoods. Vessels in most ring-porous hardwoods need to be filled to obtain a smooth finished surface. Filler may be a paste or liquid, natural or colored. Wipe the filler across wood grain to pack it into the vessels; then, wipe with a few light strokes with the grain. Remove surplus filler immediately after the glossy wet appearance disappears. After the filler dries thoroughly, lightly sand it before finishing the wood.

Use slightly different methods for opaque and clear coatings. For opaque finishes, fill vessels, sand, and apply primer/sealer and top-coats. For clear finishes, stain prior to filling to bring out the color of the vessels. Transparent fillers do not affect finish or wood color; colored fillers match or contrast with wood color.

Sealers

Sealers are thinned varnish, shellac, or lacquer used to prevent absorption of finish and prevent bleeding of stains into surface coatings, especially lacquer coatings. Lacquer and shellac sealers dry quickly.

Transparent Finishes

Transparent film-forming finishes such as varnish give excellent performance on wood indoors. However, as with high-gloss finishes, transparent finishes accentuate surface blemishes. Remove all blemishes, such as planer marks and raised grain before finishing. Transparent finishing consists of sanding, staining, filling, sealing, finishing, and sometimes waxing.

Transparent coatings may be gloss varnish, semi-gloss varnish, shellac, nitrocellulose lacquer, natural oils, or wax. Wax provides protection without forming a thick coating and enhances the natural luster of wood. Other coatings, such as shellac, linseed or tung oil, lacquer, and varnish accentuate the natural luster of some hardwoods and seem to give the surface “depth.” Shellac applied by the laborious process of French polishing probably achieves this impression of depth most fully, but the coating is expensive and easily marred by water. Rubbing varnishes give almost as much depth. Lacquers have the advantages of drying rapidly and forming a hard surface, but lacquer requires more coats than varnish to obtain a lustrous appearance. Sufficient film thickness is needed for long service life, particularly for products that are cleaned often, such as kitchen cabinets and tabletops. Varnishes are usually alkyd-modified polyurethane and are available in solvent-borne and waterborne formulations. Waterborne finishes are more likely to raise grain than are solvent-borne finishes and may appear like a plastic film, rather than bringing out the “depth” of the wood



Figure 16–31. Number 2 grade of hickory finished to accentuate the beauty of the various colors, knots, and grain pattern of this species.

substrate. Apply varnish directly to wood or stain prior to varnishing.

Varnish and lacquer usually dry to a high gloss. To decrease gloss, rub finish surface with polishing compound (waterproof sandpaper or powdered pumice stone and water or polishing oil). The final sheen varies with the fineness of the polishing compound; coarse powders make a dull surface and fine powders produce a bright sheen. For a smooth surface with high polish, use rottenstone and oil for final polishing. Varnish and lacquer that give a semi-gloss or satin finish are also available. Do not use steel wool (see Iron Stain).

Natural oils such as linseed oil or teak oil and commercial formulations such as Danish oil are popular. These finishes penetrate wood and do not form a film. Apply two or more coats of oil followed by a paste wax. Oil finishes are easy to apply and maintain, but they soil more easily than film-forming finishes.

Finishes for Wood Floors

Wood is highly desirable flooring for homes, factories, and public buildings and is available in many wood species. Natural color and grain accentuate many architectural styles. Finishes enhance the natural beauty of wood floors, protect them from excessive wear, and make them easier to clean (Fig. 16–31). Detailed procedures and specific products depend largely on the species of wood used and finish preference. Obtain additional information specific to your needs from flooring associations or individual flooring manufacturers.

Finishing floors consists of four steps: sanding the surface, applying filler, staining to achieve a desired color, and finishing with a clear coat. Careful sanding to provide a

smooth surface is essential for a good appearance because the finish accentuates any irregularities or roughness in the surface. A smooth surface requires sanding in several steps with progressively finer sandpaper, usually with a machine unless the area is small. After sanding, remove all dust. Never use steel wool on floors because minute steel particles left in wood cause iron stains. Filler is necessary for wood with large pores, such as red oak, to obtain a smooth glossy appearance (Table 16–1). Stain to obtain a uniform color or to accent the grain pattern. Stain should be an oil-based or non-grain-raising type. Stains penetrate wood only slightly; therefore, protect the stained surface with a clear coating. Refinish the clear top-coats as needed to prevent wearing through to the stained wood. Staining worn spots in a way that will match the color of the surrounding area is difficult.

Whether the wood is stained or not, sealers or varnishes give a clear finish for wood floors. Floor varnish is usually alkyd-modified polyurethane. Sealers are usually thinned varnish and penetrate the surface without forming a coating of appreciable thickness. Prolong the service life of floor finishes by keeping them waxed. Paste wax generally provides better appearance and lasts longer than liquid wax. Re-waxing or resealing and waxing of high traffic areas are relatively simple maintenance procedures, as long as the stained surface of the wood has not been worn.

Finishes for Items Used for Food

The durability and beauty of wood make it an attractive material for bowls, butcher blocks, and other items used to serve or prepare food. A finish helps keep wood dry, which makes it less prone to harbor bacteria, check, or crack. Finishes that repel water decrease the effects of brief periods of wetting (washing). Finished wood is easier to clean than unfinished wood.

Types of Finish

Sealers and Drying Oils

Sealers and drying oils penetrate wood and cure (dry) to form a barrier to liquid water. Many commercial sealers are similar to thinned varnish (e.g., polyurethane or alkyd-modified polyurethane). Drying oils such as tung, linseed, and walnut can also be used as sealers. Sealers and drying oils give a surface that is easy to clean and resistant to scratching. Sealers are easy to apply and cure quickly. Drying oils may require several weeks to cure.

Nondrying Oils

Nondrying oils (vegetable and mineral oils) penetrate wood but do not cure. As with sealers and drying oils, they improve water resistance. Vegetable oils (such as olive, corn, peanut, and safflower) are food for microorganisms such as mildew or bacteria. Vegetable oils can become rancid and may impart undesirable odors or flavors to food. Mineral (or paraffin) oil is a nondrying oil from petroleum. Mineral oil is not a natural product; therefore, it is not prone to mildew or to harbor bacteria.

Varnish and Lacquer

Finishes that form a film, such as varnish or lacquer, give a smooth cleanable surface. These finishes resist staining and should perform well if you minimize their exposure to water; avoid placing them in a dishwasher. However, eventually the finish may crack, chip, and peel.

Paraffin Wax

Paraffin wax is similar to paraffin oil but is solid at room temperature. Paraffin wax is one of the simplest ways to finish wood utensils, especially countertops, butcher blocks, and cutting boards.

Food Service Items

Food service items such as salad bowls and eating utensils need a finish that is easy to clean and resistant to abrasion, water, acids, and stains. Varnishes, lacquers, penetrating wood sealers, and drying oils can be used; however, varnishes and lacquers are easiest to keep clean and most resistant to absorption of stains.

Note: Whatever finish is chosen for wood utensils used to store, handle, or eat food, be sure the finish is safe and not toxic. Also, be sure the finish you select is recommended for use with food or is described as food grade. For information on the safety and toxicity of any finish, check the label, contact the manufacturer or the Food and Drug Administration, or check with your local extension home economics expert or county agent.

Butcher Blocks and Cutting Boards

The simplest finish for wood butcher blocks and cutting boards is melted paraffin wax (the type used for home canning). Melt wax using hot plate or other low-temperature heat source—**do not use an open flame**. Brush melted wax on the wood. Use an iron to melt excess wax that has solidified on the surface so that it absorbs into the wood, or just scrape off the excess wax. Refinishing is simple and easy. Other penetrating finishes (sealers, drying and nondrying oils) may be used for butcher blocks and cutting boards, but as mentioned in the subsection on eating utensils, vegetable oils may become rancid. Film-forming finishes such as varnish or lacquer perform poorly on butcher blocks and cutting boards.

Wood Cleaners and Brighteners

The popularity of wood decks and the desire to keep them looking bright and new has led to a proliferation of commercial cleaners and brighteners. The active ingredient in many of these products is sodium percarbonate ($2\text{Na}_2\text{CO}_3 \cdot 3\text{H}_2\text{O}_2$). Sodium percarbonate is bleach; however, it is oxygen bleach rather than chlorine bleach such as laundry bleach—sodium hypochlorite and calcium hypochlorite. Oxygen bleaches remove mildew and have been reported to be less likely to damage wood surfaces than “chlorine” bleaches, particularly with low-density woods like western redcedar, Alaska

yellow-cedar, and redwood. However, it is difficult to compare the advantages and disadvantages of the two types of cleaner (oxygen versus chlorine) because of the wide range of active ingredient concentrations in the cleaners, additives in the cleaners, and various wood substrates that have been used for evaluating the cleaners. Some commercial products contain household bleach. Commercial cleaners usually have a surfactant or detergent to enhance the cleansing action.

At the other extreme from the reported gentle bleaching action of sodium percarbonate are those cleaners containing sodium hydroxide. Sodium hydroxide is a strongly alkaline chemical that pulps wood and is used in some paint strippers. These cleaners may be necessary where mildew is imbedded in a surface finish; however, they should be used only as a last resort.

Manufacturers of some cleaners and brighteners report that their products restore color to wood. Cleaning wood does not add color. Removing mildew reveals the original color. Brightening the wood may make it appear as if it has more color. Weathered wood has a silvery gray appearance because weathering removes colored components from the surface. If you want to restore color, stain the wood. Some commercial cleaners pulp the wood surface and subsequent power washing removes the pulped surface. In this case, the color is “restored” because the surface of the wood was removed. Sanding would give the same result.

Some brighteners contain oxalic acid. Oxalic acid removes extractives bleed and iron stains, but it is not effective for removing mildew.

Paint Strippers

Removing paint and other film-forming finishes from wood is a time-consuming and often difficult process. Finish removal is necessary if a finish has extensive cracking or peeling (see Finish Failure or Discoloration). It may be necessary to remove paint containing lead; however, if the paint is still sound and it is not illegal to leave it on the structure, paint over the lead-based paint to seal in the lead (see Lead-Based Paint).

Methods described here can remove finishes from furniture; however, companies that specialize in stripping furniture usually immerse the furniture in a vat of paint stripper, then clean and brighten the wood.

Mechanical and chemical are general types of stripping methods. Consult product literature for additional information on appropriate uses and safety precautions. Regardless of the method used to strip paint, sand the wood prior to applying new finish.

Note: Dust caused by mechanical stripping methods and fumes given off by chemical strippers are usually toxic. Use effective safety equipment, including a respirator, even if the paint does not contain lead (see Lead-Based Paint). Dust masks sold in hardware stores do not block chemical fumes and are not very effective against dust.

Mechanical Methods

Scraping, sanding, wet or dry sandblasting, spraying with pressurized water (power washing), and using electrically heated pads, hot air guns, and blowtorches are mechanical methods for removing finishes.

Scraping is effective for removing loosely bonded paint or paint that has already partially peeled from small areas of the structure. If possible, sand weathered surfaces and feather edges of paint still bonded to wood. ***Do not sand if the old paint contains lead*** (see Lead-Based Paint).

If paint has partially debonded on large areas of a structure, contractors usually remove the finish by power washing. This methods work well for paint that is loosely bonded. If paint is tightly bonded, complete removal can be difficult without severely damaging wood. The pressure needed to debond tightly bound paint from wood can easily cause deep erosion of wood. If high pressure is necessary to remove paint, the paint probably does not need to be removed prior to refinishing. Power washing erodes less dense EW more than dense LW, leaving behind ridges of LW, which are difficult to repaint. Power washing is less damaging to wood than is wet or dry sandblasting, particularly if low pressure is used. If more aggressive mechanical methods are required, wet sandblasting can remove even tightly-bonded paint. Dry sandblasting is not suitable for removing paint from wood because it severely erodes wood along with the paint and it tends to glaze the surface. ***Power washing and wet and dry sandblasting are not suitable for paint containing lead.***

Power sanders and similar devices are available for complete paint removal. Some devices are suitable for removing paint that contains lead; they have attachments for containing the dust. Equipment that has a series of blades similar to a power hand-planer is less likely to “gum up” with paint than equipment that merely sands the surface. Planers and sanders cannot be used unless the fasteners are countersunk. Consult the manufacturers’ technical data sheets for detailed information to determine the suitability of their equipment for your needs and to meet government regulations on lead-containing paint.

Paint can be softened using electrically heated pads, hot air guns, or blow torches, then removed by scraping it from the wood. Heated pads and hot air guns are slow methods and cause little damage to the wood. Blowtorches have been

used to remove paint, but they are extremely hazardous; the flame can easily ignite flammable materials beneath the siding through gaps in the siding. These materials may smolder, undetected, for hours before bursting into flame and causing loss of the structure. **Heated pads, hot air guns, and blowtorches are not suitable for paint containing lead.** These methods volatilize lead at their operating temperatures. Lead fumes are released at approximately 371 °C (700 °F).

Note: Removing paint from wood with a blowtorch is not recommended.

Chemical Methods

Efficient paint removal may involve mechanical and chemical methods. Stripping paint chemically has the following steps: apply paint stripper, wait, scrap off the softened paint, neutralize the stripper (if necessary), wash the wood, and sand the surface to remove wood damaged by the stripper and raised grain caused by washing. Chemical paint strippers, although tedious to use, are sometimes the most reasonable choice. Some are extremely strong chemicals that quickly remove paint but are dangerous to use. Others remove the paint slowly but are safer. With the exception of alkali paint stripper, how safe a product is and how fast it removes paint seem to be inversely correlated.

Solvent-Based Strippers

Fast-working paint strippers usually contain methylene chloride, a possible carcinogen that can burn eyes and skin. Eye and skin protection and a supplied-air respirator are essential when using this paint stripper. Paint strippers having methylene chloride can remove paint in as little as 10 min. Some paint strippers are formulated using other strong solvents because of concerns with methylene chloride; the same safety precautions should be used with these formulations as with those containing methylene chloride. Consult product literature and strictly observe safety precautions.

Alkali-Based Strippers

As an alternative to strong solvents, some paint strippers contain strong bases (alkali). As with solvent-based paint strippers, alkali-based strippers require eye and skin protection. Follow manufacturers' recommendations concerning use of a respirator. Although alkali-based paint strippers soften paint rather slowly, they are strong chemicals and can severely damage wood. Strong alkali pulps the wood surface. After paint removal, neutralize the surface with mild acid. Unfortunately, balancing the acid and base concentrations is difficult. If excess alkali remains in the wood, it may degrade the wood and subsequent paint coating. Excess acid can also damage wood. Alkali strippers are often left on painted wood a full day or overnight and are usually covered to slow evaporation. These covered types of products have the advantage of containing the paint stripper and paint quite well, an important consideration when removing paint

containing lead. Do not let alkali chemicals dry on the surface, particularly on those finishes containing lead. The dry chemicals contain lead dust.

Note: Alkali-based strippers require extra care to ensure that the wood is neutralized and that residual salts are washed from the wood. The surface usually needs to be sanded before repainting to remove raised grain.

“Safe” Paint Strippers

Several manufactures have marketed “safe” paint strippers. These strippers work slower than those having methylene chloride. The active ingredient in such paint strippers is usually proprietary. Concerning safety, follow the manufacturer's recommendations.

Avoidance of Problems

Avoid finish failure subsequent to removing the old finish by using methods that do not damage wood. The best way to remove paint may involve a combination of methods. For example, use power washing to remove as much loosely bound paint as possible. Then, use a chemical paint stripper on tightly-bonded paint. Avoid using excessive amounts of chemical stripper. Applying too much stripper or leaving it on painted wood too long can damage wood. Use less paint stripper and reapply it rather than trying to remove all the paint with one application and risk damaging wood.

The range of wood species and finishes and the possibility of finishes containing lead complicates paint removal. Companies may optimize paint stripper formulation without considering the effects on wood. Removing paint from wood is only half the task. Getting a paintable surface is the other half. Companies that formulate paint strippers should consider this other half. Those who use paint strippers need to understand the added burden of surface preparation.

Disposal of Old Paint

No matter what method you use to remove paint, be careful in disposing of old paint, particularly paint that contains lead. Lead paint is hazardous waste; follow all regulations, national and local, during the removal, storage, and disposal of all paint, especially paint containing lead (see Lead-Based Paint).

Lead-Based Paint

Lead-based paint was widely used in residential structures in the United States until the early 1940s, and its use continued to some extent, for the exterior of dwellings, until 1976. In 1971, Congress passed the Lead-Based Paint Poisoning Prevention Act, and in 1976, the Consumer Product Safety Commission (CPSC) issued a ruling under this Act that limited the lead content of paint used in residential dwellings, toys, and furniture to 0.06%. Prior to any paint restoration on structures built prior to 1976 (and probably a good idea on any structure), check paint for lead. Check for lead using a solution of 6% to 8% sodium sulfide in water or using a

Chapter 16 Finishing of Wood

test kit. Test kits should be available in most paint and hardware stores. Be certain to check all paint layers, because the older ones are more likely to contain lead.

Lead-based paint is still manufactured for applications not covered by the CPSC ruling, such as paint for metal products, particularly those made of steel. Occasionally, such lead-based paint inadvertently gets into the hands of consumers. **Imported products may also contain lead paint.** Studies have shown that ingestion of even minute amounts of lead can have serious effects on health; lead causes hypertension, fetal injury, damage to the brain, kidneys, and red blood cells, partial loss of hearing, impairment of mental development, growth retardation, and inhibited metabolism of vitamin D. The American Academy of Pediatrics regards lead as one of the foremost toxicological dangers to children.

Lead-based paint on the exterior of structures weathers to give flakes and powder. The degraded paint particles accumulate in the soil near the structure. Lead-based paint used on interior surfaces can also degrade to produce lead-containing dust. Sanding coatings prior to repainting generates lead dust. Sanding the exterior of a structure without proper equipment can cause lead contamination inside the structure.

Methods used to remove lead paint can themselves generate lead dust. This is particularly true when unacceptable methods and work practices are used. Poorly performed abatement can be worse than no abatement. Micron-sized lead dust particles can remain airborne for substantial periods and cannot be completely removed by standard cleaning methods. When working on old painted surfaces, assume that one or more of the paint coats contain lead. Take precautions accordingly.

Check with the U.S. Department of Health and Urban Development (HUD), U.S. Environmental Protection Agency (EPA), and American Coatings Association for the latest regulations and guidelines for remediating lead-based paint (www.hud.gov/offices/lead) (www.epa.gov/lead) (www.paint.org/issues/lead.cfm).

Caution: Remodeling or refinishing projects that require disturbing, removing, or demolishing portions of structures coated with lead-based paint pose serious health risk. The consumer should seek information, advice, and perhaps professional assistance for addressing these risks. Contact HUD for the latest information on the removal of lead-based paints. Debris coated with lead-based paint is hazardous waste and must be disposed of in accordance with federal and local regulations.

Literature Cited

AWPA. 2008. Book of standards. Birmingham, AL: American Wood Protection Association.

Sabin, A.H. 1927. Technology of paint and varnish. 3rd ed. London: John Wiley & Sons.

Schofield, M. 2008. Fine wood working. Newtown, CT: The Taunton Press. September/October (Issue 200): 52–58.

Wicks, Z.W., Jr.; Jones, F.N.; Pappas, S.P.; Wicks, D.A. 2007. Organic Coatings: Science and Technology. 3rd ed. Hoboken, NJ: John Wiley & Sons.

Additional References

APA. 1979. Stains and paints on plywood. Pamphlet B407B. Tacoma, WA: American Plywood Association.

Arnold, M.; Feist, W.C.; Williams, R.S. 1992. Effect of weathering of new wood on the subsequent performance of semitransparent stains. *Forest Products Journal*. 42(3): 10–14.

ASTM. 2003. Standard specification for zinc coating (hot-dip) on iron and steel hardware. A 153/A 153M–01a. West Conshohocken, PA: ASTM International. 1(6).

Black, J.M.; Mraz, E.A. 1974. Inorganic surface treatments for weather-resistant natural finishes. Res. Pap. FPL–232. Madison, WI: U.S. Department of Agriculture, Forest Service, Forest Products Laboratory. 44 p.

Bussjaeger, S.; Daisey, G.; Simmons, R.; Spindel, S.; Williams, S. 1999. Mildew and mildew control for wood surfaces. *JCT Coatings Tech*. 71(890): 67–69.

Cassens, D.L.; Feist, W.C. 1980a. Wood finishing: finishing exterior plywood, hardboard and particle board. North Central Region Extension Pub. 132. West Lafayette, IN: Purdue University, Cooperative Extension Service.

Cassens, D.L.; Feist, W.C. 1980b. Wood finishing: paint failure problems and their cure. North Central Region Extension Pub. 133. West Lafayette, IN: Purdue University, Cooperative Extension Service.

Cassens, D.L.; Feist, W.C. 1980c. Wood finishing: discoloration of house paint—causes and cures. North Central Region Extension Pub. 134. West Lafayette, IN: Purdue University, Cooperative Extension Service.

Cassens, D.L.; Feist, W.C. 1980d. Wood finishing: selection and application of exterior finishes for wood. North Central Region Extension Pub. 135. West Lafayette, IN: Purdue University, Cooperative Extension Service.

Cassens, D.L.; Feist, W.C. 1980e. Wood finishing: finishing and maintaining wood floors. North Central Region Extension Pub. 136. West Lafayette, IN: Purdue University, Cooperative Extension Service.

Daniels, T.; Hirsch, M.; McClelland, K.; Ross, A.; Williams, R.S. 2004. Clear exterior finishes: finding the balance between aesthetics and durability. *JCT Coatings Tech*. 1(9): 42–48.

Feist, W.C. 1979. Protection of wood surfaces with chromium trioxide. Res. Pap. FPL–339. Madison, WI: U.S.

- Department of Agriculture, Forest Service, Forest Products Laboratory. 11 p.
- Feist, W.C. 1982a. Weathering characteristics of finished wood-based panel products. *JCT Coatings Tech.* 54(686): 43–50.
- Feist, W.C. 1982b. Weathering of wood in structural uses. In: Meyer, R.W.; Kellogg, R.M., eds. *Structural use of wood in adverse environments*. New York: Van Nostrand Reinhold Company. 156–178.
- Feist, W.C. 1990. Outdoor wood weathering and protection. In: Rowell, R., ed. *Archaeological wood, properties, chemistry, and preservation*. Advanced in Chemistry Series No. 225. Washington, DC: American Chemical Society: 263–298. Chapter 11.
- Feist, W.C. 1996. Finishing exterior wood. *Federation Series on Coatings Technology*. Blue Bell, PA: Federation of Societies for Coatings Technology.
- Feist, W.C.; Hon, D.N.–S. 1984. Chemistry of weathering and protection. In: Rowell, R.M., ed. *The chemistry of solid wood*. Advances in Chemistry Series No. 207. Washington, DC: American Chemical Society: 401–451. Chapter 11.
- Feist, W.C.; Mraz, E.A. 1980. Performance of mildewcides in a semitransparent stain wood finish. *Forest Products Journal.* 30(5): 43–46.
- Feist, W.C.; Ross, A.S. 1995. Performance and durability of finishes on previously coated CCA-treated wood. *Forest Products Journal.* 45(9): 29–36.
- Feist, W.C.; Williams, R.S. 1991. Weathering durability of chromium treated Southern Pine. *Forest Products Journal.* 41(1): 8–14.
- Gorman, T.M.; Feist, W.C. 1989. Chronicle of 65 years of wood finishing research of the Forest Products Laboratory. Gen. Tech. Rep. FPL–GTR–60. Madison, WI: U.S. Department of Agriculture, Forest Service, Forest Products Laboratory.
- Jourdain, C.; Dwyer, J.; Kersall, K.; Mall, D.; Springate, R.; Williams, S. 1999. Changing nature of wood products—what does it mean for coatings and finish performance? *JCT Coatings Tech.* 71(890): 61–66.
- Kalnins, M.A.; Feist, W.C. 1993. Increase in wettability of wood with weathering. *Forest Products Journal.* 43(2): 55–57.
- Kiguchi, M.; Evans, P.D.; Ekstedt, J.; Williams, R.S.; Katoaka, Y. 2001. Improvement of the durability of clear coatings by grafting of UV-absorbers on to wood. *Surface Coatings International Part B: Coatings Transactions.* 84(B4): 263–270.
- Mall, D.D.; Bonura, T.; Bussjaeger, S.; Carll, C.; Panila, D.; Williams, R.S. 2004. Frequently asked questions: wood and coatings applications. *JCT Coatings Tech.* 1(3): 36–49.
- McDonald, K.A.; Falk, R.H.; Williams, R.S.; Winandy, J.E. 1996. *Wood decks: materials, construction, and finishing*. Madison, WI: Forest Products Society. 94 p.
- Miller, R.B.; Wiedenhoeft, A.C.; Williams, R.S.; Stockman, W.; Green, F. 2003. Characteristics of ten tropical hardwoods from certified forests in Bolivia: part II, natural durability to decay fungi. *Wood and Fiber Science.* 35(3): 429–433.
- Niemiec, S.S.; Brown, T.D. 1988. *Care and maintenance of wood shingle and shake roofs*. Corvallis, OR: Oregon State University Extension Service. EC 1271. (September).
- Richter, K.; Feist, W.C.; Knaebe, M.T. 1995. The effect of surface roughness on the performance of finishes. Part 1. Roughness characterization and stain performance. *Forest Products Journal.* 45(7/8): 91–97.
- Ross, A.; Daisey, G.; Jourdain, C.; Williams, R.S. 1998. Cleaners and restorers for wood decks. *The Paint Dealer.* (April): 30–33.
- Ross, A.S.; Feist, W.C. 1993. The effects of CCA-treated wood on the performance of surface finishes. *American Paint and Coatings Journal.* 78(9): 41–54.
- Ross, A.S.; Bussjaeger, R.C.; Feist, W.C. 1992. Professional finishing of CCA-pressure-treated wood. *American Painting Contractor.* 69(7): 107–114.
- Sell, J.; Feist, W.C. 1986. Role of density in the erosion of wood during weathering. *Forest Products Journal.* 36(3): 57–60.
- Simpson, W.T., ed. 1991. *Dry kiln operator's manual*. Agric. Handb. 188. Madison, WI: U.S. Department of Agriculture, Forest Service, Forest Products Laboratory. 274 p.
- Tichy, R.J. 1997. *Interior wood finishing: industrial use guide*. Madison, WI: Forest Products Society. 113 p.
- USDA. 1998. *Rehabilitation of wood-frame houses*. Agric. Handb. 804. Washington, DC: U.S. Department of Agriculture, Forest Service. 240 p.
- WDMA. 1999. *Industry standard for water-repellent preservative treatment for millwork*. IS4–99. Des Plaines, IL: Window and Door Manufacturer's Association.
- Williams, R.S. 1986. Effects of acid rain on painted wood surfaces: importance of the substrate. In: Baboian, R., ed. *Materials degradation caused by acid rain*. ACS Symposium Series 318. Washington, DC: American Chemical Society: 310–331.
- Williams, R.S. 1990a. Acidic deposition: state of science and technology. In: *Effects of acidic deposition on materials*.

Chapter 16 Finishing of Wood

- Report 19. National Acid Precipitation Assessment Program. 19/165 19/202. Vol. 3.
- Williams, R.S. 1990b. Effects of acidic deposition on painted wood. In: Effects of acidic deposition on materials. State of Science and State of Technology, Report 19. National Acid Precipitation Assessment Program: 19/165–19/202. Vol. 3.
- Williams, R.S. 1991. Effects of acidic deposition on painted wood: a review. *JCT Coatings Tech.* 63(800): 53–73.
- Williams, R.S. 2005. Weathering of wood. In: Rowell, R.M., ed. *Handbook of Wood Chemistry and Wood Composites*. Boca Raton: CRC Press. Chapter 7.
- Williams, R.S.; Feist, W.C. 1993a. Durability of paint or solid-color stain applied to preweathered wood. *Forest Products Journal.* 43(1): 8–14.
- Williams, R.S.; Feist, W.C. 1993b. Effect of weathering of wood prior to finishing on paint bond strength and durability. In: Proceedings of the Polymeric Materials Science and Engineering Division. Denver, CO: American Chemical Society Spring Meeting. 1993; March 29 April 2.
- Williams, R.S.; Feist, W.C. 1994. Effect of preweathering, surface roughness, and wood species on the performance of paint and stains. *JCT Coatings Tech.* 66(828): 109–121.
- Williams, R.S.; Feist, W.C. 1999. Selection and application of exterior stains for wood. Gen. Tech. Rep. FPL–GTR–106. Madison, WI: U.S. Department of Agriculture, Forest Service, Forest Products Laboratory: 1–9.
- Williams, R.S.; Feist, W.C. 1999. Water repellent and water repellent preservative finishes for wood. Gen. Tech. Rep. FPL–GTR–109. Madison, WI: U.S. Department of Agriculture, Forest Service, Forest Products Laboratory: 1–12.
- Williams, R.S.; Feist, W.C. 2001. Duration of wood pre-weathering: effect on the service life of subsequently applied paint. *JCT Coatings Tech.* 73(930): 65–72.
- Williams, R.S.; Feist, W.C. 2004. The service life of semitransparent stain, solid color stain, and latex paint on yellow-poplar and sweetgum plywood and the effect of these finishes on wood durability. *Forest Products Journal.* 54(7/8): 96–101.
- Williams, R.S.; Knaebe, M. 2000. Restoration of severely weathered wood. *JCT Coatings Tech.* 72(902): 43–51.
- Williams, R.S.; Knaebe, M.T.; Feist, W.C. 1996. Finishes for exterior wood. Madison, WI: Forest Products Society.
- Williams, R.S.; Miller, R.B.; Gangstad, J. 2001. Characteristics of ten tropical hardwoods from certified forests in Bolivia: part I, weathering characteristics and dimensional stability. *Wood and Fiber Science.* 33(4): 618–626.
- Williams, R.S.; Plantinga, P.L.; Feist, W.C. 1990. Photo-degradation of wood affects paint adhesion. *Forest Products Journal.* 40(1): 45–49.
- Williams, R.S.; Sotos, P.; Feist, W.C. 1999. Evaluation of several paint systems on severely weathered wood. *JCT Coatings Tech.* 71(895): 97–102.
- Williams, R.S.; Winandy, J.E.; Feist, W.C. 1987a. Adhesion of paint to weathered wood. *Forest Products Journal.* 37(11/12): 29–31.
- Williams, R.S.; Winandy, J.E.; Feist, W.C. 1987b. Paint adhesion to weathered wood. *JCT Coatings Tech.* 59(749): 43–49.
- Williams, R.S.; Winandy, J.E.; Feist, W.C. 2002. Correlation of adhesive strength with service life of paint applied to weathered wood. Paper 161. In: Proceedings, 9th durability of building materials and components conference. Brisbane, Australia: 17–20 March.
- Williams, R.S.; Jourdain, C.; Daisey, G.; Springate, R.W. 2000. Wood properties affecting finish service life. *JCT Coatings Tech.* 72(902): 35–42.
- Williams, R.S.; Knaebe, M.T.; Evans, J.W.; Feist, W.C. 2001. Erosion rates of wood during natural weathering: part III, effect of exposure angle on erosion rates. *Wood and Fiber Science.* 33(1): 50–57.
- Williams, R.S.; Knaebe, M.T.; Sotos, P.G.; Feist, W.C. 2001. Erosion rates of wood during natural weathering: part I, effect of grain angle and surface texture. *Wood and Fiber Science.* 33(1): 33–42.
- Williams, R.S.; Lacher, S.; Halpin, C.; White, C. 2005. Evaluating weather factors and material response during outdoor exposure to determine accelerated test protocols for predicting service life. In: Martin, J.W.; Ryntz, R.A.; Dickie, R.A., eds. *Service Life Prediction, Challenging the Status Quo*, Federation of Societies for Coatings Technology. Proceedings, 3rd international symposium on service life prediction. Sedona, AZ. 2004 February 1–6.
- Williams, R.S.; Ross, A.S.; Sotos, P.; Cheeks, C.N. 2001. Water-repellent preservative treatment of brick molding prior to factory priming improves paint service life. In: Proceedings of the annual meeting of the American Wood Preserver's Association. (Vol. 97): 65–67.

Use of Wood in Buildings and Bridges

James P. Wacker, Research General Engineer

Contents

Light-Frame Buildings 17-1
Foundations 17-2
Floors 17-2
Exterior Walls 17-3
Ceiling and Roof 17-4
Wood Decks 17-4
Post-Frame and Pole Buildings 17-4
Log Buildings 17-6
Heavy Timber Buildings 17-6
Timber Frame 17-6
Mill Type 17-7
Glulam Beam 17-7
Arch Structure 17-8
Dome 17-8
Timber Bridges 17-8
Log Stinger 17-8
Sawn Lumber 17-9
Glulam 17-9
Structural Composite Lumber 17-9
Considerations for Wood Buildings 17-9
Structural 17-9
Thermal Insulation and Air Infiltration Control 17-9
Moisture Control 17-10
Sound Control 17-11
Literature Cited 17-12

In North America, most housing and commercial structures built prior to the 20th century used wood as the major structural material. The abundant wood resource formed the basic structure for most houses, commercial buildings, bridges, and utility poles. Today, houses and many light commercial and industrial buildings are made using modern wood structural materials. Recently, there has been increased interest in using wood for various types of transportation structures, including highway bridges.

In this chapter, the features of various types of building systems are described. Emphasis is placed on how these systems have adapted to the use of modern materials and techniques. For example, where floor, wall, and roof sheathing for light-frame construction were once commonly made from wood boards, sheathing is now commonly made from structural panel products, such as plywood and oriented strandboard (OSB). Compared with boards, these panel products are quicker to install and provide improved structural resistance to wind and earthquake loadings. Furthermore, prefabricated floor and wall panels along with prefabricated roof and floor trusses or I-joists are replacing piece-by-piece on-site construction with dimension lumber. A structure can be enclosed within a short time on site using factory-made panelized systems.

Engineered wood products are being used increasingly for transportation structures. A brief description of the uses of wood in railroad and highway bridges and other transportation structures is included.

Light-Frame Buildings

Historically, two general types of light-frame construction have been used—balloon and platform framing. Balloon framing, which was used in the early part of the 20th century, consists of full-height wall framing members for two-story construction. Additional information on balloon framing is available from older construction manuals. Since the latter part of the 20th century, platform framing has dominated the housing market and is widely used in commercial and light industrial applications. Platform framing features the construction of each floor on top of the one beneath. Platform framing construction differs from that of 60 years ago in the use of new and innovative materials, panel products for floor and roof sheathing, and prefabricated components and modules as opposed to “stick built” or on-site construction. A detailed description of the platform-type of construction

is given in *Wood Frame House Construction* (Sherwood and Stroh 1989); additional information is given in the *Wood Frame Construction Manual for One- and Two-Family Dwellings, 2001* (AF&PA 2001).

Foundations

Light-frame buildings with basements are typically supported on cast-in-place concrete walls or concrete block walls supported by footings. This type of construction with a basement is common in northern climates. Another practice is to have concrete block foundations extend a short distance above ground to support a floor system over a “crawl space.” In southern and western climates, some buildings have no foundation; the walls are supported by a concrete slab, thus having no basement or crawl space.

Treated wood is also used for basement foundation walls. Basically, such foundations consist of wood-frame wall sections with studs and plywood sheathing supported on treated wood plates, all of which are preservatively treated to a specified level of protection. To distribute the load, the plates are laid on a layer of crushed stone or gravel. Walls, which must be designed to resist the lateral loads of the backfill, are built using the same techniques as conventional walls. The exterior surface of the foundation wall below grade is draped with a continuous moisture barrier to prevent direct water contact with the wall panels. The backfill must be designed to permit easy drainage and provide drainage from the lowest level of the foundation.

Because a foundation wall needs to be permanent, the preservative treatment of the plywood and framing and the type of fasteners used for connections are very important. A special foundation (FDN) treatment has been established for the plywood and framing, with strict requirements for depth of chemical penetration and amount of chemical retention. Corrosion-resistant fasteners (for example, stainless steel) are recommended for all preservatively treated wood. Additional information and materials and construction procedures are given in *Permanent Wood Foundation Basic Requirements* (AF&PA 2007).

Floors

For houses with basements, the central supporting structure may consist of wood posts on suitable footings that carry a built-up girder, which is frequently composed of planks the same width as the joists (standard 38 by 184 mm to 38 by 286 mm (nominal 2 by 8 in. to 2 by 12 in.)), face-nailed together, and set on edge. Because planks are seldom sufficiently long enough to span the full length of the beam, butt joints are required in the layers. The joints are staggered in the individual layers near the column supports. The girder may also be a glulam beam or steel I-beam, often supported on adjustable steel pipe columns. Similar details may be applied to a house over a crawl space. The floor framing in residential structures typically consists of wood joists on

400- or 600-mm (16- or 24-in.) centers supported by the foundation walls and the center girder (Fig. 17–1).

Joist size depends on the anticipated loading, spacing between joists, distance between supports (span), species, and grade of lumber. Commonly used joists are standard 38- by 184-mm or 38- by 235-mm (nominal 2- by 8-in. or 2- by 10-in.) lumber, prefabricated wood I-joists, or parallel chord trusses. Lumber joists typically span from 3.6 to 4.8 m (12 to 16 ft). Span tables are available from the American Forest & Paper Association (AF&PA 2005b). Span capabilities of prefabricated wood I-joists or parallel chord trusses are recommended by the manufacturer.

Floor openings for stairways, fireplaces, and chimneys may interrupt one or more joists. Preferably, such openings are parallel to the length of the joists to reduce the number of joists that will be interrupted. At the interruption, a support (header) is placed between the uninterrupted joists and attached to them. A single header is usually adequate for openings up to about 1.2 m (4 ft) in width, but double headers are required for wider openings. Special care must be taken to provide adequate support at headers (using joist hangers, for example).

Cutting of framing members to install items such as plumbing lines and heating ducts should be minimized. Cut members may require a reinforcing scab, or a supplementary member may be needed. Areas of highly concentrated loads, such as under bathtubs, require doubling of joists or other measures to provide adequate support. One advantage of framing floors with parallel-chord trusses or prefabricated I-joists is that their longer span capabilities may eliminate the need for interior supports. An additional advantage is that the web areas of these components are designed for easy passing of plumbing, electrical, and heating ducts.

Floor sheathing, or subflooring, is used over the floor framing to provide a working platform and a base for the finish flooring. Older homes have board sheathing but newer homes generally use panel products. Common sheathing materials include plywood and OSB, which are available in a number of types to meet various sheathing requirements. Exterior-type panels with water-resistant adhesive are desirable in locations where moisture may be a problem, such as floors near plumbing fixtures or situations where the subfloor may be exposed to the weather for some time during construction.

Plywood should be installed with the grain direction of the face plies at right angles to the joists. Oriented strandboard also has a preferred direction of installation. Nailing patterns are either prescribed by code or recommended by the manufacturer. About 3 mm (1/8 in.) of space should be left between the edges and ends of abutting panels to provide for dimensional changes associated with moisture content.

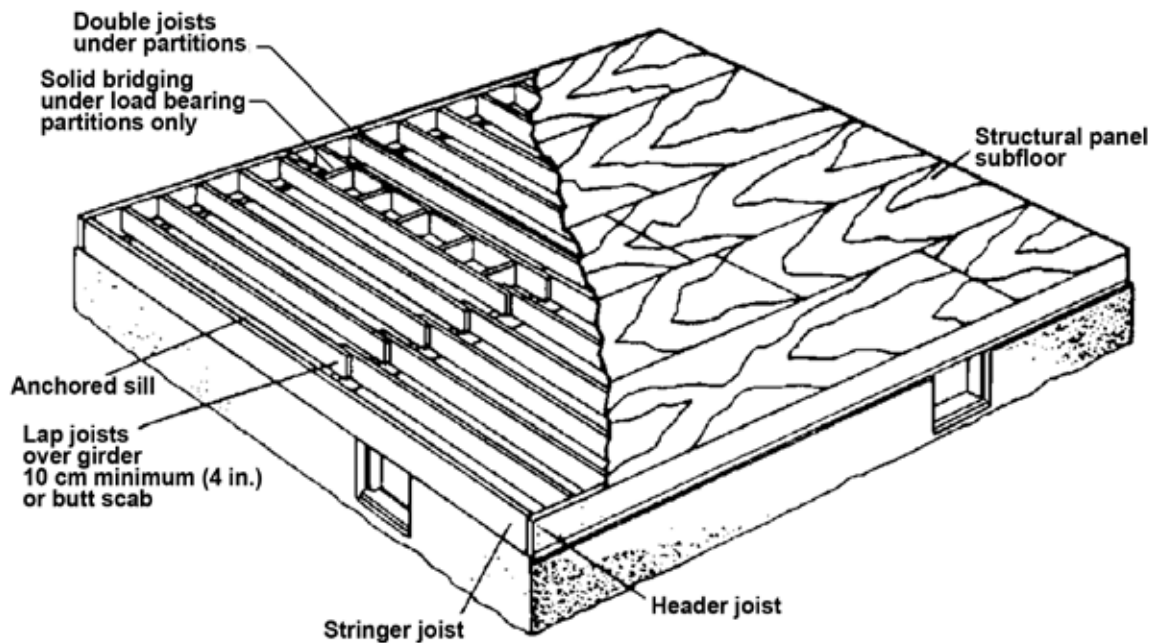

Figure 17-1. Typical floor details for platform construction with joists spliced on center beam.

Literature from APA—The Engineered Wood Association includes information on the selection and installation of the types of structural panels suitable for subfloors (APA 2007).

Exterior Walls

Exterior walls of light-frame structures are generally load bearing; they support upper floors and the roof. An exception is the gable ends of a one- or two-story building. Basically, wall framing consists of vertical studs and horizontal members, including top and bottom plates and headers (or lintels) over window and door openings. The studs are generally standard 38- by 89-mm, 38- by 114-mm, or 38- by 140-mm (nominal 2- by 4-in., 2- by 5-in., or 2- by 6-in.) members spaced between 300 and 600 mm (12 and 24 in.) on center. Selection of the stud size depends on the load the wall will carry, the need for support of wall-covering materials, and the need for insulation thickness in the walls. Headers over openings up to 1.2 m (4 ft) are often 38 by 140 mm (2 by 6 in.), nailed together face to face with spacers to bring the headers flush with the faces of the studs. Special headers that match the wall thickness are also available in the form of either prefabricated I-joists or structural composite lumber. Wall framing is erected over the platform formed by the first-floor joists and subfloor. In most cases, an entire wall is framed in a horizontal position on the subfloor, then tilted into place. If a wall is too long to make this procedure practical, sections of the wall can be formed horizontally and tilted up, then joined to adjacent sections.

Corner studs are usually prefabricated in such a configuration as to provide a nailing edge for the interior finish

(Fig. 17-2). Studs are sometimes doubled at the points of intersection with an interior partition to provide backup support for the interior wall finish. Alternatively, a horizontal block is placed midheight between exterior studs to support the partition wall. In such a case, backup clips on the partition stud are needed to accommodate the interior finish.

Upper plates are usually doubled, especially when rafters or floor joists will bear on the top plate between studs. The second top plate is added in such a way that it overlaps the first plate at corners and interior wall intersections. This provides a tie and additional rigidity to the walls. In areas subject to high winds or earthquakes, ties should be provided between the wall, floor framing, and sill plate that should be anchored to the foundation. If a second story is added to the structure, the edge floor joist is nailed to the top wall plate, and subfloor and wall framing are added in the same way as the first floor.

Sheathing for exterior walls is commonly some type of panel product. Here again, plywood or OSB may be used. Fiberboard that has been treated to impart some degree of water resistance is another option. Several types of fiberboard are available. Regular-density board sometimes requires additional bracing to provide necessary resistance to lateral loads. Intermediate-density board is used where structural support is needed. Numerous foam-type panels can also be used to impart greater thermal resistance to the walls.

In cases where the sheathing cannot provide the required racking resistance, diagonal bracing must be used. Many foam sheathings cannot provide adequate racking resistance,

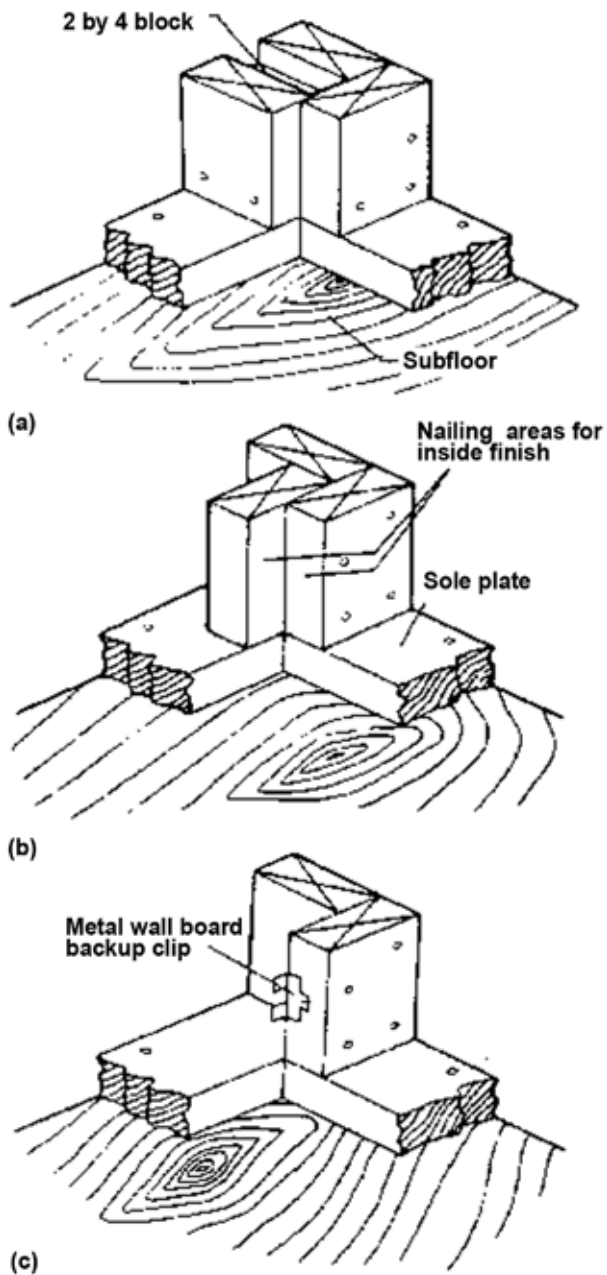

Figure 17-2. Corner details for wood stud walls that provide support for interior sheathing: (a) traditional three-stud corner with blocking; (b) three-stud corner without blocking; (c) two-stud corner with wallboard backup clips.

so either diagonal braces must be placed at the corners or structural panels must be applied over the first 1.2 m (4 ft) of the wall from the corner. When light-weight insulating foam sheathings are used, bracing is commonly provided by standard 19- by 89-mm (nominal 1- by 4-in.) lumber or steel strapping.

Ceiling and Roof

Roof systems are generally made of either the joists-and-rafter systems or with trusses. Engineered trusses reduce on-site labor and can span greater distances without intermediate support, thus eliminating the need for interior load-carrying partitions. This provides greater flexibility in the layout of interior walls. Prefabricated roof trusses are used to form the ceiling and sloped roof of more than two-thirds of current light-frame buildings. For residential buildings, the trusses are generally made using standard 38- by 89-mm (nominal 2- by 4-in.) lumber and metal plate connectors with teeth that are pressed into the pieces that form the joints (TPI 2007).

Joists and rafter systems are found in most buildings constructed prior to 1950. Rafters are generally supported on the top plate of the wall and attached to a ridge board at the roof peak. However, because the rafters slope, they tend to push out the tops of the walls. This is prevented by nailing the rafters to the ceiling joists and nailing the ceiling joists to the top wall plates (Fig. 17-3a).

A valley or hip is formed where two roof sections meet perpendicular to each other. A valley rafter is used to support short-length jack rafters that are nailed to the valley rafter and the ridge board (Fig. 17-3b). In some cases, the roof does not extend to a gable end but is sloped from some point down to the end wall to form a “hip” roof. A hip rafter supports the jack rafters, and the other ends of the jack rafters are attached to the top plates (Fig. 17-3c). In general, the same materials used for wall sheathing and subflooring are used for roof sheathing.

Wood Decks

A popular method of expanding the living area of a home is to build a wood deck adjacent to one of the exterior walls. Decks are made of preservatively treated lumber, which is generally available from local building supply dealers and, depending upon the complexity, may be built by the “do-it-yourselfer.” To ensure long life, acceptable appearance, and structural safety, several important guidelines should be followed. Proper material selection is the first step. Then, proper design and construction techniques are necessary. Finally, proper maintenance practices are necessary. Detailed recommendations for all these areas are included in *Wood Decks: Materials, Construction, and Finishing* (McDonald and others 1996) and *Prescriptive Residential Wood Deck Construction Guide* (AWC 2009).

Post-Frame and Pole Buildings

In post-frame and pole buildings, round poles or rectangular posts serve both as the foundation and the principal vertical framing element. This type of construction was known as “pole buildings” but today, with the extensive use of posts,

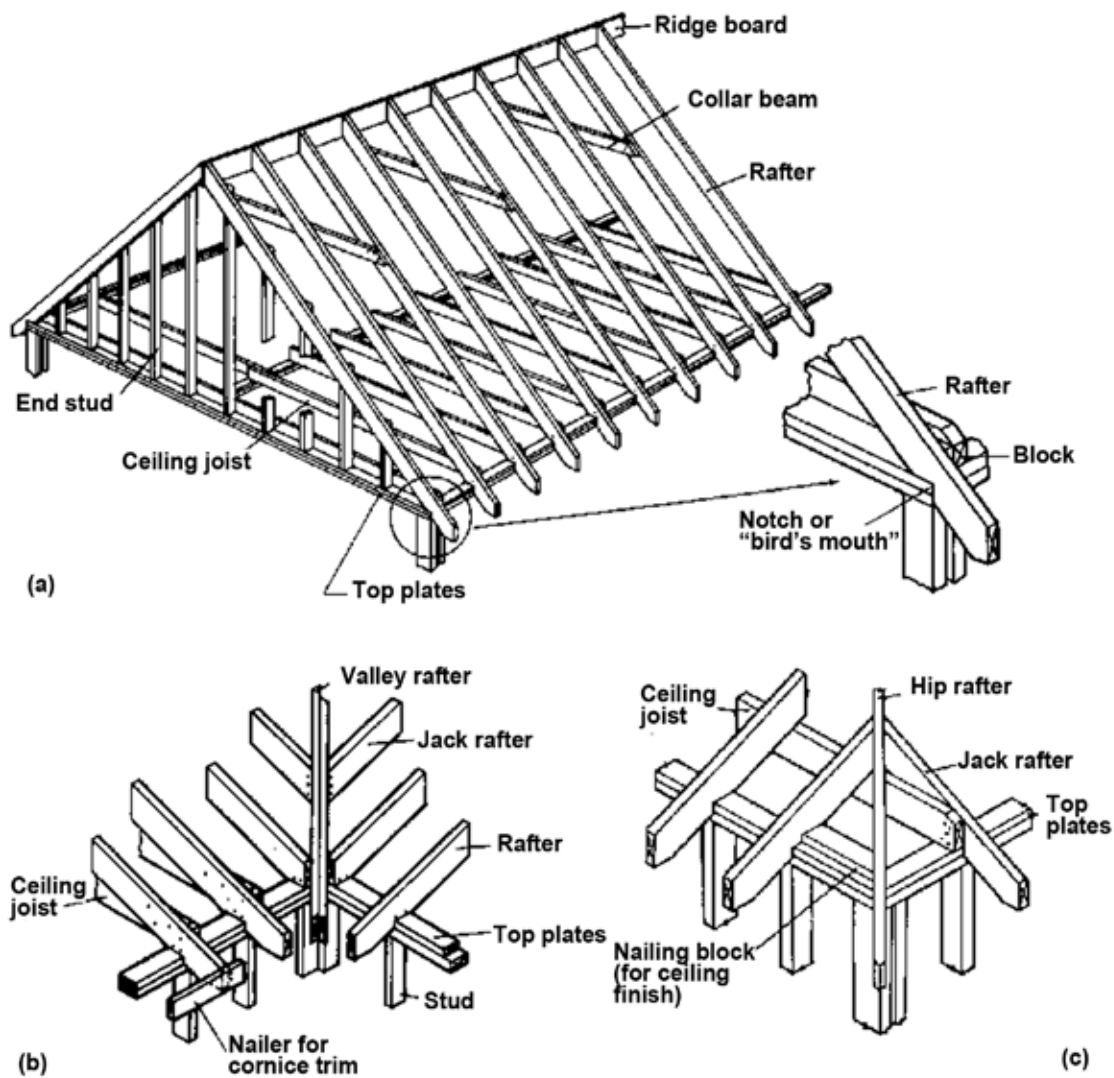

Figure 17-3. (a) A rafter-type roof with typical framing details for (b) a valley and (c) a hip corner.

is commonly referred to as “post-frame” construction. For relatively low structures, light wall and roof framing are nailed to poles or posts set at fairly frequent centers, commonly 2.4 to 3.6 m (8 to 12 ft). This type of construction was originally used with round poles for agricultural buildings, but the structural principle has been extended to commercial and residential buildings (Fig. 17-4).

Round poles present some problems for connecting framing members; these problems can be eased by slabbing the outer face of the pole. For corner poles, two faces may be slabbed at right angles. This permits better attachment of both light and heavy framing by nails or timber connectors. When the pole is left round, the outer face may be notched to provide seats for beams.

Rectangular posts are the most commonly used and may be solid sawn, glulam, or built-up by nail laminating. Built-up

posts are advantageous because only the base of the post must be preservative treated. The treated portion in the ground may have laminations of various lengths that are matched with the lengths of untreated laminations in the upper part of the post. The design of these types of posts must consider the integrity of the splice between the treated and untreated lumber. The wall system consists of horizontal girts often covered by light-gauge metal that provides some degree of racking resistance. Roof trusses made with metal plate connectors are attached to each pole, or post, and roof purlins are installed perpendicular to the trusses at spacings from 1.2 to 3.7 m (4 to 12 ft), with 2.4 m (8 ft) as a common spacing. For 2.4-m (8-ft) truss spacing, these purlins are often standard 38 by 89 mm (nominal 2 by 4 in.) spaced on 0.6-m (2-ft) centers and attached to either the top of the trusses or between the trusses using joists hangers. The roofing is often light-gauge metal that provides some diaphragm

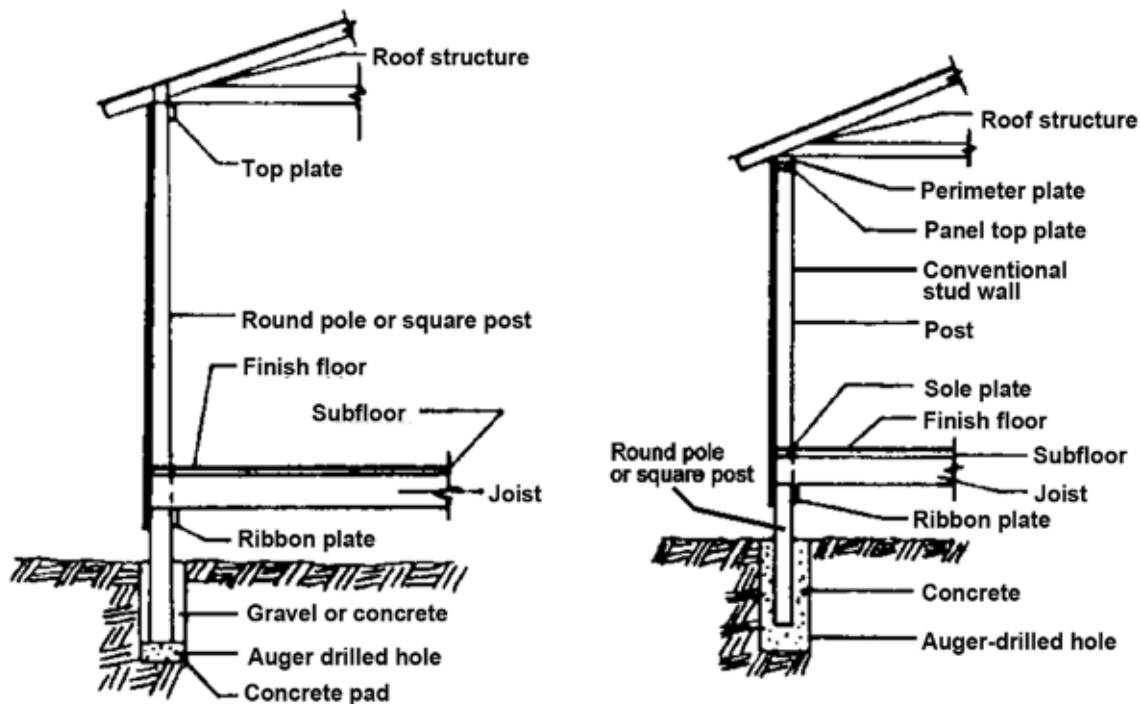

Figure 17-4. Pole and post-frame buildings: (left) pole or post forms both foundation and wall; (right) pole or post forms only the foundation for conventional platform-framed structure.

stiffness to the roof and transmits a portion of the lateral loading to the walls parallel to the direction of the load. Detailed information on the design of post-frame buildings is provided by the National Frame Builders Association (1999) or Walker and Woeste (1992).

Log Buildings

Interest is growing in log houses—from small, simple houses for vacation use to large, permanent residences (Fig. 17-5). Many U.S. firms specialize in the design and materials for log houses. Log houses nearly always feature wall systems built from natural or manufactured logs rather than from dimension lumber. Roof and floor systems may also be built with logs or conventional framing. Log house companies tend to categorize log types into two systems: round and shaped. In the round log system, the logs are machined to a smooth, fully rounded surface, and they are generally all the same diameter. In the shaped system, the logs are machined to specific shapes, generally not fully round. The exterior surfaces of the logs are generally rounded, but the interior surfaces may be either flat or round. The interface between logs is machined to form an interlocking joint.

Consensus standards have been developed for log grading and the assignment of allowable properties, and these standards are being adopted by building codes (ASTM 2009). Builders and designers need to realize that logs can reach the building site at moisture content levels greater than ideal. The effects of seasoning and the

consequences of associated shrinkage and checking must be considered. Additional information on log homes is available from The Log Home Council, National Association of Home Builders, Washington, D.C., or in *Standard on the Design and Construction of Log Structures* (ICC 2007).

Heavy Timber Buildings

Timber Frame

Timber frame houses were common in early America and are enjoying some renewed popularity today. Most barns and factory buildings dating prior to the middle of the 20th century were heavy timber frame. The traditional timber frame is made of large sawn timbers (larger than 114 by 114 mm (5 by 5 in.)) connected to one another by hand-fabricated joints, such as mortise and tenon. Construction of such a frame involves rather sophisticated joinery, as illustrated in Figure 17-6.

In today's timber frame home, a prefabricated, composite sheathing panel (1.2 by 2.4 m (4 by 8 ft)) is frequently applied directly to the frame. This panel may consist of an inside layer of 13-mm (1/2-in.) gypsum, a core layer of rigid foam insulation, and an outside layer of exterior plywood or OSB. Finish siding is applied over the composite panel. In some cases, a layer of standard 19-mm (nominal 1-in.) tongue-and-groove, solid-wood boards is applied to the frame, and a rigid, foam-exterior, plywood composite panel is then applied over the boards to form the building exterior.



Figure 17–5. Modern log homes are available in a variety of designs.

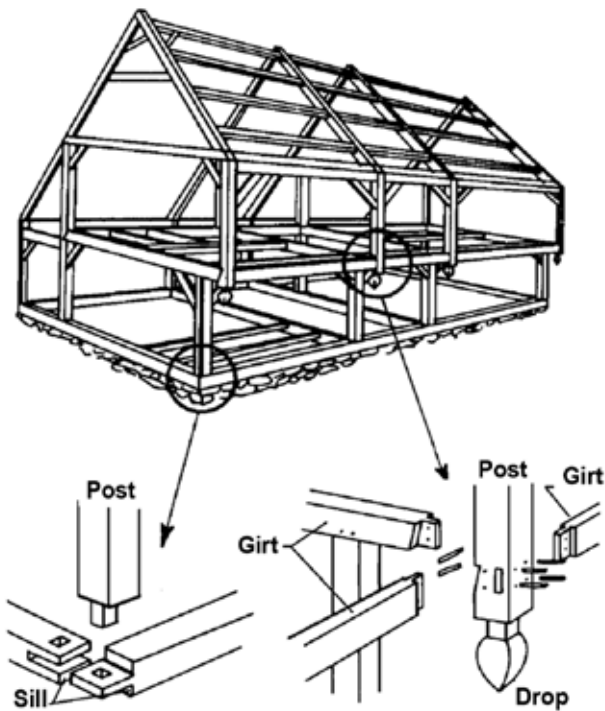

Figure 17–6. Timber frame structure with typical joint details.

Local fire regulations should be consulted about the acceptance of various foam insulations.

Framing members are cut in large cross sections; therefore, seasoning them before installation is difficult, if not impossible. Thus, the builder (and the owner) should recognize the dimensional changes that may occur as the members dry in place. The structure must be designed to accommodate these dimensional changes as well as seasoning checks, which are almost inevitable.

Mill Type

Mill-type construction has been widely used for warehouse and manufacturing structures, particularly in the eastern United States. This type of construction uses timbers of large cross sections with columns spaced in a grid according to the available lengths of beam and girder timbers. The size of the timbers makes this type of construction resistant to fire. The good insulating qualities of wood as well as the char that develops during fire result in slow penetration of fire into the large members. Thus, the members retain a large proportion of their original load-carrying capacity and stiffness for a relatively lengthy period after the onset of fire.

To be recognized as mill-type construction, the structural elements must meet specific sizes—columns cannot be less than standard 184 mm (nominal 8 in.) in dimension, and beams and girders cannot be less than standard 140 by 235 mm (nominal 6 by 10 in.) in cross section. Other limitations must be observed as well. For example, walls must be made of masonry, and concealed spaces must be avoided. The structural frame has typically been constructed of solid-sawn timbers, which should be stress graded. These timbers can now be supplanted with glulam timbers, and longer spans are permitted.

Glulam Beam

A panelized roof system using glulam roof framing is widely used for single-story commercial buildings in the southwestern United States. This system is based on supporting columns located at the corners of pre-established grids. The main glulam beams support purlins, which may be sawn timbers, glulam, parallel chord trusses, or prefabricated wood I-joists. These purlins, which are normally on 2.4-m (8-ft) centers, support preframed structural panels. The basic unit of the preframed system is a 1.2- by 2.4-m (4- by 8-ft) structural panel nailed to standard 38- by 89-mm or 38- by 140-mm (nominal 2- by 4-in. or 2- by 6-in.) stiffeners (subpurlins). The stiffeners run parallel to the 2.4-m (8-ft) dimension of the structural panel. One stiffener is located at the centerline of the panel; the other is located at an edge, with the plywood edge at the stiffener centerline. The stiffeners are precut to a length equal to the long dimension of the plywood less the thickness of the purlin, with a small allowance for the hanger.

In some cases, the purlins are erected with the hangers in place. The prefabricated panels are lifted and set into place in the hangers, and the adjoining basic panels are then attached to each other. In other cases, the basic panels are attached to one purlin on the ground. An entire panel is lifted into place to support the loose ends of the stiffeners. Additional details on this system and other glulam details are available from the American Institute of Timber Construction (www.aitc-glulam.org).

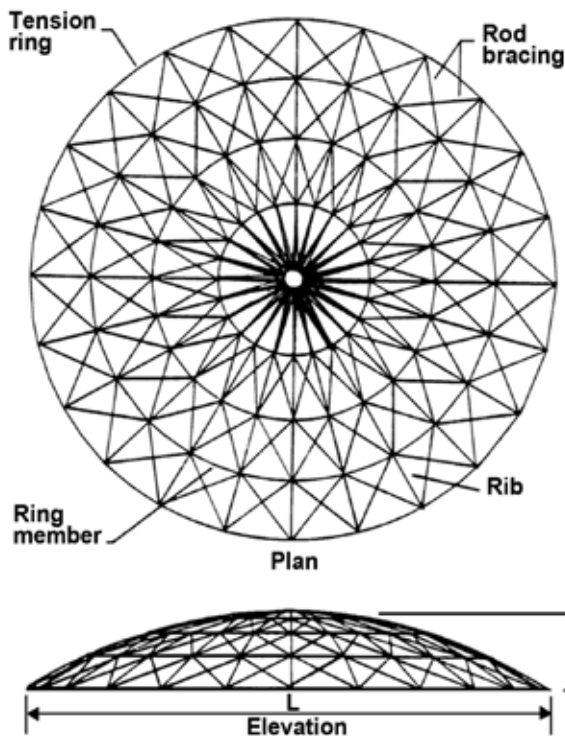

Figure 17-7. Member layout for a radial-rib dome.

Arch Structure

Arch structures are particularly suited to applications in which large, unobstructed areas are needed, such as churches, recreational buildings, and aircraft hangars. Many arch forms are possible with the variety limited only by the imagination of the architect. Churches have used arches from the beginning of glulam manufacture in the United States. Additional information on the use and design of arches is given in *The Timber Construction Manual* (AITC 2004).

Dome

Radial-rib domes consist of curved members extending from the base ring (tension ring) to a compression ring at the top of the dome along with other ring members at various elevations between the tension and compression rings (Fig. 17-7). The ring members may be curved or straight. If they are curved to the same radius as the rib and have their centers at the center of the sphere, the dome will have a spherical surface. If the ring members are straight, the dome will have an umbrella look. Connections between the ribs and the ring members are critical because of the high compressive loads in the ring members. During construction, care must be taken to stabilize the structure because the dome has a tendency to rotate about the central vertical axis.

Other dome patterns called Varax and Triax are also used. Their geometries are quite complex, and specialized computer programs are used in their design. Steel hubs used at the joints and supports are critical. An example of a Triax dome is shown in Figure 17-8.



Figure 17-8. This 161.5-m- (530-ft-) diameter Tacoma dome (Tacoma, Washington), built in 1982–1983, is one of the longest clear roof spans in the world. (Photo courtesy of Western Wood Structures, Inc., Tualatin, Oregon.)

Timber Bridges

Prior to the 20th century, timber was the major material used for both highway and railroad bridges. The development of steel and reinforced concrete provided other options, and these have become major bridge building materials. However, the U.S. inventory does contain a substantial number of timber bridges, many of which continue to carry loads beyond their design life. A recent initiative in the United States has focused research and technology transfer efforts on improving the design and performance of timber bridges. As a result, hundreds of timber highway bridges were built across the United States during the past several years, many using innovative designs and materials.

Bridges consist of a substructure and a superstructure. The substructure consists of abutments, piers, or piling, and it supports the superstructure that consists of stringers and/or a deck. The deck is often covered with a wearing surface of asphalt. Timber may be combined with other materials to form the superstructure, for example, timber deck over steel stringers. Several bridge railing systems were recently crash-tested and approved for use by the Federal Highway Administration (Faller and others 1999). Covered bridges are also undergoing a resurgence of interest, with a recent national program for the rehabilitation and restoration of numerous historic structures. The various types of timber bridge superstructures are described in the following sections. Detailed information on modern timber bridges is given in *Timber Bridges: Design, Construction, Inspection, and Maintenance* (Ritter 1992).

Log Stringer

A simple bridge type that has been used for centuries consists of one or more logs used to span the opening. Several logs may be laid side-by-side and fastened together. The log stringer bridge has been used to access logging areas and is advantageous when adequate-sized logs are available and the bridge is needed for only a short time. Unless built with a durable species, the life span of log stringer bridges is usually limited to less than 10 years.



Figure 17–9. Glulam beam bridge over the Dangerous River, near Yukatat, Alaska, consists of three 43.5-m (143-ft) spans. Each span is supported by four 2.3-m (91.5-in.-) deep glulam beams.

Sawn Lumber

Several types of bridges can be built with sawn lumber. Even though the span is usually limited to about 9 m (30 ft) because of the limited size of lumber available, this span length entails the majority of timber bridges in the United States.

Several timbers can be used to span the opening, and a transverse lumber deck can be placed over them to form a stringer and deck bridge. Lumber can be placed (on-edge) side-by-side and used to span the entire opening, forming a longitudinal deck bridge. The lumber can be fastened together with nails or large spikes in partial-width panelized bridge systems or compressed together with high-strength tension rods to form a “stress-laminated” slab-type deck.

Glulam

Structural glued-laminated (glulam) timber greatly extends the span capabilities of the same types of bridges described in the previous paragraph. Glulam stringers placed 0.6 to 1.8 m (2 to 6 ft) on center can support a glulam deck system and result in spans of 12 to 30 m (40 to 100 ft) or more (Fig. 17–9). Using glulam panels to span the opening results in a longitudinal deck system, but this is usually limited to about 9-m (30-ft) spans. These panels are either interconnected or supported at one or more locations with transverse distributor beams. Glulam beams can be used to form a solid deck and are held together with high-stress tension rods to form a stress-laminated slab-type deck. Curved glulam members can be used to produce various aesthetic effects and long-span bridges (Fig. 17–10).

Structural Composite Lumber

Two types of structural composite lumber (SCL)—laminated veneer and oriented strand—are beginning to be used to build timber bridges. Most of the same type of bridges built with either solid-sawn or glulam timber can be built with SCL (Chap. 11).

Considerations for Wood Buildings

Many factors must be considered when designing and constructing wood buildings, including structural, insulation, moisture, and sound control. The following sections provide a brief description of the design considerations for these factors. Fire safety, another important consideration, is addressed in Chapter 18.

Structural

The structural design of any building consists of combining the prescribed performance requirements with the anticipated loading. One major performance requirement is that there be an adequate margin of safety between the structure’s ultimate capacity and the maximum anticipated loading. The probability that the building will ever collapse is minimized using material property information recommended by the material manufacturers along with code-recommended design loads.

Another structural performance requirement relates to serviceability. These requirements are directed at ensuring that the structure is functional, and the most notable one is that deformations are limited. It is important to limit deformations so that floors are not too “bouncy” or that doors do not bind under certain loadings. Building codes often include recommended limits on deformation, but the designer may be provided some latitude in selecting the limits. The basic reference for structural design of wood in all building systems is the *National Design Specification for Wood Construction* (AF&PA 2005a).

Thermal Insulation and Air Infiltration Control

For most U.S. climates, the exterior envelope of a building needs to be insulated either to keep heat in the building or prevent heat from entering. Wood frame construction is well-suited to application of both cavity insulation and surface-applied insulation. The most common materials used for cavity insulation are glass fiber, mineral fiber, cellulose insulation, and spray-applied foams. For surface applications, a wide variety of sheathing insulations exist, such as rigid foam panels. Insulating sheathing placed on exterior walls may also have sufficient structural properties to provide required lateral bracing. Prefinished insulating paneling can be used as an inside finish on exterior walls or one or both sides of the interior partitions. In addition, prefinished insulation can underlay other finishes.

Attic construction with conventional rafters and ceiling joists or roof trusses can be insulated between framing members with batt, blanket, or loose-fill insulation. In some warm climates, radiant barriers and reflective insulations can provide an additional reduction in cooling loads. The “Radiant Barrier Attic Fact Sheet” from the U.S. Department of Energy (1991) provides information on climatic areas that are best suited for radiant barrier applications. This document also provides comparative information on



Figure 17–10. The Alton Saylor Memorial Bridge is a glulam deck arch bridge crossing Joncy Gorge in Angelica, New York. The center three-hinged arch spans 52 m (171 ft) and is the longest clear span in the United States. (Photo courtesy of Laminated Concepts, Inc., Big Flats, New York.)

the relative performance of these products and conventional fibrous insulations.

Existing frame construction can be insulated pneumatically using suitable loose-fill insulating material. When loose-fill materials are used in wall retrofit applications, extra care must be taken during the installation to eliminate the existence of voids within the wall cavity. All cavities should be checked prior to installation for obstructions, such as fire stop headers and wiring, that would prevent the cavity from being completely filled. Care must also be taken to install the material at the manufacturer's recommended density to ensure that the desired thermal performance is obtained. Accessible space can be insulated by manual placement of batt, blanket, or loose-fill material.

In addition to being properly insulated, the exterior envelope of all buildings should be constructed to minimize air flow into or through the building envelope. Air flow can degrade the thermal performance of insulation and cause excessive moisture accumulation in the building envelope.

More information on insulation and air flow retarders can be found in the ASHRAE *Handbook of Fundamentals*, chapters 22 to 24 (ASHRAE 2005).

Moisture Control

Moisture sources for buildings can be broadly classified as follows: (1) surface runoff of precipitation from land areas, (2) ground water or wet soil, (3) precipitation or irrigation water that falls on the building, (4) indoor humidity, (5) outdoor humidity, (6) moisture from use of wet building materials or construction under wet conditions, and (7) errors, accidents, and maintenance problems associated with indoor plumbing. At a given instant of time, the categories are distinct from each other. Water can change phase and

can be transported over space by various mechanisms. Water may therefore be expected to move between categories over time, blurring the distinctions between categories. Christian (1994) provides quantitative estimates of potential moisture loads from various sources.

Moisture accumulation within a building or within parts of a building can affect human comfort and health, influence building durability, and necessitate maintenance and repair activities (or can require that these activities be undertaken more frequently). Moisture accumulation in the building's thermal envelope is also likely to influence the building's energy performance. Some problems associated with moisture accumulation are easily observed. Examples include: (a) mold and mildew, (b) decay of wood-based materials, (c) corrosion of metals, (d) damage caused by expansion of materials from moisture (such as buckling of wood floors), and (e) decline in visual appearance (such as paint peeling, distortion of wood-based siding, or efflorescence on masonry surfaces). Some problems associated with moisture accumulation may not be readily apparent but are nonetheless real; an example is reduced performance of insulated assemblies (resulting in increased energy consumption). Detailed discussions on the effects and the control of moisture in buildings can be found in an ASTM standard (ASTM 2008), the ASHRAE *Handbook of Fundamentals*, chapters 23 and 24 (ASHRAE 2005), and Lstiburek and Carmody (1999).

Mold, Mildew, Dust Mites, and Human Health

Mold and mildew in buildings are offensive, and the spores can cause respiratory problems and allergic reactions in humans. Mold and mildew will grow on most surfaces if the relative humidity at the surface is above a critical value and the surface temperatures are conducive to growth. The longer the surface remains above this critical relative humidity level, the more likely mold will appear; the higher the humidity or temperature, the shorter the time needed for germination. The surface relative humidity is a complex function of material moisture content, material properties, local temperature, and humidity conditions. In addition, mold growth depends on the type of surface. Mildew and mold can usually be avoided by limiting surface relative humidity conditions >80% to short periods. Only for nonporous surfaces that are regularly cleaned should this criterion be relaxed. Most molds grow at temperatures approximately above 4 °C (40 °F). Moisture accumulation at temperatures below 4 °C (40 °F) may not cause mold and mildew if the material is allowed to dry out below the critical moisture content before the temperature increases above 4 °C (40 °F).

Dust mites can trigger allergies and are an important cause of asthma. They thrive at high relative humidity levels (>70%) at room temperature, but will not survive at sustained relative humidity levels less than 50%. However, these relative humidity levels relate to local conditions in the typical places that mites tend to inhabit (for example, mattresses, carpets, soft furniture).

Paint Failure and Other Appearance Problems

Moisture trapped behind paint films may cause failure of the paint (Chap. 16). Water or condensation may also cause streaking or staining. Excessive swings in moisture content of wood-based panels or boards may cause buckling or warp. Excessive moisture in masonry and concrete can produce efflorescence, a white powdery area or lines. When combined with low temperatures, excessive moisture can cause freeze–thaw damage and spalling (chipping).

Structural Failures

Structural failures caused by decay of wood are rare but have occurred. Decay generally requires a wood moisture content equal to or greater than fiber saturation (usually about 30%) and temperatures between 10 and 43 °C (50 and 100 °F). Wood moisture content levels above fiber saturation are only possible in green lumber or by absorption of liquid water from condensation, leaks, ground water, or other saturated materials in contact with the wood. To maintain a safety margin, a 20% moisture content is sometimes used during field inspections as the maximum allowable level. Once established, decay fungi produce water that enables them to maintain moisture conditions conducive to their growth. See Chapter 14 for more information on wood decay.

Rusting or corrosion of nails, nail plates, or other metal building products is also a potential cause of structural failure. In the rare cases of catastrophic structural failure of wood buildings (almost always under the influence of a large seismic load or an abnormally high wind load), failure of mechanical connections usually plays a critical role. Corrosion may occur at high relative humidity levels near the metal surface or as a result of liquid water from elsewhere. Wood moisture content levels >20% encourage corrosion of steel fasteners in wood, especially if the wood is treated with preservatives. In buildings, metal fasteners are often the coldest surfaces, which encourages condensation on, and corrosion of, fasteners.

Effect on Heat Flow

Moisture in the building envelope can significantly degrade the thermal performance of most insulation materials but especially the thermal resistance of fibrous insulations and open cell foams. The degradation is most pronounced when daily temperature reversals across the insulation drive moisture back and forth through the insulation.

Moisture Control Strategies

Strategies to control moisture accumulation fall into two general categories: (1) minimize moisture entry into the building envelope and (2) provide for removal (dissipation) of moisture from the building envelope. Inasmuch as building materials and assemblies are often wetted during construction, design strategies that encourage dissipation of moisture from the assemblies are highly recommended. Such strategies will also allow the building to better withstand wetting events that occur rarely, and thus are largely

unanticipated, but which nonetheless occur at least once during the building's lifespan. Effective moisture dissipation strategies typically involve drainage and ventilation.

The transport mechanisms that can move moisture into or out of building envelopes have various transport capabilities. The mechanisms, in order of the quantities of moisture that they can move, are as follows: (a) liquid water movement, including capillary movement; (b) water vapor transport by air movement; and (c) water vapor diffusion. Trechsel (2001) discusses these in detail. In design for control of moisture entry, it is logical to prioritize control of the transport mechanisms in the order of their transport capabilities. A logical prioritization is thus as follows: (a) control of liquid entry by proper site grading and installing gutters and downspouts and appropriate flashing around windows, doors, and chimneys; (b) control of air leakage by installing air flow retarders or careful sealing by taping and caulking; and (c) control of vapor diffusion by placing vapor retarders on the “warm” side of the insulation. Trechsel (2001) makes the point that although air leakage can potentially move much greater amounts of moisture than diffusion, the potential for moisture damage is not necessarily proportional to the amount of moisture movement, and thus that moisture diffusion in design of building envelopes should not be ignored.

In inhibiting vapor diffusion at the interior surfaces of building assemblies in heating climates (or alternatively, encouraging such diffusion at interior surfaces of building assemblies in cooling climates), control of indoor humidity levels is usually important. In heating climates, ventilation of the living space with outdoor air and limiting indoor sources of moisture (wet firewood, unvented dryers, humidifiers) will lower indoor humidity levels. This is very effective at lowering the rate of moisture diffusion into the building's thermal envelope. In cooling climates, the lower indoor humidity levels afforded by mechanical dehumidification will encourage dissipation of moisture (to the interior) from the building's thermal envelope. More information on the definition of heating and cooling climates and specific moisture control strategies can be found in the *ASHRAE Handbook of Fundamentals*, chapter 24 (ASHRAE 2005).

Sound Control

An important design consideration for residential and office buildings is the control of sound that either enters the structure from outside or is transmitted from one room to another. Wood frame construction can achieve levels of sound control equal to or greater than more massive construction, such as concrete. However, to do so requires designing for both airborne and impact noise insulation.

Airborne noise insulation is the resistance to transmission of airborne noises, such as traffic or speech, either through or around an assembly such as a wall. Noises create vibrations on the structural surfaces that they contact, and the design challenge is to prevent this vibration from reaching and

Table 17–1. Sound transmission class (STC) ratings for typical wood-frame walls

STC rating	Privacy afforded	Wall structure
25	Normal speech easily understood	6-mm (1/4-in.) wood panels nailed on each side of standard 38- by 89-mm (nominal 2- by 4-in.) studs.
30	Normal speech audible but not intelligible	9.5-mm (3/8-in.) gypsum wallboard nailed to one side of standard 38- by 89-mm (nominal 2- by 4-in.) studs.
35	Loud speech audible and fairly understandable	20-mm (5/8-in.) gypsum wallboard nailed to both sides of standard 38- by 89-mm (nominal 2- by 4-in.) studs.
40	Loud speech audible but not intelligible	Two layers of 20-mm (5/8-in.) gypsum wallboard nailed to both sides of standard 38- by 89-mm (nominal 2- by 4-in.) studs.
45	Loud speech barely audible	Two sets of standard 38- by 64-mm (nominal 2- by 3-in.) studs staggered 0.2 m (8 in.) on centers fastened by standard 38- by 89-mm (nominal 2- by 4-in.) base and head plates with two layers of 20-mm (5/8-in.) gypsum wallboard nailed on the outer edge of each set of studs.
50	Shouting barely audible	Standard 38- by 89-mm (nominal 2- by 4-in.) wood studs with resilient channels nailed horizontally to both sides with 20-mm (5/8-in.) gypsum wallboard screwed to channels on each side.
55	Shouting not audible	Double row of standard 38- by 89-mm (nominal 2- by 4-in.) studs 0.4 m (16 in.) on centers fastened to separate plates spaced 25 mm (1 in.) apart. Two layers of 20-mm (5/8-in.) gypsum wallboard screwed 0.3 m (12 in.) on center to the studs. An 89-mm- (3.5-in.-) thick sound-attenuation blanket installed in one stud cavity.

leaving the opposite side of the structural surface. Sound transmission class (STC) is the rating used to characterize airborne noise insulation. A wall system with a high STC rating is effective in preventing the transmission of sound. Table 17–1 lists the STC ratings for several types of wall systems; detailed information for both wall and floor are given in FPL–GTR–43 (Rudder 1985).

Impact noise insulation is the resistance to noise generated by footsteps or dropping objects, generally addressed at floor–ceiling assemblies in multi-family dwellings. Impact insulation class (IIC) is the rating used to characterize the impact noise insulation of an assembly. Both the character of the flooring material and the structural details of the floor influence the IIC rating. Additional information on IIC ratings for wood construction is given in FPL–GTR–59 (Sherwood and Moody 1989).

Literature Cited

AF&PA. 2001. Wood frame construction manual for one- and two-family dwellings, 2001 edition. Washington, DC: American Forest & Paper Association.

AF&PA. 2005a. National design specification for wood construction. Washington, DC: American Forest & Paper Association.

AF&PA. 2005b. Span tables for joists and rafters. Washington, DC: American Forest & Paper Association.

AF&PA. 2007. Permanent wood foundation design specification. Washington, DC: American Forest & Paper Association.

AITC. 2004. Timber construction manual, 5th edition. American Institute of Timber Construction. New York: John Wiley & Sons, Inc.

APA. 2007. Engineered wood construction guide: floor construction. Section 2, Form E30. September 2007. Tacoma, WA: APA–The Engineered Wood Association.

ASHRAE. 2005. Handbook of fundamentals. Atlanta, GA: American Society of Heating, Refrigerating and Air-Conditioning Engineers.

ASTM. 2008. Standard guide for limiting water-induced damage to buildings. ASTM E241-08. West Conshohocken, PA: American Society for Testing and Materials.

ASTM. 2009. Standard methods for establishing stress grades for structural members used in log buildings. ASTM D3957-09. West Conshohocken, PA: American Society for Testing and Materials.

AWC. 2009. Prescriptive wood deck construction guide. Washington, DC: American Wood Council.

Christian, J.E. 1994. Moisture sources. Chapter 8 in moisture control in buildings, ASTM MNL18 (ISBN 0-8031-2051-6). Philadelphia, PA: American Society for Testing and Materials.

Faller, R.K.; Ritter, M.A.; Rosson, B.T.; Duwadi, S.R. 1999. Railing systems for use on timber deck bridges. Underground and other structural design issues. Washington, D.C.: National Academy Press. Transportation research record 1656. pp. 110–119.

Chapter 17 Use of Wood in Buildings and Bridges

ICC. 2007. Standard on the design and construction of log structures. ICC400-2007. Washington, DC: International Code Council.

Lstiburek, J.; Carmody, J. 1999. Moisture control handbook: principles and practices for residential and small commercial buildings. New York: Wiley.

McDonald, K.A.; Falk, R.H.; Williams, R.S.; Winandy, J.E. 1996. Wood decks: materials, construction, and finishing. Madison, WI: Forest Products Society.

National Frame Builders Association. 1999. Post frame building design manual. Glenview, IL: National Frame Builders Association.

Ritter, M.A. 1992. Timber bridges—design, construction, inspection and maintenance. EM 7700–8. Washington, DC: U.S. Department of Agriculture, Forest Service, Engineering Staff.

Rudder, F.F. Jr. 1985. Airborne sound transmission loss characteristics of wood-frame construction. Gen. Tech. Rep. FPL–GTR–43. Madison, WI: U.S. Department of Agriculture, Forest Service, Forest Products Laboratory.

Sherwood, G.E.; Moody, R.C. 1989. Light-frame wall and floor systems—analysis and performance. Gen. Tech. Rep. FPL–GTR–59. Madison, WI: U.S. Department of Agriculture, Forest Service, Forest Products Laboratory.

Sherwood, G.E.; Stroh, R.C. 1989. Wood frame house construction. Agric. Handb. 73. Washington, DC: U.S. Government Printing Office. (Also available from Armonk Press, Armonk, NY.)

TPI. 2007. National design standards for metal plate connected wood truss construction. ANSI/TPI 1–2007. Alexandria, VA: Truss Plate Institute.

Trechsel, H.R. 2001. Moisture primer. Chapter 1 in moisture analysis and condensation control in buildings. ASTM MNL40 (ISBN 0-8031-2089-3). West Conshohocken, PA: ASTM International.

U.S. Department of Energy. 1991. Radiant barrier attic fact sheet. Oak Ridge, TN: Oak Ridge National Laboratory.

Walker, J.N.; Woeste, F.E. 1992. Post-frame building design. ASAE Monograph No. 11. St. Joseph, MI: American Society of Agricultural and Biological Engineers.

Fire Safety of Wood Construction

Robert H. White, Research Forest Products Technologist

Mark A. Dietenberger, Research General Engineer

Contents

Fire Safety Design and Evaluation	18–1
Types of Construction	18–2
Ignition	18–2
Exterior Fire Exposure in the Wildland–Urban Interface	18–3
Fire Growth Within Compartment	18–3
Containment to Compartment of Origin	18–6
Fire-Performance Characteristics of Wood	18–8
Thermal Degradation of Wood	18–8
Ignition	18–9
Heat Release and Smoke	18–11
Flame Spread	18–12
Charring and Fire Resistance	18–13
Fire-Retardant-Treated Wood	18–15
Pressure Treatments	18–15
Performance Requirements	18–16
Fire-Retardant Coatings	18–17
Literature Cited	18–18
Additional References	18–18
General	18–18
Fire Test Standards	18–19
Ignition	18–19
Flame Spread	18–20
Flashover and Room/Corner Tests	18–20
Heat Release and Heat of Combustion	18–20
Combustion Products	18–21
Fire Resistance	18–21
Fire-Retardant-Treated Wood	18–22

Fire safety is an important concern in all types of construction. The high level of national concern for fire safety is reflected in limitations and design requirements in building codes. These code requirements and related fire performance data are discussed in the context of fire safety design and evaluation in the initial section of this chapter. Because basic data on fire behavior of wood products are needed to evaluate fire safety for wood construction, the second major section of this chapter provides additional information on fire behavior and fire performance characteristics of wood products. The chapter concludes with a discussion of fire-retardant treatments that can be used to reduce the combustibility of wood.

Fire Safety Design and Evaluation

Fire safety involves prevention, detection, evacuation, containment, and extinguishment. Fire prevention basically means preventing the sustained ignition of combustible materials by controlling either the source of heat or the combustible materials. This involves proper design, installation or construction, and maintenance of the building and its contents. Proper fire safety measures depend upon the occupancy or processes taking place in the building. Smoke and heat detectors can be installed to provide early detection of a fire. Early detection is essential for ensuring adequate time for egress. Egress, or the ability to escape from a fire, often is a critical factor in life safety. Statutory requirements pertaining to fire safety are specified in building codes or fire codes. Design deficiencies are often responsible for spread of heat and smoke in a fire. Spread of a fire can be prevented with designs that limit fire growth and spread within a compartment and contain fire to the compartment of origin. Sprinklers provide improved capabilities to extinguish a fire in its initial stages. These requirements fall into two broad categories: material requirements and building requirements. Material requirements include such things as combustibility, flame spread, and fire resistance. Building requirements include area and height limitations, firestops and draftstops, doors and other exits, automatic sprinklers, and fire detectors.

Adherence to codes will result in improved fire safety. Code officials should be consulted early in the design of a building because the codes offer alternatives. For example, floor areas can be increased if automatic sprinkler systems are added. Code officials have the option to approve alternative materials and methods of construction and to modify

provisions of the codes when equivalent fire protection and structural integrity are documented.

Most current building codes in the United States are based on the model building code produced by the International Code Council (ICC) (*International Building Code*® (IBC)) and related *International Code*® (I-Codes®) documents). In addition to the documents of the ICC, the National Fire Protection Association's (NFPA's) Life Safety Code (NFPA 101) provides guidelines for life safety from fire in buildings and structures. NFPA also has a model building code known as NFPA 5000. The provisions of the ICC and NFPA documents become statutory requirements when adopted by local or state authorities having jurisdiction.

Information on fire ratings for different products and assemblies can be obtained from industry literature, evaluation reports issued by ICC Evaluation Service, Inc. (ICC-ES) and other organizations, and listings published by testing laboratories or quality assurance agencies. Products listed by Underwriters Laboratories, Inc. (UL), Intertek, and other such organizations are stamped with the rating information.

The field of fire safety engineering is undergoing rapid changes because of the development of more engineering and scientific approaches to fire safety. This development is evidenced by the publication of the fourth edition of *The Society of Fire Protection Engineers (SFPE) Handbook of Fire Protection Engineering*. Steady advances are being made in the fields of fire dynamics, fire hazard calculations, fire design calculations, and fire risk analysis. Such efforts support the worldwide trend to develop alternative building codes based on performance criteria rather than prescriptive requirements. Additional information on fire protection can be found in various publications of the NFPA and SFPE.

In the following sections, various aspects of building code provisions pertaining to fire safety of building materials are discussed under the broad categories of (a) types of construction, (b) ignition, (c) fire growth within compartment, (d) containment to compartment of origin, and (e) exterior fires. These are largely requirements for materials. Information on prevention and building requirements not related to materials (for example, detection) can be found in NFPA publications.

Types of Construction

A central aspect of the fire safety provisions of building codes is the classification of buildings by types of construction and use or occupancy. Based on classifications of building type and occupancy, the codes set limits on areas and heights of buildings. Building codes generally recognize five classifications of construction based on types of materials and required fire resistance ratings. The two classifications known as Type I (fire-resistant construction) and Type II (noncombustible construction) basically restrict the building elements to noncombustible materials. Wood is permitted to be used more liberally in the other three

classifications, which are Type III (ordinary), Type IV (heavy timber), and Type V (light-frame). Type III construction allows smaller wood members to be used for interior walls, floors, and roofs including wood studs, joists, trusses, and I-joists. For Type IV (heavy timber) construction, interior wood columns, beams, floors, and roofs are required to satisfy certain minimum dimensions and no concealed spaces are permitted. In both Types III and IV construction, exterior walls must be of noncombustible materials, except that fire-retardant-treated (FRT) wood is permitted within exterior wall assemblies of Type III construction when the requirements for fire resistance ratings are 2-h or less. In Type V construction, walls, floors, and roofs may be of any dimension lumber and the exterior walls may be of combustible materials. Types I, II, III, and V constructions are further subdivided into two parts—A (protected) and B (unprotected), depending on the required fire resistance ratings. In Type V-A (protected light-frame) construction, most of the structural elements have a 1-h fire resistance rating. No general fire resistance requirements are specified for buildings of Type V-B (unprotected light-frame) construction. The required fire resistance ratings for exterior walls also depend on the fire separation distance from the lot line, centerline of the street, or another building. Such property line setback requirements are intended to mitigate the risk of exterior fire exposure.

Based on their performance in the ASTM E 136 test (see list of fire test standards at end of chapter), both untreated and FRT wood are combustible materials. However, building codes permit substitution of FRT wood for noncombustible materials in some specific applications otherwise limited to noncombustible materials. Specific performance and treatment requirements are defined for FRT wood used in such applications.

In addition to type of construction, height and area limitations also depend on the use or occupancy of a structure. Fire safety is improved by automatic sprinklers, property line setbacks, or more fire-resistant construction. Building codes recognize the improved fire safety resulting from application of these factors by increasing allowable areas and heights beyond that designated for a particular type of construction and occupancy. Thus, proper site planning and building design may result in a desired building area classification being achieved with wood construction.

Ignition

The most effective ways to improve fire safety are preventive actions that will reduce or eliminate the risks of ignition. Some code provisions, such as those in electrical codes, are designed to address this issue. Other such provisions are those pertaining to separations between heated pipes, stoves, and similar items and any combustible material. In situations of prolonged exposures and confined spaces, wood has been known to ignite at temperatures much lower than the temperatures normally associated with

wood ignition. To address this concern, a safe margin of fire safety from ignition even in cases of prolonged exposures can be obtained if surface temperatures of heated wood are maintained below about 80 °C, which avoids the incipient wood degradation associated with reduction in the ignition temperature.

Other examples of regulations addressing ignition are requirements for the proper installation and treatment of cellulosic installation. Proper chemical treatments of cellulosic insulation are required to reduce its tendency for smoldering combustion and to reduce flame spread. Cellulosic insulation is regulated by a product safety standard of the U.S. Consumer Product Safety Commission. One of the required tests is a smoldering combustion test. Proper installation around recessed light fixtures and other electrical devices is necessary.

Exterior Fire Exposure in the Wildland–Urban Interface

In areas subjected to wildfires, actions to remove ignition sources around the home or other structures and prevent easy fire penetration into such buildings can significantly improve the chances that a structure will survive a wildfire. This includes appropriate landscaping to create a defensible space around the structure. Particular attention should be paid to the removal of vegetation and other combustible exterior items (such as firewood, fence, landscape mulch) that are close to openings (vents, windows, and doors), combustible surfaces of the building, and soffits. Openings in building exteriors can allow the fire to penetrate into the building and cause interior ignitions. Building design and maintenance should be done to limit the accumulation of combustible debris that could be ignited by firebrands that originate from burning trees and buildings, with particular attention paid to nooks and crannies that allow accumulation of debris. The firebrands' distribution is such that they can cause destruction of unprotected structures that are some distance from the actual flames of the wildfire. Regardless of the type of material used for the exterior membrane, the type and placement of the joints of the membrane can affect the likelihood that a fire will penetrate the exterior membrane. For example, birdstops should be installed at the ends of clay tile barrel roof coverings to prevent firebrands from igniting the underlining substrate.

Rated roof covering materials are designated Class A, B, or C according to their performance in the tests described in ASTM E 108, *Fire Tests of Roof Coverings*. This test standard includes intermittent flame exposure, spread of flame, burning brand, flying brand, and rain tests. Each of the three classes has a different version of the pass–fail test. The Class A test is the most severe, Class C the least. In the case of the burning brand tests, the brand for the Class B test is larger than that for the Class C test. FRT wood shingles and shakes are available that carry a Class B or C fire rating. A Class A rated wood roof system can be achieved by using

Class B wood shingles with specified roof deck and underlayment.

For other exterior applications, FRT wood is tested in accordance with ASTM E 84. An exterior treatment is required to have no increase in the listed flame spread index after being subjected to the rain test of ASTM D 2898. At the present time, a commercial treated-wood product for exterior applications is either treated to improve fire retardancy or treated to improve resistance to decay and insects, not both.

Various websites (such as www.firewise.org) provide additional information addressing the protection of homes in the wildland–urban interface. The national Firewise Communities program is a multi-agency effort designed to reach beyond the fire service by involving homeowners, community leaders, planners, developers, and others in the effort to protect people, property, and natural resources from the risk of wildland fire, before a fire starts. The Firewise Communities approach emphasizes community responsibility for planning in the design of a safe community and effective emergency response, along with individual responsibility for safer home construction and design, landscaping, and maintenance.

The ICC's International Wildland–Urban Interface Code provides model code regulations that specifically address structures and related land use in areas subjected to wildfires. NFPA 1144 is a standard that focuses on individual structure hazards from wildland fires. In response to losses due to wildfires, the California State Fire Marshal's Office (www.fire.ca.gov) has implemented ignition-resistant construction standards for structures in the wildland–urban interface. These test requirements intended to address ignitability of the structure are based on tests developed at the University of California for exterior wall siding and sheathing, exterior windows, under eave, and exterior decking.

Fire Growth within Compartment

Flame Spread

Important provisions in the building codes are those that regulate the exposed interior surface of walls, floors, and ceilings (that is, the interior finish). Codes typically exclude trim and incidental finish, as well as decorations and furnishings that are not affixed to the structure, from the more rigid requirements for walls and ceilings. For regulatory purposes, interior finish materials are classified according to their flame spread index. Thus, flame spread is one of the most tested fire performance properties of a material. Numerous flame spread tests are used, but the one cited by building codes is ASTM E 84 (also known as NFPA 255 and UL 723), the “25-ft tunnel” test. In this test method, the 508-mm-wide, 7.32-m-long specimen completes the top of the tunnel furnace. Flames from a burner at one end of the tunnel provide the fire exposure, which includes forced draft conditions. The furnace operator records the flame front position as a function of time and the time of maximum flame front travel during a 10-min period. The standard

Table 18–1. ASTM E 84 flame spread indexes for 19-mm-thick solid lumber of various wood species as reported in the literature^a

Species ^b	Flame spread index ^c	Smoke developed index ^c	Source ^d
Softwoods			
Yellow-cedar (Pacific Coast yellow cedar)	78	90	CWC
Baldcypress (cypress)	145–150	—	UL
Douglas-fir	70–100	—	UL
Fir, Pacific silver	69	58	CWC
Hemlock, western (West Coast)	60–75	—	UL
Pine, eastern white (eastern white, northern white)	85, 120–215 ^f	122, —	CWC, UL
Pine, lodgepole	93	210	CWC
Pine, ponderosa	105–230 ^e	—	UL
Pine, red	142	229	CWC
Pine, Southern (southern)	130–195 ^f	—	UL
Pine, western white	75 ^f	—	UL
Redcedar, western	70	213	HPVA
Redwood	70	—	UL
Spruce, eastern (northern, white)	65	—	UL, CWC
Spruce, Sitka (western, Sitka)	100, 74	—, 74	UL, CWC
Hardwoods			
Birch, yellow	105–110	—	UL
Cottonwood	115	—	UL
Maple (maple flooring)	104	—	CWC
Oak (red, white)	100	100	UL
Sweetgum (gum, red)	140–155	—	UL
Walnut	130–140	—	UL
Yellow-poplar (poplar)	170–185	—	UL

^aAdditional data for domestic solid-sawn and panel products are provided in the AF&PA–AWC DCA No. 1, “Flame Spread Performance of Wood Products.”

^bIn cases where the name given in the source did not conform to the official nomenclature of the Forest Service, the probable official nomenclature name is given and the name given by the source is given in parentheses.

^cData are as reported in the literature (dash where data do not exist). Changes in the ASTM E 84 test method have occurred over the years. However, data indicate that the changes have not significantly changed earlier data reported in this table. The change in the calculation procedure has usually resulted in slightly lower flame spread results for untreated wood. Smoke developed index is not known to exceed 450, the limiting value often cited in the building codes.

^dCWC, Canadian Wood Council (CWC 1996); HPVA, Hardwood Plywood Manufacturers Association (Tests) (now Hardwood Plywood & Veneer Assoc.); UL, Underwriters Laboratories, Inc. (Wood-fire hazard classification. Card Data Service, Serial No. UL 527, 1971).

^eFootnote of UL: In 18 tests of ponderosa pine, three had values over 200 and the average of all tests is 154.

^fFootnote of UL: Due to wide variations in the different species of the pine family and local connotations of their popular names, exact identification of the types of pine tested was not possible. The effects of differing climatic and soil conditions on the burning characteristics of given species have not been determined.

prescribes a formula to convert these data to a flame spread index (FSI), which is a measure of the overall rate of flame spreading in the direction of air flow. In the building codes, the classes for flame spread index are A (FSI of 0 to 25), B (FSI of 26 to 75), and C (FSI of 76 to 200). Generally, codes specify FSI for interior finish based on building occupancy, location within the building, and availability of automatic sprinkler protection. The more restrictive classes, Classes A and B, are generally prescribed for stairways and corridors that provide access to exits. In general, the more flammable classification (Class C) is permitted for the interior finish of other areas of the building that are not considered exit ways or where the area in question is protected by automatic

sprinklers. In other areas, no flammability restrictions are specified on the interior finish, and unclassified materials (that is, more than 200 FSI) can be used. The classification labels of I, II, and III have been used instead of A, B, and C.

The FSI for most domestic wood species is between 90 and 160 (Table 18–1). Thus, unfinished lumber, 10 mm or thicker, is generally acceptable for interior finish applications requiring a Class C rating. Fire-retardant treatments are necessary when a Class A flame spread index is required for a wood product. Some domestic softwood species meet the Class B flame spread index without treatment. Other domestic softwood species have FSIs near the upper limit of 200 for Class C. All available data for domestic hardwoods

Chapter 18 Fire Safety of Wood Construction

are for Class C. Some high-density imported hardwood species have FSIs in Class B. Additional FSI data for domestic solid-sawn and panel products are provided in the American Forest and Paper Association (AF&PA)—American Wood Council (AWC) design for code acceptance (DCA) No. 1 (see list of references at end of chapter). Report 128 of APA—The Engineered Wood Association (APA) discusses the flame spread indexes of construction plywood panels.

Code provisions pertaining to floors and floor coverings include those based on the critical radiant flux test (ASTM E 648). In the critical radiant flux test, the placement of the radiant panel is such that the radiant heat being imposed on the surface has a gradient in intensity down the length of the horizontal specimen. Flames spread from the ignition source at the end of high heat flux (or intensity) to the other end until they reach a location where the heat flux is not sufficient for further propagation. This is reported as the critical radiant flux (CRF). Thus, low CRF reflects materials with high flammability.

Depending on location and occupancy, building code requirements are for a minimum critical radiant flux level of 2.2 kW m^{-2} (0.22 W cm^{-2}) for Class II or 4.5 kW m^{-2} (0.45 W cm^{-2}) for Class I. These provisions are mainly intended to address the fire safety of some carpets. One section in the International Building Code (IBC) (Sec. 804) where this method is cited exempts wood floors and other floor finishes of a traditional type from the requirements. This method is also cited in standards of the National Fire Protection Association (NFPA) such as the Life Safety Code. Very little generic data is published on wood products tested in accordance with ASTM E 648. In one report published during the development of the test, a CRF of approximately 3.5 to 4.0 kW m^{-2} was cited for oak flooring (Benjamin and Davis 1979). Company literature for proprietary wood floor products indicates that such products can achieve CRF in excess of the 4.5 kW m^{-2} for Class I. For wood products tested in accordance with the similar European radiant panel test standard (EN ISO 9239-1 (2002)) (Östman and Mikkola 2006, Tsantaridis and Östman 2004), critical heat flux (CHF) ranged from 2.6 to 5.4 kW m^{-2} for 25 wood floorings tested without a surface coating. Most densities ranged from 400 to 600 kg m^{-3} . One additional wood flooring product had a CHF of 6.7 kW m^{-2} . Additional results for the wood flooring products tested with a wide range of coating systems indicated that the non-fire-retardant coatings may significantly improve the CHF to levels above 4.5 kW m^{-2} .

The critical radiant flux apparatus is also used to test the flammability of cellulosic insulation (ASTM E 970). There are many other test methods for flame spread or flammability. Most are used only for research and development or quality control, but some are used in product specifications and regulations of materials in a variety of applications.



Figure 18-1.
Flashover in
standard room
test.

Other tests for flammability include those that measure heat release.

Flashover

With sufficient heat generation, the initial growth of a fire in a compartment leads to the condition known as flashover. The visual criteria for flashover are full involvement of the compartment and flames out the door or window (Figure 18-1). The intensity over time of a fire starting in one room or compartment of a building depends on the amount and distribution of combustible contents in the room and the amount of ventilation.

The standard full-scale test for pre-flashover fire growth is the room-corner test (ASTM E 2257). In this test, a gas burner is placed in the corner of the room, which has a single door for ventilation. Three of the walls are lined with the test material, and the ceiling may also be lined with the test material. Other room-corner tests use a wood crib or similar item as the ignition source. Such a room-corner test is used to regulate foam plastic insulation, a material that is not properly evaluated in the ASTM E 84 test. Observations are made of the growth of the fire and the duration of the test until flashover occurs. Instruments record the heat generation, temperature development within the room, and the heat flux to the floor. Results of full-scale room-corner tests are used to validate fire growth models and bench-scale test results. In a series of room-corner tests using a 100/300-kW burner and no test material on the ceiling, the ranking of the different wood products was consistent with their flame spread index in the ASTM E 84 test (White and others 1999). Another room-corner test standard (NFPA 286) is cited in codes as an alternative to ASTM E 84 for evaluating interior wall or ceiling finishes for Class A applications.

Smoke and Toxic Gases

One of the most important problems associated with evacuation during a fire is the smoke produced. The term smoke is frequently used in an all-inclusive sense to mean the mixture of pyrolysis products and air that is present near the fire site. In this context, smoke contains gases, solid particles, and droplets of liquid. Smoke presents potential hazards because it interacts with light to obscure vision and because it contains noxious and toxic substances. Generally, two approaches are used to deal with the smoke problem: limit smoke production and control the smoke that has been produced. The control of smoke flow is most often a factor in the design and construction of large or tall buildings. In these buildings, combustion products may have serious effects in areas remote from the actual fire site.

The smoke yield restrictions in building codes are also based on data from the ASTM E 84 standard. Smoke measurement is based on a percentage attenuation of white light passing through the tunnel exhaust stream and detected by a photocell. This is converted to the smoke developed index (SDI), with red oak flooring set at 100. Flame spread requirements for interior finish generally are linked to an added requirement that the SDI be less than 450. Available SDI data for wood products are less than 450 (Table 18–1).

In the 1970s, the apparatus known as the NBS smoke chamber was developed and approved as an ASTM standard for research and development (ASTM E 662). This test is a static smoke test because the specimen is tested in a closed chamber of fixed volume and the light attenuation is recorded over a known optical path length. The corresponding light transmission is reported as specific optical density as a function of time. Samples are normally tested in both flaming (pilot flame) and nonflaming conditions using a radiant flux of 25 kW m^{-2} . Some restrictions in product specifications are based on the smoke box test (ASTM E 662). As discussed in a later section, dynamic measurements of smoke can be obtained with the cone calorimeter (ASTM E 1354) and the room-corner test (ASTM E 2257).

Toxicity of combustion products is a concern. Fire victims are often not touched by flames but die as a result of exposure to smoke, toxic gases, or oxygen depletion. These life-threatening conditions can result from burning contents, such as furnishings, as well as from the structural materials involved. The toxicity resulting from the thermal decomposition of wood and cellulosic substances is complex because of the wide variety of types of wood smoke. Composition and the concentration of individual constituents depend on such factors as the fire exposure, oxygen and moisture present, species of wood, any treatments or finishes that may have been applied, and other considerations. The vast majority of fires that attain flashover do generate dangerous levels of carbon monoxide, independent of what is burning. Carbon monoxide is a particularly insidious toxic gas and is often generated in significant amounts in wood fires. Small

amounts of carbon monoxide are particularly toxic because the hemoglobin in the blood is much more likely to combine with carbon monoxide than with oxygen, even with plenty of breathable oxygen (carboxyhemoglobin) present.

Containment to Compartment of Origin

The growth, intensity, and duration of the fire is the “load” that determines whether a fire is confined to the room of origin. Whether a given fire will be contained to the compartment depends on the fire resistance of the walls, doors, ceilings, and floors of the compartment. Requirements for fire resistance or fire resistance ratings of structural members and assemblies are another major component of the building code provisions. In this context, fire resistance is the ability of materials or their assemblies to prevent or retard the passage of excessive heat, hot gases, or flames while continuing to support their structural loads. Fire resistance ratings are usually obtained by conducting standard fire tests. The standard fire resistance test (ASTM E 119) has three failure criteria: element collapse, passage of flames, or excessive temperature rise on the non-fire-exposed surface (average increase of several locations exceeding 139 or $181 \text{ }^\circ\text{C}$ at a single location).

Doors can be critical in preventing the spread of fires. Doors left open or doors with little fire resistance can easily defeat the purpose of a fire-rated wall or partition. Listings of fire-rated doors, frames, and accessories are provided by various fire testing agencies. When a fire-rated door is selected, details about which type of door, mounting, hardware, and closing mechanism need to be considered.

Fires in buildings can spread by the movement of hot fire gases through open channels in concealed spaces. Codes specify where fireblocking and draftstops are required in concealed spaces, and they must be designed to interfere with the passage of the fire up or across a building. In addition to going along halls, stairways, and other large spaces, heated gases also follow the concealed spaces between floor joists and between studs in partitions and walls of frame construction. Obstruction of these hidden channels provides an effective means of restricting fire from spreading to other parts of the structure. Fireblockings are materials used to resist the spread of flames via concealed spaces within building components such as floors and walls. They are generally used in vertical spaces such as stud cavities to block upward spread of a fire. Draftstops are barriers intended to restrict the movement of air within concealed areas of a building. They are typically used to restrict horizontal dispersion of hot gases and smoke in larger concealed spaces such as those found within wood joist floor assemblies with suspended dropped ceilings or within an attic space with pitched chord trusses.

Exposed Wood Members

The self-insulating quality of wood, particularly in the large wood sections of heavy timber construction, is an important

factor in providing a degree of fire resistance. In Type IV or heavy timber construction, the need for fire resistance requirements is achieved in the codes by specifying minimum sizes for the various members or portions of a building and other prescriptive requirements. In this type of construction, the wood members are not required to have specific fire resistance ratings. The acceptance of heavy timber construction is based on historical experience with its performance in actual fires. Proper heavy timber construction includes using approved fastenings, avoiding concealed spaces under floors or roofs, and providing required fire resistance in the interior and exterior walls.

The availability and code acceptance of a procedure to calculate the fire resistance ratings for large timber beams and columns have allowed their use in fire-rated buildings not classified as Type IV (heavy timber) construction. In the other types of construction, the structural members and assemblies are required to have specified fire resistance ratings. There are two accepted procedures for calculating the fire ratings of exposed wood members. In the first such procedure, the equations are simple algebraic equations that only need the dimensions of the beam or column and a load factor. Determination of the load factor requires the minimum dimension of column, the applied load as a percentage of the full allowable design load, and the effective column length. The acceptance of this procedure is normally limited to beams and column with nominal dimensions of 152 mm (6 in.) or greater and for fire ratings of 1 h or less. This procedure is applicable to glued-laminated timbers that utilize standard laminating combinations. Because the outer tension laminate of a glued-laminated beam is charred in a 1-h fire exposure, a core lamination of a beam needs to be removed and the equivalent of an extra nominal 51-mm- (2-in.-) thick outer tension lamination added to the bottom of the beam. Details on this procedure can be found in various industry publications (American Institute of Timber Construction (AITC) Technical Note 7, AF&PA-AWC DCA #2, APA Publication EWS Y245A) and the IBC.

A second more flexible mechanistic procedure was incorporated within the *National Design Specification for Wood Construction* (NDS®) in 2001 and is referred to as the NDS Method. As an explicit engineering method, it is applicable to all wood structural members covered under the NDS, including structural composite lumber wood members. Normal engineering calculations of the ultimate load capacity of the structural wood element are adjusted for reductions in dimensions with time as the result of charring. As discussed more in a later section, a char depth of 38 mm (1.5 in.) at 1 h is generally used for solid-sawn and structural glued-laminated softwood members. The char depth is adjusted upward by 20% to account for the effect of elevated temperatures on the mechanical properties of the wood near the wood-char interface. This procedure also requires that core lamination(s) of glued-laminated beams be replaced by extra outer tension laminate(s). A provision of the NDS procedure

addresses the structural integrity performance criteria for timber decks, but the thermal separation criteria are not addressed. This second procedure was developed by the American Wood Council and is fully discussed in their Technical Report No. 10. Fire resistance tests on glued-laminated specimens and structural composite lumber products loaded in tension are discussed in FPL publications.

The fire resistance of glued-laminated structural members, such as arches, beams, and columns, is approximately equivalent to the fire resistance of solid members of similar size. Laminated members glued with traditional phenol, resorcinol, or melamine adhesives are generally considered to be at least equal in their fire resistance to a one-piece member of the same size. In recent years, the fire resistance performance of structural wood members manufactured with adhesives has been of intense interest. As a result of concerns about some adhesives that were being used in fingerjointed lumber, industry test protocols and acceptance criteria were developed to address this issue. When a wood-frame assembly is required to have a fire resistance rating, any finger-jointed lumber within the assembly must include the HRA designation for heat-resistant adhesives in the grademark. The designation is part of the Glued Lumber Policy of the American Lumber Standard Committee, Inc. The activities to address questions concerning the adhesives have included the development of ASTM standard test methods and revisions to the ASTM standard specifications for the applicable wood products.

Light-Frame Assemblies

Light-frame wood construction can provide a high degree of fire containment through use of gypsum board as the interior finish. This effective protective membrane provides the initial fire resistance rating. Many recognized assemblies involving wood-frame walls, floors, and roofs provide a 1- or 2-h fire resistance rating. Fire-rated gypsum board (Type X or C) is used in rated assemblies. Type X and the higher grade Type C gypsum boards have textile glass filaments and other ingredients that help to keep the gypsum core intact during a fire. Fire resistance ratings of various assemblies are listed in the IBC and other publications such as the Gypsum Association *Fire Resistance Design Manual*, AF&PA-AWC DCA #3, and product directories of listing organizations, such as UL and Intertek. Traditional constructions of regular gypsum wallboard (that is, not fire rated) or lath and plaster over wood joists and studs have fire resistance ratings of 15 to 30 min. In addition to fire-rated assemblies constructed of sawn lumber, there are rated assemblies for I-joists and wood trusses.

Fire-rated assemblies are generally tested in accordance with ASTM E 119 while loaded to 100% of the allowable design load calculated using the NDS. The calculation of the allowable design load of a wood stud wall is described in ASTM D 6513. Some wood stud wall assemblies were tested with a load equivalent to 78% of the current design

load (NDS dated 2005) calculated using a l_e/d of 33. Less than full design load in the fire test imposes a load restriction on the rated assembly.

While fire resistance ratings are for the entire wall, floor, or roof assembly, the fire resistance of a wall or floor can be viewed as the sum of the resistance of the interior finish and the resistance of the framing members. In a code-accepted procedure, the fire rating of a light-frame assembly is calculated by adding the tabulated times for the fire-exposed membrane to the tabulated times for the framing. For example, the fire resistance rating of a wood stud wall with 16-mm-thick Type X gypsum board and rock wool insulation is computed by adding the 20 min listed for the stud wall, the 40 min listed for the gypsum board, and the 15 min listed for the rock wool insulation to obtain a rating for the assembly of 75 min. Additional information on this component additive method (CAM) can be found in the IBC and AF&PA DCA No. 4. More sophisticated mechanistic models have been developed.

The relatively good structural behavior of a traditional wood member in a fire test results from the fact that its strength is generally uniform through the mass of the piece. Thus, the unburned fraction of the member retains high strength, and its load-carrying capacity is diminished only in proportion to its loss of cross section. Innovative designs for structural wood members may reduce the mass of the member and locate the principal load-carrying components at the outer edges where they are most vulnerable to fire, as in structural sandwich panels. With high strength facings attached to a low-strength core, unprotected load-bearing sandwich panels have failed to support their load in less than 6 min when tested in the standard test. If a sandwich panel is to be used as a load-bearing assembly, it should be protected with gypsum wallboard or some other thermal barrier. In any protected assembly, the performance of the protective membrane is the critical factor in the performance of the assembly.

Unprotected light-frame wood buildings do not have the natural fire resistance achieved with heavier wood members. In these, as in all buildings, attention to good construction details is important to minimize fire hazards. Quality of workmanship is important in achieving adequate fire resistance. Inadequate nailing and less than required thickness of the interior finish can reduce the fire resistance of an assembly. The method of fastening the interior finish to the framing members and the treatment of the joints are significant factors in the fire resistance of an assembly. The type and quantity of any insulation installed within the assembly may also affect the fire resistance of an assembly.

Any penetration in the membrane must be addressed with the appropriate fire protection measures. This includes the junction of fire-rated assemblies with unrated assemblies. Fire stop systems are used to properly seal the penetration of fire-rated assemblies by pipes and other utilities.

Through-penetration fire stops are tested in accordance with ASTM E 814. Electrical receptacle outlets, pipe chases, and other through openings that are not adequately firestopped can affect the fire resistance. In addition to the design of walls, ceilings, floors, and roofs for fire resistance, stairways, doors, and firestops are of particular importance.

Fire-Performance Characteristics of Wood

Several characteristics are used to quantify the burning behavior of wood when exposed to heat and air, including thermal degradation of wood, ignition from heat sources, heat and smoke release, flame spread in heated environments, and charring rates in a contained room.

Thermal Degradation of Wood

As wood reaches elevated temperatures, the different chemical components undergo thermal degradation that affect wood performance. The extent of the changes depends on the temperature level and length of time under exposure conditions. At temperatures below 100 °C, permanent reductions in strength can occur, and its magnitude depends on moisture content, heating medium, exposure period, and species. The strength degradation is probably due to depolymerization reactions (involving no carbohydrate weight loss). The little research done on the chemical mechanism has found a kinetic basis (involving activation energy, pre-exponential factor, and order of reaction) of relating strength reduction to temperature. Chemical bonds begin to break at temperatures above 100 °C and are manifested as carbohydrate weight losses of various types that increases with the temperature. Literature reviews by Bryan (1998), Shafizadeh (1984), Atreya (1983), and Browne (1958) reveal the following four temperature regimes of wood pyrolysis and corresponding pyrolysis kinetics.

Between 100 and 200 °C, wood becomes dehydrated and generates water vapor and other noncombustible gases including CO₂, formic acid, acetic acid, and H₂O. With prolonged exposures at higher temperatures, wood can become charred. Exothermic oxidation reactions can occur because ambient air can diffuse into and react with the developing porous char residue.

From 200 to 300 °C, some wood components begin to undergo significant pyrolysis and, in addition to gases listed above, significant amounts of CO and high-boiling-point tar are given off. The hemicelluloses and lignin components are pyrolyzed in the range of 200 to 300 °C and 225 to 450 °C, respectively. Much of the acetic acid liberated from wood pyrolysis is attributed to deacetylation of hemicellulose. Dehydration reactions beginning around 200 °C are primarily responsible for pyrolysis of lignin and result in a high char yield for wood. Although the cellulose remains mostly unpyrolyzed, its thermal degradation can be accelerated in the presence of water, acids, and oxygen. As the temperature

increases, the degree of polymerization of cellulose decreases further, free radicals appear and carbonyl, carboxyl, and hydroperoxide groups are formed. Overall pyrolysis reactions are endothermic due to decreasing dehydration and increasing CO formation from porous char reactions with H₂O and CO₂ with increasing temperature. During this “low-temperature pathway” of pyrolysis, the exothermic reactions of exposed char and volatiles with atmospheric oxygen are manifested as glowing combustion.

The third temperature regime is from 300 to 450 °C because of the vigorous production of flammable volatiles. This begins with the significant depolymerization of cellulose in the range of 300 to 350 °C. Also around 300 °C, aliphatic side chains start splitting off from the aromatic ring in the lignin. Finally, the carbon–carbon linkage between lignin structural units is cleaved at 370 to 400 °C. The degradation reaction of lignin is an exothermic reaction, with peaks occurring between 225 and 450 °C; temperatures and amplitudes of these peaks depend on whether the samples were pyrolyzed under nitrogen or air. All wood components end their volatile emissions at around 450 °C. The presence of minerals and moisture within the wood tend to smear the separate pyrolysis processes of the major wood components. In this “high-temperature pathway,” pyrolysis of wood results in overall low char residues of around 25% or less of the original dry weight. Many fire retardants work by shifting wood degradation to the “low-temperature pathway,” which reduces the volatiles available for flaming combustion.

Above 450 °C, the remaining wood residue is an activated char that undergoes further degradation by being oxidized to CO₂, CO, and H₂O until only ashes remain. This is referred to as afterglow.

The complex nature of wood pyrolysis often leads to selecting empirical kinetic parameters of wood pyrolysis applicable to specific cases. Considering the degrading wood to be at low elevated temperature over a long time period and ignoring volatile emissions, a simple first-order reaction following the Arrhenius equation, $dm/dt = -mA \exp(-E/RT)$, was found practical. In this equation, m is mass of specimen, t is time, A is the preexponential factor, E is activation energy, R is the universal gas constant, and T is temperature in kelvins. The simplest heating environment for determination of these kinetic parameters is isothermal, constant pressure, and uniform flow gas exposures on a nominally thick specimen. As an example, Stamm (1955) reported on mass loss of three coniferous wood sticks (1 by 1 by 6 in.)—Southern and white pine, Sitka spruce, and Douglas-fir—that were heated in a drying oven in a temperature range of 93.5 to 250 °C. The fit of the Arrhenius equation to the data resulted in the values of $A = 6.23 \times 10^7 \text{ s}^{-1}$ and $E = 124 \text{ kJ mol}^{-1}$. If these same woods were exposed to steam instead of being oven dried, degradation was much faster. With the corresponding kinetic parameters, $A = 82.9 \text{ s}^{-1}$ and $E = 66$

kJ mol^{-1} , Stamm concluded that steam seemed to act as a catalyst because of significant reduction in the value of activation energy. Shafizadeh (1984) showed that pyrolysis proceeds faster in air than in an inert atmosphere and that this difference gradually diminishes around 310 °C. The value of activation energy reported at large for pyrolysis in air varied from 96 to 147 kJ mol^{-1} .

In another special case, a simple dual reaction model could distinguish between the low- and high- temperature pathways for quantifying the effect of fire retardant on wood pyrolysis. The reaction equation, $dm/dt = (m_{\text{end}} - m)[A_1 \exp(-E_1/RT) + A_2 \exp(-E_2/RT)]$, was found suitable by Tang (1967). In this equation, m_{end} is the ending char mass, and subscripts 1 and 2 represent low- and high-temperature pathways, respectively. A dynamic thermogravimetry was used to span the temperature to 500 °C at a rate of 3 °C per minute using tiny wood particles. The runs were made in triplicate for ponderosa pine sapwood, lignin, and alpha-cellulose samples with five different inorganic salt treatments. Tang’s derived values for the untreated wood are $m_{\text{end}} = 0.21$ of initial weight, $A_1 = 3.2 \times 10^5 \text{ s}^{-1}$, $E_1 = 96 \text{ kJ mol}^{-1}$, $A_2 = 6.5 \times 10^{16} \text{ s}^{-1}$, and $E_2 = 226 \text{ kJ mol}^{-1}$. A well-known fire-retardant-treatment chemical, monobasic ammonium phosphate, was the most effective chemical tested in that char yield was increased to 40% and E_1 decreased to 80 kJ mol^{-1} , thereby promoting most volatile loss through the low-temperature pathway. The alpha-cellulose reacted to the chemicals similarly as the wood, while the lignin did not seem to be affected much by the chemicals. From this we conclude that flammable volatiles generated by the cellulose component of wood are significantly reduced with fire retardant treatment. For applications to biomass energy and fire growth phenomenology, the kinetic parameters become essential to describe flammable volatiles and their heat of combustion but are very complicated (Dietenberger 2002). Modern pyrolysis models now include competing reactions to produce char, tar, and noncondensing gases from wood as well as the secondary reaction of tar decomposition.

Ignition

Ignition of wood is the start of a visual and sustained combustion (smoldering, glow, or flame) fueled by wood pyrolysis. Therefore the flow of energy or heat flux from a fire or other heated objects to the wood material to induce pyrolysis is a necessary condition of ignition. A sufficient condition of flaming ignition is the mixing together of volatiles and air with the right composition in a temperature range of about 400 to 500 °C. An ignition source (pilot or spark plug) is therefore usually placed where optimum mixing of volatiles and air can occur for a given ignition test. In many such tests the surface temperature of wood materials has been measured in the range of 300 to 400 °C prior to piloted ignition. This also coincides with the third regime of wood pyrolysis in which there is a significant production of flammable volatiles. However, it is possible for smoldering or

Table 18–2. Derived wood-based thermophysical parameters of ignitability

Material	Thickness (mm)	Density (kg m ⁻³) ρ	Moisture content (%) M	Material emissivity	r^a	T_{ig} (K)	$k/\rho c^a$ (m ² /s) $\times 10^7$	$k\rho c^a$ (kJ ² m ⁻⁴ K ⁻² s ⁻¹)
Gypsum board, Type X	16.5	662	—	0.9	N/A	608.5	3.74	0.451
FRT Douglas-fir plywood	11.8	563	9.48	0.9	0.86	646.8	1.37	0.261
Oak veneer plywood	13	479	6.85	0.9	1.11	563	1.77	0.413
FRT plywood (Forintek)	11.5	599	11.17	0.9	0.86	650	1.31	0.346
Douglas-fir plywood (ASTM)	11.5	537	9.88	0.85	0.863	604.6	1.37	0.221
FRT Southern Pine plywood	11	606	8.38	0.9	1.43	672	2.26	0.547
Douglas-fir plywood (MB)	12	549	6.74	0.89	0.86	619	1.38	0.233
Southern Pine plywood	11	605	7.45	0.88	0.86	620	1.38	0.29
Particleboard	13	794	6.69	0.88	1.72	563	2.72	0.763
Oriented strandboard	11	643	5.88	0.88	0.985	599	1.54	0.342
Hardboard	6	1,026	5.21	0.88	0.604	593	0.904	0.504
Redwood lumber	19	421	7.05	0.86	1.0	638	1.67	0.173
White spruce lumber	17	479	7.68	0.82	1.0	621	1.67	0.201
Southern Pine boards	18	537	7.82	0.88	1.0	644	1.63	0.26
Waferboard	13	631	5.14	0.88	1.62	563	2.69	0.442

^aFormulas for wood thermal conductivity k , heat capacity c , and density ρ , at elevated temperatures used to calculate thermal inertia $k\rho c$ and thermal diffusivity $k/\rho c$ are as follows:

$$k = r \left[(0.1941 + 0.004064M) (\rho_{od} \times 10^{-3}) + 0.01864 \left(T_m / 297 \times 10^{-3} \right) \right] \text{ kWm}^{-1}\text{K}^{-1}$$

$$c = 1.25(1 + 0.025M) (T_m / 297) \text{ kJkg}^{-1}\text{K}^{-1}$$

$$\rho_{od} = \rho / (1 + 0.01M) \text{ kgm}^{-3}$$

where T_{ig} is ignition temperature, ambient temperature $T_a = 297$ K, mean temperature $T_m = (T_a + T_{ig})/2$, and the parameter r is an adjustment factor used in the calculation of the thermal conductivity for composite, engineered, or treated wood products (Dietenberger 2004).

glow to exist prior to flaming ignition if the imposed radiative or convective heating causes the wood surface to reach 200 °C or higher for the second regime of wood pyrolysis. Indeed, unpiloted ignition is ignition that occurs where no pilot source is available. Ignition associated with smoldering is another important mechanism by which fires are initiated.

Therefore, to study flaming or piloted ignition, a high heat flux (from radiant heater) causes surface temperature to rapidly reach at least 300 °C to minimize influence of unwanted smoldering or glow at lower surface temperatures. Surface temperature at ignition has been an elusive quantity that was experimentally difficult to obtain, but relatively recent studies show some consistency. For various horizontally orientated woods with specific gravities ranging from 0.33 to 0.69, the average surface temperature at ignition increases from 347 °C at imposed heat flux of 36 kW m⁻² to 377 °C at imposed heat flux of 18 kW m⁻². This increase in the ignition temperature is due to the slow decomposition of the material at the surface and the resulting buildup of the char layer at low heat fluxes (Atreya 1983). In the case of naturally high charring material such as redwood that has high lignin and low extractives, the measured averaged ignition temperatures were 353, 364, and 367 °C for material thicknesses of 19, 1.8, and 0.9 mm, respectively, for various heat flux values as measured in the cone calorimeter (ASTM E 1354) (Dietenberger 2004). This equipment

along with the lateral ignition and flame spread test (LIFT) apparatus (ASTM E 1321) are used to obtain data on time to piloted ignition as a function of heater irradiance. From such tests, values of ignition temperature, critical ignition flux (heat flux below which ignition would not occur), and thermophysical properties have been derived using a transient heat conduction theory (Table 18–2). In the case of redwood, the overall piloted ignition temperature was derived to be 365 °C (638 K) in agreement with measured values, regardless of heat flux, thickness, moisture content, surface orientation, and thin reflective paint coating. The critical heat flux was derived to be higher on the LIFT apparatus than on the cone calorimeter primarily due to the different convective coefficients (Dietenberger 1996). However, the heat properties of heat capacity and thermal conductivity were found to be strongly dependent on density, moisture content, and internal elevated temperatures. Thermal conductivity has an adjustment factor for composite, engineered, or treated wood products. Critical heat fluxes for ignition have been calculated to be between 10 and 13 kW m⁻² for a range of wood products. For exposure to a constant heat flux, ignition times for solid wood typically ranged from 3 s for heat flux of 55 kW m⁻² to 930 s for heat flux of 18 kW m⁻². Estimates of piloted ignition in various scenarios can be obtained using the derived thermal properties listed in Table 18–2 and an applicable heat conduction theory (Dietenberger 2004).

Some, typically old, apparatuses for testing piloted ignition measured the temperature of the air flow rather than the imposed heat flux with the time to ignition measurement. These results were often reported as the ignition temperature and as varying with time to ignition, which is misleading. When the imposed heat flux is due to a radiant source, such reported air flow ignition temperature can be as much as 100 °C lower than the ignition surface temperature. For a proper heat conduction analysis in deriving thermal properties, measurements of the radiant source flux and air flow rate are also required. Because imposed heat flux to the surface and the surface ignition temperature are the factors that directly determine ignition, some data of piloted ignition are inadequate or misleading.

Unpiloted ignition depends on special circumstances that result in different ranges of ignition temperatures. At this time, it is not possible to give specific ignition data that apply to a broad range of cases. For radiant heating of cellulosic solids, unpiloted transient ignition has been reported at 600 °C. With convective heating of wood, unpiloted ignition has been reported as low as 270 °C and as high as 470 °C. Unpiloted spontaneous ignition can occur when a heat source within the wood product is located such that the heat is not readily dissipated. This kind of ignition involves smoldering and generally occurs over a longer period of time. Continuous smoking is visual evidence of smoldering, which is sustained combustion within the pyrolyzing material. Although smoldering can be initiated by an external ignition source, a particularly dangerous smoldering is that initiated by internal heat generation. Examples of such fires are (a) panels or paper removed from the press or dryer and stacked in large piles without adequate cooling and (b) very large piles of chips or sawdust with internal exothermic reactions such as biological activities. Potential mechanisms of internal heat generation include respiration, metabolism of microorganisms, heat of pyrolysis, abiotic oxidation, and adsorptive heat. These mechanisms, often in combination, may proceed to smoldering or flaming ignition through a thermal runaway effect within the pile if sufficient heat is generated and is not dissipated. The minimum environmental temperature to achieve smoldering ignition decreases with the increases in specimen mass and air ventilation, and can be as low as air temperatures for large ventilating piles. Therefore, safe shipping or storage with wood chips, dust, or pellets often depends on anecdotal knowledge that advises maximum pile size or ventilation constraints, or both (Babrauskas 2003).

Unpiloted ignitions that involve wood exposed to low-level external heat sources over very long periods are an area of dispute. This kind of ignition, which involves considerable charring, does appear to occur, based on fire investigations. However, these circumstances do not lend themselves easily to experimentation and observation. There is some evidence that the char produced under low heating temperatures can

have a different chemical composition, which results in a somewhat lower ignition temperature than normally recorded. Thus, a major issue is the question of safe working temperature for wood exposed for long periods. Temperatures between 80 and 100 °C have been recommended as safe surface temperatures for wood. As noted earlier, to address this concern, a safe margin of fire safety from ignition can be obtained if surface temperatures of heated wood are maintained below about 80 °C, which avoids the incipient wood degradation associated with reduction in ignition temperature.

Heat Release and Smoke

Heat release rates are important because they indicate the potential fire hazard of a material and also the combustibility of a material. Materials that release their potential chemical energy (and also the smoke and toxic gases) relatively quickly are more hazardous than those that release it more slowly. There are materials that will not pass the current definition of noncombustible in the model codes but will release only limited amounts of heat during the initial and critical periods of fire exposure. There is also some criticism of using limited flammability to partially define noncombustibility. One early attempt was to define combustibility in terms of heat release in a potential heat method (NFPA 259), with the low levels used to define low combustibility or noncombustibility. This test method is being used to regulate materials under some codes. The ground-up wood sample in this method is completely consumed during the exposure to 750 °C for 2 h, which makes the potential heat for wood identical to the gross heat of combustion from the oxygen bomb calorimeter. The typical gross heat of combustion averaged around 20 MJ kg⁻¹ for oven-dried wood, depending on the lignin and extractive content of the wood.

A better or a supplementary measure of degrees of combustibility is a determination of the rate of heat release (RHR) or heat release rate (HRR). This measurement efficiently assesses the relative heat contribution of materials—thick, thin, untreated, or treated—under fire exposure. The cone calorimeter (ASTM E 1354) is currently the most commonly used bench-scale HRR apparatus and is based on the oxygen consumption method. An average value of 13.1 kJ g⁻¹ of oxygen consumed was the constant found for organic solids and is accurate with very few exceptions to within 5%. In the specific case of wood volatiles flaming and wood char glowing, this oxygen consumption constant was reconfirmed at the value of 13.23 kJ g⁻¹ (Dietenberger 2002). Thus, it is sufficient to measure the mass flow rate of oxygen consumed in a combustion system to determine the net HRR. The intermediate-scale apparatus (ASTM E 1623) for testing 1- by 1-m assemblies or composites and the room full-scale test (ASTM E 2257) also use the oxygen consumption technique to measure the HRR of fires at larger scales.

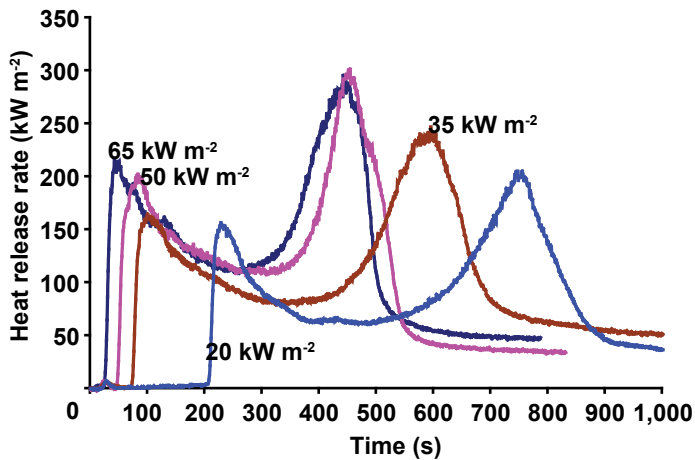

Figure 18–2. Heat release rate curves for 12-mm-thick oriented strandboard (OSB) exposed to constant heat flux of 20, 35, 50 and 65 kW m⁻².

The cone calorimeter is ideal for product development with its small specimen size of 100 by 100 mm. The specimen is continuously weighed by use of a load cell. In conjunction with HRR measurements, the effective heat of combustion as a function of time is calculated by the ASTM E 1354 method. Basically, the effective heat of combustion is the HRR divided by the mass loss rate as determined from the cone calorimeter test as a function of time. Typical HRR profiles, as shown in Figure 18–2, begin with a sharp peak upon ignition, and as the surface chars, the HRR drops to some minimum value. After the thermal wave travels completely through the wood thickness, the back side of a wood sample reaches pyrolysis temperature, thus giving rise to a second, broader, and even higher HRR peak. For FRT wood products, the first HRR peak may be reduced or eliminated.

Heat release rate depends upon the intensity of the imposed heat flux. Generally, the averaged effective heat of combustion is about 65% of the oxygen bomb heat of combustion (higher heating value), with a small linear increase with irradiance. The HRR itself has a large linear increase with the heat flux. This information along with a representation of the heat release profile shown in Figure 18–2 has been used to model or correlate with large scale fire growth such as the Steiner tunnel test and the room-corner fire test (Dietenberger and White 2001)

The cone calorimeter is also used to obtain dynamic measurements of smoke consisting principally of soot and CO in the overventilated fires and of white smoke during unignited pyrolysis and smoldering. The measurements are dynamic in that smoke continuously flows out the exhaust pipe where optical density and CO are measured continuously. This contrasts with a static smoke test in which the specimen is tested in a closed chamber of fixed volume and the light attenuation is recorded over a known optical path length. In

the dynamic measurements of smoke, the appropriate smoke parameter is the smoke release rate (SRR), which is the optical density multiplied by the volume flow rate of air into the exhaust pipe and divided by the product of exposed surface area of the specimen and the light path length. Often the smoke extinction area, which is the product of SRR and the specimen area, is preferred because it can be correlated linearly with HRR in many cases. This also permits comparison with the smoke measured in the room-corner fire test because HRR is a readily available test result (Dietenberger and Grexa 2000). Although SRR can be integrated with time to get the same units as the specific optical density, they are not equivalent because static tests involve the direct accumulation of smoke in a volume, whereas SRR involves accumulation of freshly entrained air volume flow for each unit of smoke. Methods investigated to correlate smoke between different tests included alternative parameters such as particulate mass emitted per area of exposed sample. As pertaining to CO production, some amount of correlation has been obtained between the cone calorimeter's CO mass flow rate as normalized by HRR to the corresponding parameter measured from the post flashover gases during the room-corner fire test. Thermal degradation of white smoke from wood into simpler gases within the underventilated fire test room during post flashover is not presently well understood and can have dramatic effects on thermal radiation within the room, which in turn affects wood pyrolysis rates.

Flame Spread

The spread of flames over solids is a very important phenomenon in the growth of compartment fires. Indeed, in fires where large fuel surfaces are involved, increase in HRR with time is primarily due to increase in burning area. Much data have been acquired with the flame spread tests used in building codes. Table 18–1 lists the FSI and smoke index of ASTM E 84 for solid wood. Some consistencies in the FSI behavior of the hardwood species can be related to their density (White 2000). Considerable variations are found for wood-based composites; for example, the FSI of four structural flakeboards ranged from 71 to 189.

As a prescriptive regulation, the ASTM E 84 tunnel test is a success in the reduction of fire hazards but is impractical in providing scientific data for fire modeling or in useful bench-scale tests for product development. Other full-scale tests (such as the room-corner test) can produce quite different results because of the size of the ignition burner or test geometry. This is the case with foam plastic panels that melt and drip during a fire test. In the tunnel test, with the test material on top, a material that melts can have low flammability because the specimen does not stay in place. With an adequate burner in the room-corner test, the same material will exhibit very high flammability.

A flame spreads over a solid material when part of the fuel, ahead of the pyrolysis front, is heated to the critical

condition of ignition. The rate of flame spread is controlled by how rapidly the fuel reaches the ignition temperature in response to heating by the flame front and external sources. The material's thermal conductivity, heat capacitance, thickness, and blackbody surface reflectivity influence the material's thermal response, and an increase in the values of these properties corresponds to a decrease in flame spread rate. On the other hand, an increase in values of the flame features, such as the imposed surface fluxes and spatial lengths, corresponds to an increase in the flame spread rate.

Flame spread occurs in different configurations, which are organized by orientation of the fuel and direction of the main flow of gases relative to that of flame spread. Downward and lateral creeping flame spread involves a fuel orientation with buoyantly heated air flowing opposite of the flame spread direction. Related bench-scale test methods are ASTM E 162 for downward flame spread, ASTM E 648 for horizontal flame spread to the critical flux level, and ASTM E 1321 (LIFT apparatus) for lateral flame spread on vertical specimens to the critical flux level. Heat transfer from the flame to the virgin fuel is primarily conductive within a spatial extent of a few millimeters and is affected by ambient conditions such as oxygen, pressure, buoyancy, and external irradiance. For most wood materials, this heat transfer from the flame is less than or equal to surface radiant heat loss in normal ambient conditions, so that excess heat is not available to further raise the virgin fuel temperature; flame spread is prevented as a result. Therefore, to achieve creeping flame spread, an external heat source is required in the vicinity of the pyrolysis front (Dietenberger 1994).

Upward or ceiling flame spread involves a fuel orientation with the main air flowing in the same direction as the flame spread (assisting flow). Testing of flame spread in assisting flow exists in both the tunnel tests and the room-corner burn tests. The heat transfer from the flame is both conductive and radiative, has a large spatial feature, and is relatively unaffected by ambient conditions. Rapid acceleration in flame spread can develop because of a large, increasing magnitude of flame heat transfer as a result of increasing total HRR in assisting flows (Dietenberger and White 2001). These complexities and the importance of the flame spread processes explain the many and often incompatible flame spread tests and models in existence worldwide.

Charring and Fire Resistance

As noted earlier in this chapter, wood exposed to high temperatures will decompose to provide an insulating layer of char that retards further degradation of the wood (Figure 18–3). The load-carrying capacity of a structural wood member depends upon its cross-sectional dimensions. Thus, the amount of charring of the cross section is the major factor in the fire resistance of structural wood members.

When wood is first exposed to fire, the wood chars and eventually flames. Ignition occurs in about 2 min under the

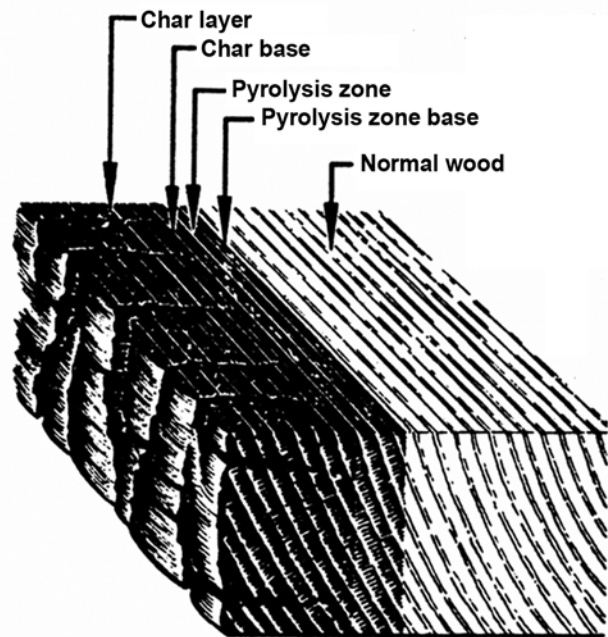

Figure 18–3. Illustration of charring of wood slab.

standard ASTM E 119 fire-test exposures. Charring into the depth of the wood then proceeds at a rate of approximately 0.8 mm min^{-1} for the next 8 min (or 1.25 min mm^{-1}). Thereafter, the char layer has an insulating effect, and the rate decreases to 0.6 mm min^{-1} (1.6 min mm^{-1}). Considering the initial ignition delay, the fast initial charring, and then the slowing down to a constant rate, the average constant charring rate is about 0.6 mm min^{-1} (or 1.5 in. h^{-1}) (Douglas-fir, 7% moisture content). In the standard fire resistance test, this linear charring rate is generally assumed for solid wood directly exposed to fire. There are differences among species associated with their density, anatomy, chemical composition, and permeability. In a study of the fire resistance of structural composite lumber products, the charring rates of the products tested were similar to that of solid-sawn lumber. Moisture content is a major factor affecting charring rate. Density relates to the mass needed to be degraded and the thermal properties, which are affected by anatomical features. Charring in the longitudinal grain direction is reportedly double that in the transverse direction, and chemical composition affects the relative thickness of the char layer. Permeability affects movement of moisture being driven from the wood or that being driven into the wood beneath the char layer. Normally, a simple linear model for charring where t is time (min), C is char rate (min mm^{-1}), and x_c is char depth (mm) is

$$t = Cx_c \quad (18-1)$$

The temperature at the base of the char layer is generally taken to be $300 \text{ }^\circ\text{C}$ or $550 \text{ }^\circ\text{F}$ ($288 \text{ }^\circ\text{C}$). With this temperature criterion, empirical equations for charring rate have

Table 18–3. Charring rate data for selected wood species

Species	Wood exposed to ASTM E 119 exposure ^a					Wood exposed to a constant heat flux ^b					
	Density ^c (kg m ⁻³)	Char contraction factor ^d	Linear charring rate ^e (min mm ⁻¹)	Non-linear charring rate ^f (min mm ^{-1.23})	Thermal penetration depth ^g (mm)	Linear charring rate ^e (min mm ⁻¹)		Thermal penetration depth ^g (mm)		Average mass loss rate (g m ⁻² s ⁻¹)	
						18- kW m ⁻² heat flux	55- kW m ⁻² heat flux	18- kW m ⁻² heat flux	55- kW m ⁻² heat flux	18- kW m ⁻² heat flux	55- kW m ⁻² heat flux
Softwoods											
Southern Pine	509	0.60	1.24	0.56	33	2.27	1.17	38	26.5	3.8	8.6
Western redcedar	310	0.83	1.22	0.56	33	—	—	—	—	—	—
Redwood	343	0.86	1.28	0.58	35	1.68	0.98	36.5	24.9	2.9	6.0
Engelmann spruce	425	0.82	1.56	0.70	34	—	—	—	—	—	—
Hardwoods											
Basswood	399	0.52	1.06	0.48	32	1.32	0.76	38.2	22.1	4.5	9.3
Maple, hard	691	0.59	1.46	0.66	31	—	—	—	—	—	—
Oak, red	664	0.70	1.59	0.72	32	2.56	1.38	27.7	27.0	4.1	9.6
Yellow-poplar	504	0.67	1.36	0.61	32	—	—	—	—	—	—

^aMoisture contents of 8% to 9%.

^bCharring rate and average mass loss rate obtained using ASTM E 906 heat release apparatus. Test durations were 50 to 98 min for 18-kW m⁻² heat flux and 30 to 53 min for 55-kW m⁻² heat flux. Charring rate based on temperature criterion of 300 °C and linear model. Mass loss rate based on initial and final weight of sample, which includes moisture driven from the wood. Initial average moisture content of 8% to 9%.

^cBased on weight and volume of oven-dried wood.

^dThickness of char layer at end of fire exposure divided by original thickness of charred wood layer (char depth).

^eBased on temperature criterion of 288 °C and linear model.

^fBased on temperature criterion of 288 °C and nonlinear model of Equation (18–3).

^gAs defined in Equation (18–6). Not sensitive to moisture content.

been developed. Equations relating charring rate under ASTM E 119 fire exposure to density and moisture content are available for Douglas-fir, Southern Pine, and white oak. These equations for rates transverse to the grain are

$$C = (0.002269 + 0.00457\mu)\rho + 0.331 \quad \text{for Douglas-fir} \quad (18-2a)$$

$$C = (0.000461 + 0.00095\mu)\rho + 1.016 \quad \text{for Southern Pine} \quad (18-2b)$$

$$C = (0.001583 + 0.00318\mu)\rho + 0.594 \quad \text{for white oak} \quad (18-2c)$$

where μ is moisture content (fraction of oven-dry mass) and ρ is density, dry mass volume at moisture content μ (kg m⁻³).

A nonlinear char rate model has been found useful. This alternative model is

$$t = mx_c^{1.23} \quad (18-3)$$

where m is char rate coefficient (min mm^{-1.23}).

A form of Equation (18–3) is used in the NDS Method for calculating the fire resistance rating of an exposed wood member. Based on data from eight species (Table 18–3), the

following equation was developed for the char rate coefficient:

$$m = -0.147 + 0.000564\rho + 1.21\mu + 0.532f_c \quad (18-4)$$

where ρ is density, oven-dry mass and volume, and f_c is char contraction factor (dimensionless).

The char contraction factor is the thickness of the residual char layer divided by the original thickness of the wood layer that was charred (char depth). Average values for the eight species tested in the development of the equation are listed in Table 18–3. These equations and data are valid when the member is thick enough to be a semi-infinite slab. For smaller dimensions, the charring rate increases once the temperature has risen above the initial temperature at the center of the member or at the unexposed surface of the panel. As a beam or column chars, the corners become rounded.

Charring rate is also affected by the severity of the fire exposure. Data on charring rates for fire exposures other than ASTM E 119 have been limited. Data for exposure to constant temperatures of 538, 815, and 927 °C are available in Schaffer (1967). Data for a constant heat flux are given in Table 18–3.

The temperature at the innermost zone of the char layer is assumed to be 300 °C. Because of the low thermal conductivity of wood, the temperature 6 mm inward from the base of the char layer is about 180 °C. This steep temperature

gradient means the remaining uncharred cross-sectional area of a large wood member remains at a low temperature and can continue to carry a load. Once a quasi-steady-state charring rate has been obtained, the temperature profile beneath the char layer can be expressed as an exponential term or a power term. An equation based on a power term is

$$T = T_i + (300 - T_i) \left(1 - \frac{x}{d}\right)^2 \quad (18-5)$$

where T is temperature ($^{\circ}\text{C}$), T_i initial temperature ($^{\circ}\text{C}$), x distance from the char front (mm), and d thermal penetration depth (mm).

In Table 18–3, values for the thermal penetration depth parameter are listed for both the standard fire exposure and the constant heat flux exposure. As with the charring rate, these temperature profiles assume a semi-infinite slab. The equation does not provide for the plateau in temperatures that often occurs at 100°C in moist wood. In addition to these empirical data, there are mechanistic models for estimating the charring rate and temperature profiles. The temperature profile within the remaining wood cross section can be used with other data to estimate the remaining load-carrying capacity of the uncharred wood during a fire and the residual capacity after a fire.

Fire-Retardant-Treated Wood

Wood products can be treated with fire retardants to improve their fire performance. Fire-retardant treatments result in delayed ignition, reduced heat release rate, and slower spread of flames. HRRs are markedly reduced by fire-retardant treatment (Fig. 18–4). In terms of fire performance, fire-retardant treatments are marketed to improve the flame spread characteristics of the wood products as determined by ASTM E 84, ASTM E 108, or other flammability tests. Fire-retardant treatment also generally reduces the smoke-developed index as determined by ASTM E 84. A fire-retardant treatment is not intended to affect fire resistance of wood products as determined by an ASTM E 119 test in any consistent manner. Fire-retardant treatment does not make a wood product noncombustible as determined by ASTM E 136 nor does it change its potential heat as determined by NFPA 259.

Because fire-retardant treatment does reduce the flammability of the wood product, FRT wood products are often used for interior finish and trim in rooms, auditoriums, and corridors where codes require materials with low surface flammability. Although FRT wood is not a noncombustible material, many codes have specific exceptions that allow the use of FRT wood and plywood in fire-resistive and noncombustible construction for framing of non-load-bearing partitions, nonbearing exterior walls, and roof assemblies. Fire-retardant-treated wood is also used for such special purposes as wood scaffolding and for the frame, rails, and stiles of wood fire doors.

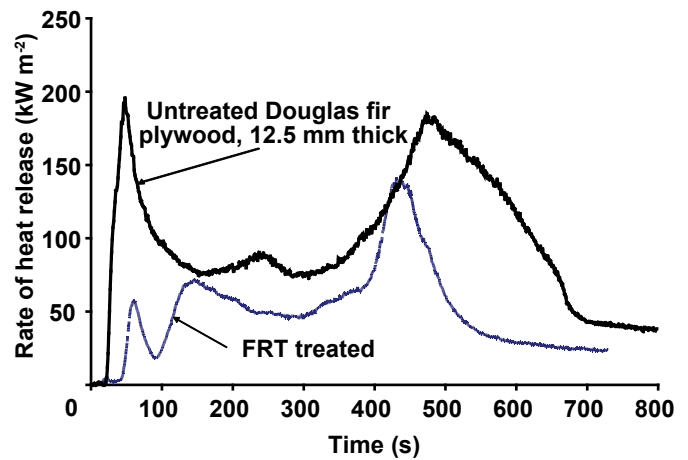

Figure 18–4. Heat release curves for untreated and fire-retardant-treated (FRT) Douglas-fir plywood, 12.5 mm thick.

To meet specifications in building codes and various standards, FRT lumber and plywood is wood that has been pressure treated with chemicals to reduce its flame spread characteristics. In the case of other composite wood products, chemicals can be added during the manufacture of the wood product. Fire-retardant treatment of wood generally improves the fire performance by reducing the amount of flammable volatiles released during fire exposure or by reducing the effective heat of combustion, or both. Both results have the effect of reducing HRR, particularly during the initial stages of fire, and thus consequently reducing the rate of flame spread over the surface. The wood may then self-extinguish when the primary heat source is removed. FRT products can be found in the Underwriters Laboratories, Inc., “Building Materials Directory,” evaluation reports of ICC Evaluation Service, Inc. (ICC–ES), and other such listings.

Pressure Treatments

In impregnation treatments, wood is pressure impregnated with chemical solutions using pressure processes similar to those used for chemical preservative treatments. However, considerably heavier absorptions of chemicals are necessary for fire-retardant protection. Penetration of chemicals into the wood depends on species, wood structure, and moisture content. Because some species are difficult to treat, the degree of impregnation needed to meet the performance requirements for FRT wood may not be possible.

Inorganic salts are the most commonly used fire retardants for interior wood products, and their characteristics have been known for more than 50 years. These salts include monoammonium and diammonium phosphate, ammonium sulfate, zinc chloride, sodium tetraborate, and boric acid. Guanylurea phosphate is also used. Chemicals are combined in formulations to develop optimum fire performance yet still retain acceptable hygroscopicity, strength, corrosivity, machinability, surface appearance, glueability, and

paintability. Cost is also a factor in these formulations. Actual formulations of commercial fire-retardant treatments are generally proprietary. For the two interior fire-retardant treatments listed in American Wood Protection Association (AWPA) (formerly American Wood-Preservers' Association) standards, the chemicals listed are guanylurea phosphate and boric acid for FR-1 and phosphate, boric acid, and ammonia for FR-2. Species-specific information on the depth of chemical penetration for these two formulations can be found in Section 8.8 of AWPA Standard T1. Traditional fire-retardant salts are water soluble and are leached out in exterior applications or with repeated washings. Water-insoluble organic fire retardants have been developed to meet the need for leach-resistant systems. Such treatments are also an alternative when a low-hygroscopic treatment is needed. These water-insoluble systems include (a) resins polymerized after impregnation into wood and (b) graft polymer fire retardants attached directly to cellulose. An amino resin system based on urea, melamine, dicyandiamide, and related compounds is of the first type.

There are AWPA standards that describe methods for testing wood for the presence of phosphate or boron. Such tests can be used to determine the presence of fire-retardant treatments that contain these chemicals. AWPA Standard A9 is a method for analysis of treated wood and treating solutions by x-ray spectroscopy. The method detects the presence of elements of atomic number 5 or higher including B(5) and P(15). AWPA Standard A26 has a method for analysis of fire retardant FR1 solutions or wood by titration for the percentages of boric acid and guanylurea phosphate. AWPA Standard A3 describes methods for determining penetration of fire retardants. Included are two methods for boron-containing preservatives and fire retardants and one method for phosphorus-containing fire retardants. The compositions of commercial fire-retardant treatments are proprietary. In the case of boron, tests for its presence cannot distinguish between treatments for preservation and those for fire retardancy. Such chemical tests are not an indicator of the adequacy of the treatment in terms of fire retardancy. Small-scale fire tests such as the cone calorimeter (ASTM E 1354), oxygen index (ASTM D 2863), fire tube (ASTM E 69), and various thermal analysis methodologies can also be used to determine the presence of fire retardant treatment.

Performance Requirements

The IBC has prescriptive language specifying performance requirements for FRT wood. The fire performance requirement for FRT wood is that its FSI is 25 or less when tested according to the ASTM E 84 flame spread test and that it shows no evidence of significant progressive combustion when this 10-min test is continued for an additional 20 min. In addition, it is required that the flame front in the test shall not progress more than 3.2 m beyond the centerline of the burner at any given time during the test. In the IBC, FRT wood must be a wood product impregnated with

chemicals by a pressure process or other means during manufacture. In applications where the requirement being addressed is not for “fire-retardant-treated wood” but only for Class A or B flame spread, the treatment only needs to reduce the FSI to the required level in the ASTM E 84 flame spread test (25 for Class A, 75 for Class B).

In addition to requirements for flame spread performance, FRT wood for use in certain applications is required to meet other performance requirements. Wood treated with inorganic fire-retardant salts is usually more hygroscopic than is untreated wood, particularly at high relative humidities. Increases in equilibrium moisture content of this treated wood will depend upon the type of chemical, level of chemical retention, and size and species of wood involved. Applications that involve high humidity will likely require wood with low hygroscopicity. Requirements for low hygroscopicity in the IBC stipulate that interior FRT wood shall have a moisture content of not more than 28% when tested in accordance with ASTM D 3201 procedures at 92% relative humidity.

Exterior fire-retardant treatments should be specified whenever the wood is exposed to weather, damp, or wet conditions. Exterior type treatment is one that has shown no increase in the listed flame spread index after being subjected to the rain test of ASTM D 2898. Although the method of D 2898 is often not specified, the intended rain test is usually Method A of ASTM D 2898. Method B of D 2898 includes exposures to UV bulbs in addition to water sprays, is described in FPL publications, and is an acceptable method in AWPA Standard U1 for evaluating exterior treatments. The ASTM D 2898 standard practice was recently revised to include Methods C and D. Method C is the “amended rain test” described in the acceptance criteria for classified wood roof systems (AC107) of the ICC Evaluation Service, Inc. Method D is the alternative rain test described in ASTM E 108 for roof coverings.

Fire-retardant treatment generally results in reductions in the mechanical properties of wood. Fire-retardant-treated wood is often more brash than untreated wood. For structural applications, information on mechanical properties of the FRT wood product needs to be obtained from the treater or chemical supplier. This includes the design modification factors for initial strength properties of the FRT wood and values for the fasteners. Adjustments to the design values must take into account expected temperature and relative humidity conditions. In field applications with elevated temperatures, such as roof sheathings, there is the potential for further losses in strength with time. Fire-retardant-treated wood that will be used in high-temperature applications, such as roof framing and roof sheathing, is also strength tested in accordance with ASTM D 5664 (lumber) or ASTM D 5516 (plywood) for purpose of obtaining adjustment factors as described in ASTM D 6841 (lumber) and ASTM D 6305 (plywood). The temperatures used to obtain the adjustment

factors also become the maximum temperature that can be used in kiln drying of lumber or plywood after treatment.

Corrosion of fasteners can be accelerated under conditions of high humidity and in the presence of fire-retardant salts. For fire-retardant treatments containing inorganic salts, the types of metal and chemical in contact with each other greatly affect the rate of corrosion. Thus, information on proper fasteners also needs to be obtained from the treater or chemical supplier. Other issues that may require contacting the treater or chemical supplier include machinability, gluing characteristics, and paintability.

Fire-retardant treatment of wood does not prevent the wood from decomposing and charring under fire exposure (the rate of fire penetration through treated wood approximates the rate through untreated wood). Fire-retardant-treated wood used in doors and walls can slightly improve fire resistance of these doors and walls. Most of this improvement is associated with reduction in surface flammability rather than any changes in charring rates.

There are specifications for FRT wood issued by AWPA and NFPA. In terms of performance requirements, these specifications are consistent with the language in the codes. The AWPA standards C20 and C27 for FRT lumber and plywood have recently been deleted by AWPA. They have been replaced by AWPA “Use Category System Standards” for specifying treated wood. The specific provisions are Commodity H of Standard U1 and Section 8.8 of Standard T1. The fire protection categories are UCFA for interior applications where the wood is protected from exterior weather and UCFB for exterior applications where any water is allowed to quickly drain from the surface. Neither category is suitable for applications involving contact with the ground or with foundations. Commodity Specification H is fire-retardant treatment by pressure processes of solid sawn and plywood. The performance requirements for Commodity Specification H treatments are provided in Standard U1. Section 8.8 of Standard T1 provides information on the treatment and processing (that is, drying) of the products.

There is also NFPA standard 703 for FRT wood and fire-retardant coatings. In addition to the performance and testing requirements for FRT wood products impregnated with chemicals by a pressure process or other means during manufacture, this NFPA standard provides separate specifications for fire-retardant coatings.

For parties interested in developing new fire-retardant treatments, there are documents that provide guidelines on the data required for technical acceptance. In the AWPA Book of Standards, there is “Appendix B: Guidelines for evaluating new fire retardants for consideration by the AWPA.” The ICC–ES has issued an “Acceptance criteria for fire-retardant-treated wood” (AC66), which provides guidelines for what is required to be submitted for their evaluation reports. There is also “Acceptance criteria for classified wood roof

systems” (AC107). Because of the relative small size of the specimen, FPL uses the cone calorimeter in its research and development of new FRT products.

Fire-Retardant Coatings

For some applications, applying the fire-retardant chemical as a coating to the wood surface may be acceptable to the authorities having jurisdiction. Commercial coating products are available to reduce the surface flammability characteristics of wood. The two types of coatings are intumescent and nonintumescent. The widely used intumescent coatings “intumesce” to form an expanded low-density film upon exposure to fire. This multicellular carbonaceous film insulates the wood surface below from high temperatures. Intumescent formulations include a dehydrating agent, a char former, and a blowing agent. Potential dehydrating agents include polyammonium phosphate. Ingredients for the char former include starch, glucose, and dipentaerythritol. Potential blowing agents for the intumescent coatings include urea, melamine, and chlorinate paraffins. Nonintumescent coating products include formulations of the water-soluble salts such as diammonium phosphate, ammonium sulfate, and borax.

NFPA standard 703 includes specifications for fire-retardant coatings. Because coatings are not pressure impregnated or incorporated during manufacture, fire-retardant coated wood is not FRT wood as defined in most codes or standards including NFPA 703. In NFPA 703, a fire-retardant coating is defined as a coating that reduces the flame spread of Douglas-fir and all other tested combustible surfaces to which it is applied by at least 50% or to a flame spread classification value of 75 or less, whichever is the lesser value, and has a smoke developed rating not exceeding 200 when tested in accordance with ASTM E 84, NFPA 255, or UL 723. There is no requirement that the standard test be extended for an additional 20 min as required for FRT wood. NFPA 703 differentiates between a Class A coating as one that reduces flame spread index to 25 or less and a Class B coating as one that reduces flame spread index to 75 or less.

Fire-retardant coatings for wood are tested and marketed to reduce flame spread. Clear intumescent coatings are available. Such coatings allow the exposed appearance of old structural wood members to be maintained while providing improved fire performance. This is often desirable in the renovation of existing structures, particularly museums and historic buildings. Studies have indicated that coatings subjected to outdoor weathering are of limited durability and would need to be reapplied on a regular basis.

Although their use to improve the resistance ratings of wood products has been investigated, there is no general acceptance for using coatings to improve the fire resistance rating of a wood member. There is a lack of full-scale ASTM E 119 test data to demonstrate their performance and validate a suitable calculation methodology for obtaining the rating.

Literature Cited

Atreya, A. 1983. Pyrolysis, ignition, and flame spread on horizontal surfaces of wood. Cambridge, MA: Harvard University. Ph.D. dissertation.

Babrauskas, V. 2003. Ignition Handbook. Issaquah, WA: Fire Science Publishers.

Benjamin, I.A.; Davis, S. 1979. Flammability testing for carpets. *Fire Technology*. 15(3): 189–194.

Browne, F.L. 1958. Theories of the combustion of wood and its control—a survey of the literature. Rep. No. 2136. Madison, WI: U.S. Department of Agriculture, Forest Service, Forest Products Laboratory.

Bryan, K.M. 1998. Computational modeling of wood combustion. Madison, WI: University of Wisconsin–Madison. Ph.D. dissertation.

Dietenberger, M.A. 1994. Protocol for ignitability, lateral flame spread, and heat release rate using LIFT apparatus. In: Nelson, G.L., ed. *Fire and polymers II. Materials and tests for hazard prevention: Proceedings of 208th national meeting of the American Chemical Society; 1994 August 21–26; Washington, DC. ACS symposium series 599.* Washington, DC: American Chemical Society, 1995. Chapter 29.

Dietenberger, M.A. 1996. Ignitability analysis using the cone calorimeter and LIFT apparatus. *Proceedings of the international conference on fire safety, Vol. 22; 1996 July 22–26. Columbus OH: Product Safety Corporation.* Sissonville, WV: 189–197.

Dietenberger, M.A. 2002. Update for combustion properties of wood components. *Fire and Materials Journal*. (26): 255–267.

Dietenberger, M.A. 2004. Ignitability of materials in transitional heating regimes. *Proceedings of 5th international scientific conference on wood & fire safety; 2004 April 18–22. Slovak Republic. Zvolen, Slovakia: Faculty of Wood Sciences and Technology, Technical University of Zvolen, 2004: 31–41.*

Dietenberger, M.A.; Grexa, O. 2000. Correlation of smoke development in room tests with cone calorimeter data for wood products. *Proceedings of 4th international scientific conference on wood & fire safety; 2000 May 14–19. Slovak Republic: The High Tatras, Hotel Patria, Strbske Pleso.*

Dietenberger, M.A.; White, R.H. 2001. Reaction-to-fire testing and modeling for wood products. In: *Proceedings of 12th annual BCC conference on flame retardancy; 2001 May 21–23. Stamford, CT. Norwalk, CT: Business Communications Co., Inc. 54–69.*

Östman, B.A.-L.; Mikkola, E. 2006. European classes for the reaction to fire performance of wood products. *Holz als Roh- und Werkstoff*. 64: 327–337.

Schaffer, E.L. 1967. Charring rate of selected woods—transverse to grain. Res. Pap. FPL 69. Madison, WI: U.S. Department of Agriculture, Forest Service, Forest Products Laboratory.

Shafizadeh, F. 1984. The chemistry of pyrolysis and combustion. In: Rowell, R.M., ed. *The chemistry of solid wood, advances in chemistry series 207.* Washington, DC: American Chemical Society. 489–530.

Stamm, A.J. 1955. Thermal degradation of wood and cellulose. Presented at the symposium on degradation of cellulose and cellulose derivatives. Sponsored by the Division of Cellulose Chemistry, 127th national meeting of the American Chemical Society. Cincinnati, OH. (April 4–7).

Tang, W.K. 1967. Effect of inorganic salts on pyrolysis of wood, alpha-cellulose, and lignin determined by dynamic thermogravimetry. Res. Pap. FPL 71. Madison, WI: U.S. Department of Agriculture, Forest Service, Forest Products Laboratory.

Tsantaridis, L.; Östman, B. 2004. European classes for the reaction to fire performance of wood floorings. *Träteknisk Rapport 0411026.* Stockholm: Institute för Träteknisk Forskning.

White, R.H. 2000. Fire performance of hardwood species. NTIS #PB2001-107912WBT. In: XXI IUFRO World Congress, Kuala Lumpur, Malaysia; 2000 August 7–12.

White, R.H.; Dietenberger, M.A.; Tran, H.; Grexa, O.; Richardson, L.; Sumathipala, K.; Janssens, M. 1999. Comparison of test protocols for the standard room/corner test. *Fire and Materials*. 23: 139–46.

Additional References

General

APA. [Current edition]. *Fire-rated systems.* Tacoma, WA: APA—The Engineered Wood Association. www.apawood.org.

CWC. 1996. *Fire safety design in buildings.* Ottawa, ON, Canada: Canadian Wood Council. www.cwc.ca.

ICC. [2006 or current edition]. *International building code.* Country Club Hills, IL: International Code Council, Inc. www.iccsafe.org.

International wildland-urban interface code

International fire code

International residential code for one- and two-family dwellings

International Code Council performance code for buildings and facilities

NFPA. [Current edition]. *Fire protection handbook.* Quincy, MA: National Fire Protection Association. www.nfpa.org.

Chapter 18 Fire Safety of Wood Construction

NFPA 1144. Standard for reducing structure ignition hazards from wildland fire.

NFPA 101. Life safety code.

Society of Fire Protection Engineers. [Current edition]. The Society of Fire Protection Engineers handbook of fire protection engineering. Quincy, MA: National Fire Protection Association. www.nfpa.org.

Fire Test Standards

ASTM. [Current edition]. West Conshohocken, PA: ASTM International. www.astm.org.

ASTM D 2863. Measuring the minimum oxygen concentration to support candle-like combustion of plastics (oxygen index).

ASTM D 2898. Accelerated weathering of fire-retardant treated wood for fire testing.

ASTM D 6513. Calculating the superimposed load on wood-frame walls for standard fire-resistance tests.

ASTM E 69. Combustible properties of treated wood by fire-tube apparatus.

ASTM E 84. Surface burning characteristics of building materials.

ASTM E 108. Fire tests of roof coverings.

ASTM E 119. Fire tests of building construction and materials.

ASTM E 136. Behavior of materials in a vertical tube furnace at 750 °C.

ASTM E 162. Surface flammability of materials using a radiant heat energy source.

ASTM E 648. Critical radiant flux of floor-covering systems using a radiant heat energy source.

ASTM E 662. Specific optical density of smoke generated by solid materials.

ASTM E 814. Fire tests of through-penetration fire stops.

ASTM E 906. Heat and visible smoke release rates from materials and products.

ASTM E 970. Critical radiant flux of exposed attic floor insulation using a radiant heat energy source.

ASTM E 1321. Determining material ignition and flame spread properties.

ASTM E 1354. Heat and visible smoke release rates for materials and products using an oxygen consumption calorimeter.

ASTM E 1623. Determination of fire and thermal parameters of materials, products, and systems using an intermediate scale calorimeter (ICAL).

ASTM E 1678. Measuring smoke toxicity for use in fire hazard analysis.

ASTM E 2257. Room fire test of wall and ceiling materials and assemblies.

ASTM E 2579. Specimen preparation and mounting of wood products to assess surface burning characteristics.

NFPA. [Current edition]. Quincy, MA: National Fire Protection Association. www.nfpa.org.

NFPA 251. Fire resistance of building construction and materials.

NFPA 253. Critical radiant flux of floor covering systems using a radiant heat energy source.

NFPA 255. Surface burning characteristics of building materials.

NFPA 259. Potential heat of building materials.

NFPA 286. Evaluating contribution of wall and ceiling interior finish to room fire growth.

UL. [Current edition]. Northbrook, IL: Underwriters Laboratories, Inc. www.ul.com.

ANSI/UL 723. Surface burning characteristics of building materials.

Ignition

Atreya, A. 1998. Ignition of fires. London, England: Philosophical Transactions of the Royal Society of London. (356): 2787–2813.

Brenden, J.J.; Schaffer, E. 1980. Smoldering wave-front velocity in fiberboard. Res. Pap. FPL 367. Madison, WI: U.S. Department of Agriculture, Forest Service, Forest Products Laboratory.

Dietenberger, M.A. 1994. Ignitability analysis of siding materials using modified protocol for LIFT apparatus. In: Proceedings, 3rd fire and materials conference; 1994 October 27–28; Crystal City, VA. London: Interscience Communications Limited: 259–268.

Kubler, H. 1990. Self-heating of lignocellulosic materials. In: Nelson, G.L., ed. Fire and polymers—hazards identification and prevention. ACS symposium series 425. Washington, DC: American Chemical Society: 429–449.

LeVan, S.; Schaffer, E. 1982. Predicting weight loss from smoldering combustion in cellulosic insulation. Journal of Thermal Insulation. 5: 229–244.

Matson, A.F.; Dufour, R.E.; Breen, J.F. 1959. Part II. Survey of available information on ignition of wood exposed to moderately elevated temperatures. In: Performance of type B gas vents for gas-fired appliances. Bull. of Res. 51. Chicago, IL: Underwriters Laboratories: 269–295.

Schaffer, E.L. 1980. Smoldering in cellulose under prolonged low-level heating. *Fire Technology*. 16(1): 22–28.

Shafizadeh, F.; Sekiguchi, Y. 1984. Oxidation of chars during smoldering combustion of cellulosic materials. *Combustion and Flame*. 55: 171–179.

Flame Spread

AWC. [Current edition]. Flame spread performance of wood products. Design for code acceptance No. 1. www.awc.org.

Bengelsdorf, M.F. [Current edition]. Fire-hazard classification of construction plywood panels. Report 128. Tacoma, WA: APA–The Engineered Wood Association. www.apawood.org.

Gardner, W.D.; Thomson, C.R. 1988. Flame spread properties of forest products. Comparison and validation of prescribed Australian and North American flame spread test methods. *Fire and Materials*. 12: 71–85.

Holmes, C.A.; Eickner, H.W.; Brenden, J.J.; White, R.H. 1979. Fire performance of structural flakeboard from forest residue. Res. Pap. FPL–RP–315. Madison, WI: U.S. Department of Agriculture, Forest Service, Forest Products Laboratory.

Sumathipala, K.; White, R.H. 2006. Flammability tests for regulation of building and construction materials. In: Vivek, B.A., ed. *Flammability testing of materials used in construction, transport and mining*. Cambridge, England: Woodhead Publishing, Ltd. 217–30. Chapter 10.

UL. 1971. Wood-fire hazard classification. Card Data Service, Serial No. UL527. Chicago, IL: Underwriters Laboratories, Inc.

UL. [Current edition]. Building materials directory. Northbrook, IL: Underwriters Laboratories, Inc. www.ul.com.

Yarbrough, D.W.; Wilkes, K.E. 1997. Thermal properties and use of cellulosic insulation produced from recycled paper. In: *The use of recycled wood and paper in building applications*. Proc. 7286. Madison, WI: Forest Products Society: 108–114.

Flashover and Room/Corner Tests

Bruce, H.D. 1959. Experimental dwelling—room fires. Rep. 1941. Madison, WI: U.S. Department of Agriculture, Forest Service, Forest Products Laboratory.

Dietenberger, M.A.; Grexa, O.; White, R.H. [and others]. 1995. Room/corner test of wall linings with 100/300 kW burner. In: *Proceedings, 4th international fire and materials conference; 1995 November 15–16*. Crystal City, MD. London: InterScience Communications Limited: 53–62.

Holmes, C. 1978. Room corner-wall fire tests of some structural sandwich panels and components. *Journal of Fire & Flammability*. 9: 467–488.

Holmes, C.; Eickner, H.; Brenden, J.J. [and others]. 1980. Fire development and wall endurance in sandwich and wood-frame structures. Res. Pap. FPL 364. Madison, WI: U.S. Department of Agriculture, Forest Service, Forest Products Laboratory.

Schaffer, E.L.; Eickner, H.W. 1965. Effect of wall linings on fire performance within a partially ventilated corridor. Res. Pap. FPL 49. Madison, WI: U.S. Department of Agriculture, Forest Service, Forest Products Laboratory.

Tran, H.C. 1991. Wall and corner fire tests on selected wood products. *Journal of Fire Sciences*. 9: 106–124. March/April.

Heat Release and Heat of Combustion

Babrauskas, V.; Grayson, S.J., eds. 1992. *Heat release in fires*. New York: Elsevier Applied Science.

Chamberlain, D.L. 1983. Heat release rates of lumber and wood products. In: Schaffer, E.L., ed. *Behavior of polymeric materials in fire*. ASTM STP 816. Philadelphia, PA: American Society for Testing and Materials: 21–41.

Hagge, M.J.; Bryden, K.M.; Diitenberger, M.A. 2004. Effect of backing board materials on wood combustion performance. In: *Proceedings, 5th international scientific conference on wood & fire safety; 2004 April 18–22*.

Tran, H.C. 1990. Modifications to an Ohio State University apparatus and comparison with cone calorimeter results. In: Quintiere, J.G.; Cooper, L.Y., eds. *Heat and mass transfer in fires. Proceedings, AIAA/ASME thermophysics and heat transfer conference; 1990 June 18–20; Seattle, WA*. New York: The American Society of Mechanical Engineers. (141): 131–139.

Tran, H.C. 1992. (B) Experimental data on wood materials. In: Babrauskas, V.; Grayson, S.J., eds. *Heat release in fires*. New York: Elsevier Applied Science: 357–372. Chapter 11, Part B.

White, R.H. 1987. Effect of lignin content and extractives on the higher heating value of wood. *Wood and Fiber Science*. 19(4): 446–452.

White, R.H.; Diitenberger, M.A. 2004. Cone calorimeter evaluation of wood products. In: *15th annual conference on recent advances in flame retardancy of polymeric materials*. Stamford, CT. Norwalk, CT: Business Communications Company, Inc.: 331–342.

White, R.H.; Diitenberger, M.A.; Stark, N. 2007. Cone calorimeter tests of wood-based decking materials. In: *Proceedings, 18th annual conference on recent advances in flame retardancy of polymeric materials*. Stamford, CT. Norwalk, CT: BCC Research. (2): 326–337.

Combustion Products

Brenden, J.J. 1970. Determining the utility of a new optical test procedure for measuring smoke from various

Chapter 18 Fire Safety of Wood Construction

wood products. Res. Pap. FPL 137. Madison, WI: U.S. Department of Agriculture, Forest Service, Forest Products Laboratory.

Brenden, J.J. 1975. How nine inorganic salts affected smoke yield from Douglas-fir plywood. Res. Pap. FPL 249. Madison, WI: U.S. Department of Agriculture, Forest Service, Forest Products Laboratory.

Hall, J.R., Jr. 1996. Whatever happened to combustion toxicity. *Fire Technology*. 32(4): 351–371.

Tran, H.C. 1990. Correlation of wood smoke produced from NBS smoke chamber and OSU heat release apparatus. In: Hasegawa, H.K., ed. *Characterization and toxicity of smoke*. ASTM STP 1082. Philadelphia, PA: American Society for Testing and Materials: 135–146.

Fire Resistance

AITC. [Current edition]. *Calculation of fire resistance of glued laminated timbers*. Tech. Note 7. Englewood, CO: American Institute of Timber Construction. www.aite-glulam.org.

APA. [Current edition]. *Calculating fire resistance of glulam beams and columns*. Publ. No. EWS Y245A. Tacoma, WA: APA—The Engineered Wood Association. www.apawood.org.

ASCE. 1982. *Evaluation, maintenance and upgrading of wood structures—a guide and commentary*. New York: American Society of Civil Engineers. 428 p.

AWC. [Current edition]. *Calculating the fire resistance of exposed wood members*. Tech. Rep. 10. Washington, DC: American Forest & Paper Association—American Wood Council. www.awc.org.

AWC. [Current edition]. Chapter M16: *Fire design*. In: *ASD/LRFD manual for engineered wood construction*. Washington, DC: American Forest & Paper Association—American Wood Council. www.awc.org.

AWC. [Current edition]. *Component additive method (CAM) for calculating and demonstrating assembly fire endurance*. Design for code acceptance No. 4. Washington, DC: American Forest & Paper Association—American Wood Council. www.awc.org.

AWC. [Current edition]. *Design of fire-resistive exposed wood members*. Design for code acceptance No. 2. Washington, DC: American Forest & Paper Association—American Wood Council. www.awc.org.

AWC. [Current edition]. *Fire rated wood floor and wall assemblies*. Design for code acceptance No. 3. Washington, DC: American Forest & Paper Association—American Wood Council. www.awc.org.

Gypsum Association. [Current edition]. *Fire resistance design manual*. Washington, DC: Gypsum Association. www.gypsum.org.

HUD. 1980. *Guideline on fire ratings of archaic materials and assemblies*. Rehabilitation guidelines, part 8. Washington, DC: U.S. Department of Housing and Urban Development, Superintendent of Documents. <http://www.huduser.org/Publications/PDF/fire.pdf>.

Intertek. [Current edition]. *Directory of listed product*. www.intertek-etlsemko.com.

Janssens, M. 1994. Thermo-physical properties for wood pyrolysis models. In: *Proceedings, Pacific timber engineering conference; 1994 July 11–15; Gold Coast, Australia*. Fortitude Valley MAC, Queensland, Australia: Timber Research and Development Advisory Council: 607–618.

Janssens, M.L.; White, R.H. 1994. Short communication: temperature profiles in wood members exposed to fire. *Fire and Materials*. 18: 263–265.

Ross, R.J.; Brashaw, B.K.; Wang, X.; White, R.H.; Pellerin, R.F. 2004. *Wood and timber condition assessment manual*. Madison, WI: Forest Products Society.

Schaffer, E.L. 1966. Review of information related to the charring rate of wood. Res. Note FPL–145. Madison, WI: U.S. Department of Agriculture, Forest Service, Forest Products Laboratory.

Schaffer, E.L. 1977. State of structural timber fire endurance. *Wood and Fiber*. 9(2): 145–170.

Schaffer, E.L. 1984. *Structural fire design: Wood*. Res. Pap. FPL 450. Madison, WI: U.S. Department of Agriculture, Forest Service, Forest Products Laboratory.

Tran, H.C.; White, R.H. 1992. Burning rate of solid wood measured in a heat release calorimeter. *Fire and Materials*. 16: 197–206.

UL. [Current edition]. *Fire resistance directory*. Northbrook, IL: Underwriters Laboratories, Inc. www.ul.com.

White, R.H. 2003. *Fire resistance of engineered wood rim board products*. FPL Res. Pap. 610. Madison, WI: U.S. Department of Agriculture, Forest Service, Forest Products Laboratory. 22 p.

White, R.H. 2004. Fire resistance of exposed wood members. In: *Proceedings, 5th international wood & fire safety conference*. Zvolen, Slovak Republic: Technical University of Zvolen, Faculty of Wood Science and Technology. 337–44.

White, R.H. 2006. *Fire resistance of structural composite lumber products*, Res. Pap. FPL–RP–633. Madison, WI: U.S. Department of Agriculture, Forest Service, Forest Products Laboratory. 28 p.

White, R.H. 2008. Analytical methods for determining fire resistance of timber members. In: *SFPE handbook of fire protection engineering*. 4th ed. Quincy, MA: National Fire Protection Association.

White, R.H.; Nordheim, E.V. 1992. Charring rate of wood for ASTM E 119 exposure. *Fire Technology*. 28: 5–30.

White, R.H.; Tran, H.C. 1996. Charring rate of wood exposed to a constant heat flux. In: *Proceedings, wood & fire safety, 3rd international conference. The High Tatras; 1996 May 6–9; Zvolen, Slovakia. Zvolen, Slovakia: Faculty of Wood Technology, Technical University: 175–183.*

Fire-Retardant-Treated Wood

ASTM. [Current edition]. West Conshohocken, PA: ASTM International. www.astm.org.

ASTM D 3201. Hygroscopic properties of fire-retardant wood and wood-base products.

ASTM D 5516. Evaluating the mechanical properties of fire-retardant treated softwood plywood exposed to elevated temperatures.

ASTM D 5664. Evaluating the effects of fire-retardant treatments and elevated temperatures on strength properties of fire-retardant treated lumber.

ASTM D 6305. Calculating bending strength design adjustment factors for fire-retardant-treated plywood roof sheathing.

ASTM D 6841. Calculating design value treatment adjustment factors for fire-retardant-treated lumber.

AWPA. [Current edition]. Gransbury, TX: American Wood Protection Association (formerly American Wood-Preservers' Association). www.awpa.com.

Standard A2. Analysis of waterborne preservatives and fire-retardant formulations.

Standard A3. Determining penetration of preservative and fire retardants.

Standard A9. Analysis of treated wood and treating solutions by X-ray spectroscopy.

Standard A26. Analysis of fire retardant solutions and wood by titration.

Standard T1. Use category system: processing and treatment standard.

Standard U1. Use category system: user specification for treated wood.

Holmes, C.A. 1977. Effect of fire-retardant treatments on performance properties of wood. In: Goldstein, I.S., ed. *Wood technology: chemical aspects. Proceedings, ACS symposium series 43. Washington, DC: American Chemical Society.*

ICC-ES. [Current edition]. Whittier, CA: ICC Evaluation Service, Inc. www.icc-es.org.

AC66. Acceptance criteria for fire-retardant-treated wood.

AC107. Acceptance criteria for classified wood roof systems.

Lebow, P.K.; Winandy, J.E. 2003. Using kinetic models to predict thermal degradation of fire-retardant-treated plywood roof sheathing. Paper 048. In: *Proceedings, 31st annual conference of North American Thermal Analysis Society; 2003 September 22–24; Albuquerque, NM.*

LeVan, S.L. 1984. Chemistry of fire retardancy. In: Rowell, R.M., ed. *The chemistry of solid wood. Advances in Chemistry series 207. Washington, DC: American Chemical Society.*

LeVan, S.L.; Tran, H.C. 1990. The role of boron in flame-retardant treatments. In: Hamel, M., ed. *Proceedings 47355, 1st international conference on wood protection with diffusible preservatives; 1990 November 28–30; Nashville, TN. Madison, WI: Forest Products Research Society: 39–41.*

LeVan, S.L.; Winandy, J.E. 1990. Effects of fire-retardant treatments on wood strength: a review. *Wood and Fiber Science*. 22(1): 113–131.

LeVan, S.L.; Ross, R.J.; Winandy, J.E. 1990. Effects of fire retardant chemicals on the bending properties of wood at elevated temperatures. Res. Pap. FPL–RP–498. Madison, WI: U.S. Department of Agriculture, Forest Service, Forest Products Laboratory.

NAHB. 1990. Home builders guide to fire retardant treated plywood. Evaluation, testing, and replacement. Upper Marlboro, MD: National Association of Home Builders, National Research Center.

NFPA. [Current edition]. Quincy, MA: National Fire Protection Association. www.nfpa.org.

NFPA 703. Fire retardant-treated wood and fire-retardant coatings for building materials.

Winandy, J.E. 1995. Effects of fire retardant treatments after 18 months of exposure at 150 °F (66 °C). Res. Note FPL–RN–0264. Madison, WI: U.S. Department of Agriculture, Forest Service, Forest Products Laboratory.

Winandy, J.E.; LeVan, S.L.; Ross, R.J.; Hoffman, S.P.; McIntyre, C.R. 1991. Thermal degradation of fire-retardant-treated plywood—development and evaluation of a test protocol. Res. Pap. FPL–RP–501. Madison, WI: U.S. Department of Agriculture, Forest Service, Forest Products Laboratory.

Specialty Treatments

Rebecca E. Ibach, Research Chemist

Contents

Plasticizing Wood 19–1
Principles of Plasticizing and Bending 19–1
Bent Wood Members 19–2
Laminated Members 19–2
Veneered Curved Members 19–3
Bending of Solid Members 19–3
Selection of Stock 19–3
Moisture Content of Bending Stock 19–3
Bending Operation and Apparatus 19–4
Fixing the Bend 19–4
Characteristics of Bent Wood 19–4
Modified Woods 19–4
Resin-Treated Wood—Not Compressed (Impreg) 19–4
Resin-Treated Wood—Compressed (Compreg) 19–5
Heat Treatments 19–9
Heating Wet Wood 19–9
Heating Wet Wood Followed by Compression 19–10
Heating Dry Wood 19–10
Heating Dry Wood Followed by Compression 19–10
Wood Treated with Polyethylene Glycol (PEG) 19–10
Wood–Polymer Composites 19–11
Chemical Modification 19–12
Paper-Based Plastic Laminates 19–12
Industrial Laminates 19–12
Decorative Laminates 19–13
Lignin-Filled Laminates 19–14
Paper-Face Overlays 19–14
References 19–14

Many specialty treatments can be applied to wood to either improve its performance or change its properties. Treatments addressed in this chapter are those that make permanent changes in the shape of a wood product, improvements in dimensional stability, or improvements in performance through combinations with nonwood resources.

Plasticizing Wood

Principles of Plasticizing and Bending

In simple terms, the wood cell wall is a composite made of a rigid cellulose polymer in a matrix of lignin and the hemicelluloses. The lignin polymer in the middle lamella and S2 layer is thermoplastic; that is, it softens upon heating. The glass transition temperature T_g of the lignin in the matrix is approximately 170 °C (338 °F). Above the matrix T_g , it is possible to cause the lignin to undergo thermoplastic flow and, upon cooling, reset in the same or modified configuration. This is the principle behind bending of wood.

The matrix can be thermoplasticized by heat alone, but the T_g of the unmodified matrix is so high that some fiber decomposition can occur if high temperatures are maintained for a lengthy period. The T_g of the matrix can be decreased with the addition of moisture or through the use of plasticizers or softeners.

Heat and moisture make certain species of wood sufficiently plastic for bending operations. Steaming at atmospheric or a low gauge pressure, soaking in boiling or nearly boiling water, or microwave heating moist wood are satisfactory methods of plasticizing wood. Wood at 20% to 25% moisture content needs to be heated without losing moisture; at lower moisture content, heat and moisture must be added. As a consequence, the recommended plasticizing processes are steaming or boiling for about 15 min cm⁻¹ (38 min in⁻¹) of thickness for wood at 20% to 25% moisture content and steaming or boiling for about 30 min cm⁻¹ (75 min in⁻¹) of thickness for wood at lower moisture content levels. Steaming at high pressures causes wood to become plastic, but wood treated with high pressure steam generally does not bend as successfully as does wood treated at atmospheric or low pressure. Microwave heating requires much shorter times.

Wood can be plasticized by a variety of chemicals in addition to water. Common chemicals that plasticize wood include urea, dimethylol urea, low-molecular-weight phenol-formaldehyde resin, dimethyl sulfoxide, and liquid ammonia. Urea and dimethylol urea have received limited

commercial attention, and a bending process using liquid ammonia has been patented. Wood members can be readily molded or shaped after immersion in liquid ammonia or treatment under pressure with ammonia in the gas phase. As the ammonia evaporates, the lignin resets, the wood stiffens and retains its new shape. Plasticization of the lignin matrix alone can be done using chemical modification technologies, which are covered later in this chapter.

It is also possible to bend wood without softening or plasticizing treatments. However, the stability of the final product may not be as permanent as from treatments in which softening and plasticizing methods are used.

Bent Wood Members

Bending can provide a variety of functional and esthetically pleasing wood members, ranging from large curved arches to small furniture components. The curvature of the bend, size of the member, and intended use of the product determine the production method.

Laminated Members

At one time in the United States, curved pieces of wood were laminated chiefly to produce small items such as parts for furniture and pianos. However, the principle was extended to the manufacture of arches for roof supports in farm, industrial, and public buildings and other types of structural members (see Chap. 11). The laminations are bent without end pressure against a form and adhesively bonded together. Both softwoods and hardwoods are suitable for laminated bent structural members, and thin material of any species can be bent satisfactorily for such purposes. The choice of species and adhesive depends primarily on the cost, required strength, and demands of the application.

Laminated curved members are produced from dry stock in a single bending and adhesive bond formation operation. This process has the following advantages compared with bending single-piece members:

- Bending thin laminates to the required radius involves only moderate stress and deformation of the wood fibers, eliminating the need for treatment with steam or hot water and associated drying and conditioning of the finished product. In addition, the moderate stresses involved in curving laminated members result in stronger members when compared with curved single-piece members.
- The tendency of laminated members to change shape with changes in moisture content is less than that of single-piece bent members.
- Ratios of thickness of member to radius of curvature that are impossible to obtain by bending single pieces can be attained readily by laminating.
- Curved members of any desired length can be produced.

Straight-laminated members can be steamed and bent after they are bonded together. However, this type of procedure requires an adhesive that will not be affected by the steaming or boiling treatment and complicates conditioning of the finished product.

Curved Plywood

Curved plywood is produced either by bending and adhesive bonding the plies in one operation or by bending previously bonded flat plywood. Plywood curved by bending and bonding simultaneously is more stable in curvature than plywood curved by bending previously bonded material.

Plywood Bent and Adhesively Bonded Simultaneously

In bending and bonding plywood in a single operation, adhesive-coated pieces of veneer are assembled and pressed over or between curved forms. Pressure and sometimes heat are applied through steam or electrically heated forms until the adhesive sets and holds the assembly to the desired curvature. Some laminations are at an angle, usually 90°, to other laminations, as in the manufacture of flat plywood. The grain direction of the thicker laminations is normally parallel to the axis of the bend to facilitate bending.

A high degree of compound curvature can be obtained in an assembly made up of a considerable number of thin veneers. First, for both the face and back of the assembly, the two outer plies are bonded at 90° to each other in a flat press. The remaining veneers are then adhesive-coated and assembled at any desired angle to each other. The entire assembly is hot-pressed to the desired curvature.

Bonding the two outer plies before molding allows a higher degree of compound curvature without cracking the face plies than could otherwise be obtained. Where a high degree of compound curvature is required, the veneer should be relatively thin (less than 3 mm (1/8 in.)) with a moisture content of about 12%.

The molding of plywood with fluid pressure applied by flexible bags of some impermeable material produces plywood parts of various degrees of compound curvature. In “bag molding,” fluid pressure is applied through a rubber bag by air, steam, or water. The veneer is wrapped around a form, and the whole assembly is enclosed in a bag and subjected to pressure in an autoclave, the pressure in the bag being “bled.” Or the veneer may be inserted inside a metal form and, after the ends have been attached and sealed, pressure is applied by inflating a rubber bag. The form may be heated electrically or by steam.

The advantages of bending and bonding plywood simultaneously to form a curved shape are similar to those for curved-laminated members. In addition, the cross plies give the curved members properties that are characteristic of cross-banded plywood. Curved plywood shells for furniture manufacture are examples of these bent veneer and adhesive-bonded products.

Plywood Bent after Bonding

After the plies are bonded together, flat plywood is often bent by methods that are somewhat similar to those used in bending solid wood. To bend plywood properly to shape, it must be plasticized by some means, usually moisture or heat, or a combination of both. The amount of curvature that can be introduced into a flat piece of plywood depends on numerous variables, such as moisture content, direction of grain, thickness and number of plies, species and quality of veneer, and the technique applied in producing the bend. Plywood is normally bent over a form or a bending mandrel.

Flat plywood bonded with a waterproof adhesive can be bent to compound curvatures after bonding. However, no simple criterion is available for predetermining whether a specific compound curvature can be imparted to flat plywood. Soaking the plywood prior to bending and using heat during forming are aids in manipulation. Usually, the plywood to be postformed is first thoroughly soaked in hot water, and then dried between heated forming dies attached to a hydraulic press. If the use of postforming for bending flat plywood to compound curvatures is contemplated, exploratory trials to determine the practicability and the best procedure are recommended. Remember that in postforming plywood to compound curvatures, all the deformation must be by compression or shear because plywood cannot be stretched. Hardwood species, such as birch, poplar, and gum, are usually used in plywood that is to be postformed.

Veneered Curved Members

Veneered curved members are usually produced by bonding veneer to one or both faces of a curved solid-wood base. The bases are ordinarily sawn to the desired shape or bent from a piece grooved with saw kerfs on the concave side at right angles to the direction of bend. Pieces bent by making saw kerfs on the concave side are commonly reinforced and kept to the required curvature by bonding splines, veneer, or other pieces to the curved base. Veneering over curved solid wood is used mainly in furniture. The grain of the veneer is commonly laid in the same general direction as the grain of the curved wood base. The use of crossband veneers, that is, veneers lay with the grain at right angles to the grain of the back and face veneer, decreases the tendency of the member to split.

Bending of Solid Members

Wood of certain species that is steamed, microwaved, or soaked in boiling water can be compressed as much as 25% to 30% parallel to the grain. The same wood can be stretched only 1% to 2%. Because of the relation between attainable tensile and compressive deformations, if bending involves severe deformation, then most of the deformation must be compression. The inner or concave side must assume the maximum amount of compression, and the outer or convex side must experience zero strain or a slight tension. To accomplish this, a metal strap equipped with end

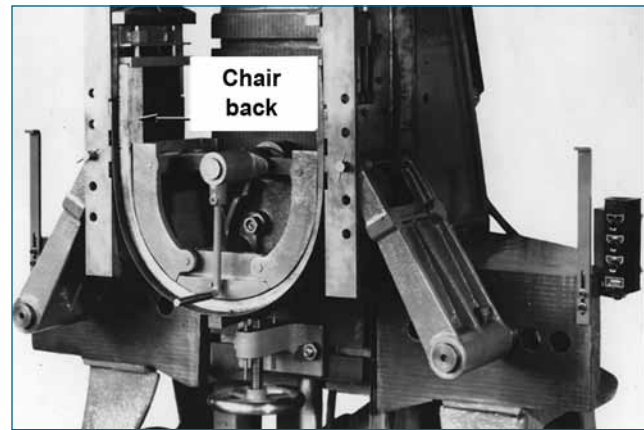

Figure 19–1. Chair back being bent through an arc of 180° in a bending machine.

fittings is customarily used. The strap makes contact with the outer or convex side and, acting through the end fittings, places the whole piece of wood in compression. The tensile stress that would normally develop in the outer side of the piece of wood during bending is borne by the metal strap. A bending form is shown in Figure 19–1.

Selection of Stock

In general, hardwoods possess better bending quality than softwoods, and certain hardwoods surpass others in this quality. This is interesting from a theoretical point of view because hardwoods contain less lignin than softwoods. Hardwoods also contain much more hemicelluloses in the matrix than do softwoods. The species commonly used to produce bent members are white oak, red oak, elm, hickory, ash, beech, birch, maple, walnut, sweetgum, and mahogany. As stated, most softwoods have a poor bending quality and are not often used in bending operations. However, Pacific yew and yellow-cedar are exceptions to this rule. In addition, Douglas-fir, southern yellow pine, northern and Atlantic white-cedar, and redwood are used for ship and boat planking for which purpose they are often bent to moderate curvature after being steamed or soaked.

Bending stock should be free from serious cross grain and distorted grain, such as may occur near knots. The slope of cross grain should not be steeper than about 1 to 15. Decay, knots, shake, pith, surface checks, and exceptionally light or brittle wood should be avoided.

Moisture Content of Bending Stock

Although green wood can be bent to produce many curved members, difficulties are encountered in drying and fixing the bend. Another disadvantage with green stock is that hydrostatic pressure may be developed during bending. Hydrostatic pressure can cause compression failures on the concave side if the wood is compressed by an amount greater than the air space in the cells of the green wood.

Bending stock that has been dried to low moisture content level requires a lengthy steaming or soaking process to increase its moisture content to the point where it can be made sufficiently plastic for successful bending. For most chair and furniture parts, the moisture content of the bending stock should be 12% to 20% before it is steamed or microwave heated. The preferred moisture content level varies with the severity of the curvature to which the wood is bent and the method used in drying and fixing the bent member. For example, chair-back slats, which have a slight curvature and are subjected to severe drying conditions between steam-heated platens, can be produced successfully from stock at 12% moisture content. For furniture parts that need a more severe bend where the part must be bent over a form, 15% to 20% moisture content is recommended.

Bending Operation and Apparatus

After being plasticized, the stock should be quickly placed in the bending apparatus and bent to shape. The bending apparatus consists essentially of a form (or forms) and a means of forcing the piece of steamed wood against the form. If the curvature to be obtained demands a difference of much more than 3% between lengths of the outer and inner surfaces of the pieces, then the apparatus should include a device for applying end pressure. This generally takes the form of a metal strap or pan provided with end blocks, end bars, or clamps.

Fixing the Bend

After being bent, the piece should be cooled and dried while held in its curved shape. One method is to dry the piece in the bending machine between the plates of a hot-plate press. Another method is to secure the bent piece to the form and place both the piece and the form in a drying room. Still another is to keep the bent piece in a minor strap with tie rods or stays so that it can be removed from the form and placed in a drying room. When the bent member has cooled and dried to moisture content suitable for its intended use, the restraining devices can be removed and the piece will hold its curved shape.

Characteristics of Bent Wood

After a bent piece of wood is cooled and dried, the curvature will be maintained. An increase in moisture content may cause the piece to lose some of its curvature. A decrease in moisture content may cause the curve to become sharper, although repeated changes in moisture content bring about a gradual straightening. These changes are caused primarily by lengthwise swelling or shrinking of the inner (concave) face, the fibers of which were wrinkled or folded during the bending operation.

A bent piece of wood has less strength than a similar unbent piece. However, the reduction in strength brought about by bending is seldom serious enough to affect the utility value of the member.

Modified Woods

Wood can be chemically modified to improve water repellency, dimensional stability, resistance to acids or bases, ultraviolet radiation, biodeterioration, and thermal degradation. Wood can also be chemically treated, then compressed to improve dimensional stability and increase hardness. Sheets of paper treated with resins or polymers can be laminated and hot pressed into thick panels that have the appearance of plastic rather than paper. These sheets are used in special applications because of their structural properties and in items requiring hard, impervious, and decorative surfaces.

Modified woods, modified wood-based materials, and paper-based laminates are usually more expensive than wood because of the cost of the chemicals and the special processing required producing them. Thus, modified wood use is generally limited to special applications where the increased cost is justified by the special properties needed.

Wood is treated with chemicals to increase hardness and other mechanical properties, as well as its resistance to decay, fire, weathering, and moisture. The rate and extent of swelling and shrinking of the wood when in contact with water is decreased by application of water-resistant chemicals to the surface of wood, impregnation of the wood with such chemicals dissolved in water or volatile solvents, or bonding chemicals to the cell wall polymer. Such treatments may also decrease the rate at which wood changes dimension as a result of humidity, even though these treatments do not affect the final dimensional changes caused by lengthy duration exposures. Paints, varnishes, lacquers, wood-penetrating water repellents, and plastic and metallic films retard the rate of moisture absorption but have little effect on total dimensional change if exposure to moisture is extensive and prolonged.

Resin-Treated Wood—Not Compressed (Impreg)

Permanent stabilization of the dimensions of wood is needed for certain specialty uses. This can be accomplished by depositing a bulking agent within the swollen structure of the wood fibers. The most successful bulking agents that have been commercially applied are highly water-soluble, thermosetting, phenol-formaldehyde resin-forming systems, with initially low molecular weights. No thermoplastic resins have been found that effectively stabilize the dimensions of wood.

Wood treated with a thermosetting, fiber-penetrating resin and cured without compression is known as impreg. The wood (preferably green veneer to facilitate resin pickup) is soaked in the aqueous resin-forming solution or, if air dry, is impregnated with the solution under pressure until the resin content equals 25% to 35% of the weight of dry wood. The treated wood is allowed to stand under nondrying conditions

for 1 to 2 days to permit uniform distribution of the solution throughout the wood. The resin-containing wood is dried at moderate temperatures to remove the water, and then heated to higher temperatures to cure the resin.

Uniform distribution of the resin has been effectively accomplished with thick wood specimens only in sapwood of readily penetrated species. Although thicker material can be treated, the process is usually applied to veneers up to about 8 mm (0.3 in.) thick, because treating time increases rapidly with increases in thickness. Drying thick, resin-treated wood may result in checking and honeycombing. For these reasons, treatments should be confined to veneer and the treated-cured veneer used to build the desired products. Any species can be used for the veneer except the resinous pines. The stronger the original wood, the stronger the end product.

Impreg has a number of properties differing from those of normal wood and ordinary plywood. These properties are given in Table 19–1, with similar generalized findings for other modified woods. Data for the strength properties of yellow birch impreg are given in Table 19–2. Information on thermal expansion properties of ovendry impreg is given in Table 19–3.

The good dimensional stability of impreg is the basis of one use where its cost is not a deterrent. Wood dies of automobile body parts serve as the master from which the metal-forming dies are made for actual manufacture of parts. Small changes in moisture content, even with the most dimensionally stable wood, produce changes in dimension and curvature of an unmodified wood die. Such changes create major problems in making the metal-forming dies where close final tolerances are required. The use of impreg, with its high antishrink efficiency (ASE) (Table 19–4), almost entirely eliminated the problem of dimensional change during the entire period that the wood master dies were needed. Despite the tendency of the resins to dull cutting tools, pattern makers accepted the impreg readily because it machines with less splitting than unmodified wood.

Patterns made from impreg are also superior to unmodified wood in resisting heat when used with shell-molding techniques where temperatures as high as 205 °C (400 °F) are required to cure the resin in the molding sand.

Resin-Treated Wood—Compressed (Compreg)

Compreg is similar to impreg except that it is compressed before the resin is cured within the wood. The resin-forming chemicals (usually phenol-formaldehyde) act as plasticizers for the wood so that it can be compressed under modest pressure (6.9 MPa, 1,000 lb in⁻²) to a specific gravity of 1.35. Some properties of compreg are similar to those of impreg, and others vary considerably (Tables 19–1 and 19–2). Compared with impreg, the advantages of compreg are its natural lustrous finish that can be developed on any cut

surface by sanding with fine-grit paper and buffing, its greater strength properties, and its ability to mold (Tables 19–1 and 19–2). However, thermal expansion coefficients of ovendry compreg are also increased (Table 19–3).

Compreg can be molded by (a) gluing blocks of resin-treated (but still uncured) wood with a phenolic glue so that the gluelines and resin within the plies are only partially set; (b) cutting to the desired length and width but two to three times the desired thickness; and (c) compressing in a split mold at about 150 °C (300 °F). Only a small flash squeeze out at the parting line between the two halves of the mold needs to be machined off. This technique was used for motor-test propellers and airplane antenna masts during World War II.

A more satisfactory molding technique, known as expansion molding, has been developed. The method consists of rapidly precompressing dry but uncured single sheets of resin-treated veneer in a cold press after preheating the sheets at 90 to 120 °C (195 to 250 °F). The heat-plasticized wood responds to compression before cooling. The heat is insufficient to cure the resin, but the subsequent cooling sets the resin temporarily. These compressed sheets are cut to the desired size, and the assembly of plies is placed in a split mold of the final desired dimensions. Because the wood was precompressed, the filled mold can be closed and locked. When the mold is heated, the wood is again plasticized and tends to recover its uncompressed dimensions. This exerts an internal pressure in all directions against the mold equal to about half the original compressing pressure. On continued heating, the resin is set. After cooling, the object may be removed from the mold in finished form. Metal inserts or metal surfaces can be molded to compreg or its handles are molded onto tools by this means. Compreg bands have been molded to the outside of turned wood cylinders without compressing the core. Compreg tubes and small airplane propellers have been molded in this way.

Past uses of compreg were related largely to aircraft; however, it is a suitable material where bolt-bearing strength is required, as in connector plates, because of its good specific strength (strength per unit of weight). Layers of veneer making up the compreg for such uses are often cross laminated (alternate plies at right angles to each other, as in plywood) to give nearly equal properties in all directions.

As a result of its excellent strength properties, dimensional stability, low thermal conductivity, and ease of fabrication, compreg is extremely useful for aluminum drawing and forming dies, drilling jigs, and jigs for holding parts in place while welding.

Compreg has also been used in silent gears, pulleys, water-lubricated bearings, fan blades, shuttles, bobbins, and picker sticks for looms, nuts and bolts, instrument bases and cases, musical instruments, electrical insulators, tool handles, and various novelties. At present, compreg finds considerable

Table 19–1. Properties of modified woods

Property	Impreg	Compreg	Staypak
Specific gravity	15% to 20% greater than normal wood	Usually 1.0 to 1.4	1.25 to 1.40
Equilibrium swelling and shrinking	1/4 to 1/3 that of normal wood	1/4 to 1/3 that of normal wood at right angle to direction of compression, greater in direction of compression but very slow to attain	Same as normal wood at right angle to direction of compression, greater in direction of compression but very slow to attain
Springback	None	Very small when properly made	Moderate when properly made
Face checking	Practically eliminated	Practically eliminated for specific gravities less than 1.3	About the same as in normal wood
Grain raising	Greatly reduced	Greatly reduced for uniform-texture woods, considerable for contrasting grain woods	About the same as in normal wood
Surface finish	Similar to normal wood	Varnished-like appearance for specific gravities greater than about 1.0; cut surfaces can be given this surface by sanding and buffing	Varnished-like appearance; cut surfaces can be given this surface by sanding and buffing
Permeability to water vapor	About 1/10 that of normal wood	No data, but presumably much less than impreg	No data, but presumably less than impreg
Decay and termite resistance	Considerably better than normal wood	Considerably better than normal wood	Normal, but decay occurs somewhat more slowly
Acid resistance	Considerably better than normal wood	Better than impreg because of impermeability	Better than normal wood because of impermeability, but not as good as compreg
Alkali resistance	Same as normal wood	Somewhat better than normal wood because of impermeability	Somewhat better than normal wood because of impermeability
Fire resistance	Same as normal wood	Same as normal wood for long exposures, somewhat better for short exposures	Same as normal wood for long exposures, somewhat better for short exposures
Heat resistance	Greatly increased	Greatly increased	No data
Electrical conductivity	1/10 that of normal wood at 30% RH; 1/1,000 that of normal wood at 90% RH	Slightly more than impreg at low relative humidity values due to entrapped water	No data
Heat conductivity	Slightly increased	Increased about in proportion to specific gravity increase	No data, but should increase about in proportion to specific gravity increase
Compressive strength	Increased more than proportional to specific gravity increase	Increased considerably more than proportional to specific gravity increase	Increased about in proportion to specific gravity increase parallel to grain, increased more perpendicular to grain
Tensile strength	Decreased significantly	Increased less than proportional to specific gravity increase	Increased about in proportion to specific gravity increase
Flexural strength	Increased less than proportional to specific gravity increase	Increased less than proportional to specific gravity increase parallel to grain, increased more perpendicular to grain	Increased proportional to specific gravity increase parallel to grain, increased more perpendicular to grain
Hardness	Increased considerably more than proportional to specific gravity increase	10 to 20 times that of normal wood	10 to 18 times that of normal wood
Impact strength			
Toughness	About 1/2 of value for normal wood, but very susceptible to the variables of manufacture	1/2 to 3/4 of value for normal wood, but very susceptible to the variables of manufacture	Same to somewhat greater than normal wood
Izod	About 1/5 of value for normal wood	1/3 to 3/4 of value for normal wood	Same to somewhat greater than normal wood
Abrasion resistance (tangential)	About 1/2 of value for normal wood	Increased about in proportion to specific gravity increase	Increased about in proportion to specific gravity increase
Machinability	Cuts cleaner than normal wood, but dulls tools more	Requires metalworking tools and metalworking tool speeds	Requires metalworking tools and metalworking tool speeds
Moldability	Cannot be molded but can be formed to single curvatures at time of assembly	Can be molded by compression and expansion molding methods	Cannot be molded
Gluability	Same as normal wood	Same as normal wood after light sanding or in the case of thick stock, machining surfaces plane	Same as normal wood after light sanding, or in the case of thick stock, machining surfaces plane

Table 19–2. Strength properties of normal and modified laminates^a of yellow birch and a laminated paper plastic

Property	Normal laminated wood ^b	Impreg (impregnated, uncompressed) ^c	Compreg (impregnated, highly compressed) ^c	Staypak (unimpregnated, highly compressed) ^b	Paper laminate (impregnated, highly compressed) ^d
Thickness of laminate (mm (in.))	23.9 (0.94)	26.2 (1.03)	16.0 (0.63)	12.2 (0.48)	3.2 (0.126) 13.0 (0.512)
Moisture content at time of test (%)	9.2	5.0	5.0	4.0	—
Specific gravity (based on weight and volume at test)	0.7	0.8	1.3	1.4	1.4
Parallel laminates					
Flexure—grain parallel to span (flatwise) ^e					
Proportional limit stress (MPa (lb in ⁻²))	79.3 (11,500)	109.6 (15,900)	184.1 (26,700)	138.6 (20,100)	109.6 (15,900)
Modulus of rupture (MPa (lb in ⁻²))	140.6 (20,400)	129.6 (18,800)	250.3 (36,300)	271.6 (39,400)	252.3 (36,600)
Modulus of elasticity (GPa (1,000 lb in ⁻²))	16.0 (2,320)	16.4 (2,380)	25.4 (3,690)	30.7 (4,450)	20.8 (3,010)
Flexure—grain perpendicular to span (flatwise) ^e					
Proportional limit stress (MPa (lb in ⁻²))	6.9 (1,000)	9.0 (1,300)	29.0 (4,200)	22.1 (3,200)	72.4 (10,500)
Modulus of rupture (MPa (lb in ⁻²))	13.1 (1,900)	11.7 (1,700)	31.7 (4,600)	34.5 (5,000)	167.5 (24,300)
Modulus of elasticity (GPa (1,000 lb in ⁻²))	1.0 (153)	1.5 (220)	4.3 (626)	4.2 (602)	10.2 (1,480)
Compression parallel to grain (edgewise) ^e					
Proportional limit stress (MPa (lb in ⁻²))	44.1 (6,400)	70.3 (10,200)	113.1 (16,400)	66.9 (9,700)	49.6 (7,200)
Ultimate strength (MPa (lb in ⁻²))	65.5 (9,500)	106.2 (15,400)	180.0 (26,100)	131.7 (19,100)	144.1 (20,900)
Modulus of elasticity (GPa (1,000 lb in ⁻²))	15.8 (2,300)	17.0 (2,470)	26.1 (3,790)	32.2 (4,670)	21.5 (3,120)
Compression perpendicular to grain (edgewise) ^f					
Proportional limit stress (MPa (lb in ⁻²))	4.6 (670)	6.9 (1,000)	33.1 (4,800)	17.9 (2,600)	29.0 (4,200)
Ultimate strength (MPa (lb in ⁻²))	14.5 (2,100)	24.8 (3,600)	96.5 (14,000)	64.8 (9,400)	125.5 (18,200)
Modulus of elasticity (GPa (1,000 lb in ⁻²))	1.1 (162)	1.7 (243)	3.9 (571)	4.0 (583)	11.0 (1,600)
Compression perpendicular to grain (flatwise) ^e					
Maximum crushing strength (MPa (lb in ⁻²))	—	29.5 (4,280)	115.1 (16,700)	91.0 (13,200)	291.0 (42,200)
Tension parallel to grain (lengthwise)					
Ultimate strength (MPa (lb in ⁻²))	153.1 (22,200)	108.9 (15,800)	255.1 (37,000)	310.3 (45,000)	245.4 (35,600)
Modulus of elasticity (GPa (1,000 lb in ⁻²))	15.8 (2,300)	17.3 (2,510)	27.2 (3,950)	31.8 (4,610)	25.1 (3,640)
Tension perpendicular to grain (edgewise)					
Ultimate strength (MPa (lb in ⁻²))	9.6 (1,400)	9.6 (1,400)	22.1 (3,200)	22.8 (3,300)	137.9 (20,000)
Modulus of elasticity (GPa (1,000 lb in ⁻²))	1.1 (166)	1.6 (227)	4.3 (622)	4.0 (575)	11.8 (1,710)
Shear strength parallel to grain (edgewise) ^f					
Johnson double shear across laminations (MPa (lb in ⁻²))	20.5 (2,980)	23.8 (3,460)	50.8 (7,370)	43.9 (6,370)	122.7 (17,800)
Cylindrical double shear parallel to laminations (MPa (lb in ⁻²))	20.8 (3,020)	24.5 (3,560)	39.2 (5,690)	21.2 (3,080)	20.7 (3,000)
Shear modulus					
Tension method (GPa (1,000 lb in ⁻²))	1.2 (182)	1.8 (255)	3.1 (454)	—	—
Plate shear method (FPL test) (GPa (1,000 lb in ⁻²))	—	—	—	2.6 (385)	6.3 (909)
Toughness (FPL test edgewise) ^f (J (in-lb))	26.6 (235)	14.1 (125)	16.4 (145)	28.2 (250)	—
Toughness (FPL test edgewise) ^f (J mm ⁻¹ of width (in-lb in ⁻¹ of width))	1.1 (250)	0.53 (120)	1.0 (230)	2.3 (515)	—
Impact strength (Izod)—grain lengthwise					
Flatwise (notch in face) (J mm ⁻¹ of notch (ft-lb in ⁻¹ of notch))	0.75 (14.0)	0.12 (2.3)	0.23 (4.3)	0.68 (12.7)	0.25 (4.7)
Edgewise (notch in face) (J mm ⁻¹ of notch (ft-lb in ⁻¹ of notch))	0.60 (11.3)	0.10 (1.9)	0.17 (3.2) ^g	—	0.036 (0.67)
Hardness					
Rockwell flatwise ^e (M–numbers)					
Load to embed 11.3-mm (0.444-in.) steel ball to 1/2 its diameter (kN (lb))	7.1 (1,600)	10.7 (2,400)	—	—	—
Hardness modulus (H_M) ^h (MPa (lb in ⁻²))	37.2 (5,400)	63.4 (9,200)	284.8 (41,300)	302.0 (43,800)	245.4 (35,600)
Abrasion—Navy wear-test machine (flatwise) ^e wear per 1,000 revolutions (mm (in.))	0.76 (0.030)	1.45 (0.057)	0.46 (0.018)	0.38 (0.015)	0.46 (0.018)

Table 19–2. Strength properties of normal and modified laminates^a of yellow birch and a laminated paper plastic—con.

Property	Normal laminated wood ^b	Impreg (impregnated, uncompressed) ^c	Compreg (impregnated, highly compressed) ^c	Staypak (unimpregnated, highly compressed) ^b	Paper laminate (impregnated, highly compressed) ^d
Water absorption (24-h immersion) increase in weight (%)	43.6	13.7	2.7	4.3	2.2
Dimensional stability in thickness direction					
Equilibrium swelling (%)	9.9	2.8	8.0	29	—
Recovery from compression (%)	—	0	0	4	—
Crossband laminates					
Flexure—face grain parallel to span (flatwise) ^e					
Proportional limit stress (MPa (lb in ⁻²))	47.6 (6,900)	55.8 (8,100)	99.3 (14,400)	78.6 (11,400)	86.9 (12,600)
Modulus of rupture (MPa (lb in ⁻²))	90.3 (13,100)	78.6 (11,400)	157.2 (22,800)	173.0 (25,100)	215.8 (31,300)
Modulus of elasticity (GPa (1,000 lb in ⁻²))	9.0 (1,310)	11.5 (1,670)	17.1 (2,480)	20.0 (2,900)	15.4 (2,240)
Compression parallel to face grain (edgewise) ^f					
Proportional limit stress (MPa (lb in ⁻²))	22.8 (3,300)	35.8 (5,200)	60.0 (8,700)	35.8 (5,200)	34.5 (5,000)
Ultimate strength (MPa (lb in ⁻²))	40.0 (5,800)	78.6 (11,400)	164.8 (23,900)	96.5 (14,000)	130.3 (18,900)
Modulus of elasticity (GPa (1,000 lb in ⁻²))	9.4 (1,360)	10.3 (1,500)	15.8 (2,300)	18.6 (2,700)	16.3 (2,370)
Tension parallel to face grain (lengthwise)					
Ultimate strength (MPa (lb in ⁻²))	84.8 (12,300)	54.5 (7,900)	113.8 (16,500)	168.9 (24,500)	187.5 (27,200)
Modulus of elasticity (GPa (1,000 lb in ⁻²))	8.9 (1,290)	10.1 (1,460)	15.1 (2,190)	17.7 (2,570)	18.6 (2,700)
Toughness (FPL test edgewise) ^f (J mm ⁻¹ of width (in-lb in ⁻¹ of width))	0.47 (105)	0.18 (40)	0.51 (115)	1.4 (320)	—

^aLaminates made from 17 plies of 1.6-mm (1/16-in.) rotary-cut yellow birch veneer.

^bVeneer conditioned at 27 °C (80 °F) and 65% relative humidity before assembly with phenol resin film adhesive.

^cImpregnation, 25% to 30% of water-soluble phenol-formaldehyde resin based on the dry weight of untreated veneer.

^dHigh-strength paper (0.076-mm (0.003-in.) thickness) made from commercial unbleached black spruce pulp (*Mitscherlich subtilis*), phenol resin content 36.3% based on weight of treated paper, Izod impact abrasion, flatwise compression, and shear specimens, all on 12.7-mm- (1/2-in.-) thick laminate.

^eLoad applied to the surface of the original material (parallel to laminating pressure direction).

^fForest Products Laboratory (FPL) test procedure: load applied to edge of laminations (perpendicular to laminating pressure direction).

^gValues as high as 0.53 J mm⁻¹ (10.0 ft-lb in⁻¹) of notch have been reported for compreg made with alcohol-soluble resins and 0.37 J mm⁻¹ (7.0 ft-lb in⁻¹) with water-soluble resins.

^hValues based on the average slope of load–penetration plots where H_M is an expression for load per unit of spherical area of penetration of the 11.3-mm (0.444-in.) steel ball expressed in MPa (lb in⁻²).

Table 19–3. Coefficients of linear thermal expansion per degree Celsius of wood, hydrolyzed wood, and paper products^a

Material ^b	Specific gravity of product	Resin content ^c (%)	Fiber or machine direction	Linear expansion per °C (values multiplied by 10 ⁶)		
				Perpendicular to fiber or machine direction in plane of laminations	Pressing direction	Cubical expansion per °C (values multiplied by 10 ⁶)
Yellow birch laminate	0.72	3.1	3.254	40.29	36.64	80.18
Yellow birch staypak laminate	1.30	4.7	3.406	37.88	65.34	106.63
Yellow birch impreg laminate	0.86	33.2	4.648	35.11	37.05	76.81
Yellow birch compreg laminate	1.30	24.8	4.251	39.47	59.14	102.86
	1.31	34.3	4.931	39.32	54.83	99.08
Sitka spruce laminate	0.53	6.0 ^d	3.887	37.14	27.67	68.65
Parallel-laminated paper laminate	1.40	36.5	5.73	15.14	65.10	85.97
Crossbanded paper laminate	1.40	36.5	10.89	11.0 ^e	62.2	84.09
Molded hydrolyzed-wood plastic	1.33	25	42.69	42.69	42.69	128.07
Hydrolyzed-wood sheet laminate	1.39	18	13.49	224.68	77.41	115.58

^aThese coefficients refer to bone-dry material. Generally, air-dry material has a negative thermal coefficient, because the shrinkage resulting from the loss in moisture is greater than the normal thermal expansion.

^bAll wood laminates made from rotary-cut veneer, annual rings in plane of sheet.

^cOn basis of dry weight of product.

^dApproximate.

^eCalculated value.

Table 19–4. Comparison of wood treatments and the degree of dimensional stability achieved

Treatment	Antishrink efficiency (%)
Simple wax dip	2 to 5
Wood–plastic combination	10 to 15
Staypak/Staybwood	30 to 40
Impreg	65 to 70
Chemical modification	65 to 75
Polyethylene glycol	80 to 85
Formaldehyde	82 to 87
Compreg	90 to 95

use in handles for knives and other cutlery. The expansion-molding techniques of forming and curing of the compreg around the metal parts of the handle as well as attaching previously made compreg with rivets are two methods used. Compreg is currently manufactured worldwide, including the United States, United Kingdom, Pakistan, and India.

Veneer of any nonresinous species can be used for making compreg. Most properties depend upon the specific gravity to which the wood is compressed rather than the species used.

Heat Treatments

Heating wood changes the properties of wood. It can decrease the hygroscopicity and improve the dimensional stability and decay resistance. Yet, at the same time, the increase in stability and durability also increases the brittleness and loss in some strength properties, including impact toughness, modulus of rupture, and work to failure. The treatments usually cause a darkening of the wood and the wood has a tendency to crack and split.

Wood can be heated various ways: heating in the presence of moisture, heating in the presence of moisture followed by compression, heating dry wood, and heating dry wood followed by compression. The effect of the heating process on wood properties depends on the process itself. As the wood is heated, the first weight loss is due to the loss of water, followed by a variety of chemistries that produce degradation products and volatile gasses. As the temperature increases, wood cell wall polymers start to degrade. Pyrolysis of the hemicelluloses takes place about 270 °C followed closely by cellulose. Lignin is much more stable to high temperature.

Many of the commercial heat treating processes take place in the absence of air at temperatures ranging from 180 to 260 °C for times ranging from a few minutes to several hours. Temperatures lower than 140 °C result in less change in physical properties, and heating above 300 °C results in severe wood degradation. Wood has been heated in steam, in an inert gas, below molten metal, and in hot oil baths. Improved dimensional stability and durability are thought to be due to a loss of hydroscopic hemicellulose sugars and their conversion to furan-based polymers that are much less

hydroscopic, and the lost sugars decrease the ability of fungi to attack the heated wood. The weight loss is proportional to the square of the reduction in swelling.

A variety of thermal modification processes have been developed. The results of the process depend on several variables, including time and temperature, treatment atmosphere, wood species, moisture content, wood dimensions, and the use of a catalyst. Temperature and time of treatment are the most critical elements. Treatments done in air result in oxidation reactions not leading to the desired properties of the treated wood. Generally, weight loss occurs to a greater extent in hardwoods than in softwoods.

Several names have been given to the various heat-treated products and treatments for wood, including Staypak and Staybwood in the United States, Lignostone and Lignofol in Germany, Jicwood and Jablo in the United Kingdom, ThermoWood in Finland, Plato in the Netherlands, and Perdure and Retification in France.

Heating wood under a variety of conditions is an environmentally benign process requiring no added chemicals and gives rise to a variety of products with decreased moisture contents and some durability against biological degradation. However, it is not recommended to be used in ground contact. Most physical properties are decreased, especially abrasion resistance and toughness, and it is therefore not suitable for load-bearing applications.

Heating Wet Wood

Wood with moisture content close to its equilibrium moisture content (EMC) that is heated to 180 to 200 °C results in a wood with greatly decreased moisture content. The high temperature degrades the hemicellulose sugars to furan-based intermediates and volatile gasses. The furan intermediates have a lower EMC than the sugars and increase bonding of the wood structure. At a weight loss of approximately 25%, the EMC is lowered by almost the same percentage. Dimensional stability is also increased but not as much as heating followed by compression (discussed in the following section).

Two current processes are based on heating wet wood for stability and increased biological resistance. ThermoWood was developed by VTT in Finland and is a three-stage process done in the presence of steam, which helps protect the wood from oxidative reactions. In the first stage, the wood is heated to 100 °C for almost 20 h. In the second stage, the wood is heated to 185 to 230 °C for 10 h, followed by the lowering of the temperature in the presence of a water spray.

Plato (Proving Lasting Advanced Timber Option) wood was developed by Royal Dutch Shell in The Netherlands and involves a four-stage process. The first stage involves heating the wood to 150 to 180 °C under high-pressure steam for 4 to 5 h. The wood is then dried to a moisture content of 8% to 10% and then heated again at 150 to 190 °C for 12 to

16 h, resulting in a drop in moisture content to less than 1%. The wood is then conditioned to 4% to 6% moisture over a 3-day period. The wood is dark brown in color but will weather to the normal gray color in time. It has a 5% to 20% decrease in modulus of rupture but a slightly higher modulus of elasticity.

The Le Bois Perdure process was developed by the French company BCI in the mid-1990s and has been commercialized by PCI Industries, Inc., based in Quebec. The process involves drying and heating the wood at 200 to 230 °C in steam.

All heat-treated wood is gluable and paintable and can be used for furniture, flooring, decking, door and window components, and exterior joinery.

Heating Wet Wood Followed by Compression

When wet wood is heated to 180 to 220 °C and compressed, the wood structure is compressed and remains in this compressed state when dried. The compressed wood is much harder and has a much higher modulus of rupture and elongation. Re-wetting the compressed wood reverses the process and it swells back to its original thickness.

Heating Dry Wood

Heating wood under drying conditions at higher temperatures (95 to 320 °C (200 to 600 °F)) than those normally used in kiln drying produces a product known as Staybwood that decreases the hygroscopicity and subsequent swelling and shrinking of the wood appreciably. However, the stabilization is always accompanied by loss of mechanical properties. Toughness and resistance to abrasion are most seriously affected.

Under conditions that cause a reduction of 40% in shrinking and swelling, the toughness is decreased to less than half that of the original wood. Extensive research to minimize this loss was not successful. Because of the reduction in strength properties from heating at such high temperatures, wood that is dimensionally stabilized in this manner was never commercialized.

One commercial process produces dry-heated wood products. Retification is a process developed in France by École des Mines de St. Etienne and involves heating wood in a nitrogen atmosphere to 180 to 250 °C for several hours.

Heating Dry Wood Followed by Compression

To meet the demand for a tougher compressed product than compreg, a compressed wood containing no resin (staypak) was developed. A temperature range of 150 to 170 °C is used, and the wood is compressed while heated. It does not lose its compression under swelling conditions as does untreated compressed wood. In making staypak, the compressing conditions are modified so that the lignin-cementing material between the cellulose fibers flows sufficiently to eliminate internal stresses.

Staypak is not as water resistant as compreg, but it is about twice as tough and has higher tensile and flexural strength properties (Tables 19–1 and 19–2). The natural finish of staypak is almost equal to that of compreg. Under weathering conditions, however, it is definitely inferior to compreg. For outdoor use, a good synthetic resin varnish or paint finish should be applied to staypak.

Staypak can be used in the same way as compreg where extremely high water resistance is not needed. It shows promise in tool handles, forming dies, connector plates, propellers, and picker sticks and shuttles for weaving, where high impact strength is needed. Staypak is not impregnated; therefore, it can be made from solid wood as well as from veneer. The cost of staypak is less than that of compreg.

A material similar to staypak was produced in Germany prior to World War II. It was a compressed solid wood with much less dimensional stability than staypak and was known as lignostone. Another similar German product was a laminated compressed wood known as lignofol.

Wood Treated with Polyethylene Glycol (PEG)

The dimensional stabilization of wood with polyethylene glycol-1000 (PEG), also known as Carbowax, is accomplished by bulking the fiber to keep the wood in a partially swollen condition. PEG acts in the same manner as does the previously described phenolic resin. It cannot be further cured. The only reason for heating the wood after treatment is to drive off water. PEG remains water soluble in the wood. Above 60% relative humidity, it is a strong humectant and, unless used with care and properly protected, PEG-treated wood can become sticky at high levels of relative humidity. Because of this, PEG-treated wood is usually finished with a polyurethane varnish.

Treatment with PEG is facilitated by using green wood. Here, pressure is not applied because the treatment is based on diffusion. Treating times are such that uniform uptakes of 25% to 30% of chemical are achieved (based on dry weight of wood). The time necessary for this uptake depends on the thickness of the wood and may require weeks. The PEG treatment is being effectively used for cross-sectional wood plaques and other decorative items. Table tops of high quality furniture stay remarkably flat and dimensionally stable when made from PEG-treated wood.

Another application of this chemical is to decrease the checking of green wood during drying. For this application, a high degree of PEG penetration is not required. This method of treatment has been used to decrease checking during drying of small wood blanks or turnings.

Cracking and distortion that old, waterlogged wood undergoes when it is dried can be substantially decreased by treating the wood with PEG. The process was used to dry 200-year-old waterlogged wooden boats raised from Lake George, New York. The “Vasa,” a Swedish ship that sank

Table 19–5. Strength properties of wood–polymer composites^a

Strength property	Unit	Untreated ^b	Treated ^b
Static bending			
Modulus of elasticity	MPa ($\times 10^3$ lb in ⁻²)	9.3 (1,356)	11.6 (1,691)
Fiber stress at proportional limit	MPa (lb in ⁻²)	44.0 (6,387)	79.8 (11,582)
Modulus of rupture	MPa (lb in ⁻²)	73.4 (10,649)	130.6 (18,944)
Work to proportional limit	$\mu\text{J mm}^{-3}$ (in-lb in ⁻³)	11.4 (1.66)	29.1 (4.22)
Work to maximum load	$\mu\text{J mm}^{-3}$ (in-lb in ⁻³)	69.4 (10.06)	122.8 (17.81)
Compression parallel to grain			
Modulus of elasticity	GPa ($\times 10^6$ lb in ⁻²)	7.7 (1,113)	11.4 (1,650)
Fiber stress at proportional limit	MPa (lb in ⁻²)	29.6 (4,295)	52.0 (7,543)
Maximum crushing strength	MPa (lb in ⁻²)	44.8 (6,505)	68.0 (9,864)
Work to proportional limit	$\mu\text{J mm}^{-3}$ (in-lb in ⁻³)	77.8 (11.28)	147.6 (21.41)
Toughness	$\mu\text{J mm}^{-3}$ (in-lb in ⁻³)	288.2 (41.8)	431.6 (62.6)

^aMethyl methacrylate impregnated basswood.

^bMoisture content 7.2%.

on its initial trial voyage in 1628, was also treated after it was raised. There have been many applications of PEG treatment for the restoration of waterlogged wood from archeological sites.

Wood–Polymer Composites

In the modified wood products previously discussed, most of the chemical resides in cell walls; the lumens are essentially empty. If wood is vacuum impregnated with certain liquid vinyl monomers that do not swell wood and are later polymerized *in situ* by gamma radiation or chemical catalyst-heat systems, the resulting polymer resides almost exclusively in the lumens. Methyl methacrylate is a common monomer used for wood–polymer composites. It is converted to polymethyl methacrylate. The hygroscopic characteristics of the wood substance are not altered because little, if any, polymer penetrates the cell walls. However, because of the high polymer content (70% to 100% based on the dry weight of wood), the normally high void volume of wood is greatly decreased. With the elimination of this very important pathway for vapor or liquid water diffusion, the response of the wood substance to changes in relative humidity or water is very slow, and moisture resistance or water-repellent effectiveness (WRE) is greatly improved. Water-repellent effectiveness is measured as follows:

$$\text{WRE} = \frac{S_1}{S_2} \times 100 \quad (19-1)$$

where S_1 is the swelling or moisture uptake of the control specimen during exposure to water for t minutes, and S_2 is the swelling or moisture uptake of the treated specimen during exposure to water also for t minutes.

Wood–polymer composite materials offer desirable aesthetic appearance, high compression strength and abrasion resistance, and increase in hardness and are much stronger than untreated wood (Table 19–5). Commercial application of these products is largely based on increased strength and hardness properties. Improvements in physical properties

of wood–polymer composites are related to polymer loading. This, in turn, depends not only on the permeability of the wood species but also on the particular piece of wood being treated. Sapwood is filled to a much greater extent than heartwood for most species. The most commonly used monomers include styrene, methyl methacrylate, vinyl acetate, and acrylonitrile. Industrial applications include certain sporting equipment, musical instruments, decorative objects, and high-performance flooring.

At present, the main commercial use of wood–polymer composites is hardwood flooring. Comparative tests with conventional wood flooring indicate that wood–polymer materials resisted indentation from rolling, concentrated, and impact loads better than did white oak. This is largely attributed to improved hardness. Abrasion resistance is also increased. A finish is usually used on these products to increase hardness and wear resistance even more. Wood–polymer composites are also being used for sporting goods, musical instruments, and novelty items.

In addition to the use of vinyl monomers for wood–polymer composites, polysaccharides from renewable resources are also used. Examples include the use of furfuryl alcohol from primarily corn cobs and the use of modified polysaccharides primarily from soy and corn starch. The process (Indurite) involves the impregnation of wood with a water-soluble polysaccharide solution made from soy and corn starch, followed by a curing step at 70 °C. The treatment improves the dimensional stability and hardness of wood and is used in production of flooring materials.

Modification of wood with furfuryl alcohol is called furfurylation. Stamm started research on furfurylation at the Forest Products Laboratory in the 1950s. The process was industrialized in the mid-1960s in the United States, and furfurylated wood products included knife handles, bench tops, and rotor blades, but production ceased by the 1970s. Interest renewed in the late 1980s, and now products are marketed in the United States and Europe. Furfurylation

involves a full cell impregnation step of the treatment solution, an intermediate drying step, a reaction curing step, and a final kiln-drying step. Products are available for decking, marine application, cladding, window joinery, poles, roofs, garden furniture, building materials, and flooring. Impact strength is strongly decreased (from –25% at 15% WPG to –65% at 125% WPG). Stiffness increases from 30% to 80%. The ASE ranges from 30% to 80%. Fungal durability and insect resistance are high at high weight gains.

Chemical Modification

Through chemical reactions, it is possible to add an organic chemical to the hydroxyl groups on wood cell wall components. This type of treatment bulks the cell wall with a permanently bonded chemical. Many reactive chemicals have been used experimentally to chemically modify wood. For best results, chemicals used should be capable of reacting with wood hydroxyls under neutral or mildly alkaline conditions at temperatures less than 120 °C. The chemical system should be simple and must be capable of swelling the wood structure to facilitate penetration. The complete molecule should react quickly with wood components to yield stable chemical bonds while the treated wood retains the desirable properties of untreated wood. Reaction of wood with chemicals such as anhydrides, epoxides, isocyanates, acid chlorides, carboxylic acids, lactones, alkyl chlorides, and nitriles result in antishrink efficiency (ASE) values (Table 19–4) of 65% to 75% at chemical weight gains of 20% to 30%. Antishrink efficiency is determined as follows:

$$S = \frac{V_2 - V_1}{V_1} \times 100 \quad (19-2)$$

where S is volumetric swelling coefficient, V_2 is wood volume after humidity conditioning or wetting with water, and V_1 is wood volume of oven-dried sample before conditioning or wetting. Then,

$$ASE = \frac{S_2 - S_1}{S_1} \times 100 \quad (19-3)$$

where ASE is reduction in swelling or antishrink efficiency resulting from a treatment, S_2 is treated volumetric swelling coefficient, and S_1 is untreated volumetric swelling coefficient.

Reaction of these chemicals with wood yields a modified wood with increased dimensional stability and improved resistance to termites, decay, and marine organisms.

Mechanical properties of chemically modified wood are essentially unchanged compared with untreated wood.

Modification of wood with acetic anhydride has been researched extensively. The acetylation process involves impregnation of acetic anhydride followed by heat to start the reaction. The last step is to remove the acetic acid by-product and any remaining acetic anhydride. The hydroxyl groups of the cell wall polymers are converted to acetyl

groups, making the wood hydrophobic. As a result, biological durability and dimensional stability increase significantly compared with unmodified wood. Acetylated wood is now commercially available.

The reaction of formaldehyde with wood hydroxyl groups is an interesting variation of chemical modification. At weight gains as low as 2%, formaldehyde-treated wood is not attacked by wood-destroying fungi. An antishrink efficiency (Table 19–4) of 47% is achieved at a weight gain of 3.1%, 55% at 4.1%, 60% at 5.5%, and 90% at 7%. The mechanical properties of formaldehyde-treated wood are all decreased from those of untreated wood. A definite embrittlement is observed, toughness and abrasion resistance are greatly decreased, crushing strength and bending strength are decreased about 20%, and impact bending strength is decreased up to 50%.

Paper-Based Plastic Laminates

Commercially, paper-based plastic laminates are of two types: industrial and decorative. Total annual production is equally divided between the two types. They are made by superimposing layers of paper that have been impregnated with a resinous binder and curing the assembly under heat and pressure.

Industrial Laminates

Industrial laminates are produced to perform specific functions requiring materials with predetermined balances of mechanical, electrical, and chemical properties. The most common use of such laminates is electrical insulation. The paper reinforcements used in the laminates are kraft pulp, alpha pulp, cotton linters, or blends of these. Kraft paper emphasizes mechanical strength and dielectric strength perpendicular to laminations. Alpha paper is used for its electric and electronic properties, machineability, and dimensional stability. Cotton linter paper combines greater strength than alpha paper with excellent moisture resistance.

Phenolic resins are the most suitable resins for impregnating the paper from the standpoint of high water resistance, low swelling and shrinking, and high strength properties (except for impact). Phenolics also cost less than do other resins that give comparable properties. Water-soluble resins of the type used for impreg impart the highest water resistance and compressive strength properties to the product, but they make the product brittle (low impact strength). Alcohol-soluble phenolic resins produce a considerably tougher product, but the resins fail to penetrate the fibers as well as water-soluble resins, thus imparting less water resistance and dimensional stability to the product. In practice, alcohol-soluble phenolic resins are generally used.

Paper-based plastic laminates inherit their final properties from the paper from which they are made. High-strength papers yield higher strength plastic laminates than do low-strength papers. Papers with definite directional properties

result in plastic laminates with definite directional properties unless they are cross laminated (alternate sheets oriented with the machine direction at 90° to each other).

The use of higher strength paper has helped in the development of paper-based laminates suitable for structural use. Pulping under milder conditions and operating the paper machines to give optimum orientation of the fibers in one direction, together with the desired absorbency, contribute markedly to improvements in strength.

Strength and other properties of a paper-plastic laminate are shown in Table 19-2. The National Electrical Manufacturers Association L1-1 specification has additional information on industrial laminates. Paper is considerably less expensive than glass fabric or other woven fabric mats and can be molded at considerably lower pressures; therefore, the paper-based laminates generally have an appreciable price advantage over fabric laminates. However, some fabric laminates give superior electrical properties and higher impact properties. Glass fabric laminates can be molded to greater double curvatures than can paper laminates.

During World War II, a high-strength paper plastic known as papreg was used for molding nonstructural and semistructural airplane parts such as gunner's seats and turrets, ammunition boxes, wing tabs, and the surfaces of cargo aircraft flooring and catwalks. Papreg was used to a limited extent for the skin surface of airplane structural parts, such as wing tips. One major objection to its use for such parts is that it is more brittle than aluminum and requires special fittings. Papreg has been used to some extent for heavy-duty truck floors and industrial processing trays for nonedible materials. Because it can be molded at low pressures and is made from thin paper, papreg is advantageous for use where accurate control of panel thickness is required.

Decorative Laminates

Although made by the same process as industrial laminates, decorative laminates are used for different purposes and bear little outward resemblance to industrial laminate. They are used as facings for doors and walls and tops of counters, flooring, tables, desks, and other furniture.

These decorative laminates are usually composed of a combination of phenolic- and melamine-impregnated sheets of paper. Phenolic-impregnated sheets are brown because of the impregnating resins and make up most of the built-up thickness of the laminate. Phenolic sheets are overlaid with paper impregnated with melamine resin. One sheet of the overlay is usually a relatively thick one of high opacity and has the color or design printed on it. Then, one or more tissue-thin sheets, which become transparent after the resin is cured, are overlaid on the printed sheet to protect it in service. The thin sheets generally contain more melamine resin than do the printed sheets, providing stain and abrasion resistance as well as resistance to cigarette burns, boiling water, and common household solvents.

The resin-impregnated sheets of paper are hot pressed, cured, and then bonded to a wood-based core, usually plywood, hardboard, or particleboard. The thin transparent (when cured) papers impregnated with melamine resin can be used alone as a covering for decorative veneers in furniture to provide a permanent finish. In this use, the impregnated sheet is bonded to the wood surface in hot presses at the same time the resin is cured. The heat and stain resistance and the strength of this kind of film make it a superior finish.

The overall thickness of a laminate may obviously be varied by the number of sheets of kraft-phenolic used in the core assembly. Some years ago, a 2-mm (0.08-in.) thickness was used with little exception because of its high impact strength and resistance to substrate show through. Recently, a 1-mm (0.04-in.) thickness has become popular on vertical surfaces such as walls, cabinet doors, and vertical furniture faces. This results in better economy, and the greater strength of the heavier laminate is not necessary. As applications have proliferated, a series of thicknesses have been offered, from 20 to 60 mm (0.8 to 2.4 in.), even up to 150 mm (6 in.) when self-supportive types are needed. These laminates may have decorative faces on both sides if desired, especially in the heavier thicknesses. Replacement bowling lanes made from high-density fiberboard core and phenolic-melamine, high-pressure laminated paper on the face and back are commercially used.

The phenolic sheets may also contain special postforming-type phenolic resins or extensible papers that make it possible to postform the laminate. By heating to 160 °C (320 °F) for a short time, the structure can readily undergo simple bending to a radius of 10 mm (0.4 in.), and 5 to 6 mm (0.20 to 0.24 in.) with careful control. Rolled furniture edges, decorative moldings, curved counter tops, shower enclosures, and many other applications are served by this technique. Finally, the core composition may be modified to yield a fire-retardant, low-smoking laminate to comply with fire codes. These high-pressure decorative laminates are covered by the National Electrical Manufacturers Association Specification LD-3.

Paper will absorb or give off moisture, depending upon conditions of exposure. This moisture change causes paper to shrink and swell, usually more across the machine direction than along it. In the same manner, the laminated paper plastics shrink and swell, although at a much slower rate. Cross laminating minimizes the amount of this shrinking and swelling. In many furniture uses where laminates are bonded to cores, the changes in dimension as a result of moisture fluctuating with the seasons are different than those of the core material. To balance the construction, a paper plastic with similar properties may be glued to the opposite face of the core to prevent bowing or cupping caused by moisture variation.

Lignin-Filled Laminates

The cost of phenolic resins at one time resulted in considerable effort to find impregnating and bonding agents that were less expensive and yet readily available. Lignin-filled laminates made with lignin recovered from the spent liquor of the soda pulping process were developed as a result of this search. Lignin is precipitated from solution within the pulp or added in a pre-precipitated form before the paper is made. The lignin-filled sheets of paper can be laminated without the addition of other resins, but their water resistance is considerably enhanced when some phenolic resin is applied to the paper in a second operation. The water resistance can also be improved by impregnating only the surface sheet with phenolic resin. It is also possible to introduce lignin, together with phenolic resin, into untreated paper sheets. The lignin-filled laminates are always dark brown or black. They have better toughness than phenolic laminates; in most other strength properties, they are comparable or lower.

Reduction in cost of phenolic resins has virtually eliminated the lignin-filled laminates from U.S. commerce. These laminates have several potential applications, however, where a cheaper laminate with less critical properties than phenolic laminates can be used.

Paper-Face Overlays

Paper has found considerable use as an overlay material for veneer or plywood. Overlays can be classified into three different types according to their use—masking, structural, and decorative. Masking overlays are used to cover minor defects in plywood, such as face checks and patches, minimize grain raising, and provide a more uniform paintable surface, thus making possible the use of lower grade veneer. Paper for this purpose need not be of high strength, because the overlays do not need to add strength to the product. For adequate masking, a single surface sheet with a thickness of 0.5 to 1 mm (0.02 to 0.04 in.) is desirable. Paper impregnated with phenolic resins at 17% to 25% of the weight of the paper gives the best all-around product. Higher resin content makes the product too costly and tends to make the overlay more transparent. Appreciably lower resin content gives a product with low scratch and abrasion resistance, especially when the panels are wet or exposed to high relative humidities.

The paper faces can be applied at the same time that the veneer is assembled into plywood in a hot press. Thermal stresses that might result in checking are not set up if the machine direction of the paper overlays is at right angles to the grain direction of the face plies of the plywood.

The masking-paper-based overlays or vulcanized fiber sheets have been used for such applications as wood house siding that is to be painted. These overlays mask defects in the wood, prevent bleed-through of resins and extractives in the wood, and provide a better substrate for paint. The

paper-based overlays improve the across-the-board stability from changes in dimension as a result of changes in moisture content.

The structural overlay, also known as the high-density overlay, contains no less than 45% thermosetting resins, generally phenolic. It consists of one or more plies of paper similar to that used in the industrial laminates described previously. The resin-impregnated papers can be bonded directly to the surface of a wood substrate during cure of the sheet, thus requiring only a single pressing operation.

The decorative-type overlay is described in the Decorative Laminates section.

References

- Clark, W.M. 1965. Veneering and wood bending in the furniture industry. New York, NY: Pergamon Press.
- Deka, M.; Saikia, C.N. 2000. Chemical modification of wood with thermosetting resin: effect on dimensional stability and strength property. *Bioresource Technology*. 73(2): 179–181.
- Finnish Thermowood Association. 2000. Helsinki, Finland: Wood Focus Oy, P.O. Box 284, Snellmaninkatu 13, FIN-00171. www.thermowood.fi. (December 2000).
- FPL. 1962. Physical and mechanical properties of lignin-filled laminated paper plastic. FPL Rep. 1579. Madison, WI: U.S. Department of Agriculture, Forest Service, Forest Products Laboratory.
- Franich, R. 2007. The Indurite™ Process—a review from concept to business. In: Hill, C.A.S.; Jones, D.; Miltz, H.; Ormondroyd, G.A., eds. *Proceedings, 3rd European conference on wood modification*. Cardiff, UK: 23–29.
- Goldstein, I.S. 1955. The impregnation of wood to impart resistance to alkali and acid. *Forest Products Journal*. 5: 265–267.
- Heebink, B.G. 1959. Fluid-pressure molding of plywood. FPL Rep. 1624. Madison, WI: U.S. Department of Agriculture, Forest Service, Forest Products Laboratory.
- Heebink, B.G. 1963. Importance of balanced construction in plastic-faced wood panels. Res. Note FPL–021. Madison, WI: U.S. Department of Agriculture, Forest Service, Forest Products Laboratory.
- Heebink, B.G.; Haskell, H.H. 1962. Effect of heat and humidity on the properties of high-pressure laminates. *Forest Products Journal*. 12(11): 542–548.
- Hill, C.A.S. 2006. *Wood modification: chemical, thermal and other processes*. Chichester, West Sussex, UK: John Wiley and Sons, Ltd.
- Hoadley, R.B. 1980. *Understanding wood: a craftsman's guide to wood technology*. Newtown, CT: The Taunton Press.

Chapter 19 Specialty Treatments

- Hurst, K. 1962. Plywood bending. *Australian Timber Journal*. (June.)
- Inoue, M.; Norimoto, M.; Tanahashi, M.; Rowell, R.M. 1993. Steam and heat fixation of compressed wood. *Wood and Fiber Science*. 25(3): 224–235.
- Jorgensen, R.N. 1965. Furniture wood bending, part I. *Furniture Design and Manufacturing*. (December.)
- Jorgensen, R.N. 1966. Furniture wood bending, part II. *Furniture Design and Manufacturing*. (January.)
- Langwig, J.E.; Meyer, J.A.; Davidson, R.W. 1968. Influence of polymer impregnation on mechanical properties of bass-wood. *Forest Products Journal*. 18(7): 33–36.
- McKean, H.B.; Blumenstein, R.R.; Finnorn, W.F. 1952. Laminating and steam bending of treated and untreated oak for ship timbers. *Southern Lumberman*. 185: 2321.
- Meyer, J.A. 1965. Treatment of wood-polymer systems using catalyst-heat techniques. *Forest Products Journal*. 15(9): 362–364.
- Meyer, J.A. 1981. Wood-polymer materials: state of the art. *Wood Science*. 14(2): 49–54.
- Meyer, J.A.; Loos, W.E. 1969. Treating Southern Pine wood for modification of properties. *Forest Products Journal*. 19(12): 32–38.
- NEMA. [Current edition]. Standard specification for industrial laminated thermosetting products, Designation L1–1; standard specification for high-pressure decorative laminates, Designation LD–3. Washington, DC: National Electrical Manufacturers Association.
- Peck, E.C. 1957. Bending solid wood to form. *Agric. Handb.* 125. Washington, DC: U.S. Department of Agriculture.
- Perry, T.D. 1951. Curves from flat plywood. *Wood Products*. 56(4).
- Rapp, A.O. 2001. Review on heat treatments of wood. Cost Action E22. Proceedings of special seminar; 2001 February 9; Antibes, France. 66 p.
- Rowell, R.M. 1975. Chemical modification of wood: advantages and disadvantages. Proceedings, American Wood Protection Association (AWPA), formerly American Wood-Preservers' Association. 71: 41–51.
- Rowell, R.M., ed. 1984. The chemistry of solid wood. *Advances in Chemistry Series No. 207*. Washington, DC: American Chemical Society.
- Rowell, R.M., ed. 2005. *Handbook of wood chemistry and wood composites*. Boca Raton, FL: CRC Press. 487 p.
- Rowell, R.M.; Lange, S.; McSweeney, J.; Davis, M. 2002. Modification of wood fiber using steam. In: Proceedings, 6th Pacific Rim bio-based composites symposium. Portland, OR.
- Schneider, M. 1994. Wood polymer composites. *Wood and Fiber Science*. 26(1): 142–151.
- Schneider, M.; Witt, A.E. 2004. History of wood polymer composites commercialization. *Forest Products Journal*. 54(4): 19–24.
- Schuerch, C. 1964. Principles and potential of wood plasticization. *Forest Products Journal*. 14(9): 377–381.
- Seborg, R.M.; Inverarity, R.B. 1962. Preservation of old, waterlogged wood by treatment with polyethylene glycol. *Science*. 136(3516): 649–650.
- Seborg, R.M.; Vallier, A.E. 1954. Application of impreg for patterns and die models. *Forest Products Journal*. 4(5): 305–312.
- Seborg, R.M.; Millett, M.A.; Stamm, A.J. 1945. Heat-stabilized compressed wood (staypak). *Mechanical Engineering*. 67(1): 25–31.
- Seidl, R.J. 1947. Paper and plastic overlays for veneer and plywood. Madison, WI: Forest Products Research Society Proceedings. 1: 23–32.
- Shafizadeh, F.; Chin, P.P.S. 1977. Thermal degradation of wood. In: Goldstein, I.S., ed. *Wood technology: chemical aspects*. ACS Symposium Series 43: 57–81.
- Spielman, F. 1980. Working green wood with PEG. New York, NY: Sterling Publishing Company.
- Stamm, A.J. 1959. Effect of polyethylene glycol on dimensional stability of wood. *Forest Products Journal*. 9(10): 375–381.
- Stamm, A.J. 1964. *Wood and cellulose science*. New York, NY: Ronald Press.
- Stamm, A.J.; Hansen, L.A. 1937. Minimizing wood shrinkage and swelling. Effect of heating in various gasses. *Industrial and Engineering Chemistry*. 29(7): 831–833.
- Stamm, A.J.; Seborg, R.M. 1951. Forest Products Laboratory resin-treated laminated, compressed wood (compreg). FPL Rep. 1381. Madison, WI: U.S. Department of Agriculture, Forest Service, Forest Products Laboratory.
- Stamm, A.J.; Seborg, R.M. 1962. Forest Products Laboratory resin-treated wood (impreg). FPL Rep. 1380 (rev.). Madison, WI: U.S. Department of Agriculture, Forest Service, Forest Products Laboratory.
- Stamm, A.J.; Burr, H.K.; Kline, A.A. 1946. Staybwood. Heat stabilized wood. *Industrial and Engineering Chemistry*. 38(6): 630–634.
- Stevens, W.C.; Turner, N. 1970. *Wood bending handbook*. London, England: Her Majesty's Stationery Office.

Tiemann, H.D. 1915. The effect of different methods of drying on the strength of wood. *Lumber World Review*. 28(7): 19–20.

Weatherwax, R.C.; Stamm, A.J. 1945. Electrical resistivity of resin-treated wood (impreg and compreg), hydrolyzed-wood sheet (hydroxylin), and laminated resin-treated paper (papreg). FPL Rep. 1385. Madison, WI: U.S. Department of Agriculture, Forest Service, Forest Products Laboratory.

Weatherwax, R.C.; Stamm, A.J. 1946. The coefficients of thermal expansion of wood and wood products. *Transactions of American Society of Mechanical Engineering*. 69(44): 421–432.

Welzbacher, C.R.; Rapp, A.O. 2007. Durability of thermally modified timber from industrial-scale processes in different use classes: results from laboratory and field tests. *Wood Material Science and Engineering*. 2: 4–14.

Westin, M.; Lande, S.; Schneider, M. 2003. Furfurylation of wood—process, properties and commercial production. In: Van Acker, J.; Hill, C.A.S., eds. *Proceedings, 1st European conference on wood modification*. Ghent, Belgium: 289–306.

Heat Sterilization of Wood

Xiping Wang, Research Forest Products Technologist

Contents

Heat Treatment Standards	20–1
Factors Affecting Heating Times	20–2
Energy Source	20–2
Heating Medium	20–2
Air Circulation	20–2
Size and Configuration of Wood	20–2
Species	20–2
Stacking Methods	20–2
Heating Times for Wood in Various Forms	20–4
Methods for Estimating Heating Times	20–5
MacLean Equations	20–5
Multiple Regression Models	20–7
American Lumber Standard Committee (ALSC)	
Enforcement Regulations	20–9
Quality Mark	20–11
Other Considerations	20–11
Literature Cited	20–13

Insects and other pests can travel between countries in pallets and other wood packaging materials through international trade. Because these pests can cause significant ecological damage, their invasion into non-native countries is undesirable. Heat sterilization is currently the most practical and environmentally friendly treatment to kill pests in solid wood materials and prevent their transfer between continents and regions. Consequently, regulations requiring heat sterilization are becoming more and more common.

Two important questions should be considered in heat sterilizing solid wood materials: First, what temperature–time regime is required to kill a particular pest? Second, how much time is required to heat the center of any wood configuration to the kill temperature? The entomology research on the first question has facilitated the development of international standards for heat sterilization of various solid wood materials. This chapter primarily addresses the second question. It focuses on various factors that should be considered when planning and implementing a heat treatment process, discusses experimentally derived heating times for commonly used wood products, and presents analytical and empirical methods for estimating heating times that can be used as starting points in the development of heat treatment schedules. Current wood packaging material enforcement regulations and several additional practical considerations for heat treatment operations are also presented.

The preferred units of measure for this chapter are in the in–lb system because of the current high demand for this information in the United States. Metric units or conversion factors are also provided.

Heat Treatment Standards

The current international standard for heat sterilization of solid wood packaging materials is the International Standard for Phytosanitary Measures (ISPM) Pub. No. 15, “Guidelines for Regulating Wood Packaging Material in International Trade,” which requires heating wood to a minimum core temperature of 133 °F (56 °C) for a minimum of 30 min (IPPC 2002, APHIS 2004). These guidelines are for all forms of wood packaging material that may serve as a pathway for plant pests posing a threat mainly to living trees. This temperature–time regime is chosen in consideration of the wide range of pests for which this combination is documented to be lethal and a commercially feasible treatment. Table 20–1 lists the pest groups associated with wood packaging material that can be practically eliminated by heat treatment under ISPM 15 standard. Although some pests are known to have a higher thermal tolerance, quarantine

Table 20–1. Pest groups that are practically eliminated by heat treatment under ISPM 15 standard

Insects
Anobiidae
Bostrichidae
Buprestidae
Cerambycidae
Curculionidae
Isoptera
Lyctidae (with some exceptions for HT)
Oedemeridae
Scolytidae
Siricidae
Nematodes
<i>Bursaphelenchus xylophilus</i>

pests in this category are managed by the National Plant Protection Organizations (NPPOs) on a case-by-case basis (IPPC 2002). Future development may identify other temperature–time regimes required to kill specific insects or fungi.

Factors Affecting Heating Times

From a practical standpoint, the time required for the center of solid wood material to reach the kill temperature depends on many factors, including the type of energy source used to generate the heat, the medium used to transfer the heat (for example, wet or dry heat), the effectiveness of the air circulation in the heating facility, the species and physical properties (configurations, specific gravity, moisture content, initial wood temperature) of the wood and wood products being sterilized, and the stacking methods used in the heat treatment process.

Energy Source

Energy is the amount of heat supplied during the heat treatment process. Heat-treating chambers typically employ systems that utilize steam, hot air (direct fire), electricity, and hot water or hot oil as mechanisms to generate the heat necessary to sterilize the wood. The choice of heat energy primarily depends on the heat treatment method, energy resources available, and the cost of the energy.

Heating Medium

The temperature and humidity of the heating medium significantly affect heating times. Higher heating temperatures obviously yield shorter heating times, and heating wood in saturated steam (wet heat) results in the shortest heating times. When the heating medium is air that is not saturated with steam, the relative humidity is less than 100% (wet-bulb depression > 0 °F), and drying occurs as water evaporates from the wood surface. As the heating medium changes from wet to dry heat, the time needed to reach the required temperature increases. This is illustrated in Figure 20–1, which shows experimentally derived heating times as a function of wet-bulb depression for a series of lumber and timber products.

When the wet-bulb temperature in the heating medium approaches or falls below the target center temperature, heating time becomes much longer than with wet heat (Simpson 2002, Simpson and others 2003) because evaporation of water from the wood surface with dry heat cools the surface and lowers its temperature, reducing the surface-to-center temperature gradient that is the driving force for transferring heat. With wet heat there is little or no evaporation of moisture and thus little surface cooling to slow heat transfer.

Air Circulation

Maintaining adequate air circulation is also important in heat sterilization. The circulating air performs two functions, as it does in kiln drying: it carries heat to the wood to effect evaporation, and it removes the evaporated water vapor. Good air circulation ensures uniform heat distribution in the chamber and keeps the wood surface temperature high so that the surface-to-center temperature gradient is as high as possible. This is usually accomplished with fans and baffles in a treatment chamber.

Size and Configuration of Wood

The heat treatment process is affected by wood configuration and size, as would be expected. Heating time increases with size and at a rate that is more than proportional to the configuration. For example, heating time can range from only a few minutes for thin boards to many hours for large timbers. The effect of wood configuration on heating time can be seen in Figure 20–1 for a series of web-bulb depressions.

Species

Studies of five hardwood species (red maple, sugar maple, red oak, basswood, and aspen) at the USDA Forest Service Forest Products Laboratory (FPL) have indicated that the actual effect of species was not large (Simpson and others 2005). In fact, the differences in heating times of different species are of a similar magnitude to the expected natural variability between individual boards and square timbers. In heat treatment operation, there is no practical reason to heat-treat different hardwood species separately. Figure 20–2 illustrates the effects of species on heating times of boards and square timbers for five hardwood species.

No data are currently available to directly assess the effect of species in heat-treating softwood products. However, there are practical reasons to separate species in drying softwood lumber, and heat treatment for softwood products is often accomplished as part of the wood drying process. Detailed information on heating times for softwood products is presented in the sections of stacking methods, heating times for wood in various forms, and methods for estimating heating times.

Stacking Methods

Proper stacking of lumber or timbers is an essential aspect of the heat treatment process because it directly affects heat

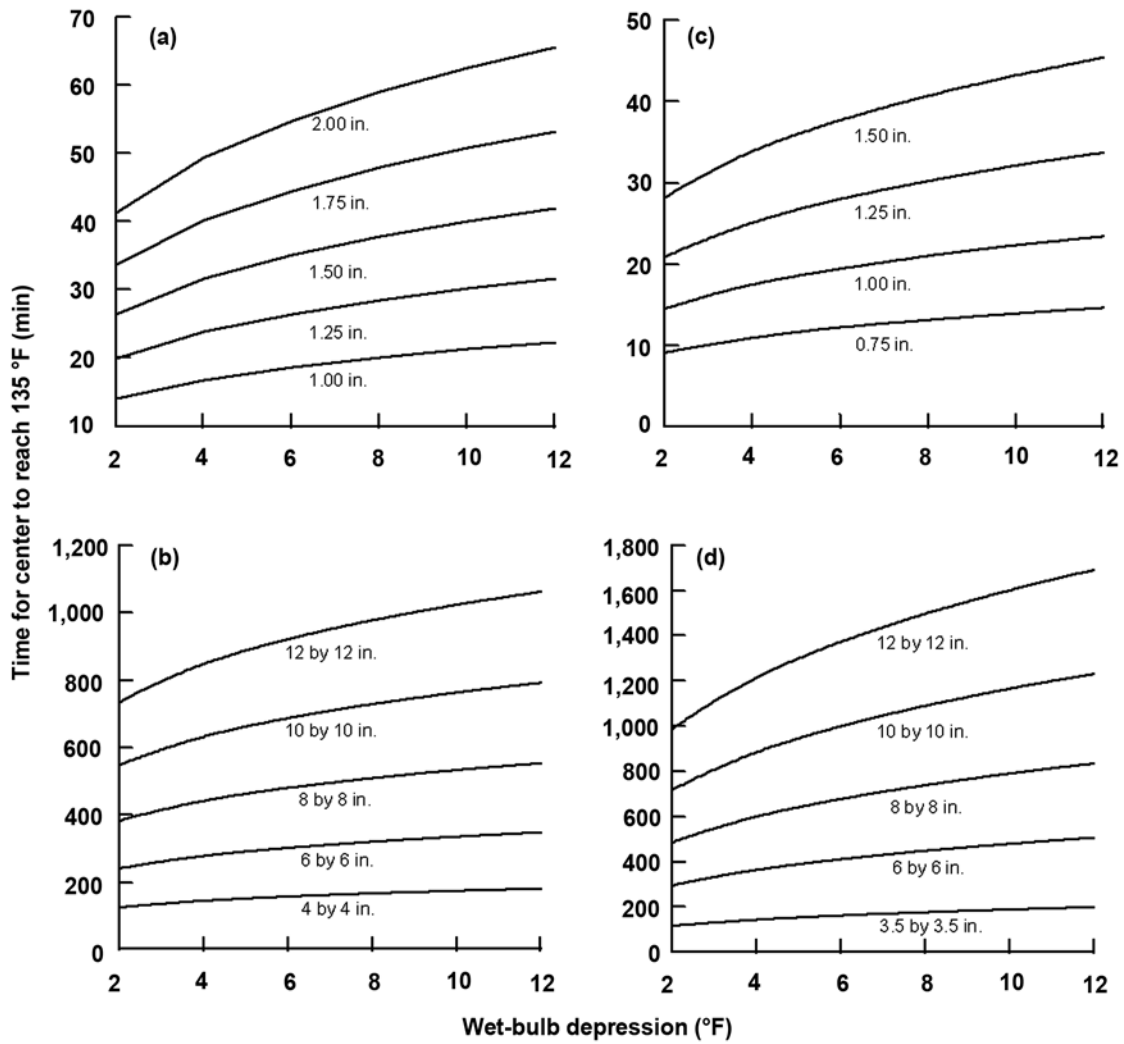

Figure 20–1. Dependence of heating time on wet-bulb depression for (a) 1- to 2-in.-thick ponderosa pine boards; (b) 4- to 12-in. ponderosa pine timbers; (c) 3/4- to 1-1/2-in.-thick Douglas-fir boards; and (d) 3-1/2- by 3-1/2-in. Douglas-fir timbers (initial temperature: 60 °F). ($^{\circ}\text{C} = (^{\circ}\text{F} - 32)/1.8$; 1 in. = 25.4 mm)

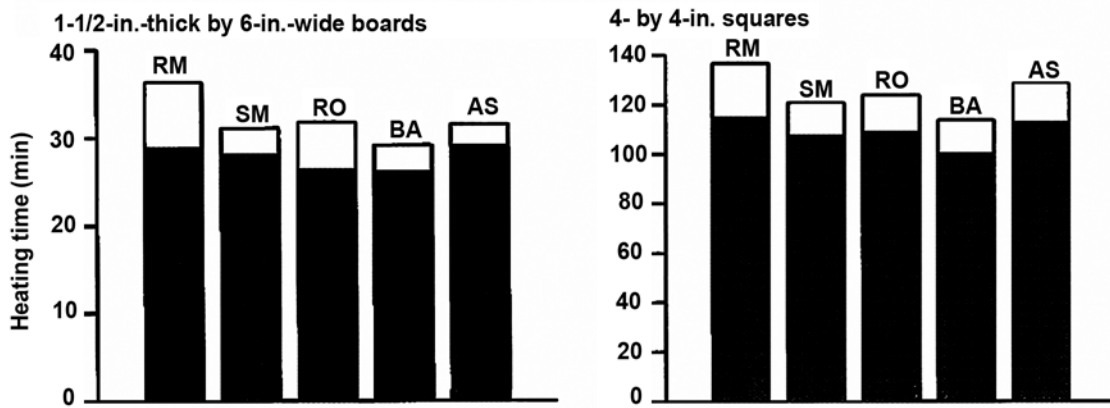

Figure 20–2. Effect of species on heating times of boards and squares. RM, red maple; SM, sugar maple; RO, red oak; BA, basswood; AS, aspen. The solid rectangle represents 2 °F (1.1 °C) wet-bulb depression. The entire rectangle represents 10 °F (5.6 °C) wet-bulb depression.

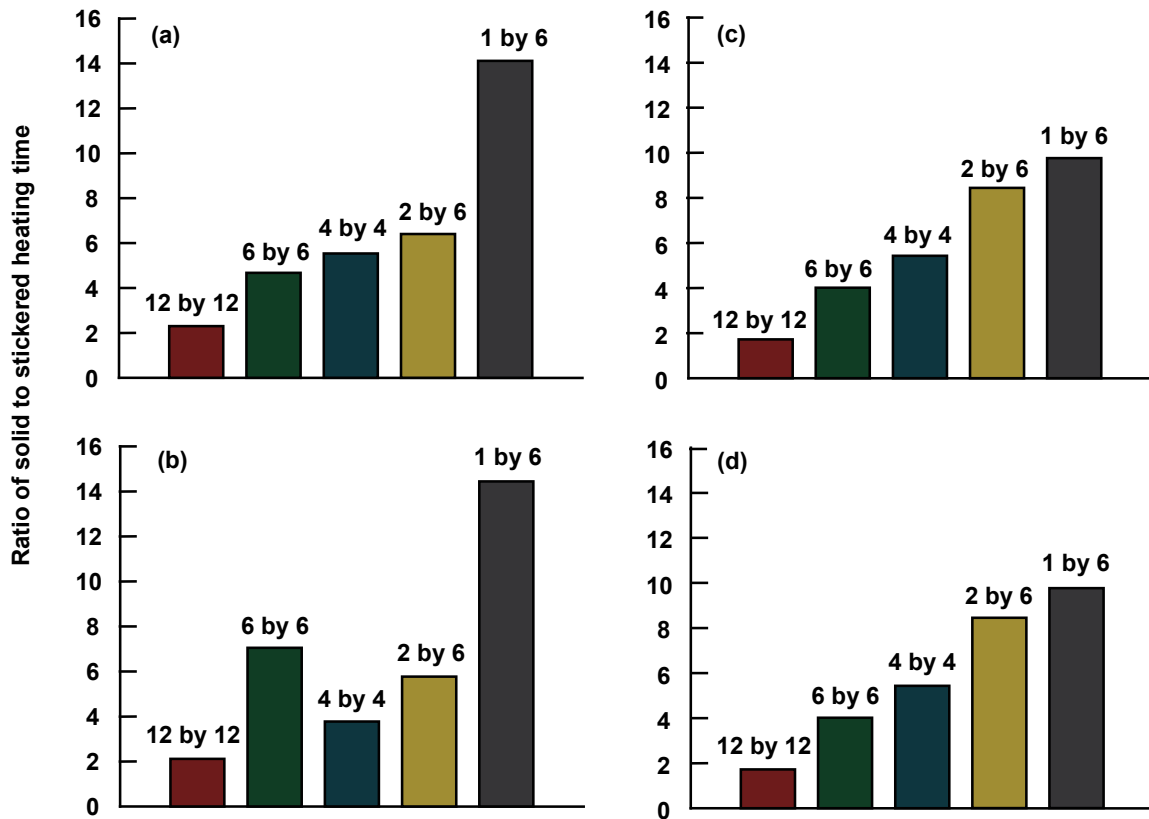

Figure 20–3. Ratio of heating times of solid-piled boards and timbers (4 by 3.2 ft) to stickered boards and timbers for (a) Douglas-fir, 1.5 °F/2.2 °F (0.8 °C/1.2 °C) wet-bulb depression; (b) Douglas-fir, 12.5 °F/13.8 °F (7.0 °C/7.7 °C) wet-bulb depression; (c) ponderosa pine, 2.5 °F/2.8 °F (1.4 °C/1.6 °C) wet-bulb depression; and (d) ponderosa pine, 12.0 °F/13.4 °F (6.7 °C/7.5 °C) wet-bulb depression.

transfer and, consequently, heating times. If a heat treatment facility receives solid-piled bundles of lumber or timbers, it may be desirable to heat-treat in the solid-piled configuration. However, a solid bundle of lumber or timbers requires much longer heating times than a comparable quantity of stickered lumber or timbers. Figure 20–3, for example, shows the ratio of heating times for equal quantities of lumber or timbers, one being heat treated as a solid bundle (4 by 3.2 ft) and the other treated after stickering. Note that the ratio ranges from about 2 for 12- by 12-in. timbers to more than 14 for 1- by 6-in. boards, which indicates that heat-treating stickered materials can result in substantial decreases in heating times. In addition, a higher degree of variation in heating times for solid-piled materials than for stickered materials results from how closely the individual pieces fit together in a stacking bundle (Simpson and others 2003). Gaps between individual pieces allow hot air to penetrate and thus warm the surface more than where adjacent pieces fit tightly together. In commercial practice, this high variability would cause complications in estimating heating times.

Heating Times for Wood in Various Forms

A series of heating experiments were conducted at the FPL (Simpson 2001, 2002; Simpson and others 2003, 2005). Tables 20–2 and 20–3 summarize experimental heating times for ponderosa pine and Douglas-fir boards and square timbers to a center temperature of 133 °F (56 °C) in a heating environment of 160 °F (71 °C) dry-bulb temperature and various wet-bulb depressions. Table 20–4 summarizes average heating times required to reach 133 °F (56 °C) for six sizes of five hardwood species (red maple, sugar maple, red oak, basswood, and aspen) at two wet-bulb depressions (0 and 10 °F (0 and 5.6 °C)). Note that heating times in these tables are for wood in green condition and that these data were obtained through laboratory experiments in a small-scale dry kiln (approximately 1,500 board foot (3.5 m³) capacity) under well-controlled heating conditions. Although the experimental results have not been calibrated to commercial operation, they have served as the bases for developing heat treatment schedules for industrial applications (ALSC 2009).

Table 20–2. Summary of experimental heating times to heat ponderosa pine boards and square timbers to a center temperature of 133 °F (56 °C) in a heating environment of nominal 160 °F (71 °C) dry-bulb temperature and various wet-bulb depressions

Wet-bulb depression (°F (°C))	Experimental heating times (min) ^a				
	1 by 6 ^b	2 by 6	4 by 4	6 by 6	12 by 12
Stickered					
2.5 (1.4)	17 (8.1)	43 (13.1)	153 (8.9)	299 (17.7)	1,006 (15.5)
6.2 (3.4)	16 (5.9)	53 (2.4)	180 (6.0)	271 (6.2)	980 (12.1)
12.0 (6.6)	23 (3.1)	67 (15.0)	207 (17.3)	420 (28.3)	1,428 (8.2)
26.8 (14.9)	188 (45.2)	137 (12.5)	256 (19.0)	568 (7.2)	1,680 (13.9)
47.5 (26.4)	427 (18.1)	361 (30.7)	817 (53.9)	953 (38.1)	2,551 (22.2)
Solid-piled^c					
2.8 (1.6)	166 (70.3)	361 (64.9)	831 (14.0)	1,201 (30.1)	1,736 (26.4)
13.4 (7.4)	201 (22.7)	391 (23.4)	710 (48.1)	1,617 (26.7)	2,889 (22.4)

^aValues in parentheses are coefficients of variation (%).

^bActual sizes are the same as nominal sizes.

^cSolid pile 4 ft wide and 3.2 ft high.

Table 20–3. Summary of experimental heating times to heat Douglas-fir boards and square timbers to a center temperature of 133 °F (56 °C) in a heating environment of nominal 160 °F (71 °C) dry-bulb temperature and various wet-bulb depressions

Wet-bulb depression (°F (°C))	Experimental heating times (min) ^a				
	1 by 6 ^b	2 by 6	4 by 4	6 by 6	12 by 12
Stickered					
2.2 (1.2)	7 (22.2 ^c)	21 (21.3)	78 (12.5)	209 (8.9)	840 (8.8)
6.3 (3.5)	8 (10.3)	25 (21.9)	91 (10.5)	202 (11.6)	914 (13.9)
12.5 (6.9)	10 (6.7)	34 (22.3)	138 (17.8)	262 (7.7)	1,153 (7.0)
27.1 (15.0)	216 (39.9)	157 (23.1)	255 (25.1)	715 (22.8)	1,679 (3.1)
44.2 (24.6)	233 (62.8)	223 (20.3)	362 (28.0)	849 (6.1)	2,005 (23.3)
Solid-piled^c					
1.5 (0.8)	103 (45.2)	137 (46.9)	432 (27.2)	977 (9.3)	1,931 (13.5)
13.8 (7.7)	143 (69.1)	195 (77.4)	521 (54.7)	1,847 (25.7)	1,847 (25.7)

^aValues in parentheses are coefficients of variation (%).

^bNominal sizes.

^cSolid pile 4 ft wide and 3.2 ft high.

Methods for Estimating Heating Times

Many combinations of wood configurations, heating temperatures, wet-bulb depressions, and initial wood temperatures are possible. No one experiment of practical scope would cover them all. Therefore, analytical methods are needed to estimate the heating times for combinations not directly measured experimentally.

MacLean Equations

MacLean (1930, 1932, 1941) developed equations for estimating heating times in steam and showed experimentally that they worked well. The equations are for two-dimensional heat flow (heating is from all four cross-sectional faces) and apply only to heating in a saturated steam environment.

Heat conduction is considered to be about 2.5 times faster in the longitudinal grain direction than across the grain. However, because the length of many typical timbers and rounds is much greater than the cross-sectional dimension, longitudinal conduction is ignored and the equations thus simplified.

Round Cross Section

The heat conduction equations for round cross sections are taken from MacLean (1930), further refined by Ingersoll and Zobel (1948). The temperature T at any point on radius r is given by

$$T = T_s + 2(T_0 - T_s) \sum_{n=1}^{\infty} \frac{J_0(z_n r/R)}{z_n J_1(z_n)} \exp(-\alpha z_n^2 / R^2) \quad (20-1)$$

Table 20-4. Summary of experimental heating times to 133 °F (56 °C) for six sizes of five hardwood species heated at a nominal dry-bulb temperature of 160 °F (71 °C) and two wet-bulb depressions^a

Wet-bulb depression (°F (°C))	Piece size (in.) ^c	Heating time (min) ^b				
		Red maple	Sugar maple	Red oak	Basswood	Aspen
0 (0)	1 by 6	14 (15)	13 (14)	14 (15)	12 (14)	13 (14)
	1-1/2 by 6	29 (31)	28 (30)	26 (28)	26 (28)	29 (32)
	2 by 6	50 (52)	48 (49)	49 (53)	46 (48)	50 (54)
	3 by 3	59 (64)	58 (61)	57 (60)	51 (58)	61 (64)
	4 by 4	115 (119)	107 (113)	109 (112)	100 (108)	113 (117)
	6 by 6	265 (283)	255 (277)	252 (259)	226 (243)	262 (278)
10 (5.6)	1 by 6	17 (18)	14 (15)	15 (16)	15 (17)	15 (16)
	1-1/2 by 6	36 (38)	31 (34)	32 (33)	29 (31)	32 (33)
	2 by 6	59 (62)	53 (56)	56 (59)	54 (58)	57 (62)
	3 by 3	85 (96)	63 (67)	66 (69)	63 (69)	69 (74)
	4 by 4	137 (143)	121 (127)	124 (129)	114 (120)	129 (133)
	6 by 6	294 (304)	284 (299)	284 (298)	262 (284)	285 (195)

^aHeating times were adjusted to a common initial temperature of 60 °F (16 °C) and the overall actual average heating temperature of 157 °F (69 °C).

^bValues in parentheses are 99% upper confidence bounds of heating times.

^cActual sizes.

where

T_s is surface temperature (which must be attained immediately),

T_0 initial temperature,

J_0 zero-order Bessel function,

J_1 first-order Bessel function,

z_n n th root of $J_0(z_n) = 0$,

r any point on radius of cross section,

R radius of cross section,

α thermal diffusivity (dimension²/time), and

t heating time.

$$z_2 = 5.520$$

$$z_3 = 8.654$$

$$z_4 = 11.792$$

$$z_5 = 14.931$$

and the first five values of $J_1(z_n)$ are

$$J_1(2.405) = 0.5191$$

$$J_1(5.520) = -0.3403$$

$$J_1(8.654) = 0.2714$$

$$J_1(11.792) = -0.2325$$

$$J_1(14.931) = 0.2065$$

To calculate the temperature at the center of the cross section, $r = 0$, Equation (20-1) becomes

$$T_c = T_s + 2(T_0 - T_s) \sum_{n=1}^{\infty} \frac{\exp(-\alpha t z_n^2 / R^2)}{z_n J_1(z_n)} \quad (20-2)$$

Equations (20-1) and (20-2) converge quickly, so only the first few terms are necessary. The first few terms of Equation (20-2) are

$$T_c = T_s + 2(T_0 - T_s) \left[\frac{\exp(-\alpha t z_1^2 / R^2)}{z_1 J_1(z_1)} + \frac{\exp(-\alpha t z_2^2 / R^2)}{z_2 J_1(z_2)} + \frac{\exp(-\alpha t z_3^2 / R^2)}{z_3 J_1(z_3)} + \dots \right] \quad (20-3)$$

From Watson (1958), the first five roots of $J_0(z_n) = 0$ are

$$z_1 = 2.405$$

Rectangular Cross Section

The equation for rectangular cross sections is taken from MacLean (1932) and is the solution to the differential equation of heat conduction in the two dimensions of a rectangular cross section. The temperature T at any point x and y is given by

$$T = T_s + (T_0 - T_s) (16/\pi^2) \times \{ \sin(\pi x/a) \sin(\pi y/b) \exp[-\pi^2 t (\alpha_x/a^2 + \alpha_y/b^2)] + (1/3) \sin(3\pi x/a) \sin(\pi y/b) \exp[-\pi^2 t (9\alpha_x/a^2 + \alpha_y/b^2)] + (1/3) \sin(\pi x/a) \sin(3\pi y/b) \exp[-\pi^2 t (\alpha_x/a^2 + 9\alpha_y/b^2)] + (1/5) \sin(5\pi x/a) \sin(\pi y/b) \exp[-\pi^2 t (25\alpha_x/a^2 + \alpha_y/b^2)] + (1/5) \sin(\pi x/a) \sin(5\pi y/b) \exp[-\pi^2 t (\alpha_x/a^2 + 25\alpha_y/b^2)] + (1/7) \sin(7\pi x/a) \sin(\pi y/b) \exp[-\pi^2 t (49\alpha_x/a^2 + \alpha_y/b^2)] + (1/7) \sin(\pi x/a) \sin(7\pi y/b) \exp[-\pi^2 t (\alpha_x/a^2 + 49\alpha_y/b^2)] + \dots \} \quad (20-4)$$

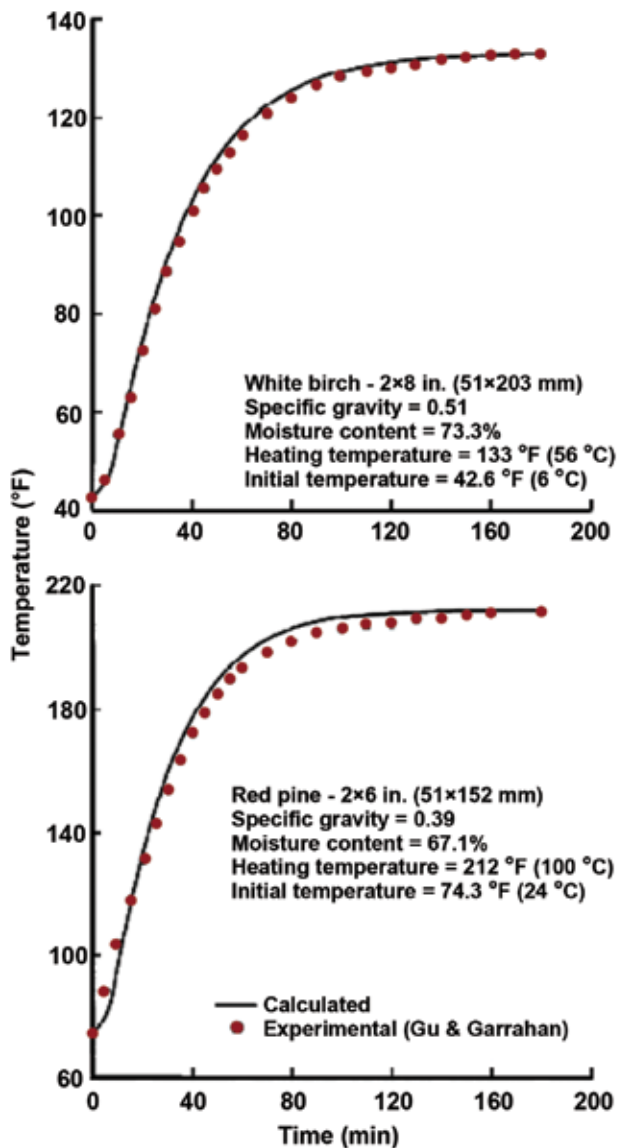

Figure 20–4. Comparison of experimental heating times of Gu and Garrahan (1984) with times calculated using MacLean equations for white birch and red pine.

where

- T_s is surface temperature (which must be attained immediately),
 T_0 initial temperature,
 a one cross-sectional dimension,
 b other cross-sectional dimension,
 α_x thermal diffusivity in the x direction (dimension²/time),
 α_y thermal diffusivity in the y direction, and
 t heating time.

Equation (20–4) converges quickly, so only the first few terms are necessary. Because thermal conductivity and thermal diffusivity do not differ much in the radial and tangen-

tial directions of wood, in Equation (20–4) we can set $\alpha_x = \alpha_y$ (MacLean 1941). Equation (20–4) can easily be converted to calculate the temperature at the center of the cross section by setting $x = a/2$ and $y = b/2$.

Gu and Garrahan (1984) experimentally confirmed that MacLean's equations were valid for estimating heating times. Figure 20–4 shows close agreement of experimental heating times of Gu and Garrahan (1984) with times calculated using MacLean's heat conduction equation. Simpson (2001) further confirmed the validity of MacLean's equations and used them to develop a series of tables of heating times (to the center) of round and rectangular sections. Variables in the tables were wood specific gravity, moisture content, initial temperature, heating temperature, and target center temperature.

Specific gravity and moisture content values were chosen to represent several species that might be subjected to heat sterilization. Target center temperatures other than 133 °F (56 °C) were included because future heat sterilization requirements are not known and might include higher temperatures. As an example, Table 20–5 tabulates the estimated heating times to heat lumber of selected sizes to 133 °F (56 °C) for wood specific gravity of 0.35 (Cheung 2008). Tables for other combinations of variables are presented in Simpson (2001).

Heat experiments at the Forest Products Laboratory indicated that MacLean's equations are able to estimate heating times in steam to a degree of accuracy that is within about 5% to 15% of measured heating times. The equations offer a powerful way to include the effects of all the variables that affect heating time—specific gravity, moisture content, initial temperature, heating temperature, target center temperature, and cross-sectional dimensions.

MacLean's approach requires full access of all four faces to the heating medium. This might not be achieved in the close edge-to-edge contact of the stickered configuration or the solid-piled configuration. In practice, his approach will probably require some small level of gapping between adjacent boards or timbers.

Multiple Regression Models

MacLean's equations apply only to heating in a saturated steam environment. When the heating medium is air that is not saturated with steam, there is a wet-bulb depression (the relative humidity is less than 100%), and drying occurs as water evaporates from the wood surface. The consequence is that heating time increases and MacLean's equations no longer apply. An alternative method to estimate the heating time when simultaneous drying occurs is to use a strictly empirical approach.

The following multiple regression model proved to have a good ability to predict heating time from size, wet-bulb depression, and initial wood temperature as long as the

Table 20-5. Estimated heating times to heat lumber to 133 °F (56 °C) for wood with a specific gravity of 0.35

Thickness (t) and width (w) (in.)	Heat temp. (°F)	Estimated heating time (min) from four initial wood temperatures and four MC levels															
		30 °F				50 °F				70 °F				90 °F			
		25%	70%	100%	130%	25%	70%	100%	130%	25%	70%	100%	130%	25%	70%	100%	130%
t = 1.0 w = 4.0	140	21	21	20	19	19	19	18	17	17	17	16	15	15	14	13	12
	150	15	15	14	13	14	13	13	12	12	11	11	10	10	9	9	8
	160	13	12	12	11	11	11	10	9	10	9	9	8	8	7	7	6
	170	11	10	10	9	10	9	8	8	8	7	7	7	6	6	6	5
	180	9	9	9	8	8	8	7	7	7	6	6	6	6	5	5	4
	190	9	8	8	7	7	7	7	6	6	6	5	5	5	4	4	4
	200	8	7	7	6	7	6	6	5	6	5	5	4	5	4	4	3
210	7	7	6	6	6	6	5	5	5	5	4	4	4	4	3	3	
t = 1.0 w = 6.0	140	21	21	20	19	19	19	18	17	17	17	16	15	15	14	13	12
	150	15	15	14	13	14	13	13	12	12	11	11	10	10	9	9	8
	160	13	12	12	11	11	11	10	9	10	9	9	8	8	7	7	6
	170	11	10	10	9	10	9	8	8	8	7	7	7	6	6	6	5
	180	9	9	9	8	8	8	7	7	7	6	6	6	6	5	5	4
	190	9	8	8	7	7	7	7	6	6	6	5	5	5	4	4	4
	200	8	7	7	6	7	6	6	5	6	5	5	4	5	4	4	3
210	7	7	6	6	6	6	5	5	5	5	4	4	4	4	3	3	
t = 2.0 w = 4.0	140	75	74	70	66	69	67	64	59	62	59	56	53	54	50	48	45
	150	56	55	52	49	51	49	46	43	45	42	40	38	38	35	33	31
	160	46	45	43	40	42	40	38	35	37	34	33	30	30	28	26	25
	170	41	39	37	35	36	34	33	30	32	29	28	26	26	24	22	21
	180	36	35	33	31	32	30	29	27	28	26	24	23	23	21	20	18
	190	33	31	30	28	29	27	26	24	25	23	22	20	21	18	17	16
	200	30	28	27	25	27	25	24	22	23	21	20	19	19	17	16	15
210	28	26	25	23	25	23	22	20	22	19	18	17	18	15	15	14	
t = 2.0 w = 8.0	140	86	85	81	76	79	77	73	68	71	67	64	60	61	57	54	50
	150	63	62	59	55	57	55	52	49	50	47	45	42	41	38	36	34
	160	52	50	48	45	46	44	42	39	40	37	35	33	32	30	28	26
	170	44	43	41	38	39	37	35	33	34	31	30	28	27	25	24	22
	180	39	37	36	33	35	32	31	29	30	27	26	24	24	21	20	19
	190	35	33	32	30	31	29	27	26	27	24	23	21	21	19	18	17
	200	32	30	29	27	29	26	25	23	24	22	21	19	19	17	16	15
210	30	28	26	24	26	24	23	21	22	20	19	18	18	16	15	14	
t = 4.0 w = 4.0	140	188	186	177	166	173	168	160	150	157	149	142	132	136	127	120	112
	150	141	138	131	123	128	123	117	110	114	107	102	95	96	89	85	79
	160	118	114	109	102	107	102	97	90	94	88	83	78	79	72	69	64
	170	103	99	94	88	93	88	83	78	82	76	72	67	68	62	59	55
	180	93	88	84	78	84	78	74	69	73	67	64	59	61	55	52	49
	190	85	80	76	71	76	71	67	63	67	61	58	54	56	50	47	44
	200	79	74	70	65	71	65	62	57	62	56	53	49	52	46	43	40
210	74	68	65	60	66	60	57	53	58	52	49	46	48	43	40	37	
t = 4.0 w = 12.0	140	335	332	316	296	309	300	286	267	278	265	252	235	239	224	213	198
	150	248	243	232	217	225	216	206	192	198	187	178	166	165	153	145	135
	160	205	199	190	177	184	175	167	156	160	150	142	133	131	120	114	106
	170	177	171	162	152	158	149	142	133	136	126	120	112	111	101	95	89
	180	158	150	143	133	140	131	124	116	120	110	105	98	97	87	83	77
	190	143	135	128	119	126	117	111	104	108	98	93	87	87	78	74	69
	200	131	122	116	108	115	106	101	94	98	89	84	78	79	70	67	62
210	121	112	106	99	107	97	92	86	91	81	77	72	73	64	61	57	

Table 20–6. Coefficients for multiple regression models (Eq. (20–5)) for estimating time required to heat stickered ponderosa pine and Douglas-fir boards and timbers to a 133 °F (56 °C) center temperature in a 160 °F (71 °C) heating medium^a

Application	Coefficients				
	$\ln a$	b	c	d	R^2
Ponderosa pine, 1- and 2-in. boards, WBD < 12 °F	5.04	1.55	0.257	0.627	0.978
Ponderosa pine, 4-, 6-, and 12-in. timbers, WBD < 12 °F	4.59	1.61	0.205	-0.521	0.967
Douglas-fir, 1- and 2-in. boards, WBD < 12 °F	8.04	1.63	0.265	-1.35	0.925
Douglas-fir, 4-, 6-, and 12-in. timbers, WBD < 12 °F	15.03	0.455	0.336	-2.70	0.984

^a $T_c = (T_F - 32)/1.8$; °C = °F/1.8; 1 in. = 25.4 mm.

wet-bulb temperature in the heating chamber is greater than the target center temperature:

$$\ln T_{133} = \ln a + b (\ln t)^n + c \ln (\text{WBD}) + d \ln (T_i) \quad (20-5)$$

where

T_{133}	is	time for the center to reach 133 °F (56 °C) (min),
t		thickness of boards or cross-sectional dimension of timbers (in.),
WBD		wet-bulb depression (°F),
T_i		initial wood temperature (°F),
a, b, c, d		regression coefficients,
n		either 1 or 2.

Simpson and others (2003) developed a series of regression models to estimate heating times for ponderosa pine and Douglas-fir boards and timbers. The regression coefficients (a , b , c , and d) and coefficients of determination (R^2) are shown in Table 20–6. The models worked well when the wet-bulb depression was less than or equal to about 12 °F (6.7 °C) and the boards or timbers were stickered. The heating time estimates for a series of sizes, wet-bulb depressions, and initial temperature generated using these equations are presented in Tables 20–7 to 20–10. The estimates for ponderosa pine cover initial temperatures from 40 to 80 °F (4.4 to 26.7 °C) (in 10 °F (5.6 °C) increments). The estimates for Douglas-fir cover only initial temperature of 60 to 80 °F (15.6 to 26.7 °C) because of the seasonal timing of the experiments.

The estimated heating times in Tables 20–7 to 20–10 are average times and give a reasonable general estimate of the time required to heat the center of wood to 133 °F (56 °C). In any group of lumber and timbers, the average time does not ensure that all pieces will achieve the target temperature because some will require more than the average time. Therefore, the upper statistical confidence levels for the heating times need to be considered. Equations for calculating the upper confidence levels of heating times for ponderosa pine and Douglas-fir boards and timbers are provided

in Simpson and others (2003). In Tables 20–7 to 20–10, the heating time values of 99% upper confidence bounds are presented in parentheses.

American Lumber Standard Committee (ALSC) Enforcement Regulations

Heat treatment of wood is typically accomplished in a heat chamber. Heat chamber is defined as any enclosed equipment used to heat-treat lumber or wood packaging material and includes kiln, heat boxes, or any other appropriate apparatus. Depending on the treating schedules used, products from heat treatment processes are of two types:

1. Heat treated (HT)—lumber or used, previously assembled or repaired wood packaging that has been placed in a closed chamber with artificial heat added until the lumber or packaging achieves a minimum core temperature of 133 °F (56 °C) for a minimum of 30 min.
2. Kiln-dried heat-treated (KD HT)—lumber or used, previously assembled or repaired wood packaging that has been placed in a closed chamber with artificial heat added until the lumber or packaging achieves a minimum core temperature of 133 °F (56 °C) for a minimum of 30 min and that is dried to a maximum moisture content of 19% or less.

ALSC enforcement regulations require that a heat treatment facility should be inspected and verified by an accredited third-party agency for initial qualification. Agencies will verify the accuracy of temperature-measuring and recording devices in the heating chamber and require that thermocouples be located to accurately measure the temperature achieved in the heat chamber and that an appropriate number of thermocouples are utilized given the chamber configuration. A thermocouple verification study is needed for any kiln schedule operating in a heat chamber using (1) both dry and wet heat (steam) with wet-bulb temperature of less than 140 °F (60 °C) or (2) only dry heat of less than 160 °F (71 °C). In such a verification study, an appropriate number

Table 20–7. Summary of heating times (at 160 °F (71 °C)) to 133 °F (56 °C) for ponderosa pine boards estimated by multiple regression models^a

Wet-bulb depression (°F)	Initial temperature (°F)	Heating time (min) ^b				
		1.00 in. thick	1.25 in. thick	1.50 in. thick	1.75 in. thick	2.00 in. thick
2	40	18 (39)	26 (53)	34 (67)	43 (82)	53 (98)
4	40	22 (45)	31 (60)	41 (76)	52 (93)	64 (112)
6	40	24 (48)	34 (65)	45 (83)	58 (101)	71 (121)
8	40	26 (51)	37 (69)	49 (87)	62 (107)	76 (128)
10	40	28 (54)	39 (72)	52 (92)	66 (112)	81 (134)
12	40	29 (56)	41 (75)	54 (95)	69 (117)	85 (139)
2	50	16 (28)	22 (37)	30 (47)	38 (58)	46 (70)
4	50	19 (31)	27 (42)	36 (54)	45 (66)	55 (80)
6	50	21 (34)	30 (46)	39 (59)	50 (72)	62 (87)
8	50	23 (36)	32 (49)	42 (62)	54 (77)	66 (92)
10	50	24 (38)	34 (51)	45 (65)	57 (80)	70 (97)
12	50	25 (39)	36 (53)	47 (68)	60 (84)	74 (101)
2	60	14 (21)	20 (28)	27 (36)	34 (45)	41 (55)
4	60	17 (24)	24 (33)	32 (42)	40 (52)	49 (63)
6	60	19 (26)	27 (35)	35 (46)	45 (57)	55 (70)
8	60	20 (28)	29 (38)	38 (49)	48 (61)	59 (75)
10	60	21 (29)	30 (40)	40 (52)	51 (65)	63 (79)
12	60	22 (30)	32 (42)	42 (54)	53 (68)	66 (83)
2	70	13 (17)	18 (24)	24 (31)	31 (39)	38 (48)
4	70	15 (20)	22 (27)	29 (36)	37 (46)	45 (57)
6	70	17 (22)	24 (30)	32 (40)	41 (51)	50 (64)
8	70	18 (23)	26 (33)	34 (43)	44 (56)	54 (70)
10	70	19 (25)	27 (35)	36 (46)	46 (59)	57 (74)
12	70	20 (26)	29 (36)	38 (45)	48 (63)	60 (78)
2	80	12 (15)	17 (21)	22 (29)	28 (37)	35 (46)
4	80	14 (18)	20 (26)	26 (35)	34 (45)	41 (56)
6	80	16 (20)	22 (29)	29 (39)	37 (51)	46 (64)
8	80	17 (22)	24 (31)	32 (42)	40 (55)	49 (70)
10	80	18 (23)	25 (33)	33 (45)	43 (59)	52 (75)
12	80	19 (24)	26 (35)	35 (48)	45 (63)	55 (79)

^a $T_{°C} = (T_{°F} - 32)/1.8$; $°C = °F/1.8$; 1 in. = 25.4 mm.

^bValues in parentheses are 99% upper confidence bounds of heating times.

of thermocouples are used to accurately measure the temperature conditions of the chamber and the wood to ensure that time and temperature requirements for heat treating are met. Any equipment variance of more than ± 5 °F (± 2.8 °C) requires recalibration or replacement.

Heat treatment facilities are also required to monitor temperatures throughout the heat treatment cycle by any of the following options:

1. Wet- and dry-bulb temperature
2. Dry-bulb only—unless the specific schedule has been verified, required heating times shall be equal to or greater than the time specified for the applicable schedule assuming the maximum wet-bulb depression as provided in either of the following:
 - a. FPL–RP–607, *Heat sterilization time of ponderosa pine and Douglas-fir boards and square timbers* (Simpson and others 2003); or
 - b. FPL–RP–604, *Effect of wet-bulb depression on heat sterilization time of slash pine lumber* (Simpson 2002); or
 - c. CFIA PI–07, *The technical heat treatment guidelines and operating conditions manual*, Option C (CFIA 2006).
3. Direct measurement of wood core temperature of the thickest piece(s) by use of thermocouple(s) properly sealed with non-conductive material

Heat treatment facilities are currently required to annually calibrate the temperature-monitoring and recording equipment for each facility heat-treating chamber and requalify a heat-treating chamber any time there is a major change in equipment or remodeling of the chamber. Except in the case of wood core temperature of the thickest piece(s) being directly measured by using thermocouples, when wood moisture content is not determined at the beginning of the heat treatment cycle, facilities are required to select and use

Table 20–8. Summary of heating times (at 160 °F (71 °C)) to 133 °F (56 °C) for ponderosa pine square timbers estimated by multiple regression models^a

Wet-bulb depression (°F)	Initial temperature (°F)	Heating time (min) ^b				
		4 by 4	6 by 6	8 by 8	10 by 10	12 by 12
2	40	155 (225)	297 (429)	473 (682)	677 (980)	90 (1,321)
4	40	178 (259)	343 (492)	545 (782)	780 (1,123)	1,04 (1,512)
6	40	194 (282)	372 (535)	592 (850)	848 (1,220)	1,13 (1,643)
8	40	206 (299)	395 (569)	628 (903)	899 (1,296)	1,20 (1,745)
10	40	215 (314)	413 (597)	657 (947)	941 (1,359)	1,26 (1,830)
12	40	223 (327)	429 (621)	682 (986)	977 (1,414)	1,31 (1,904)
2	50	138 (200)	265 (382)	421 (609)	603 (878)	80 (1,185)
4	50	159 (229)	305 (437)	485 (697)	695 (1,003)	93 (1,354)
6	50	173 (249)	332 (475)	527 (756)	755 (1,088)	1,01 (1,468)
8	50	183 (264)	352 (504)	559 (802)	801 (1,155)	1,07 (1,558)
10	50	192 (277)	368 (529)	585 (841)	838 (1,210)	1,12 (1,633)
12	50	199 (288)	382 (550)	607 (875)	870 (1,258)	1,16 (1,697)
2	60	125 (182)	241 (350)	383 (559)	548 (807)	73 (1,091)
4	60	144 (208)	278 (400)	441 (638)	632 (921)	84 (1,245)
6	60	157 (226)	302 (433)	479 (692)	687 (998)	92 (1,349)
8	60	166 (240)	320 (460)	508 (734)	728 (1,058)	97 (1,430)
10	60	174 (251)	335 (482)	532 (769)	762 (1,108)	1,02 (1,497)
12	60	181 (261)	348 (501)	552 (799)	791 (1,151)	1,06 (1,555)
2	70	116 (169)	222 (326)	353 (523)	506 (755)	67 (1,022)
4	70	133 (193)	256 (372)	407 (596)	583 (860)	78 (1,164)
6	70	145 (210)	278 (403)	442 (645)	634 (932)	85 (1,260)
8	70	154 (222)	295 (427)	469 (684)	672 (987)	90 (1,335)
10	70	161 (233)	309 (448)	491 (716)	703 (1,033)	94 (1,398)
12	70	167 (242)	321 (465)	510 (743)	730 (1,073)	97 (1,451)
2	80	108 (160)	207 (308)	330 (494)	472 (715)	63 (968)
4	80	124 (182)	239 (351)	380 (563)	544 (814)	73 (1,102)
6	80	135 (197)	260 (380)	413 (609)	591 (880)	79 (1,192)
8	80	143 (209)	275 (403)	438 (645)	627 (932)	84 (1,262)
10	80	150 (219)	288 (421)	458 (675)	656 (975)	88 (1,321)
12	80	156 (227)	299 (438)	476 (701)	681 (1,013)	91 (1,371)

^a $T_c = (T_F - 32)/1.8$; °C = °F/1.8; 1 in. = 25.4 mm.

^bValues in parentheses are 99% upper confidence bounds of heating times.

appropriate time–temperature schedules assuming the lowest initial wood moisture content from one of the following publications:

- FPL–GTR–130, *Heating times for round and rectangular cross sections of wood in steam* (Simpson 2001);
- FPL–RP–607, *Heat sterilization time of ponderosa pine and Douglas-fir boards and square timbers* (Simpson and others 2003);
- FPL–RP–604, *Effect of wet-bulb depression on heat sterilization time of slash pine lumber* (Simpson 2002); or
- CFIA PI–07, *The technical heat treatment guidelines and operating conditions manual, Option C* (CFIA 2006).

Quality Mark

ISPM 15 requires that treated packaging must be marked with an official stamp that includes an International Plant

Protection Convention (IPPC) symbol, an International Standards Organization (ISO) two-letter country code, and abbreviation of the type of treatment used (heat treatment is indicated by the mark HT), and a unique number assigned by the country’s national plant protection organization to the producer of the wood packaging material, who is responsible for ensuring that appropriate wood is used and properly marked (Figure 20–5). If wood packaging materials arrive in a member country without this quality mark, officials at the port of arrival have the right to refuse entry or require treatment (such as fumigation) at the port—a costly situation. Recycled, remanufactured, or repaired wood packing material should be recertified and remarked. All components of such material are required to be properly treated.

Other Considerations

Heating capacity—It is critical in heat sterilization that the heating and humidification system be designed to meet the production schedule. Typically, the heating capacity of a

Table 20–9. Summary of heating times (at 160 °F (71 °C)) to 133 °F (56 °C) for Douglas-fir boards estimated by multiple regression models^a

Wet-bulb depression (°F)	Initial temperature (°F)	Heating time (min) ^b			
		0.75 in. thick	1.00 in. thick	1.25 in. thick	1.50 in. thick
2	60	9 (25)	14 (37)	21 (53)	28 (70)
4	60	11 (29)	17 (44)	25 (62)	34 (82)
6	60	12 (32)	19 (49)	28 (68)	38 (91)
8	60	13 (34)	21 (52)	30 (74)	41 (98)
10	60	14 (36)	22 (55)	32 (78)	43 (104)
12	60	15 (38)	23 (58)	34 (82)	45 (109)
2	70	7 (15)	12 (22)	17 (32)	23 (42)
4	70	9 (17)	14 (26)	20 (37)	27 (49)
6	70	10 (19)	16 (29)	23 (41)	31 (55)
8	70	11 (20)	17 (31)	24 (44)	33 (59)
10	70	11 (22)	18 (33)	26 (47)	35 (63)
12	70	12 (23)	19 (35)	27 (49)	37 (66)
2	80	6 (10)	10 (16)	14 (23)	19 (31)
4	80	7 (12)	12 (19)	17 (27)	23 (37)
6	80	8 (13)	13 (21)	19 (30)	25 (41)
8	80	9 (15)	14 (23)	20 (32)	28 (44)
10	80	9 (15)	15 (24)	22 (35)	29 (47)
12	80	10 (16)	16 (25)	23 (36)	31 (49)

^a $T_c = (T_F - 32)/1.8$; °C = °F/1.8; 1 in. = 25.4 mm.

^bValues in parentheses are 99% upper confidence bounds of heating times.

Table 20–10. Summary of heating times (at 160 °F (71 °C)) to 133 °F (56 °C) for Douglas-fir square timbers estimated by multiple regression models^a

Wet-bulb depression (°F)	Initial temperature (°F)	Heating time (min) ^b				
		4 by 4	6 by 6	8 by 8	10 by 10	12 by 12
2	60	159 (229)	285 (406)	473 (667)	738 (1,034)	1,098 (1,534)
4	60	200 (298)	360 (526)	597 (862)	932 (1,334)	1,386 (1,974)
6	60	229 (349)	412 (615)	684 (1,007)	1,068 (1,556)	1,588 (2,299)
8	60	253 (391)	454 (689)	754 (1,126)	1,176 (1,739)	1,749 (2,567)
10	60	272 (427)	489 (752)	812 (1,229)	1,267 (1,897)	1,885 (2,799)
12	60	289 (459)	520 (809)	863 (1,321)	1,347 (2,038)	2,004 (3,006)
2	70	105 (143)	188 (256)	312 (426)	487 (669)	724 (1,003)
4	70	132 (181)	237 (323)	394 (535)	614 (836)	914 (1,251)
6	70	151 (209)	272 (372)	451 (615)	704 (959)	1,047 (1,432)
8	70	167 (232)	299 (412)	497 (680)	775 (1,061)	1,153 (1,580)
10	70	179 (252)	323 (447)	535 (737)	835 (1,148)	1,243 (1,709)
12	70	191 (270)	343 (478)	569 (788)	888 (1,226)	1,321 (1,824)
2	80	73 (103)	131 (188)	217 (315)	339 (499)	505 (753)
4	80	92 (127)	165 (230)	274 (386)	428 (609)	637 (918)
6	80	105 (144)	189 (261)	314 (436)	491 (688)	730 (1,036)
8	80	116 (159)	209 (286)	346 (477)	540 (752)	804 (1,130)
10	80	125 (171)	225 (307)	373 (513)	582 (807)	866 (1,212)
12	80	133 (182)	239 (326)	397 (544)	619 (855)	921 (1,283)

^a $T_c = (T_F - 32)/1.8$; °C = °F/1.8; 1 in. = 25.4 mm.

^bValues in parentheses are 99% upper confidence bounds of heating times.

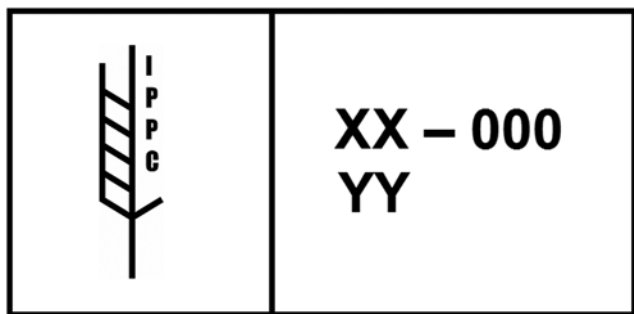

Figure 20–5. ISPM 15 requires the use of a quality mark on wood packaging materials to certify that proper treatment has occurred.

hardwood kiln ranges from 0.5 to 1.5 boiler horsepower per thousand board feet of lumber (7,100 to 21,300 Btu/h per cubic meter of lumber). To get the rapid heating needed, the boiler horsepower needs to be sized from 6.0 to 12.5 boiler horsepower per thousand board feet (85,100 to 177,300 Btu/h per cubic meter), depending on the lumber used and starting temperature (Denig and Bond 2003).

Structure damage—The environment used for heat sterilization of wood can be extremely corrosive and damaging to some structures. In addition to using the proper materials, a floor drain system should be used, especially when using the high-humidity schedules.

Mold prevention—Heat sterilization kills only mold, fungus, and insects that are present when the material is sterilized. In certain cases, mold and fungus have rapidly infested heat-sterilized lumber that was not dry (Denig and Bond 2003). It is critical for the pallet operator and user to keep their production facility free of waste wood, minimize pallet inventory of heat-treated pallets, and ensure some air movement around green pallets that have been heat-treated.

Literature Cited

ALSC. 2009. Wood packaging material enforcement regulations. Germantown, MD: American Lumber Standards Committee, Inc.

APHIS. 2004. Rules and regulations—importation of wood packaging material. In: Convention, animal and plant protection convention. 7 CFR, Part 319. Federal Register. 69(179): 55,719–55,733.

CFIA. 2006. The technical heat treatment guidelines and operating conditions manual. CFIA PI–09. Ottawa, Canada: Canadian Food Inspection Agency, Plant Health Division. 27 p.

Cheung, K.C.K. 2008. Rules and regulations regarding the heat treatment of wood—an American perspective. In: Conference, quality drying for the 21st Century: energy and

market realities; 2006 November 15–17; Bellingham, WA. Madison, WI: Forest Products Society: 83–85.

Denig, J.; Bond, B. 2003. Heat sterilization of hardwood pallets and pallet material. Pallet Phytosanitary Project Tech. Rep. No. TP–1. North Carolina: A cooperative effort of the limestone bluffs resources conservation and development area and the wood education and resources center. September 2003. 8 p.

Gu, L.B.; Garrahan, P. 1984. The temperature and moisture content in lumber during preheating and drying. *Wood Science and Technology*. 18: 121–135.

Ingersoll, L.R.; Zobel, A.C. 1948. Heat conduction. New York, NY: McGraw-Hill Book Co., Inc. 278 p.

IPPC. 2002. Guidelines for regulating wood packaging material in international trade. ISPM Pub. No. 15. FAO, Rome: International Plant Protection Convention.

MacLean, J.D. 1930. Studies of heat conduction in wood. Pt. I. Results of steaming green round Southern Pine timbers. In: Proceedings, American Wood Preservers' Association. 26: 197–217.

MacLean, J.D. 1932. Studies of heat conduction in wood. Pt. II. Results of steaming green sawed Southern Pine timbers. In: Proceedings, American Wood Preservers' Association. 28: 303–329.

MacLean, J.D. 1941. Thermal conductivity of wood: heating, piping and air conditioning. In: Proceedings, American Wood Preservers' Association. 13: 380–391.

Simpson, W.T. 2001. Heating times for round and rectangular cross sections of wood in steam. General Technical Report FPL–GTR–130. Madison, WI: U.S. Department of Agriculture, Forest Service, Forest Products Laboratory. 103 p.

Simpson, W.T. 2002. Effect of wet bulb depression on heat sterilization time of slash pine lumber. Research Paper FPL–RP–604. Madison, WI: U.S. Department of Agriculture, Forest Service, Forest Products Laboratory. 6 p.

Simpson, W.T.; Wang, X.; Verrill, S. 2003. Heat sterilization time of ponderosa pine and Douglas-fir boards and square timbers. Research Paper FPL–RP–607. Madison, WI: U.S. Department of Agriculture, Forest Service, Forest Products Laboratory. 24 p.

Simpson, W.T.; Wang, X.; Forsman, J.W.; Erickson, J.R. 2005. Heat sterilization times of five hardwood species. Research Paper FPL–RP–626. Madison, WI: U.S. Department of Agriculture, Forest Service, Forest Products Laboratory. 10 p.

Watson, G.N. 1958. A treatise on the theory of Bessel functions. 2nd ed. Cambridge, UK: Cambridge University Press. 804 p.

Adherend. A body that is held to another body by an adhesive.

Adhesion. The state in which two surfaces are held together by interfacial forces, which may consist of valence forces or interlocking action or both.

Adhesive. A substance capable of holding materials together by surface attachment. It is a general term and includes cements, mucilage, and paste, as well as glue.

Assembly Adhesive—An adhesive that can be used for bonding parts together, such as in the manufacture of a boat, airplane, furniture, and the like.

Cold-Setting Adhesive—An adhesive that sets at temperatures below 20 °C (68 °F).

Construction Adhesive—Any adhesive used to assemble primary building materials into components during building construction—most commonly applied to elastomer-based mastic-type adhesives.

Contact Adhesive—An adhesive that is apparently dry to the touch and that will adhere to itself instantaneously upon contact; also called contact bond adhesive or dry bond adhesive.

Gap-Filling Adhesive—An adhesive capable of forming and maintaining a bond between surfaces that are not close fitting.

Hot-Melt Adhesive—An adhesive that is applied in a molten state and forms a bond on cooling to a solid state.

Hot-Setting Adhesive—An adhesive that requires a temperature at or above 100 °C (212 °F) to set it.

Room-Temperature-Curing Adhesive—An adhesive that sets in the temperature range of 20 to 30 °C (68 to 86 °F), in accordance with the limits for Standard Room Temperature specified in the Standard Methods of Conditioning Plastics and Electrical Insulating Materials for Testing (ASTM D 618).

Solvent Adhesive—An adhesive having a volatile organic liquid as a vehicle. (This term excludes water-based adhesives.)

Structural Adhesive—A bonding agent used for transferring required loads between adherends exposed to service environments typical for the structure involved.

Air-Dried. (See **Seasoning.**)

Allowable Property. The value of a property normally published for design use. Allowable properties are identified with grade descriptions and standards, reflect the orthotropic structure of wood, and anticipate certain end uses.

Allowable Stress. (See **Allowable Property.**)

American Lumber Standard. The American Softwood Lumber Standard, Voluntary Product Standard PS-20 (National Institute of Standards and Technology), establishes standard sizes and requirements for the development and coordination of lumber grades of various species, the assignment of design values when called for, and the preparation of grading rules applicable to each species. It provides for implementation of the standard through an accreditation and certification program to assure uniform industry-wide marking and inspection. A purchaser must, however, make use of grading association rules because the basic standards are not in themselves commercial rules.

Anisotropic. Exhibiting different properties when measured along different axes. In general, fibrous materials such as wood are anisotropic.

Assembly Joint. (See **Joint.**)

Assembly Time. (See **Time, Assembly.**)

Balanced Construction. A construction such that the forces induced by uniformly distributed changes in moisture content will not cause warping. Symmetrical construction of plywood in which the grain direction of each ply is perpendicular to that of adjacent plies is balanced construction.

Bark Pocket. An opening between annual growth rings that contains bark. Bark pockets appear as dark streaks on radial surfaces and as rounded areas on tangential surfaces.

Bastard Sawn. Lumber (primarily hardwoods) in which the annual rings make angles of 30° to 60° with the surface of the piece.

Beam. A structural member supporting a load applied transversely to it.

Bending, Steam. The process of forming curved wood members by steaming or boiling the wood and bending it to a form.

Bent Wood. (See **Bending, Steam.**)

Bird Peck. A small hole or patch of distorted grain resulting from birds pecking through the growing cells in the tree. The shape of bird peck usually resembles a carpet tack with the point towards the bark; bird peck is usually accompanied by discoloration extending for considerable distance along the grain and to a much lesser extent across the grain.

Birdseye. Small localized areas in wood with the fibers indented and otherwise contorted to form few to many small circular or elliptical figures remotely resembling birds' eyes on the tangential surface. Sometimes found in sugar maple and used for decorative purposes; rare in other hardwood species.

Blister. An elevation of the surface of an adherend, somewhat resembling in shape a blister on human skin; its bound-

aries may be indefinitely outlined, and it may have burst and become flattened. (A blister may be caused by insufficient adhesive; inadequate curing time, temperature, or pressure; or trapped air, water, or solvent vapor.)

Bloom. Crystals formed on the surface of treated wood by exudation and evaporation of the solvent in preservative solutions.

Blow. In plywood and particleboard especially, the development of steam pockets during hot pressing of the panel, resulting in an internal separation or rupture when pressure is released, sometimes with an audible report.

Blue Stain. (See **Stain.**)

Board. (See **Lumber.**)

Board Foot. A unit of measurement of lumber represented by a board 12 in. long, 12 in. wide, and 1 in. thick or its cubic equivalent. In practice, the board foot calculation for lumber 1 in. or more in thickness is based on its nominal thickness and width and the actual length. Lumber with a nominal thickness of less than 1 in. is calculated as 1 in.

Bole. The main stem of a tree of substantial diameter—roughly, capable of yielding sawtimber, veneer logs, or large poles. Seedlings, saplings, and small-diameter trees have stems, not boles.

Bolt. (1) A short section of a tree trunk. (2) In veneer production, a short log of a length suitable for peeling in a lathe.

Bond. (1) The union of materials by adhesives. (2) To unite materials by means of an adhesive.

Bondability. Term indicating ease or difficulty in bonding a material with adhesive.

Bond Failure. Rupture of adhesive bond.

Bondline. The layer of adhesive that attaches two adherends.

Bondline Slip. Movement within and parallel to the bondline during shear.

Bond Strength. The unit load applied in tension, compression, flexure, peel impact, cleavage, or shear required to break an adhesive assembly, with failure occurring in or near the plane of the bond.

Bow. The distortion of lumber in which there is a deviation, in a direction perpendicular to the flat face, from a straight line from end-to-end of the piece.

Box Beam. A built-up beam with solid wood flanges and plywood or wood-based panel product webs.

Boxed Heart. The term used when the pith falls entirely within the four faces of a piece of wood anywhere in its length. Also called boxed pith.

Brashness. A condition that causes some pieces of wood to be relatively low in shock resistance for the species and, when broken in bending, to fail abruptly without splintering at comparatively small deflections.

Breaking Radius. The limiting radius of curvature to which wood or plywood can be bent without breaking.

Bright. Free from discoloration.

Broad-Leaved Trees. (See **Hardwoods.**)

Brown Rot. (See **Decay.**)

Brown Stain. (See **Stain.**)

Built-Up Timbers. An assembly made by joining layers of lumber together with mechanical fastenings so that the grain of all laminations is essentially parallel.

Burl. (1) A hard, woody outgrowth on a tree, more or less rounded in form, usually resulting from the entwined growth of a cluster of adventitious buds. Such burls are the source of the highly figured burl veneers used for purely ornamental purposes. (2) In lumber or veneer, a localized severe distortion of the grain generally rounded in outline, usually resulting from overgrowth of dead branch stubs, varying from one to several centimeters (one-half to several inches) in diameter; frequently includes one or more clusters of several small contiguous conical protuberances, each usually having a core or pith but no appreciable amount of end grain (in tangential view) surrounding it.

Butt Joint. (See **Joint.**)

Buttress. A ridge of wood developed in the angle between a lateral root and the butt of a tree, which may extend up the stem to a considerable height.

Cambium. A thin layer of tissue between the bark and wood that repeatedly subdivides to form new wood and bark cells.

Cant. A log that has been slabbed on one or more sides. Ordinarily, cants are intended for resawing at right angles to their widest sawn face. The term is loosely used. (See **Fitch.**)

Casehardening. A condition of stress and set in dry lumber characterized by compressive stress in the outer layers and tensile stress in the center or core.

Catalyst. A substance that initiates or changes the rate of chemical reaction but is not consumed or changed by the reaction.

Cell. A general term for the anatomical units of plant tissue, including wood fibers, vessel members, and other elements of diverse structure and function.

Cellulose. The carbohydrate that is the principal constituent of wood and forms the framework of the wood cells.

Cellulosic Fiberboard. (See **Wood-Based Composite Panel.**)

Glossary

Check. A lengthwise separation of the wood that usually extends across the rings of annual growth and commonly results from stresses set up in wood during seasoning.

Chemical Brown Stain. (See **Stain.**)

Chipboard. A paperboard used for many purposes that may or may not have specifications for strength, color, or other characteristics. It is normally made from paper stock with a relatively low density in the thickness of 0.1524 mm (0.006 in.) and up.

Cleavage. In an adhesively bonded joint, a separation in the joint caused by a wedge or other crack-opening-type action.

Close Grained. (See **Grain.**)

Coarse Grained. (See **Grain.**)

Cohesion. The state in which the constituents of a mass of material are held together by chemical and physical forces.

Cold Pressing. A bonding operation in which an assembly is subjected to pressure without the application of heat.

Collapse. The flattening of single cells or rows of cells in heartwood during the drying or pressure treatment of wood. Often characterized by a caved-in or corrugated appearance of the wood surface.

Compartment Kiln. (See **Kiln.**)

Composite Assembly. A combination of two or more materials bonded together that perform as a single unit.

Composite Panel. (See **Wood-Based Composite Panel.**)

Compound Curvature. Wood bent to a compound curvature, no element of which is a straight line.

Compreg. Wood in which the cell walls have been impregnated with synthetic resin and compressed to give it reduced swelling and shrinking characteristics and increased density and strength properties.

Compression Failure. Deformation of the wood fibers resulting from excessive compression along the grain either in direct end compression or in bending. It may develop in standing trees due to bending by wind or snow or to internal longitudinal stresses developed in growth, or it may result from stresses imposed after the tree is cut. In surfaced lumber, compression failures may appear as fine wrinkles across the face of the piece.

Compression Wood. Abnormal wood formed on the lower side of branches and inclined trunks of softwood trees. Compression wood is identified by its relatively wide annual rings (usually eccentric when viewed on cross section of branch or trunk), relatively large amount of latewood (sometimes more than 50% of the width of the annual rings in which it occurs), and its lack of demarcation between earlywood and latewood in the same annual rings. Compression wood shrinks excessively longitudinally, compared with normal wood.

Conditioning (pre and post). The exposure of a material to the influence of a prescribed atmosphere for a stipulated period of time or until a stipulated relation is reached between material and atmosphere.

Conifer. (See **Softwoods.**)

Connector, Timber. Metal rings, plates, or grids that are embedded in the wood of adjacent members, as at the bolted points of a truss, to increase the strength of the joint.

Consistency. That property of a liquid adhesive by virtue of which it tends to resist deformation. (Consistency is not a fundamental property but is composed of rheological properties such as viscosity, plasticity, and other phenomena.)

Construction Adhesive. (See **Adhesive.**)

Contact Angle. The angle between a substrate plane and the free surface of a liquid droplet at the line of contact with the substrate.

Cooperage. Containers consisting of two round heads and a body composed of staves held together with hoops, such as barrels and kegs.

Slack Cooperage—Cooperage used as containers for dry, semidry, or solid products. The staves are usually not closely fitted and are held together with beaded steel, wire, or wood hoops.

Tight Cooperage—Cooperage used as containers for liquids, semisolids, or heavy solids. Staves are well fitted and held tightly with cooperage-grade steel hoops.

Copolymer. Substance obtained when two or more types of monomers polymerize.

Corbel. A projection from the face of a wall or column supporting a weight.

Core Stock. A solid or discontinuous center ply used in panel-type glued structures (such as furniture panels and solid or hollowcore doors).

Coupling Agent. A molecule with different or like functional groups that is capable of reacting with surface molecules of two different substances, thereby chemically bridging the substances.

Covalent Bond. A chemical bond that results when electrons are shared by two atomic nuclei.

Creep. (1) Time-dependent deformation of a wood member under sustained wood. (2) In an adhesive, the time-dependent increase in strain resulting from a sustained stress.

Crook. The distortion of lumber in which there is a deviation, in a direction perpendicular to the edge, from a straight line from end-to-end of the piece.

Crossband. To place the grain of layers of wood at right angles in order to minimize shrinking and swelling; also, in plywood of three or more plies, a layer of veneer whose grain direction is at right angles to that of the face plies.

Cross Break. A separation of the wood cells across the grain. Such breaks may be due to internal stress resulting from unequal longitudinal shrinkage or to external forces.

Cross Grained. (See **Grain.**)

Cross-Link. An atom or group connecting adjacent molecules in a complex molecular structure.

Cup. A distortion of a board in which there is a deviation flatwise from a straight line across the width of the board.

Cure. To change the properties of an adhesive by chemical reaction (which may be condensation, polymerization, or vulcanization) and thereby develop maximum strength. Generally accomplished by the action of heat or a catalyst, with or without pressure.

Curing Agent. (See **Hardener.**)

Curing Temperature. (See **Temperature, Curing.**)

Curing Time. (See **Time, Curing.**)

Curly Grained. (See **Grain.**)

Curtain Coating. Applying liquid adhesive to an adherend by passing the adherend under a thin curtain of liquid falling by gravity or pressure.

Cut Stock. (See **Lumber for Dimension.**)

Cuttings. In hardwoods, portions of a board or plank having the quality required by a specific grade or for a particular use. Obtained from a board by crosscutting or ripping.

Decay. The decomposition of wood substance by fungi.

Advanced (Typical) Decay—The older stage of decay in which the destruction is readily recognized because the wood has become punky, soft and spongy, stringy, ringshaked, pitted, or crumbly. Decided discoloration or bleaching of the rotted wood is often apparent.

Brown Rot—In wood, any decay in which the attack concentrates on the cellulose and associated carbohydrates rather than on the lignin, producing a light to dark brown friable residue—hence loosely termed “dry rot.” An advanced stage where the wood splits along rectangular planes, in shrinking, is termed “cubical rot.”

Dry Rot—A term loosely applied to any dry, crumbly rot but especially to that which, when in an advanced stage, permits the wood to be crushed easily to a dry powder. The term is actually a misnomer for any decay, since all fungi require considerable moisture for growth.

Incipient Decay—The early stage of decay that has not proceeded far enough to soften or otherwise perceptibly impair the hardness of the wood. It is usually accompanied by a slight discoloration or bleaching of the wood.

Heart Rot—Any rot characteristically confined to the heartwood. It generally originates in the living tree.

Pocket Rot—Advanced decay that appears in the form of a hole or pocket, usually surrounded by apparently sound wood.

Soft Rot—A special type of decay developing under very wet conditions (as in cooling towers and boat timbers) in the outer wood layers, caused by cellulose-destroying microfungi that attack the secondary cell walls and not the intercellular layer.

White-Rot—In wood, any decay or rot attacking both the cellulose and the lignin, producing a generally whitish residue that may be spongy or stringy rot, or occur as pocket rot.

Delamination. The separation of layers in laminated wood or plywood because of failure of the adhesive, either within the adhesive itself or at the interface between the adhesive and the adherend.

Delignification. Removal of part or all of the lignin from wood by chemical treatment.

Density. As usually applied to wood of normal cellular form, density is the mass per unit volume of wood substance enclosed within the boundary surfaces of a wood-plus-voids complex. It is variously expressed as pounds per cubic foot, kilograms per cubic meter, or grams per cubic centimeter at a specified moisture content.

Density Rules. A procedure for segregating wood according to density, based on percentage of latewood and number of growth rings per inch of radius.

Dew Point. The temperature at which a vapor begins to deposit as a liquid. Applies especially to water in the atmosphere.

Diagonal Grained. (See **Grain.**)

Diffuse-Porous Wood. Certain hardwoods in which the pores tend to be uniform in size and distribution throughout each annual ring or to decrease in size slightly and gradually toward the outer border of the ring.

Dimension. (See **Lumber for Dimension.**)

Dipole–Dipole Forces. Intermolecular attraction forces between polar molecules that result when positive and negative poles of molecules are attracted to one another.

Dote. “Dote,” “doze,” and “rot” are synonymous with “decay” and are any form of decay that may be evident as either a discoloration or a softening of the wood.

Double Spread. (See **Spread.**)

Dry-Bulb Temperature. The temperature of air as indicated by a standard thermometer. (See **Psychrometer.**)

Dry Kiln. (See **Kiln.**)

Dry Rot. (See **Decay.**)

Glossary

Dry Strength. The strength of an adhesive joint determined immediately after drying under specified conditions or after a period of conditioning in a standard laboratory atmosphere.

Drywall. Panel product used as an interior wall and ceiling covering made of gypsum plaster with paper facings. The gypsum plaster may be reinforced with recycled fiber.

Durability. A general term for permanence or resistance to deterioration. Frequently used to refer to the degree of resistance of a species of wood to attack by wood-destroying fungi under conditions that favor such attack. In this connection, the term “decay resistance” is more specific. As applied to bondlines, the life expectancy of the structural qualities of the adhesive under the anticipated service conditions of the structure.

Earlywood. The portion of the growth ring that is formed during the early part of the growing season. It is usually less dense and weaker mechanically than latewood.

Edge Grained. (See **Grain.**)

Edge Joint. (See **Joint.**)

Elastomer. A macromolecular material that, at room temperature, is deformed by application of a relatively low force and is capable of recovering substantially in size and shape after removal of the force.

Embrittlement. A loss in strength or energy absorption without a corresponding loss in stiffness. Clear, straight-grained wood is generally considered a ductile material; chemical treatments and elevated temperatures can alter the original chemical composition of wood, thereby embrittling the wood.

Encased Knot. (See **Knot.**)

End Grained. (See **Grain.**)

End Joint. (See **Joint.**)

Equilibrium Moisture Content. The moisture content at which wood neither gains nor loses moisture when surrounded by air at a given relative humidity and temperature.

Excelsior. (See **Wood Wool.**)

Extender. A substance, generally having some adhesive action, added to an adhesive to reduce the amount of the primary binder required per unit area.

Exterior Plywood. (See **Wood-Based Composite Panel.**)

Extractive. Substances in wood, not an integral part of the cellular structure, that can be removed by solution in hot or cold water, ether, benzene, or other solvents that do not react chemically with wood components.

Extrusion Spreading. A method of adhesive application in which adhesive is forced through small openings in the spreader head.

Factory and Shop Lumber. (See **Lumber.**)

Failure, Adherend. Rupture of an adhesive joint, such that the separation appears to be within the adherend.

Failure, Adhesive. Rupture of an adhesive joint, such that the plane of separation appears to be at the adhesive–adherend interface.

Failure, Cohesive. Rupture of an adhesive joint, such that the separation appears to be within the adhesive.

Feed Rate. The distance that the stock being processed moves during a given interval of time or operational cycle.

Fiber, Wood. A wood cell comparatively long (≤ 40 to 300 mm, ≤ 1.5 to 12 in.), narrow, tapering, and closed at both ends.

Fiberboard. (See **Wood-Based Composite Panel.**)

Fiber Saturation Point. The stage in the drying or wetting of wood at which the cell walls are saturated and the cell cavities free from water. It applies to an individual cell or group of cells, not to whole boards. It is usually taken as approximately 30% moisture content, based on oven-dry weight.

Fibril. A threadlike component of cell walls, invisible under a light microscope.

Figure. The pattern produced in a wood surface by annual growth rings, rays, knots, deviations from regular grain such as interlocked and wavy grain, and irregular coloration.

Filler. In woodworking, any substance used to fill the holes and irregularities in planed or sanded surfaces to decrease the porosity of the surface before applying finish coatings. As applied to adhesives, a relatively nonadhesive substance added to an adhesive to improve its working properties, strength, or other qualities.

Fine Grained. (See **Grain.**)

Fingerjoint. (See **Joint.**)

Finish (Finishing). (1) Wood products such as doors, stairs, and other fine work required to complete a building, especially the interior. (2) Coatings of paint, varnish, lacquer, wax, or other similar materials applied to wood surfaces to protect and enhance their durability or appearance.

Fire Endurance. A measure of the time during which a material or assembly continues to exhibit fire resistance under specified conditions of test and performance.

Fire Resistance. The property of a material or assembly to withstand fire or give protection from it. As applied to elements of buildings, it is characterized by the ability to confine a fire or to continue to perform a given structural function, or both.

Fire Retardant. (See **Flame Retardant.**)

Fire-Retardant-Treated Wood. As specified in building codes, a wood product that has been treated with chemicals by a pressure process or treated during the manufacturing process for the purpose of reducing its flame spread performance in an ASTM E 84 test conducted for 30 min to performance levels specified in the codes.

Flake. A small flat wood particle of predetermined dimensions, uniform thickness, with fiber direction essentially in the plane of the flake; in overall character resembling a small piece of veneer. Produced by special equipment for use in the manufacture of flakeboard.

Flakeboard. (See **Wood-Based Composite Panel.**)

Flame Retardant. A treatment, coating, or chemicals that when applied to wood products delays ignition and reduces the flame spread of the product.

Flame Spread. The propagation of a flame away from the source of ignition across the surface of a liquid or a solid, or through the volume of a gaseous mixture.

Flat Grained. (See **Grain.**)

Flat Sawn. (See **Grain.**)

Flecks. (See **Rays, Wood.**)

Flich. A portion of a log sawn on two or more faces—commonly on opposite faces leaving two waney edges. When intended for resawing into lumber, it is resawn parallel to its original wide faces. Or, it may be sliced or sawn into veneer, in which case the resulting sheets of veneer laid together in the sequence of cutting are called a flich. The term is loosely used. (See **Cant.**)

Framing. Lumber used for the structural member of a building, such as studs and joists.

Full-Cell Process. Any process for impregnating wood with preservatives or chemicals in which a vacuum is drawn to remove air from the wood before admitting the preservative. This favors heavy adsorption and retention of preservative in the treated portions.

Furnish. Wood material that has been reduced for incorporation into conventional wood-based composites; including flakes, particles, and fiber.

Gelatinous Fibers. Modified fibers that are associated with tension wood in hardwoods.

Girder. A large or principal beam used to support concentrated loads at isolated points along its length.

Gluability. (See **Bondability.**)

Glue. Originally, a hard gelatin obtained from hides, tendons, cartilage, bones, etc., of animals. Also, an adhesive prepared from this substance by heating with water. Through general use, the term is now synonymous with the term “adhesive.”

Glue Laminating. Production of structural or nonstructural wood members by bonding two or more layers of wood together with adhesive.

Glued Laminated Timber (Glulam). A manufactured structural timber product composed of layers of dimensional lumber glued together.

Glueline. (See **Bondline.**)

Grade. The designation of the quality of a manufactured piece of wood or of logs.

Grain. The direction, size, arrangement, appearance, or quality of the fibers in wood or lumber. To have a specific meaning the term must be qualified.

Close-Grained (Fine-Grained) Wood—Wood with narrow, inconspicuous annual rings. The term is sometimes used to designate wood having small and closely spaced pores, but in this sense the term “fine textured” is more often used.

Coarse-Grained Wood—Wood with wide conspicuous annual rings in which there is considerable difference between earlywood and latewood. The term is sometimes used to designate wood with large pores, such as oak, keruing, meranti, and walnut, but in this sense, the term “open-grained” is more often used.

Cross-Grained Wood—Wood in which the fibers deviate from a line parallel to the sides of the piece. Cross grain may be either diagonal or spiral grain or a combination of the two.

Curly-Grained Wood—Wood in which the fibers are distorted so that they have a curled appearance, as in “birds-eye” wood. The areas showing curly grain may vary up to several inches in diameter.

Diagonal-Grained Wood—Wood in which the annual rings are at an angle with the axis of a piece as a result of sawing at an angle with the bark of the tree or log. A form of cross-grain.

Edge-Grained Lumber—Lumber that has been sawed so that the wide surfaces extend approximately at right angles to the annual growth rings. Lumber is considered edge grained when the rings form an angle of 45° to 90° with the wide surface of the piece.

End-Grained Wood—The grain as seen on a cut made at a right angle to the direction of the fibers (such as on a cross section of a tree).

Fiddleback-Grained Wood—Figure produced by a type of fine wavy grain found, for example, in species of maple; such wood being traditionally used for the backs of violins.

Flat-Grained (Flat-Sawn) Lumber—Lumber that has been sawn parallel to the pith and approximately tangent

Glossary

to the growth rings. Lumber is considered flat grained when the annual growth rings make an angle of less than 45° with the surface of the piece.

Interlocked-Grained Wood—Grain in which the fibers put on for several years may slope in a right-handed direction, and then for a number of years the slope reverses to a left-handed direction, and later changes back to a right-handed pitch, and so on. Such wood is exceedingly difficult to split radially, though tangentially it may split fairly easily.

Open-Grained Wood—Common classification for woods with large pores such as oak, keruing, meranti, and walnut. Also known as “coarse textured.”

Plainsawn Lumber—Another term for flat-grained lumber.

Quartersawn Lumber—Another term for edge-grained lumber.

Side-Grained Wood—Another term for flat-grained lumber.

Slash-Grained Wood—Another term for flat-grained lumber.

Spiral-Grained Wood—Wood in which the fibers take a spiral course about the trunk of a tree instead of the normal vertical course. The spiral may extend in a right-handed or left-handed direction around the tree trunk. Spiral grain is a form of cross grain.

Straight-Grained Wood—Wood in which the fibers run parallel to the axis of a piece.

Vertical-Grained Lumber—Another term for edge-grained lumber.

Wavy-Grained Wood—Wood in which the fibers collectively take the form of waves or undulations.

Green. Freshly sawed or undried wood. Wood that has become completely wet after immersion in water would not be considered green but may be said to be in the “green condition.”

Growth Ring. The layer of wood growth put on a tree during a single growing season. In the temperate zone, the annual growth rings of many species (for example, oaks and pines) are readily distinguished because of differences in the cells formed during the early and late parts of the season. In some temperate zone species (black gum and sweetgum) and many tropical species, annual growth rings are not easily recognized.

Gum. A comprehensive term for nonvolatile viscous plant exudates, which either dissolve or swell up in contact with water. Many substances referred to as gums such as pine and spruce gum are actually oleoresins.

Hardboard. (See **Wood-Based Composite Panel.**)

Hardener. A substance or mixture of substances that is part of an adhesive and is used to promote curing by taking part in the reaction.

Hardness. A property of wood that enables it to resist indentation.

Hardwoods. Generally one of the botanical groups of trees that have vessels or pores and broad leaves, in contrast to the conifers or softwoods. The term has no reference to the actual hardness of the wood.

Heart Rot. (See **Decay.**)

Heartwood. The wood extending from the pith to the sapwood, the cells of which no longer participate in the life processes of the tree. Heartwood may contain phenolic compounds, gums, resins, and other materials that usually make it darker and more decay resistant than sapwood.

Hemicellulose. A celluloselike material (in wood) that is easily decomposable as by dilute acid, yielding several different simple sugars.

Hertz. A unit of frequency equal to one cycle per second.

High Frequency Curing. (See **Radiofrequency Curing.**)

Hollow-Core Construction. A panel construction with faces of plywood, hardboard, or similar material bonded to a framed-core assembly of wood lattice, paperboard rings, or the like, which support the facing at spaced intervals.

Honeycomb Core. A sandwich core material constructed of thin sheet materials or ribbons formed to honeycomb-like configurations.

Honeycombing. Checks, often not visible at the surface, that occur in the interior of a piece of wood, usually along the wood rays.

Hot-Setting Adhesive. (See **Adhesive.**)

Hydrogen Bond. An intermolecular attraction force that results when the hydrogen of one molecule and a pair of unshared electrons on an electronegative atom of another molecule are attracted to one another.

Hydrophilic. Having a strong tendency to bind or absorb water.

Hydrophobic. Having a strong tendency to repel water.

Impreg. Wood in which the cell walls have been impregnated with synthetic resin so as to reduce materially its swelling and shrinking. Impreg is not compressed.

Incising. A pretreatment process in which incisions, slits, or perforations are made in the wood surface to increase penetration of preservative treatments. Incising is often required to enhance durability of some difficult-to-treat species, but incising reduces strength.

Increment Borer. An augerlike instrument with a hollow bit and an extractor, used to extract thin radial cylinders of

wood from trees to determine age and growth rate. Also used in wood preservation to determine the depth of penetration of a preservative.

Inorganic-Bonded Composites. Manufactured wood-based composites where an inorganic binder, typically gypsum, Portland-cement, or magnesia-cement, acts as a continuous matrix and fully encapsulates the wood elements.

Intergrown Knot. (See **Knot.**)

Interior Plywood. (See **Wood-Based Composite Panel.**)

Interlocked Grained. (See **Grain.**)

Interlocking Action. (See **Mechanical Adhesion.**)

Internal Stresses. Stresses that exist within an adhesive joint even in the absence of applied external forces.

Interphase. In wood bonding, a region of finite thickness as a gradient between the bulk adherend and bulk adhesive in which the adhesive penetrates and alters the adherend's properties and in which the presence of the adherend influences the chemical and/or physical properties of the adhesive.

Intumesce. To expand with heat to provide a low-density film; used in reference to certain fire-retardant coatings.

Isotropic. Exhibiting the same properties in all directions.

Joint. The junction of two pieces of wood or veneer.

Adhesive Joint—The location at which two adherends are held together with a layer of adhesive.

Assembly Joint—Joints between variously shaped parts or subassemblies such as in wood furniture (as opposed to joints in plywood and laminates that are all quite similar).

Butt Joint—An end joint formed by abutting the squared ends of two pieces.

Edge Joint—A joint made by bonding two pieces of wood together edge to edge, commonly by gluing. The joints may be made by gluing two squared edges as in a plain edge joint or by using machined joints of various kinds, such as tongued-and-grooved joints.

End Joint—A joint made by bonding two pieces of wood together end to end, commonly by finger or scarf joint.

Fingerjoint—An end joint made up of several meshing wedges or fingers of wood bonded together with an adhesive. Fingers are sloped and may be cut parallel to either the wide or narrow face of the piece.

Lap Joint—A joint made by placing one member partly over another and bonding the overlapped portions.

Scarf Joint—An end joint formed by joining with adhesive the ends of two pieces that have been tapered or beveled to form sloping plane surfaces, usually to a feather-edge, and with the same slope of the plane with respect

to the length in both pieces. In some cases, a step or hook may be machined into the scarf to facilitate alignment of the two ends, in which case the plane is discontinuous and the joint is known as a stepped or hooked scarf joint.

Starved Joint—A glue joint that is poorly bonded because an insufficient quantity of adhesive remained in the joint.

Sunken Joint—Depression in wood surface at a joint (usually an edge joint) caused by surfacing material too soon after bonding. (Inadequate time was allowed for moisture added with the adhesive to diffuse away from the joint.)

Joint Efficiency or Factor. The strength of a joint expressed as a percentage of the strength of clear straight-grained material.

Joist. One of a series of parallel beams used to support floor and ceiling loads and supported in turn by larger beams, girders, or bearing walls.

Kiln. A chamber having controlled air-flow, temperature, and relative humidity for drying lumber. The temperature is increased as drying progresses, and the relative humidity is decreased.

Kiln Dried. (See **Seasoning.**)

Knot. That portion of a branch or limb that has been surrounded by subsequent growth of the stem. The shape of the knot as it appears on a cut surface depends on the angle of the cut relative to the long axis of the knot.

Encased Knot—A knot whose rings of annual growth are not intergrown with those of the surrounding wood.

Intergrown Knot—A knot whose rings of annual growth are completely intergrown with those of the surrounding wood.

Loose Knot—A knot that is not held firmly in place by growth or position and that cannot be relied upon to remain in place.

Pin Knot—A knot that is not more than 12 mm (1/2 in.) in diameter.

Sound Knot—A knot that is solid across its face, at least as hard as the surrounding wood, and shows no indication of decay.

Spike Knot—A knot cut approximately parallel to its long axis so that the exposed section is definitely elongated.

Laminate. A product made by bonding together two or more layers (laminations) of material or materials.

Laminate, Paper-Based. A multilayered panel made by compressing sheets of resin-impregnated paper together into a coherent solid mass.

Glossary

Laminated Strand Lumber (LSL). (See **Structural Composite Lumber**.)

Laminated Veneer Lumber (LVL). (See **Structural Composite Lumber**.)

Lap Joint. (See **Joint**.)

Latewood. The portion of the growth ring that is formed after the earlywood formation has ceased. It is usually denser and stronger mechanically than earlywood.

Latex Paint. A paint containing pigments and a stable water suspension of synthetic resins (produced by emulsion polymerization) that forms an opaque film through coalescence of the resin during water evaporation and subsequent curing.

Lathe Checks. In rotary-cut and sliced veneer, the fractures or checks that develop along the grain of the veneer as the knife peels veneer from the log. The knife side of the veneer where checks occur is called the loose side. The opposite and log side of the veneer where checking usually does not occur is called the tight side.

Layup. The process of loosely assembling the adhesive-coated components of a unit, particularly a panel, to be pressed or clamped.

Lbs/MSGL. Abbreviation for rate of adhesive application in pounds of adhesive per 1,000 ft² of single glueline (bondline). (See **Spread**.) When both faces of an adherend are spread as in some plywood manufacturing processes, the total weight of adhesive applied may be expressed as Lbs/MDGL (pounds per 1,000 ft² double glueline).

Lignin. The second most abundant constituent of wood, located principally in the secondary wall and the middle lamella, which is the thin cementing layer between wood cells. Chemically, it is an irregular polymer of substituted propylphenol groups, and thus, no simple chemical formula can be written for it.

London Dispersion Forces. Intermolecular attraction forces between nonpolar molecules that result when instantaneous (nonpermanent) dipoles induce matching dipoles in neighboring molecules. London forces also exist between polar molecules.

Longitudinal. Generally, parallel to the direction of the wood fibers.

Loose Knot. (See **Knot**.)

Lumber. The product of the saw and planing mill for which manufacturing is limited to sawing, resawing, passing lengthwise through a standard planing machine, crosscutting to length, and matching. Lumber may be made from either softwood or hardwood (See also **Lumber for Dimension**.)

Board—Lumber that is less than 38 mm standard (2 in. nominal) thickness and greater than 38 mm standard (2 in. nominal) width. Boards less than 140 mm standard (6 in. nominal) width are sometimes called strips.

Dimension—Lumber with a thickness from 38 mm standard (2 in. nominal) up to but not including 114 mm standard (5 in. nominal) and a width of greater than 38 mm standard (2 in. nominal).

Dressed Size—The dimensions of lumber after being surfaced with a planing machine. The dressed size is usually 1/2 to 3/4 in. less than the nominal or rough size. A 2- by 4-in. stud, for example, actually measures about 1-1/2 by 3-1/2 in. (standard 38 by 89 mm).

Factory and Shop Lumber—Lumber intended to be cut up for use in further manufacture. It is graded on the percentage of the area that will produce a limited number of cuttings of a specified minimum size and quality.

Matched Lumber—Lumber that is edge dressed and shaped to make a close tongued-and-grooved joint at the edges or ends when laid edge to edge or end to end.

Nominal Size—As applied to timber or lumber, the size by which it is known and sold in the market (often differs from the actual size).

Patterned Lumber—Lumber that is shaped to a pattern or to a molded form in addition to being dressed, matched, or shiplapped, or any combination of these workings.

Rough Lumber—Lumber that has not been dressed (surfaced) but has been sawed, edged, and trimmed.

Shiplapped Lumber—Lumber that is edge dressed to make a lapped joint.

Shipping-Dry Lumber—Lumber that is partially dried to prevent stain and mold in transit.

Shop Lumber—(See **Factory and Shop Lumber**.)

Side Lumber—A board from the outer portion of the log—ordinarily one produced when squaring off a log for a tie or timber.

Structural Lumber—Lumber that is intended for use where allowable properties are required. The grading of structural lumber is based on the strength or stiffness of the piece as related to anticipated uses.

Surfaced Lumber—Lumber that is dressed by running it through a planer.

Timbers—Lumber that is standard 114 mm (nominal 5 in.) or more in least dimension. Timbers may be used as beams, stringers, posts, caps, sills, girders, or purlins.

Yard Lumber—A little-used term for lumber of all sizes and patterns that is intended for general building purposes having no design property requirements.

Lumber for Dimension. The National Dimension Manufacturers Association defines both hardwood and softwood dimension components as being cut to a specific size from

kiln-dried rough lumber, bolts, cants, or logs. Dimension components include Flat Stock (solid and laminated) for furniture, cabinet, and specialty manufactures. This term has largely superseded the terms “hardwood dimension” and “dimension parts.” (See also **Lumber**).

Lumen. In wood anatomy, the cell cavity.

Manufacturing Defects. Includes all defects or blemishes that are produced in manufacturing, such as chipped grain, loosened grain, raised grain, torn grain, skips in dressing, hit and miss (series of surfaced areas with skips between them), variation in sawing, miscut lumber, machine burn, machine gouge, mismatching, and insufficient tongue or groove.

Mastic. A material with adhesive properties, usually used in relatively thick sections, that can be readily applied by extrusion, trowel, or spatula. (See **Adhesive**.)

Matched Lumber. (See **Lumber**.)

Mechanical Adhesion. Adhesion between surfaces in which the adhesive holds the parts together by interlocking action.

Medium-Density Fiberboard. (See **Wood-Based Composite Panel**.)

Millwork. Planed and patterned lumber for finish work in buildings, including items such as sash, doors, cornices, panelwork, and other items of interior or exterior trim. Does not include flooring, ceiling, or siding.

Mineral Streak. An olive to greenish-black or brown discoloration of undetermined cause in hardwoods.

Modified Wood. Wood processed by chemical treatment, compression, or other means (with or without heat) to impart properties quite different from those of the original wood.

Moisture Content. The amount of water contained in the wood, usually expressed as a percentage of the weight of the oven-dry wood.

Molecular Weight. The sum of the atomic weights of the atoms in a molecule.

Moulding. A wood strip having a curved or projecting surface, used for decorative purposes.

Monomer. A relatively simple molecular compound that can react at more than one site to form a polymer.

Mortise. A slot cut into a board, plank, or timber, usually edgewise, to receive the tenon of another board, plank, or timber to form a joint.

Nanoindentation Hardness. A hardness measurement conducted at the nanometer scale. Nanoindentation hardness uses an extremely small indenter of a hard material and specified shape to press into the surface of a specimen with sufficient force to cause deformation.

Naval Stores. A term applied to the oils, resins, tars, and pitches derived from oleoresin contained in, exuded by, or

extracted from trees, chiefly species of pines (genus *Pinus*). Historically, these were important items in the stores of wood sailing vessels.

Nominal-Size Lumber. (See **Lumber for Dimension**.)

Nonpolar. (See **Polar**.)

Nonpressure Process. Any process of treating wood with a preservative or fire retardant where pressure is not applied. Some examples are surface applications by brushing or brief dipping, soaking in preservative oils, or steeping in solutions of waterborne preservatives; diffusion processes with waterborne preservatives; and vacuum treatments.

Oil Paint. A paint containing a suspension of pigments in an organic solvent and a drying oil, modified drying oil, or synthetic polymer that forms an opaque film through a combination of solvent evaporation and curing of the oil or polymer.

Old Growth. Timber in or from a mature, naturally established forest. When the trees have grown during most if not all of their individual lives in active competition with their companions for sunlight and moisture, this timber is usually straight and relatively free of knots.

Oleoresin. A solution of resin in an essential oil that occurs in or exudes from many plants, especially softwoods. The oleoresin from pine is a solution of pine resin (rosin) in turpentine.

Open Assembly Time. (See **Time, Assembly**.)

Open Grain. (See **Grain**.)

Oriented Strandboard. (See **Wood-Based Composite Panel**.)

Oriented Strand Lumber (OSL). (See **Structural Composite Lumber**.)

Orthotropic. Having unique and independent properties in three mutually orthogonal (perpendicular) planes of symmetry. A special case of anisotropy.

Ovendry Wood. Wood dried to a relatively constant weight in a ventilated oven at 102 to 105 °C (215 to 220 °F).

Overlay. A thin layer of paper, plastic, film, metal foil, or other material bonded to one or both faces of panel products or to lumber to provide a protective or decorative face or a base for painting.

Paint. Any pigmented liquid, liquifiable, or mastic composition designed for application to a substrate in a thin layer that converts to an opaque solid film after application.

Pallet. A low wood or metal platform on which material can be stacked to facilitate mechanical handling, moving, and storage.

Paperboard. The distinction between paper and paperboard is not sharp, but broadly speaking, the thicker (greater than

Glossary

0.3 mm (0.012 in.)), heavier, and more rigid grades of paper are called paperboard.

Papreg. Any of various paper products made by impregnating sheets of specially manufactured high-strength paper with synthetic resin and laminating the sheets to form a dense, moisture-resistant product.

Parallel Strand Lumber (PSL). (See **Structural Composite Lumber.**)

Parenchyma. Short cells having simple pits and functioning primarily in the metabolism and storage of plant food materials. They remain alive longer than the tracheids, fibers, and vessel elements, sometimes for many years. Two kinds of parenchyma cells are recognized—those in vertical strands, known more specifically as axial parenchyma, and those in horizontal series in the rays, known as ray parenchyma.

Particleboard. (See **Wood-Based Composite Panel.**)

Particles. The aggregate component of particleboard manufactured by mechanical means from wood. These include all small subdivisions of wood such as chips, curls, flakes, sawdust, shavings, slivers, strands, wafers, wood flour, and wood wool.

Peck. Pockets or areas of disintegrated wood caused by advanced stages of localized decay in the living tree. It is usually associated with cypress and incense-cedar. There is no further development of peck once the lumber is seasoned.

Peel. To convert a log into veneer by rotary cutting. In an adhesively bonded joint, the progressive separation of a flexible member from either a rigid member or another flexible member.

Phloem. The tissues of the inner bark, characterized by the presence of sieve tubes and serving for the transport of elaborate foodstuffs.

Pile. A long, heavy timber, round or square, that is driven deep into the ground to provide a secure foundation for structures built on soft, wet, or submerged sites (for example, landing stages, bridge abutments).

Pin Knot. (See **Knot.**)

Pitch Pocket. An opening extending parallel to the annual growth rings and containing, or that has contained, pitch, either solid or liquid.

Pitch Streaks. A well-defined accumulation of pitch in a more or less regular streak in the wood of certain conifers.

Pith. The small, soft core occurring near the center of a tree trunk, branch, twig, or log.

Pith Fleck. A narrow streak, resembling pith on the surface of a piece; usually brownish, up to several centimeters long; results from burrowing of larvae in the growing tissues of the tree.

Plainsawn. (See **Grain.**)

Planing Mill Products. Products worked to pattern, such as flooring, ceiling, and siding.

Plank. A broad, thick board laid with its wide dimension horizontal and used as a bearing surface.

Plasticizing Wood. Softening wood by hot water, steam, or chemical treatment to increase its moldability.

Plywood. (See **Wood-Based Composite Panel.**)

Pocket Rot. (See **Decay.**)

Polar. Characteristic of a molecule in which the positive and negative electrical charges are permanently separated, as opposed to nonpolar molecules in which the charges coincide. Water, alcohol, and wood are polar in nature; most hydrocarbon liquids are not.

Polymer. A compound formed by the reaction of simple molecules having functional groups that permit their combination to proceed to high molecular weights under suitable conditions. Polymers may be formed by polymerization (addition polymer) or polycondensation (condensation polymer). When two or more different monomers are involved, the product is called a copolymer.

Polymerization. A chemical reaction in which the molecules of a monomer are linked together to form large molecules whose molecular weight is a multiple of that of the original substance. When two or more different monomers are involved, the process is called copolymerization.

Pore. (See **Vessel Elements.**)

Postformed Plywood. (See **Wood-Based Composite Panel.**)

Post Cure. (1) A treatment (normally involving heat) applied to an adhesive assembly following the initial cure, to complete cure, or to modify specific properties. (2) To expose an adhesive assembly to an additional cure, following the initial cure; to complete cure; or to modify specific properties.

Pot Life. (See **Working Life.**)

Precure. Condition of too much cure, set, or solvent loss of the adhesive before pressure is applied, resulting in inadequate flow, transfer, and bonding.

Preservative. Any substance that, for a reasonable length of time, is effective in preventing the development and action of wood-rotting fungi, borers of various kinds, and harmful insects that deteriorate wood.

Pressure Process. Any process of treating wood in a closed container whereby the preservative or fire retardant is forced into the wood under pressures greater than one atmosphere. Pressure is generally preceded or followed by vacuum, as in the vacuum-pressure and empty-cell processes respectively;

or they may alternate, as in the full-cell and alternating-pressure processes.

Progressive Kiln. (See **Kiln.**)

Psychrometer. An instrument for measuring the amount of water vapor in the atmosphere. It has both a dry-bulb and wet-bulb thermometer. The bulb of the wet-bulb thermometer is kept moistened and is, therefore, cooled by evaporation to a temperature lower than that shown by the dry-bulb thermometer. Because evaporation is greater in dry air, the difference between the two thermometer readings will be greater when the air is dry than when it is moist.

Quartersawn. (See **Grain.**)

Radial. Coincident with a radius from the axis of the tree or log to the circumference. A radial section is a lengthwise section in a plane that passes through the centerline of the tree trunk.

Radiofrequency (RF) Curing. Curing of bondlines by the application of radiofrequency energy. (Sometimes called high-frequency curing.)

Rafter. One of a series of structural members of a roof designed to support roof loads. The rafters of a flat roof are sometimes called roof joists.

Raised Grain. A roughened condition of the surface of dressed lumber in which the hard latewood is raised above the softer earlywood but not torn loose from it.

Rays, Wood. Strips of cells extending radially within a tree and varying in height from a few cells in some species to 4 or more inches in oak. The rays serve primarily to store food and transport it horizontally in the tree. On quartersawn oak, the rays form a conspicuous figure, sometimes referred to as flecks.

Reaction Wood. Wood with more or less distinctive anatomical characters, formed typically in parts of leaning or crooked stems and in branches. In hardwoods, this consists of tension wood, and in softwoods, compression wood.

Relative Humidity. Ratio of the amount of water vapor present in the air to that which the air would hold at saturation at the same temperature. It is usually considered on the basis of the weight of the vapor but, for accuracy, should be considered on the basis of vapor pressures.

Resilience. The property whereby a strained body gives up its stored energy on the removal of the deforming force.

Resin. (1) Solid, semisolid, or pseudosolid resin—An organic material that has an indefinite and often high molecular weight, exhibits a tendency to flow when subjected to stress, usually has a softening or melting range, and usually fractures conchoidally. (2) Liquid resin—an organic polymeric liquid that, when converted to its final state for use, becomes a resin.

Resin Ducts. Intercellular passages that contain and transmit resinous materials. On a cut surface, they are usually inconspicuous. They may extend vertically parallel to the axis of the tree or at right angles to the axis and parallel to the rays.

Retention by Assay. The determination of preservative retention in a specific zone of treated wood by extraction or analysis of specified samples.

Rheology. The study of the deformation and flow of matter.

Ring Failure. A separation of the wood during seasoning, occurring along the grain and parallel to the growth rings. (See **Shake.**)

Ring-Porous Woods. A group of hardwoods in which the pores are comparatively large at the beginning of each annual ring and decrease in size more or less abruptly toward the outer portion of the ring, thus forming a distinct inner zone of pores, known as the earlywood, and an outer zone with smaller pores, known as the latewood.

Ring Shake. (See **Shake.**)

Rip. To cut lengthwise, parallel to the grain.

Roll Spreading. Application of a film of a liquid material to a surface by means of rollers.

Room-Temperature-Setting Adhesive. (See **Adhesive.**)

Rot. (See **Decay.**)

Rotary-Cut Veneer. (See **Veneer.**)

Rough Lumber. (See **Lumber.**)

Sap Stain. (See **Stain.**)

Sapwood. The wood of pale color near the outside of the log. Under most conditions, the sapwood is more susceptible to decay than heartwood.

Sash. A frame structure, normally glazed (such as a window), that is hung or fixed in a frame set in an opening.

Sawn Veneer. (See **Veneer.**)

Saw Kerf. (1) Grooves or notches made in cutting with a saw. (2) That portion of a log, timber, or other piece of wood removed by the saw in parting the material into two pieces.

Scarf Joint. (See **Joint.**)

Schedule, Kiln Drying. A prescribed series of dry- and wet-bulb temperatures and air velocities used in drying a kiln charge of lumber or other wood products.

Seasoning. Removing moisture from green wood to improve its serviceability.

Air Dried—Dried by exposure to air in a yard or shed, without artificial heat.

Kiln Dried—Dried in a kiln with the use of artificial heat.

Glossary

Second Growth. Timber that has grown after the removal, whether by cutting, fire, wind, or other agency, of all or a large part of the previous stand.

Semitransparent Stain. A suspension of pigments in either a drying oil–organic solvent mixture or a water–polymer emulsion, designed to color and protect wood surfaces by penetration without forming a surface film and without hiding wood grain.

Set. A permanent or semipermanent deformation. In reference to adhesives, to convert an adhesive into a fixed or hardened state by chemical or physical action, such as condensation, polymerization, oxidation, vulcanization, gelation, hydration, or evaporation of volatile constituents.

Shake. A separation along the grain, the greater part of which occurs between the rings of annual growth. Usually considered to have occurred in the standing tree or during felling.

Shakes. In construction, shakes are a type of shingle usually hand cleft from a bolt and used for roofing or weatherboarding.

Shaving. A small wood particle of indefinite dimensions developed incidental to certain woodworking operations involving rotary cutterheads usually turning in the direction of the grain. This cutting action produces a thin chip of varying thickness, usually feathered along at least one edge and thick at another and generally curled.

Shear. In an adhesively bonded joint, stress, strain, or failure resulting from applied forces that tends to cause adjacent planes of a body to slide parallel in opposite directions.

Sheathing. The structural covering, usually of boards, building fiberboards, plywood, or oriented strandboard, placed over exterior studding or rafters of a structure.

Shelf Life. (See **Storage Life.**)

Shiplapped Lumber. (See **Lumber.**)

Shipping-Dry Lumber. (See **Lumber.**)

Shop Lumber. (See **Lumber.**)

Side Grained. (See **Grain.**)

Side Lumber. (See **Lumber.**)

Siding. The finish covering of the outside wall of a frame building, whether made of horizontal weatherboards, vertical boards with battens, shingles, or other material.

Slash Grained. (See **Grain.**)

Sliced Veneer. (See **Veneer.**)

Soft Rot. (See **Decay.**)

Softwoods. Generally, one of the botanical groups of trees that have no vessels and in most cases have needlelike or scalelike leaves, the conifers, also the wood produced by

such trees. The term has no reference to the actual hardness of the wood.

Solid Color Stains (Opaque Stains). A suspension of pigments in either a drying oil–organic solvent mixture or a water–polymer emulsion designed to color and protect a wood surface by forming a film. Solid color stains are similar to paints in application techniques and in performance.

Solids Content. The percentage of weight of the nonvolatile matter in an adhesive.

Solvent Adhesive. (See **Adhesive.**)

Sound Knot. (See **Knot.**)

Specific Adhesion. Adhesion between surfaces that are held together by valence forces of the same type as those that give rise to cohesion.

Specific Gravity. As applied to wood, the ratio of the oven-dry weight of a sample to the weight of a volume of water equal to the volume of the sample at a specified moisture content (green, air dry, or oven-dry).

Spike Knot. (See **Knot.**)

Spiral Grained. (See **Grain.**)

Spread. The quantity of adhesive per unit joint area applied to an adherend. (See **Lbs/MSGL.**)

Single spread—Refers to application of adhesive to only one adherend of a joint.

Double spread—Refers to application of adhesive to both adherends of a joint.

Squeezeout. Bead of adhesive squeezed out of a joint when pressure is applied.

Stain. A discoloration in wood that may be caused by such diverse agencies as micro-organisms, metal, or chemicals. The term also applies to materials used to impart color to wood.

Blue Stain—A bluish or grayish discoloration of the sapwood caused by the growth of certain dark-colored fungi on the surface and in the interior of the wood; made possible by the same conditions that favor the growth of other fungi.

Brown Stain—A rich brown to deep chocolate-brown discoloration of the sapwood of some pines caused by a fungus that acts much like the blue-stain fungi.

Chemical Brown Stain—A chemical discoloration of wood, which sometimes occurs during the air drying or kiln drying of several species, apparently caused by the concentration and modification of extractives.

Sap Stain—A discoloration of the sapwood caused by the growth of certain fungi on the surface and in the interior of the wood; made possible by the same conditions that favor the growth of other fungi.

Sticker Stain—A brown or blue stain that develops in seasoning lumber where it has been in contact with the stickers.

Starved Joint. (See **Joint.**)

Static Bending. Bending under a constant or slowly applied load; flexure.

Staypak. Wood that is compressed in its natural state (that is, without resin or other chemical treatment) under controlled conditions of moisture, temperature, and pressure that practically eliminate springback or recovery from compression. The product has increased density and strength characteristics.

Stickers. Strips or boards used to separate the layers of lumber in a pile and thus improve air circulation.

Sticker Stain. (See **Stain.**)

Storage Life. The period of time during which a packaged adhesive can be stored under specific temperature conditions and remain suitable for use. Sometimes called shelf life.

Straight Grained. (See **Grain.**)

Strand. (1) A type of wood flake with a high aspect ratio which allows for orientation. It is used in oriented strand board, oriented strand lumber, and laminated strand lumber. (2) A wood element with a high aspect ratio manufactured from veneer. It is used in parallel strand lumber.

Strength. (1) The ability of a member to sustain stress without failure. (2) In a specific mode of test, the maximum stress sustained by a member loaded to failure.

Strength Ratio. The hypothetical ratio of the strength of a structural member to that which it would have if it contained no strength-reducing characteristics (such as knots, slope-of-grain, shake).

Stress-Wave Timing. A method of measuring the apparent stiffness of a material by measuring the speed of an induced compression stress as it propagates through the material.

Stressed-Skin Construction. A construction in which panels are separated from one another by a central partition of spaced strips with the whole assembly bonded so that it acts as a unit when loaded.

Stringer. A timber or other support for cross members in floors or ceilings. In stairs, the support on which the stair treads rest.

Structural Composite Lumber (SCL). (Wood elements glued together to form products that are similar in size to solid-sawn lumber)

Laminated Strand Lumber (LSL)—Similar to oriented strand lumber with somewhat longer strands.

Laminated Veneer Lumber (LVL)—Structural composite lumber manufactured from veneers laminated

into a panel with the grain of all veneer running parallel to each other. The resulting panel is ripped to common lumber dimensions.

Oriented Strand Lumber (OSL)—Structural composite lumber made from wood strand elements similar to those used in oriented strand board. The strands are oriented primarily along the length of the member.

Parallel Strand Lumber (PSL)—Structural composite lumber made from high aspect ratio wood strand elements manufactured from veneer oriented primarily along the length of the member. It is manufactured in billets and cut to lumber dimensions.

Structural Lumber. (See **Lumber.**)

Structural Timbers. Pieces of wood of relatively large size, the strength or stiffness of which is the controlling element in their selection and use. Examples of structural timbers are trestle timbers (stringers, caps, posts, sills, bracing, bridge ties, guardrails); car timbers (car framing, including upper framing, car sills); framing for building (posts, sills, girders); ship timber (ship timbers, ship decking); and crossarms for poles.

Stud. One of a series of slender wood structural members used as supporting elements in walls and partitions.

Substrate. A material upon the surface of which an adhesive-containing substance is spread for any purpose, such as bonding or coating. A broader term than adherend. (See **Adherend.**)

Surface Inactivation. In adhesive bonding to wood, physical and chemical modifications of the wood surface that result in reduced ability of an adhesive to properly wet, flow, penetrate, and cure.

Surface Tension. The force per unit length acting in the surface of a liquid that opposes the increase in area of the liquid (spreading).

Surfaced Lumber. (See **Lumber.**)

Symmetrical Construction. Panels in which the plies on one side of a center ply or core are essentially equal in thickness, grain direction, properties, and arrangement to those on the other side of the core.

Tack. The property of an adhesive that enables it to form a bond of measurable strength immediately after adhesive and adherend are brought into contact under low pressure.

Tangential. Strictly, coincident with a tangent at the circumference of a tree or log, or parallel to such a tangent. In practice, however, it often means roughly coincident with a growth ring. A tangential section is a longitudinal section through a tree or limb perpendicular to a radius. Flat-grained lumber is sawed tangentially.

Temperature, Curing. The temperature to which an adhesive or an assembly is subjected to cure the adhesive. The

Glossary

temperature attained by the adhesive in the process of curing (adhesive curing temperature) may differ from the temperature of the atmosphere surrounding the assembly (assembly curing temperature).

Temperature, Setting. (See **Temperature, Curing.**)

Tenon. A projecting member left by cutting away the wood around it for insertion into a mortise to make a joint.

Tension. In an adhesively bonded joint, a uniaxial force tending to cause extension of the assembly, or the counteracting force within the assembly that resists extension.

Tension Wood. Abnormal wood found in leaning trees of some hardwood species and characterized by the presence of gelatinous fibers and excessive longitudinal shrinkage. Tension wood fibers hold together tenaciously, so that sawed surfaces usually have projecting fibers and planed surfaces often are torn or have raised grain. Tension wood may cause warping.

Texture. A term often used interchangeably with grain. Sometimes used to combine the concepts of density and degree of contrast between earlywood and latewood. In this handbook, texture refers to the finer structure of the wood rather than the annual rings. (See also **Grain.**)

Thermoplastic. (1) Capable of being repeatedly softened by heat and hardened by cooling. (2) A material that will repeatedly soften when heated and harden when cooled.

Thermoset. A cross-linked polymeric material.

Thermosetting. Having the property of undergoing a chemical reaction by the action of heat, catalyst, ultraviolet light, and hardener, leading to a relatively infusible state.

Timbers, Round. Timbers used in the original round form, such as poles, piling, posts, and mine timbers.

Timber, Standing. Timber still on the stump.

Timbers. (See **Lumber.**)

Time, Assembly. The time interval between the spreading of the adhesive on the adherend and the application of pressure or heat, or both, to the assembly. (For assemblies involving multiple layers or parts, the assembly time begins with the spreading of the adhesive on the first adherend.)

Open Assembly Time—The time interval between the spreading of the adhesive on the adherend and the completion of assembly of the parts for bonding.

Closed Assembly Time—The time interval between completion of assembly of the parts for bonding and the application of pressure or heat, or both, to the assembly.

Time, Curing. The period during which an assembly is subjected to heat or pressure, or both, to cure the adhesive.

Time, Setting. (See **Time, Curing.**)

Toughness. A quality of wood that permits the material to absorb a relatively large amount of energy, to withstand repeated shocks, and to undergo considerable deformation before breaking.

Tracheid. The elongated cells that constitute the greater part of the structure of the softwoods (frequently referred to as fibers). Also present in some hardwoods.

Transfer. In wood bonding, the sharing of adhesive between a spread and an unspread surface when the two adherends are brought into contact.

Transverse. Directions in wood at right angles to the wood fibers. Includes radial and tangential directions. A transverse section is a section through a tree or timber at right angles to the pith.

Treenail. A wooden pin, peg, or spike used chiefly for fastening planking and ceiling to a framework.

Trim. The finish materials in a building, such as moldings, applied around openings (window trim, door trim) or at the floor and ceiling of rooms (baseboard, cornice, and other moldings).

Truss. An assembly of members, such as beams, bars, rods, and the like, so combined as to form a rigid framework. All members are interconnected to form triangles.

Twist. A distortion caused by the turning or winding of the edges of a board so that the four corners of any face are no longer in the same plane.

Tyloses. Masses of parenchyma cells appearing somewhat like froth in the pores of some hardwoods, notably the white oaks and black locust. Tyloses are formed by the extension of the cell wall of the living cells surrounding vessels of hardwood.

Ultrasonics. (See **Stress-Wave Timing.**)

van der Waal Forces. Physical forces of attraction between molecules, which include permanent dipole, induced dipole, hydrogen bond, and London dispersion forces.

Vapor Retarder. A material with a high resistance to vapor movement, such as foil, plastic film, or specially coated paper, that is used in combination with insulation to control condensation.

Veneer. A thin layer or sheet of wood.

Rotary-Cut Veneer—Veneer cut in a lathe that rotates a log or bolt, chucked in the center, against a knife.

Sawn Veneer—Veneer produced by sawing.

Sliced Veneer—Veneer that is sliced off a log, bolt, or flitch with a knife.

Vertical Grained. (See **Grain.**)

Vessel Elements. Wood cells in hardwoods of comparatively large diameter that have open ends and are set one above the other to form continuous tubes called vessels. The openings of the vessels on the surface of a piece of wood are usually referred to as pores.

Virgin Growth. The growth of mature trees in the original forests.

Viscoelasticity. The ability of a material to simultaneously exhibit viscous and elastic responses to deformation.

Viscosity. The ratio of the shear stress existing between laminae of moving fluid and the rate of shear between these laminae.

Wane. Bark or lack of wood from any cause on edge or corner of a piece except for eased edges.

Warp. Any variation from a true or plane surface. Warp includes bow, crook, cup, and twist, or any combination thereof.

Water Repellent. A liquid that penetrates wood that materially retards changes in moisture content and dimensions of the dried wood without adversely altering its desirable properties.

Water-Repellent Preservative. A water repellent that contains a preservative that, after application to wood and drying, accomplishes the dual purpose of imparting resistance to attack by fungi or insects and also retards changes in moisture content.

Weathering. The mechanical or chemical disintegration and discoloration of the surface of wood caused by exposure to light, the action of dust and sand carried by winds, and the alternate shrinking and swelling of the surface fibers with the continual variation in moisture content brought by changes in the weather. Weathering does not include decay.

Wet Strength. The strength of an adhesive joint determined immediately after removal from water in which it has been immersed under specified conditions of time, temperature, and pressure.

Wet-Bulb Temperature. The temperature indicated by the wet-bulb thermometer of a psychrometer.

Wettability. A condition of a surface that determines how fast a liquid will wet and spread on the surface or if it will be repelled and not spread on the surface.

Wetting. The process in which a liquid spontaneously adheres to and spreads on a solid surface.

White-Rot. (See **Decay.**)

Wood-Based Composite Panel. A generic term for a material manufactured from wood veneer, strands, flakes, particles, or fibers or other lignocellulosic material and a synthetic resin or other binder.

Cellulosic Fiberboard—A generic term for a low-density panel made from lignocellulosic fibers characterized by an integral bond produced by interfelted of the fibers, to which other materials may have been added during manufacture to improve certain properties, but which has not been consolidated under heat and pressure as a separate stage in manufacture; has a density of less than 496 kg m⁻³ (31 lb ft⁻³) (specific gravity 0.50) but more than 160 kg m⁻³ (10 lb ft⁻³) (specific gravity 0.16).

Exterior Plywood—A general term for plywood bonded with a type of adhesive that by systematic tests and service records has proved highly resistant to weather; microorganisms; cold, hot, and boiling water; steam; and dry heat.

Fiberboard—A generic term inclusive of panel products of various densities manufactured of refined or partially refined wood (or other lignocellulosic) fibers. Bonding agents may be added.

Flakeboard—A generic term indicating a manufactured panel product composed of flakes bonded with a synthetic resin.

Hardboard—A generic term for a panel manufactured primarily from interfelted lignocellulosic fibers (usually wood), consolidated under heat and pressure in a hot press to a density of 496 kg m⁻³ (31 lb ft⁻³) or greater. May be manufactured using either a dry-process or wet-process.

Interior Plywood—A general term for plywood manufactured for indoor use or in construction subjected to only temporary moisture. The adhesive used may be interior, intermediate, or exterior.

Medium-Density Fiberboard—A dry-process fiberboard manufactured from lignocellulosic fibers combined with a synthetic resin or other suitable binder. The panels are manufactured to a density of 496 kg m⁻³ (31 lb ft⁻³) (0.50 specific gravity) to 880 kg m⁻³ (55 lb ft⁻³) (0.88 specific gravity) by the application of heat and pressure by a process in which the interfiber bond is substantially created by the added binder.

Oriented Strandboard—A type of flakeboard product composed of strand-type flakes that are purposefully aligned in directions that make a panel stronger, stiffer, and with improved dimensional properties in the alignment directions than a panel with random flake orientation.

Particleboard—A panel product manufactured from wood particles usually in three layers. For good surface characteristics, the outer layers have smaller particles and the interior uses coarser particles. The particles in the core may or may not be aligned.

Plywood—A glued wood panel made up of relatively thin layers of veneer with the grain of adjacent layers at right

Glossary

angles or of veneer in combination with a core of lumber or of reconstituted wood. The usual constructions have an odd number of layers.

Wood Failure. The rupturing of wood fibers in strength tests of bonded joints usually expressed as the percentage of the total area involved that shows such failure. (See **Failure, Adherend.**)

Wood Flour. Wood reduced to finely divided particles, approximately the same as those of cereal flours in size, appearance, and texture, and passing a 40 to 100 mesh screen.

Wood Substance. The solid material of which wood is composed. It usually refers to the extractive-free solid substance of which the cell walls are composed, but this is not always true. There is not a wide variation in chemical composition or specific gravity between the wood substance of various species. (The characteristic differences of species are largely due to differences in extractives and variations in relative amounts of cell walls and cell cavities.)

Wood-Thermoplastic Composite. Manufactured composite materials consisting primarily of wood elements and thermoplastic. The wood element may either serve as a reinforcement or filler in a continuous thermoplastic matrix, or the thermoplastic may act as a binder to the wood element.

Wood Wool. Long, curly, slender strands of wood used as an aggregate component for some particleboards and cement-bonded composites. Sometimes referred to as excelsior.

Workability. The degree of ease and smoothness of cut obtainable with hand or machine tools.

Working Life. The period of time during which an adhesive, after mixing with catalyst, solvent, or other compounding ingredients, remains suitable for use. Also called pot life.

Working Properties. The properties of an adhesive that affect or dictate the manner of application to the adherends to be bonded and the assembly of the joint before pressure application (such as viscosity, pot life, assembly time, setting time).

Xylem. The portion of the tree trunk, branches, and roots that lies between the pith and the cambium (that is the wood).

Yard Lumber. (See **Lumber.**)

- Accelerated air-drying, 13-6
- Acid copper chromate (ACC):
 components, 15-3
 effectiveness and leaching, 15-3
 retention levels for various wood products, 15-4t
 Southern pine sapwood stakes retention and life span test results, 15-7t to 15-8t
 temperature for pressure treating, 15-20
- Adherends:
 bond strength properties, 10-21
 density and porosity, 10-6
 ease of bonding by species, 10-7t
 extractives on surface, effect on, 10-4
 knife- and abrasive-planed surfaces, 10-2 to 10-3, 10-3fig
 mechanical testing of bonded assemblies, 10-20 to 10-21
 moisture content:
 and dimensional change, 10-6 to 10-7
 control, 10-14 to 10-15
 U.S. averages, 10-15, 10-15fig
 surface preparation, 10-15
 surface properties, 10-2 to 10-3
 veneer surfaces, 10-3 to 10-4
 wettability, 10-4
 wood and nonwood composites, 10-5
- Adhesives:
 affected by:
 physical properties, 10-5 to 10-8
 surface properties, 10-5
 wood density, 10-6
 wood moisture content, 10-6
 wood porosity, 10-8
 analytic chemical and mechanical testing of polymers, 10-20 to 10-21
 assembly and pressing, 10-16 to 10-17, 10-17fig
 composition, 10-8 to 10-9
 consistency, effect of, 10-16 to 10-17, 10-17fig
 definition, 10-1
 ease of bonding by species, 10-7t
 form and color of types, 10-11t to 10-13t
 health and safety, 10-14
 mechanical testing of bonded assemblies, 10-20 to 10-21
 post-cure conditioning, 10-17
 preparation and application, 10-11t to 10-13t
 quality assurance programs, 10-22
 short- and long-term performance, 10-21 to 10-22, 10-22fig
 selection, 10-10 to 10-14
 spreading, 10-15, 10-16fig
 strength and durability, 10-9 to 10-10, 10-10t, 10-11t to 10-13t
 strength properties, 10-21
 uses, 10-1, 10-11t to 10-13t
 use on veneers, 10-3 to 10-4
 use on wood and nonwood composites, 10-5
 use with chemically modified wood, 10-4
 use with fire-retardant-treated woods, 10-4
 use with preservative-treated wood, 10-4
 working life, 10-10, 10-14
- Adjustment of properties for design use, 7-10 to 7-13
- Advantages of using wood for structures, 2-2
- Afara. *See* Limba
- Aformosia:
 characteristics, 2-19
 decay resistance, 2-19
 ease of bonding, 10-7t
 locality of growth, 2-19
 mechanical properties, 5-18t, 5-22t
 shrinkage values, 4-8t
 uses, 2-19
- Air-drying advantages and limitations, 13-6
- Albarco:
 characteristics, 2-19
 locality of growth, 2-19
 mechanical properties, 5-18t, 5-22t
 shrinkage values, 4-8t
 uses, 2-19
 workability, 2-19
- Alder, red:
 characteristics, 2-3
 characteristics for painting, 16-5t
 decay resistance, 14-5t
 dimensional change coefficient, 13-16t
 ease of bonding, 10-7t
 erosion of planed surfaces, 16-12t
 locality of growth, 2-3
 moisture content, 4-2t
 nomenclature, 6-5t
 shock resistance, 2-3
 shrinkage values, 4-6t
 strength properties, 5-4t, 5-9t
 uses, 2-3
- Alkaline copper quat (ACQ):
 common types, 15-5
 composition of common types, 15-6t
 retention levels for various wood products, 15-4t
 uses, 15-5
- Alkyl ammonium compound:
 effectiveness, 15-12
 in ammoniacal copper quat, 15-5
 solubility, 15-9
- Almon. *See* Meranti
- Alpha paper, 19-12
- Amaranth. *See* Purpleheart
- American Lumber Standard Committee (ALSC):
 accepting design values for foreign species, 7-3, 7-4t
 design properties, 7-4
 stress grading, 7-2 to 7-3
- American Society of Testing and Materials (ASTM):
 calculating design properties, 7-8 to 7-9
 calculating strength ratios, 7-3
 calculating wood properties for visual stress grades, 7-3
 critical radiant flux of floorcovering systems using a radiant heat energy source (ASTM E 648), 18-5
 related test methods, 18-8 to 18-9
 cone calorimeter (ASTM E 1354), 18-6, 18-7
 fire tests of roof covering (ASTM E 108), 18-3
 fire-resistance test (ASTM E 119), 18-6 to 18-7
 flame spread (ASTM E 84), 18-3 to 18-5, 18-4t, 18-6, 18-12
 flame spread index for solid sawn lumber, 18-4t
 NBS smoke chamber (ASTM E 662), 18-6
- American Softwood Lumber Standard, 6-2, 6-7, 6-8, 7-2
- American standard lumber sizes, 6-10, 6-11t
- American Wood Preservers' Association:
 fire-retardant-treated wood, 18-16 to 18-17
- Ammonia for plasticizing wood, 19-2
- Ammoniacal copper citrate (CC):
 retention levels for various wood products, 15-4t
 solution percentages, 15-9
 temperature for pressure treating, 15-18
- Ammoniacal copper zinc arsenate (ACZA):
 composition, 15-3
 replacement for ACA, 15-3
 retention levels for various wood products, 15-4t
 temperature for pressure treating, 15-18
 uses, 15-3
 use with Douglas-fir, 15-3
- Anani. *See* Manni
- Anaura. *See* Marishballi
- Andiroba:
 characteristics, 2-19
 decay resistance, 14-5t
 dimensional change coefficient, 13-17t
 durability, 2-19
 ease of bonding, 10-7t
 locality of growth, 2-19
 mechanical properties, 5-18t, 5-22t

- nomenclature, 2-19, 2-43t
 resistance to decay and insects, 2-19
 shrinkage values, 4-8t
 uses, 2-19
 workability, 2-19
- Angelin (*See also* Sucupira):
 ease of bonding, 10-7t
 mechanical properties, 5-18t, 5-22t
 shrinkage values, 4-8t
- Angelique:
 characteristics, 2-19 to 2-20
 decay resistance, 14-5t
 dimensional change coefficient, 13-17t
 ease of bonding, 10-7t
 machining properties, 2-20
 mechanical properties, 5-18t, 5-22t
 resistance to decay and insects, 2-20
 shrinkage values, 4-8t
 uses, 2-20
- Animal adhesives:
 structural performance, 10-10t
 working and strength properties, and
 uses, 10-11t to 10-13t
- Ants, carpenter, 14-13
- Annual growth rings. *See* Growth rings
- Apa. *See* Wallaba
- Apamate. *See* Roble
- Apitong. (*See also* Keruing):
 dimensional change coefficient, 13-17t
 shrinkage values, 4-8t
- Apple:
 dimensional change coefficient, 13-16t
 moisture content, 4-2t
- Ash:
 decay resistance, 14-5t
 for flooring, 6-4, 6-6
- Ash, black:
 characteristics, 2-3
 dimensional change coefficient, 13-16t
 locality of growth, 2-3
 moisture content, 4-2t
 nomenclature, 6-5t
 shrinkage values, 4-6t
 species, 2-3
 specific gravity, 2-3
 strength properties, 5-4t, 5-9t
 thermal conductivity, 4-13t
 uses, 2-3
- Ash, blue:
 shrinkage values, 4-6t
 strength properties, 5-4t, 5-9t
- Ash, green:
 dimensional change coefficient, 13-16t
 moisture content, 4-2t
 penetration, 15-16t
 shrinkage values, 4-6t
 strength properties, 5-4t, 5-9t
- Ash, Oregon:
 dimensional change coefficient, 13-16t
 nomenclature, 6-5t
 shrinkage values, 4-6t
- strength properties, 5-4t, 5-9t
- Ash, pumpkin:
 dimensional change coefficient, 13-16t
 shrinkage values, 4-6t
- Ash, white:
 characteristics, 2-3 to 2-4
 characteristics for painting, 16-5t
 connector joint strength, 8-21t
 dimensional change coefficient, 13-16t
 ease of bonding, 10-7t
 elastic ratio, 5-2t
 locality of growth, 2-3
 moisture content, 4-2t, 5-34t
 nomenclature, 6-5t
 penetration, 15-16t
 Poisson ratio, 5-3t
 shrinkage values, 4-6t
 shock resistance, 2-3
 species, 2-3
 thermal conductivity, 4-13t
 uses, 2-4
- Aspen:
 characteristics, 2-4
 connector joint strength, 8-21t
 decay resistance, 14-5t
 ease of bonding, 10-7t
 locality of growth, 2-4
 moisture content, 4-2t
 nomenclature, 6-5t
 shock resistance, 2-4
 species, 2-4
 uses, 2-4
 workability, 2-4
- Aspen, bigtooth:
 characteristics for painting, 16-5t
 mechanical properties, 5-14t, 5-16t
 penetration, 15-16t
 shrinkage values, 4-6t
 strength properties, 5-4t, 5-9t
 thermal conductivity, 4-13t
- Aspen, quaking:
 dimensional change coefficient, 13-16t
 mechanical properties, 5-14t, 5-16t
 Poisson ratio, 5-3t
 shrinkage values, 4-6t
 strength properties, 5-4t, 5-9t
 thermal conductivity, 4-13t
- Avodire:
 characteristics, 2-20
 decay resistance, 14-5t
 dimensional change coefficient, 13-17t
 ease of bonding, 10-7t
 locality of growth, 2-20
 mechanical properties, 5-18t, 5-22t
 shrinkage values, 4-8t
 shock resistance, 2-20
 uses, 2-20
 workability, 2-20
- Axial load, deformation, 9-1, 9-1eq
- Azobe:
 characteristics, 2-20
- decay resistance, 14-5t
 ease of bonding, 10-7t
 locality of growth, 2-20
 mechanical properties, 5-18t, 5-22t
 resistance to decay and insects, 2-20
 marine borers, 14-13 to 14-15
 shrinkage values, 4-8t
 workability, 2-20
 uses, 2-20
- Bacteria causing decay, 14-9
- Back priming, 16-25
- Bagtikan. *See* Seraya, white
- Balata:
 characteristics, 2-20
 decay resistance, 14-5t
 ease of bonding, 10-7t
 locality of growth, 2-20
 resistance to decay and insects, 2-20
 shrinkage values, 4-8t
 uses, 2-20
 workability, 2-20
- Balau:
 characteristics, 2-21
 decay resistance, 14-5t
 ease of bonding, 10-7t
 locality of growth, 2-21
 species, 2-21
 uses, 2-21
- Baldcypress:
 characteristics, 2-11
 characteristics for painting, 16-5t
 connector joint strength, 8-21t
 decay resistance, 14-5t
 dimensional change coefficient, 13-16t
 elastic ratio, 5-2t
 flame spread index, 18-4t
 locality of growth, 2-11
 moisture content, 4-2t
 nomenclature, 6-13t
 pecky cypress, 2-11
 penetration, 15-16t
 Poisson ratio, 5-3t
 tensile strength, 5-26t
 thermal conductivity, 4-14t
 uses, 2-11
- Balsa:
 characteristics, 2-21, 2-44t
 decay resistance, 14-5t
 dimensional change coefficient, 13-17t
 ease of bonding, 10-7t
 elastic ratio, 5-2t
 locality of growth, 2-21
 mechanical properties, 5-18t, 5-22t
 Poisson ratio, 5-3t
 shrinkage values, 4-8t
 uses, 2-21
- Banak:
 characteristics, 2-21
 decay resistance, 14-5t

Index

- dimensional change coefficient, 13-17t
- ease of bonding, 10-7t
- locality of growth, 2-21
- machining properties, 2-21
- mechanical properties, 5-18t, 5-22t
- nomenclature, 2-21, 2-44t
- resistance to decay and insects, 2-21
- shrinkage values, 4-8t
- uses, 2-21
- Bark:
 - growth, 3-2
 - inner and outer, 3-2fig
- Basswood:
 - characteristics, 2-4
 - characteristics for painting, 16-5t
 - charring rate data, 18-14t
 - connector joint strength, 8-21t
 - decay resistance, 14-5t
 - ease of bonding, 10-7t
 - elastic ratio, 5-2t
 - flammability data, 18-4t
 - locality of growth, 2-4
 - machinability, 2-4
 - moisture content, 4-2t
 - nomenclature, 6-5t
 - strength properties, 5-4t, 5-9t
 - in wood-polymer composites, 19-11t
 - thermal conductivity, American, 4-13t
 - uses, 2-4
 - workability, 2-4
- Basswood, American:
 - dimensional change coefficient, 13-16t
 - penetration, 15-16t
 - shrinkage values, 4-6t
 - strength properties, 5-4t, 5-9t
- Bastard sawn lumber, definition, 3-14
- Beams:
 - bending deflection, 9-3 to 9-4, 9-2eq, 9-2t, 9-4eq
 - bending stress, 9-4, 9-5eq, 9-9
 - combined bending and axial load, effect of, 9-3, 9-6
 - compressive stress, 9-4
 - deformation, 9-1 to 9-4
 - end loading, effect of, 9-6
 - lateral buckling, 9-9 to 9-10, 9-9eq, 9-9t
 - modulus of rupture, 9-4, 9-4eq
 - notches and holes, effect of, 9-2, 9-6 to 9-7
 - shear deflection, 9-2, 9-2eq, 9-2t
 - shear stress, 9-4, 9-4eq
 - size, effect on strength, 9-5, 9-5eq, 9-6eq
 - size, effects on modulus of rupture, 9-5, 9-6eq
 - stability, 9-7 to 9-10
 - tapered beams:
 - bending stress, 9-5 to 9-6, 9-5eq
 - deflections, 9-3, 9-3eq, 9-3fig
 - glulam combinations, 11-17 to 11-18
 - shear stresses, 9-4 to 9-6, 9-5fig
- tensile, stress, 9-4, 9-4eq
- time, effect of, 9-2, 9-7
- twist, 9-4, 9-4eq
- waterponding, effect of, 9-2, 9-3eq, 9-6, 9-8, 9-8eq
- Beech:
 - characteristics for painting, 16-5t
 - decay resistance, 14-5t
 - for flooring, 6-4, 6-6
 - nomenclature, 6-5t
 - penetration, 15-16t
- Beech, American:
 - characteristics, 2-4
 - connector joint strength, 8-21t
 - dimensional change coefficient, 13-16t
 - ease of bonding, 10-7t
 - locality of growth, 2-4
 - machinability, 2-4
 - moisture content, 4-2t
 - shock resistance, 2-4
 - shrinkage values, 4-6t
 - strength properties, 5-4t, 5-9t
 - tensile strength, 5-26t
 - thermal conductivity, 4-13t
 - uses, 2-4
- Bees, carpenter, 14-13
- Beetles:
 - ambrosia beetles, 14-9 to 14-10
 - damage caused by, 14-8t
 - bark beetles, 14-9
 - old house borers, 14-10
 - damage caused by, 14-8t
 - powder-post beetles, 14-10
 - damage caused by, 14-9fig, 14-8t
- Bending:
 - creep, 5-39
 - strength and temperature, 5-37t
- Bending of glulam, 11-17
- Bending properties, affected by temperature, 5-37, 5-37t
- Bending stiffness:
 - bending strength, stress grading, 7-6
- Bending stress:
 - derivations for machine-graded lumber, 7-8 to 7-10, 7-12fig
- Bending of wood:
 - apparatus, 19-4
 - chemicals used, 19-2
 - fixing the bend, 19-4
 - moisture content of stock, 19-3 to 19-4
 - principles of plasticizing and bending, 19-1
 - selection of stock, 19-3
 - solid members, 19-3, 19-3fig
 - steaming, 19-1
- Benge:
 - characteristics, 2-21
 - decay resistance, 14-5t
 - ease of bonding, 10-7t
 - mechanical properties, 5-18t, 5-22t
 - nomenclature, 2-21
 - shrinkage values, 4-8t
 - uses, 2-22
 - workability, 2-21
- Bent wood members:
 - characteristics, 19-4
 - solid wood members, species used, 19-3
 - uses, 19-2
- Birch:
 - connector joint strength, 8-21t
 - decay resistance, 14-5t
 - for casing and base, 6-17
 - for flooring, 6-4, 6-6
 - heat release data, 18-12fig
 - nomenclature, 6-5t
- Birch, gray, shrinkage values, 4-6t
- Birch, paper:
 - characteristics, 2-4 to 2-5
 - dimensional change coefficient, 13-16t
 - locality of growth, 2-5
 - moisture content, 4-2t
 - shrinkage values, 4-6t
 - strength properties, 5-4t, 5-9t
 - uses, 2-5
- Birch, river:
 - dimensional change coefficient, 13-16t
 - penetration, 15-16t
 - shrinkage values, 4-6t
- Birch, sweet:
 - characteristics, 2-5
 - dimensional change coefficient, 13-16t
 - ease of bonding, 10-7t
 - locality of growth, 2-5
 - moisture content, 4-2t
 - penetration, 15-16t
 - shock resistance, 2-5
 - shrinkage values, 4-6t
 - strength properties, 5-4t, 5-9t
 - thermal conductivity, 4-13t
 - uses, 2-5
- Birch, yellow:
 - characteristics, 2-5
 - characteristics for painting, 16-5t
 - dimensional change coefficient, 13-16t
 - ease of bonding, 10-7t
 - elastic ratio, 5-2t
 - flame spread index, 18-4t
 - laminated:
 - strength properties, 19-7t to 19-8t
 - thermal expansion coefficients, 19-8t
 - locality of growth, 2-5
 - moisture content, 4-2t, 5-34t
 - Poisson ratio, 5-3t
 - penetration, 15-16t
 - shrinkage values, 4-6t
 - shock resistance, 2-5
 - strength properties, 5-4t, 5-9t
 - thermal conductivity, 4-13t
 - toughness values, 5-27t
 - uses, 2-5

- Bird peck:
 description, 5-33
 effect on strength, 5-33
 species involved, 5-33
- Black locust. *See* Locust, black
- Blood adhesive, working and strength properties, and uses, 10-11t to 10-13t
- Blue stain, description, 14-2
- Boats, wood:
 control of decay in, 14-9
 control of marine borers, 14-14 to 14-15
 use of varnish on, 16-25
- Bolts:
 bearing stress of wood under:
 bolt diameter, effect perpendicular to grain, 8-15fig
 intermediate angle to grain loading, 8-14, 8-13fig
 L/D ratios, 8-14
 parallel to grain loading, 8-14, 8-14fig
 perpendicular to grain loading, 8-14, 8-14fig
 bearing stress with steel side plates, 8-15
 bolt holes, effect on, 8-16 to 8-17, 8-16fig
 bolt quality, effect on joint strength, 8-15, 8-14fig, 8-15fig
 drift, 8-10
 member thickness, effect of, 8-15, 8-15fig
 multiple bolt joints, 8-15 to 8-16
 pre-1991 allowable loads:
 parallel to grain, 8-17 to 8-18, 8-17t
 perpendicular to grain, 8-17, 8-18t, 8-19eq
 post-1991 yield model, 8-17, 8-19eq, 8-19t
 spacing, edge and end distance, 8-16
- Bondability:
 of metals and plastics to wood, 10-5
 of wood species, 10-6, 10-7t
- Bonded joints:
 basic stress modes, 10-20 to 10-21
 construction joints, 10-19 to 10-20, 10-19fig
 edge-grain joints, 10-18, 10-18fig
 end-grain joints, 10-18, 10-18fig
 end-to-edge grain joints, 10-18, 10-18fig
 mechanical testing of, 10-19 to 10-21
- Bonding:
 adhesive selection, 10-10 to 10-15
 assembly and pressing, 10-16 to 10-17, 10-17fig
 effect of:
 moisture content and dimensional change, 10-14 to 10-15
 wood density, 10-5 to 10-6
 wood porosity, 10-6
 elements of, 10-1 to 10-2
 moisture content control, 10-14 to 10-16
- quality assurance programs, 10-22
 short- and long-term performance of adhesives, 10-21 to 10-22, 10-22fig
 strength and durability of adhesives, 10-9 to 10-10, 10-10t, 10-18
 strength properties of adhesives, 10-21
 surface preparation, 10-15
 with veneers, 10-3 to 10-4
 wettability of wood, 10-2, 10-4fig
 wood and nonwood composites, 10-5
- Boxelder, nomenclature, 6-5t
- Box nails, 8-2, 8-2t
- Bridges, 17-8 to 17-9, 17-9fig
- Brown rot, 14-4
- Bubinga (*See also* Bengé):
 decay resistance, 14-5t
 ease of bonding, 10-7t
 mechanical properties, 5-18t, 5-22t
 shrinkage values, 4-8t
- Buckeye:
 characteristics, 2-5
 decay resistance, 14-5t
 dimensional change coefficient, 13-16t
 locality of growth, 2-5
 machinability, 2-5
 nomenclature, 6-5t
 shock resistance, 2-5
 species, 2-5
 uses, 2-5
 yellow, shrinkage values, 4-6t
- Buckling:
 interaction of buckling modes, 9-9 to 9-10, 9-9eq, 9-10eq
 of beams, 9-9 to 9-10, 9-9eq, 9-9t, 9-10fig
 of columns, 9-7 to 9-9, 9-7eq, 9-8fig
 of deck beams, 9-9, 9-10fig
 of roof beams, 9-9
- Building codes:
 classifications of construction, 18-2
 fire safety:
 containment to compartment of origin, 18-6 to 18-8
 fire growth within compartments, 18-3 to 18-6
 types of construction, 18-2
 organizations producing, 18-2
- Buildings, control of decay in, 14-4, 14-7
- Built-up columns, 9-8
- Bulletwood (*See also* Balata):
 mechanical properties, 5-18t, 5-22t
 shrinkage values, 4-8t
- Butternut:
 characteristics, 2-5
 characteristics for painting, 16-5t
 decay resistance, 14-5t
 dimensional change coefficient, 13-16t
 ease of bonding, 10-7t
 locality of growth, 2-5
 machinability, 2-5
 nomenclature, 6-5t
 shock resistance, 2-5
 shrinkage values, 4-6t
 strength properties, 5-4t, 5-9t
 uses, 2-5
- Buttonwood. *See* Sycamore
- Cambium, 3-2fig, 3-4, 3-6fig
- Carapa. *See* Andiroba
- Carbon impact:
 construction performance indices, 1-2t
 contained, 1-3
 deforestation, 1-2
 emissions, net carbon, 1-3, 1-4t
 photosynthesis, 1-2
 process, 1-2
 sequestration, 1-2
 sustainability, defined, 1-3
- Carbon monoxide, 18-6
- Carpenter ants:
 damage caused by, 14-11fig, 14-8t
 discussed, 14-13
- Carpenter bees:
 damage caused by, 14-8t
 discussed, 14-13
- Casing and base, availability, 6-17
- Casein adhesive:
 structural performance, 10-10t
 working and strength properties, and uses, 10-11t to 10-13t
- Catalpa:
 decay resistance, 14-5t
 dimensional change coefficient, 13-16t
- Catalysts and adhesion, 10-10
- Cativo:
 characteristics, 2-22
 decay resistance, 14-5t
 dimensional change coefficient, 13-17t
 ease of bonding, 10-7t
 locality of growth, 2-22
 mechanical properties, 5-18t, 5-22t
 resistance to decay and insects, 2-22
 shrinkage values, 4-8t
 uses, 2-22
- Cedar:
 availability at retail lumber yards, 6-16
 for finish boards, 6-16
- Cedar, Atlantic-white:
 characteristics, 2-18
 decay resistance, 14-5t
 dimensional change coefficient, 13-16t
 locality of growth, 2-18
 nomenclature, 6-13t
 shock resistance, 2-18
 shrinkage values, 4-6t
 strength properties, 5-6t, 5-11t
 thermal conductivity, 4-14t
 uses, 2-18
- Cedar, eastern red:
 characteristics, 2-16

Index

- decay resistance, 14-5t
- dimensional change coefficient, 13-16t
- ease of bonding, 10-7t
- heat release data, 18-12fig
- locality of growth, 2-16
- moisture content, 4-2t
- nomenclature, 6-13t
- shock resistance, 2-16
- shrinkage values, 4-6t
- strength properties, 5-6t, 5-11t
- thermal conductivity, 4-14t
- uses, 2-16
- Cedar, incense:
 - characteristics, 2-12 to 2-13
 - characteristics for painting, 16-5t
 - decay resistance, 14-5t
 - dimensional change coefficient, 13-16t
 - locality of growth, 2-12
 - moisture content, 4-2t
 - pecky, 2-13
 - nomenclature, 6-13t
 - shock resistance, 2-13
 - shrinkage values, 4-6t
 - strength properties, 5-6t, 5-11t
 - uses, 2-13
- Cedar, northern white:
 - characteristics, 2-18
 - characteristics for painting, 16-5t
 - decay resistance, 14-5t
 - dimensional change coefficient, 13-16t
 - elastic ratio, 5-2t
 - for shingles, 6-17
 - locality of growth, 2-18
 - mechanical properties, 5-14t, 5-15t
 - nomenclature, 6-13t
 - penetration, 15-16t
 - Poisson ratio, 5-3t
 - shock resistance, 2-18
 - shrinkage values, 4-6t
 - strength properties, 5-6t, 5-11t
 - thermal conductivity, 4-14t
 - uses, 2-18
- Cedar, Port-Orford:
 - characteristics, 2-16
 - characteristics for painting, 16-5t
 - connector joint strength, 8-21t
 - decay resistance, 14-5t
 - dimensional change coefficient, 13-16t
 - ease of bonding, 10-7t
 - locality of growth, 2-16
 - moisture content, 4-2t
 - nomenclature, 6-13t
 - shock resistance, 2-16
 - shrinkage values, 4-6t
 - strength properties, 5-7t, 5-12t
 - tensile strength, 5-26t
 - thermal conductivity, 4-14t
 - uses, 2-16
- Cedar, western red:
 - characteristics, 2-16
 - characteristics for painting, 16-5t
 - charring rate data, 18-14t
 - connector joint strength, 8-21t
 - decay resistance, 14-5t
 - dimensional change coefficient, 13-16t
 - ease of bonding, 10-7t
 - elastic ratio, 5-2t
 - erosion of planed surfaces, 16-12t
 - flame spread index, 18-4t
 - for shingles and shakes, 6-17
 - for siding, 6-16
 - locality of growth, 2-16
 - mechanical properties, 5-14t, 5-15t
 - moisture content, 4-2t
 - nomenclature, 6-13t
 - penetration, 15-16t
 - Poisson ratio, 5-3t
 - shock resistance, 2-16
 - shrinkage values, 4-6t
 - strength properties, 5-12t, 5-7t
 - tensile strength, 5-26t
 - thermal conductivity, 4-14t
 - toughness values, 5-28t
 - used for poles, 6-19
 - uses, 2-16
- Cedar, yellow:
 - characteristics, 2-18
 - characteristics for painting, 16-5t
 - connector joint strength, 8-21t
 - decay resistance, 14-5t
 - dimensional change coefficient, 13-16t
 - ease of bonding, 10-7t
 - flame spread index, 18-4t
 - locality of growth, 2-18
 - mechanical properties, 5-14t, 5-15t
 - moisture content, 4-2t
 - nomenclature, 6-13t
 - shrinkage values, 4-6t
 - shock resistance, 2-18
 - strength properties, 5-7t, 5-12t
 - thermal conductivity, 4-14t
 - toughness values, 5-28t
 - uses, 2-18
- Cedro. *See* Spanish-cedar
- Cedro macho. *See* Andiroba
- Cedro-Rana. *See* Tornillo
- Ceiba:
 - characteristics, 2-22
 - decay resistance, 14-5t
 - locality of growth, 2-22
 - mechanical properties, 5-18t, 5-22t
 - resistance to decay and insects, 2-22
 - shrinkage values, 4-8t
 - uses, 2-22
 - workability, 2-22
- Cells of wood:
 - description, 3-7, 3-9 to 3-12
 - fibers, 3-11
 - functions of various types, 3-9 to 3-12
 - parenchyma, 3-9, 3-11
 - rays, 3-9, 3-11
 - tracheids, 3-9
 - vessels, 3-10
- Cellulose, discussion, 3-7
- Cellulose insulation, product safety standard, 18-2 to 18-3
- Cement-bonded composites, 11-23 to 11-25, 11-24fig
 - magnesia-cement-bonded, 11-23
 - mechanical properties, 12-9, 12-10t
 - Portland-cement-bonded, 11-24
 - problems, 11-24
 - treatment, 11-24
- Cement-coated nails, 8-2fig, 8-3
- Ceramic-bonded composites, 11-25
- Chalking, 16-28
- Checks:
 - development due to weathering, 16-6, 16-11, 16-11fig
 - during drying, 13-7, 13-9 to 13-10, 13-12fig
 - in decking boards, 16-6
 - in lumber stress grading, 7-4
 - in glued-laminated timbers, 11-19
 - in veneer adhesion, 10-4
- Chemical discolorations during drying, 13-10, 13-13fig
- Chemicals, effect on wood:
 - discussion, 5-41
 - strength and mechanical properties, 5-41 to 5-42
- Cherry:
 - characteristics for painting, 16-5t
 - ease of bonding, 10-7t
 - nomenclature, 6-5t
- Cherry, black:
 - characteristics, 2-5
 - decay resistance, 14-5t
 - dimensional change coefficient, 13-16t
 - elastic ratio, 5-2t
 - locality of growth, 2-5
 - machinability, 2-5
 - moisture content, 4-2t
 - Poisson ratio, 5-3t
 - shock resistance, 2-5
 - strength properties, 5-4t, 5-9t
 - thermal conductivity, 4-13t
 - uses, 2-1, 2-5
- Cherry, pin, penetration, 15-16t
- Chestnut:
 - characteristics for painting, 16-5t
 - nomenclature, 6-5t
- Chestnut, American:
 - availability, 2-5 to 2-6
 - characteristics, 2-6
 - connector joint strength, 8-21t
 - decay resistance, 14-5t
 - dimensional change coefficient, 13-16t
 - ease of bonding, 10-7t
 - locality of growth, 2-5

- moisture content, 4-2t, 5-34t
penetration, 15-16t
shock resistance, 2-6
shrinkage values, 4-6t
strength properties, 5-4t, 5-9t
thermal conductivity, 4-13t
uses, 2-6
workability, 2-6
- Chewstick. *See* Manni
- Chlorothalonil/chlorpyrifos:
component ratios, 15-12
effectiveness, 15-12
- Chlorpyrifos:
effectiveness, 15-12
in combination, 15-12
- Chromated copper arsenate (CCA):
common types, 15-4
component substitutions, 15-4
composition of common types, 15-5t
effectiveness of common types, 15-4
effect on adhesion, 10-4
finishing wood treated with, 16-24
resistance to marine borers, 15-5
retention levels for various wood products, 15-5t
Southern pine sapwood stakes retention and life span test results, 15-7t to 15-8t
temperature for pressure treating, 15-18
use with Douglas-fir, 15-3
- Coal-tar creosote. *See* Creosote
- Cocobolo, shrinkage values, 4-8t
- Coefficient of friction, 4-17
- Coefficient of thermal expansion, 4-14
- Coefficient of variation, 5-26t
- Collapse during drying, 13-10, 13-12fig
- Columns:
built-up and spaced columns, 9-8
flanged columns, 9-8
long columns, compressive stress, 9-7, 9-7eq
short columns, compressive stress, 9-7 to 9-8, 9-8eq
- Composite products:
classification, 11-2t
conventional wood-based composite panels, 11-2 to 11-17
additives, 11-5
adhesives, 11-3 to 11-5
classification, 11-2t
elements, 11-2, 11-6fig
fiberboard, 11-12 to 11-15
oriented strandboard, 11-7 to 11-10
particleboard, 11-10 to 11-12
performance and standards, 11-1, 11-3t
plywood, 11-5 to 11-7
specialty composites, 11-15
glued-laminated timber (glulam), 11-17 to 11-20
mechanical properties, 12-2t
specific gravity, 12-2t
standards, 11-3t
- structural composite lumber, 11-20 to 11-22
description, 11-20
laminated strand lumber, 11-21
laminated veneer lumber, 11-21
oriented strand lumber, 11-21
parallel strand lumber, 11-21
- test standards, 12-5 to 12-7
- wood elements, 11-4fig
- wood–nonwood composites, 11-22 to 11-27
description, 11-22
inorganic-bonded composites, 11-22 to 11-25
wood–thermoplastic composites, 11-25 to 11-27
- Compreg:
advantages, 19-5
dimensional stability, 19-9t
molding, 19-5, 19-9
plasticizers, 19-5
properties, 19-5, 19-6t
thermal expansion coefficients, 19-8t
uses, 19-5 to 19-9
- Compressed wood, untreated (staypak)
appearance, 19-10
dimensional stability, 19-9t
purpose, 19-7t to 19-6t
strength properties, 19-7t to 19-8t
uses, 19-10
- Compression failures:
causes, 5-33
description, 5-33, 5-33fig
effect on strength, 5-33
- Compression wood:
definition, 5-31
density increase, 5-31
in juvenile wood, 5-32
shrinkage, 4-5, 5-32
- Compression strength parallel to grain:
affected by temperature, 5-36t
coefficient of variation, 5-26t
defined, 5-3
- Compressive stress of columns, 9-7 to 9-9, 9-7eq
- Compression stress perpendicular to grain:
coefficient of variation, 5-26t
defined, 5-3
- Condensation in crawl spaces, 14-7
- Conductance meters and moisture content, 13-2 to 13-3
- Conductivity, thermal:
definition, 4-10
discussion, 4-10 to 4-15
- Cone calorimeter, 18-12
- Connector joints:
cross bolts, 8-24
design loads, 8-20, 8-20fig, 8-21fig
end distance and spacing, 8-23
multiple connectors, 8-23 to 8-24, 8-24fig
net section stress, 8-23
parallel to grain loading, 8-19, 8-20fig
perpendicular to grain loading, 8-19 to 8-20, 8-20fig
shear plate connector, 8-19fig
split-ring connector, 8-19fig
strength components, 8-18 to 8-19
strength ratios, 8-25t
working loads:
exposure and moisture condition, effect of, 8-21
grade and quality of lumber, 8-22
loads at angle with grain, 8-22, 8-7fig, 8-13eq,
species grouping, 8-21t, 8-22t
steel side plates, effect of, 8-21
thickness of member, effect of, 8-22, 8-22t, 8-23fig
width of member, effect of, 8-23
- Consortium for Research on Renewable Industrial Materials (CORRIM):
calculations, 1-2
standards, 1-2
- Construction, design factors affecting dimensional change, 13-18
- Construction logs:
availability, 6-20
form, 6-21, 6-21fig
standards and specifications, 6-18t
strength properties, 7-14
uses, 6-20
- Copper azole - Type A (CBA-Type A):
retention levels for various wood products, 15-4t
solution percentages, 15-6
temperature for pressure treating, 15-18
- Copper bis(dimethyldithiocarbamate) (CDDC):
retention levels for various wood products, 15-4t, 15-5t
solution percentages, 15-6
temperature for pressure treating, 15-18
uses, 15-6
- Copper HDO (CXA), 15-6
- Copper naphthenate:
color transfer and changes, 15-6
effectiveness, 15-6
retention levels for various wood products, 15-4t
solution values, 15-6
Southern pine sapwood stakes retention and life span test results, 15-7t to 15-8t
treatment for cutting pretreated wood, 15-25
- Copper naphthenate (waterborne), 15-6
- Cotton linter paper, 19-12

Index

- Cottonwood:
 - characteristics, 2-6
 - connector joint strength, 8-21t
 - decay resistance, 14-5t
 - ease of bonding, 10-7t
 - elastic ratio, 5-2t
 - flame spread index, 18-4t
 - locality of growth, 2-6
 - moisture content, 4-2t
 - nomenclature, 6-5t
 - penetration, 15-16t
 - shock resistance, 2-6
 - species, 2-6
 - uses, 2-6
 - workability, 2-6
 - Cottonwood, balsam poplar:
 - mechanical properties, 5-14t, 5-15t
 - shrinkage values, 4-6t
 - strength properties, 5-4t, 5-9t
 - Cottonwood, black:
 - dimensional change coefficient, 13-16t
 - mechanical properties, 5-14t, 5-15t
 - shrinkage values, 4-6t
 - strength properties, 5-4t, 5-9t
 - thermal conductivity, 4-13t
 - Cottonwood, eastern:
 - dimensional change coefficient, 13-16t
 - elastic ratio, 5-2t
 - characteristics for painting, 16-5t
 - mechanical properties, 5-14t, 5-15t
 - Poisson ratio, 5-3t
 - shrinkage values, 4-6t
 - strength properties, 5-4t, 5-9t
 - thermal conductivity, 4-13t
 - Courbaril:
 - characteristics, 2-22 to 2-23
 - decay resistance, 14-5t
 - ease of bonding, 10-7t
 - locality of growth, 2-22
 - machinability, 2-23
 - mechanical properties, 5-18t, 5-22t
 - resistance to decay and insects, 2-23
 - shrinkage values, 4-8t
 - uses, 2-23
 - Covalent chemical bonds, 10-1 to 10-2
 - Crabwood. *See* Andiroba
 - Crack propagation systems, 5-17
 - Creep:
 - defined, 5-39
 - discussed, 5-39
 - influence of stress on, 5-39fig
 - Creosote, coal-tar:
 - advantages, 15-10
 - appearance, 15-10
 - composition variability, 15-10
 - EPA-approved customer information sheet, 15-2
 - effect on mechanical properties, 15-25 to 15-26
 - for non-pressure treatments, 15-12
 - handling precautions, 15-2
 - in pressure treatment process, 15-18
 - odor and vapors, 15-2
 - retention levels for various wood products, 15-4t, 15-5t
 - standards, 15-2 to 15-3
 - temperature for pressure treating, 15-25
 - treatment for cutting pretreated wood, 15-25
 - use site precautions, 15-2
 - volatility, 15-10
 - Creosote-coal-tar solutions:
 - properties, 15-10
 - retention levels for various wood products, 15-4t to 15-5t
 - standards by volume, 15-10
 - temperature for pressure treating, 5-42
 - Creosote-petroleum oil solutions:
 - retention levels for various wood products, 15-4t to 15-5t
 - Cristobal. *See* Macawood
 - Critical radiant flux test, 18-5
 - Cross grain:
 - effect on mechanical properties, 5-27 to 5-30
 - types, 5-27 to 5-30
 - Cuangare (*See also* Banak):
 - dimensional change coefficient, 13-17t
 - mechanical properties, 5-18t, 5-22t
 - shrinkage values, 4-8t
 - Cucumber, nomenclature, 6-5t
 - Cypress:
 - for siding, 6-16
 - Cypress, Arizona, decay resistance, 14-5t
 - Cypress, Mexican
 - characteristics, 2-38 to 2-39
 - locality of growth, 2-38
 - machinability, 2-38
 - mechanical properties, 5-18t, 5-22t
 - uses, 2-39
 - Dead trees, strength, 5-34
 - Decay:
 - and exposure to weather, 16-10, 16-13
 - appearance of fungi, 14-4
 - brown rot, 14-4
 - conditions favoring, 14-4
 - control in:
 - boats, wood, 14-7
 - buildings, 14-7
 - logs, poles, piling, or ties, 14-6
 - lumber, 14-6
 - plywood, 14-7, 14-9
 - cycle, 14-3fig
 - dead trees, 5-34
 - dry rot, 14-4
 - dry rot fungi, 14-4
 - effect on mechanical properties, 5-44
 - effect on strength, 5-43 to 5-44, 14-4 to 14-5, 14-6
 - fungal stain and molds, 14-4
 - heartwood, susceptibility to, 14-3 to 14-4
 - incipient, 14-4
 - sapwood, susceptibility to, 14-3
 - soft rot, 14-4
 - white rot, 14-4
- Decay hazard climate index, 14-2fig
- Decay resistance:
 - extractives, 3-3
 - heartwood, 3-3, 4-2t, 14-3 to 14-4
 - in visual stress grading, 7-5
- Decks:
 - discussed, 17-4
 - finishes, suitability and expected service life, 16-17t
 - finishing, 16-24
 - supports, 9-9, 9-10fig
 - use of cleaners, 16-34 to 16-35
- Deflections of beams:
 - effect of time, creep, 9-2
 - straight beams, 9-1 to 9-2, 9-2t, 9-1eq
 - tapered beams, 9-2, 9-2eq, 9-3fig
- Deformation equations:
 - axial load, 9-1, 9-1eq
 - bending:
 - effect of notches and holes, 9-2
 - effect of time, creep deflection, 9-3
 - straight beam deflection, 9-1 to 9-2, 9-1eq, 9-2t
 - tapered beam deflection, 9-2, 9-2eq, 9-3fig
 - water ponding, 9-2, 9-3eq
 - combined bending and axial load:
 - concentric load, 9-3 to 9-4, 9-4eq
 - eccentric load, 9-7, 9-7eq
 - torsion, 9-7, 9-7eq, 9-7fig
- Deformed shank nails, strength of, 8-8
- Degame:
 - characteristics, 2-23
 - locality of growth, 2-23
 - machinability, 2-23
 - mechanical properties, 5-18t, 5-22t
 - resistance to decay and insects, 2-23
 - shrinkage values, 4-8t
 - strength, 2-23
 - uses, 2-23
- Delamination and adhesive failure, 10-21
- Density:
 - as function of specific gravity and moisture content, 4-7 to 4-10, 4-11t, 4-12t
 - definition, 3-12
 - effect on adhesive bonding, 10-5 to 10-6
 - effect on withdrawal resistance of nails, 8-2 to 8-3
 - in sorting machine-graded lumber, 7-8
 - in visual stress grading, 7-5
 - variation, 4-7
- Design factors affecting dimensional change in structures:
 - flooring, 13-18

- framing lumber in house construction, 13-17
- heavy timber construction, 13-18
- interior finish, 13-18
- Design properties:
and stress grading, 7-3
procedures for deriving, 7-5 to 7-7
- Design values:
for foreign species, approval process, 7-4t
- Determa:
characteristics, 2-23
decay resistance, 14-5t
ease of bonding, 10-7t
locality of growth, 2-23
machinability, 2-23
mechanical properties, 5-18t, 5-22t
resistance to decay and insects, 2-23 uses, 2-23
- Diagonal grain, 5-28 to 5-31
- Dielectric constant, definition, 4-15, 4-16
- Dielectric meters and moisture content, 13-2 to 13-3
- Dielectric power factor, 4-16, 4-17
- Dimensional change and wood paintability, 16-2, 16-3
- Dimensional changes in wood:
affected by design factors, 13-17
calculation based on green dimensions, 13-17, 13-17eq
care during construction, 13-18 to 13-19
estimation using coefficients, 13-15 to 13-17, 13-15eq, 13-16t, 13-17t
- Discoloration:
by mildew, 16-12, 16-28, 16-28fig
by mold and fungal stains, 14-2
by nonmicrobial or chemical stains, 14-2
from water-soluble extractives, 16-28 to 16-30
of paint due to extractives, 16-25, 16-29 to 16-31
use of wood cleaners, 16-34 to 16-36
- Dogwood, nomenclature, 6-5t
- Doors, fire resistance in frame construction, 18-3 to 18-6
- Douglas-fir:
availability at retail yards, 6-16
characteristics, 2-11
characteristics for painting, 16-5t
charring rate equation, 18-13
connector joint strength, 8-21t
decay resistance, 14-5t
ease of bonding, 10-7t
elastic ratio, 5-2t
erosion of planed surfaces, 16-12t
flame spread index, 18-4t
for flooring, 6-16
for siding, 6-16
fracture toughness, 5-28t
kiln drying schedule, 13-11t
- locality of growth, 2-11
mechanical properties, 5-14t, 5-15t
moisture content, 5-34t
nomenclature, 6-13t
penetration, 15-16t
Poisson ratio, 5-3t
preservative pressure and temperature, 15-18, 15-20
preservative treatment to prevent marine borer attack on piles, 15-5t
preservatives used, 15-10 to 15-12
shrinkage, 4-5, 4-7fig
used for poles, 6-19
uses, 2-11
- Douglas-fir, coast:
dimensional change coefficient, 13-16t
moisture content, 4-2t
penetration, 15-16t
shrinkage values, 4-6t
strength properties, 5-7t, 5-12t
thermal conductivity, 4-14t
toughness values, 5-28t
- Douglas-fir, interior north:
dimensional change coefficient, 13-16t
shrinkage values, 4-6t
strength properties, 5-7t, 5-12t
tensile strength, 5-26t
thermal conductivity, 4-14t
toughness values, 5-28t
- Douglas-fir, interior west:
dimensional change coefficient, 13-16t
shrinkage values, 4-6t
strength properties, 5-7t, 5-12t
thermal conductivity, 4-14t
toughness values, 5-28t
- Douglas-fir, interior south:
strength properties, 5-7t, 5-12t
toughness values, 5-28t
- Draftstops, 18-6
- Dried wood, moisture control during transit and storage, 13-14 to 13-15, 13-15t
- Drift bolts, 7-10
- Dry kilns, 13-6 to 13-8, 13-8fig
- Drying of wood:
accelerated air drying and predrying, 13-6
advantages, 13-5
affect of properties, 13-5
air drying, 13-6
drying mechanism, 13-6 to 13-7, 13-6fig
drying defects:
discoloration, 13-10, 13-13fig, 13-14fig
fracture or distortion, 13-10, 13-12fig
warp, 13-10, 13-13fig
drying schedules, 13-8 to 13-9, 13-11t
drying stresses, 13-7, 13-7fig
kiln drying, 13-6
hardwood lumber targets, 13-5
softwood lumber targets, 13-5
- Duration of load:
adjustment of design properties, 7-10 to 7-13, 7-12t, 7-13fig
defined, 5-15, 5-39
effect on mechanical properties, 5-39 to 5-40
relationship to failure, 5-40fig
Dutch elm disease, 2-6
- Earlywood:
effect on paintability, 16-2, 16-3fig, 16-4fig, 16-3 to 16-4
description, 3-4
erosion of planed surfaces, 16-12t
- Ebony, shrinkage values, 4-8t
- Edge-grained lumber:
preferred for painting, 16-8, 16-6fig
weathering and check development, 16-11
- Ehie (*See also* Bengé):
decay resistance, 14-5t
- Ekki. *See* Azobe
- Ekop:
characteristics, 2-23
decay resistance, 14-5t
locality of growth, 2-23
machinability, 2-23
mechanical properties, 5-18t, 5-22t
shrinkage values, 4-8t
uses, 2-23
- EL2, 15-8
- Elastic properties of clear wood:
discussion, 5-2
values of:
modulus of elasticity ratios, 5-2t
modulus of rigidity ratios, 5-3t
Poisson's ratio, 5-2
- Elastomeric adhesives:
in light-frame construction, 10-19, 10-19fig
performance over time, 10-21 to 10-22, 10-22fig
structural performance, 10-10t
working and strength properties, and uses, 10-11t to 10-13t
- Electrical properties of wood:
conductivity, 4-15 to 4-17
dielectric constant, 4-15, 4-16
power factor, 4-16, 4-17
resistance and moisture content, 4-16fig
- Elm:
characteristics, 2-6
connector joint strength, 8-21t
decay resistance, 14-5t
disease, 2-6
locality of growth, 2-6
moisture content, 4-2t
species, 2-6
uses, 2-6

Index

- Elm, American:
 - characteristics for painting, 16-5t
 - dimensional change coefficient, 13-16t
 - ease of bonding, 10-7t
 - moisture content, 4-2t
 - shrinkage values, 4-6t
 - strength properties, 5-4t, 5-9t
 - thermal conductivity, 4-13t
- Elm, cedar:
 - dimensional change coefficient, 13-16t
 - moisture content, 4-2t
 - shrinkage values, 4-6t
 - tensile strength, 5-26t
- Elm, rock:
 - dimensional change coefficient, 13-16t
 - ease of bonding, 10-7t
 - moisture content, 4-2t
 - nomenclature, 6-5t
 - penetration 15-16t
 - shrinkage values, 4-6t
 - strength properties, 5-4t, 5-9t
 - thermal conductivity, 4-13t
- Elm, slippery:
 - dimensional change coefficient, 13-16t
 - penetration, 15-16t
 - shrinkage values, 4-6t
 - strength properties, 5-4t, 5-9t
 - thermal conductivity, 4-13t
- Elm, soft:
 - nomenclature, 6-5t
- Elm, winged:
 - dimensional change coefficient, 13-16t
 - shrinkage values, 4-6t
- Encased knots, definition, 5-27
- Encino. *See* Oak
- End joints in glued laminated timber, 11-19
- Engineered trusses and light-frame construction, 17-4
- Environmental benefits of wood:
 - discussion, 1-1
 - wood industry fuel sources, 1-2t
- Epoxy:
 - performance over time, 10-21 to 10-22
 - structural performance, 10-10t
 - use with wood and nonwood composites, 10-5
 - working and strength properties, and uses, 10-11t to 10-13t
- Erosion:
 - of earlywood and latewood planed surfaces, 16-12t
 - of finishes, 16-13
 - of wood, discussed, 16-11
 - rates for hardwood and softwoods, 16-12t
- Equilibrium moisture content:
 - definition, 4-3, 16-6
 - relative humidity as related to, 4-4t
 - values for U.S. cities, 13-3, 13-4t
- Extractives:
 - and mill glaze, 16-26 to 16-27
 - discoloration, water-soluble, 16-25, 16-29
 - discussion, 3-3, 5-34
 - effect on painting, 16-7, 16-12 to 16-13, 16-29
 - effect on strength, 5-34
 - heartwood, 3-3
 - species involved, 5-34
- Factory-finished wood products, 16-25
- Factory lumber (*See also* Hardwood lumber):
 - grades, 6-2
 - standard dimensions, 6-3
- Fastener head embedment, 8-26, 8-27fig
- Fasteners:
 - and iron stain, 16-30
 - corrosion and fire-retardant treated wood, 18-15
 - fire resistance in frame construction, 18-7 to 18-8
 - multiple-fastener joints, 8-24 to 8-25
- Fatigue:
 - defined, 5-15, 5-40
 - discussed, 5-40 to 5-41
 - summary of fatigue studies, 5-40t
- Fences, finishing, 16-13, 16-24
- Fiberboard:
 - attrition milling or refining, 11-12
 - cellulosic fiberboard, 11-14
 - grade stamp, 11-15fig
 - manufacture, 11-14
 - products, 11-14
 - sizing agents, 11-14
 - standards, 11-3t
 - classification, 11-1, 11-2t, 11-5fig
 - fibers used, 11-12
 - finishing techniques, 11-14 to 11-15
 - hardboard:
 - dry-process, 11-13
 - grade stamp, 11-15fig
 - heat treatment, 11-13
 - humidification, 11-13
 - manufacture, 11-13
 - mechanical properties, 12-6t
 - specific gravity, 12-6t
 - standards, 11-3t
 - tempering, 11-13
 - wet-process, 11-13
 - medium-density fiberboard (MDF):
 - density, 12-6t
 - grade stamp, 11-14fig
 - mechanical properties, 12-6t
 - resins used, 11-13
 - standards, 11-3t
 - uses, 11-13
 - with veneer overlay, 11-15, 11-16fig
- Fiber orientation, related to slope of grain, 5-28 to 5-31, 5-30fig
- Fibers:
 - description, 3-11
 - length, 3-11
 - shape, 3-11
- Fiber saturation point:
 - average, 4-2
 - definition, 4-2
- Finger joints, in laminated members, 11-19
- Finger-jointed lumber:
 - defined, 16-9
 - finishing, 16-10, 16-32
- Finish board, availability, 6-16
- Finish failure:
 - chalking, 16-28
 - cross-grain cracking, 16-26
 - discoloration from water-soluble extractives, 16-29, 16-29fig
 - intercoat peeling, 16-27, 16-27fig
 - mill glaze, 16-26 to 16-27
 - moisture blisters, 16-26, 16-26fig
 - stain:
 - blue, 16-30, 16-30fig
 - brown stain over knots, 16-25, 16-31
 - iron, 16-25, 16-30
 - rust, 16-30
- Finishes:
 - application and maintenance, 16-14t, 16-17t, 16-19t
 - application of:
 - paint, 16-22
 - semitransparent penetrating stain, 16-20
 - caution in use, 16-20, 16-19t
 - solid-color stain, 16-22
 - water-repellant preservative, 16-13
 - drying oils, 16-21
 - function, 16-21
 - factors affecting performance:
 - extractives, 16-7, 16-29 to 16-30
 - knots, 16-31
 - texture of wood, 16-8
 - weathering:
 - as a natural finish, 16-16
 - effect on paint adhesion, 16-12
 - effect on wood, 16-11
 - effect on wood finish, 16-13
 - wood moisture content, 16-6 to 16-7
 - back-priming, 16-25
 - wood product characteristics:
 - finger-jointed lumber, 16-9, 16-32
 - lumber, 16-8 to 16-9
 - plywood, 16-9
 - reconstituted wood products:
 - fiberboard, 16-8 to 16-10
 - particleboard, 16-10
 - treated wood:
 - fire-retardant treated, 16-11
 - preservative treated, 16-10

- wood properties, 16-2 to 16-3, 16-32
- moisture-excluding effectiveness of, 16-6 to 16-8, 16-13
 - on ponderosa pine, 16-14t
- non-drying oils, 16-34
- on:
 - butcher blocks and cutting boards, 16-34
 - floors, 16-33 to 16-34
 - interior wood, 16-32
 - items used for food, 16-34
 - porches, decks, fences, 16-24
 - treated wood, 16-24
 - wood exposed to marine environments, 16-24 to 16-25
 - paintability values, 16-7, 16-12
 - paraffin wax, 16-33 to 16-34
 - refinishing, 16-22 to 16-23
 - suitability and expected service life for exterior wood surfaces, 16-17t
- types:
 - film-forming:
 - effect on water and vapor absorption, 16-13
 - fire-retardant coatings, 16-11, 16-25
 - paint, 16-7, 16-12, 16-22
 - solid-color stain, 16-22
 - varnish:
 - clear, 16-21
 - pigmented, 16-21
 - opaque, 16-32
 - penetrating, 16-17 to 16-18
 - lightly colored, 16-16 to 16-17
 - semitransparent stains, 16-19 to 16-20
 - transparent clear, 16-17
 - oils, 16-21
 - stains, 16-16 to 16-24
 - surface coats, 16-33
 - transparent, 16-33
 - use of fillers, 16-33
 - use of sealers, 16-33
 - VOC regulation compliance, 16-15 to 16-16
 - See also* Paint and Water-repellant preservatives
- Fire performance characteristics of wood:
 - charring:
 - differences in wood species, 18-13 to 18-15
 - discussed, 18-13 to 18-15
 - equations for charring rates, 18-13 to 18-15
 - moisture content, 18-10
 - flame spread:
 - and heat release rate, 18-11
 - configurations, 18-9
 - factors influencing, 18-11
 - flammability data for wood species, 18-14t
 - heat release rate:
 - discussed, 18-11 to 18-13
 - measuring, 18-11
 - ignition:
 - piloted, 18-9
 - unpiloted, 18-10
 - smoke:
 - approaches for dealing with, 18-11
 - carbon monoxide, 18-6
 - defined, 18-6
 - release rate, 18-8
 - tests for determining yield, 18-6 to 18-8
 - toxicity, 18-6
 - smouldering, 18-6 to 18-7
 - stages of degradation, 18-8
- Fire resistance:
 - calculating, 18-13
 - defined, 18-13
 - failure criteria, 18-14
 - in heavy timber construction, 18-7
 - in light-frame construction, 18-7
 - in glued laminated members, 18-2 ratings, 18-2
- Fire-retardant coatings, 16-11, 16-25, 18-17
- Fire-retardant-treated wood:
 - and hygroscopicity, 18-15
 - and mechanical properties, 18-17
 - discussed, 18-15
 - effect on adhesion, 10-4
 - fastener corrosion, 18-17
 - heat release rates, 18-12 to 18-13
 - in high temperature applications, 18-11
 - paintability, 16-22
 - performance requirements, 18-11
 - uses, 18-11
- Fire-retardant treatments:
 - application methods, 18-15
 - chemical penetration, 18-16
 - inorganic salts, 18-15
- Fire safety design:
 - cellulosic insulation, 18-3
 - code organizations, 18-2
 - code requirements, 18-1
 - components, 18-1
 - containment to compartment of origin:
 - firestops and draftstops, 18-6
 - fire resistance, 18-6
 - of heavy timber construction, 18-2
 - in light-frame construction, 18-7
 - of glued-laminated members, 18-2, 18-7
 - fire safety engineering, 18-7
 - flame spread index, 18-3 to 18-5
 - flashover, 18-5
 - flooring, 18-5
 - roof covering materials, 18-5
- types of construction:
 - heavy timber, 18-2
 - light frame, 18-7
 - ordinary, 18-2
- Fire tests:
 - critical radiant flux, 18-5
 - flame spread index:
 - discussed, 18-3
 - values for solid lumber, 18-4t
 - roof coverings, 18-5
 - room/corner test, 18-5
 - tunnel test, 18-3
 - wood ignition, 18-9
- Firestops, 18-6
- Fir, balsam:
 - connector joint strength, 8-21t
 - dimensional change coefficient, 13-16t
 - mechanical properties, 5-14t, 5-15t
 - nomenclature, 6-13t
 - shrinkage values, 4-6t
 - strength properties, 5-7t, 5-12t
 - thermal conductivity, 4-14t
- Fir, California red:
 - dimensional change coefficient, 13-16t
 - nomenclature, 6-13t
 - penetration, 15-16t
 - tensile strength, 5-26t
 - toughness values, 5-28t
 - shrinkage values, 4-6t
 - strength properties, 5-7t, 5-12t
- Fir, grand:
 - dimensional change coefficient, 13-16t
 - ease of bonding, 10-7t
 - moisture content, 4-2t
 - nomenclature, 6-13t
 - penetration, 15-16t
 - shrinkage values, 4-6t
 - strength properties, 5-7t, 5-12t
- Fir, noble:
 - dimensional change coefficient, 13-16t
 - ease of bonding, 10-7t
 - moisture content, 4-2t
 - nomenclature, 6-13t
 - penetration, 15-16t
 - shrinkage values, 4-6t
 - toughness values, 5-28t
 - strength properties, 5-7t, 5-12t
- Fir, Pacific silver:
 - dimensional change coefficient, 13-16t
 - ease of bonding, 10-7t
 - flame spread index, 18-4t
 - mechanical properties, 5-14t, 5-15t
 - moisture content, 4-2t
 - nomenclature, 6-13t
 - shrinkage values, 4-6t
 - strength properties, 5-7t, 5-12t
 - tensile strength, 5-26t
 - toughness values, 5-28t
- Fir, subalpine:
 - dimensional change coefficient, 13-16t

Index

- elastic ratio, 5-2t
- mechanical properties, 5-14t, 5-15t
- nomenclature, 6-13t
- Poisson's ratio, 5-3t
- shrinkage values, 4-6t
- Firs, true (Eastern species):
 - characteristics, 2-11
 - decay resistance, 14-5t
 - locality of growth, 2-11
 - shock resistance, 2-11
 - strength properties, 2-11
 - uses, 2-11
- Firs, true (Western species):
 - decay resistance, 14-5t
 - locality of growth, 2-12
 - species, 2-12
 - uses, 2-12
- Fir, white:
 - connector joint strength, 8-21t
 - dimensional change coefficient, 13-16t
 - ease of bonding, 10-7t
 - moisture content, 4-2t
 - nomenclature, 6-13t
 - penetration, 15-16t
 - shrinkage values, 4-6t
 - strength properties, 5-7t, 5-12t
 - thermal conductivity, 4-14t
 - toughness values, 5-28t
- Flame-retardant composites, 11-15
- Flame spread index (FSI):
 - classes for, 18-2
 - discussed, 18-3
 - values for solid lumber, 18-4t
 - wood usage, 18-4
- Flat-sawn lumber:
 - and mill glaze, 16-26 to 16-27
 - disadvantages for finishing, 16-1, 16-25
- Flashover, discussed, 18-5
- Flooring:
 - care during construction, 13-19
 - design factors affecting dimensional change, 13-17
 - recommended moisture content, 13-5t
 - retail yard availability, 6-16, 6-17
- Forest certification programs:
 - discussion, 1-3 to 1-4
 - systems used, 1-4
 - American Tree Farm System (ATFS):
 - standards, 1-4
 - program location, 1-4
 - Canadian Standards Association (CSA):
 - standards, 1-5
 - program location, 1-5
 - Forest Stewardship Council (FSC):
 - standards, 1-4
 - program location, 1-4
 - Programme for the Endorsement of Forest Certification (PEFC) Schemes:
 - standards, 1-5
 - program location, 1-5
- Sustainable Forestry Initiative (SFI):
 - standards, 1-4
 - program location, 1-4
- Formaldehyde adhesives:
 - performance over time, 10-21 to 10-22, 10-22fig
 - safety concerns, 10-14
 - structural performance, 10-11t to 10-13t
 - use with composite products, 11-3 to 11-4
- Formosan termite, 14-11
- Foundations for light-frame buildings, 17-2
- Fracture toughness, defined, 5-15
- Friction, coefficient of, 4-17
- Fungi:
 - appearance of, 14-4
 - conditions favorable to growth, 14-1
 - definition, 14-1
 - discoloration caused by, 14-1 to 14-2
 - effect on wood, 14-2
 - prevention of damage from, 14-6
- Fungus damage:
 - causes, 14-1 to 14-2
 - stains, 14-2
- Glued-laminated timber (Glulam):
 - advantages, 11-17
 - architectural effects, 11-7
 - combinations:
 - axial members, 11-18
 - bending members, 11-18 to 11-19
 - curved members, 11-18
 - tapered straight members, 11-18
 - cross section variation, 11-17
 - finishes, suitability and expected service life, 15-15t
 - fire resistance, 17-5
 - grade variation, 11-17
 - manufacture:
 - end jointing, 11-19
 - face bonding, 11-19 to 11-20
 - finishing and fabrication, 11-20
 - lumber drying and grading, 11-19
 - preservative treatment, 11-20
 - mechanical properties, 12-7t
 - preservative retention levels, 14-5t to 14-6t
 - seasoning advantages, 11-17
 - size capabilities, 11-17
 - standards 11-18 to 11-19, 11-3t
- Glulam. *See* Glued-laminated timber (Glulam)
- Glulam beam construction, 16-8
- Glulam timber bridge, 16-10, 16-10fig
- Gluing properties of different wood, classification of species, 9-8t
- Gmelina, shrinkage values, 4-8t
- Gola. *See* Ekop
- Goncalo alves:
 - characteristics, 2-24
 - decay resistance, 14-5t
 - locality of growth, 2-24
 - mechanical properties, 5-18t, 5-22t
 - resistance to fungus attack, 2-24
 - shrinkage values, 4-8t
 - species, 2-24, 2-43t
 - strength, 2-24
 - uses, 2-24
- Grades and lumber, purchasing consideration, 6-17 to 6-18
- Grading hardwood lumber, 6-2 to 6-4
- Grading, machine, 7-7 to 7-11
- Grading softwood lumber, 6-7 to 6-10
- Grading, visual, 7-3 to 7-7
- Grain and texture of wood:
 - and finish performance, 16-6fig
 - and paintability, 16-7 to 16-8
 - discussion, 3-13 to 3-15
- Green building:
 - bioenergy, 1-2
 - biomass, 1-2
 - carbon neutral, 1-2
 - defined, 1-1
 - embodied energy, 1-1
 - fossil fuels, 1-2
 - production uses, 1-1 to 1-2
 - wood products, 1-2
- Greenheart:
 - characteristics, 2-24
 - decay resistance, 14-5t
 - dimensional change coefficient, 13-17t
 - ease of bonding, 10-7t
 - locality of growth, 2-24
 - machinability, 2-24
 - mechanical properties, 5-18t, 5-22t
 - shrinkage values, 4-8t
 - resistance to fungi and insects, 2-24
 - marine borers, 14-13 to 14-15
 - uses, 2-24
- Green wood:
 - and clinched nails, 8-5
 - bending properties, 19-3
 - creep and relaxation under load, 5-39
 - definition, 4-1
 - relationship of mechanical properties to specific gravity, 5-29t
 - treatment with polyethylene glycol (PEG), 19-10
- Growth rings:
 - cross section showing, 3-5fig, 3-6fig
 - discussion, 3-4, 3-6
 - effect on strength properties, 5-30 to 5-31
 - grain, 3-14
 - in sawn boards, 3-14
 - principal axes with respect to, 5-2
 - shrinkage, 4-5 to 4-7, 4-7fig
- Guatambu. *See* Pau marfim
- Guayacan. *See* Ipe
- Gum:

- nomenclature, 6-5t
 Gurjun. *See* Apitong
 Gypsum board, use in wood-frame construction to provide fire resistance, 18-7 to 18-8
 Gypsum-bonded composites, 11-23
- Hackberry:
 characteristics, 2-6
 decay resistance, 14-5t
 dimensional change coefficient, 13-16t
 ease of bonding, 10-7t
 locality of growth, 2-6
 moisture content, 4-2t
 nomenclature, 6-5t
 penetration, 15-16t
 shock resistance, 2-6
 shrinkage values, 4-6t
 strength properties, 5-4t, 5-9t
 thermal conductivity, 4-13t
 uses, 2-6
- Hardness:
 coefficient of variation, 5-26t
 definition, 5-3
- Hardwood flooring, grading rules:
 Maple Flooring Manufacturers Association, 6-4, 6-4t
 National Oak Flooring Manufacturers Association, 6-4, 6-4t
- Hardwood lumber:
 drying targets, 13-5
 finished market products:
 flooring:
 grading rules, 6-2 to 6-6
 standard dimensions, 6-3 to 6-4
 types, 6-4, 6-6
 kiln drying schedules, 13-8 to 13-9, 13-11t
 grades, 6-2, 6-2fig, 6-3t
 grading associations and rules, 6-4, 6-3t, 6-4t
 minimum widths, 6-3
 standard dimensions, 6-3
 standard thicknesses, 6-6t
 uses, 6-2
- Hardwoods:
 availability, 2-1 to 2-3
 bending properties, 19-3
 charring rates, 18-14t
 definition, 2-2
 flame spread index, 18-4t
 flammability data, 18-10t
 heat release data, 18-12fig
 imported, 2-19 to 2-38
 locality of growth, 2-2
 moisture content, heartwood and sapwood, 4-2t
 preservative penetration, 15-16t
 relationship of mechanical properties to specific gravity, 5-29t
 species by region, 2-3t
 uses, 2-2
 vessels, 3-10 to 3-11
- Heartwood:
 color, 4-2t
 decay resistance in different species, 3-3, 14-5t
 extractives content, 3-3
 for shakes, 6-17
 in visual stress grading, 7-5
 moisture content and drying, 13-7
- Heat capacity:
 defined, 4-11 to 4-12
 discussed, 4-11
 of solid wood, 4-15t
- Heat release rate:
 and smoke release rate, 18-11
 discussed, 18-11 to 18-12
- Heat sterilization:
 American Lumber Standard Committee (ALSC) regulations, 20-9 to 20-11
 quality mark, 20-11, 20-13fig
 standards:
 discussion, 20-1
 International Standard for Phytosanitary Measures (ISPM), 20-1 to 20-2
 pest groups, 20-1, 20-2t
 heating times:
 experimental, 20-4t
 factors affecting:
 air circulation, 20-2
 energy source, 20-2
 heating medium, 20-2, 20-3fig
 size and configuration of wood, 20-2, 20-3fig
 species, 20-2, 20-3fig
 stacking methods, 20-2, 20-4fig
 methods for estimating:
 MacLean equations, 20-5, 20-5eq, 20-6eq, 20-7fig
 degree of accuracy, 20-7
 heat conduction, 20-5eq
 summary of estimates, 20-8t
 multiple regression models, 20-7
 coefficients for, 20-9t
 summary of estimates, 20-10t, 20-11t, 20-12t
- Heat treatment. *See* Heat sterilization
- Heavy-timber construction:
 fire resistance of, 18-2, 18-7 to 18-8
 wood used in, 18-2
- Hemicellulose, 3-7
- Hemlock:
 availability at retail yards, 6-17
 for siding, 6-16
- Hemlock, eastern:
 characteristics, 2-12
 dimensional change coefficient, 13-17t
 connector joint strength, 8-21t
 locality of growth, 2-12
 mechanical properties, 5-14t, 5-15t
 moisture content, 4-2t
 nomenclature, 6-13t
 penetration, 15-16t
 shock resistance, 2-12
 shrinkage values, 4-6t
 strength properties, 5-7t, 5-12t
 thermal conductivity, 4-14t
 uses, 2-12
- Hemlock, mountain:
 characteristics, 2-12
 locality of growth, 2-12
 nomenclature, 6-13t
 shrinkage values, 4-6t
 strength properties, 5-7t, 5-12t
 toughness values, 5-28t
 uses, 2-12
- Hemlock, western:
 characteristics, 2-12
 characteristics for painting, 16-5t
 connector joint strength, 8-21t
 dimensional change coefficient, 13-17t
 elastic ratio, 5-2t
 erosion of planed surfaces, 16-12t
 flame spread index, 18-4t
 fracture toughness, 5-28t
 locality of growth, 2-12
 mechanical properties, 5-14t, 5-15t
 moisture content, 4-2t, 5-34t
 nomenclature, 6-13t
 Poisson ratio, 5-3t
 shock resistance, 2-12
 shrinkage values, 4-6t
 strength properties, 5-7t, 5-12t
 tensile strength, 5-26t
 thermal conductivity, 4-14t
 toughness values, 5-28t
 uses, 2-12
- Hickory:
 decay resistance, 14-5t
 nomenclature, 6-5t
- Hickory, bittersweet:
 moisture content, 4-2t
 strength properties, 5-5t, 5-10t
- Hickory, mockernut:
 moisture content, 4-2t
 penetration, 15-16t
 shrinkage values, 4-6t
 strength properties, 5-5t, 5-10t
 thermal conductivity, 4-13t
 toughness values, 5-27t
- Hickory, nutmeg, strength properties, 5-5t, 5-10t
- Hickory, pecan:
 characteristics, 2-6 to 2-7
 dimensional change coefficient, 13-16t
 ease of bonding, 10-7t
 for flooring, 6-4, 6-6
 locality of growth, 2-6 to 2-7

Index

- shrinkage values, 4-6t
- species, 2-6
- strength properties, 5-5t, 5-10t
- thermal conductivity, 4-13t
- uses, 2-7
- Hickory, pignut:
 - moisture content, 4-2t
 - shrinkage values, 4-6t
 - strength properties, 5-5t, 5-10t
 - toughness values, 5-27t
- Hickory, red, moisture content, 4-2t
- Hickory, sand:
 - moisture content, 4-2t
 - toughness values, 5-27t
- Hickory, shagbark:
 - characteristics for painting, 16-5t
 - shrinkage values, 4-6t
 - strength properties, 5-5t, 5-10t
 - thermal conductivity, 4-13t
- Hickory, shellbark:
 - shrinkage values, 4-6t
 - strength properties, 5-5t, 5-10t
- Hickory, water:
 - moisture content, 4-2t
 - strength properties, 5-5t, 5-10t
- Hickory, true:
 - characteristics, 2-7
 - connector joint strength, 8-21t
 - dimensional change coefficient, 13-16t
 - ease of bonding, 10-7t
 - locality of growth, 2-7
 - shrinkage values, 4-6t
 - species, 2-7
 - strength properties, 5-5t, 5-10t
 - uses, 2-7
- Holly, nomenclature, 6-5t
- Holly, American:
 - dimensional change coefficient, 13-16t
 - shrinkage values, 4-6t
- Honeylocust:
 - availability, 2-7
 - characteristics, 2-7
 - decay resistance, 14-5t
 - dimensional change coefficient, 13-16t
 - locality of growth, 2-7
 - shock resistance, 2-7
 - shrinkage values, 4-6t
 - strength properties, 5-5t, 5-10t
 - uses, 2-7
- Hot melt adhesives:
 - bonding, 10-9
 - structural performance, 10-10t
 - working and strength properties, and uses, 10-11t to 10-13t
- Hot-press bonding, affect on moisture content, 10-15
- Hot pressing:
 - fiberboard, 11-13 to 11-14
 - oriented strandboard, 11-8, 11-10
 - particleboard, 11-11
- Hura:
 - characteristics, 2-24
 - decay resistance, 14-5t
 - ease of bonding, 10-7t
 - locality of growth, 2-24
 - machinability, 2-24
 - mechanical properties, 5-18t, 5-22t
 - resistance to fungi and insects, 2-24
 - shrinkage values, 4-8t
 - uses, 2-24
- Identification of wood, 3-16
- Ignition of wood:
 - piloted, 18-9
 - unpiloted, 18-10
- Ilomba:
 - characteristics, 2-24 to 2-25
 - locality of growth, 2-24
 - machinability, 2-25
 - mechanical properties, 5-19t, 5-23t
 - resistance to fungi and insects, 2-25
 - shrinkage values, 4-8t
 - uses, 2-25
- Imbuia, shrinkage values, 4-8t
- Imported woods, commercially important, 2-18 to 2-40
- Impact bending:
 - coefficient of variation, 5-26t
 - defined, 5-3
- Impreg:
 - bulking agents, 19-4 to 19-5
 - dimensional stability, 19-9t
 - process, 19-4 to 19-5
 - properties, 19-6t
 - species, 19-5
 - strength properties, 19-7t to 19-8t
- Incising:
 - and fire-retardant treatments, 18-15 to 18-16
 - effect on strength properties, 5-43
- Incense-cedar. *See* Cedar, Incense
- Inorganic boron (borax/boric acid):
 - acceptable compounds, 15-13 to 15-15
 - effectiveness, 15-13 to 15-15
 - solubility, 15-6, 15-8
 - temperature for pressure treating, 15-20
 - uses, 15-6, 15-8
- Insect damage and control:
 - beetles, 14-9 to 14-10
 - carpenter ants, 14-13
 - bees, 14-13
 - effect on strength, 5-44
 - naturally termite-resistant wood, 14-12 to 14-13
 - termites, 14-11 to 14-12
 - types of damage, 14-8t, 14-9fig
- Insulation for sound control for wood buildings, 17-11, 17-12t
- Insulation in wood building, 17-11 to 17-12
- Intergrown knots, 3-15, 5-27
- Interlocked grain:
 - definition, 3-15
 - effect on strength, 5-30
 - in Sweetgum, 2-9
- Interior finishes, care during construction, 13-19
- Internal friction, 5-17, 5-21
- Invasive species. *See* Heat sterilization
- Ipe:
 - decay resistance, 14-5t
 - locality of growth, 2-25
 - machinability, 2-25
 - mechanical properties, 5-19t, 5-23t
 - resistance to decay and insects, 2-25
 - shrinkage values, 4-8t
 - uses, 2-25
- Ipil. *See* Merbau
- Iroko:
 - characteristics, 2-25
 - decay resistance, 14-5t
 - dimensional change coefficient, 13-17t
 - ease of bonding, 10-7t
 - locality of growth, 2-25
 - mechanical properties, 5-19t, 5-23t
 - resistance to fungi and insects, 2-25
 - shrinkage values, 4-8t
 - species, 2-25
 - workability, 2-25
 - uses, 2-25
- Iron stain, 14-2, 16-25, 16-30
- Ironwood, nomenclature, 6-5t
- Isocyanate adhesives:
 - performance over time, 10-21
 - structural performance, 10-11t to 10-13t
 - use with composite products, 11-4
 - working and strength properties, and uses, 10-11t to 10-13t
- Jacaranda. *See* Rosewood, Brazilian
- Jarrah:
 - characteristics, 2-25 to 2-26
 - decay resistance, 14-5t
 - ease of bonding, 10-7t
 - locality of growth, 2-25
 - machinability, 2-26
 - mechanical properties, 5-19t, 5-23t
 - resistance to decay and insects, 2-25 to 2-26
 - marine borers, 14-13 to 14-15
 - shrinkage values, 4-8t
 - uses, 2-26
- Jatoba. *See* Courbaril
- Jelutong:
 - characteristics, 2-26
 - decay resistance, 14-5t
 - locality of growth, 2-26
 - mechanical properties, 5-19t, 5-23t
 - shrinkage values, 4-8t
 - uses, 2-26
 - workability, 2-26

- Jequitiba. *See* Albarco
- Joints, glued, strength, 10-4 to 10-5
- Joists and light-frame construction, 17-1 to 17-2
- Joists and rafter systems in light-frame construction, 17-3
- Juniper, decay resistance, 14-5t
- Juvenile wood:
- discussion, 3-13
 - effect on mechanical properties, 5-32 to 5-33
 - effect on strength properties, 5-32 to 5-33
 - properties, 5-33, 5-33fig
 - shrinkage of, 5-32
- Kakaralli. *See* Manbarklak
- Kaneelhart:
- characteristics, 2-26
 - ease of bonding, 10-7t
 - locality of growth, 2-26
 - mechanical properties, 5-19t, 5-23t
 - resistance to fungi and insects, 2-26
 - shrinkage values, 4-8t
 - uses, 2-26
- Kapur:
- characteristics, 2-26
 - decay resistance, 14-5t
 - ease of bonding, 10-7t
 - locality of growth, 2-26
 - machinability, 2-26
 - mechanical properties, 5-19t, 5-23t
 - resistance to fungi and insects, 2-26
 - shrinkage values, 4-8t
 - strength properties, 2-26
 - uses, 2-26
- Karri:
- characteristics, 2-26 to 2-27
 - decay resistance, 14-5t
 - ease of bonding, 10-7t
 - locality of growth, 2-26 to 2-27
 - machinability, 2-27
 - mechanical properties, 5-19t, 5-23t
 - shrinkage values, 4-8t
 - uses, 2-27
- Kauta. *See* Marishballi
- KDS, 15-8
- Kempas:
- characteristics, 2-27
 - decay resistance, 14-5t
 - locality of growth, 2-27
 - machinability, 2-27
 - mechanical properties, 5-19t, 5-23t
 - resistance to fungi and insects, 2-27
 - shrinkage values, 4-8t
 - uses, 2-27
- Keruing:
- characteristics, 2-27
 - decay resistance, 14-5t
 - dimensional change coefficient, 13-17t
 - ease of bonding, 10-7t
 - durability, 2-27
 - locality of growth, 2-27
 - machinability, 2-27
 - mechanical properties, 5-19t, 5-23t
 - shrinkage values, 4-8t
 - uses, 2-27
- Khaya (*See* Mahogany, African):
- dimensional change coefficient, 13-17t
- Kiln drying:
- advantages, 13-6
 - importance of air circulation, 13-6
 - kiln schedules, 13-8 to 13-9, 13-11t
 - types of kilns, 13-6 to 13-8, 13-10fig
- Knots:
- changes during drying, 13-10, 13-12fig
 - definition, 5-26
 - discoloration through paint, 16-25
 - effect on:
 - in determining strength ratios, 7-5 to 7-6, 7-6fig
 - mechanical properties of wood, 5-26 to 5-28, 5-34
 - stiffness, 7-4
 - strength properties, 7-3 to 7-4
 - encased, 5-27, 7-4
 - in lumber stress grades, 7-4
 - intergrown, 5-27, 7-4
 - knotholes, 7-4
- Kokrodua (*See also* Afrormosia):
- dimensional change coefficient, 13-17t
- Korina. *See* Limba
- Krabak. *See* Mersawa
- Kraft paper, 19-12
- Kwila. *See* Merbau
- Lag screws. *See* Screws, lag
- Laminated members, curved:
- advantages, 19-2 to 19-3
 - species, choice of, 19-2 to 19-3
 - uses, 19-2
- Laminated members, glued. *See* Glued structural members.
- Laminated strand lumber, 11-21
- Laminated veneer lumber, 11-21
- mechanical properties, 12-8t
- Laminated wood, strength properties, 19-7t to 19-8t
- Laminates. *See* Paper-based plastic laminates
- Laminating grades, 6-8
- Lapacho (*See also* Ipe):
- ease of bonding, 10-7t
- Lap marks, 16-19, 16-20fig
- Lapuna. *See* Ceiba
- Larch, western:
- characteristics, 2-13
 - characteristics for painting, 16-5t
 - connector joint strength, 8-21t
 - decay resistance, 14-5t
 - dimensional change coefficient, 13-17t
 - ease of bonding, 10-7t
 - elastic ratio, 5-2t
 - for flooring, 6-16
 - locality of growth, 2-13
 - mechanical properties, 5-14t, 5-15t
 - moisture content, 4-2t, 5-34t
 - nomenclature, 6-13t
 - penetration, 15-16t
 - Poisson ratio, 5-3t
 - shock resistance, 2-13
 - strength properties, 5-7t, 5-12t
 - tensile strength, 5-26t
 - thermal conductivity, 4-14t
 - toughness values, 5-28t
 - used for poles, 6-19
 - uses, 2-13
- Lateral buckling, of beams, 9-9 to 9-10
- Lateral resistance:
- and the National Design Specification for Wood Construction, 8-1
 - of lag screws, 8-12 to 8-14
 - of nails, 8-5
 - of wood screws, 8-10 to 8-11
- Latewood:
- description, 3-4
 - erosion of planed surfaces, 16-12t
 - paintability, 16-7 to 16-8, 16-12
- Lauans:
- dimensional change coefficient, 13-17t
 - shrinkage values, 4-8t
- Lemonwood. *See* Degame
- Light-frame construction:
- balloon framing, 17-1
 - ceiling and roof, 17-4
 - decks, 17-4
 - exterior walls, 17-3 to 17-4
 - fire resistance of, 18-2 to 18-3
 - floors, 17-2, 17-3fig
 - foundations, 17-2
 - platform framing, 17-1 to 17-2
 - use of elastomeric adhesives, 10-19 to 10-20, 10-19fig
 - wood use in, 18-2
- Lignin:
- discussion, 3-7
 - weathering, 16-11 to 16-12
- Lignumvitae:
- characteristics, 2-27 to 2-28
 - decay resistance, 14-5t
 - ease of bonding, 10-7t
 - locality of growth, 2-28
 - mechanical properties, 5-19t, 5-23t
 - species, 2-27 to 2-28
 - uses, 2-28
 - working and strength properties, and uses, 10-11t to 10-13t
- Limba:
- characteristics, 2-28
 - decay resistance, 14-5t

Index

- dimensional change coefficient, 13-17t
- ease of bonding, 10-7t
- locality of growth, 2-28
- machinability, 2-28
- mechanical properties, 5-19t, 5-23t
- resistance to decay and insects, 2-28
- shrinkage values, 4-8t
- uses, 2-28
- Limnoria, 14-14
- Locust, black:
 - characteristics, 2-7
 - decay resistance, 14-5t
 - dimensional change coefficient, 13-16t
 - locality of growth, 2-7
 - nomenclature, 6-5t
 - penetration, 15-16t
 - shock resistance, 2-7
 - shrinkage values, 4-6t
 - strength properties, 5-5t, 5-10t
 - uses, 2-1, 2-7
- Lodgepole pine, used for poles, 6-19
- Log homes, 6-21, 17-6, 17-7fig
- Logs, control of mold, stain, decay, 14-6
- Longitudinal shrinkage of wood, 4-5
- Lumber:
 - commonly used abbreviations, 6-23 to 6-25
 - development of grading rules, 6-7
 - grading organization, 6-9t, 6-12
 - hardwood:
 - drying targets, 13-5
 - finished market products:
 - flooring:
 - grading rules, 6-6 to 6-7
 - standard dimensions, 6-3 to 6-4
 - types, 6-6
 - kiln drying schedules, 13-8 to 13-9, 13-11t
 - grades, 6-2, 6-3t, 6-2fig
 - grading associations and rules, 6-2, 6-3t
 - minimum widths, 6-3
 - standard dimensions, 6-3
 - standard thicknesses, 6-6t
 - uses, 6-2
 - purchase:
 - distribution yards, 6-12
 - primary manufacturers:
 - customers, 6-12
 - retail yard inventory:
 - availability of hardwood and softwoods, 6-12, 6-16
 - boards and yard lumber, 6-16
 - casing and base, 6-17
 - dimension and structural lumber stocked, 6-16
 - finish boards, 6-16
 - flooring, 6-16, 6-17
 - shingles and shakes, 6-17
 - siding, 6-16
 - purchase consideration, 6-17 to 6-18
 - softwood:
 - American Lumber Standards, 6-7
 - classification by grades:
 - factory and shop lumber:
 - factory (shop) grades, 6-10
 - industrial clears, 6-10
 - ladder and pole stock, 6-10
 - moulding stock, 6-10
 - pencil stock, 6-10
 - tank stock, 6-10
 - structural lumber:
 - dimension lumber, 6-8
 - structural laminations, 6-8
 - yard lumber:
 - select lumber, 6-7
 - common lumber, 6-7, 6-8fig
 - development of grading rules, 6-7
 - drying targets, 13-5
 - grading organizations, 6-9t
 - kiln drying schedules, 13-8 to 13-9, 13-11t
 - manufacture:
 - size, 6-10 to 6-11, 6-11t
 - surfacing, 6-11
 - patterns, 6-11, 6-12fig
 - species, 6-13t to 6-15t, 6-16
 - transportation, 6-12
 - Macacauba. *See* Macawood
 - Macawood:
 - characteristics, 2-28
 - common names, 2-44t
 - locality of growth, 2-28
 - mechanical properties, 5-19t, 5-23t
 - resistance to fungi and insects, 2-28
 - shrinkage values, 4-8t
 - uses, 2-28
 - workability, 2-28
 - Machine-graded structural lumber:
 - allowable stress for bending, 7-8 to 7-10
 - common grades, 7-7, 7-7t
 - components of system, 7-8
 - design stresses for other properties, 7-10
 - machine sorting criteria, 7-8
 - procedures for deriving design properties, 7-8
 - quality control, 7-10
 - Machinmango. *See* Manbarklak
 - Madrone, Pacific:
 - dimensional change coefficient, 13-16t
 - ease of bonding, 10-7t
 - nomenclature, 6-5t
 - shrinkage values, 4-6t
 - Magnesia-cement-bonded composites, 11-23
 - Magnolia:
 - characteristics, 2-7 to 2-8
 - decay resistance, 14-5t
 - dimensional change coefficient, 13-16t
 - ease of bonding, 10-7t
 - locality of growth, 2-7
 - moisture content, 4-2t
 - nomenclature, 6-5t
 - shock resistance, 2-8
 - shrinkage values, 4-6t
 - species, 2-7
 - strength properties, 5-5t, 5-10t
 - thermal conductivity, 4-13t
 - uses, 2-7
 - Mahogany:
 - species, 2-28
 - Mahogany, African:
 - characteristics, 2-28
 - dimensional change coefficients, 13-17t
 - decay resistance, 2-29, 14-5t
 - ease of bonding, 10-7t
 - elastic ratio, 5-2t
 - locality of growth, 2-28
 - machinability, 2-29
 - mechanical properties, 5-19t, 5-23t
 - Poisson ratio, 5-3t
 - shrinkage values, 4-8t
 - species, 2-28
 - uses, 2-29
 - Mahogany, American
 - characteristics, 2-29
 - decay resistance, 14-5t
 - ease of bonding, 10-7t
 - locality of growth, 2-29
 - machinability, 2-29
 - mechanical properties, 5-19t, 5-23t
 - uses, 2-29
 - Mahogany, Honduras:
 - elastic ratio, 5-2t
 - Poisson ratio, 5-3t
 - Mahogany, Phillippine, availability at retail yards, 6-16
 - Manbarklak:
 - characteristics, 2-29
 - locality of growth, 2-29
 - mechanical properties, 5-19t, 5-23t
 - nomenclature, 2-29, 2-44t
 - shrinkage values, 4-8t
 - resistance to fungi and insects, 2-29
 - marine borers, 14-13 to 14-15
 - uses, 2-29
 - workability, 2-29
 - Manni:
 - characteristics, 2-29
 - decay resistance, 14-5t
 - locality of growth, 2-29
 - machinability, 2-29
 - mechanical properties, 5-19t, 5-23t
 - resistance to insects, 2-29
 - shrinkage values, 4-8t
 - uses, 2-29
 - Maple, black:
 - dimensional change coefficients, 13-16t

- shrinkage values, 4-6t
 strength properties, 5-5t, 5-10t
 thermal conductivity, 4-13t
- Maple, bigleaf:
 dimensional change coefficients, 13-16t
 shrinkage values, 4-6t
 strength properties, 5-5t, 5-10t
- Maple, hard:
 characteristics, 2-8
 charring rate data, 18-14t
 connector joint strength, 8-21t
 decay resistance, 14-5t
 ease of bonding, 10-7t
 heat release data, 18-12fig
 locality of growth, 2-8
 nomenclature, 6-5t
 shock resistance, 2-8
 species, 2-8
 uses, 2-8
- Maple, Oregon, nomenclature, 6-5t
- Maple, red:
 dimensional change coefficients, 13-16t
 elastic ratio, 5-2t
 Poisson ratio, 5-3t
 shrinkage values, 4-6t
 strength properties, 5-5t, 5-10t
 thermal conductivity, 4-13t
- Maple, silver:
 dimensional change coefficients, 13-16t
 moisture content, 4-2t
 penetration, 15-16t
 shrinkage values, 4-6t
 strength properties, 5-5t, 5-10t
 thermal conductivity, 4-13t
- Maple, soft:
 connector joint strength, 8-21t
 ease of bonding, 10-7t
 locality of growth, 2-8
 nomenclature, 6-5t
 species, 2-8
 uses, 2-8
- Maple, sugar:
 characteristics for painting, 16-5t
 dimensional change coefficients, 13-16t
 elastic ratio, 5-2t
 fracture toughness, 5-27t, 5-28t
 moisture content, 4-2t
 penetration, 15-16t
 Poisson ratio, 5-3t
 shrinkage values, 4-6t
 strength properties, 5-5t, 5-10t
 thermal conductivity, 4-13t
 toughness values, 5-27t
- Maple flooring:
 availability, 6-16 to 6-17
 grading, 6-6
- Maple Flooring Manufacturers Association, grading rules, 6-6
- Marishballi:
 characteristics, 2-29 to 2-30
- locality of growth, 2-29 to 2-30
 mechanical properties, 5-19t, 5-23t
 resistance to fungi and insects, 2-30
 shrinkage values, 4-8t
 uses, 2-30
- Marine borer damage and control, 14-13 to 14-15
- Malayapis. *See* Lauans
- Mata-mata. *See* Manbarklak
- Mayflower. *See* Roble
- Mechanical interlocking and adhesives, 10-1 to 10-2
- Mechanical properties of wood adjusted for design use, 7-10 to 7-13
 affected by:
 adhesion to metals, 10-5
 age, 5-41
 changes in moisture content, 5-34
 chemicals:
 exposure to, 5-41
 treatment, 5-41 to 5-43
 cross grain, 5-30
 decay, 5-43 to 5-44
 duration of load, 5-39 to 5-40
 fire-retardant treatments, 18-15
 insect damage, 5-44
 knots, 5-26 to 5-27
 juvenile wood, 5-32 to 5-33
 mold and stain fungi, 5-43
 rate of loading, 5-38
 slope of grain, 5-30t
 temperature, 5-35 to 5-38
 waterborne preservatives, 5-42
 relation to specific gravity, 5-26, 5-29t
 relation to stress grades, 7-2
- Medium-density fiberboard:
 grade stamp, 11-14fig
 properties, 11-13, 12-5, 12-6t
 resins used, 11-13
 standards, 11-3t
 uses, 11-13
 with veneer overlay, 11-15, 11-16fig
- Medium-density hardboard, finishes, suitability and expected service life, 16-17t
- Medium density overlays:
 finishes, suitability and expected service life, 16-17t
 to improve paintability of plywood, 16-9
- Melamine adhesives:
 performance over time, 10-21 to 10-22
 use with composite products, 11-4
 working and strength properties, and uses, 10-11t to 10-13t
- Meranti:
 characteristics, 2-30
 color, 2-30t
 decay resistance, 14-5t
 dimensional change coefficient, 13-17t
 ease of bonding, 10-7t
 locality of growth, 2-30
- machinability, 2-30
 mechanical properties, 5-21t, 5-25t
 uses, 2-30
- Merbau:
 characteristics, 2-30
 locality of growth, 2-30
 machinability, 2-30
 mechanical properties, 5-19t, 5-23t
 resistance to insects, 2-30
 shrinkage values, 4-8t
 uses, 2-30
- Mersawa:
 characteristics, 2-31
 decay resistance, 14-5t
 locality of growth, 2-31
 machinability, 2-31
 mechanical properties, 5-19t, 5-23t
 resistance to fungi and insects, 2-31
 shrinkage values, 4-8t
 uses, 2-31
- Metal bonding, 10-5
- Metal plate connectors, 8-25, 8-26fig
- Mildew:
 discoloration of wood, 16-28 to 16-29, 16-28fig
 removal, 16-28 to 16-29
- Mill glaze, 16-26 to 16-27
- Mill work, finishes, suitability and expected service life, 16-17t
- Modified woods:
 formaldehyde-treated wood:
 dimensional stability, 19-9t, 13-12
 mechanical properties, 19-11 to 19-12
 resistance to fungi, 19-12
 chemical modification:
 antishrink efficiency calculations, 19-12
 conditions for, 19-12
 chemicals used, 19-12
 dimensional stability, 19-9t, 19-11
 mechanical properties, 19-11 to 19-12
 cost, 19-5
 dimensional stability, 19-9t
 purposes, 19-4 to 19-5
 resin-treated compressed wood
- (Compreg):
 advantages, 19-5
 dimensional stability, 19-9t
 molding, 19-5, 19-9
 plasticizers, 19-5
 properties, 19-5, 19-6t
 strength properties, 19-7t to 19-8t
 thermal expansion coefficients, 19-8t
 uses, 19-9
- resin-treated wood (Impreg):
 bulking agents, 19-4 to 19-5
 dimensional stability, 19-9t
 process, 19-5
 properties, 19-6t
 strength properties, 19-7t to 19-8t

Index

- untreated compressed wood (Staypak):
 - appearance, 19-10
 - dimensional stability, 19-9t
 - properties, 19-9 to 19-10, 19-6t
 - purpose, 19-9
 - strength properties, 19-7t to 19-8t
 - uses, 19-9 to 19-10
- untreated heated wood (Staywood):
 - loss of mechanical and strength properties, 19-9
 - purpose, 19-9
- wood-polymer composites:
 - advantages, 19-11 to 19-12
 - changing characteristics, 19-11 to 19-12
 - monomers, 19-11
 - species used, 19-11
 - strength properties, 19-11t
 - uses, 19-11
- wood treated with polyethylene glycol (PEG):
 - dimensional stability, 19-9t
 - finishing, 19-10
 - process, 19-10
 - uses, 19-10
- Modulus of elasticity:
 - and columns with flanges, 9-8
 - coefficient of variation, 5-26t
 - discussed, 5-3
 - effect of temperature, 5-35, 5-36fig, 5-37t
 - of machine graded lumber, 7-7 to 7-8
 - of visually graded lumber, 7-6 to 7-7 values, 5-2t
- Modulus of rigidity:
 - discussion, 5-3
 - ratios, 5-3t
- Modulus of rupture:
 - and moisture content, 7-11, 7-11t, 7-12fig
 - coefficient of variation, 5-26t
 - defined, 5-3
 - effect of temperature, 5-36fig, 5-36t, 5-37fig
 - of beams, 9-5, 9-6
 - temperature effect, 5-36
- Moisture blisters, 16-26
- Moisture content:
 - adsorption/desorption curve, 4-5fig
 - adjustment for, 7-12
 - and decay, 14-4
 - and electrical resistance, 4-15
 - and heat capacity, 4-11
 - changes in finished ponderosa pine sapwood, 16-14fig
 - definition, 4-2, 16-6
 - determined by:
 - electrical method, 13-2 to 13-3
 - ovendrying method, 13-2, 13-2eq
 - dimensional changes, 10-6 to 10-8
 - effect on bonded joints, 10-9
 - effect of strength properties, 5-34, 5-35fig
 - equilibrium:
 - discussion, 4-3, 4-3fig
 - relative humidity as related to, 4-4t
 - green wood, 4-1, 4-2t
 - heartwood, 4-2t
 - in wood exposed outdoors, 16-7
 - recommended for:
 - exterior siding, 13-5t
 - flooring, 13-5t
 - furniture, 13-5t
 - interior woodwork, 13-5t
 - laminated members, 13-5, 13-5t
 - lumber, 13-3, 13-4t, 13-5t
 - plywood, 13-5, 13-5t
 - sheathing, 13-5t
 - timbers, 13-3
 - trim, 13-5t
 - veneer, 13-3
 - sapwood, 4-2t
 - shrinkage as related to, 4-5 to 4-7, 4-10
 - shrinkage curves, 4-7fig
 - specific gravity, 4-7, 4-9, 4-10fig
- Moisture content of dried lumber:
 - air-dry, 13-11
 - kiln dry, 13-12
 - shipping dry, 13-11
- Moisture content during transit and storage:
 - finish and factory lumber, 13-14
 - general, 13-14, 13-15t
 - plywood and structural items, 13-14
- Moisture-gradient, typical in lumber, 13-6, 13-7fig
- Molding resin-treated compressed wood (Compreg), 19-5, 19-9
- Molds:
 - appearance of, 14-2
 - distinction from stain, 14-2
 - effect on wood, 14-2
- Moment capacity, 9-5, 9-5eq
- Mora:
 - characteristics, 2-31
 - locality of growth, 2-31
 - mechanical properties, 5-19t, 5-23t
 - resistance to fungi and insects, 2-31
 - shrinkage values, 4-8t
 - uses, 2-31
 - workability, 2-31
- Multiple-fastener joints, 8-24 to 8-25, 8-24eq
- Nails:
 - lateral resistance of common wire nails:
 - pre-1991:
 - equations, 8-8
 - lateral load coefficients, 8-6t
 - load-slip curve, 8-6, 8-6fig
 - post-1991:
 - direction of driving, effect of, 8-6
 - load-slip curves, 8-8, 8-8eq, 8-9fig
 - moisture content, effect of, 8-8
 - seasoning, effect of, 8-8
 - shank form, effect of, 8-8
 - spacing, 8-7
 - yield model theory, 8-6, 8-7eq, 8-9fig, 8-7t
 - sizes:
 - box nails, 8-2t
 - common, 8-2fig
 - helically and annularly threaded, 8-2, 8-2t
 - penny size, 8-2
 - wire nails, 8-2, 8-2t
 - toenailed joints, strength of, 8-5
 - withdrawal resistance:
 - affected by, 8-2, 8-3
 - allowable loads, 8-6
 - clinched nails, 8-5
 - corrosion, 8-5
 - density of wood, effect of, 8-3
 - direction of driving, 8-5
 - etched nails, 8-4
 - load displacement curve, 8-3, 8-3fig
 - moisture content, effect of, 8-3, 8-4
 - nail heads, 8-4
 - nail points, effect of, 8-4
 - plywood, 8-6
 - prebored lead holes, effect of, 8-5
 - seasoning, effect of, 8-3
 - shank form, effect of, 8-4
 - surface coatings, effect of, 8-3 to 8-4
 - surface coating, used for 8-4
- Nanoindentation hardness, 5-15
- Naphthenate, copper:
 - color transfer and changes, 15-6
 - effectiveness, 15-6
 - retention levels for various wood products, 15-4t, 15-5t
 - solution values, 15-3 to 15-9
 - Southern pine sapwood stakes retention and life span test results, 15-7t, 15-8t
 - treatment for cutting pretreated wood, 15-25
- Naphthenate, zinc:
 - effectiveness, 15-11
 - inappropriate uses, 15-11
 - properties, 15-11
- National Grading Rule, 7-2, 7-3, 7-3t
- National Fire Protection Association, 18-2, 18-5
- National Hardwood Lumber Association, 6-2, 6-4t
- National Oak Flooring Manufacturers Association, grading rules, 6-6 to 6-7
- Nomenclature, 6-5t, 6-13t
- Nuclear radiation:
 - discussion, 4-17
 - effect on wood strength, 5-43

- Oak:
 for casing and base, 6-17
 used in piles, 6-20
- Oak, black:
 strength properties, 5-5t, 5-10t
 thermal conductivity, 4-13t
- Oak, bur:
 strength properties, 5-6t, 5-11t
 thermal conductivity, 4-13t
- Oak, California black, moisture content, 4-2t
- Oak, cherrybark, strength properties, 5-5t, 5-10t
- Oak, chestnut, strength properties, 5-6t, 5-11t
- Oak, laurel, strength properties, 5-5t, 5-10t
- Oak, live, strength properties, 5-6t, 5-11t
- Oak, northern red:
 characteristics for painting, 16-5t
 fracture toughness, 5-28t
 strength properties, 5-5t, 5-10t
- Oak, overcup:
 strength properties, 5-6t, 5-11t
 tensile strength, 5-26t
 toughness values, 5-27t
- Oak, pin:
 strength properties, 5-5t, 5-10t
 tensile strength, 5-26t
 toughness values, 5-27t
- Oak, post, strength properties, 5-6t, 5-11t
- Oak, red:
 availability for purchase, 6-17
 characteristics, 2-8
 charring rate data, 18-14t
 connector joint strength, 8-21t
 dimensional change coefficient, 13-16t
 ease of bonding, 10-7t
 elastic ratio, 5-2t
 erosion of planed surfaces, 16-12t
 flame spread index, 18-4t
 flammability data, 18-10t
 heat release data, 18-12fig
 locality of growth, 2-8
 mechanical properties, 5-19t, 5-23t
 nomenclature, 6-5t
 Poisson ratio, 5-3t
 penetration, 15-16t
 shrinkage values, 4-6t
 species, 2-8
 uses, 2-8
- Oak, scarlet:
 strength properties, 5-5t, 5-10t
 toughness values, 5-27t
- Oak, southern red:
 moisture content, 4-2t
 strength properties, 5-5t, 5-10t
 thermal conductivity, 4-13t
- Oak, swamp chestnut, strength properties, 5-6t, 5-11t
- Oak, swamp white, strength properties, 5-6t, 5-11t
- Oak, tropical:
 characteristics, 2-31
 locality of growth, 2-31
 resistance to fungi, 2-31
 specific gravity, 2-31
 uses, 2-31
- Oak, water:
 moisture content, 4-2t
 strength properties, 5-5t, 5-11t
- Oak, white:
 characteristics, 2-1, 2-8 to 2-9
 characteristics for painting, 15-16t
 charring rate equation, 18-13
 connector joint strength, 8-21t
 decay resistance, 2-9, 14-5t
 dimensional change coefficient, 13-16t
 ease of bonding, 10-7t
 elastic ratio, 5-2t
 flame spread index, 18-4t
 locality of growth, 2-8 to 2-9
 nomenclature, 6-5t
 penetration, 15-16t
 Poisson ratio, 5-3t
 shrinkage values, 4-6t
 species, 2-8 to 2-9
 strength properties, 5-6t, 5-11t
 uses, 2-9
- Oak, willow, moisture content, 4-2t
- Oak flooring, 6-6
- Obeche:
 characteristics, 2-31 to 2-32
 decay resistance, 14-5t
 dimensional change coefficient, 13-17t
 ease of bonding, 10-7t
 locality of growth, 2-44
 machinability, 2-32
 mechanical properties, 5-19t, 5-23t
 shrinkage values, 4-8t
 uses, 2-32
- Ofram. *See* Limba
- Oilborne preservatives. *See* preservatives, oilborne
- Oil-type preservatives, strength loss, 5-42
- Okoume:
 characteristics, 2-32
 decay resistance, 14-5t
 dimensional change coefficient, 13-17t
 ease of bonding, 10-7t
 locality of growth, 2-32
 machinability, 2-32
 mechanical properties, 5-20t, 5-24t
 shrinkage values, 4-8t
 uses, 2-32
- Old house borer, 14-10
- Oligomeric alkylphenol polysulfide (PXTS), 15-9
- Opaque finishes, 16-32
- Opepe:
 characteristics, 2-32
 ease of bonding, 10-7t
 locality of growth, 2-32
 machinability, 2-32
 mechanical properties, 5-20t, 5-24t
 shrinkage values, 4-8t
 uses, 2-32
- Ordinary construction:
 code requirements for fire protection, 18-2
 description, 18-2
- Oriented strandboard:
 adhesive application or blending, 11-10
 adhesives used, 11-7
 certification, 11-10, 11-8fig
 defined, 11-7
 drying process, 11-8, 11-10
 finishes, suitability and expected service life, 16-17t
 grade stamps, 11-8fig
 hot pressing, 11-10
 manufacturing process, 11-8, 11-10, 11-10fig
 mat formation, 11-10
 mechanical properties, 12-5t
 species used, 11-8
 specific gravity, 12-5t
 standards, 11-3t
 stranding process, 11-8
- Oriented strand lumber, 11-21
- Orthotropic nature of wood, 5-1
- Osage-orange:
 decay resistance, 14-5t
 ease of bonding, 10-7t
 nomenclature, 6-5t
- Ossol. *See* Manni
- Otie. *See* Ilomba
- Ovankol (*See also* Benge):
 mechanical properties, 5-20t, 5-24t
 shrinkage values, 4-8t
- Ovendry weight, specific gravity, 4-9, 4-9t
- Oxine copper:
 composition, 15-11
 corrosiveness, 15-11
 retention levels for various wood products, 15-4t, 15-5t
 Southern pine sapwood stakes retention and life span test results, 15-7t to 15-8t
 toxicity, 15-11
- Pacific yew, nomenclature, 6-14t
- Paint:
 adhesion bandage test, 16-28
 application and maintenance, 16-19t, 16-20 to 16-21
 characteristics of wood, 16-5t
 cracking, 16-26
 discussed, 16-26 to 16-27
 disposal, 16-36
 failure caused by:
 dimensional changes in wood, 16-7

Index

- earlywood/latewood band, 16-2
- face checks in plywood, 16-9, 16-9fig
- grain orientation, 16-8
- moisture content of wood, 16-6 to 16-7
- temperature at time of painting, 16-22 to 16-23
- texture of wood, 16-9
- water soluble extractives, 16-29
- weathering, 16-11
- failure in finger-jointed lumber, 16-9 to 16-10
- lead-based:
 - dust from, 16-36 to 16-37
 - health effects, 16-36 to 16-37
 - removal of, 16-36 to 16-37
 - use of, 16-36
- mildew removal, 16-29
- moisture blisters, 16-26
- on treated wood, 16-24
- on preweathered panels, 16-12
- peeling:
 - avoiding with proper painting, 16-24
 - caused by water, intercoat, 16-27
- protection against moisture, 16-13
- preweathering before painting, 16-13
- repainting, 16-24, 16-32 to 16-33
- removal, 16-35 to 16-36
- service life, 16-25
- strippers:
 - chemical:
 - alkali-based, 16-36
 - solvent-based, 16-36
 - mechanical, 16-35
 - “safe”, 16-36
- VOC regulation compliance, 16-15 to 16-16
- Pallet and container stock, 6-17
- Palosapis. *See* Mersawa
- Panel products:
 - classification, 11-5fig
 - fiberboard, 11-12 to 11-15
 - oriented strandboard, 11-7 to 11-10
 - particleboard, 11-10 to 11-12
 - performance standards, 11-3t
 - plywood, 11-5 to 11-7
 - product standards, 11-3t
- Paper-based plastic laminates:
 - decorative laminates:
 - process, 19-12 to 19-13
 - thicknesses, 19-13
 - uses, 19-12 to 19-13
 - industrial laminates:
 - cost advantage, 19-12
 - papreg, 19-13
 - resins used, 19-13
 - strength, 19-12, 19-7t to 19-8t
 - uses, 19-12
 - lignin-filled laminates:
 - strength properties, 19-14
 - resins used, 19-14
 - shrinking and swelling, 19-13
- Paper-faced overlays:
 - manufacture, 19-14
 - types:
 - decoratives, 19-13
 - masking, 19-14
 - structural, 19-14
 - uses, 19-13
- Papreg, 19-13
- Para-Angelim (*See also* Sucupira):
 - mechanical properties, 5-20t, 5-24t
 - shrinkage values, 4-8t
- Parallell strand lumber, 11-21
- Parana pine:
 - characteristics, 2-39
 - decay resistance, 14-5t
 - dimensional change coefficient, 13-17t
 - ease of bonding, 10-7t
 - locality of growth, 2-39
 - mechanical properties, 5-20t, 5-24t
 - shrinkage values, 4-8t
 - uses, 2-39
- Particleboard, 11-10 to 11-12
 - adhesives, 11-11
 - certification, 11-12
 - finishing, 11-12
 - hot pressing, 11-12
 - mat formation, 11-11
 - mechanical properties, 12-5t
 - particle classifications and conveying, 11-11
 - particle drying, 11-11
 - production, 11-11
 - resins and wax, 11-11
 - screw withdrawal, 8-10
 - specific gravity, 12-5t
 - standards, 11-3t
 - uses, 11-11
- Pau marfim:
 - characteristics, 2-32 to 2-33
 - dimensional change coefficient, 13-17t
 - ease of bonding, 10-7t
 - locality of growth, 2-32
 - machinability, 2-32
 - mechanical properties, 5-20t, 5-24t
 - resistance to decay, 2-32
 - shrinkage values, 4-8t
 - specific gravity, 2-32
 - strength values, 2-32
 - uses, 2-33
- Pecan (*See also* Hickory, pecan):
 - nomenclature, 6-5t
- Pecky cypress, 2-11
- Pentachlorophenol:
 - and nonpressure treatments, 15-20 to 15-21
 - approved uses, 15-10
 - effect on mechanical properties of wood, 15-20
 - effectiveness, 15-10
- EPA-approved consumer information sheet, 15-2
- handling precautions, 15-2
- ineffective against marine borers, 15-10
- paintability, 15-10
- retentions for various wood products, 15-4t, 15-5t
- solution standards, 15-10
- solution performance, 15-10
- use site precautions, 15-2
- Peroba, white. *See* Peroba de Campos
- Peroba de campos:
 - characteristics, 2-33
 - locality of growth, 2-33
 - machinability, 2-33
 - mechanical properties, 5-20t, 5-24t
 - resistance to decay, 2-33
 - shrinkage values, 4-8t
 - uses, 2-33
- Peroba rosa:
 - characteristics, 2-33
 - ease of bonding, 10-7t
 - locality of growth, 2-33
 - mechanical properties, 5-20t, 5-24t
 - resistance to fungi and insects, 2-33
 - shrinkage values, 4-8t
 - uses, 2-33
- Persimmon:
 - dimensional change coefficient, 13-16t
 - ease of bonding, 10-7t
 - nomenclature, 6-5t
 - shrinkage values, 4-6t
- Phenolic adhesives:
 - performance over time, 10-22, 10-22fig
 - structural performance, 10-11t to 10-13t
 - use with composite products, 11-3, 11-5
 - working and strength properties, and uses, 10-11t to 10-13t
- Phenolic resins:
 - for laminates, 19-13
- Pholads, 14-14
- Photodegradation. *See* Weathering
- Piles:
 - knots, effect on strength, 5-26 to 5-28
 - marine, protection against insects, 14-14 to 14-15
 - preservative retention levels, 15-4t to 15-5t
 - preservative treatments, 6-22
 - service life, 6-22
 - standards and specifications, 6-18t, 6-20 to 6-21
 - standards for end-bearing piles, 6-21
 - for friction piles, 6-21
 - straightness, 6-21
 - strength properties, 7-14
 - timber availability, 6-20
 - weight and volume, 6-21 to 6-22

- Pilon:
 characteristics, 2-33
 locality of growth, 2-33
 mechanical properties, 5-20t, 5-24t
 resistance to insects, 2-33
 uses, 2-33
 workability, 2-33
- Pine, Caribbean:
 characteristics, 2-39
 ease of bonding, 10-7t
 locality of growth, 2-39
 machinability, 2-39
 mechanical properties, 5-20t, 5-24t
 resistance to insects, 2-39
 shrinkage values, 4-8t
 uses, 2-39
- Pine, eastern white:
 characteristics, 2-13
 characteristics for painting, 16-5t
 connector joint strength, 8-21t
 decay resistance, 14-5t
 dimensional change coefficient, 13-16t
 ease of bonding, 10-7t
 flame spread index, 18-4t
 locality of growth, 2-13
 mechanical properties, 5-14t, 5-15t
 nomenclature, 6-13t
 penetration, 15-16t
 shock resistance, 2-13
 shrinkage values, 4-6t
 tensile strength, 5-26t
 thermal conductivity, 4-14t
 toughness values, 5-28t
 uses, 2-13
 workability, 2-13
- Pine, jack:
 characteristics, 2-13
 decay resistance, 14-5t
 dimensional change coefficient, 13-16t
 locality of growth, 2-13
 mechanical properties, 5-14t, 5-15t
 nomenclature, 6-13t
 penetration, 15-16t
 shock resistance, 2-13
 shrinkage values, 4-6t
 strength properties, 5-7t, 5-12t
 thermal conductivity, 4-14t
 toughness values, 5-28t
 uses, 2-13
- Pine, loblolly:
 decay resistance, 14-5t
 dimensional change coefficient, 13-16t
 elastic ratio, 5-2t
 erosion of planed surfaces, 16-12t
 moisture content, 4-2t, 5-34t
 penetration, 15-16t
 Poisson ratio, 5-3t
 shrinkage values, 4-6t
 strength properties, 5-7t, 5-12t
 tensile strength, 5-26t
- thermal conductivity, 4-14t
 toughness values, 5-28t
- Pine, lodgepole:
 characteristics, 2-13 to 2-14
 decay resistance, 14-5t
 dimensional change coefficient, 13-16t
 elastic ratio, 5-2t
 flame spread index, 18-4t
 locality of growth, 2-13 to 2-14
 mechanical properties, 5-14t, 5-15t
 moisture content, 4-2t
 nomenclature, 6-13t
 penetration, 15-16t
 Poisson ratio, 5-3t
 shock resistance, 2-14
 shrinkage values, 2-14, 4-6t
 strength properties, 5-7t, 5-12t
 thermal conductivity, 4-14t
 toughness values, 5-28t
 used for poles, 6-19
 workability, 2-14
 uses, 2-14
- Pine, longleaf:
 decay resistance, 14-5t
 dimensional change coefficient, 13-16t
 elastic ratio, 5-2t
 moisture content, 4-2t, 5-34t
 nomenclature, 6-13t
 Poisson ratio, 5-3t
 shrinkage values, 4-6t
 strength properties, 5-7t, 5-12t
 thermal conductivity, 4-14t
- Pine, ocote:
 characteristics, 2-39
 locality of growth, 2-39
 mechanical properties, 5-20t, 5-24t
 resistance to fungi, 2-39
 shrinkage values, 4-8t
 strength properties, 2-39
 uses, 2-39
- Pine, pitch:
 characteristics, 2-14
 decay resistance, 14-5t
 locality of growth, 2-14
 nomenclature, 6-13t
 shock resistance, 2-14
 shrinkage values, 2-14, 4-6t
 strength properties, 5-7t, 5-12t
 thermal conductivity, 4-14t
 uses, 2-14
- Pine, pond:
 characteristics, 2-14
 decay resistance, 14-5t
 dimensional change coefficient, 13-16t
 locality of growth, 2-14
 elastic ratio, 5-2t
 Poisson ratio, 5-3t
 shock resistance, 2-14
 shrinkage values, 2-14, 4-6t
 strength properties, 5-8t, 5-13t
- uses, 2-14
- Pine, ponderosa:
 characteristics, 2-14
 characteristics for painting, 16-5t
 connector joint strength, 8-21t
 decay resistance, 14-5t
 dimensional change coefficient, 13-16t
 ease of bonding, 10-7t
 elastic ratio, 5-2t
 erosion of planed surfaces, 16-12t
 flame spread index, 18-4t
 for siding, 6-16
 fracture toughness, 5-28t
 Jeffrey, 2-14
 locality of growth, 2-14
 mechanical properties, 5-14t, 5-15t
 moisture content, 4-2t
 changes in finished sapwood samples, 16-14fig
 moisture-excluding effectiveness of finishes on, 16-14t
 nomenclature, 6-13t
 penetration, 15-16t
 Poisson ratio, 5-3t
 shock resistance, 2-14
 shrinkage values, 4-6t
 strength properties, 5-8t, 5-13t
 thermal conductivity, 4-14t
 toughness values, 5-28t
 used for poles, 6-19
 uses, 2-14
- Pine, radiata:
 characteristics, 2-39 to 2-40
 ease of bonding, 10-7t
 locality of growth, 2-39
 machinability, 2-40
 mechanical properties, 5-20t, 5-24t
 uses, 2-40
- Pine, red:
 characteristics, 2-14
 connector joint strength, 8-21t
 decay resistance, 14-5t
 dimensional change coefficient, 13-16t
 flame spread index, 18-4t
 heat release index, 18-10t
 locality of growth, 2-14
 mechanical properties, 5-14t, 5-15t
 moisture content, 4-2t, 5-34t
 penetration, 15-16t
 preservative treatments to prevent marine borer attacks on piles, 15-5t
 Poisson ratio, 5-3t
 shock resistance, 2-14
 shrinkage values, 4-6t
 strength properties, 5-8t, 5-13t
 thermal conductivity, 4-14t
 toughness values, 5-28t
 uses, 2-14
- Pine, sand, strength properties, 5-8t, 5-13t
- Pine, scots, fracture toughness, 5-28t

Index

- Pine, shortleaf:
dimensional change coefficient, 13-16t
elastic ratio, 5-2t
moisture content, 4-2t
shrinkage values, 4-6t
strength properties, 5-8t, 5-13t
thermal conductivity, 4-14t
toughness values, 5-28t
- Pine, slash:
dimensional change coefficient, 13-16t
decay resistance, 14-5t
elastic ratio, 5-2t
Poisson ratio, 5-3t
shrinkage values, 4-6t
strength properties, 5-8t, 5-13t
thermal conductivity, 4-14t
toughness values, 5-28t
- Pine, southern:
characteristics, 2-14 to 2-15
characteristics for painting, 16-5t
charring rate data, 18-14t
charring rate equation, 18-13
connector joint strength, 8-21t
decay resistance, 14-5t
ease of bonding, 10-6, 10-7t
erosion of planed surfaces, 16-12t
flame spread index, 18-4t
flammability data, 18-10t
for flooring, 6-16 to 6-17
fracture toughness, 5-28t
grading, 6-8
kiln drying schedule, 13-8, 13-11t
moisture content and property values, 5-36t
nomenclature, 6-13t
preservative retention and life span tests, 15-7t to 15-8t
preservative treatments to prevent marine borer attacks on piles, 15-5t
shock resistance, 2-15
shrinkage values, 2-15, 4-6t
species, 2-14 to 2-15
used for piles, 6-20
used for poles, 6-19
uses, 2-15
- Pine, spruce:
characteristics, 2-15
decay resistance, 14-5t
locality of growth, 2-15
strength properties, 5-8t, 5-13t
uses, 2-15
- Pine, sugar:
characteristics, 2-15
connector joint strength, 8-12t
decay resistance, 14-5t
dimensional change coefficient, 13-16t
ease of bonding, 10-7t
elastic ratio, 5-2t
locality of growth, 2-15
moisture content, 4-2t
nomenclature, 6-14t
penetration, 15-16t
Poisson ratio, 5-3t
shock resistance, 2-15
shrinkage values, 2-15, 4-6t
strength properties, 5-8t, 5-13t
thermal conductivity, 4-14t
uses, 2-15
workability, 2-15
- Pine, Virginia:
characteristics, 2-15 to 2-16
decay resistance, 14-5t
dimensional change coefficient, 13-16t
locality of growth, 2-15
shock resistance, 2-15
shrinkage values, 4-6t
strength properties, 5-8t, 5-13t
tensile strength, 5-26t
toughness values, 5-28t
uses, 2-16
- Pine, western white:
characteristics, 2-16
characteristics for painting, 16-5t
connector joint strength, 8-21t
decay resistance, 14-5t
dimensional change coefficient, 13-16t
ease of bonding, 10-7t
elastic ratio, 5-2t
flame spread index, 18-4t
for siding, 6-17
fracture toughness, 5-28t
heat release data, 18-12fig
locality of growth, 2-16
mechanical properties, 5-14t, 5-15t
moisture content, 4-2t
paintability rating, 16-14fig
Poisson ratio, 5-3t
shock resistance, 2-16
shrinkage values, 4-6t
strength properties, 5-8t, 5-13t
thermal conductivity, 4-14t
uses, 2-16
workability, 2-16
- Pitch pockets:
description, 5-33
effect on strength, 5-33
in lumber stress grading, 7-5
species involved, 5-33
- Pith, 3-2, 3-2fig
- Piquia:
characteristics, 2-33 to 2-34
locality of growth, 2-33
machinability, 2-34
mechanical properties, 5-20t, 5-24t
shrinkage values, 4-8t
resistance to fungi and insects, 2-34
uses, 2-34
- Plainsawn lumber:
advantages, 3-15t
method of producing, 3-14
shrinkage, 4-5
- Plasticizing adhesive polymers, 10-9
- Plasticizing wood:
bent wood members, 19-2
bending operation and apparatus, 19-4
characteristics of bent wood, 19-4
chemicals used, 19-2
fixing the bend, 19-4
laminated members, 19-2 to 19-3
moisture content of bending stock, 19-3 to 19-4
principles of plasticizing and bending, 19-1
resin-treated compressed wood, 19-5
selection of stock, 19-3
steaming, 19-1
veneered curved members, 19-3
- Plastering, care during construction, 13-19
- Plastic bonding, 10-5
- Plastic-coated nails, 8-4
- Port-Orford Cedar, *See* Cedar, Port-Orford
- Plywood:
adhesives, 11-7
advantages over solid wood, 11-6
assembly, 11-5
classification by:
 exposure capability, 11-7
 grades, 11-7
description, 11-5
erosion of planed surfaced, 16-12t
finishes, suitability and expected service life, 16-17t
finishing, 16-16
fire-retardant treated, 18-15
grade stamp, 11-8fig, 11-9fig
in light-frame construction, 17-3
mechanical properties, 11-6, 12-4t
plies, 14-6
plies, 11-6
preservative retention levels, 15-4t to 15-5t
product standard, 11-7, 11-3t
protecting from decay, 14-6
specialty panels, 11-7
specific gravity, 12-4t
standards, 11-3t
types:
 construction and industrial, 11-7
 hardwood and decorative, 11-7
 weathering of, 16-9
- Plywood curved members:
bent after gluing:
 common hardwoods for, 19-3
 procedure for, 19-2
bent and glued simultaneously:
 advantages, 19-2 to 19-3
 procedure for, 19-2
- Poisson's ratio:
discussion, 5-2
values, 5-3t

Pole buildings, 17-4 to 17-5, 17-5fig, 17-6fig, 6-20

Poles:

- availability, 6-19
- characteristics relating to:
 - Douglas-fir, 6-19
 - lodgepole pine, 6-19
 - ponderosa pine, 6-19
 - southern pine, 6-19
 - western larch, 6-19
 - western redcedar, 6-19
- control of mold, stain, and decay, 14-6
- form and taper, 6-20 to 6-21, 6-20t
- preservation and seasoning, 6-22
- preservative treatment, retention levels, 15-4t to 15-5t
- specifications, 6-18t
- service life, 6-22
- species selection, 6-19
- standards and specifications, 6-18t
- strength properties, 7-13 to 7-14
- weight and volume, 6-21 to 6-22

Polymeric methylene diphenyl diisocyanate (PMDI) adhesives, 10-14

Polymerization, effect on mechanical properties, 5-43

Polymers, organic and synthetic, and adhesion, 10-9 to 10-10

Polymers, analytic chemical and mechanical testing, 10-19 to 10-20

Polyurethane bonding with wood and nonwood composites, 10-5

Polyurethane adhesives:

- performance over time, 10-21 to 10-22
- structural performance, 10-11t to 10-13t
- working and strength properties, and uses, 10-11t to 10-13t

Polyvinyl adhesives:

- structural performance, 10-11t to 10-13t
- working and strength properties, and uses, 10-11t to 10-13t

Porches:

- cleaning before refinishing, 16-23 to 16-24
- finishing, 16-25
- pests, 14-13

Pores. *See* Vessels

Portland-cement-bonded composites, 11-24, 12-9

Post-frame buildings, 17-4 to 17-5, 17-5fig, 17-6fig

Pre-drying, 13-6

Prefinished wood products, 16-25

Preservative penetration:

- heartwood, 15-13 to 15-15, 15-16t
- incising, effect of, 15-17 to 15-18
- sapwood, 15-13 to 15-15, 15-16t
- softwoods, 15-16t

Preservative-pressure-treated wood, EPA-approved customer information sheets, 15-2

Preservative retention tests, pressure treated, 15-4t to 15-5t

Preservatives:

- copper-containing, control of marine borers with, 14-14 to 14-15
- effect on mechanical properties, 15-20
- effect on paintability, 16-24 to 16-25
- effect on strength of oil-type, 5-42
- EPA regulations, 15-1 to 15-2
- inorganic arsenicals:
 - EPA-approved information sheet, 15-2
 - handling precautions, 15-2
 - use site precautions, 15-2

oilborne, various types:

- alkyl ammonium compound:
 - effectiveness, 15-12
 - in ammoniacal copper quat, 15-5
 - solubility, 15-5

- chlorothalonil/chlorpyrifos:
 - component ratios, 15-12
 - effectiveness, 15-12

- chlorpyrifos:
 - effectiveness, 15-12
 - in combination, 15-12

copper naphthenate:

- color transfer and changes, 15-11
- effectiveness, 15-11
- retention levels for various wood products, 15-4t to 15-5t
- solution values, 15-11
- Southern pine sapwood stakes retention and life span test results, 15-7t to 15-8t
- treatment for cutting pretreated wood, 15-18

creosote, coal-tar:

- advantages, 15-10
- appearance, 15-10
- composition variability, 15-10
- EPA-approved customer information sheet, 15-2
- effect on mechanical properties, 15-20 to 15-21
- for non-pressure treatments, 15-20
- handling precautions, 15-2
- in pressure treatment process, 15-18
- odor and vapors, 15-2
- retention levels for various wood products, 15-4t to 15-5t
- standards, 15-2
- temperature for pressure treating, 15-18
- treatment for cutting pretreated wood, 15-18
- use site precautions, 15-2
- volatility, 15-10

creosote-coal-tar solutions:

- properties, 15-10
- retention levels for various wood products, 15-4t to 15-5t

standards by volume, 15-10

temperature for pressure treating, 5-41

creosote-petroleum oil solutions:

- retention levels for various wood products, 15-4t to 15-5t

oxine copper:

- composition, 15-11
- corrosiveness, 15-11
- retention levels for various wood products, 15-4t to 15-5t
- Southern pine sapwood stakes retention and life span test results, 15-7t to 15-8t
- toxicity, 15-11

pentachlorophenol solutions:

- and nonpressure treatments, 15-20
- solution standards, 15-10 to 15-11
- solution performance, 15-10 to 15-11

pentachlorophenol:

- approved uses, 15-10
- effect on mechanical properties of wood, 15-20
- effectiveness, 15-10
- EPA-approved consumer information sheet, 15-2

handling precautions, 15-2, 15-10

ineffective against marine borers, 15-10

paintability, 15-10

retention levels for various wood products, 15-4t to 15-5t

Southern pine sapwood stakes retention and life span test results, 15-7t to 15-8t

use site precautions, 15-2

propiconazole:

- effectiveness, 15-9
- solubility, 15-9
- uses, 15-9

tebuconazole:

- effectiveness, 15-9
- solubility, 15-9

zinc naphthenate:

- effectiveness, 15-11
- inappropriate uses, 15-11
- properties, 15-11

3-iodo-2-propynyl butyl carbamate:

- effectiveness, 15-11
- paintability, 15-11
- retail marketing, 15-11
- use in combination, 15-11
- uses, 15-11

4, 5-dichloro-2-N-octyl-4-isothiazolin-3-one:

- effectiveness, 15-12
- inappropriate uses, 15-12
- solubility, 15-12

waterborne, general:

Index

- and non-pressure treatment, 15-12
 - application and maintenance of exterior wood finish, 16-19t
 - effectiveness, 15-12
 - effect on mechanical properties, 5-41 to 5-43
 - effect on strength, 5-41 to 5-43
 - finishing, 16-24
 - for marine piles, 15-3
 - initial kiln-drying temperature, 5-42
 - paintability, 15-12
 - post-treatment kiln drying
 - temperatures, 5-42 to 5-43
 - retention levels effect of strength, 5-15
 - retention levels for various wood products, 15-4t to 15-5t
 - retentions necessary for marine borer protection, 15-5t
 - temperature considerations, 15-3
 - waterborne, various types:
 - acid copper chromate (ACC):
 - components, 15-3
 - effectiveness and leaching, 15-3
 - retention levels for various wood products, 15-4t to 15-5t
 - Southern pine sapwood stakes retention and life span test results, 15-7t to 15-8t
 - temperature for pressure treating, 15-21
 - alkaline copper quat (ACQ):
 - common types, 15-5
 - composition of common types, 15-5t
 - retention levels for various wood products, 15-4t
 - ammoniacal copper zinc arsenate (ACZA):
 - composition, 15-3
 - replacement for ACA, 15-3
 - retention levels for various wood products, 15-4t to 15-5t
 - temperature for pressure treating, 15-20
 - use, 15-3
 - use with Douglas-fir, 15-3 to 15-4
 - chromated copper arsenate (CCA):
 - common types, 15-4 to 15-5
 - component substitutions, 15-4 to 15-5
 - composition of common types, 15-5t
 - effectiveness of common types, 15-4 to 15-5
 - effect on adhesion, 10-4
 - finishing wood treated with, 16-24 to 16-25
 - resistance to marine borers, 15-5
 - retention levels for various wood products, 15-4t to 15-5t
 - Southern pine sapwood stakes retention and life span test results, 15-7t to 15-8t
 - temperature for pressure treating, 15-20
 - use with Douglas-fir, 15-3 to 15-4
 - copper azole - Type A (CBAType A):
 - retention levels for various wood products, 15-4t to 15-5t
 - solution percentages, 15-6
 - temperature for pressure treating, 15-20
 - copper bis(dimethylthiocarbamate) (CDDC):
 - retention levels for various wood products, 15-4t to 15-5t
 - solution percentages, 15-6
 - temperature for pressure treating, 15-20
 - uses, 15-6
 - copper HDO (CXA), 15-6
 - copper naphthenate (waterborne), 15-6
 - EL2, 15-8
 - ICC-ES evaluation report
 - preservatives, 15-9
 - inorganic boron (borax/boric acid):
 - acceptable compounds, 15-6, 15-8
 - effectiveness, 15-6, 15-8
 - solubility, 15-6, 15-8
 - temperature for pressure treating, 15-20
 - uses, 15-6, 15-8
 - KDS, 15-8
 - oligomeric alkylphenol polysulfide (PXTS), 15-9
 - propiconazole, 15-9
 - tebuconazole, 15-9
 - propiconazole-tebuconazole-imidacloprid (PTI), 15-9
 - Preservatives, recommended retentions, 15-21, 15-4t to 15-5t
 - Preservatives, water-repellant, and non-pressure treatments:
 - effectiveness, 15-12
 - federal specifications, 15-12
 - uses, 15-12
 - Preservative-treated wood:
 - best management practices, 15-23 to 15-24
 - cut surfaces, protection of, 15-18
 - effect on adhesion, 10-6
 - finishing, 16-24
 - handling, 15-23 to 15-24
 - inspection, 15-25, 15-26fig
 - quality assurance, 15-25 to 15-26, 15-26fig
 - seasoning required, 15-24
 - service life, 15-25
 - specifications, 15-25
 - strength as affected by preservatives, 15-25
 - timing of use, 15-25
 - Preservative treatment for:
 - composite products, 11-15
 - light-frame construction, 17-2
 - Preservative treatment, effect on strength, 7-13
 - Preservative treatment, preparing for:
 - air-drying practices, 15-16
 - conditioning green lumber, 15-17
 - Boulton or boiling-undervacuum process, 15-17
 - steaming-and-vacuum process, 15-17
 - cutting and framing:
 - common uses, 15-18
 - potential size changes, 15-18
 - timing, 15-18
 - drying, 15-17 to 15-18
 - incising:
 - method, 15-17, 15-17fig
 - purpose, 15-17
 - primary species, 15-17
 - peeling, 15-17, 15-17fig
 - preventing decay while drying, 15-16
- Preservative treatments, nonpressure:
 - Boucherie process for green unpeeled poles, 15-21
 - brushing:
 - application, 15-22
 - choice of preservative, 15-22
 - effectiveness, 15-22
 - penetration obtained, 15-22
 - cold-soaking process:
 - effectiveness, 15-21
 - method, 15-21
 - retentions and penetrations, 15-21
 - compared to pressure treatment, 15-21
 - diffusion processes:
 - butt or groundline treatment of poles or posts, 15-21
 - double diffusion, 15-21
 - dipping:
 - effectiveness, 15-20
 - method, 15-20
 - penetration obtained, 15-20
 - steeping process:
 - effectiveness, 15-21
 - method, 15-21
 - wood used, 15-21
 - tire-tube method for green, unpeeled fencepost, 15-17
 - vacuum processes:
 - contrasted to pressure treating, 15-21
 - effectiveness, 15-21
 - methods, 15-21
 - uses, 15-21
- Preservative treatments, pressure:
 - advantages, 15-20

- and preservative temperature, 15-20
empty-cell processes:
 Lowry process, 15-20
 Rueping process, 15-18 to 15-19
full-cell process:
 description, 15-18
 following other conditioning, 15-18
modified full-cell, 15-18
penetration and retention levels, 15-18
pressures used, 15-18
- Primavera:
 availability, 2-34
 characteristics, 2-34
 dimensional change coefficient, 13-17t
 locality of growth, 2-34
 machinability, 2-34
 mechanical properties, 5-20t, 5-24t
 resistance to fungi, 2-34
 shrinkage values, 4-8t
 uses, 2-34
- Propiconazole:
 effectiveness, 15-9
 solubility, 15-9
 uses, 15-9
- Purlins and glulam beam construction, 17-7
- Purpleheart:
 characteristics, 2-34
 decay resistance, 14-5t
 ease of bonding, 10-7t
 locality of growth, 2-34
 machinability, 2-34
 mechanical properties, 5-20t, 5-24t
 shrinkage values, 4-8t
 uses, 2-34
- Pycnanthus. *See* Ilomba
- Quartersawn lumber:
 advantages, 3-15t
 method of producing, 3-14
 shrinkage, 4-5
- Quality control in preservative-treated wood, 15-25, 15-26fig
- Radius-edged decking, 6-8
- Rafters in light-frame construction, 17-3 to 17-4
- Ramin:
 characteristics, 2-34
 decay resistance, 14-5t
 dimensional change coefficient, 13-17t
 ease of bonding, 10-7t
 locality of growth, 2-34
 mechanical properties, 5-20t, 5-24t
 resistance to decay, 2-34
 shrinkage values, 4-8t
 uses, 2-34
 workability, 2-34
- Rays, definition and discussion, 3-9 to 3-10, 3-11 to 3-12
- Reaction wood:
 compression wood, 3-13, 5-31
 increase in density, 5-31
 shrinkage, 4-5, 5-32
 tension wood, 3-13, 5-32
- Redcedar, eastern. *See* Cedar, Eastern red
- Redcedar, western. *See* Cedar, Western red
- Redwood:
 characteristics, 2-17
 characteristics for painting, 16-5t
 charring rate data, 18-14t
 connector joint strength, 8-21t
 decay resistance, 2-17, 14-5t
 dimensional change coefficient, 13-16t
 ease of bonding, 10-7t
 elastic ratio, 5-2t
 erosion of planed surfaces, 16-12t
 flame spread index, 18-4t
 flammability data, 18-10t
 for finish board, 6-17
 for siding, 6-16
 heat release data, 18-12fig
 locality of growth, 2-17
 moisture content, 4-2t, 5-34t
 nomenclature, 6-14t
 paintability rating, 16-14fig
 penetration, 15-16t
 preservative pressure and temperature, 15-20
 shrinkage values, 4-6t
 strength properties, 5-8t, 5-13t
 tensile strength, 5-26t
 thermal conductivity, 4-14t
 toughness values, 5-28t
 uses, 2-17
 workability, 2-17
- Relative humidity:
 equilibrium moisture content, 4-3
 moisture content of wood, 4-4t, 16-6 to 16-7
- Remedial treatment, 14-7, 14-9
- Resorcinol adhesives:
 performance over time, 10-21 to 10-22, 10-22fig
 structural performance, 10-11t to 10-13t
 working and strength properties, and uses, 10-11t to 10-13t
- Roble:
 characteristics, 2-34
 ease of bonding, 10-7t
 locality of growth, 2-34 to 2-35
 machinability, 2-35
 mechanical properties, 5-20t, 5-24t
 resistance to decay, 2-35
 shrinkage values, 2-35, 4-8t
 uses, 2-35
- Rolling shear strength, defined, 5-17
- Roof beams and water ponding, 9-8
- Rosewood, ease of bonding, 10-7t
- Rosewood, Brazilian:
 characteristics, 2-35
 locality of growth, 2-35
 machinability, 2-35
 mechanical properties, 5-20t, 5-24t
 resistance to fungi and insects, 2-35
 shrinkage values, 4-8t
 uses, 2-35
- Rosewood, Indian:
 characteristics, 2-35
 locality of growth, 2-35
 machinability, 2-35
 mechanical properties, 5-20t, 5-24t
 shrinkage values, 4-8t
 uses, 2-35
- Round timber and ties:
 availability, 6-19 to 6-20
 durability, 6-22
 form, 6-20 to 6-21
 material requirements, 6-18 to 6-19
 standards and specifications, 6-18t
 strength properties, 7-13
 weight and volume, 6-21 to 6-22
- Sande:
 characteristics, 2-35 to 2-36
 decay resistance, 14-5t
 locality of growth, 2-35
 machinability, 2-36
 mechanical properties, 5-20t, 5-24t
 resistance to decay and insects, 2-36
 shrinkage values, 4-8t
 uses, 2-36
 fire resistance, 18-7
- Santa Maria:
 characteristics, 2-36
 dimensional change coefficient, 13-17t
 locality of growth, 2-36
 machinability, 2-36
 mechanical properties, 5-20t, 5-24t
 resistance to insects, 2-36
 uses, 2-36
- Sapele:
 characteristics, 2-36
 decay resistance, 14-5t
 ease of bonding, 10-7t
 locality of growth, 2-36
 machinability, 2-36
 mechanical properties, 5-20t, 5-24t
 shrinkage values, 4-8t
 uses, 2-36
- Sap stain, 13-10, 13-13fig, 14-2
- Sapwood:
 function, 3-2
 in visual stress grading, 7-5
 location, 3-2, 3-2fig
 moisture content, 4-2t
 moisture content and drying, 13-7
 preservative retention and stake lifespan, 15-7t to 15-8t
- Sassafras:
 characteristics, 2-9

Index

- decay resistance, 2-9, 14-5t
- dimensional change coefficient, 13-16t
- locality of growth, 2-9
- nomenclature, 6-5t
- shock resistance, 2-9
- shrinkage values, 4-6t
- strength properties, 5-6t, 5-11t
- uses, 2-9
- Screws, lag:
 - description, 8-12
 - post-1991 lateral load, yield model theory, 8-13 to 8-14, 8-7t, 8-13t
 - pre-1991 lateral loads, 8-13 to 8-14, 7-12eq, 8-12t, 8-13fig
 - lateral resistance, 8-13, 8-14t
 - lubrication, 8-14
 - prebored lead hole, size required, 8-11, 8-13fig
 - spacing, 8-16
 - withdrawal resistance, 8-10 to 8-13, 8-10eq
- Screws, tapping:
 - described, 8-10
 - use in particleboard, 8-11
 - withdrawal loads, 8-11, 8-11eq
 - withdrawal resistance, 8-10
- Screws, wood:
 - gauges, 8-11t
 - ateral load coefficients, 8-6t
 - lateral resistance, 8-10 to 8-11, 8-10eq, 8-11eq
 - lead hole and load, 8-11
 - lubrication, 8-10
 - penetration depth and load, 8-11
 - sizes, 8-11t
 - types, 8-10, 8-10fig
 - withdrawal loads for particleboard, 8-11, 8-11eq
 - withdrawal resistance, 8-10 to 8-11, 8-11eq
 - yield model theory, 8-8t, 8-11
- Seasoning and lumber purchasing considerations, 6-17 to 6-18
- Selangan Batu. *See* Balau
- Select lumber availability, 6-16 to 6-17
- Sepetir:
 - characteristics, 2-36
 - decay resistance, 14-5t
 - locality of growth, 2-36
 - mechanical properties, 5-20t, 5-24t
 - shrinkage values, 4-8t
 - uses, 2-36
 - workability, 2-36
- Seraya, white:
 - characteristics, 2-36 to 2-37
 - decay resistance, 14-5t
 - locality of growth, 2-36
 - machinability, 2-37
 - uses, 2-37
- Shakes:
 - in lumber stress grading, 7-4 to 7-5
- Shear strength parallel to grain:
 - coefficient of variation, 5-26t
 - defined, 5-3
- Shear stress of beams, 9-6
- Sheathing and light-frame construction, 17-3, 17-4fig
- Shingles and shakes, availability, 6-17
- Shingles, finishes, suitability and expected service life, 16-17t
- Shipworms, 14-13
- Shrinkage:
 - adjustment for design use, 7-10
 - affect on painting, 16-3, 16-4t
 - coefficients for changing moisture content by species, 13-16t, 13-17t
 - coefficient of variation, 4-7, 4-9
 - compression wood, 4-7
 - discussion, 4-5 to 4-9
 - fiber saturation point as related to, 4-2
 - longitudinal, 4-5
 - moisture content curves, 4-5fig
 - of domestic woods, 4-6t
 - of imported woods, 4-8t
 - radial, 4-6t, 4-8t
 - species, 4-6t, 4-8t
 - tangential, 4-6t, 4-8t
 - volumetric, 4-6t, 4-8t
- Siding:
 - and mill glaze, 16-26 to 16-27
 - availability, 6-16
 - back-priming, 16-25
 - finishes, suitability and expected service life, 16-17t
 - lumber finishing, 16-8 to 16-9
 - prefinished at the factory, 16-25
 - removing weathered surface, 16-13
 - use of plywood, 16-9
- Silverballi, brown. *See* Kaneelhart
- Size factor:
 - for design use, 7-11 to 7-12
 - procedures for design use:
 - in-grade test, 7-11 to 7-12
 - small clear, 7-11
- Slash-grained lumber. *See* Flat-grained
- Slope of grain:
 - determination, 5-28 to 5-30, 5-29eq
 - in visual sorting, 7-4
 - relationship to fiber orientation, 5-30fig
 - types, 5-29 to 5-31
- Smoke:
 - approaches for dealing with, 18-6
 - carbon monoxide, 18-6
 - defined, 18-6
 - release rate, 18-11
 - tests for determining yield, 18-9 to 18-10
 - toxicity, 18-10
- Soft rot, 14-4
- Softwood lumber:
 - American Lumber Standard, 6-7
 - classification by grades:
 - factory and shop lumber:
 - factory (shop) grades, 6-10
 - industrial clears, 6-10
 - ladder and pole stock, 6-10
 - moulding stock, 6-10
 - tank stock, 6-10
 - structural lumber:
 - dimension lumber, 6-8
 - structural laminations, 6-8
 - yard lumber:
 - common lumber, 6-7, 6-8fig
 - select lumber, 6-7 to 6-8
 - development of grading rules, 6-7
 - drying targets, 13-5
 - grading organizations, 6-9t
 - kiln drying schedules, 13-8 to 13-9, 13-11t
 - manufacture:
 - size, 6-10, 6-11t
 - surfacing, 6-11
 - patterns, 6-11, 6-12fig
 - species, 6-13t to 6-15t
- Softwoods:
 - availability, 2-2
 - bending properties, 19-3
 - charring rates, 18-14t
 - definition, 2-2
 - flame spread index, 18-4t
 - flammability data, 18-10t
 - heat release data, 18-12fig
 - imported, 2-38 to 2-40
 - moisture content, heartwood and sapwood, 4-2t
 - preservative penetration, 15-7t to 15-8t
 - relationship of mechanical properties to specific gravity, 5-29t
 - species by region, 2-3t
 - thermal conductivity, 4-14t
 - uses, 2-2
- Sorption hysteresis, discussed, 4-3
- Solvents and adhesion, 10-9
- Sound, speed of, 5-17
- Southern pine sapwood stakes, preservative retention and life span tests, 15-7t to 15-8t
- Soybean adhesives:
 - structural performance, 10-11t to 10-13t
 - working and strength properties, and uses, 10-11t to 10-13t
- Spanish-cedar:
 - characteristics, 2-37
 - decay resistance, 14-5t
 - dimensional change coefficient, 13-17t
 - ease of bonding, 10-7t
 - locality of growth, 2-37
 - mechanical properties, 5-21t, 5-25t
 - shrinkage values, 4-8t
 - uses, 2-37
 - workability, 2-37

- Specific gravity:
 and paintability of wood, 16-1, 16-2 to 16-7
 and weathering of wood, 16-11
 coefficient of variation, 4-7, 4-9, 4-9t, 5-26t
 definition, 4-7
 density as a function of, 4-9t, 4-11t
 influence on mechanical properties, 5-26, 5-29t
 moisture content, 4-1, 4-3fig, 4-5fig of reaction wood, 5-31
- Speed of sound, 5-17
- Sphaeroma, 14-14
- Spikes, 8-9
- Spiral grain, 5-30, 5-30fig
- Splits:
 in lumber stress grading, 7-4
- Spruce, black:
 dimensional change coefficient, 13-16t
 mechanical properties, 5-14t, 5-15t
 moisture content, 4-2t
 shrinkage values, 4-6t
 strength properties, 5-8t, 5-13t
 thermal conductivity, 4-14t
- Spruce, Eastern:
 characteristics, 2-17
 flame spread index, 18-4t
 locality of growth, 2-17
 nomenclature, 6-14t
 species, 2-17
 uses, 2-17
 workability, 2-17
- Spruce, Engelmann:
 characteristics, 2-17
 characteristics for painting, 16-5t
 charring rate data, 18-14t
 connector joint strength, 8-21t
 dimensional change coefficient, 13-16t
 elastic ratio, 5-2t
 erosion of planed surfaces, 16-12t
 locality of growth, 2-17
 mechanical properties, 5-14t, 5-15t
 moisture content, 4-2t
 nomenclature, 6-14t
 penetration, 15-16t
 Poisson ratio, 5-3t
 shock resistance, 2-17
 shrinkage values, 4-6t
 strength properties, 5-8t, 5-13t
 tensile strength, 5-26t
 thermal conductivity, 4-14t
 toughness values, 5-28t
 uses, 2-17
- Spruce, red:
 connector joint strength, 8-21t
 dimensional change coefficient, 13-17t
 fracture toughness, 5-28t
 mechanical properties, 5-14t, 5-15t
 moisture content, 5-34t
 shrinkage values, 4-6t
 strength properties, 5-8t, 5-13t
 thermal conductivity, 4-14t
- Spruce, Sitka:
 characteristics, 2-17 to 2-18
 connector joint strength, 8-21t
 dimensional change coefficient, 13-17t
 ease of bonding, 10-7t
 elastic ratio, 5-2t
 flame spread index, 18-4t
 locality of growth, 2-17
 mechanical properties, 5-14t, 5-15t
 moisture content, 4-2t, 5-34t
 nomenclature, 6-14t
 penetration, 15-16t
 Poisson ratio, 5-3t
 shock resistance, 2-18
 shrinkage values, 4-6t
 strength properties, 2-18, 5-8t, 5-13t
 tensile strength, 5-26t
 thermal conductivity, 4-14t
 uses, 2-18
- Spruce, white:
 connector joint strength, 8-21t
 dimensional change coefficient, 13-17t
 mechanical properties, 5-14t, 5-15t
 penetration, 15-16t
 strength properties, 5-8t, 5-13t
 thermal conductivity, 4-14t
- Stability:
 beams:
 water ponding, 9-9, 9-9eq
 lateral-torsion buckling, 9-9 to 9-10, 9-9eq, 9-10t
 deck support, effect of, 9-9, 9-9eq, 9-10fig
 built-up and spaced columns, 9-8, 9-8eq
 column flanges, 9-8, 9-8eq
 long columns, 9-7, 9-7eq
 interaction of buckling modes, 9-9 to 9-10, 9-9eq, 9-10eq
 short columns, 9-7 to 9-8, 9-8eq, 9-8fig
- Stain:
 penetrating:
 use on exterior plywood, 16-9
 semi-transparent:
 application and maintenance, 16-19t, 16-19 to 16-20
 discussed, 16-17
 refinishing, 16-18 to 16-20
 solid color:
 and mill glaze, 16-26 to 16-27
 application and maintenance, 16-19t, 16-19 to 16-20
 discussed, 16-22
 reconstituted wood products, 16-25
 refinishing, 16-22
 use on floors, 16-33 to 16-34
- Stains. *See also* Discoloration
- Stains, chemical, discussed 14-2
- Stains, fungal:
 blue, 16-30
 discussed, 14-1 to 14-2
 distinction from mold, 14-2
 during drying, 13-10, 13-13fig
 effect on wood, 14-2
- Stains, iron, 16-30
- Stake tests with preservatives, pressure-treated, 15-7t to 15-8t
- Standard lengths of lumber, 6-3
- Standard lumber abbreviations, 6-23 to 6-25
- Standard thicknesses of lumber:
 for flooring, 6-6
 table, 6-6t
- Standard widths of lumber, 6-3
- Staples, 8-9 to 8-10
- Starch adhesive, structural performance, 10-11t to 10-13t
- Staywood, 19-10
- Staypak:
 appearance, 19-10
 dimensional stability, 19-9t
 properties, 19-6t, 19-9 to 19-10
 purpose, 19-10
 strength properties, 19-7t to 19-8t
 uses, 19-10
- Sterilization of wood. *See* Heat sterilization
- Sticker stain during drying, 13-10, 13-14fig
- Stiffeners and glulam beam construction, 17-7
- Stiffness, affected by knots, 7-4
- Storage of lumber:
 care in yards, 13-14 to 13-15, 14-7
 green or partially seasoned, 13-14
 storage shed temperature, 13-14t
- Storing lumber:
 finish and factory items, 13-14
 sheathing and structural items, 13-14
- Strength and duration of load adjustments, 7-12
- Strength ratio:
 definition, 7-3
 equations, 7-6, 7-6fig
 estimating, 7-5
 ranges in visual grading, 7-6
- Strength properties:
 bird pecks, effect of, 5-33
 compression failures, effect of, 5-33
 creep, 5-39
 dead trees, 5-34
 derived for small clear wood, 7-5
 duration of load, effect, 5-39 to 5-40
 extractives, effect of, 5-34
 fire-retardant treatments, 5-41 to 5-42
 for commercially important woods, 5-4t to 5-13t
 insect damage, effect of, 5-44
 juvenile wood, 5-32 to 5-33
 knots, effect of, 5-26 to 5-28

Index

- moisture content as related to, 5-5
- nuclear radiation, 5-43
- pitch pockets, effect of, 5-33
- rate of loading, 5-38
- slope of grain, 5-28 to 5-31
- treatment, effect of, 7-13
- Strength, related to slope, 5-31t
- Stress equations:
 - axial load:
 - tensile stress, 9-4, 9-4eq
 - short-block compressive stress, 9-4, 9-4eq
 - bending:
 - notches, slits and holes, effect 9-6 to 9-7
 - size effect, 9-5, 9-5eq
 - straight beam stresses, 9-4
 - tapered beam stresses, 9-4 to 9-6, 9-5fig, 9-5eq, 9-6eq
 - time effects, 9-6
 - water ponding, 9-6
 - combined bending and axial load:
 - concentric load, 9-6, 9-6eq
 - eccentric load, 9-7, 9-7eq
 - torsion, 9-7, 9-7fig, 9-7eq
- Stress-graded lumber, American Standard lumber sizes, 6-11t
- Stress grading:
 - American Lumber Standard Committee (ALSC):
 - accredited rules-writing and independent agencies, 7-2t
 - American Softwood Standard, 7-2
 - National Grading Rule, 7-3, 7-3t
 - American Society of Testing and Materials (ASTM):
 - calculating clear wood properties for visual stress grades, 7-3
 - design properties, 7-1
 - strength ratio, 7-3
 - U.S. responsibility structure, 7-2, 7-2fig
- Stress, relationship between constant load and failure, 5-39 to 5-40, 5-39fig, 5-40fig
- Structural composite lumber (SCL) in bridges, 17-9
- Structural flakeboard and light-frame construction, 17-3
- Sucupira:
 - characteristics, 2-37
 - decay resistance, 14-5t
 - ease of bonding, 10-7t
 - locality of growth, 2-37
 - mechanical properties, 5-21t, 5-25t
 - resistance to fungi and insects, 2-37
 - shrinkage values, 4-8t
 - uses, 2-37
 - workability, 2-37
- Sugarberry (*See also* Hackberry)
- Suradan. *See* Pilon
- Sweetgum:
 - characteristics, 2-9
 - characteristics for painting, 16-5t
 - connector joint strength, 8-21t
 - decay resistance, 14-5t
 - dimensional change coefficient, 13-16t
 - ease of bonding, 10-7t
 - elastic ratio, 5-2t
 - flame spread index, 18-4t
 - interlocked grain, 2-9
 - locality of growth, 2-9
 - moisture content, 4-2t
 - penetration, 15-16t
 - shock resistance, 2-9
 - shrinkage values, 4-6t
 - strength properties, 5-6t, 5-11t
 - thermal conductivity, 4-13t
 - toughness values, 5-27t
 - uses, 2-9
- Swelling, coefficient for changing moisture content, by species, 13-16t to 13-17t
- Sycamore:
 - characteristics for painting, 16-5t
 - decay resistance, 14-5t
 - ease of bonding, 10-7t
 - nomenclature, 6-5t
- Sycamore, American:
 - characteristics, 2-9
 - connector joint strength, 8-21t
 - dimensional change coefficient, 13-16t
 - locality of growth, 2-9
 - moisture content, 4-2t
 - penetration, 15-16t
 - shock resistance, 2-9
 - shrinkage values, 4-6t
 - strength properties, 5-6t, 5-11t
 - thermal conductivity, 4-13t
 - uses, 2-9
- Tamarack:
 - characteristics, 2-18
 - characteristics for painting, 16-5t
 - decay resistance, 14-5t
 - dimensional change coefficient, 13-17t
 - locality of growth, 2-18
 - mechanical properties, 5-14t, 5-15t
 - moisture content, 4-2t, 5-34t
 - nomenclature, 6-14t
 - penetration, 15-16t
 - shrinkage values, 4-6t
 - strength properties, 5-8t, 5-13t
 - uses, 2-18
- Tangare. *See* Andiroba
- Tanoak:
 - characteristics, 2-9 to 2-10
 - decay resistance, 14-5t
 - dimensional change coefficient, 13-16t
 - locality of growth, 2-9
 - machinability, 2-10
 - nomenclature, 6-5t
 - shrinkage values, 4-6t
 - strength properties, 2-9, 5-6t, 5-11t
 - uses, 2-10
- Teak:
 - characteristics, 2-37 to 2-38
 - decay resistance, 14-5t
 - dimensional change coefficient, 13-17t
 - ease of bonding, 10-7t
 - locality of growth, 2-37
 - machinability, 2-38
 - mechanical properties, 5-21t, 5-25t
 - shrinkage values, 4-8t
 - uses, 2-38
- Tebuconazole:
 - effectiveness, 15-9
 - solubility, 15-9
- Temperature, effect on:
 - fatigue strength, 5-40 to 5-41
 - mechanical properties:
 - irreversible effects, 5-37 to 5-38, 5-38fig
 - reversible effects, 5-35 to 5-36, 5-36fig
 - properties, 7-13, 7-13t
 - relative humidity and moisture content, 4-4t
- Tensile strength, end-grain bonded joints, 10-18
- Tensile strength parallel to grain:
 - average values, 5-26t
 - coefficient of variation, 5-26t
 - defined, 5-3
- Tensile strength perpendicular to grain, 5-3
- Tension wood:
 - definition, 5-32
 - density increase, 5-31
 - description, 5-32
 - effect on strength, 5-32
 - shrinkage, 5-32
- Texture of wood, 3-13 to 3-14
- Texture, effect on paintability, 16-6
- Termites:
 - damage caused by, 14-8t, 14-11fig
 - nonsubterranean, 14-12
 - subterranean, 14-11 to 14-12
 - termite-resistant wood, 14-12 to 14-13
- Thermal, conductivity of wood:
 - definition, 4-10
 - determination, 4-12
 - factors affecting, 4-10, 4-11
 - selected species, 4-13t to 4-14t
- Thermal diffusivity of wood, 4-12
- Thermal expansion, 4-14
- Thermal properties of wood, 4-10
- Thermoplastics and adhesion, 10-9 to 10-10
- Ties:
 - availability, 6-20
 - preservative penetration levels, 15-4t to 15-5t
 - service life, 6-23
 - sizes, 6-20

- standards and specifications, 6-18t
 strength properties, 7-14
 weight and volume, 6-21 to 6-22
- Timber:
 inventory, 2-2
 resources, 2-2
- Timber bridges:
 glulam, 17-7, 17-9, 17-9fig
 log stringer, 17-8
 sawn lumber, 17-9
 structural composite lumber, 17-9
- Timber buildings:
 arch structure, 17-8
 dome, 17-8, 17-8fig
 glulam beam, 17-7
 mill-type construction:
 fire resistance, 17-7
 specifications, 17-7
 timber frame houses, 17-6 to 17-7,
 17-7fig
- Timbers, recommended moisture content,
 13-3
- Timber from dead trees, properties of, 5-34
- Time, effect on strength:
 creep, 5-39
 duration of load, 5-39 to 5-40
- Tornillo:
 characteristics, 2-38
 decay resistance, 14-5t
 locality of growth, 2-38
 mechanical properties, 5-21t, 5-25t
 uses, 2-38
 workability, 2-38
- Torsion, strength, 5-15
- Toughness:
 average values, 5-27t, 5-28t
 coefficient of variation, 5-26t
 defined, 5-25
- Tracheids, description and function, 3-9
- Transverse and volumetric shrinkage of
 wood, 4-5 to 4-7
- Treated wood recycling and disposal,
 15-26
- Trebol. *See* Macawood
- Trim, exterior:
 care during construction, 13-19
 recommended moisture content, 13-5t
- Trusses:
 care during construction, 13-8 to 13-19
 in light-frame construction, 17-4
 in pole and post-frame construction,
 17-4 to 17-6
- Truss plates, 8-25, 8-25fig
- Tupelo:
 characteristics, 2-10
 connector joint strength, 8-21t
 locality of growth, nomenclature, 6-5t
 shock resistance, 2-10
 species, 2-10
 uses, 2-10
- Tupelo, black:
 dimensional change coefficient, 13-16t
 moisture content, 4-2t
 shrinkage values, 4-6t
 strength properties, 5-6t, 5-11t
 thermal conductivity, 4-13t
- Tupelo, swamp, moisture content, 4-2t
- Tupelo, water:
 dimensional change coefficient, 13-16t
 moisture content, 4-2t
 shrinkage values, 4-6t
 strength properties, 5-6t, 5-11t
 thermal conductivity, 4-13t
- Urea and dimethylol urea for plasticizing
 wood, 19-1
- Urea adhesives:
 performance over time, 10-21 to 10-22,
 10-22fig
 structural performance, 10-11t to 10-13t
 use with composite products, 11-3
 working and strength properties, and
 uses, 10-11t to 10-13t
- Van der Waal's forces, 10-1 to 10-2
- Varnish:
 application and maintenance, 16-19t
 clear, 16-21
 use on boats, 16-25
 use on floors, 16-33 to 16-34
- Veneer:
 and adhesion, 10-3 to 10-4
 use with plywood, 11-5
- Veneered curved members, 19-3
- Ventilation and anobiids, 14-10
- Vertical-grained lumber. *See* Edgegrained
 lumber
- Vessel:
 definition, 2-2
 function, 3-10 to 3-11
- Vibration properties, 5-17
- Virola. *See* Banak
- Visual grades in the National Grading
 Rule, 7-3t
- Visual grading:
 deriving strength properties for small
 clear wood, 7-5 to 7-6, 7-5fig
 deriving modulus of elasticity for small
 clear wood, 7-5, 7-6fig
 in-grade procedures, 7-7
 sorting criteria, 7-3 to 7-4
- Visual sorting criteria in lumber stress
 grading:
 checks and splits, 7-4
 decay, 7-5
 density, 7-5
 explanation, 7-3
 heartwood and sapwood, 7-5
 knots, 7-3 to 7-4
 pitch pockets, 7-5
- shakes, 7-4
 slope of grain, 7-4
 wane, 7-5
- Waika. *See* Manni
- Walele. *See* Ilomba
- Wallaba:
 characteristics, 2-38
 decay resistance, 14-5t
 ease of bonding, 10-7t
 locality of growth, 2-38
 machinability, 2-38
 mechanical properties, 5-21t, 5-25t
 resistance to insects, 2-38
 shrinkage values, 4-8t
 uses, 2-38
- Walnut, black:
 availability at retail yards, 6-16
 characteristics, 2-10
 characteristics for painting, 16-5t
 decay resistance, 14-5t
 dimensional change coefficient, 13-16t
 ease of bonding, 10-7t
 elastic ratio, 5-2t
 kiln drying schedule, 13-11t
 locality of growth, 2-10
 moisture content, 4-2t
 nomenclature, 6-5t
 Poisson ratio, 5-3t
 shock resistance, 2-10
 shrinkage values, 4-6t
 strength properties, 5-6t, 5-11t
 uses, 2-10
 workability, 2-10
- Wane in lumber stress grading, 7-5
- Wapa. *See* Wallaba
- Warp:
 and finishing, 16-13 to 16-14
 and weathering, 16-11
 during drying, 13-7
- Waterborne preservatives. *See*
 Preservatives, waterborne
- Waterponding, effect on bending stress, 9-8
- Water repellants (*See also* water repellent
 preservative):
 application and maintenance, 16-19t,
 16-20
 discussed, 16-13
 moisture-excluding coatings, different
 from, 16-13
 used as a finish, 16-13
- Water-repellent preservatives:
 application and maintenance, 16-19t
 as a first step in finishing, 16-11
 back-priming, 16-25
 caution in use, 16-25
 effect of use on window sash and frame,
 16-18fig
 on wood exposed to marine
 environments, 16-24 to 16-25

Index

- paintability, 16-24 to 16-25
- refinishing, 16-25
- used as a finish, 16-25
- use on edges of reconstituted wood products, 16-10
- use on end grain, 16-6fig
- Wax in composite products, 11-5
- Weathering of wood:
 - and mill glaze, 16-26 to 16-27
 - artist's rendition of, 16-11fig
 - as a natural finish, 16-16
 - effect on extractives, 16-7
 - effect on lignin, 16-11
 - effect on paint adhesion, 16-12
 - erosion rates for hardwoods and softwoods, 16-12t
 - in marine environments, 16-24 to 16-25
 - of finishes, 16-16
 - process, 16-24
 - warp, 16-12 to 16-13
- Western redcedar, used for poles, 6-19
- White-cedar:
 - Atlantic. *See* Cedar, Atlantic white
 - Northern. *See* Cedar, Northern white
- White rot, 14-4
- Willow, black:
 - characteristics, 2-10
 - decay resistance, 14-5t
 - dimensional change coefficient, 13-16t
 - ease of bonding, 10-7t
 - locality of growth, 2-10
 - nomenclature, 6-5t
 - penetration, 15-16t
 - shock resistance, 2-10
 - shrinkage values, 4-6t
 - strength properties, 5-6t, 5-11t
 - toughness values, 5-27t
 - uses, 2-10
- Withdrawal resistance:
 - of lag screws, 8-12 to 8-13
 - of nails, 8-2 to 8-5
 - of wood screws, 8-10 to 8-11
- Wood buildings, consideration:
 - moisture control:
 - effect on heat flow, 17-11
 - mold, mildew, mites and health, 17-10
 - moisture control strategies, 17-11
 - paint failure and appearance problems, 17-11
 - structural failure, 17-11
 - sound control, 17-11 to 17-12, 17-12t
 - structural performance and serviceability, 17-9 to 17-10
 - thermal insulation and air infiltration control, 17-9 to 17-10
- Wood cells. *See* cells of wood
- Wood cleaners and brighteners, 16-34 to 16-35
- Wood Components Manufacturers Association, 6-4, 6-4t
- Wood fillers, 16-33
- Wood identification, 3-16
- Wood-thermoplastic composites:
 - materials, 11-25
 - production, 11-26
 - with high thermoplastic composites:
 - advantages, 11-26
 - compounding, 11-26
 - disadvantages, 11-26
 - manufacture, 11-26
 - mechanical properties, 12-9t
 - specific gravity, 12-9t
 - with low thermoplastic composites:
 - manufacture, 11-27
- Wood screws. *See* screws, wood
- Work to maximum load in bending, 5-3
- Yang. *See* Keruing
- Yellow-cedar. *See* Cedar, yellow
- Yellow-poplar:
 - characteristics, 2-10 to 2-11
 - characteristics for painting, 16-5t
 - charring rate data, 18-14t
 - connector joint strength, 8-21t
 - decay resistance, 14-5t
 - dimensional change coefficient, 13-16t
 - ease of bonding, 10-7t
 - elastic ratio, 5-2t
 - erosion of planed surfaces, 16-12t
 - flame spread index, 18-4t
 - fracture toughness, 5-27t, 5-28t
 - locality of growth, 2-10
 - moisture content, 4-2t
 - penetration, 15-16t
 - Poisson ratio, 5-3t
 - shock resistance, 2-11
 - shrinkage values, 4-6t
 - strength properties, 5-6t, 5-11t
 - thermal conductivity, 4-13t
 - toughness values, 5-27t
 - uses, 2-11
- Zinc-coated nails, 8-3
- Zinc naphthenate:
 - effectiveness, 15-11
 - inappropriate uses, 15-11
 - properties, 15-11

