

**PROPOSED AMENDMENTS TO THE HEXAVALENT CHROMIUM
AIRBORNE TOXIC CONTROL MEASURE FOR CHROME PLATING AND
CHROMIC ACID ANODIZING OPERATIONS**



Stationary Source Division
Air Quality Measures Branch

Release Date: August 11, 2006

To Be Considered by the Board: September 28, 2006

**State of California
AIR RESOURCES BOARD**

**STAFF REPORT: INITIAL STATEMENT OF REASONS
FOR PROPOSED RULEMAKING**

Public Hearing to Consider

**ADOPTION OF THE PROPOSED AMENDMENTS TO THE HEXAVALENT
CHROMIUM AIRBORNE TOXIC CONTROL MEASURE FOR CHROME
PLATING AND CHROMIC ACID ANODIZING OPERATIONS**

To be considered by the Air Resources Board on September 28, 2006, at:

California Environmental Protection Agency
Headquarters Building
1001 "I" Street
Sacramento, California

Stationary Source Division:

Robert Fletcher, P.E., Chief
Robert D. Barham, Ph.D., Assistant Division Chief
Janette Brooks, Chief, Air Quality Measures Branch
Carla D. Takemoto, Manager, Technical Evaluation Section

This report has been prepared by the staff of the Air Resources Board. Publication does not signify that the contents reflect the views and policies of the Air Resources Board, nor does mention of trade names or commercial products constitute endorsement or recommendation for use.

Acknowledgements

Contributing Authors

Shobna Sahni, M.P.H. (Lead)
Carla Takemoto
Reza Mahdavi, Ph.D.
Tony Servin, P.E.
Robert Barrera

Legal Counsel

Robert Jenne, Esq., Office of Legal Affairs

We are particularly grateful to Mr. Jose Mauro Saldana for his untiring assistance in the preparation of this report.

We also wish to acknowledge the participation and assistance of:

Metal Finishing Association of Southern California
Surface Technology Association

We would also like to acknowledge the participation and assistance of air pollution control and air quality management districts. In particular, we would like to thank the individuals at the following districts that participated in the ARB/District Working Group:

Richard Wales, Antelope Valley Air Quality Management District
Randy Frazier, Bay Area Air Quality Management District
Karla Sanders, Feather River Air Quality Management District
Jose De Guzman and Mark Loutzenhiser,
Sacramento Metropolitan Air Quality Management District
Archie de la Cruz, Cara Bandera, Dave Byrnes,
San Diego County Air Pollution Control District
Chay Thao, Martin Keast, John Copp,
San Joaquin Valley Air Pollution Control District
Shasta County Air Quality Management District
Robert Gottschalk, Andrew Lee, Jay Chen, Susan Nakamura, Marco Polo,
Thomas Liebel, Joan Niertit, Jill Whynot, Mike Garibay, David Jones, and
Sam Vergara, South Coast Air Quality Management District
Terri Thomas, Ventura County Air Pollution Control District

For the emissions testing program we want to acknowledge the invaluable assistance of: Mr. Dominic Nole, Mr. Dan Cunningham, Mr. Dean High, Mr. Paramo Hernandez, Mr. Ray Lucas, Mr. Chad Medico, Mr. John Martin, and Mr. Ralph Hersher

We also acknowledge the assistance of the tested facilities: Sigma Plating, Excello Plating, Van Nuys Plating, Alta Plating, Sherm's Custom Chrome, Clovis Specialty Plating, Walker Custom Chrome

Numerous ARB staff helped in the emissions testing program and in development of this report. In particular we acknowledge: Alex Barber; Ron Barros; Nicholas Berger; Darryl Burns; Chris Clark; Monique Davis; Steve Eve; Cynthia Garcia; Marline Hicks; Chris Nguyen; Olufemi Olaluwoye; Johnnie Raymond; Don Ridgley; Betsy Ronsse; Peter Samra; Dale Shimp; David Todd, Source Testing Lead; Roxana Walker; Evan Wong; Glen Villa; Zuzana Vona

Table of Contents

Executive Summary	ES-1
I. Introduction	1
A. Overview	1
B. Goals of the Proposed Amendments	2
C. Regulatory Authority.....	3
D. Existing State Control Measure.....	5
E. Federal Regulations	6
F. Current Air District Rules.....	7
G. Barrio Logan, A Case Study of Near Source Impacts	9
H. Hexavalent Chromium Emissions Study and Conclusions.....	10
II. Need for Further Regulation.....	13
A. Characteristics, Sources, and Ambient Concentrations of Hexavalent Chromium and Chromium Compounds.....	14
B. Health Impacts	18
C. Barrio Logan: A Case Study of Near Source Impacts	19
D. Proximity of Facilities to Sensitive Receptors.....	20
III. Public Outreach and Data Collection	24
A. Public Involvement	24
B. Data Collection Tools	25
IV. Chromium Plating and Chromic Acid Anodizing Operations	28
A. Overview	28
B. Types of Chromium Operations	29
C. Data Resources	30
D. Industry Characterization	31

V.	Emissions.....	39
A.	Overview	39
B.	Emission Factor Background	39
C.	Emissions Testing Program	40
D.	Statewide Hexavalent Chromium Emissions.....	47
E.	Fugitive Emissions	49
VI.	Reducing Hexavalent Chromium Emissions	52
A.	In-tank Controls.....	52
B.	Add-on Air Pollution Control Devices	58
C.	Alternative Processes.....	59
VII.	Health Risk Assessment	66
A.	Overview	66
B.	Health Risk Assessment Process	66
C.	Factors that Affect Health Risk Assessments.....	73
D.	Cancer Risk Assessment	74
E.	Non-Cancer Risk Assessment	75
VIII.	Proposed Risk Reduction Approach and Benefits.....	78
A.	Best Available Control Technology	78
B.	Emissions and Cancer Risk Reduction Benefits	80
C.	Other Aspects of the Staff’s Proposal	82
IX.	Proposed Amendments and Alternatives	84
A.	Summary of the Existing Airborne Toxic Control Measure.....	84
B.	Summary of the Proposed Amendments.....	84
C.	Basis for the Proposed Amendments.....	97
D.	Alternatives to the Proposed Amendments	97
E.	Recommendation	101

X.	Economic Impacts.....	103
A.	Summary of the Economic Impacts.....	103
B.	Economic Impact Analysis	104
XI.	Environmental Impacts.....	118
A.	Legal Requirements	118
B.	Analysis of Reasonably Foreseeable Environmental Impacts.....	119
C.	Reasonably Foreseeable Mitigation Measures	122
D.	Reasonably Foreseeable Alternative Means of Compliance	123
E.	Community Health and Environmental Justice.....	123

List of Tables

Table ES-1. Sixty-three Facilities have Estimated Cancer Risk of Over 10 per Million Exposed People (2005 Baseline)	8
Table ES-2. Proposed Hexavalent Chromium Emission Limits for Existing Facilities	11
Table ES-3. Adoption of Staff’s Proposal Significantly Reduces the Estimated Cancer Risk from Hexavalent Chromium Emissions	13
Table ES-4. Adoption of Staff’s Proposal Offers the Greatest Reduction in Significant Community Cancer Risk	18
Table I-1. Air Districts with Active Chromium Plating and/or Anodizing Facilities and Corresponding Prohibitive Rule	8
Table II-1. Hexavalent Chromium Mean Concentration in Air Districts with Chromium Plating and Anodizing Facilities for the Year 2005.....	16
Table IV-1. Description of Hexavalent Chromium Operations.....	30
Table IV-2. Number of Operations by Plating Type.....	32
Table IV-3. Hexavalent Chromium Plating Type and Ampere-hours (2003)	33
Table IV-4. Number of Employees at Chromium Plating and Chromic Acid Anodizing Facilities.....	37
Table V-1. Decorative Chromium Plating Emission Factors in Existence Prior to ARB Testing Program (milligrams/ampere-hour)	40
Table V-2. Average Hexavalent Chromium Emission Rates and Selected Testing Parameters for Phase 1.....	41
Table V-3. Average Hexavalent Chromium Emission Rates and Selected Testing Parameters for Phase II.....	44
Table V-4. Chemical Fume Suppressants Approved for Use at Specified Surface Tensions.....	45
Table V-5. Plating Bath Contaminants, Concentration Levels Where Bath Clean-up is Recommended, and Hexavalent Chromium Emission Rates	47
Table V-6. Summary of Indoor Air Results During Emissions Testing Program.....	50

Table VI-1.	Types of Chemical Fume Suppressants Used in California in 2003.....	56
Table VI-2.	Summary of Chemical Fume Suppressant Mechanism of Control and Recommended Surface Tension	57
Table VI-3.	Cost Estimate for Conversion to Trivalent Chromium.....	61
Table VII-1.	Inhalation Cancer Potency Factors for Common Carcinogens.....	67
Table VII-2.	Hexavalent Chromium Health Effects Values Used in Non-Cancer Health Risk Assessment.....	68
Table VII-3.	Key Parameters for Air Dispersion Modeling and Health Risk Assessment.....	70
Table VII-4.	Generic Facility Parameters for Air Dispersion Modeling and Health Risk Assessment.....	71
Table VII-5.	Key Parameters for Assessing Estimated Cancer and Non-Cancer Health Impacts for Chromium Plating and Chromic Acid Anodizing Facilities.....	73
Table VII-6.	Sixty-three Facilities have Estimated Cancer Risk of Over 10 per Million Exposed People (2005 Baseline)	75
Table VIII-1.	Adoption of Staff’s Proposal Significantly Reduces the Estimated Cancer Risk from Hexavalent Chromium Emissions	81
Table VIII-2.	Adoption of Staff’s Proposal Significantly Reduces the Estimated Cancer Risk from Hexavalent Chromium Emissions for Off-Site Workers.....	81
Table IX-1.	Definitions Proposed for Modification	86
Table IX-2.	New Definitions Proposed for Addition	86
Table IX-3.	Proposed Hexavalent Chromium Emission Limits for Existing Facilities	89
Table IX-4.	Chemical Fume Suppressants Approved for Use at Specified Surface Tensions.....	94
Table IX-5.	Adoption of Staff’s Proposal Offers the Greatest Reduction in Significant Community Cancer Risk.....	100
Table X-1.	Estimated Compliance Costs (Other than Those for Add-On Air Pollution Control Devices)	106
Table X-2.	Costs for HEPA Add-on Air Pollution Control Devices.....	107
Table X-3.	Number of Affected Hexavalent Chromium Plating and Chromic Acid Anodizing Facilities by Air District.....	114

Table XI-1. Distribution of Chromium Plating and Chromic Acid Anodizing
Facilities in the Los Angeles and Orange County Areas..... 124

List of Figures

Figure ES-1. Location and Type of Operation Performed at Chromium Plating and Chromic Acid Anodizing Facilities in California (2003)	5
Figure ES-2. Throughput (in Ampere-hours) for Chromium Plating and Chromic Acid Anodizing Facilities in California (2003).....	6
Figure ES-3. Baseline Hexavalent Chromium Emissions are About Four Pounds (2005).....	7
Figure ES-4. Forty-three Percent of Facilities are Located Near Sensitive Receptors	9
Figure IV-1. Main Components of an Electroplating Tank.....	29
Figure IV-2. Distribution of Chromium Operations by District (2003).....	31
Figure IV-3. Distribution of Hexavalent Chromium Operations by Type (2003).....	32
Figure IV-4. Throughput (in Ampere-hours) for Chromium Plating and Chromic Acid Anodizing Facilities in California (2003).....	33
Figure IV-5. Distribution of Emission Controls by Type of Chromium Operation	34
Figure IV-6. Distance (in Meters) Between Hexavalent Chromium Facilities and the Nearest Sensitive Receptor	36
Figure IV-7. Gross Annual Revenue for Hexavalent Chromium Plating and Anodizing Facilities (2003)	37
Figure V-1. Temporary 'Hood' for Capturing Hexavalent Chromium Emissions at Decorative Chromium Plating Facilities	43
Figure V-2. Statewide Hexavalent Chromium Emissions in 2003 Were 14.4 Pounds.....	48
Figure VII-1. Percent Concentration of Hexavalent Chromium at Increasing Distances from the Source	72
Figure VIII-1. Comparison of Cancer Risks (MICR) Remaining After Application of Controls at Various Throughputs	79

List of Appendices

- Appendix A: Proposed Regulation Order for the Proposed Amendments to the Chromium Plating ATCM
- Appendix B: Chronology of Meetings
- Appendix C: Industry Survey Form
- Appendix D: Supplier Survey Form
- Appendix E: Economic Survey Forms
- Appendix F: Results of Emission Testing Program
- Appendix G: Results of SDCAPCD Dust Samples Collected from Hexavalent Chromium Plating Facilities
- Appendix H: Air Quality Modeling Parameters and Results
- Appendix I: Analysis of Proximity of Chromium Plating and Chromic Acid Anodizing Facilities in a Southern California Community

Executive Summary

The Air Resources Board (ARB) staff is proposing amendments to the Hexavalent Chromium Airborne Toxic Control Measure for Chrome Plating and Chromic Acid Anodizing Operations (Chromium Plating ATCM or ATCM). The amendments are proposed as a result of our evaluation of the 226 chromium plating and chromic acid anodizing facilities in California.

In 1986, the Board identified hexavalent chromium as a toxic air contaminant (TAC). Hexavalent chromium was determined to be an extremely potent human carcinogen with no known safe level of exposure. Only dioxin is a more potent carcinogen than hexavalent chromium. Exposure over a lifetime to very low hexavalent chromium concentrations can substantially increase a person's chance of developing cancer.

Due to its potential cancer risk, ARB has adopted a number of control measures for hexavalent chromium sources, including chromium plating and chromic acid anodizing facilities. The current ATCM reduced emissions of hexavalent chromium by over 90 percent, and in some cases by over 99 percent. Other air district programs have also reduced emissions of hexavalent chromium. As a result, ambient levels of hexavalent chromium are low and have been reduced by about 60 percent since the early 1990s.

Based on community concerns and the potency of hexavalent chromium, the staff has re-evaluated the current Chromium Plating ATCM. We found that people living near many of these facilities are exposed to unacceptable concentrations of hexavalent chromium. Our evaluation showed that 43 percent of chromium plating and chromic acid anodizing operations are located within 100 meters of sensitive receptors and about 30 percent of the facilities have emissions sufficient to produce a potential cancer risk of greater than ten per million exposed people. The data also show that the chromium plating facilities are often located in low income and ethnically diverse communities.

In the evaluation, we also found that reliable add-on air pollution control devices, such as high efficiency particulate arrestor (HEPA) filters, are available. These controls now represent best available control technology (BACT) for intermediate and large sized facilities that can result in higher community risks. BACT for smaller facilities, those with emissions that can relatively easily be controlled to the levels needed to keep community risk low (under one per million), is use of specific chemical fume suppressants. In our proposal, all 226 facilities would be affected; 89 of those facilities would need to meet an emission limit equivalent to that achieved by HEPA filters and another 48 facilities would have to use specific chemical fume suppressants. The other facilities are in substantial compliance. The requirements would be phased-in over time, with facilities close to receptors having to install BACT in two years, versus five years for other facilities.

By requiring BACT for all facilities, remaining cancer risks would be reduced by up to 85 percent in communities close to facilities. We also estimate that adoption of the staff's proposal will reduce the estimated cancer risk for about 75 percent of facilities to no more than one per million exposed persons, with 92 percent of facilities having estimated cancer risks of less than ten per million exposed persons. The proposal would also

isolate new chromium plating or chromic acid anodizing facilities from people and require housekeeping measures to address fugitive emissions.

Staff has determined that costs for some individual businesses are expected to be significant and may adversely impact their profitability. Some smaller volume plating or anodizing businesses may decide to cease chromium plating or anodizing operations rather than make the investments needed to comply. This analysis assumes that affected facilities would install HEPA filters, although there may be less costly equivalent options available, and the facilities cannot recover their costs through increased prices.

This Executive Summary provides an overview of the staff's proposal, including the basis and rationale, key provisions, and the environmental and economic impacts. The staff report, entitled "Proposed Amendments to the Hexavalent Chromium Airborne Toxic Control Measure For Chrome Plating and Chromic Acid Anodizing Operations," presents detailed information related to the staff's proposal, as well as the proposed regulation order.

A. Background

1. What is chromium plating and chromic acid anodizing?

Hexavalent chromium plating, or simply chromium plating, is the electrical application of a coating of chromium onto a surface for decoration, corrosion protection, or for durability. An electrical charge is applied to a tank (bath) containing an electrolytic salt (chromium anhydride) solution. The electrical charge causes the chromium metal particles in the bath to fall out of solution and deposit onto objects placed in the plating solution. The most familiar type of chromium plating is the decorative chromium plating process which provides a bright, shiny finish onto objects such as wheels and plumbing fixtures. During chromic acid anodizing, an oxidation layer is generated on the surface of the part. These electrolytic processes cause mists containing hexavalent chromium to be ejected from the plating tank which are eventually emitted into outdoor air.

2. What is hexavalent chromium?

Hexavalent chromium is the cation of a metal salt and does not occur naturally. Generally, hexavalent chromium ions are produced under strong oxidizing conditions from metallic chromium, with the most common ions being chromate ion (CrO_4^{-2}) or dichromate ion ($\text{Cr}_2\text{O}_7^{-2}$). Unlike many pollutants which are gases, hexavalent chromium is a particle.

3. How is hexavalent chromium emitted from the plating/anodizing process?

In the chromium plating process, only about 20 percent of the electrical current applied actually deposits chromium onto the part. The remaining current forms bubbles, hydrogen gas at the cathode and oxygen at the anode, that rise to the surface of the bath. As these bubbles burst, hexavalent chromium is emitted into the air.

4. Why are we concerned about emissions of hexavalent chromium?

Hexavalent chromium is a known human carcinogen. Prolonged exposure causes lung cancer. The Board identified hexavalent chromium as a TAC in 1986. A cancer unit risk factor of $0.15 (\mu\text{g}/\text{m}^3)^{-1}$ was developed in support of the TAC identification by the Office of Environmental Health Hazard Assessment (OEHHA) and approved by the Scientific Review Panel on TACs. This value means that a person's chance of developing cancer due to exposure to $1 \mu\text{g}/\text{m}^3$ of hexavalent chromium over a 70 year lifetime would be 146,000 chances per million people, almost 15 percent. Only one other identified TAC, dioxin, has been determined more likely to cause cancer than hexavalent chromium. When the Board designated hexavalent chromium as a TAC, they further determined that there was no known level of exposure that would be considered safe.

5. What does State law require ARB to do to reduce the public's exposure to toxic air contaminants?

Health and Safety Code section 39666 requires ARB to adopt control measures to reduce emissions of TACs. When adopting or amending ATCMs for TACs, if no safe threshold exposure level is identified, the ATCM is to reduce emissions to the lowest level achievable through the application of BACT or a more effective control method, in consideration of health risk and cost.

6. What does the current ATCM require?

Originally adopted in 1988 and amended in 1998, the Chromium Plating ATCM set forth the requirements for reducing hexavalent chromium emissions based on the type of operation. Most hard chromium plating facilities were required to reduce hexavalent chromium emissions by 99 percent or more. This was achieved through installation of add-on air pollution control devices. Decorative chromium plating and chromic acid anodizing facilities were required to reduce uncontrolled emissions by at least 95 percent. However, they were not required to use add-on air pollution control devices. A brief summary of the requirements follows:

- Hard chromium plating facilities are required to install add-on air pollution control devices to meet emission limits ranging from 0.15 milligrams/ampere-hour to 0.006 milligrams/ampere-hour, depending on levels of throughput. An alternative surface tension limit was provided for hard chromium plating facilities with throughput levels of 500,000 ampere-hours or less; and
- Decorative plating and chromic acid anodizing facilities must comply with either an emission limit using add-on air pollution control devices or meet a surface tension limit. Most facilities comply by using chemical fume suppressants to meet the surface tension limit.

The ATCM was amended in 1998 to establish equivalency with the National Emission Standards for Chromium Emissions from Hard and Decorative Chromium Electroplating and Chromium Anodizing Tanks (Chromium Plating NESHAP) (U.S. EPA, 1995).

Therefore, chromium plating and chromic acid anodizing facilities are only subject to California's Chromium Plating ATCM.

7. Why did ARB staff decide to evaluate the existing ATCM?

Due to the carcinogenicity of hexavalent chromium, and in response to community concerns, ARB staff undertook an evaluation of the Chromium Plating ATCM. The staff evaluated if people located near chromium plating or chromic acid anodizing facilities were adequately protected from emissions of hexavalent chromium. Staff also evaluated if technologies were available to reduce hexavalent chromium emissions, if necessary. As part of the evaluation, staff determined that 43 percent of the operations are located within 100 meters of a sensitive receptor, such as a residence or school. By conducting an emissions testing program and air quality modeling, staff determined that these sensitive receptors may be exposed to unacceptable hexavalent chromium concentrations. ARB staff also found that reliable add-on air pollution control devices such as HEPA filters are now available and are used by many facilities to reduce hexavalent chromium emissions.

Concurrent with the review of the Chromium Plating ATCM, unexpectedly high concentrations of hexavalent chromium were measured during an air monitoring study conducted near chromium plating facilities in San Diego. Through further air monitoring, the source of the high concentrations was determined to be the decorative chromium plating facility.

8. Have other regulatory actions affected the chromium plating and chromic acid anodizing industry?

Yes. In 2003, the South Coast Air Quality Management District (SCAQMD) adopted amendments to Rule 1469, entitled Hexavalent Chromium Emissions from Chromium Plating and Chromic Acid Anodizing Operations (SCAQMD, 2003). The amended rule requires hexavalent chromium facilities located within 25 meters of a sensitive receptor or within 100 meters of a school to reduce hexavalent chromium emissions so that the residential cancer risk will be no more than ten chances per million people. The rule also requires facilities located greater than 25 meters from a sensitive receptor or greater than 100 meters from a school to reduce emissions such that off-site worker cancer risk would be no more than 25 chances per million people. The amended rule is in full effect. To help meet the requirements, SCAQMD staff conducted a chemical fume suppressant certification program which established a list of products that could be used to meet an emission rate of 0.01 milligrams/ampere-hour.

As mentioned previously, a federal control measure is also in place to control emissions of chromium compounds from chromium plating and chromic acid anodizing facilities (U.S. EPA, 1995). The ARB has achieved equivalency with the Chromium Plating NESHAP.

The United States Department of Labor Occupational Safety and Health Administration (OSHA) established a Permissible Exposure Limit (PEL) to protect workers from

hexavalent chromium exposures. OSHA's time-weighted average PEL is $5 \mu\text{g}/\text{m}^3$, measured and reported as Chromium VI and an action level of $2.5 \mu\text{g}/\text{m}^3$ for the general industry.

B. The Chromium Plating and Chromic Acid Anodizing Industry in California

9. What are the results of the industry survey?

ARB staff conducted a survey of chromium plating and chromic acid anodizing facilities for calendar year 2003. Staff collected information on types of operations performed, emission rates, throughput in terms of annual ampere-hours, methods for controlling hexavalent chromium emissions, and economic information. Staff also conducted an emissions testing program to better characterize emissions of hexavalent chromium from decorative chromium plating operations.

Results of our survey showed that there were 228 active facilities, and 12 of these conduct more than one electroplating process. These 228 facilities perform 240 chromium related operations. This means, for example, that some facilities conduct both decorative and hard chromium plating. Ten operations use the trivalent chromium plating process to conduct decorative chromium plating. Of these ten operations, six facilities conduct only trivalent chromium plating. Four trivalent chromium operations are part of a facility that also conducts hexavalent chromium plating. The other 230 operations use the hexavalent chromium process. Of these operations 58 are hard chromium plating, 127 are decorative chromium plating, and 45 are chromic acid anodizing operations. Our survey findings are shown graphically in Figure ES-1 below.

Figure ES-1. Location and Type of Operation Performed at Chromium Plating and Chromic Acid Anodizing Facilities in California (2003)

Chart A: Facility Location

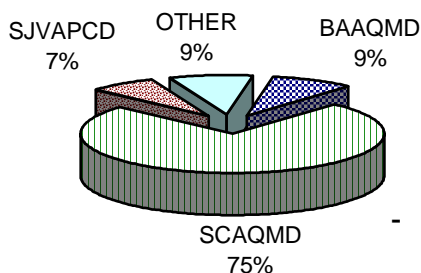

Chart B: Type of Operation

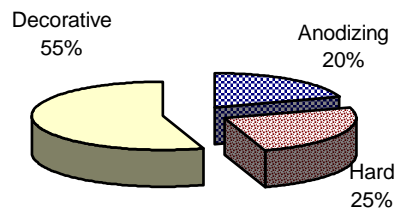
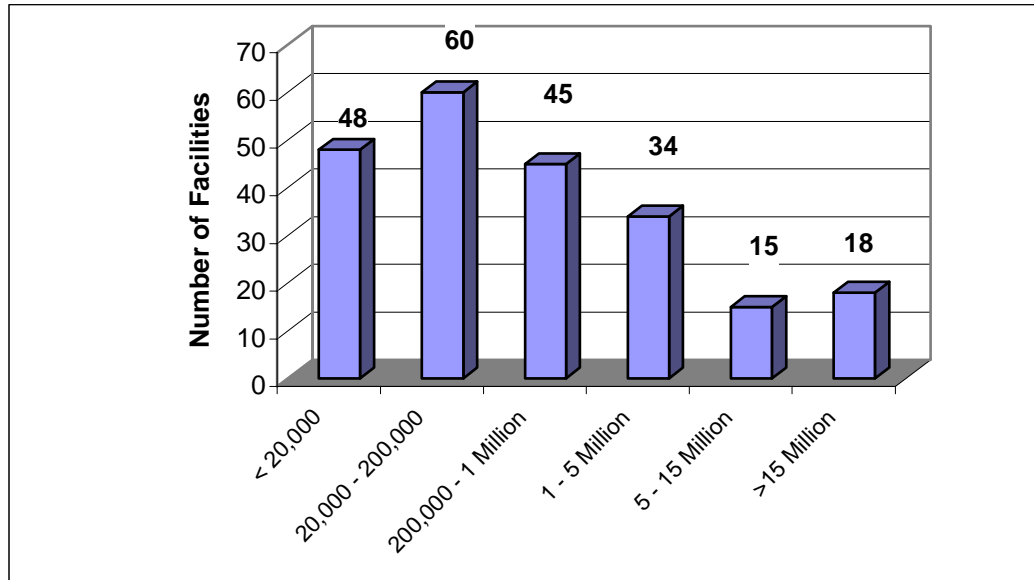

Figure ES-2 shows the distribution of the 222 hexavalent chromium plating and chromic acid anodizing facilities based on throughput. The six facilities conducting only trivalent chromium plating are not represented. Throughput is presented in ampere-hours. An

ampere-hour is a unit of amperes integrated over time. It is an important variable because it is used to determine the amount of hexavalent chromium emissions from a facility. The ampere-hours are multiplied by an emission rate to calculate emissions.

Figure ES-2. Throughput (in Ampere-hours) for Chromium Plating and Chromic Acid Anodizing Facilities in California (2003)



As shown in Figure ES-2, about 48 (about 20 percent) of facilities have annual throughput of 20,000 annual ampere-hours or less. Sixty facilities (27 percent) have throughput of between 20,000 to 200,000 annual ampere-hours. Over 50 percent of facilities have annual ampere-hours over 200,000.

10. What are the results from the decorative chromium plating emissions testing program?

The goal of the emissions testing program was to establish an emission rate for chromium plating and chromic acid anodizing tanks controlling hexavalent chromium emissions with chemical fume suppressants. Staff conducted six tests to estimate emissions based on normal facility operations. Averaging the emission rates from these six tests results in a hexavalent chromium emission factor of 0.04 milligrams/ampere-hour. These data are representative of 'real world' conditions.

Concurrent with our testing program, the SCAQMD tested the ability of chemical fume suppressants to reduce emissions under carefully controlled conditions. The purpose of this testing was to determine parameters that yielded optimum emission reductions. The SCAQMD demonstrated that hexavalent emissions can be further reduced if certain chemical fume suppressants are used. In fact, the SCAQMD demonstrated that several chemical fume suppressants could reduce emissions of hexavalent chromium to no more than 0.01 milligrams/ampere-hour. The surface tension at which this emission rate is achieved is at lower surface tension than currently required by the ATCM.

A seventh test was done to verify the SCAQMD results. The seventh test was conducted using the chemical fume suppressant Fumetrol 140®. The SCAQMD certified this chemical fume suppressant to reduce hexavalent chromium emissions to no more than 0.01 milligrams/ampere-hour when surface tension is maintained below 40 dynes/centimeter. In test seven, ARB was able to duplicate this emission rate. Based on this test result, as well as an evaluation of the SCAQMD source test data from their chemical fume suppressant certification program, ARB staff determined which chemical fume suppressants could be used as the sole control by some facilities to comply with the ATCM. These chemical fume suppressants have been shown to reduce hexavalent chromium emissions to no more than 0.01 milligrams/ampere-hour at specified surface tensions.

11. What are the emissions of hexavalent chromium from chromium plating and chromic acid anodizing facilities?

Staff developed the emission inventory for chromium plating and chromic acid anodizing facilities by using data from the survey. As explained previously, emissions of hexavalent chromium are determined based on throughput and are quantified in milligrams/ampere-hour. To develop the emission inventory, staff developed two emission factors for hexavalent chromium plating facilities controlling emissions by using chemical fume suppressants. We estimated emissions for these facilities by using the emission rate of 0.04 milligrams/ampere-hour for facilities outside SCAQMD. We used the emission factor of 0.01 milligrams/ampere-hour for SCAQMD facilities. The SCAQMD facilities are required to use chemical fume suppressants that meet this emission rate. Emissions from facilities with add-on air pollution control devices are based on source test results or regulatory requirements.

Figure ES-3. Baseline Hexavalent Chromium Emissions are About Four Pounds (2005)

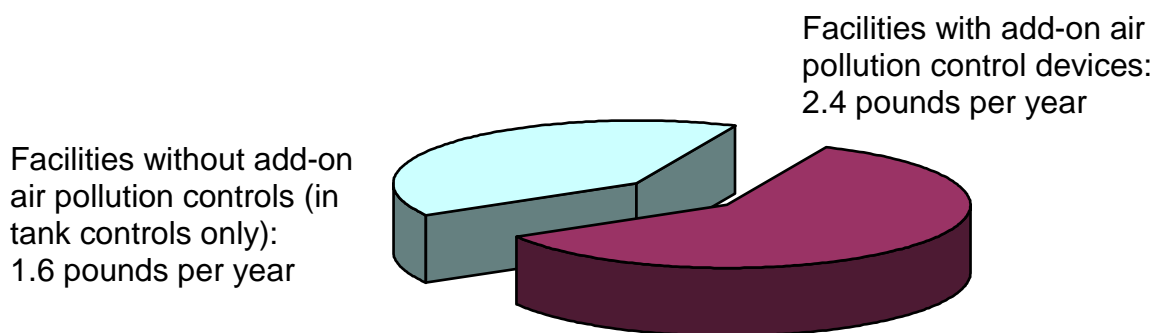

As shown in Figure ES-3, staff estimates that emissions of hexavalent chromium from chromium plating and chromic acid anodizing facilities in 2005 totaled 4.0 pounds, or about 1,800 grams.

12. Why is staff concerned about 4.0 pounds per year of emissions?

While the 4.0 pounds (1,800 grams) per year of emissions seems low, even a very small amount of hexavalent chromium can result in a substantial cancer risk. For example, staff found that as little as two grams of annual emissions would yield an estimated cancer risk of ten per million people exposed. As shown in Table ES-1, the maximum individual cancer risk (MICR) was determined for each chromium plating and chromic acid anodizing facility in California based on these 4.0 pounds of emissions. It should be noted that the MICR is calculated using the highest concentration of hexavalent chromium downwind of a facility that is predicted by an air quality model. People may not be living at the MICR point. Table ES-1 reflects implementation of the current ATCM and air district rules, including Rule 1469 for facilities in the South Coast Air Basin.

Table ES-1. Sixty-three Facilities have Estimated Cancer Risk of Over 10 per Million Exposed People (2005 Baseline)

Number of Facilities by Cancer Risk				
	≤ 1 per million	$>1 \leq 10$ per million	$>10 \leq 100$ per million	>100 per million
Baseline 2005	90	67	57	6

As shown in Table ES-1, 90 facilities (about 41 percent) have estimated cancer risk less than one per million exposed people. However, Table ES-1 also shows that 57 facilities (about 26 percent) have an estimated cancer risk of over ten per million exposed people. Six facilities (about 3 percent) may have an estimated cancer risk of over 100 per million people exposed.

Based on these results, staff determined that further risk reduction measures are necessary. While Rule 1469 reduced the estimated cancer risk for facilities in the SCAQMD, the rule had no impact on facilities in the rest of the state. We have also determined that Rule 1469 did not achieve the maximum reduction feasible because BACT was not required for all facilities.

13. Are sensitive receptors located within 100 meters of a chromium plating and chromic acid anodizing facility?

Yes. Near source exposures to chromium plating and chromic acid anodizing facilities are our primary health concern. ARB staff and the air districts worked together to determine the location of chromium plating and chromic acid anodizing facilities, and to determine the distance to the nearest residence, school, hospital, day care center, or similar sensitive receptor location. Figure ES-4 shows the proximity of facilities to sensitive receptors.

Figure ES-4. Forty-three Percent of Facilities are Located Near Sensitive Receptors

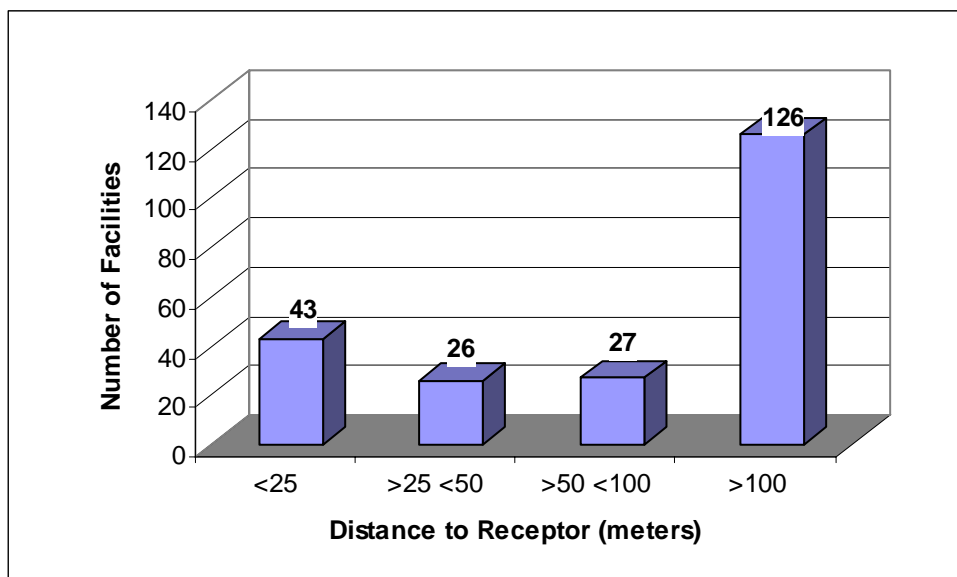

Figure ES-4 shows that 96 chromium plating and chromic acid anodizing facilities are located within 100 meters of a sensitive receptor. This represents 43 percent of the facilities. Forty-three facilities are located within 25 meters of a sensitive receptor.

C. Staff’s Proposal to Amend the Chromium Plating ATCM

14. How did staff determine the most effective approach to control?

Staff evaluated available add-on air pollution control technologies and alternative processes for hexavalent chromium plating and chromic acid anodizing to determine if cancer risk could be reduced or eliminated. While alternatives exist for some applications, their use is limited. Thus, we concluded that alternative technologies are not available that enable a phase-out of the hexavalent chromium process at this time. However, our analysis also shows that effective add-on air pollution control devices are readily available. These devices minimize the cancer risk to the extent technology allows.

Staff also conducted modeling analyses to determine how hexavalent chromium is dispersed from chromium plating and chromic acid anodizing facilities. The concentration of hexavalent chromium is highest near the facility, but the impacts of the emissions appear to be localized. We found that at 100 meters from the source hexavalent chromium concentrations are reduced by up to 90 percent.

To develop the proposal, staff conducted the health risk assessment in a manner which is very health protective in estimating cancer risks for a range of reasonably foreseeable exposure scenarios. Staff believes this health protective approach is necessary due to the very high potency and resultant serious health hazards associated with hexavalent chromium emissions. The goal of this proposal is to reduce cancer risk to as low as technology allows. Use of BACT will meet this goal.

15. What is best available control for (BACT) chromium plating and chromic acid anodizing facilities?

Staff has evaluated various types of add-on air pollution control devices. We also have evaluated the effectiveness of chemical fume suppressants through our emissions testing program. We have determined that BACT for very small facilities is use of specific types of chemical fume suppressants. BACT for intermediate and larger sized facilities is use of add-on air pollution control devices with the final capture device being HEPA filters. Use of HEPA filters will reduce hexavalent chromium emissions to no more than 0.0015 milligrams/ampere-hour. HEPA filters reduce emissions by over 99.9 percent. Any other combination of control devices that can meet this emission rate would be considered equivalent to BACT. These technologies are already employed by many chromium plating and chromic acid anodizing facilities. These control technologies are described below.

a. Chemical Fume Suppressants

Surface tension is the force that keeps a fluid together at the air/fluid interface. It is expressed in force per unit of width such as dynes/centimeter. Chemical fume suppressants that contain 'wetting agents,' or surfactants, reduce this surface tension. By reducing surface tension in the plating/anodizing bath, gas bubbles become smaller and rise more slowly than larger bubbles. Slower bubbles have reduced kinetic energy such that when the bubbles do burst at the surface the hexavalent chromium is less likely to be emitted into the air, and the droplets fall back onto the surface of the bath (Bayer®).

The most common types of surfactants used in chromium electroplating and chromic acid anodizing are fluorinated or perfluorinated compounds or fluorosurfactants (U.S. EPA, 1998). As proposed, the types of chemical fume suppressants that could be used for compliance with the ATCM would contain fluorosurfactants.

b. HEPA (High Efficiency Particulate Arrestor) Filters

HEPA filters are specifically designed for the collection of submicrometer particulate matter at high collection efficiencies. HEPA filters are rated at 99.97 percent effective in capturing particles 0.3 μm in diameter. When used in particulate air pollution control, HEPA filters are best utilized in applications with a low flow rate and low pollutant concentration. Typically, HEPA filters are installed downstream of another control device to lessen loading on the filter, thereby lengthening its life. HEPA filters are considered the most effective control of hexavalent chromium emissions from chromium plating and chromic acid anodizing.

16. What are the goals of the proposed amendments?

The goals of the proposed amendments are to achieve the maximum hexavalent chromium emission reduction from chromium plating and chromic acid anodizing facilities, ensure that new facilities are isolated from sensitive receptors, and reduce fugitive hexavalent chromium emissions.

17. How would the proposed amendments achieve these goals?

The proposed amendments would require use of BACT for all facilities. Use of HEPA filters, or other combinations of controls that are as effective as HEPA filters, represent BACT for intermediate and large throughput facilities. BACT for very small facilities is the use of ARB specified chemical fume suppressants. The requirements would be phased in based on throughput and proximity to sensitive receptors. Sensitive receptor locations include residences, schools, daycare centers, hospitals, hospices, retirement or nursing homes, prisons and dormitories.

The proposal would also prevent new hexavalent chromium plating and chromic acid anodizing facilities from operating in areas zoned as residential or mixed use or within 150 meters (~500 feet) of these zones. Any new facility would also be required to install state-of-the-art add-on air pollution control devices prior to beginning operations.

Proposed housekeeping provisions would reduce fugitive emissions of hexavalent chromium from all facilities by establishing housekeeping measures.

18. What would the proposed amendments require for existing hexavalent chromium plating and chromic acid anodizing facilities?

Staff is proposing to amend the Chromium Plating ATCM by phasing in BACT. The timing for application of BACT would be related to throughput and proximity to sensitive receptors. The requirements and timing are shown in Table ES-2 below.

Table ES-2. Proposed Hexavalent Chromium Emission Limits for Existing Facilities

Tiers of Annual Permitted Ampere-Hours	Sensitive Receptor Distance	Emission Limitation	Effective Date
Tier 1 ≤ 20,000	Any	Use Chemical Fume Suppressant as specified in section 93102.8	[Six Months after Effective Date]
Tier 2 > 20,000 and ≤ 200,000	≤ 100 Meters	0.0015 milligrams/ampere-hour	[Two Years after Effective Date]
Tier 3 > 20,000 and ≤ 200,000	> 100 Meters	0.0015 milligrams/ampere-hour	[Five Years after Effective Date]
Tier 4 > 200,000	Any	0.0015 milligrams/ampere-hour	[Two Years after Effective Date]

As shown in Table ES-2, very low throughput (less than 20,000 ampere-hours per year) facilities would be required, at a minimum, to reduce hexavalent chromium emissions through use of specified chemical fume suppressants to lower surface tension of the plating or anodizing bath. This represents BACT for these facilities, and would generally ensure that the maximum cancer risk near the facility is under one in a million.

Intermediate-sized facilities (greater than 20,000 but less than 200,000 ampere-hours per year) would be required to meet an emission limitation of 0.0015 milligrams/ampere-hour. These facilities, however, would have the option to demonstrate compliance without installation of add-on air pollution control devices. This proposal, along with providing additional time to comply for those facilities more than 100 meters from a sensitive receptor, could reduce compliance costs for some small businesses.

The largest facilities (more than 200,000 ampere-hours per year) would be required to comply with the emission limitation of 0.0015 milligrams/ampere-hour within two years using an add-on air pollution control device(s). After application of BACT, facilities with remaining cancer risk over 25 per million exposed people would be required to conduct a site specific analysis of their facility's risk to determine if further control measures are necessary.

19. What would the proposed amendments require for any new facility?

The proposal would prevent new chromium plating or chromic acid anodizing facilities from operating in areas zoned residential or mixed use or within 150 meters (~500 feet) of an area zoned residential or mixed use. At this distance, modeling for point sources shows that the hexavalent chromium concentration has dropped off by about 80 percent. New facilities would also be required to conduct a site specific analysis to ensure their emissions do not cause adverse impacts.

20. What is staff proposing to limit fugitive emissions?

Fugitive dust emissions also likely impact people residing near chromium plating and chromic acid anodizing facilities. Therefore, staff is proposing that all facilities implement housekeeping measures to reduce dust emissions.

21. Are other changes proposed?

Yes. Training explaining the Chromium Plating ATCM and the requirements, conducted by ARB staff, would be required for employees responsible for compliance every two years. The training offered by SCAQMD would fulfill this requirement.

The proposal would also prohibit the sale or use of chromium plating or chromic acid anodizing materials unless sold or used by individuals or businesses under air district permit to conduct such operations.

Staff is proposing to require use of specific types of chemical fume suppressants for complying with the surface tension limits. The chemical fume suppressants that could be used have been shown to reduce hexavalent chromium emissions to more than 0.01 milligrams/ampere-hour at the proposed surface tensions.

To implement the new hexavalent chromium emission reduction requirements, a definition for "sensitive receptor" is proposed. A "sensitive receptor" is proposed to be defined as "any residence including private homes, condominiums, apartments, and living quarters;

education resources such as preschools and kindergarten through grade twelve (k-12) schools; daycare centers; and health care facilities such as hospitals or retirement and nursing homes. A "Sensitive Receptor" includes individuals housed in long term care hospitals, hospices, prisons, and dormitories or similar live-in housing."

D. Health Benefits Resulting from the Proposed Amendments

Adoption of the proposed amendments would significantly reduce both emissions and cancer risk from chromium plating and chromic acid anodizing facilities.

22. How would emissions and cancer risk be reduced if the staff's proposal were to be adopted?

If the staff's proposal were to be adopted, an additional 40 percent of facilities would be reducing emissions by over 99 percent. Estimated cancer risk for residents and off-site workers living or working near chromium plating and chromic acid anodizing facilities would be reduced by up to 85 percent depending on the individual facility.

Table ES-3 below shows how excess cancer risk would be reduced beyond the risk reduction achieved by implementation of current ARB and district rules.

Table ES-3. Adoption of Staff's Proposal Significantly Reduces the Estimated Cancer Risk from Hexavalent Chromium Emissions

	Number of Facilities by Cancer Risk			
	≤1 per million	>1 ≤10 per million	>10 ≤100 per million	>100 per million
Staff Proposal	162	41	17	0
Baseline	90	67	57	6

As shown in Table ES-3, by adopting the staff's proposal about 162 facilities (74 percent) would have remaining cancer risk of no more than one per million exposed persons. This represents an additional 72 facilities compared to the baseline. Only 17 facilities (about 8 percent) would have estimated cancer risk of over ten per million exposed people. No facilities would have cancer risk exceeding 100 per million exposed people. Under the staff's proposal each facility with residual cancer risk over 25 per million exposed people would need to do a site specific analysis to determine if further control measures are needed. Total hexavalent chromium emissions from all chromium plating and chromic acid anodizing facilities would decrease, by 55 percent, to 1.8 pounds per year.

Non-cancer health risks were also evaluated. Our analysis found that each facility's hazard index was well below the level of concern (hazard index = 1). Adoption of the proposal would only lower further the potential for any adverse non-cancer effects to occur.

E. Public Outreach

23. In developing the proposal what actions did staff take to consult with all stakeholders?

Staff worked with the air districts, industry, the environmental community, and other affected parties through public workshops, meetings, telephone calls, and mail-outs. Major outreach activities included:

- Forming an ARB/Air District Working Group;
- Forming an ARB/Stakeholder Working Group and conducting meetings in Northern and Southern California;
- Conducting site visits to numerous chromium plating and chromic acid anodizing operations;
- Creating a website and maintaining a List-Serve to automatically update interested parties about proposed ATCM developments;
- Conducting surveys of chromium plating and chromic acid anodizing facilities, chemical fume suppressant manufacturers providing chemicals and services to the chromium plating and chromic acid anodizing facilities in California, and conducting an economic survey of the industry;
- Mailing workshop notices and posting workshop materials on ARB's website;
- Conducting public workshops, with conference call tie-in, in Northern and Southern California; and
- Preparing a fact sheet regarding the development of the proposed ATCM and making it available to the public.

F. Economic Impacts of the Staff's Proposal

Staff has evaluated the financial impact on California businesses that would result from adoption of the proposed amendments. Staff conducted a very conservative cost impact assessment. While some businesses may be able to demonstrate compliance without purchasing a HEPA system, it was assumed for the purpose of our economic impact analysis that all facilities required to meet the 0.0015 milligrams/ampere-hour limit would purchase a HEPA filtration system.

24. How many businesses are impacted by the staff's proposal?

All of the 226 facilities affected by the proposed amendments to the ATCM will have some compliance costs. [Two facilities have closed down since conducting the survey.] Up to 89 facility owners would be required to expend significant capital to meet the requirements. About 60 percent of facilities however, are already in substantial compliance.

25. What would be an individual facility's cost to comply?

During the first year, all facilities would have compliance costs. Costs will vary depending on the extent an individual business is already in compliance with the proposed amendments. We estimate that costs in the first year would range from \$450 to \$217,000, with an average cost of \$23,000. In subsequent years, costs would range from near zero to \$217,000, with an average cost of \$53,000. After the first year, 60 percent of the facilities would have no additional compliance costs.

26. How would the Return on Owner's Equity be affected?

All of the chromium plating and chromic acid anodizing businesses affected by these proposed amendments are California businesses. Businesses are affected by the proposed amendments to the extent that costs associated with implementation of the regulation may reduce their profitability.

Profitability impacts were estimated by calculating the decline in the return on owner's equity (ROE). A decline in ROE of 10 percent or more is one indication that the ATCM could result in a significant adverse impact. The proposed amendments to the ATCM are expected to result in an average ROE decline of nine percent.

Staff has determined that costs for some individual businesses are expected to be significant and would adversely impact their profitability. For the 89 businesses that would likely need to install or upgrade add-on air pollution control devices, the estimated decline in profitability ranges from 3 to 41 percent. Twenty-eight of these are small businesses. The average estimated compliance cost for these businesses is about \$53,000. Some smaller volume plating or anodizing businesses may decide to cease chromium plating or anodizing operations rather than make the investments needed to comply.

27. Is there any assistance available to help small businesses secure the necessary capital to comply?

The Governor, in 2005, signed legislation (Assembly Bill 721, Nunez) to establish a loan guarantee program for decorative chromium plating operations to purchase pollution control equipment. The program is administered by the Business, Transportation, and Housing Agency. The program will provide loan guarantees of up to \$100,000 to owners of decorative chromium plating small businesses that are not able to qualify for a conventional loan. The loan guarantee program is now in effect. In July 2006, the Governor signed into law amendments to the loan guarantee program. The loan guarantee program is now available for all metal plating facilities.

28. Are manufacturers of chromium plating and chromic acid anodizing suppliers adversely impacted by the proposed amendments?

We do not expect manufacturers of chromium plating and chromic acid anodizing materials to incur any costs. However, the staff's proposal to prohibit sales of chromium

plating kits to non-permitted facilities may result in lost revenue for these businesses. The proposed amendments would potentially impact the chemical manufacturers in a positive way through increased sale of chemical fume suppressants. Add-on air pollution control device manufacturers, as well as the metal fabricating industry would also benefit from the proposed amendments as controls and ductwork for ventilation systems is purchased.

29. Would consumers be impacted by the proposal?

The potential impact of the proposed amendments to the ATCM on consumers depends upon the extent to which affected businesses are able to pass on the increased cost to consumers in terms of higher prices for their goods and services. If all costs are passed onto the consumers, we expect the cost per ampere-hour to increase from near zero to about \$2.20 per ampere-hour. These costs are estimated based on facilities that would have to install add-on air pollution control devices. The lower end of this cost would represent a large throughput facility, while the upper end cost would represent a small throughput facility.

To put these costs into perspective, consider that chromium plating an automobile bumper (a decorative chromium application) requires 50 ampere-hours to chromium plate. This would mean the increased cost to plate a bumper would increase from near zero to about \$110. If re-plating a bumper costs \$400 at present time, the cost of the bumper would increase from about \$400 to as much as \$510.

30. Are there any costs to public agencies?

Yes. The air districts, as a result of the proposed amendments, would incur costs for reviewing initial compliance status reports; reviewing or revising permit modifications for facilities adding or upgrading to HEPA, or an equivalent level of control; reviewing source test protocols and results; and reviewing site specific analyses, if necessary. We estimate the new costs to air districts resulting from the proposed amendments to the ATCM to be approximately \$685,000. However, air districts can recover these costs through fees charged to the facilities.

31. What are the total costs of the proposed amendments to the Chromium Plating ATCM?

Total capital costs for purchase of add-on air pollution control devices are estimated at \$9.6 million. Total recurring costs are estimated at \$3.6 million. An additional \$1.0 million in costs is estimated for reports, source testing, permit fees, and site specific analyses. In total costs are estimated to be \$14.2 million.

G. Evaluation of Alternatives

32. What alternatives to the proposed amendments to the Chromium Plating ATCM did staff consider?

Staff considered four alternatives to the proposed amendments. The alternatives were evaluated in terms of applicability, risk reduction, enforceability, and cost.

a. Require decorative chromium plating facilities to use the trivalent chromium plating process

One alternative to the staff's proposal would be to require the use of the trivalent chromium plating process for all decorative chromium plating facilities. Requiring all decorative chromium facilities to use the trivalent chromium process would eliminate the remaining cancer risk from the hexavalent chromium emissions from decorative chromium plating facilities. Staff has evaluated the trivalent chromium process and has determined that it is not a universal replacement for all decorative chromium plating applications. Therefore, staff has determined this is not a technologically feasible alternative.

b. Require HEPA filtration systems, or an equivalent add-on air pollution control device, for all facilities

Another alternative would be to require installation of HEPA filtration systems, or an equivalent add-on air pollution control device for all facilities. Staff determined that this alternative would result in no appreciable additional benefit because the very small facilities would have estimated cancer risk of no more than one per million exposed people after implementation of the proposal. This option would add additional equipment costs of over \$4.0 million. As a result staff chose not to pursue this alternative.

c. Adopt the provisions of SCAQMD Rule 1469 statewide

A third alternative considered was to adopt the provisions of SCAQMD Rule 1469 statewide. In 2003, the SCAQMD amended its Rule 1469, Control of Hexavalent Chromium Emissions from Chrome Plating and Chromic Acid Anodizing Operations (Rule 1469). The rule requires hexavalent chromium facilities located within 25 meters of a sensitive receptor or within 100 meters of a school to reduce hexavalent chromium emissions such that the residential cancer risk will be no more than ten chances per million people. The rule also requires facilities located greater than 25 meters from a sensitive receptor or 100 meters from a school to reduce emissions such that off-site worker cancer risk would be no more than 25 chances per million people. The amended rule is in full effect.

Staff has evaluated this alternative and has found it does not provide the level of protection that would be achieved through adoption of the staff's proposal. Such an approach would not ensure that BACT is applied at all facilities. ARB staff has determined that BACT for very small facilities ($\leq 20,000$ ampere-hour throughput) is use

of specific types of chemical fume suppressants. BACT for intermediate and larger facilities is use of add-on air pollution control devices with the final capture device being HEPA filters, or any other combination of controls that are as effective as HEPA filters.

d. Require no further control

Alternative 4 would be to require no additional control. Staff does not believe the *status quo* is protective of public health especially considering that 43 percent of operations are located within 100 meters of a sensitive receptor. Our goal is to achieve the maximum feasible health protection—especially when people are living, learning, working, or playing near chromium plating and chromic acid anodizing facilities. Thus, staff did not choose this alternative.

e. Summary

Table ES-4 compares alternatives three and four with the staff’s proposal. Alternatives one and two are not presented. Alternative one is not technologically feasible. Alternative two essentially offers no benefit beyond the staff’s proposal.

Table ES-4. Adoption of Staff’s Proposal Offers the Greatest Reduction in Significant Community Cancer Risk

	Number of Facilities by Cancer Risk			
	≤1 per million	>1 ≤10 per million	>10 ≤100 per million	>100 per million
Staff Proposal	162	41	17	0
Rule 1469 Statewide	98	67	53	2
Baseline	90	67	57	6

Table ES-4 shows that the staff’s proposal offers the best health protection. As shown, adopting the provisions of SCAQMD Rule 1469 statewide would result in 98 facilities (about 45 percent) with remaining cancer risk of no more than one per million exposed persons. This represents an additional 8 facilities compared to the baseline. Adoption of the staff’s proposal would reduce the estimated cancer risk for 162 facilities (about 74 percent) to no more than one per million exposed persons.

Table ES-4 also shows that if the provisions of Rule 1469 were to be adopted statewide, 53 facilities (about 24 percent) would continue to have estimated cancer risk of over ten per million exposed people, and two facilities would have estimated cancer risk of over 100 per million exposed people. If the staff’s proposal were adopted, 17 facilities (about 8 percent) would have estimated cancer risk of over ten per million exposed people and no facilities would have cancer risk exceeding 100 per million exposed people. Under the staff’s proposal each facility with residual cancer risk over 25 per million would need to do a site specific analysis to determine if further control measures are needed.

f. Conclusion

We evaluated each of the alternatives and concluded that the alternatives did not meet the objective of Health and Safety Code section 39666 to reduce emissions to the lowest level achievable in consideration of cost, health risk, and environmental impacts. Staff believes the proposed amendments represent the best balance between costs and cancer risk.

H. Environmental Impacts

33. What are the expected environmental benefits if the proposed amendments are adopted?

The primary benefit from the proposed amendments is a large reduction in excess cancer risk from emissions of hexavalent chromium. We estimate that an additional 40 percent of facilities would be controlling emissions by over 99 percent and cancer risk would be reduced by up to 85 percent for individual facilities. Almost 75 percent of facilities would have cancer risk of less than one per million people exposed. Ninety-two percent of facilities would have cancer risk of less than ten per million people exposed. The proposal will also have a direct benefit for low income and ethnically diverse communities that may be heavily impacted by hexavalent chromium emissions from chromium plating and chromic acid anodizing operations.

34. Are there any significant adverse environmental impacts that would result from adopting the proposed amendments?

No. We evaluated the potential impacts on air quality, water and wastewater, and hazardous waste. We also evaluated the effect on the environment of the use of chemical fume suppressants.

Air Quality. The proposed amendments to the ATCM would result in a negligible improvement in air quality in terms of the weight of the emissions. While the proposed amendments reduce emissions of hexavalent chromium by about 55 percent, the actual reduction in mass is about 2.2 pounds per year. Remaining emissions are estimated to be 1.8 pounds per year.

It is also anticipated that there will be a temporary increase in emissions of criteria pollutants due to construction related activity involved in the installation of new add-on air pollution controls and the possible dismantling of current controls.

Water and Wastewater. Many of the add-on air pollution control devices required by the proposed amendments require periodic water washdown to clean and maintain the integrity of the system. Implementation of housekeeping measures would likely require fresh water usage as well. The increased water usage is difficult to quantify. However, we do not expect the increased use to be significant. We expect the amount of wastewater to also increase due to the proposed amendments related to housekeeping and equipment maintenance. Compliance with State Water Resources Control Board

regulations would prevent this hexavalent chromium from being discharged to lakes, rivers, bays, or oceans.

Hazardous waste. The proposed amendments would require an additional 89 facilities to begin using add-on air pollution control devices with the final collection mechanism likely to be HEPA filters. These filters, as well as pre-filters designed to increase the useful life of HEPA filters, are considered hazardous waste to be disposed of in Class A landfills. HEPA filters are usually replaced at least annually, but replacement schedules depend upon the individual operation. Pre-filters are replaced more often. Assuming a typical filter volume of 4 cubic feet each, the resulting volume of hazardous waste generated is 2.9 cubic feet per day. We do not consider this to be a significant increase in the amount of hazardous waste to be landfilled.

In California, all hazardous waste must be disposed of at a facility that is registered with the Department of Toxic Substances Control (DTSC). Chromium plating and chromic acid anodizing facility wastes are classified as hazardous waste because they contain hexavalent chromium.

Use of Bioaccumulative Compounds. The fluorosurfactants used as active ingredients in chemical fume suppressants are often referred to as perfluorooctyl sulfonates (PFOS). While these products are highly effective at reducing hexavalent chromium emissions by reducing plating bath surface tension the compounds have been shown to be persistent, bioaccumulative, and toxic to mammals. Studies indicate that PFOS may have potential developmental, reproductive, and systemic toxicity (U.S. EPA, 2006). These compounds are being evaluated for addition to a Significant New Use Rule for perfluoroalkyl sulfonates (PFAS). Based on the staff's proposal we estimate a maximum increased use of chemical fume suppressants of about three gallons per year.

We expect these impacts to be minimal and believe that the significant reduction in cancer risk overrides any small adverse impact that would result from adoption of the staff's proposal.

35. Are any reasonably foreseeable mitigation measures necessary?

No. The California Environmental Quality Act requires an agency to identify and adopt feasible mitigation measures that would minimize any significant adverse environmental impacts described in the environmental analysis. The ARB staff has concluded that no significant adverse environmental impacts should occur from adoption of and compliance with the proposed amendments to the ATCM. Because no significant adverse impacts have been identified, no specific mitigation measures would be necessary.

36. Are there any reasonably foreseeable alternative means of compliance with the proposed amendments to the airborne toxic control measure?

Alternatives to the proposed amendments to the Chromium Plating ATCM are discussed in question 32. The ARB staff has concluded that the proposed amendments to the ATCM provide the most effective and least burdensome approach to reducing the public's

exposure to hexavalent chromium emitted from chromium plating and chromic acid anodizing facilities.

37. How does the staff's proposal relate to ARB's community health and environmental justice programs?

Environmental Justice is defined as the fair treatment of people of all races, cultures, and incomes with respect to the development, adoption, implementation, and enforcement of environmental laws, regulations, and policies. The ARB is committed to integrating environmental justice into all of our activities. The proposed amendments to the ATCM are consistent with our policies to reduce health risks from toxic air pollutants in all communities, including those with low-income and ethnically diverse populations, regardless of location. Potential health risks from hexavalent chromium emissions from chromium plating and chromic acid anodizing operations can affect both urban and rural communities. Therefore, reducing hexavalent chromium emissions from chromium plating and chromic acid anodizing operations will provide air quality benefits to urban and rural communities in the State, including low-income areas and ethnically diverse communities.

We have identified several communities that may be heavily impacted by hexavalent chromium emissions from chromium plating and chromic acid anodizing operations. The residents in these communities would realize a large portion of the benefits of the proposal.

To further address environmental justice and the public's concern regarding exposure to hexavalent chromium emissions, the proposed amendments to the ATCM would specify that any new facility would not be able to operate in any area zoned as residential or mixed use, or within 150 meters of a residential or mixed use zone.

I. Recommendation

We recommend that the Board adopt the proposed amendments to the Chromium Plating ATCM. Staff has determined that the proposed amendments are necessary to reduce cancer risk from hexavalent chromium emissions from chromium plating and chromic acid anodizing facilities. If adopted, about 75 percent of facilities would have estimated cancer risk of no more than one per million exposed people. Ninety-two percent of facilities would have estimated cancer risk of no more than ten per million exposed people. Staff also believes the proposal represents a balance between health risk and cost. The proposed amendments are contained in Appendix A.

Within six months of the amendments becoming legally effective, the air districts would be required to implement and enforce the proposed amendments to the ATCM or adopt an equally effective measure.

REFERENCES

Bayer ®. Product information Bayowet® FT 248 and FT 248R.

SCAQMD, 2003. South Coast Air Quality Management District. Rule 1469: “Hexavalent Chromium Emissions from Chrome Plating and Chromic Acid Anodizing Operations”. Amended May 2, 2003

U.S. EPA, 1995. U.S. Environmental Protection Agency. 40 CFR Part 63 Subpart N: “National Emission Standards for Chromium Emissions From Hard and Decorative Chromium Electroplating and Chromium Anodizing Tanks”. 1995.

U.S. EPA, 1998. U.S. Environmental Protection Agency. EPA/625/R-98/002: “Capsule Report Hard Chrome Fume Suppressants and Control Technologies”. 1998.

U.S. EPA, 2006. U.S. Environmental Protection Agency. 40 CFR Part 721: “Perfluoroalkyl Sulfonates; Proposed Significant New Use Rule.” 2006.

I. Introduction

Hexavalent chromium plating, or simply chromium plating, is the electrical application of a coating of chromium onto a surface for decoration, corrosion protection, or for durability. An electrical charge is applied to a tank (bath) containing an electrolytic salt (chromium anhydride) solution. The electrical charge causes the chromium metal particles in the bath to fall out of solution and deposit onto objects placed into the plating solution. During chromic acid anodizing, an oxidation layer is generated on the surface of the part. These electrolytic processes cause mists containing hexavalent chromium to be ejected from the plating tank which are eventually dispersed into outdoor ambient air.

Hexavalent chromium is a potent known human carcinogen. Consequently, the California Air Resources Board (ARB or Board) has regulated the hexavalent chromium emissions from chromium plating and chromic acid anodizing facilities since 1988. The existing control measure, the Hexavalent Chromium Airborne Toxic Control Measure for Chrome Plating and Chromic Acid Anodizing Operations (ATCM or Chromium Plating ATCM), is found in title 17, California Code of Regulations, section 93102.

ARB staff has determined that despite significant reductions, people living near chromium plating and chromic acid anodizing facilities are still exposed to unnecessarily high concentrations of hexavalent chromium. Therefore, this Initial Statement of Reasons sets forth the staff's proposal to amend the ATCM (contained in Appendix A) and the rationale for the proposal.

A. Overview

In 1986, based on a recommendation by the Scientific Review Panel (SRP) on Toxic Air Contaminants (TACs), the Board identified hexavalent chromium as a TAC (ARB, 1985). Hexavalent chromium was determined to be a potent human carcinogen with no known safe level of exposure. Subsequent to that finding, the Board adopted measures to control hexavalent chromium emissions, including an ATCM to reduce hexavalent chromium emissions from chromium plating and chromic acid anodizing operations. This ATCM reduced hexavalent chromium emissions from chromium plating and anodizing facilities by well over 90 percent.

While an over 90 percent reduction is significant, because of the potent carcinogenicity of hexavalent chromium, even minute amounts are cause for concern, particularly for near-source receptors. Hexavalent chromium emissions of as little as two grams per year can result in an estimated cancer risk of ten per million people exposed. Because of the potential for near-source unacceptable residual health risks, staff undertook an evaluation of the chromium plating and chromic acid anodizing industry and the existing ATCM to ensure that it continues to provide the maximum feasible health protection. These amendments are being proposed as a result of that evaluation. ARB staff has

reviewed control technologies, emissions, population exposures, and remaining health risks, and has found that further control is feasible and warranted. This Initial Statement of Reasons (ISOR or Staff Report) sets forth the staff's proposal to amend the Chromium Plating ATCM and outlines the need and rationale for the proposal. This staff report for the proposed amendments includes:

- Background regulatory information and authority;
- Goals of the regulation and public outreach;
- Chromium plating and chromic acid anodizing industry characterization;
- Findings from the Industry Survey, Chemical Manufacturers Survey, Economic Survey, and Receptor Proximity Survey;
- Emission factor development and the decorative chromium plating emissions testing program;
- Potential exposure and risk from chromium plating and chromic acid anodizing operations;
- Availability and technological feasibility of potential control devices;
- Description of the proposed amendments;
- Economic impacts of the proposed amendments; and
- Environmental impacts of the proposed amendments.

B. Goals of the Proposed Amendments

The goal of the proposed amendments to the Chromium Plating ATCM is to minimize the public's exposure to hexavalent chromium emissions from chromium plating and chromic acid anodizing facilities. The amendments are designed to achieve the maximum hexavalent chromium emission reductions by using the most reliable controls available. The amendments are also designed to isolate people from new facilities. If adopted, the amendments would set more stringent requirements for all intermediate and large hexavalent chromium plating and chromic acid anodizing facilities by requiring best available add-on air pollution control technology (BACT). We have determined that BACT for very small facilities is the use of specific types of chemical fume suppressants. The requirements would be phased in based on throughput and proximity to sensitive receptors. Sensitive receptor locations include residences, schools, daycare centers, hospitals, hospices, retirement or nursing homes, prisons, and dormitories.

The proposal would also prevent new chromium plating and chromic acid anodizing facilities from operating in areas zoned as residential or mixed use or within 150 meters (~500 feet) of these zones. Any new facility would also be required to install state-of-the-art add-on air pollution control devices prior to beginning operations.

Proposed housekeeping provisions would also reduce fugitive emissions of hexavalent chromium from all facilities by establishing housekeeping measures. Personnel at plating operations would also be required to undergo ARB-sponsored training to ensure that parameter monitoring and recordkeeping are done properly. The amendments would also prevent sale of chromium plating chemicals and equipment to any individual that was not the owner or operator of a permitted facility.

The existing ATCM requirements are different based on the type of operation (decorative plating and anodizing or hard chromium plating). Under this proposal, all facilities using the hexavalent chromium process regardless of type of operation would be subject to the same control requirements. The proposed amendments are contained in Appendix A. Adoption of the staff's proposal would result in reducing cancer risk by up to 85 percent for individual facilities.

If adopted by the Board, the amended control measure would be implemented and enforced by the air pollution control and air quality management districts (air districts). The air districts may implement the proposed amendments to the ATCM, as adopted by the Board, or adopt an alternative rule at least as stringent as the ARB's ATCM.

C. Regulatory Authority

Legislation enacted in the 1980's delegated to ARB the authority and responsibility to identify and control toxic air contaminants. This section outlines the statutory authority to control toxic substances and includes a description of the processes that have been developed to fulfill the requirements of State law.

The ARB's statewide air toxics program was established in the early 1980's. Assembly Bill (AB) 1807 (Tanner, Chapter 1047, statutes 1983), *The Toxic Air Contaminant Identification and Control Act*, created California's Toxic Air Contaminant Identification and Control Program (Air Toxics Program) to reduce the public's exposure to air toxics. This law is codified in Health and Safety Code sections 39650 through 39675. AB 2588 (Connelly, Chapter 1252, statutes of 1987), *Air Toxics "Hot Spots" Information and Assessment Act*, supplements the Air Toxics Program by requiring a statewide air toxics inventory, notification of people exposed to a significant health risk, and facility plans to reduce these risks.

1. Identification and Control of Toxic Air Contaminants

The Air Toxics Program established a two step process to identify and then control air toxics to protect the health of Californians.

In the first step, a substance is formally identified as a TAC based on reviews by the ARB and the Office of Environmental Health Hazard Assessment (OEHHA). The agencies evaluate the health impacts of, and exposure to, substances, and identify as TACs those substances that pose the greatest health threat. The ARB's evaluation is made available to the public and is formally reviewed by the SRP on TACs established under Health and Safety Code section 39670. Following the ARB's evaluation and the SRP's review, the Board, at a public hearing, may formally identify a TAC.

In the second step, risk reduction, the ARB reviews the emission sources of a TAC to determine what regulatory actions are available and necessary to maximize health protection. Health and Safety Code sections 39658, 39665, 39666, and 39667 require ARB, with the participation of the air districts, and in consultation with affected sources and interested parties, to prepare a report on the need and appropriate degree of regulation for a TAC. In situations where no safe threshold level is found for a particular TAC, the control measures are to be designed to reduce emissions to the lowest level achievable through application of BACT or a more effective control method in consideration of health risk to the public and cost.

2. The “Hot Spots” Program

Under the AB 2588 program, stationary sources are required to report the types and quantities of certain substances that their facilities routinely release into the air. The goals of the "Hot Spots" Act are to collect emission data, identify facilities having localized impacts, determine health risks, and notify nearby residents of significant risks. In September 1992, the "Hot Spots" Act was amended by SB 1731 to address the reduction of significant risks. The bill requires that owners of significant-risk facilities reduce their risks below the level of significance as determined by air districts. Chromium plating and anodizing operations are subject to the “Hot Spots” program, and, as described below, are also subject to a technology-based ATCM to minimize emissions of hexavalent chromium.

3. Identification and Control of Hexavalent Chromium

In 1986, ARB identified hexavalent chromium as a TAC after peer review by the SRP. Hexavalent chromium was determined to be a potent known human carcinogen with a cancer unit risk factor of 1.5×10^{-1} microgram per cubic meter ($\mu\text{g}/\text{m}^3$) of air. This potency factor means that exposure to $1 \mu\text{g}/\text{m}^3$ of hexavalent chromium over a lifetime would potentially result in 146,000 excess cancer cases per million exposed people. The Board also found that the available scientific evidence did not support a hexavalent chromium threshold exposure level below which significant adverse health effects would not be expected (title 17, California Code of Regulations, section 93000). Also, at this time, the Board did not find sufficient evidence to identify trivalent chromium as a TAC (ARB, 1985).

To reduce the risk from hexavalent chromium, the Board has adopted four ATCMs:

- 1988 - *Hexavalent Chromium Airborne Toxic Control Measure for Chrome Plating and Chromic Acid Anodizing Operations* (ARB, 1988);
- 1989 - *Airborne Toxic Control Measure for Hexavalent Chromium For Cooling Towers* (ARB, 1989);
- 2001 - *Airborne Toxic Control Measure for Emissions of Hexavalent Chromium and Cadmium From Motor Vehicle and Mobile Equipment Coatings* (ARB, 2001);
- 2005 – *Airborne Toxic Control Measure to Reduce Emissions of Hexavalent Chromium and Nickel From Thermal Spraying* (ARB, 2005).

This report describes staff's proposal to further reduce the public's exposure to hexavalent chromium from chromium plating and chromic acid anodizing facilities. To better understand the proposal it is important to first understand the requirements of the current ATCM.

D. Existing State Control Measure

The State's existing Chromium Plating ATCM was originally adopted in 1988 and amended in 1998. The regulation is set forth in title 17, CCR, section 93102. The ATCM adopted in 1988 set technology-based standards that focused primarily on hard chromium plating facilities and set limits based on BACT at that time. Implementation of this regulation resulted in hexavalent chromium emission reductions of over 90 percent. A brief summary of the requirements for the existing ATCM follows:

- Hard chromium plating facilities are required to install add-on air pollution control devices to meet emission limits ranging from 0.15 milligrams/ampere-hour (mg/amp-hr) to 0.006 milligrams/ampere-hour, depending on levels of throughput. An alternative surface tension limit was provided for hard chromium plating facilities with throughput levels of 500,000 ampere-hours or less; and
- Decorative plating and anodizing facilities must comply with either an emission limit using add-on air pollution controls or meet a surface tension limit. Most facilities comply by meeting the surface tension limit.

The ATCM also has recordkeeping requirements and operation and maintenance requirements. However, the existing ATCM does not take into account proximity of existing chromium plating and chromic acid anodizing facilities to people.

The ATCM was amended in 1998 to establish equivalency with the National Emission Standards for Chromium Emissions from Hard and Decorative Chromium Electroplating and Chromium Anodizing Tanks (Chromium Plating NESHAP) (U.S. EPA, 1995). The federal Chromium Plating NESHAP included control requirements for trivalent chromium operations because it is a hazardous air pollutant (HAP). Therefore, the focus of ARB's 1998 amendments was to include provisions for controlling emissions from trivalent chromium plating facilities (ARB, 1998). Also, prior to these amendments, chromic acid anodizing facilities were required to comply with the same provisions as hard chromium plating facilities. These amendments provided that chromic acid anodizing facilities could comply with the surface tension limit alone rather than the previous emission rate limit. Other conforming changes included:

- Parameter Monitoring requirements;
- Inspection and Maintenance requirements;
- Operation and Maintenance Plan requirements;
- Recordkeeping requirements; and
- Reporting requirements.

E. Federal Regulations

Because the ARB has achieved equivalency with the Chromium Plating NESHAP for chromium plating and chromic acid anodizing facilities, California's facilities are only required to comply with the State's ATCM (Approval of section 112 (I) Authority of Hazardous Air Pollutants; Chromium Emissions from Hard and Decorative Chromium Electroplating and Chromium Anodizing Tanks; State of California; Approved December 16, 1998, Volume 63, number 241, Page 69251-69256) (U.S. EPA, 1998a). However, a description of United States Environmental Protection Agency's (U.S. EPA) Chromium Plating NESHAP, as well as the Occupational Safety and Health Administration's (OSHA) permissible exposure level for hexavalent chromium is useful to understand how chromium plating facilities and chromic acid anodizing facilities are regulated.

1. Chromium Plating NESHAP

The 1990 federal Clean Air Act Amendments established a list of Hazardous Air Pollutants (HAPs) and directed the U.S. EPA to set standards for all major sources of air toxics. "Chromium Compounds," including hexavalent chromium and trivalent chromium are listed as HAPs. [In 1992, California AB 2728 (Tanner, Chapter 1161, statutes of 1992) specified that ARB must, by regulation, identify as TACs the 189 substances identified by the federal government as HAPs.]

For certain designated source categories, U.S. EPA has developed specific regulations referred to as the National Emission Standards for Hazardous Air Pollutants (NESHAPs). In January 1995, the U.S. EPA promulgated, in 40 Code of Federal Regulations (CFR) Part 63, Subpart N, the Chromium Plating NESHAP. Concentration standards were established for hard chromium plating facilities. These limits could be met by the addition of forced ventilation systems, but add-on air pollution control devices were not necessarily needed. Surface tension limits were established for decorative chromium plating facilities and chromic acid anodizing facilities (U.S. EPA, 1995).

On July 19, 2004, the U.S. EPA amended the Chromium Plating NESHAP. The changes are summarized below.

- Allowed the use of chemical fume suppressants to control chromium emissions from hard chromium plating facilities as an alternative to the existing concentration emission limit;
- Provided an alternative standard to the existing concentration emission limit for hard chromium plating tanks equipped with enclosed hoods;
- Modified surface tension parameter testing to accommodate the differences in measurement between the use of a stalagmometer and the tensiometer (stalagmometer requirement: < 45 dynes/centimeter; tensiometer requirement: < 35 dynes/centimeter);
- Expanded the definition of "chromium electroplating and anodizing" to include all of the ancillary hardware associated with the plating process. This includes such

items as the tank, “add-on” control equipment, rectifier, process tanks, ductwork, etc.; and

- Amended the pressure drop for composite mesh pads to ± 2 inches of water column instead of ± 1 inch of water column (U.S. EPA, 2004).

2. Federal OSHA Worker Exposure Limits

Under the U.S. Department of Labor, OSHA published a Permissible Exposure Limit (PEL) to protect workers from hexavalent chromium exposures. The exposures to hexavalent chromium are addressed in specific standards for maritime, construction, and general industries.

OSHA's PEL for chromic acid and chromates is found in 29 CFR 1910.1000, Table Z-2. On February 28, 2006, OSHA changed the hexavalent chromium rule by setting a time-weighted average PEL of $5 \mu\text{g}/\text{m}^3$, measured and reported as Chromium VI, and an action level of half the PEL for the general industry. OSHA also adopted other ancillary provisions for employee protection such as preferred methods for controlling exposure, respiratory protection, protective work clothing and equipment, establishing hygiene areas and practices, medical surveillance, hazard communication, and recordkeeping (OSHA, 2006). More information can be found at the following webpage: <http://www.osha.gov/SLTC/hexavalentchromium/standards.html>.

F. Current Air District Rules

As required by State law, air districts are required to adopt, implement, and enforce rules that are equivalent to any State adopted ATCM, or may elect to adopt a rule that is more stringent. The air districts also are required to gather from facilities emissions information required by the “Hot Spots” Act. Some air districts also have adopted rules or policies that require existing facilities to reduce health risks below an air district specified level of significance. New facilities generally are not allowed to operate unless the potential health risk posed by the facility's emissions is below the air district's level of significance.

Chromium plating and chromic acid anodizing facilities operate under permits issued by each air district. Table I-1 lists air districts that have active chromium plating and/or chromic acid anodizing facilities and the rule with which facilities in that air district must comply.

Table I-1. Air Districts with Active Chromium Plating and/or Chromic Acid Anodizing Facilities and Corresponding Prohibitive Rule

District	Rule
Bay Area Air Quality Management District (BAAQMD)	Rule 11.8
Feather River Air Quality Management District (FRAQMD)	Rule 11.2
South Coast Air Quality Management District (SCAQMD)	Rule 1469
Sacramento Metropolitan Air Quality Management District (SMAQMD)	Rule 904
San Diego County Air Pollution Control District (SDCAPCD)	Rule 1201
San Joaquin Valley Air Pollution Control District (SJVAPCD)	Rule 7011
Shasta County Air Quality Management District	Rule 3:11
Ventura County Air Pollution Control District (VCAPCD)	Chromium Plating ATCM

Of particular interest for this rulemaking is the May 2003 amendments to Rule 1469 adopted by the South Coast Air Quality Management District (SCAQMD), Hexavalent Chromium Emissions from Chrome Plating and Chromic Acid Anodizing Operations (SCAQMD, 2003). These changes were designed to further reduce health risk by specifying lower emission rates for all facilities, and establishing more stringent requirements for facilities located near sensitive receptors than were in place at the time. The goal was to specify emission rates to reduce the potential cancer risk from all facilities below the air district’s level of significance, a potential cancer risk of no more than 25 per million persons. However, more stringent requirements were specified for facilities located within 25 meters of a sensitive receptor, or 100 meters of an existing school. In these instances, potential cancer risks were to be reduced below ten per million persons. A summary of the changes is provided below:

- Set more stringent mass emission limits with increasing ampere-hours and distance to receptor;
- Established a fume suppressant certification program and an emission rate of 0.01 milligrams/ampere-hour for certified fume suppressants;
- Added housekeeping practices for all facilities;
- Prohibited the air sparging of chromium plating or anodizing tanks, unless in use;
- Prohibited removal of existing add-on air pollution control equipment, unless replaced with air pollution control techniques meeting higher control efficiencies;
- Provided optional emission limits for small facilities;
- Added alternative compliance options for all facilities; and
- Established an operator training requirement.

As part of the “Hot Spots” program, air districts have developed rules or policies designed to further reduce health risks from sources of toxic air pollutants. These rules are triggered at air district specified levels of significance and apply to both new and existing

facilities. These rules establish the health risk levels that trigger the need for installation of BACT for Toxics (T-BACT). Generally, new facilities are subject to the more stringent requirements. All of these rules and policies have been useful in our evaluation of measures that are feasible to further reduce health risk from chromium plating and chromic acid anodizing operations. A synopsis of some of these rules is provided below.

SCAQMD Rule 1401, New Source Review of Toxic Air Contaminants applies to air permits for new, relocated, or modified sources that emit TACs. If the potential increase in cancer risk from a modification does not exceed one case per one million persons, T-BACT controls are not required to obtain an air permit. If the potential increase in cancer risk is between 1 and 10 per million persons, T-BACT controls are required to obtain an air permit. In addition, the cancer burden must not exceed 0.5 cases (SCAQMD, 1990).

SCAQMD Rule 1402, Control of Toxic Air Contaminants from Existing Sources, specifies an action risk level of 25 excess cases per million persons for cancer risk, a cancer burden of 0.5, or a total acute or chronic hazard index of 3.0 for any target organ system at any receptor location. [An acute or chronic hazard index is the ratio of the estimated level of exposure over a specified period of time to its acute or chronic reference exposure level.] Existing facilities that exceed the action risk level must develop risk reduction plans and implement measures to reduce risks to below the action level. The amendments to Rule 1469 were designed as an alternative for chromium plating and chromic acid anodizing facilities to meet the requirements of Rule 1402 (SCAQMD, 1994).

San Diego County Air Pollution Control District (SDCAPCD) Rules 1200, Toxic Air Contaminants – New Source Review, and 1210, Toxic Air Contaminant Public Health Risks – Public Notification and Risk Reduction, specify that if the potential increase in cancer risk does not exceed one per million persons, T-BACT controls are not required to obtain an air permit. If the potential increase in cancer risk is between 1 and 10 per million persons, T-BACT controls are generally required to obtain an air permit. If the potential increased cancer risk is greater than 10 but no more than 100 per million persons, it may still be possible to get an air permit if a facility can meet specific conditions (SDCAPCD, 1996).

The Bay Area Air Quality Management District (BAAQMD) does not have a specific rule for toxics permitting. However, BAAQMD's permitting policy is generally consistent with the SCAQMD and SDCAPCD toxics new source review rules. All permit applications for new or modified sources are screened for emissions of TACs and sources that may present significant health risks are required to install T-BACT to minimize TAC emissions (BAAQMD, 2005).

G. Barrio Logan, A Case Study of Near Source Impacts

In May of 2001, ARB, with cooperation of the SDCAPCD, began monitoring around two chromium plating facilities in the Barrio Logan neighborhood of San Diego. A residence was located between these facilities and numerous residences were in the area. Local concern about possible exposures to hexavalent chromium emissions from these

facilities, as well as, the Children's Environmental Health Protection Act [Senate Bill 25, Escutia 1999 (SB 25)] prompted the study. SB 25 required ARB to evaluate the air that children are exposed to in places where they live and play and to determine if current regulations adequately protect them. One facility was a hard chromium plating operation with emissions controlled by a HEPA filter system. The other facility was a decorative plating operation with emissions controlled by using a chemical fume suppressant to reduce the surface tension of the plating bath.

In January 2002, unexpectedly high levels of hexavalent chromium were found at a number of monitoring sites. More intensive monitoring pinpointed the source of the elevated levels of hexavalent chromium to be from the decorative chromium plating facility. Through this study, we also found that fugitive dust emissions from the facility contributed to community hexavalent chromium exposures. For more detailed information, please refer to the Barrio Logan Report, "A Compilation of Air Quality Studies in Barrio Logan, November 2004" (ARB, 2004). The report can be found at the following address: http://www.arb.ca.gov/ch/programs/bl_11_04.pdf

H. Hexavalent Chromium Emissions Study and Conclusions

The results of air monitoring for hexavalent chromium in Barrio Logan indicated that emissions from decorative chromium plating facilities may be underestimated. To investigate this theory, we undertook a hexavalent chromium emissions testing program at decorative chromium plating facilities in various parts of the State to evaluate the emission factor for facilities using only in-tank controls. As a result of this testing, the emission factor for chemical fume suppressant controlled facilities (those complying with the surface tension limit¹) has been revised and is used in this report to assess emissions of, and exposure to, hexavalent chromium from these facilities.

Through our evaluation, we have found that there are remaining significant public health risks associated with hexavalent chromium emissions from chromium plating and chromic acid anodizing facilities, especially when facilities are located near homes or schools. In assessing existing, readily available, control technologies for chromium plating and chromic acid anodizing facilities, staff believes further control is feasible and necessary to protect the health of California's residents, by reducing exposure to hexavalent chromium.

¹ Chemicals are added to the plating bath that reduce surface tension. Surface tension reductions also reduce hexavalent chromium emissions.

REFERENCES

ARB, 1985. Air Resources Board. “Staff Report: Initial Statement of Reasons for Proposed Rulemaking – Public Hearing to Consider the Adoption of a Regulatory Amendment Identifying Hexavalent Chromium as a Toxic Air Contaminant”. 1985.

ARB, 1988. Air Resources Board. “Final Regulation Order – Hexavalent Chromium Airborne Toxic Control Measure (ATCM) for Chrome Plating and Chromic Acid Anodizing Operations”. 1988.

ARB, 1989. Air Resources Board. “Final Regulation Order – Chromate Treated Cooling Towers”. 1989.

ARB, 1998. Air Resources Board. “Staff Report – Proposed Amendments to the Hexavalent Chromium Control Measure For Decorative and Hard Chrome Plating and Chromic Acid Anodizing Facilities”. 1998.

ARB, 2001. Air Resources Board. “Final Regulation Order - Airborne Toxic Control Measure for Emissions of Hexavalent Chromium and Cadmium From Motor Vehicle and Mobile Equipment Coatings”. 2001.

ARB, 2004. Air Resources Board. “Barrio Logan Report: A Compilation of Air Quality Studies in Barrio Logan”. 2004.

ARB, 2005. Air Resources Board. “Final Regulation Order - Airborne Toxic Control Measure to Reduce Emissions of Hexavalent Chromium and Nickel from Thermal Spraying”. 2005.

BAAQMD, 2005. Bay Area Air Quality Management District. Regulation 2 Permits Rule 5: “New Source Review of Toxic Air Contaminants”. 2005.

OSHA, 2006. Occupational Safety and Health Administration. 29 CFR Parts 1910, 1915, 1917, 1918, and 1926, “Occupational Exposure to Hexavalent Chromium; Final Rule”. 2006

SCAQMD, 1990. South Coast Air Quality Management District. Rule 1401: “New Source Review of Toxic Air Contaminants”. 1990

SCAQMD, 1994. South Coast Air Quality Management District. Rule 1402: “Control of Toxic Air Contaminants from Existing Sources”. 1994

SCAQMD, 2003. South Coast Air Quality Management District. Rule 1469: “Hexavalent Chromium Emissions from Chrome Plating and Chromic Acid Anodizing Operations”. Amended May 2, 2003

SDCAPCD, 1996. San Diego Air Pollution Control District: Rule 1200: “Toxic Air Contaminants – New Source Review”. Revised June 12, 1996

U.S. EPA, 1995. U.S. Environmental Protection Agency. 40 CFR Part 63 Subpart N: “National Emission Standards for Chromium Emissions From Hard and Decorative Chromium Electroplating and Chromium Anodizing Tanks”. 1995.

U.S. EPA, 1998a. U.S. Environmental Protection Agency. 40 CFR Part 63: “Approval of Section 112(I) Authority for Hazardous Air Pollutants; Chromium Emissions from Hard and Decorative Chromium Electroplating and Chromium Anodizing Tanks; State of California”. 1998.

U.S. EPA, 2004. U.S. Environmental Protection Agency. 40 CFR Part 63: “National Emission Standards for Chromium Emissions From Hard and Decorative Chromium Electroplating and Chromium Anodizing Tanks”. 2004.

II. Need for Further Regulation

In 1986, the Board identified hexavalent chromium as a Toxic Air Contaminant (TAC). Hexavalent chromium was determined to be an extremely potent human carcinogen with no known safe level of exposure. The Board found that exposure over a lifetime to very low ambient hexavalent chromium concentrations could substantially increase a person's chance of developing cancer from exposure to the hexavalent chromium emissions. Based on this finding, in 1988 the Board adopted a very stringent ATCM which resulted in reducing hexavalent chromium emissions from chromium plating and chromic acid anodizing facilities by well over 90 percent. While an over 90 percent reduction is significant, even minute amounts are cause for concern, particularly for near-source receptors because of the potent carcinogenicity of hexavalent chromium.

Ambient levels of hexavalent chromium measured from our air toxics monitoring network are routinely low, with many measurements below the level of detection. Thus, the general public's exposure to ambient hexavalent chromium concentrations is not considered significant. However, near-source exposures can be significant. In 2002, SCAQMD conducted limited ambient air sampling around several chromium plating and chromic acid anodizing facilities. Based on this monitoring, estimated cancer risks from five facilities ranged from 20 to 55 per million people exposed. Four facilities had cancer risks of less than ten per million exposed people. One facility had an estimated cancer risk of 450 per million exposed people (SCAQMD, 2003a). [SCAQMD worked with the facility with cancer risk of 450 per million exposed people to reduce the risk.] Although these data were collected prior to implementation of Rule 1469, the results demonstrate that measurable and elevated concentrations of hexavalent chromium are found near these sources. Due to implementation of SCAQMD Rule 1469, these estimated cancer risks from the facilities tested could be lower.

Information from our Barrio Logan study reinforce findings that hexavalent chromium emissions from chromium plating and chromic acid anodizing operations are measurable, but highly localized. The Barrio Logan study, also showed that dust containing hexavalent chromium can contribute to ambient, near-source concentrations. This result was confirmed by follow-up sampling conducted by the SDCAPCD. These fugitive emissions can not be quantified for all facilities, but could increase the cancer risk beyond what is calculated based on emissions from the plating operation alone.

Our modeling analyses also indicate that near-source concentrations are, in many cases, significant. Hexavalent chromium emissions of as little as two grams per year can result in an estimated cancer risk of ten per million people exposed. Thus, staff has found that emissions from some facilities still result in unacceptable health risks to near-by receptors. Based on our evaluation of chromium plating and chromic acid anodizing facilities, we found that it is common to find sensitive receptors near these facilities. In fact, we found that 43 percent of facilities are located within 100 meters of a sensitive receptor. For all of these reasons, staff has determined that, despite the fact that significant emissions reductions have been achieved, there is a need to further reduce emissions, if technologically feasible.

This Chapter contains a general summary of the physical and chemical characteristics of hexavalent chromium and chromium compounds. Emissions and sources of hexavalent chromium, as well as health effects from exposure to hexavalent chromium are also provided. For ease of the reader, we have summarized some of the information from earlier reports, and have updated information where appropriate. For further information, the reader is referred to the following documents:

- Staff Report: Initial Statement of Reasons for Proposed Rulemaking – Identification of Hexavalent Chromium as a Toxic Air Contaminant (ARB, 1985);
- Proposed Hexavalent Chromium Control Plan (ARB, 1988a);
- Initial Statement of Reasons for Proposed Rulemaking – Proposed Airborne Toxic Control Measure for Emissions of Hexavalent Chromium from Chrome Plating and Chromic Acid Anodizing Operations (ARB, 1988b);
- Proposed Hexavalent Chromium Control Measure for Cooling Towers (ARB, 1989a);
- Toxic Air Contaminant Identification List Summaries (ARB, 1997);
- Airborne Toxic Control Measure for Emissions of Hexavalent Chromium and Cadmium from Motor Vehicle and Mobile Equipment Coatings: Initial Statement of Reasons for Proposed Rulemaking Executive Summary/Staff Report (ARB, 2001a); and
- Airborne Toxic Control Measure to Reduce Emissions of Hexavalent Chromium and Nickel from Thermal Spraying Initial Statement of Reasons for Proposed Rulemaking (ARB, 2004a).

In support of the need for further regulation, this Chapter also contains a synopsis of our Barrio Logan study findings and results from our survey to determine proximity of sensitive receptors to hexavalent chromium plating and chromic acid anodizing facilities.

A. Characteristics, Sources, and Ambient Concentrations of Hexavalent Chromium and Chromium Compounds

The chromium compounds of interest for this staff report are the TACs hexavalent chromium and trivalent chromium. Because hexavalent chromium is a TAC and has been identified as a human carcinogen with no known safe exposure level (ARB, 1985), the focus of the staff's proposal is to further reduce hexavalent chromium emissions from chromium plating and chromic acid anodizing facilities.

Trivalent chromium has been identified as a TAC by virtue of it being a hazardous air pollutant (HAP). By comparison to hexavalent chromium, it poses lesser health hazards. It is not a human carcinogen. Health hazards associated with use of trivalent chromium are presented to put these hazards in perspective to the health hazards associated with use of hexavalent chromium. Due to the comparatively lower toxicity impact, staff believes trivalent chromium plating (for decorative plating) to be a safer alternative to

hexavalent chromium plating. In fact, the trivalent chromium chemistry is already successfully in use at several California decorative chromium plating facilities. However,

although improvements in the process have been made, use of trivalent chromium is not available for all applications.

1. Chemistry

Trivalent chromium occurs naturally in the mineral chromite (chrome ore). It is from chromite that chromium metal and other chromium compounds are formed. Of the various chromium oxidation states, trivalent chromium is the most stable. Hexavalent chromium is the cation of a metal salt and does not occur naturally. Generally, hexavalent chromium ions are produced under strong oxidizing conditions from metallic chromium, with the most common ions being chromate ion (CrO_4^{-2}) or dichromate ion ($\text{Cr}_2\text{O}_7^{-2}$). Hexavalent chromium ions are strong oxidizing agents and are readily reduced to trivalent chromium in acid or by organic matter (ARB, 1997).

2. Sources and Emissions

Chromium plating, chromic acid anodizing, thermal spraying, and firebrick lining of glass furnaces are all stationary sources of hexavalent chromium in California. In California, stationary sources are estimated to emit about 1,000 pounds per year of hexavalent chromium. Approximately 0.13 tons/year are emitted by gasoline vehicles and 0.83 tons/year by other mobile sources such as trains and ships (ARB, 2006a).

Chapter V describes the emissions of hexavalent chromium in California from chromium plating and chromic acid anodizing facilities.

Based on staff's survey of the chromium plating and chromic acid anodizing industry it appears data used to compile the 2006 Almanac emission inventory overestimated the hexavalent chromium emissions contributed by chromium plating and chromic acid anodizing facilities. In the 2006 Almanac, emissions from chromium plating and chromic acid anodizing facilities were estimated to be about 30 pounds. Since publication of the 2006 Almanac, updated emission inventory information has resulted in a revision of the earlier estimate of 30 pounds to about 4.5 pounds. We estimate, based on our survey, that in 2005 emissions from chromium plating and chromic acid anodizing facilities were about four pounds. These data are provided in Chapter V. Information from the survey, along with updated emissions estimates from local air districts and other sources, will be used as the basis for emissions estimates in future Almanacs. Emission inventories are dynamic and are 'snapshots' in time. This reduction in hexavalent chromium plating and chromic acid anodizing facility emissions, that will be reflected in the next Almanac, will not appreciably reduce the total statewide stationary source estimated emissions.

3. Ambient Concentrations

Chromium compounds and hexavalent chromium are routinely monitored as part of the statewide ARB air toxics network. This monitoring meets U.S. EPA's standards for ambient monitoring. It does not reflect near source exposures which may be significant. Trivalent chromium compounds are not specifically monitored, but are accounted for as a fraction of total chromium. The monitoring results indicate that hexavalent chromium

concentrations have declined in recent years. The statewide mean concentration of hexavalent chromium has decreased from 0.27 nanograms per cubic meter (ng/m³) in 1992 to 0.091 ng/m³ in 2005. For hexavalent chromium ambient monitoring, the limit of detection has also decreased from 0.2 ng/m³ in 1992 to 0.06 ng/m³ in 2002. Therefore, the mean concentrations for 2002 and later are based on more precise measurements of ambient concentrations (ARB, 2006a).

Table II-1 shows the hexavalent chromium mean concentration at various monitoring sites in air districts with chromium plating and anodizing facilities (ARB, 2006b).

Table II-1. Hexavalent Chromium Mean Concentration in Air Districts with Chromium Plating and Anodizing Facilities for the Year 2005

District	ARB's Air Toxics Network Monitoring Site	Mean Concentration (ng/m³)
South Coast Air Quality Management District	Azusa-803 Loren Ave.	0.08
	Burbank – W. Palm Ave.	0.113
	North Long Beach	0.10
San Diego County Air Pollution Control District	Chula Vista	0.038
	El Cajon-Redwood Avenue	0.048
Ventura County Air Pollution Control District	Simi Valley-Cochran Street	0.05
Bay Area Air Quality Management District	Fremont-Chapel Way	0.05
	San Francisco-Arkansas Street	0.11
San Joaquin Valley Air Pollution Control District	Fresno-1st Street	0.063
	Stockton-Hazelton Street	0.12
Sacramento Metropolitan Air Quality Management District	Roseville-N Sunrise Blvd	0.058

As shown in Table II-1, mean concentrations range from 0.038 to 0.12 ng/m³ in 2005. These values would yield a range of estimated cancer risk of about 6 per million to 18 per million people exposed.

The mean concentrations may be overestimated. This is because prior to 2002 monitoring results below the limit of detection are assumed to be one-half the limit of detection or 0.1 ng/m³ (ARB, 2006a). Our ambient monitoring data show that the percentage of measurements that were below the detection limits increased steadily over the years, reaching a peak of over 96 percent in 1999. Starting in 2002, analysis was performed on composite samples representative of one quarter. This lowered the detection limit to 0.06 ng/m³. Even with this lowering of the detection limit, the percentage of measurements below the detection limit has been steady at around 28 percent.

Therefore, we conclude that ambient concentrations of hexavalent chromium are low and are not a general public health concern. From these ambient data we are also able to infer that the emissions from chromium plating and chromic acid anodizing facilities are a near source-concern. As further support, in the SCAQMD ambient monitoring mentioned earlier, concentrations measured downwind of 10 chromium plating and chromic acid anodizing facilities ranged from 0.03 ng/m³ to 2.99 ng/m³, with an average of 0.44 ng/m³ (SCAQMD, 2003a).

4. Indoor Sources and Concentrations

The extent of exposure to airborne hexavalent chromium in the indoor environment, other than in the workplace, is not known. There are no direct consumer uses of chromium that could lead to indoor emissions of hexavalent chromium compounds. During the emissions testing program conducted by the ARB, staff placed ambient air monitors inside the plating shops that were being source tested. Indoor levels of hexavalent chromium detected in the chromium plating facilities tested without forced ventilation systems in place ranged from four to 2,350 ng/m³. These data are qualitative and the numbers should not be used as indoor air concentration numbers. However, the numbers clearly indicate that hexavalent chromium is emitted from plating tanks, and is present as an airborne particle. These data are presented in Chapter V.

Environmental Tobacco Smoke is known to contain hexavalent chromium in the particulate matter components (ARB, 2005a) The Board identified environmental tobacco smoke as a TAC in January 2006.

5. Atmospheric Persistence

Atmospheric reactions of chromium compounds were characterized in field reaction studies and laboratory chamber tests. These results demonstrated an average experimental half-life of 13 hours (ARB, 1997). Based on this, one would expect there to be minimal amounts of hexavalent chromium in the dust found in and around the plating facilities. However, during ARB's Barrio Logan study and later during a SDCAPCD study, indoor dust was collected at plating shops to determine if hexavalent chromium was present. Results of dust sample analyses indicated that hexavalent chromium was indeed present in the dust samples. Hexavalent chromium concentrations in samples collected near the plating tank ranged from 407 to 89,800 milligrams per kilogram. These results are summarized in Appendix G.

6. Particle Size of Hexavalent Chromium

The potential of hexavalent chromium to become airborne and disperse into ambient air is dependent on particle size. If the particles are large, they would likely not become airborne, or if they would become airborne they would rapidly deposit. Our indoor air data collected during the emissions testing program demonstrate that hexavalent chromium is present in ambient air inside the facilities. Our modeling analyses in Chapter VII are based on hexavalent chromium particles being small enough to behave as a gas such that they are emitted into ambient air. To verify this, we consulted the U.S. EPA's AP 42

document and found that generally hexavalent chromium particles are eight micrometers or smaller in diameter. Particles of this size are thought to behave as a gas (U.S. EPA, 1996). Thus, we conclude that the modeling analyses accurately predict how hexavalent chromium is dispersed into the outside ambient air.

B. Health Impacts

Health Impacts of hexavalent chromium have been well documented. The ARB and U.S. EPA have identified hexavalent chromium as a TAC and HAP respectively. It is widely recognized as a potent human carcinogen with no known level of safe exposure. When hexavalent chromium was identified as a TAC, OEHHA developed a cancer potency value of $0.15 (\mu\text{g}/\text{m}^3)^{-1}$ that was approved by the SRP on TACs. This value means that a person's chance of developing cancer due to exposure to $1 \mu\text{g}/\text{m}^3$ of hexavalent chromium over a 70 year lifetime would be 146,000 chances per million people, almost 15 percent (ARB, 1985). Only one other identified TAC, dioxin, has been determined more likely to cause cancer than hexavalent chromium.

Unlike hexavalent chromium, trivalent chromium is not considered to be a human carcinogen (U.S. EPA, 2000). Results from a study published in 2000 documented that hexavalent chromium caused an increased incidence of lung cancer in a group of 2,357 workers at a chromate production plant. Cumulative hexavalent chromium exposure was associated with an increased lung cancer risk, while cumulative trivalent chromium exposure was not (AJIM, 2000). The U.S. EPA published another report that distinguishes the health impacts of the two oxidation states of chromium. In that report, hexavalent chromium is described as a "Group A known human carcinogen," while trivalent chromium "is much less toxic and is recognized as an essential element in the human diet." Trivalent chromium is "a Group D Carcinogen, not classifiable as to carcinogenicity in humans" (U.S. EPA, 2000).

Trivalent chromium is also markedly less potent in causing other toxic effects. While some adverse effects on the lung, kidney, and reproductive system have been reported in animal studies, and in studies of humans occupationally exposed to trivalent chromium compounds, the doses required to produce these effects are high. These doses were generally at least ten times higher than those for corresponding effects of hexavalent chromium (ATSDR, 2000). Some of this difference is apparently due to the poor absorption of trivalent chromium from the lung or digestive system, and its much reduced ability (compared to hexavalent chromium) to move from extracellular body fluids into cells of potentially sensitive tissues.

While the chemistry and toxicology of hexavalent chromium and trivalent chromium are markedly different, trivalent chromium is not without toxic effects and still should be handled appropriately.

C. Barrio Logan: A Case Study of Near Source Impacts

1. Background

Findings from an air monitoring study conducted by ARB in the Barrio Logan community in San Diego provide one important basis for our proposal. Barrio Logan is a residential-commercial area with single-family homes and apartments located in close proximity to light industrial facilities, including two chromium plating businesses. Many of the families living near the chromium plating shops include children and the elderly. In addition to the plating shops, there are approximately twelve single family residences, a cabinet shop, a neighborhood youth center, and a community swimming pool.

In May 2001, the ARB began monitoring around the two chromium plating facilities. One facility was a hard chromium plating facility with add-on air pollution control devices, including a HEPA filter and forced ventilation system. The other facility was a decorative chromium plating shop with in-tank controls (chemical fume suppressant) and no forced ventilation system. The chromium plating facilities were close to multiple residences and a community youth center and the community was concerned about hexavalent chromium emissions from these facilities. Thus, the ARB staff designed a receptor-oriented sampling study focusing on airborne hexavalent chromium concentrations.

The monitoring study also allowed us to evaluate the effectiveness of the existing Chromium Plating ATCM in providing public health protection, especially in community settings where residences and sensitive receptors are in close proximity to emission sources.

2. Air Monitoring

Air monitoring to determine hexavalent chromium ambient air concentrations began in May 2001 and continued periodically until May of 2002. Analysis of air samples, collected during monitoring from December 3 through December 17, 2001, found some unusually high hexavalent chromium levels (nine samples had results greater than 3.0 ng/m³) in the immediate vicinity of the plating shops and residences. The average of all 24-hour ambient samples was 0.98 ng/m³ (ARB, 2003). To put this in perspective, the statewide annual average hexavalent chromium concentration in 2005 is 0.091 ng/m³. The highest 24-hour ambient hexavalent chromium value recorded in ARB's statewide toxics network was 22 ng/m³ measured on February 20, 1995, in Burbank in the South Coast Air Basin. The next highest values statewide were 9.9 ng/m³ in 1991 and 3.0 ng/m³ in 1992.

Further sampling was conducted to identify the source or sources of the emissions and the specific activities leading to the high concentrations of hexavalent chromium found in December 2001. Follow-on sampling began on February 5 and ran daily through May 24, 2002, to identify the source of the emissions and to address the public health concern associated with the ambient hexavalent chromium levels. In addition to air monitoring, we also conducted compliance inspections, dust and soil sampling, a source test, indoor air sampling at the plating shops, extensive area walks and inspections, and air dispersion modeling.

3. Summary of Results and Findings

Analysis of samples implicated the decorative chromium plating operation as the source of the high ambient hexavalent chromium measurements. The data also showed that it was not only emissions from the daily plating process that were the cause of the high ambient hexavalent chromium readings. We also found that fugitive hexavalent chromium laden dust, that had accumulated within the shop was escaping through building openings and contributing to elevated outdoor hexavalent chromium concentrations (ARB, 2004).

This study was important to the evaluation of the Chromium Plating ATCM because results indicated that:

- Hexavalent chromium emissions from decorative chromium plating facilities may be underestimated;
- Poor 'housekeeping' practices may lead to fugitive hexavalent chromium emissions;
- Hexavalent chromium emissions from chromium plating create a local impact, a "Hot Spot," but the hexavalent chromium concentration drops off quickly; and
- Emissions from the HEPA controlled hard chromium plating facility were effectively reduced and not contributing to elevated levels of hexavalent chromium in the neighborhood.

D. Proximity of Facilities to Sensitive Receptors

As part of our evaluation, we collected data to determine proximity of sensitive receptors to all chromium plating and chromic acid anodizing shops. We learned from the Barrio Logan study that the receptors nearest volume emission sources (source without add-on air pollution control) are most affected.

ARB staff worked with the air districts to obtain receptor information for all chromium plating and chromic acid anodizing facilities. In instances when data were not available, ARB staff visited facilities and determined the distance to the nearest sensitive receptor. We are proposing to define sensitive receptor as a residence including private homes, condominiums, apartments, and living quarters; education resources such as preschools and kindergarten through twelve (K-12) schools; daycare centers; and health care facilities such as hospitals or retirement and nursing homes. A sensitive receptor would include long term care hospitals, hospices, prisons, and dormitories or similar live-in housing.

Out of 222 hexavalent chromium plating and chromic acid anodizing facilities, 19 percent are located within 25 meters of a sensitive receptor. We also found that 96 facilities (43 percent) are located within 100 meters of a sensitive receptor. Air quality modeling results, found in Chapter VII, indicate that receptors located within 100 meters of a

chromium plating operation (volume source) may be exposed to significant levels of hexavalent chromium. The detailed data on proximity of sensitive receptors to chromium plating and chromic acid anodizing facilities are summarized in Chapter IV.

These data point to the need to further control hexavalent chromium emissions to protect near-source receptors, especially sensitive receptors such as children and the elderly.

REFERENCES

AJIM, 2000. American Journal of Industrial Medicine. HJ Gibb, PSJ Lees, PF Pinsky & BC Rooney. Lung Cancer Among Workers in Chromium Chemical Production. 38:115-126. 2000.

ARB, 1985. Air Resources Board. “Staff Report: Initial Statement of Reasons for Proposed Rulemaking – Public Hearing to Consider the Adoption of a Regulatory Amendment Identifying Hexavalent Chromium as a Toxic Air Contaminant”. 1985.

ARB, 1988a. Air Resources Board. “Technical Support Document to Proposed Hexavalent Chromium Control Plan”. 1988.

ARB, 1988b. Air Resources Board. “Staff Report: Initial Statement of Reasons for Proposed Rulemaking – Proposed Airborne Toxic Control Measure for Emissions of Hexavalent Chromium from Chrome Plating and Chromic Acid Anodizing Operations”. 1988.

ARB, 1989a. Air Resources Board. “Proposed Hexavalent Chromium Control Measure For Cooling Towers”. 1989.

ARB, 1997. Air Resources Board. “Toxic Air Contaminant Identification List – Summaries – Chromium and Compounds Hexavalent Chromium”. 1997.

ARB, 2001a. Air Resources Board. “Airborne Toxic Control Measure For Emissions Of Hexavalent Chromium And Cadmium From Motor Vehicle And Mobile Equipment Coatings: Initial Statement Of Reasons For Proposed Rulemaking. Executive Summary/Staff Report”. 2001.

ARB, 2003. Air Resources Board. “Ambient Monitoring for Hexavalent Chromium and Metals in Barrio Logan: May 2001 through May 2002”. 2003.

ARB, 2004a. Air Resources Board. “Staff Report: Initial Statement of Reasons for Proposed Rulemaking – Airborne Toxic Control Measure to Reduce Emissions of Hexavalent Chromium and Nickel from Thermal Spraying”. 2004.

ARB, 2004. Air Resources Board. “Barrio Logan Report: A Compilation of Air Quality Studies in Barrio Logan”. 2004.

ARB, 2005a. Air Resources Board. “Proposed Identification of Environmental Tobacco Smoke as a Toxic Air Contaminant: Executive Summary”. 2005.

ARB, 2006a. Air Resources Board. “The California Almanac of Emissions And Air Quality”. 2006 Edition.

ARB, 2006b. Air Resources Board. Annual Statewide Toxics Summary-Hexavalent Chromium. 2006. (<http://www.arb.ca.gov/adam/toxics/statepages/cr6state.html>)

ATSDR, 2000. Agency for Toxic Substances and Disease Registry. "Toxicological Profile for Chromium". 2000.

SCAQMD, 2003a. South Coast Air Quality Management District. "Draft Staff Report - Proposed Amended Rule 1469-- Hexavalent Chromium Emissions from Chrome Plating and Chromic Acid Anodizing Operations and Proposed Rule 1426- Emissions from Metal Finishing Operations." 2003

U.S. EPA, 1996. U.S. Environmental Protection Agency. "Emission Factor Documentation for AP-42 Section 12.20 – Electroplating – Final Report". 1996.

U.S. EPA, 2000. U.S. Environmental Protection Agency, Office of Air Quality Planning and Standards, Research Triangle Park, NC. 453/R-99-007: "National Air Toxics Program: The Integrated Urban Strategy, Report to Congress". 2000.

III. Public Outreach and Data Collection

Public participation is a key ingredient of ARB's regulatory process. Reliable data are also necessary to provide a sound basis for regulatory action. This Chapter summarizes our efforts to inform and involve all stakeholders in the regulatory process. We also summarize our data collection efforts.

A. Public Involvement

The full benefits of public participation are realized when all stakeholders are involved and informed, particularly those directly affected by a regulation. In addition, public outreach to low-income and ethnically diverse communities is an important tool for fulfilling ARB's goal to provide equal environmental protection to all Californians. Thus, throughout the development of the proposed amendments to the ATCM, staff worked with the affected industry and public organizations to offer opportunities to: 1) become informed about the proposed changes to the ATCM and the public process; 2) provide pertinent information for ARB staff consideration; and 3) discuss comments and concerns.

Staff has used Internet web page <http://www.arb.ca.gov/toxics/chrome/chrome.htm> and electronic and mail-out notices to alert and invite organizations and individuals to workgroup meetings, public workshops, and to the public hearing at which these proposed changes to the ATCM will be considered. In addition, outreach efforts have included personal contacts via telephone, electronic mail, U.S. mail, surveys, facility visits, and meetings. The following stakeholders have been involved in the process:

- Chromium plating and chromic acid anodizing facility owners and operators;
- Metal finishing industry associations;
- Chemical suppliers;
- Control equipment manufacturers;
- Representatives from federal agencies, including the U.S. EPA and OSHA;
- Representatives from State agencies, including the Department of Toxic Substance Control (DTSC), the Water Resources Control Board, and the Business, Transportation, and Housing Agency;
- Representatives from California Air Pollution Control and Air Quality Management Districts;
- Environmental and community groups; and
- Representatives from pollution prevention and public health advocate organizations.

Stakeholders were initially made aware of ARB's intention to evaluate the current ATCM in January 2002 when stakeholder workgroups meetings were held in Diamond Bar, Fresno, and San Francisco, California. Over the course of the evaluation of the industry, the emissions testing program, and regulatory concept development, stakeholders were given the opportunity to participate and comment. A summary of outreach activities is shown below:

- Forming a District Workgroup and conducting meetings and conference calls;
- Forming a Stakeholder Workgroup and conducting meetings throughout the state;
- Creating the Hexavalent Chromium mailing list, activity website and maintaining a List-Serve to update interested parties;
- Conducting site visits in various districts to familiarize ARB staff with chromium plating and chromic acid anodizing processes and to select facilities for the emissions testing program;
- Preparing and disseminating a fact sheet on chromium plating and chromic acid anodizing operations for community outreach meetings;
- Participating in the SCAQMD negotiated rulemaking process;
- Conducting surveys on industry throughput levels and economics by mail, facsimile and telephone;
- Conducting a survey of chemical fume suppressant manufacturers;
- Developing a compliance assistance compact disk;
- Mailing workshop notices and posting workgroup materials on ARB's website; and
- Conducting public workshops in various locations within the State.

Staff held numerous meetings with affected industry and the public. A chronology of meetings is compiled in Appendix B of this report. In addition as specified in Health and Safety Code 39665(c), relevant comments on the ATCM received by ARB on the proposed amendments to the ATCM have been included in the administrative record. They are listed as a reference at the end of this Chapter (ATCM comments) and are available from ARB staff upon request for public review and comment.

B. Data Collection Tools

ARB staff gathered information by conducting surveys of air districts, chromium plating and chromic acid anodizing operations, and chemical fume suppressant manufacturers. A brief summary of the types of information collected is summarized below.

1. Air District Survey

Chromium plating and chromic acid anodizing operations are located in eight air districts. Because air districts implement the ATCM, ARB staff worked with them throughout the evaluation process to gather information on chromium plating and chromic acid anodizing facilities. To characterize the industry, ARB staff requested permit information, ongoing compliance reports, source test results, and available risk assessment information for active chromium plating and chromic acid anodizing operations. These data were used to form an initial mailing list and preliminary emission estimates. To gather more information, ARB staff conducted facility surveys and a receptor survey.

2. Chromium Plating and Chromic Acid Anodizing Facility Survey

The first step in evaluating the existing ATCM was to characterize the facilities in California. A letter dated April 12, 2004, was sent to each facility informing them of ARB's effort to re-evaluate the Chromium Plating ATCM and included a brief questionnaire related to calendar year 2003. The list of questions included type of operation, annual throughput in ampere-hours, type of in-tank and add-on controls, manual or hoist lines, grinding and polishing operations, and questions on storage of chemicals. To collect the information on the questionnaire, ARB staff contacted all facilities by telephone. The results of the survey were used to characterize the industry (see Chapter IV) and assess technological feasibility (see Chapter VI). The survey is included as Appendix C to this report.

3. Chemical Fume Suppressant Manufacturers Survey

The ARB staff also conducted a survey of chemical fume suppressant manufacturers to gather information on chemical fume suppressants and recommendations on optimum tank conditions for efficient plating. The survey requested information on fume suppressant formulations, the primary mechanism of reducing hexavalent chromium emissions, and recommended surface tension. We also collected information on recommended tank contaminant levels to determine when bath clean-up was recommended, such that decorative chromium plating baths would operate most efficiently. The survey information is summarized in Chapter IV. The survey is included as Appendix D to this report.

4. Economic Questionnaire

The ARB is required by law to assess the economic impact of regulations on the affected industry. To assist with this requirement, ARB staff contacted the facilities by mail in February 2005. The letter included a brief economic questionnaire to collect financial information for calendar year 2003. Businesses were then contacted by telephone to complete the questionnaire. These data are summarized in Chapter IV. The questionnaire is included as Appendix E to this report.

REFERENCES

ATCM Comments. Comment letters received by ARB on the proposed amendments to the Chromium Plating ATCM.

IV. Chromium Plating and Chromic Acid Anodizing Operations

ARB has regulated chromium plating and chromic acid anodizing facilities since 1988. In this Chapter, we provide a brief summary describing the processes. A detailed review of the source category can be found in the original staff report (ARB, 1988b). As part of our evaluation of the effectiveness of the existing ATCM, staff conducted two facility surveys. This Chapter also summarizes the results of these surveys by providing an overview of chromium plating and chromic acid anodizing facilities in California in 2003. One goal of the proposed amendments is to further reduce hexavalent chromium emissions and exposure; therefore, this Chapter primarily describes information on hexavalent chromium plating and chromic acid anodizing operations.

A. Overview

Electroplating is a chemical or electrochemical process of surface treatment. A metallic layer is deposited onto a base material. In the chromium plating process, an electrical charge is applied to a plating bath containing an electrolytic salt (chromium anhydride) solution. The electrical charge causes the chromium metal in the bath to fall out of solution and deposit onto various objects (usually metallic) placed into the plating bath. In an anodizing process, an oxide film is formed on the surface of the part.

The hexavalent chromium plating process is only about 20 percent efficient. This inefficiency leads to excess generation of hydrogen and oxygen bubbles as electrical current is applied to the plating bath. The bubbles rise through the tank and burst at the surface, leading to emissions of hexavalent chromium. Facilities using trivalent chromium baths emit trivalent chromium in the process. Once emitted from the facility, hexavalent chromium can be inhaled and entrained in the lungs. In a similar manner hexavalent chromium mist is generated during chromic acid anodizing. Thus, hexavalent chromium emissions have the potential to adversely impact public health on a statewide basis, as well as at the local community level. A schematic diagram of a plating tank is shown in Figure IV-1.

Figure IV-1. Main Components of an Electroplating Tank

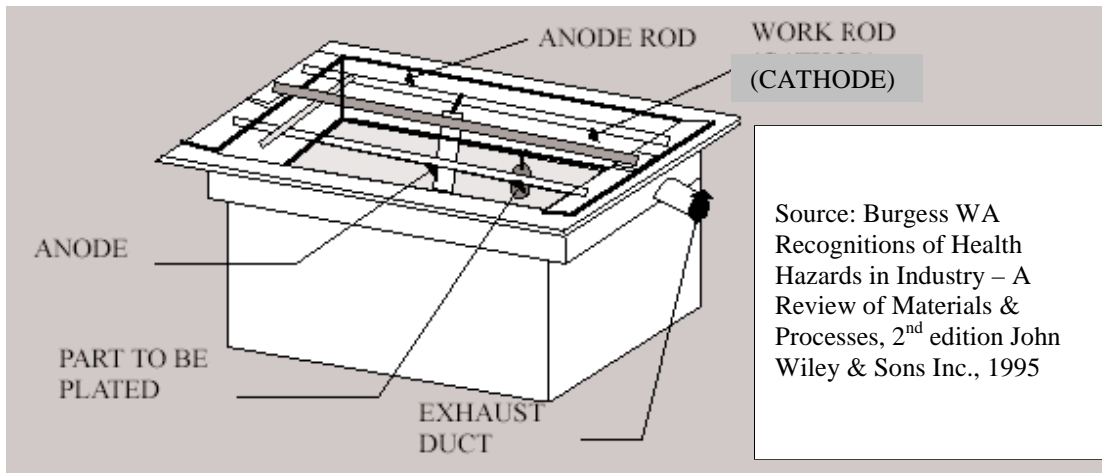

From OHCOW, 1997

As shown in Figure IV-1, the part to be plated becomes the cathode in the circuit. In chromic acid anodizing, the part to be oxidized serves as the anode in the circuit.

B. Types of Chromium Operations

As mentioned above, facilities use either trivalent or hexavalent chromium baths. However, the trivalent chromium plating process is only available for decorative chromium plating applications. Facilities using hexavalent chromium baths can be divided into three types. These include hard chromium (or functional chromium) plating operations, decorative chromium plating operations, and chromic acid anodizing operations. Decorative plating includes black chromium plating which is selected both for its functional and decorative properties. It has a dull dark gray, or black finish when polished. It has numerous applications and can be used in military, aerospace, automotive or other applications. It is a semi hard, non-reflective, abrasion resistant, heat and corrosion resistant coating.

The same hexavalent chromium bath chemistry can be used for both hard and decorative chromium plating. Table IV-1 provides a summary of the three processes.

Table IV-1. Description of Hexavalent Chromium Operations

	HARD CHROMIUM PLATING	DECORATIVE CHROMIUM PLATING	CHROMIC ACID ANODIZING
Type of layer	Thick layer (2.5 μm – 760 μm)	Thin layer 0.003 μm -2.5 μm	Electrochemical conversion
Properties provided	Corrosion protection, wear resistance, lubricity and oil retention among other properties	A decorative and protective finish	Corrosion and abrasion resistant surface by forming an oxide coating
Type of parts	Engine parts, industrial machinery, and tools	Bath fixtures, faucets, automotive bumpers and wheels, furniture components, motorcycle parts	Architectural applications, landing gears, giftware and novelties, automotive trim and bumpers
Plating duration	Hours or days	Seconds or minutes	<1 – 5 minutes
Substrate	Typically plated on steel	Typically plated on Nickel	Aluminum

The most familiar type of chromium plating is decorative chromium plating which provides a bright, and shiny finish on objects such as faucets and wheels. Generally, the base material has been nickel-plated prior to plating the chromium.

C. Data Resources

To characterize the industry, ARB staff contacted all air districts with active chromium plating and chromic acid anodizing facilities. These operations are under permits to operate issued by air districts and must comply with applicable district rules or the Chromium Plating ATCM. Together with the air districts and utilizing other data sources, a list of 355 potential operations was developed. A letter was sent to these 355 facilities informing them of ARB’s intent to review the ATCM, and requesting them to provide basic information about their business. Each facility was contacted by telephone to complete the questionnaire. From this survey, 222 active hexavalent chromium plating and chromic acid anodizing facilities and ten trivalent chromium plating operations were identified. Of the ten trivalent chromium operations, six facilities only plate using the trivalent chromium process, while the other four operations are part of a business that also conducts hexavalent chromium plating. ARB staff also conducted an economic survey to gather employee and economic information. Data on proximity of plating shops to receptors was also gathered with the assistance of the air districts. A summary of the data collected from our surveys is provided in the following sections.

D. Industry Characterization

The following sections provide information collected from our calendar year 2003 industry survey. Note that a distinction is made between number of facilities and number of operations. This is necessary because some facilities perform multiple operations. For example, one facility may conduct chromic acid anodizing as well as hard chromium plating.

1. Location and Number of Plating and Anodizing Facilities

ARB staff determined that in 2003 there were 228 combined trivalent and hexavalent chromium plating and chromic acid anodizing facilities in California. Several of these facilities perform multiple operations using hexavalent chromium (230 operations) and trivalent chromium (10 operations). Four hexavalent chromium plating facilities also conduct trivalent chromium plating. There are six facilities that only conduct trivalent chromium plating. Most of this Chapter will focus on the 222 hexavalent chromium plating and chromic acid anodizing facilities. The facility list was verified by air districts. Therefore, we believe that the industry is fully represented. Information collected included: facility location; type of operation; total throughput; add-on air pollution control equipment; in-tank controls; source test information; type of plating line; and grinding and polishing activity information. In the following graphs, note the distinction between facility and operation as we characterize the industry.

Out of 240 operations, the majority are in located in the SCAQMD. Figure IV-2 below depicts the plating and anodizing operations by air district. Other air districts include Shasta, Sacramento, Ventura, and Feather River.

Figure IV-2. Distribution of Chromium Operations by District (2003)

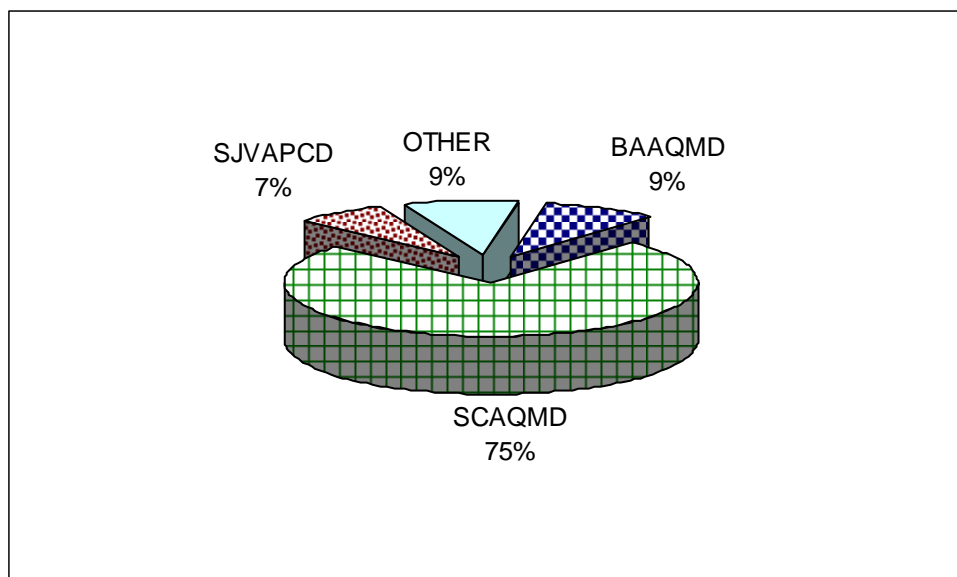

Out of 240 operations, 230 are hexavalent chromium plating or anodizing operations and ten are trivalent chromium plating operations. Table IV-2 below summarizes all active facilities by operation type. Note that there were 228 active chromium plating and chromic acid anodizing facilities in California in 2003 and twelve of them perform multiple operations.

Table IV-2. Number of Operations by Plating Type

Hexavalent Chromium Baths	
Hard (Functional) Chromium Plating	58
Decorative Chromium Plating	127
Chromic Acid Anodizing	45
Trivalent Chromium Baths	
Trivalent Chromium Plating	10
TOTAL	240

Figure IV-3 below shows that of the 222 active hexavalent chromium facilities, 55 percent of them perform decorative chromium plating, 25 percent perform hard (functional) chromium plating, and 20 percent conduct chromic acid anodizing.

Figure IV-3. Distribution of Hexavalent Chromium Operations by Type (2003)

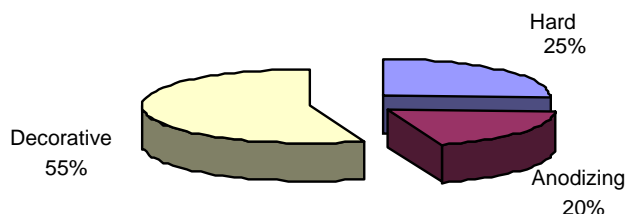

Emissions of hexavalent chromium from plating and anodizing operations depend on total throughput in ampere-hours. An ampere-hour is a unit of amperes integrated over time. It is an important variable because it determines the amount of hexavalent chromium emissions from a facility. The ampere-hours are multiplied by the emission rate (milligrams/ampere-hour) to calculate emissions. This is discussed later in Chapter V on emissions. Table IV-3 provides a summary of throughput ranges and averages by plating type. Data were not available for two operations, therefore, the numbers in Tables IV-2 and IV-3 differ slightly.

Table IV-3. Hexavalent Chromium Plating Type and Ampere-hours (2003)

	Hard	Decorative	Anodizing
Number of operations	57	126	45
Range of Ampere-hours	1,200 – 79,000,000	120 – 82,900,000	260 – 2,000,000
Average (Mean) Ampere-hours	12,500	1,700,000	150,000
Median Ampere-hours	2,900,000	95,000	43,000

*Unknown throughput information for 2 plating or anodizing operations

Although the ranges appear similar for hard and decorative plating, generally ampere-hours from hard chromium plating operations are much higher than those from decorative chromium plating. This can be seen by comparing the mean and median ampere-hours shown in Table IV-3. The higher throughput levels, in ampere-hours, that are shown for hard chromium plating are related to the length of time required to build the thick chromium layer typical of hard chromium plating.

In terms of throughput, many chromium plating and chromic acid anodizing facilities are small operations. Figure IV-4 shows the level of throughput, in ampere-hours for the various operations.

Figure IV-4. Throughput (in Ampere-hours) for Chromium Plating and Chromic Acid Anodizing Facilities in California (2003)

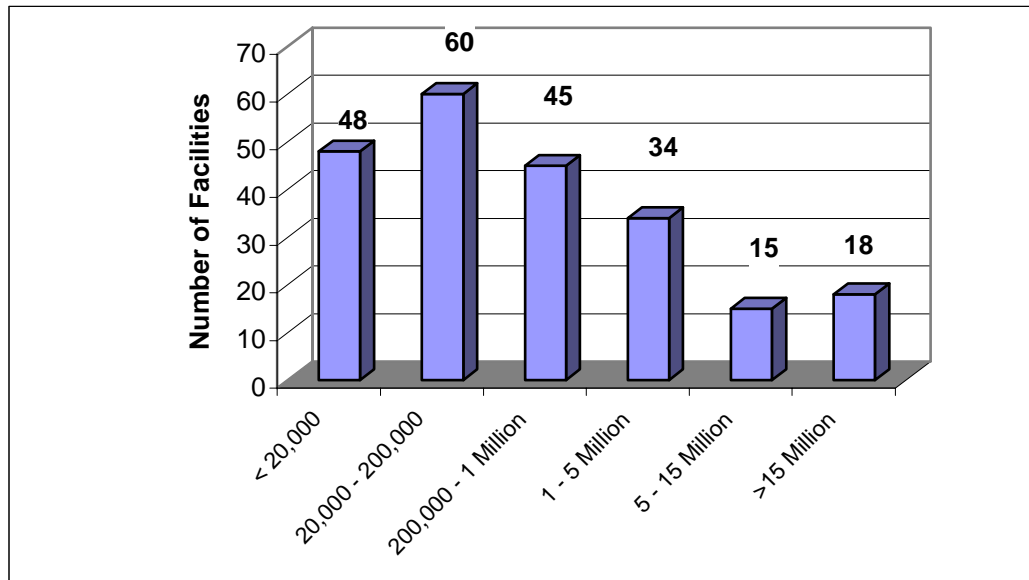

As shown in Figure IV-4, 48 (about 20 percent) facilities have annual throughput of 20,000 annual ampere-hours or less. Sixty facilities (27 percent) have throughput of between 20,000 to 200,000 annual ampere-hours. Over 50 percent of facilities have annual ampere-hours over 200,000.

2. Control Equipment

All chromium plating and chromic acid anodizing facilities already use a variety of controls to comply with the existing ATCM. Emissions control can be achieved through using add-on air pollution controls, such as filter systems, or in-tank controls, primarily chemical fume suppressants that reduce surface tension. The staff collected information on the types of emission controls in use based on visits to many plating and anodizing operations, and through the survey. The following section provides information on controls currently being used by the chromium plating and chromic acid anodizing industry. A description of these control types is provided in Chapter VI.

To comply with the existing ATCM, hard chromium plating facilities must use add-on air pollution control devices to meet emission limitations expressed in milligrams/ampere-hour (an alternative to meet a surface tension limit is provided for hard chromium plating facilities with less than 500,000 ampere-hours). Decorative plating and chromic acid anodizing facilities have the option of complying with an emission limit expressed in milligrams/dry standard cubic meter of air (mg/dscm) or meeting a surface tension requirement using a chemical fume suppressant with a wetting agent. Most have chosen the latter means of complying. Many facilities use a combination of controls to reduce emissions. Figure IV-5 shows distribution of current control options in use at the hexavalent chromium facilities in California.

Figure IV-5. Distribution of Emission Controls by Type of Chromium Operation

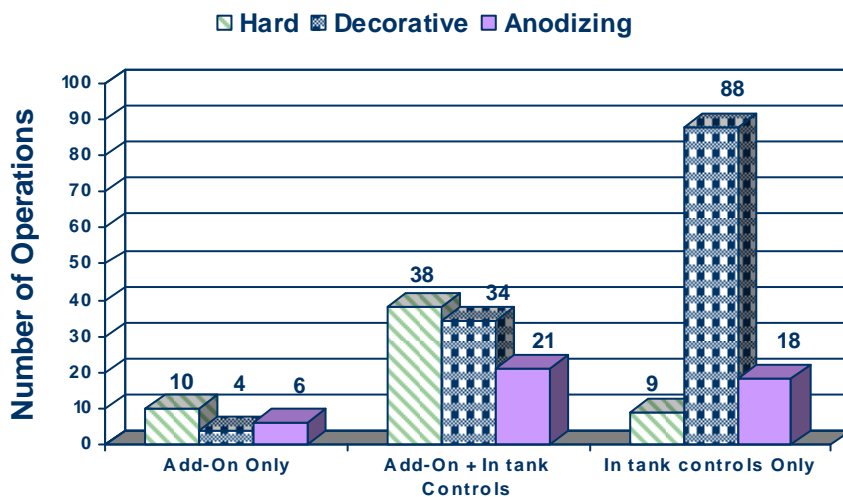

*Note no information about 2 operations that have shut down since 2003

As shown in Figure IV-5, in 2003, there are 113 operations controlling hexavalent chromium emissions with add-on air pollution control devices. Of facilities with add-on air pollution controls, 69 operations (14 chromic acid anodizing, 26 decorative chromium, and 29 hard chromium plating facilities), or 61 percent, had HEPA filters as their final control. Our survey also gathered source test emission rate information for facilities. Out of 113 operations with add-on air pollution control device(s), source test information was available for 71 (63 percent) of the operations.

Figure IV-5 also shows that the majority of operations used chemical fume suppressants as the sole source of emission control. As shown, 88 operations, or almost 70 percent of decorative chromium plating operations used chemical fume suppressants to control hexavalent chromium emissions. Note also that there are several hard chromium plating facilities using chemical fume suppressants. These are operations with throughput below 500,000 ampere-hours per year.

3. Housekeeping

Because of information gleaned from our Barrio Logan study, we also gathered information on grinding and polishing operations within facilities, and whether the plating line was automatic or manual. We are interested in this information because operations with grinding and polishing activities generate dust, which could act as a sink for hexavalent chromium mist being emitted from the plating or anodizing tank. Once disturbed by activities of the workers or ventilation within the operation, the dust can be re-entrained leading to fugitive emissions of hexavalent chromium.

Through the survey, we found 145 facilities that performed grinding polishing or buffing on site and 72 that did not. No information was available for five facilities.

The manner in which parts are processed, particularly for decorative plating, also could lead to hexavalent chromium emissions as droplets of liquid from the plating tank may fall to the floor surrounding the tank. Again, this could lead to dust and fugitive emissions of hexavalent chromium. Automatic lines generally have tanks set up in a row but manual lines may not. We found that there were 186 facilities with manual lines, 30 with automatic lines, and 3 facilities that had both manual and automatic lines. No information was available for 4 facilities.

4. Sensitive Receptor Distances

As we found in Barrio Logan, the impacts of hexavalent chromium emissions are highly localized. While ambient hexavalent chromium emissions may be low, emissions of hexavalent chromium from plating and anodizing could pose significant exposures to receptors living near the source. Therefore, to assess potential adverse impacts to near source receptors, with assistance from the air districts, ARB staff determined the distances to the nearest sensitive receptors for all facilities. Figure IV-6 provides distances, in meters, from the source to the nearest sensitive receptor for all hexavalent chromium facilities by type of operation. The receptors include: any residence including private homes, condominiums, apartments, and living quarters; education resources such

as preschools and kindergarten through grade twelve (K-12) schools; daycare centers; and health care facilities such as hospitals, retirement and nursing homes, long term care hospitals, hospices, prisons, and dormitories or similar live-in housing.

Figure IV-6. Distance (in Meters) Between Hexavalent Chromium Facilities and the Nearest Sensitive Receptor

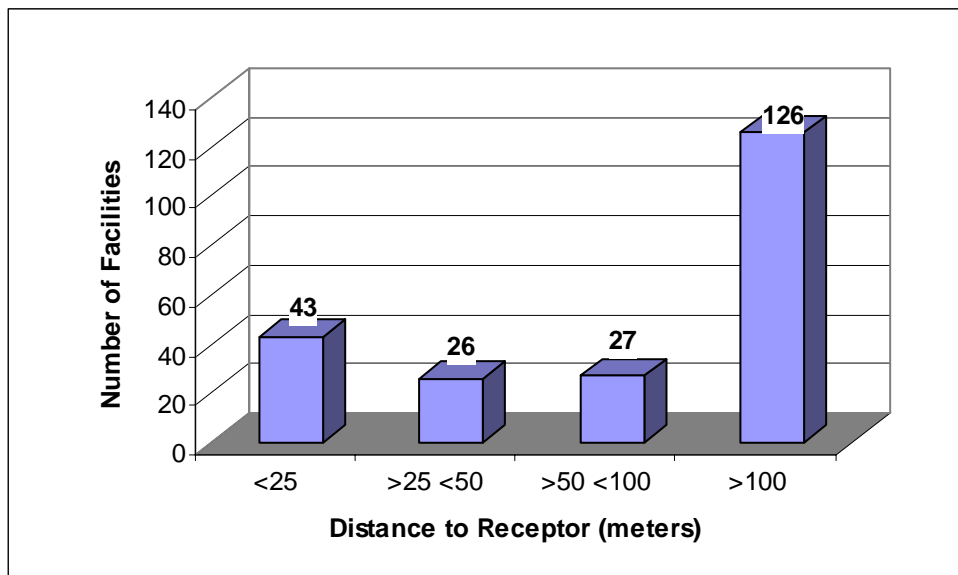

As shown in Figure IV-6, and as stated previously, 96 hexavalent chromium facilities are located within 100 meters of a sensitive receptor. This represents 43 percent of the facilities. Of these, 76 are decorative chromium plating and chromic acid anodizing facilities that generally control emissions with chemical fume suppressants. Figure IV-6 also shows that 43 of these facilities are located within 25 meters of a sensitive receptor.

5. Economic Survey

To characterize the industry financially, ARB staff contacted active facilities in February 2005 to obtain economic information. These data for the 2003 calendar year are summarized here and will be used to determine the economic impacts of the proposed amendments on chromium plating and chromic acid anodizing facilities. The financial information obtained is shown in Figure IV-7.

Figure IV-7. Gross Annual Revenue for Hexavalent Chromium Plating and Anodizing Facilities (2003)

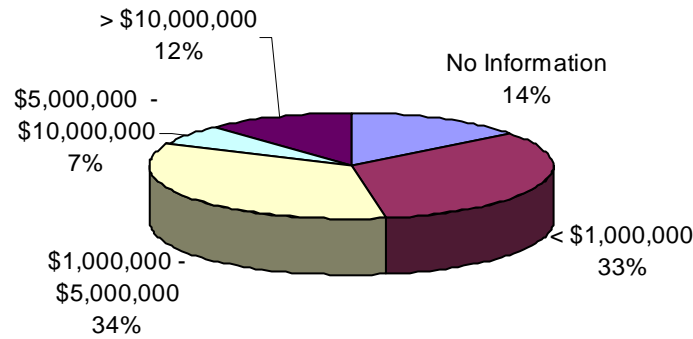

As shown in Figure IV-7, out of 222 hexavalent chromium facilities, we found that one third had gross annual revenue of less than \$1,000,000, while another third had revenues between \$1,000,000 to \$5,000,000. About 20 percent have annual revenue over \$5,000,000. No information was received from 14 percent of the facilities.

Table IV-4 provides data on the number of people employed by various plating and anodizing businesses.

Table IV-4. Number of Employees at Chromium Plating and Chromic Acid Anodizing Facilities

Employee Number Range	Number of Facilities
1 – 10	60
11 – 25	46
26 – 100	61
>101	24
No information	31

As shown in Table IV-4, 25 percent (60 facilities) employ ten or fewer people. Seventy-five percent of facilities have less than 100 employees.

REFERENCES

ARB, 1988b. Air Resources Board. “Staff Report; Initial Statement of Reasons for Proposed Rulemaking – Proposed Airborne Toxic Control Measure for Emissions of Hexavalent Chromium from Chrome Plating and Chromic Acid Anodizing Operations”. 1988.

OHCOW, 1997. Occupational Health Clinics for Ontario Workers Inc. “Electroplating – A Focus on Chrome Plating”. 1997

V. Emissions

This Chapter presents a summary of our decorative chromium plating emissions testing program to investigate and, if needed, improve the emission factor for chemical fume suppressant controlled decorative plating facilities. Based on the emission factor developed through the testing program, this Chapter also includes 2003 estimated statewide emissions of hexavalent chromium from chromium plating and chromic acid anodizing facilities in California. As background, information on existing hexavalent chromium emission factors is also included.

A. Overview

One goal of characterizing the industry and estimating hexavalent chromium emissions was to assess the potential for significant near-source residual cancer risk resulting from chromium plating and chromic acid anodizing. The remaining risk, if any, would be from facilities already complying with the Chromium Plating ATCM and air districts rules. During our evaluation, it became clear that a better understanding of emissions occurring from decorative chromium plating was necessary. To comply with the ATCM, most decorative chromium plating facilities have used chemical fume suppressants to reduce the bath surface tension. Reducing the surface tension reduces misting and, therefore, hexavalent chromium emissions. However, the overall effectiveness of chemical fume suppressants to reduce emissions was not well quantified. Therefore, ARB staff undertook an emissions testing program to quantify hexavalent chromium emissions from decorative chromium plating facilities using chemical fume suppressants.

B. Emission Factor Background

ARB staff, in 1988, established for hexavalent chromium plating and chromic acid anodizing operations uncontrolled and controlled hexavalent chromium emission factors (ARB, 1988b). These factors were based on source tests available at the time. For hard chromium plating and chromic acid anodizing facilities, an uncontrolled emission factor of 5.2 milligrams/ampere-hour was established. Based on available data, an uncontrolled emission factor of 0.5 milligrams/ampere-hour was established for decorative chromium plating facilities. 'Controlled' emission factors were then developed based on efficiencies reported for various control methods. For example, at the time, chemical fume suppressants were thought to be 95 percent effective. Therefore, the controlled hexavalent chromium emission factor was believed to be 0.025 milligrams/ampere-hour, based on uncontrolled decorative chromium emissions of 0.5 milligrams/ampere-hour. Likewise, an emission factor of 0.006 milligrams/ampere-hour for hard chromium plating facilities was based on 99.8 percent control from an uncontrolled hard chromium plating emission factor of 5.2 milligrams/ampere-hour.

Controlled emissions for hard chromium plating operations have since been measured directly through source testing emissions downstream of add-on air pollution control devices. However, quantifying controlled emissions from decorative plating operations has been more difficult because most facilities do not have add-on air pollution control devices. To better assess residual health risk from decorative chromium plating facilities,

improved information on emissions from tanks controlled with chemical fume suppressants was necessary. To that end, ARB undertook an emissions testing program.

In other developments, the SCAQMD also tested effectiveness of chemical fume suppressants to control hexavalent chromium emissions. (SCAQMD, 2004) From their testing, a list of chemical fume suppressant products was developed that under specified conditions, would result in emissions of no more than 0.01 milligrams/ampere-hour. The list of SCAQMD certified chemical fume suppressants can be found on the air district website at: <http://www.aqmd.gov/prdas/chrome%20plating/chromeplating.htm>

A summary of controlled and uncontrolled emission factors for decorative plating tanks that existed prior to our testing program is provided in Table V-1 below.

Table V-1. Decorative Chromium Plating Emission Factors in Existence Prior to ARB Testing Program (milligrams/ampere-hour)

	ARB (1988)	U.S. EPA (1996)	SCAQMD (2003)
Uncontrolled	0.5	2.14	4.4
Controlled with foam or foam plus scrubber	0.025	--	--
Controlled with chemical fume suppressants	0.025	0.008	--
Controlled with certified chemical fume suppressants	--	--	0.01
Controlled with HEPA filter			0.0015

In reviewing the data in Table V-1, it becomes clear that residual cancer risk would vary widely based on the emission factor chosen.

C. Emissions Testing Program

1. Overview

During our Barrio Logan study unexpectedly high concentrations of hexavalent chromium were measured outside a decorative chromium plating facility in San Diego (refer to Chapter II). These concentrations were higher than would have been predicted based on ARB's decorative chromium plating emission factor. In light of these findings, we conducted an emissions testing program at decorative chromium plating businesses to gather emissions information. The testing was conducted in two phases in consultation with the chromium plating industry and the air districts. Each test consists of three test runs. These individual runs are averaged to determine an emission rate. A summary of

both phases and testing result summary tables are provided in the sections below. Appendix F contains further data on each test conducted.

2. Phase I

During Phase I of the testing program, ARB staff conducted four source tests at three decorative chromium plating facilities. These facilities had forced ventilation systems and were using a variety of controls which included chemical fume suppressants. All of these tests measured emissions after in-tank controls (chemical fume suppressants) alone. These in-tank control test results ranged from 0.0017 to 0.810 milligrams/ampere-hour, with an average of 0.21 milligrams/ampere-hour. After evaluating these data, staff determined that the presence of forced ventilation systems may have led to higher emission rates than would be representative of the overall decorative chromium plating industry. Table V-2 presents results of the Phase 1 testing.

Table V-2. Average Hexavalent Chromium Emission Rates and Selected Testing Parameters for Phase 1

Test Number	1	2*	2*	3	4
Date	1/2003	1/2003	1/2003	3/2003	4/2003
Mean Hexavalent Chromium Emission Rate (milligrams/ampere-hour)	0.19	0.28	0.003	0.003	0.159
Surface Tension* (dynes/centimeter)	35.5	38.5	38.5	33.2	32.7
Chemical Fume Suppressant	CR 1700®	CR 1700®	CR 1700®	Fumetrol 140®	Dis Mist NP®
Other Controls	None	None	Composite Mesh Pad	Polyballs	None
Chromic Acid Concentration (ounce/gallon)	33.8	33.2	33.2	44.7	21.4

* Same test, emissions collected before and after the composite mesh pad.

These data were not used to develop an emission factor. However, we did find that, even though emissions off the tank varied widely, emissions after an add-on air pollution control device were consistently low. In one test we measured hexavalent chromium emissions before and after an add-on air pollution control device, a composite mesh pad system. The samples collected before the composite mesh pad system would be representative of a tank controlled with chemical fume suppressants. In this test, although the emission rate results collected before the composite mesh pad system varied for each of three test runs (0.0017 to 0.810 milligrams/ampere-hour), the emission rates measured after the composite mesh pad were consistent. Emission results ranged from 0.002 to 0.003 milligrams ampere-hour with an average of 0.003 milligrams/ampere-hour. These results provide evidence that add-on air pollution control devices provide a

consistent level of control regardless of operating parameters. In another test, use of polyballs and chemical fume suppressant yielded an emission rate of 0.003 milligrams/ampere-hour. This test result indicates that polyballs combined with in-tank controls provides emission reduction benefits over that achieved with chemical fume suppressants alone.

From these tests, we also evaluated differences in surface tension readings based on two types of instruments: a stalagmometer and a tensiometer. There was a difference observed between measurements with the two instruments. While all stalagmometer surface tension readings were higher than the tensiometer readings, no uniform difference was seen (*i.e.* they did not consistently vary by the same amount of dynes/centimeter). In developing the proposed amendments to the Chromium Plating NESHAP, U.S. EPA determined that measurements between the two instruments varied consistently by ten dynes/centimeter. Our testing did not confirm this.

We also learned that the emission rates from decorative chromium plating tanks were similar to those of hard chromium plating facilities with similar controls. We believe this indicates that uncontrolled emissions from decorative plating facilities were underestimated during the development of the original ATCM. This finding supports the proposal to have similar emission limits for all plating types.

3. Phase II

During Phase II of the testing program, ARB staff measured hexavalent chromium emissions at facilities with open tanks (*i.e.*, they do not have forced ventilation systems). These facilities all reduced hexavalent chromium emissions using chemical fume suppressants as the sole control source. These facilities are more representative of the decorative plating industry. Seven source tests were conducted at three facilities. To facilitate testing, ARB staff designed a temporary hood to capture emissions. The temporary hood set-up is shown in Figure V-1.

Figure V-1. Temporary 'Hood' for Capturing Hexavalent Chromium Emissions at Decorative Chromium Plating Facilities



The results of the first six tests were used to assess existing hexavalent chromium emissions from various decorative chromium plating tanks without forced ventilation. These tanks were all controlled with various chemical fume suppressants. The mean emission rate from these tests is representative of emissions existing prior to implementation of Rule 1469 in the SCAQMD. Table V-3 provides results for each of the first six tests.

Table V-3. Average Hexavalent Chromium Emission Rates and Selected Testing Parameters for Phase II

Test Number	1	2	3	4	5	6
Date	1/2004	2/2004	5/2004	10/2004	5/2005	6/2005
Mean Hexavalent Chromium Emission Rate (milligrams/ampere-hour)	0.009	0.004	0.050	0.050	0.052	0.065
Surface Tension* (dynes/centimeter)	39.9	29.5	36.8	42	30.1	31.5
Chemical Fume Suppressant	Protab 1000®	Clepo Mist®	Protab 1000®	Chrome Foam®	Chrome Foam®	Chrome Foam®
Chromic Acid Concentration (ounce/gallon)	36	34.7	33.4	30.2	25	28.2

* Surface tension was determined using a stalagmometer

For consistency, several variables remained as constant as practicable for the six tests shown in Table V-3. [The seventh test was done to verify the results of the SCAQMD fume suppressant certification program. The results of this test will be discussed separately.] The plating tanks were of similar size, the ampere-hours per test were consistent, and the same number and types of parts were plated each time. More details on each of these six tests are included in Appendix F. In addition to evaluating the effectiveness of different chemical fume suppressants to control hexavalent chromium emissions, we also monitored several other parameters to determine the effect, if any, on hexavalent chromium emissions. A brief description of our findings is provided below.

a. Hexavalent Chromium Emission Factor for Chemical Fume Suppressant Controlled Plating Tanks Derived from the Emissions Testing Program

Using the results from the six tests shown in Table V-3, a hexavalent chromium emission factor was developed to quantify the emissions from chromium plating and chromic acid anodizing operations using chemical fume suppressants as the sole source of control. These data are representative of 'real world' conditions. The emission rates from six tests ranged from 0.004 to 0.065 milligrams/ampere-hour, with an average of 0.04 milligrams/ampere-hour. For establishing the 2003 statewide hexavalent chromium emissions, this average emission rate, 0.04 milligrams/ampere-hour, was used.

b. Assessing Chemical Fume Suppressants to be Used for Compliance with the ATCM

Concurrent with our testing program, the SCAQMD tested chemical fume suppressants under controlled conditions. The purpose of this testing was to determine parameters that yielded optimum emission reductions. The SCAQMD demonstrated that hexavalent emissions can be further reduced if certain chemical fume suppressants are used. In fact, the SCAQMD demonstrated that several chemical fume suppressants could reduce emissions of hexavalent chromium to no more than 0.01 milligrams/ampere-hour

(SCAQMD, 2004a). The surface tension at which this emission rate is achieved is at lower surface tension than currently required in the ATCM.

Our first six tests were used to estimate emissions based on how facilities normally operate using chemical fume suppressants. Test seven was designed to verify the SCAQMD results. The seventh test was conducted using the chemical fume suppressant, Fumetrol 140®. This chemical fume suppressant was certified by the SCAQMD to reduce hexavalent chromium emissions to no more than 0.01 milligrams/ampere-hour when surface tension is maintained below 40 dynes/centimeter.

The results of the this test yielded an average emission rate of 0.009 milligrams/ampere-hour. This emission rate was achieved when surface tension was maintained at 35 dynes/centimeter, just below the level of SCAQMD certification. ARB was able to confirm results of the SCAQMD fume suppressant certification program. Based on this test result, as well as an evaluation of the SCAQMD source test data from their chemical fume suppressant certification program, ARB staff determined the chemical fume suppressants that would reduce emissions of hexavalent chromium to no more than 0.01 milligrams/ampere-hour at specified surface tensions. (SCAQMD, 2004a) Table V-4 lists these chemical fume suppressants with the surface tension at which the emission rate of 0.01 milligrams/ampere-hour is achievable.

Table V-4. Chemical Fume Suppressants Approved for Use at Specified Surface Tensions

Chemical Fume Suppressant and Manufacturer	Stalagmometer Measured Surface Tension (dynes/cm)	Tensiometer Measured Surface Tension (dynes/cm)
Benchbrite CR 1800® Benchmark Products	<40	<35
Clepo Chrome® MacDermid	<40	<35
Fumetrol 140® Atotech U.S.A.	<40	<35

Note that Table V-4 does not list all chemical fume suppressants certified by the SCAQMD. The chemical fume suppressants that employ a foaming mechanism for reducing emissions are not included on this list. This foaming component is critical to the effectiveness of the chemical fume suppressant. Most of the chromium plating facilities that will use these chemical fume suppressants as sole source of control are decorative chromium plating facilities. Many of these facilities do not operate in a manner that would allow the foam blanket to form and be maintained on the surface of the plating bath. In instances when the foam blanket is not maintained, emissions are likely higher than 0.01 milligrams/ampere-hour.

Through the emissions testing program and data obtained in the SCAQMD certification program, staff has developed two emission factors for hexavalent chromium plating tanks using chemical fume suppressants. The emission factor of 0.04 milligrams/ampere-hour

is developed for all tanks using chemical fume suppressants prior to 2005. The second emission rate of 0.01 milligrams/ampere-hour for chemical fume suppressant controlled facilities is used to evaluate the SCAQMD facilities in the 2005 baseline year, while the emission rate of 0.04 milligrams/ampere-hour is used for facilities in other parts of the State. Finally, to determine the benefits of adoption of the ARB staff's proposal, estimated cancer risk and emissions from facilities using chemical fume suppressants as the sole control will be calculated based on an emission factor of 0.01 milligrams/ampere-hour.

c. Effect of Surface Tension on Emission Rate

The requirement in the ATCM for controlling hexavalent chromium emissions with chemical fume suppressants specifies that surface tension is to be maintained below 45 dynes/centimeter. Hexavalent chromium emissions are lowered as surface tension is reduced. Therefore, part of our testing program was to determine if reducing surface tension further resulted in decreased emission rates. For tests one and two, we evaluated the effect of reduced surface tension on emissions. The emission rates presented in Table V-3 are the averages of three test runs. As shown, the mean emission rate for test one, run at a surface tension of ~ 40 dynes/centimeter, was 0.009 milligrams/ampere-hour, while for test two, run at a surface tension of ~ 30 dynes/centimeter, the mean was 0.004 milligrams/ampere-hour. While the average emission rate for test two is lower, as determined by the statistical t-Test, at a significance level where $\alpha=0.05$, the means, and therefore the emission rates, are not different.

Interestingly, the emission rates for tests five and six, conducted at the same facility with the same chemical fume suppressant and at similar surface tensions, are higher—not lower—than the emission rate calculated for test four at the same facility conducted at a higher surface tension. We believe this indicates that other factors and practices at individual operations also affect the rate of hexavalent chromium emissions.

We also evaluated emission rates with the type of chemical fume suppressant used. The chemical fume suppressants used in tests one through six all contain fluorinated surfactants as the active ingredients (further information on chemical fume suppressant chemistry is included in Chapter VI). Because of this, one would expect, if all other variables are similar, that emission rates would be similar. However, emission rates ranged from 0.004 to 0.065 milligrams/ampere-hour, with an average of 0.04 milligrams/ampere-hour. Recall that ARB's historical emission factor for hexavalent chromium emissions from decorative chromium plating tanks is 0.025 milligrams/ampere-hour.

d. Effect of Tank Contaminants on Emission Rate

Tests four, five, and six were conducted at the same facility and were designed to evaluate the effect of bath contaminant levels on hexavalent chromium emissions. Generally, as the level of metallic contaminants builds in the plating bath, the bath becomes less efficient, and more current is necessary to overcome the resistance caused by the contaminants. Increasing the current, in turn, produces more bubbling which could

lead to an emissions increase. Table V-5 contains information obtained from our survey of chemical suppliers, as well as contaminant levels present in the plating bath for tests four, five, and six. We have also included the hexavalent chromium emission rates obtained from each test to allow for easy comparison.

Table V-5. Plating Bath Contaminants, Concentration Levels Where Bath Clean-up is Recommended, and Hexavalent Chromium Emission Rates

	Manufacturer Recommended Action Level*	Test 4	Test 5	Test 6
Metallic Contaminants (milligrams/Liter)	5000–7000 mg/L	15,000 mg/L	60 mg/L	700 mg/L
Trivalent Chromium	0.5–1 oz/gal	0.64 oz/gal	< 0.1 oz/gal	0.2 oz/gal
Chloride	50 mg/L	130 mg/L	14 mg/L	20 mg/L
Mean Hexavalent Chromium Emission Rate		0.050 mg/amp-hr	0.052 mg/amp-hr	0.065 mg/amp-hr

* Average from 5 suppliers of chemicals to the plating industry.

The data in Table V-5 summarize information on common contaminants. The largest concentrations of metallic contaminants are typically nickel, copper, and lead. Trivalent chromium and chloride are also common contaminants that reduce bath efficiency. Note that despite heavy contaminant levels in test four the emission rate was lower than the emission rates in the two subsequent tests. If contaminants play a role in increasing emissions, we would have expected test five, conducted with a freshly prepared plating bath with essentially no contaminants (same tank, old solution disposed of) to yield the lowest emission rate. While we did not find a correlation with contaminant levels and emission rates, we nevertheless recommend that bath contaminants be minimized by conducting routine maintenance.

D. Statewide Hexavalent Chromium Emissions

The emission factor of 0.04 milligrams/ampere-hour was used to estimate 2003 hexavalent chromium emissions and estimated cancer risk for facilities using chemical fume suppressants as sole control. This would reflect emissions prior to implementation of Rule 1469 in the SCAQMD.

Statewide emissions of hexavalent chromium were calculated based on information from the 2003 survey of chromium plating and anodizing operations. To calculate emissions, the following equation was used:

$$\text{Emission Rate (milligrams/ampere-hour)} \times \text{Throughput (ampere-hours/year)} = \text{Annual Facility Hexavalent Chromium Emissions}$$

Emission rates were assigned as follows:

Volume (fume suppressant) Tank Emission Rate: 0.04 milligrams/ampere-hour

Point Source Emission Rate:

- Available emission rates from source tests

When source data were not available, emission rates were assigned based on type of controls corresponding to emission rates in the current ATCM as follows:

- HEPA or Mist Eliminator combination– 0.006 milligrams/ampere-hour
- Scrubber – 0.15 milligrams/ampere-hour

Figure V-2 shows the estimated statewide hexavalent chromium emissions in 2003.

Figure V-2. Statewide Hexavalent Chromium Emissions in 2003 Were 14.4 Pounds

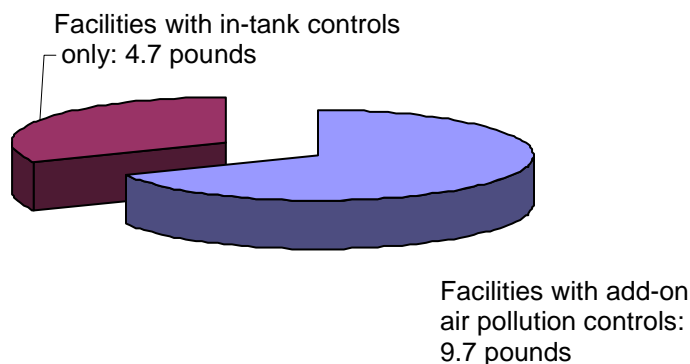

As shown in Figure V-2, statewide emissions of hexavalent chromium from chromium plating and chromic acid anodizing operations totaled 14.4 pounds in 2003. Facilities with in tank controls emitting 4.7 pounds per year, are primarily decorative plating and chromic acid anodizing operations. Facilities with add-on air pollution controls, emitting 9.7 pounds per year, generally are hard chromium plating operations. However, for health risk reasons, a number of decorative chromium plating and chromic acid anodizing facilities are also controlled with add-on air pollution control devices. While this amount of hexavalent chromium emissions seems small on a statewide basis, the emissions are

highly localized and the cancer potency of hexavalent chromium make these emissions a public health concern for sensitive receptors, especially those located in close proximity to plating and anodizing operations. It is also important to note that the emissions of hexavalent chromium shown in Figure V-2 do not include fugitive emissions of hexavalent chromium, which we have learned can be a significant part of a facility's overall impact.

E. Fugitive Emissions

In addition to hexavalent chromium emissions from the tank, chromium plating and chromic acid anodizing facilities also have fugitive emissions of hexavalent chromium, primarily dust. Dust accumulating in facilities from other operations such as grinding and polishing of parts prior to plating, and/or from poor housekeeping practices, provides a surface on which particles of hexavalent chromium from the plating operation may adhere. The hexavalent chromium may come directly from the plating process as mist is ejected from the bath. Other sources of hexavalent chromium may include droplets of chromic acid dripping onto other surfaces as plated parts are transferred to rinse tanks. This hexavalent chromium laden dust has the potential to become re-entrained due to air currents and activity in the plating or anodizing facilities.

Our Barrio Logan study confirmed that emissions of hexavalent chromium from a decorative plating shop were not only from the actual plating process, but from hexavalent chromium dust which became re-entrained. A study done by SDCAPCD also measured significant hexavalent chromium levels in dust of chromium plating and chromic acid anodizing facilities. This would indicate that the residence time might be longer for hexavalent chromium than was originally thought. During the emissions testing program, ARB staff also collected indoor air samples to qualitatively measure hexavalent chromium emissions. These studies are discussed individually and have prompted ARB to propose housekeeping requirements for hexavalent chromium plating and chromic acid anodizing facilities to minimize dust.

1. Barrio Logan Fugitive Emissions – Indoor Air Results

During the Barrio Logan study, indoor air samples were collected at two plating facilities. The first facility, a hard chromium plating facility had add-on air pollution control devices, including a HEPA filtration system. The second facility was a decorative chromium plating facility with no add-on air pollution control device or forced ventilation system. Indoor samples from the hard chromium plating facility averaged a hexavalent chromium concentration of 42.5 ng/m³, while the average at the decorative plating facility was 393.4 ng/m³. Continued indoor air sampling at the decorative plating facility yielded results as high as 2,315 ng/m³. To put these numbers in perspective, the statewide annual average of ambient hexavalent chromium levels was 0.091 ng/m³ in 2005. Key conclusions of this study are:

- High hexavalent chromium indoor air readings corresponded with high throughput (ampere-hour) at the decorative chromium plating facility;
- High levels of hexavalent chromium seen at ambient sites within the study area were consistent with high indoor levels at the decorative chromium plating facility,

indicating that the indoor hexavalent chromium emissions were emitted to the outdoors;

- Dust generated by clean up and construction activities was shown to contain high levels of hexavalent chromium (1200 mg/kg or higher), which exited the building; and
- The hard chromium plating facility, with add-on air pollution control devices, had low indoor concentrations of hexavalent chromium compared to those at the decorative chromium plating facility (ARB, 2003).

As a follow-up to the Barrio Logan study, SDCAPCD staff took additional samples at 10 other plating facilities in their district. These results are summarized in Appendix G. These data confirm that hexavalent chromium is in the dust at chromium plating and chromic acid anodizing facilities. This dust can become re-entrained in the indoor air and affect not only the workers at the facility, but also the receptors living near the facility when the dust is blown outside.

2. ARB - Indoor Air Samples During Source Testing

As we began the emissions testing program, we qualitatively measured indoor levels of hexavalent chromium during each test. Samples were taken during the source test and, for Phase II, samples were taken during the source test with the temporary hood in place. Background samples were also taken without the temporary hood for comparison. These results are summarized in Table V-6.

Table V-6. Summary of Indoor Air Results During Emissions Testing Program

Test Number	Samples	Range Indoor Air Concentration (ng/m3)	Average Indoor Air Concentration (ng/m3)
Facility 1	5	131* – 391*	262*
Facility 2	3	106 – 220	174
Facility 3	3	2.2 – 5.6	4
Facility 4	6	9.3 - 70	25
Facility 4 (background)	4	3.9 - 79	45
Facility 5	3	39 - 67	57
Facility 5 (background)	3	100 – 210	143
Facility 6	9	150-2350	976
Facility 6 (background)	4	120-460	248

*Total chromium numbers

Facilities four through six are those facilities that were tested by placing a temporary hood over the plating tank. While only qualitative, these data support that hexavalent chromium is being emitted from the plating tank during the electrolytic process. The data also indicate the presence of hexavalent chromium laden fugitive dust.

REFERENCES

ARB, 1988b. Air Resources Board. “Staff Report: Initial Statement of Reasons for Proposed Rulemaking – Proposed Airborne Toxic Control Measure for Emissions of Hexavalent Chromium from Chrome Plating and Chromic Acid Anodizing Operations”. 1988.

ARB, 2003. Air Resources Board. “Ambient Monitoring for Hexavalent Chromium and Metals in Barrio Logan: May 2001 through May 2002”. 2003.

SCAQMD, 2003a. South Coast Air Quality Management District. “Draft Staff Report - Proposed Amended Rule 1469-- Hexavalent Chromium Emissions from Chrome Plating and Chromic Acid Anodizing Operations and Proposed Rule 1426- Emissions from Metal Finishing Operations.” 2003

SCAQMD, 2004. South Coast Air Quality Management District. Certified List of Fume Suppressants for Facilities Performing Chrome Plating and Chromic Acid Anodizing Operations. 2004 (<http://www.aqmd.gov/prdas/ChromePlating/ChromePlating.htm>)

SCAQMD, 2004a. South Coast Air Quality Management District. “Hexavalent and Total Chromium Emissions from a Decorative Chrome Plating Tank Controlled by Various Mist Suppressants”. 2004

U.S. EPA, 1996. U.S. Environmental Protection Agency. “Emission Factor Documentation for AP-42 Section 12.20 – Electroplating – Final Report”. 1996.

VI. Reducing Hexavalent Chromium Emissions

No new technologies or technology transfers would be required for facilities to comply with the proposed amendments to the Chromium Plating ATCM. Hard chromium plating facilities, for the most part, have used add-on air pollution control devices such as scrubbers, composite mesh pads, and HEPA filters. Decorative chromium plating and chromic acid anodizing facilities have mostly used in-tank controls, such as chemical fume suppressants and polyballs. These same technologies, or combinations of technologies, would allow facilities to comply with the proposed amendments. Generally, the proposed amendments would require wider use of add-on air pollution control devices. This Chapter describes the types of methods used to control hexavalent chromium emissions.

A. In-tank Controls

In-tank controls are the most widely used method of reducing hexavalent chromium emissions. In-tank controls include chemical fume suppressants which are added directly to the plating bath solution and mechanical fume suppressants which float on top of the plating bath. Each is described below, along with information on their effectiveness at reducing emissions and the number of facilities using them, based on our industry survey.

1. Mechanical Fume Suppressants

Mechanical fume suppressants are added to a plating bath's surface to form a physical barrier. These plastic balls (similar in appearance to ping-pong balls), called polyballs, act as a barrier to prevent mist from escaping the tank during plating. ARB's "Senate Bill (SB) 1731 Risk Reduction Audits and Plans Guidelines for Chrome Electroplating Facilities" assigns for polyballs a 70 percent emission reduction efficiency (ARB, 1997a).

To achieve this level of emission reduction requires complete coverage of the plating bath. Our survey results indicate that polyballs are used by about 60 facilities. Of these facilities, about 40 use them in combination with a chemical fume suppressant. One test in our emissions testing program evaluated the effectiveness of polyballs in conjunction with fume suppressants to reduce emissions. This test yielded an emission rate of 0.004 milligrams/ampere-hour. However, we cannot measure the efficiency of this combination because we did not test the uncontrolled emissions from the bath.

Polyballs can be a source of fugitive emissions if they are ejected from the tank when parts are removed and the solution on the polyballs dries on the floor of the facility. Plated parts must be removed from the tank carefully to avoid pulling polyballs out of the tank along with the plated part. Polyballs may be a partial control option for facilities where there is concern with 'pitting.'

2. Chemical Fume Suppressants

In the chromium plating process, only about 20 percent of the electrical current applied actually deposits chromium onto the part. The remaining current forms bubbles, hydrogen gas at the cathode and oxygen at the anode, that rise to the surface of the bath. As these bubbles burst, hexavalent chromium is emitted into the air. These bubbles can be reduced by adding chemical fume suppressants directly into the plating bath to reduce emissions. Emissions are controlled by reducing surface tension of the bath, by forming a physical foam blanket across the tank surface during plating, or by using a combination of foam blanket and reduced surface tension. The most used type of chemical fume suppressant in California's plating industry are chemicals that reduce surface tension.

a. Chemical Fume Suppressants Containing a Wetting Agent

Surface tension is the force that keeps a fluid together at the air/fluid interface. It is expressed in force per unit of width such as dynes/centimeter (dynes/cm). Chemical fume suppressants that contain 'wetting agents,' or surfactants, reduce this surface tension. By reducing surface tension, gas bubbles become smaller and rise more slowly than larger bubbles. Slower rising bubbles have reduced kinetic energy such that when the bubbles do burst at the surface the hexavalent chromium is less likely to be emitted into the air, and the droplets fall back onto the surface of the bath (Bayer®).

The most common types of surfactants used in chromium electroplating and anodizing are fluorinated or perfluorinated compounds or, collectively, fluorosurfactants. The active ingredients are compounds such as organic fluorosulfonate and tetraethylammonium perfluorooctyl sulfonate. The fluorosurfactant-based fume suppressant products used today represent an improvement over the previous hydrocarbon-based products. Fluorosurfactants are more hydrophobic than hydrocarbon surfactants and they are more surface active than hydrocarbon surfactants. Fluorinated sulfonate surfactants are effective in highly acidic solutions because they are resistant to hydrolysis by strong acids (U.S. EPA 1998). Fluorocarbon chains are also 'stiffer' than hydrocarbon chains so they are able to pack more closely. For these and other reasons, fluorosurfactants are able to reduce surface tension to levels that cannot be reached with hydrocarbon surfactants (JPCB, 1999).

These products are highly effective at reducing hexavalent chromium emissions by reducing plating bath surface tension. However, the compounds have been shown to bioaccumulate (see further discussion in Chapter XI). The fluorosurfactants used as active ingredients in chemical fume suppressants are often referred to as perfluorooctyl sulfonates (PFOS). On March 10, 2006, U.S. EPA published at 40 CFR Part 721.9582, a proposal to add certain PFOS into their Significant New Use Rule for perfluoroalkyl sulfonates (PFAS)(U.S. EPA, 2006). The PFOS proposed for addition include the PFOS commonly used in chemical fume suppressants. More information can be found on the following website: <http://www.epa.gov/opptintr/pfoa/index.htm>.

The notice for the amended Significant New Use Rule indicated that comments were being accepted to determine if these PFOS were in current use, such that a potential

exception could be included. As of this writing, it is unclear as to what U.S. EPA's final action will be. However, it is clear that the PFOS used to control hexavalent chromium emissions from chromium plating and chromic acid anodizing have been in use since the early 1990's (P&SF, 2000). Should the U.S. EPA act to include the PFOS in the Significant New Use Rule without providing an exception for their use in electroplating, the manufacturer or importer would have to seek approval from U.S. EPA to allow their use in electroplating. ARB staff will continue to follow developments here, and would potentially have to propose regulatory changes depending on the final rule.

To put the magnitude of surface tension reduction required to suppress hexavalent chromium emissions into perspective, consider that the surface tension of water is about 72 dynes/centimeter. The current ATCM requirement is to reduce surface tension below 45 dynes/centimeter. Data suggest that lowering the surface tension below 45 dynes/centimeter reduces emissions further. In fact, product literature from a manufacturer of the fluorinated surfactants indicates that maximum emission reduction is achieved at 30 dynes/centimeter (Bayer®). Our testing results did not statistically confirm that reducing surface tension to this level reduced emissions further. Balancing cost, staff is proposing that surface tension be maintained below 40 dynes/centimeter.

Another advantage of chemical fume suppressants containing fluorinated surfactants is that once a certain concentration is added to the tank, surface tension reduces rapidly (Kissa, 1994). Thus, a consistent level of emission reduction is provided. This is further justification for requiring facilities to use the chemical fume suppressants that rapidly reduce surface tension.

Earlier generation chemical fume suppressants were thought to cause pitting. Pitting is development of small holes or imperfections during plating. This was of particular concern in hard chromium plating applications due to the length of time necessary to build the desired chromium thickness. Earlier generation chemical fume suppressants, although perfluorinated, contained salts. These salts, when mixed with the fluoride ions in the plating bath, became suspended and caused roughness, porosity or cracking of the chromium plate leading to pits. The chemical fume suppressants in use today no longer contain these salts. Thus, chemical fume suppressants used today containing fluorosurfactants are no longer a source of 'pitting,' and are accepted for use even in hard chromium plating applications. However, if the plating bath contains other contaminants that may cause pitting, such as chloride, the chemical fume suppressant will accentuate the pit (P&SF, 2000 and Jones, 2006).

The main loss of fluorinated chemical fume suppressants is through dragout of solution because fluorinated surfactants are highly stable (U.S. EPA, 1993). Studies have shown that the carbon-fluorine (C-F) chemical bond can remain stable when exposed to acids, alkali, oxidation, and reduction at relatively high temperatures (Kissa, 1994). Therefore, it is not expected that the surface tension of a bath will increase after a few days of use, due to chemical breakdown, for these types of surfactants.

However, surface tension will increase as chemical fume suppressant is lost to drag out as parts are removed from the tank. The quantity of chemical lost will depend on

workload and shop-specific parameters. Dragout can be minimized if electroplated parts are sprayed off over the tank, or drip trays are installed to return the surfactant to the tank along with the excess chromic acid.

b. Foam Blanket Chemical Fume Suppressants

Foam blanket chemical fume suppressants generate a layer of foam on the surface of the bath when current is applied. The foam blanket is formed by agitation from the hydrogen and oxygen gas bubbles generated during plating. The blanket reduces hexavalent chromium emissions by physically entrapping the mist in the foam.

There are some issues with use of foaming chemical fume suppressants. For example, foam blankets need time to form after the current is applied and may also need time to re-form after parts are removed, or makeup chemical fume suppressant is added to the bath. For shops that use their tanks intermittently, a consistent level of emission reduction is not achieved. Under the staff's proposal, chemical fume suppressants that rely on building a foam blanket for emission control could no longer be used.

Foam blankets also can entrap hydrogen gas, which may result in explosions if a spark is generated. This is more of a concern in hard chromium plating than in decorative chromium plating, because of the higher current densities and longer plating times associated with hard chromium electroplating operations. A foam blanket can also reduce the evaporative cooling of a bath, resulting in the need for increased cooling by other means (U.S. EPA, 1993).

c. Measuring Surface Tension

Because hexavalent chromium emissions are reduced only at lowered surface tensions, accurate measurement of the bath's surface tension is a critical compliance step. Surface tension has traditionally been measured either using a stalagmometer or a tensiometer. A du Nouy tensiometer is an instrument that measures surface tension by increasing force to a platinum-iridium ring in contact with the surface of the liquid. The tensiometer pulls on the ring and measures the force it takes to break the ring from the surface.

The stalagmometer is an instrument used to measure surface tension by determining the mass of a drop of liquid by weighing, a known number of drops or by counting the number of drops obtained from a known volume of liquid. Measuring surface tension with a stalagmometer is sometimes referred to as the 'drop weight' method. A stalagmometer is similar to a pipette (CDPHE 1999). Measuring surface tension with the stalagmometer is the most often used method, mostly because of cost considerations.

U.S. EPA's research found that measurements of surface tension with a tensiometer were approximately 20 percent lower than those obtained with a stalagmometer (U.S. EPA, 2002). Results of surface tension measurements from our emissions testing program also confirm that the tensiometer routinely gives lower surface tension readings than the stalagmometer. However, we did not see a consistent difference.

In 2004, U.S. EPA amended the Chromium Plating NESHAP. One of the changes establishes different surface tension standards, depending upon the type of measurement device used. If a facility uses a stalagmometer to measure surface tension, the surface tension should not exceed 45 dynes/centimeter. If a tensiometer is used, the surface tension limit is 35 dynes/centimeter (U.S. EPA, 2004).

Generally, the tensiometer is considered to provide the truer measure of surface tension. However, tensiometers can cost thousands of dollars, while stalagmometers only cost hundreds of dollars (Hensley, 1997).

Staff is proposing to incorporate the Chromium Plating NESHAP's revised surface tension requirements into the ATCM. For measuring surface tension the ATCM has referenced an U.S. EPA method, Method 306-B, contained in Appendix A of 40 Code of Federal Regulations, part 63. This Method 306-B requires use of ASTM Method D 1331-89, Standard Test Methods for Surface and Interfacial Tension of Solutions of Surface Active Agents, when surface tension is measured with a tensiometer. When measurements are taken with a stalagmometer, Method 306-B requires operators to use the instructions that came with the measuring device. For standardization, staff is proposing to include, as Appendix 8 to the ATCM, a standardized procedure for measuring surface tension with a stalagmometer. This method or a method approved by the permitting agency must be used to measure surface tension with a stalagmometer.

d. Fume Suppressants Used in California

As part of our survey of the chromium plating and chromic acid anodizing industry in California, ARB collected information on the types of fume suppressants used. The data are summarized in Table VI-1 below.

Table VI-1. Types of Chemical Fume Suppressants Used in California in 2003

Fume Suppressant Name	Numbers Using
Fumetrol 140®	108
Fumetrol 140® + Dis Mist®	16
Zero Mist®	10
Dis Mist NP®	23
Protab 1000® or Mactec Spray Stop®	5
Fumetrol 101®	5
Benchbrite®	4
Chrome Foam	4
Clepo Chrome Mist Control®	5
Foam Lok®, Harshaw MSP®, EconoChrome®	3

Of the 230 hexavalent chromium operations, 190 reported use of fume suppressant either as the sole control, or with other control devices. Table VI-1 shows the types of chemical fume suppressants reported as used by 183 operations for calendar year 2003. The other operations did not name the type of chemical fume suppressant used.

After the survey was conducted, SCAQMD amended their chromium plating and anodizing rule. They introduced the chemical fume suppressant certification program. The list of certified chemical fume suppressants can be found on their web site at: <http://www.aqmd.gov/prdas/chromeplating/chromeplating.htm>

Because the type of chemical fume suppressant used is critical to the chemical's ability to reduce and maintain lower surface tension, ARB staff also conducted a survey of chemical fume suppressant manufacturers to gather information on product formulation, mechanism of action, and the surface tension to be achieved for maximum effectiveness. The results of the survey are shown in Table VI-2, below.

Table VI-2. Summary of Chemical Fume Suppressant Mechanism of Control and Recommended Surface Tension

<u>Chemical Fume Suppressant</u>	<u>Primary Mechanism and Surface Tension</u>
Atotech USA	
Dis Mist NP®	Foam 1-2 inches
Fumetrol 140®	Surface Tension Reducer (30 dynes/cm with a tensiometer)
Benchmark	
Benchbrite CR-1800®	Surface Tension Reducer (40 dynes/cm)
Chemithon-Micel	
Chrome Foam®	Surface Tension Reducer (20-30 dynes/cm)
MacDermid	
Proquel 1299®	Surface Tension Reducer (40 dynes/cm)
Macuplex STR®	Surface Tension Reducer (40 dynes/cm)
Clepo Cr Mist Control®	Surface Tension Reducer (40 dynes/cm)
Enthone®	
Zero-Mist®	Surface Tension Reducer (30 dynes/cm)

(Source: Chemical Manufacturer Survey)

As shown in Table VI-2, almost all chemical fume suppressants used in California's chrome plating industry control hexavalent chromium emissions by reducing bath surface tension. It should also be noted that most manufacturers recommend operating baths at 40 dynes/centimeter or below for maximum effectiveness. The current ATCM requires surface tension to be maintained below 45 dynes/centimeter. The survey also indicates that the products that reduce surface tension all use fluorosurfactants as the active ingredient.

B. Add-on Air Pollution Control Devices

When the Chromium Plating ATCM was first adopted in 1998, hard chromium plating and chromic acid anodizing facilities were required to use add-on air pollution control devices to comply with hexavalent chromium emission limits (except for smaller operations). A number of decorative chromium plating facilities also use add-on air pollution control devices to comply with air district health risk rules. From our survey, 113 facilities reported using add-on air pollution control devices. Most facilities have either a one stage system consisting of composite mesh pad, mist eliminator or scrubber; or a two stage system which has a HEPA filter after the first stage. A brief description of the types of add-on air pollution control devices currently in use follows.

1. High Efficiency Particulate Arrestor (HEPA) Filter

High Efficiency Particulate Arrestor (HEPA) filters are specifically designed for the collection of submicrometer particulate matter at high collection efficiencies. First developed in the 1940's for the Manhattan Project to control radioactive contaminants, HEPA filters are rated at 99.97 percent effective in capturing particles 0.3 μm in diameter. Particles of 0.3 μm in diameter represent the most penetrating particle size, meaning that the 99.97 percent efficiency is the worst efficiency. Smaller or larger particles are trapped with higher efficiency (HHS, 2000). When used in particulate air pollution control, HEPA filters are best utilized in applications with a low flow rate and low pollutant concentration. Typically HEPA filters are installed downstream of another control device to lessen loading on the filter, thereby lengthening its life. These products do require maintenance. The filters should be replaced at least annually and disposed of as hazardous waste. For all but very small facilities, HEPA filters are considered the most effective control of hexavalent chromium emissions. They represent BACT and can reduce hexavalent chromium emissions to no more than 0.0015 milligrams/ampere-hour. About one-third of facilities are already using HEPA filters to reduce emissions.

2. Composite Mesh Pad or Dry Scrubber

A Composite Mesh Pad (CMP) system typically consists of several layers of more than one monofilament diameter and/or interlocked fibers densely packed between two supporting grids. Most systems do exist in two or three stages to ensure collection of re-entrainment caused by washdown. A 3 stage system will remove small particles from one to 3 μm at about 99 percent efficiency. Each stage can capably remove particles at this size but it will take at least 3 stages to reach this efficiency. Filters must be changed every one to six years and need to be disposed of as hazardous waste (CDPHE, 1999 and U.S. EPA, 1998).

3. Wet Scrubber

A wet scrubber is similar to a CMP system, or Dry Scrubber, except that before the first stage of filtration, there is a water washdown of the influent mist in order to increase the size of the particles in the mist. In this system, a packing media is used to coalesce these

larger particles and allow them to drip off into a reservoir at the bottom of the scrubber. This “packing” can best be described as a big bag of polypropylene “whiffle” balls.

4. Fiber-bed Mist Eliminator

A Fiber Bed Mist Eliminator (FBME) removes contaminants from a gas stream through the mechanisms of inertial impaction, direct interception, and Brownian diffusion. A FBME consists of one or more fiber beds and each bed consists of a hollow cylinder formed from two concentric screens designed for horizontal, concurrent gas liquid flow through the fiber bed. It is typically installed downstream from another control device to prevent plugging (CDPHE, 1999). The filter should last four to six years and needs to be disposed of as hazardous waste. According to our survey, this control technology is not widely used today in California.

5. Enclosed Tank Covers

For hard chromium plating and chromic acid anodizing facilities, devices are available to totally enclose the plating tank. These containers, sometimes referred to as Merlin hoods, form a sealed system to capture the hexavalent chromium emissions within the enclosed area. Gasses resulting from plating are vented through a semi-permeable membrane which allows the hydrogen and oxygen to exit, but, due to its size, the hexavalent chromium does not pass through. Two facilities reported using this technology. This technology would not be feasible for decorative chromium plating due to the short periods of time that plating actually occurs.

C. Alternative Processes

Numerous processes are available, that in some cases, could be used as a replacement for some hexavalent chromium plating and chromic acid anodizing operations. Some of these processes are briefly described below.

1. Trivalent Chromium for Decorative Chromium

Decorative chromium consists of coatings typically 0.003 to 2.5 μm to provide a bright surface with wear and tarnish resistance when plated over a nickel layer. It is used for plating, for example, automotive trim/bumpers, bath fixtures and small appliances. An option staff considered for this proposal is to phase out hexavalent chromium for decorative chromium plating facilities and replace it with the trivalent chromium process. This option would eliminate cancer risk from decorative chromium plating facilities because trivalent chromium is not considered a carcinogen; however, it is still a toxic compound.

Trivalent chromium baths are currently commercially available for decorative chromium plating. In 2003, there were 10 active trivalent chromium operations in California. Of these, six are stand alone trivalent chromium operations and four perform both hexavalent and trivalent chromium plating for decorative applications. The double cell

process developed in the 1970's is improved and has been changed to a single cell process, which is easier to maintain. There are many benefits to using a trivalent chromium process as well as potential issues. These are presented in the following paragraphs. We also provide an example of costs associated with converting from the hexavalent chromium decorative plating process to the trivalent chromium process.

a. Benefits and Issues

The greatest benefit to using a trivalent chromium process is reduction in health risk. Trivalent chromium is not a carcinogen like hexavalent chromium. However, it has toxic effects. As such, it is a U.S. EPA HAP and is a TAC. In the Chromium Plating NESHAP and ATCM, emissions from trivalent chromium baths are regulated because of this designation. The health effects associated with trivalent chromium are summarized in Chapter II.

In addition to the reduction in toxicity, the trivalent chromium process also has other environmental advantages for the plating facility. The total chromium concentration in a trivalent chromium bath is significantly less than that of a hexavalent chromium bath. This leads to less wastewater and sludge, decreasing the hazardous waste cost for the facility. The misting and odor is greatly reduced compared to a hexavalent chromium bath, thereby protecting the worker. Trivalent chromium also has better throwing power² reducing the number of rejects as well as buffing and polishing of parts (P&SF, 2003a).

In addition to benefits, there are some potential issues with the trivalent chromium process. The first issue is the color. The newer baths produce a deposit much closer in color to the hexavalent chromium deposit. If a standard trivalent chromium plated part is placed more than a few inches away from a hexavalent chromium plated part, most consumers would not be able to distinguish between the two deposits. If it placed adjacent, manufacturers and consumers might prefer the hexavalent chromium deposit. (P&SF, 2003a). To keep the color consistent, the trivalent bath requires careful monitoring (Mikhael, 2006).

The second issue is thickness and corrosion resistance. Trivalent chromium can be plated thick enough for decorative purposes. Adhesion and cohesion are as good as hexavalent chromium deposits up to at least 1.4 μm (P&SF, 2003a). However, some industry representatives believe that for automotive applications, the trivalent deposit is not thick enough to meet the step test requirements (Leehy, 2006). The manufacturers are working on acceptance of a trivalent finish for the automotive industry and have successfully changed the requirements for one company (MacDermid, 2006). Corrosion protection is also an issue for automotive applications. Hexavalent chromium ions themselves offer some corrosion resistance for the plated substrate by "chromating" the part. To achieve the same affect for parts plated with trivalent chromium, post-treatments/dips after plating can be used to produce an equivalent short-term corrosion resistance (P&SF, 2003a). Also, trivalent chromium coatings are often deposited over nickel layers. The subsequent coating is said to exhibit corrosion resistance comparable

² Throwing power is the ability to deposit chromium into the intricate recesses of a particular part.

to hexavalent chromium when using ASTM B117 salt spray test or the CASS test [1] (AF, 2000). However, some industry representatives still believe the trivalent plated deposit is “too soft” (Lucas, 2006) and will scratch easily. For the end user corrosion resistance is reduced and there is no “self healing” benefit (AF, 2001.)

Cost is another factor to consider when switching from hexavalent to trivalent chromium. Most of the equipment used for hexavalent chromium plating can be re-used when converting to trivalent chromium. A new synthetic tank lining, graphite anodes, and titanium or teflon spaghetti coils should be added for heating and cooling.

One major manufacturer estimated the costs associated with converting to trivalent chromium plating. The costs are shown below in Table VI-3.

Table VI-3. Cost Estimate for Conversion to Trivalent Chromium

Operating Cost:	Cost	Cost for 800 Gallon Tank
Operating cost (1,000,000 amp-hr)	\$0.023/amp-hr	\$23,000
Equipment/Chemicals:		
Bath make-up	\$11/gallon	\$8,800
Graphite anode cost	\$2.50/gallon	\$2,000
Ion exchange system	\$6,000 to \$10,000	\$10,000
Filter (for carbon)	\$5,000 to \$10,000	\$10,000
Air lines	\$500	\$500
Heating/cooling coil (titanium)	\$2,000	\$2,000
Amp-hour meter/feeder	\$1,200	\$1,200
Tank Liner	\$2,000 to \$5,000	\$5,000
Conversion to flowing rinse from Hexavalent pre-dip	\$2,000	\$2,000
Additional Rinse Tanks	varies	varies
Subtotal		\$41,500
Hazardous Waste Disposal: **		
Chromic Acid Disposal	\$4.35/gallon	\$3,480
	Total	\$67,980

Source: Atotech

**Cost estimate from Filter Recycling Services

Table VI-3 provides an estimate of the initial costs to convert from the hexavalent chromium process to the trivalent chromium process for a decorative plating facility with an 800 gallon plating tank and operating 1,000,000 ampere-hours per year. Of course, conversion costs would vary depending on an individual operation. A facility converting would have one-time equipment and chemical cost of about \$41,500 and a chromic acid disposal cost (in this example, about \$3,500). A facility would also have recurring operating costs of \$23,000 plus additional chemical costs which would vary depending on the operation. A facility may have to install additional rinse tanks. This could lead to additional costs to accommodate this tank(s) within an existing plating line (Atotech,

2006). These costs should only be viewed as an example. An individual facility's conversion costs will also vary based on type of parts plated (substrate and configuration), ambient temperatures, bath loading, and racking.

Staff has evaluated information from manufacturers of the trivalent chromium process, relevant literature, information from facility operators currently using the trivalent chromium process, and operators that feel they are unable to use the trivalent chromium process. We believe that the trivalent chromium process holds promise for the future. However, at this time, the trivalent chromium process is not feasible to replace all hexavalent decorative chromium plating applications.

2. Trivalent Chromium for Hard Chrome Plating

Trivalent chromium baths have not been used for hard chromium plating. There is difficulty in plating thick chromium coatings with the appropriate properties. Hard chromium coatings are typically 1.3 to 760 μm and provide functional properties such as hardness, corrosion resistance, wear resistance, and low coefficient of friction. Example applications include strut and shock absorber rods, hydraulic cylinders, crankshafts, and industrial rolls.

There has been some recent research funded by the U.S. EPA on developing a process for hard trivalent chromium plating. The project is ongoing and a company is working on a trivalent chromium process for hard chromium plating (P&SF, 2003). This process is not commercially available.

3. Other Alternatives

A number of other alternative processes exist for some chromium plating and chromic acid anodizing applications. Some of the alternative processes include:

- Type II Sulfuric Acid Anodizing – often referred to as “regular,” “architectural,” or “sulfuric” anodizing. Sulfuric anodize is formed by using an electrolytic solution of sulfuric acid at room temperature. The process produces a fairly clear coating and is normally used for decorative purposes and provides some corrosion protection (IHC, 2006).
- Electroless Nickel Phosphorous – an auto-catalytic process that deposits a layer of nickel alloyed with the reducing agent, phosphorous. The deposit thickness is uniform and free of edge buildup because no current is used. Deposits are generally semi-bright. The properties include excellent wear, good corrosion resistance in many environmental, good lubricity, and improved hardness on many substrates (PMPC, 2006).
- Nickel-Tungsten Electroplating – an electrodeposited alloy of nickel and tungsten. The plated deposit exhibits physical and chemical properties similar to chromium and electroless nickel. The process is simple to control and can be operated in

equipment similar to that used for hard chromium plating. A bright or dull finish is produced depending on the substrate (Enthone, 2006).

- Tin-Cobalt Alloy or Tin-Nickel Alloy – Tin-Cobalt alloy is usually plated over bright nickel and provides a finish with the appearance of chromium. It is durable and wear resistant (Seachrome, 2006). Tin-Nickel deposits can be used as an etch resist. It's most common use is a replacement for hexavalent chromium in decorative applications (RPC, 2006).

REFERENCES

AF, 2000. Automotive Finishing. BA Graves. Alternatives to Hexavalent Chromium and Chromium Plating. Winter 2000:

AF, 2001. Automotive Finishing. PC Wynn, CV Bishop. Replacing Hexavalent Chromium Plating. Spring, 2001:

ARB, 1997a. Air Resources Board. "Senate Bill (SB) 1731 Risk Reduction Audits and Plans Guidelines for Chrome Electroplating Facilities". 1997

Atotech, 2006. Paul Cartwright. Email to ARB staff regarding cost comparisons between trivalent and hexavalent chromium electroplating systems. 2006.

Bayer ®. Product information Bayowet® FT 248 and FT 248R

CDPHE, 1999. Colorado Department of Public Health and Environment. Chromium Maximum Achievable Control Technology (MACT) guidance. Updated April 21, 1999. (<http://www.cdphe.state.co.us/ap/chromium/html/index.html>)

Enthone, 2006. Cookson Electronics: Enthone. ENLOY® Ni-500. 2006. (<http://www.enthone.com/functional/index.aspx?Detail=../uc/enloy-ni-500.ascx>)

Hensley, 1997. JE Hensley and D York. "Report on Observed Differences in Dynes/Centimeter Readings of Various Chromium MACT Method 306B Surface Tension Measuring Devices". presented at the 18th AESF/EPA Pollution Prevention & Control Conference. 1997.

HHS, 2000. U.S. Department of Health and Human Services. "Primary Containment for Biohazards: Selection, Installation and Use of Biological Safety Cabinets". 2000

IHC, 2006. IHC, Inc. Sulfuric Anodizing. 2006. (http://www.ihccorp.com/IHC-Sulf_Anod.htm)

Jones, 2006. Jones, A.R., Email Communication dated April 17, 2006.

JPCB, 1999. Journal of Physical Chemistry B. K Wang, G Karlsson and M Almgren. Aggregation Behavior of Cationic Fluorosurfactants in Water and Salt Solutions. A CryoTEM Survey. 103, 9237-9246. 1999

Kissa E, 1994. "Fluorinated Surfactants". Chapter 4, Marcel Dekker, Inc. 1994

Leehy, 2006. Air Resources Board staff telephone conversation with David Leehey, Grover Products. 2006.

Lucas, 2006. Ray Lucas. Email to ARB staff regarding feasibility of trivalent as an alternative to hexavalent chromium plating. 2006

MacDermid, 2006. Air Resources Board staff telephone conversation with Ken Kraemer of MacDermid. 2006

Mikhael, 2006. Air Resources Board staff telephone conversation with Fiyador Mikhael, Bronzeway Plating. 2006

P&SF, 2000. Plating and Surface Finishing. TD Ferguson, M Zellen, D Brennan and J Lutz. Use of Fume Suppressants in Hard Chromium Baths—Quality Testing. February 2000:67-72.

P&SF, 2003a. Plating & Surface Finishing. DL Snyder. Distinguishing Trivalent Chromium Deposits by Color. November 2003:34-39

P&SF, 2003b. Plating and Surface Finishing. RP Renz, JJ Fortman, EJ Taylor and ME Inman. Electrically Mediated Process for Functional Trivalent Chromium to Replace Hexavalent Chromium: Scale-up for Manufacturing Insertion. June 2003:52-58

PMPC, 2006. Precious Metals Plating Company, Inc. Electroless Nickel. 2006. (<http://www.pmplating.com/electroless%20nickel.htm>)

RPC, 2006. Reliable Plating Corporation. Tin/Nickel Plating. 2006. (<http://www.reliableplating.com/tinnickel.html>)

Seachrome, 2006. Seaboard Metal Finishing. Seachrome. 2006. (<http://www.seaboardmetalfin.com/schrome.htm>)

U.S. EPA, 1993. U.S. Environmental Protection Agency. EPA/453/R-93-030a: “Chromium Emissions from Chromium Electroplating and Chromic Acid Anodizing Operations - Background Information for Proposed Standards”. 1993.

U.S. EPA, 1998. U.S. Environmental Protection Agency. EPA/625/R-98/002: “Capsule Report Hard Chrome Fume Suppressants and Control Technologies”. 1998.

U.S. EPA, 2002. U.S. Environmental Protection Agency. “National Emission Standards for Chromium Emissions From Hard and Decorative Chromium Electroplating and Chromium Anodizing Tanks”. 2002.

U.S. EPA, 2004. U.S. Environmental Protection Agency. 40 CFR Part 63: “National Emission Standards for Chromium Emissions From Hard and Decorative Chromium Electroplating and Chromium Anodizing Tanks”. 2004.

U.S. EPA, 2006. U.S. Environmental Protection Agency. 40 CFR Part 721: “Perfluoroalkyl Sulfonates; Proposed Significant New Use Rule.” 2006.

VII. Health Risk Assessment

This Chapter presents an overview of the health risk assessment (HRA) process that forms the basis for the proposed amendments to the Chromium Plating ATCM. The air quality modeling necessary to conduct the HRA is also summarized. Current cancer and non-cancer health impacts from exposure to hexavalent chromium from chromium plating and chromic acid anodizing operations is also included.

A. Overview

A health risk assessment (HRA) is an evaluation or report that a risk assessor (e.g., ARB, district, consultant, or facility operator) develops to describe the potential a person or population may have of developing adverse health effects from exposure to a facility's emissions. Some health effects that are evaluated include cancer, developmental effects, and respiratory illness. For hexavalent chromium, we evaluated the cancer and non-cancer health impacts and found that the cancer health impacts were far more significant than any non-cancer impacts. Therefore, the following sections focus on the cancer risk assessment. Section E contains a discussion of non-cancer health impacts.

Exposure to TACs can occur through pathways that include inhalation, skin exposure, and the ingestion of soil, water, crops, fish, meat, milk, and eggs. OEHHA has determined that hexavalent chromium is carcinogenic by the inhalation route only (OEHHA, 2003) and does not recommend using a multipathway methodology. The methods used in this risk assessment are consistent with the Tier 1 analysis described in the OEHHA Air Toxics "Hot Spots" Program Risk Assessment Guidelines, the Air Toxics Hot Spots Program Guidance Manual for Preparation of Health Risk Assessments (OEHHA, 2003).

B. Health Risk Assessment Process

The following sections describe the steps in the HRA process and the resulting health risk estimates for chromium plating and chromic acid anodizing facilities .

1. Hazard Identification

Step one for the risk assessor is to determine whether a hazard exists. If so, the assessor identifies the pollutant(s) and the type of effect, such as cancer or respiratory effects. In this case, we have determined that hexavalent chromium is emitted from chromium plating and chromic acid anodizing facilities. In 1986, the Board formally identified hexavalent chromium as a TAC.

The Board determined that hexavalent chromium exposure causes cancer and there was no safe level of exposure where adverse health effects would not occur. When the Board identified hexavalent chromium as a TAC, a unit risk factor of $1.5 \times 10^{-1} \mu\text{g}/\text{m}^3$ was established in support of the identification. This means that a lifetime exposure to

one $\mu\text{g}/\text{m}^3$ of hexavalent chromium would increase an exposed person's chance of developing cancer by about 15 percent. Exposure to hexavalent chromium is known to cause lung and nasal cancers, respiratory irritation, severe nasal and skin ulcerations and lesions, perforation in the nasal septum, liver and kidney failure and birth defects (ARB, 1985). Hexavalent chromium is also classified as a human carcinogen by the International Agency for Research on Cancer (IARC, 1997).

2. Dose-Response Assessment

The second step of risk assessment is for the risk assessor to characterize the relationship between a person's exposure to a pollutant and the incidence or occurrence of an adverse health effect. This step of the HRA is performed by OEHHA. OEHHA supplies these dose-response relationships in the form of cancer potency factors (CPF) and reference exposure levels (RELs.) A CPF is used when estimating potential cancer risks and RELs are used to assess potential non-cancer health impacts (OEHHA, 1999; OEHHA, 2002; OEHHA, 2003).

Cancer potency factors are the upper bound probability of developing cancer, assuming continuous lifetime exposure to a substance at a dose of one milligram per kilogram of body weight. To compare the potency of hexavalent chromium with other carcinogens, Table VII-1 lists cancer potency factors for various TACs.

Table VII-1. Inhalation Cancer Potency Factors for Common Carcinogens and Their Relative Potency to Hexavalent Chromium

Compound (in descending order)	Cancer Potency Factor ($\text{mg}/\text{kg}\text{-day}$) ⁻¹	Relative Potency to Hexavalent Chromium
Dioxin	$1.3 \times 10^{+5}$	250
Hexavalent Chromium	$5.1 \times 10^{+2}$	1
Cadmium	$1.5 \times 10^{+1}$.029
Arsenic (inorganic)	$1.2 \times 10^{+1}$.024
Diesel Exhaust	1.1×10	.0022
Nickel	9.1×10^{-1}	.0018
Benzene	1.0×10^{-1}	.0002
Ethylene Dichloride	7.2×10^{-2}	.00014
Lead	4.2×10^{-2}	.000082
Formaldehyde	2.1×10^{-2}	.000041
Perchloroethylene	2.1×10^{-2}	.000041
Chloroform	1.9×10^{-2}	.000037
Acetaldehyde	1.0×10^{-2}	.000020
Trichloroethylene	7.0×10^{-3}	.000014
Methylene Chloride	3.5×10^{-2}	.000069

(OEHHA, 2003)

As shown in Table VII-1, only one other chemical, dioxin, has a higher potential to cause cancer than does hexavalent chromium.

An REL is used as an indicator of potential non-cancer adverse health effects, and is defined as a concentration level at or below which no adverse health effects are expected. RELs are designed to protect the most sensitive persons in the population by including safety factors in their development, and can be created for both acute and chronic exposures. An acute exposure is defined as one or a series of short-term exposures generally lasting less than 24 hours. Chronic exposure is defined as long-term exposure usually lasting from one year to a lifetime. Table VII-2 contains non-cancer RELs and toxicological endpoints for hexavalent chromium.

Table VII-2. Hexavalent Chromium Health Effects Values Used in Non-Cancer Health Risk Assessment

	Non-Cancer Reference Exposure Levels (RELs)	Toxicological Endpoints
Chronic – Inhalation	0.20 (µg/m ³)	Respiratory system
Chronic – Oral	0.02 (mg/kg-day)	Hematologic

*OEHHA 2003

As shown in Table VII-2, only non-cancer chronic RELs have been determined for hexavalent chromium. There is no non-cancer acute REL. Non-cancer impacts linked to hexavalent chromium exposure include respiratory irritation, severe nasal and skin ulcerations and lesions, perforation in the nasal septum, liver and kidney failure and birth defects (ARB, 1985).

3. Exposure Assessment

In an exposure assessment, step 3, the risk assessor estimates the extent of public exposure by determining people who will likely to be exposed, how exposure will occur (e.g., inhalation and ingestion), and the magnitude of exposure. For chromium plating and chromic acid anodizing facilities, the receptors (people) that are likely to be exposed are residents and off-site workers located near the facility. For this assessment, we focused on residential and off-site worker exposures.

Although on-site workers could be impacted by the emissions, they are not the focus of this HRA because the OSHA has jurisdiction over on-site workers. To protect worker safety, OSHA has established a PEL for hexavalent chromium of 5 µg/m³. The PEL is the maximum, eight hour, time-weighted average concentration for occupational exposure. Because the proposed amendments to the ATCM will require the installation of ventilation systems and add-on air pollution control devices for many additional chromium plating and chromic acid anodizing facilities, on site-worker exposure to hexavalent chromium at the affected facilities would be reduced as well.

Hexavalent chromium is considered to be carcinogenic only when exposure occurs by the inhalation route (OEHHA, 2003.) Therefore, residential and off-site worker locations were evaluated via the inhalation pathway only.

One of the most reliable and cost-effective tools used by ARB staff to evaluate public exposures to a pollutant is to conduct air dispersion modeling simulations. The following sections summarize the air dispersion modeling conducted to evaluate the health impacts from exposure to hexavalent chromium. Further detail on the modeling simulations and the input parameters is contained in Appendix H of this report.

a. Air Dispersion Modeling

To assess the magnitude of exposure, ARB staff used a computerized air dispersion model to estimate downwind ground-level concentrations of hexavalent chromium at near source locations after it is emitted from a chromium plating or chromic acid anodizing facility. The downwind concentration is a function of the quantity of emissions, release parameters at the source, and appropriate meteorological conditions. ARB used the U.S. EPA's Industrial Source Complex Short Term (Version 02035) air dispersion model (ISCST3 model). The ISCST3 model estimates concentrations at specific locations around each facility, directly caused by each facility's emissions. The modeling inputs used are summarized below.

b. Emission Estimates

Modeled concentrations are based on unit emission rates and can be adjusted to reflect any emission rate scenario. Therefore, emissions of hexavalent chromium from chromium plating and chromic acid anodizing facilities for this modeling analysis were based on an unit emission rate of one gram per second. The mass emission estimates in the model are then scaled down to reflect emissions from each chromium plating and chromic acid anodizing facility. Thus, the modeling simulation does not "grow" an individual facility's emissions. By scaling the modeled concentrations we are able to determine how each facility's emissions are dispersed into ambient air and the resulting concentrations at various distances from the facility. For this analysis staff assumed an operating schedule of 9 hours per day, 7 days per week, 52 weeks per year.

c. Meteorological Data

Four sets of meteorological data representing various locations in California were used for this HRA. The data selected are representative of where the majority of chromium plating and chromic acid anodizing facilities are located. The four locations, and the years the meteorological data represented are Los Angeles area – Pasadena (1981), San Francisco Bay area – Oakland (1960-64), San Diego area –Inland (1967-71), Central Valley – Fresno (1985-89).

d. Physical Description of the Source and Emission Release Parameters

Six generic chromium plating and chromic acid anodizing facilities were modeled. These generic facilities were created from survey information, source test reports, and information obtained during site visits from ARB or district staff. Therefore, they are representative of the facilities in California. The modeling simulation predicted airborne

concentrations of hexavalent chromium for potential receptor distances that ranged from 20 to 1,000 meters (66 – 3,280 feet) from the chromium plating and chromic acid anodizing facilities. The assumptions used for modeling emissions from generic facilities are shown in Table VII-3 and Table VII-4.

Table VII-3. Key Parameters for Air Dispersion Modeling and Health Risk Assessment

Air Dispersion Model:	U.S. EPA, Industrial Source Complex Short Term (ISCST3), Version 02035
Source Type:	Volume and Point
Dispersion Setting:	Urban
Receptor Height:	1.2 meters
Meteorological Data:	Los Angeles area - Pasadena San Francisco Bay area - Oakland San Diego area - Miramar Naval Air Station Central Valley - Fresno
Receptor's Hypothetical Exposure Time:	70 years, 365 days/year
Adult Daily Breathing Rates:	393 liters/kg body weight-day (high-end) 302 liters/kg body weight-day (80th percentile) 271 liters/kg body weight-day (mean)
Adult Body Weight:	70 kg
Cancer Inhalation Potency Factors:	Hexavalent Chromium – 510 (mg/kg-day) ⁻¹
Non-Cancer Acute RELs – Inhalation:	Hexavalent Chromium – not established
Non-Cancer Chronic RELs – Inhalation:	Hexavalent Chromium – 0.20 ug/m ³
Non-Cancer Chronic RELs - Oral:	Hexavalent Chromium – 0.02 mg/kg-day

Table VII-4. Generic Facility Parameters for Air Dispersion Modeling and Health Risk Assessment

Stack Information (Point Sources):	
Stack Diameters	0.32, 0.66, and 0.92 meters
Stack Heights	9.1, 9.1, and 12.8 meters
Stack Temperatures	24 degrees Celsius
Stack Exhaust Velocities	10.4, 12.2, and 8.5 meters/second
Volume Source Parameters:	
Release Height	2.5 meters (ground level)
Lateral Dimension	2.3, 4.0, and 7.0 meters
Vertical Dimension	2.3 meters

Point sources are facilities that already use add-on air pollution control devices with forced ventilation systems to collect hexavalent chromium emissions. Exhaust air containing any uncollected hexavalent chromium is then vented through a stack. Table VII-4 shows the various stack parameters used in the modeling. Note that emissions are modeled from the stack, and the stack is assumed to be in the center of the building. A typical point source would be a hard chromium plating facility.

Volume sources are facilities that use only in-tank controls (*i.e.* chemical fume suppressants) to reduce hexavalent chromium emissions. Table VII-4 also shows the release parameters of the facilities that were used in the modeling. In this case, the source of emissions (the tank) is assumed to be in the center of the building and the emissions are modeled from that point. A typical volume source would be a decorative chromium plating facility.

e. Pollutant Specific Health Effects Values

Dose-response or pollutant-specific health values are developed to characterize the relationship between a person’s exposure to a pollutant and the incidence or occurrence of an adverse health effect. A CPF is used when estimating potential cancer risks and a REL is used to assess potential non-cancer health impacts. For ease of the reader, the current OEHHA-adopted health effects values for hexavalent chromium are repeated in Table VII-3. Note that the cancer inhalation potency factor is 510 (milligrams/kilogram-day)⁻¹.

Through computerized modeling simulations and using the inputs listed in Tables VII-3 and VII-4, ARB staff can estimate how concentrations of hexavalent chromium are dispersed and diluted into ambient air. These data are then used to determine health impacts from chromium plating and chromic acid anodizing facilities.

Figure VII-1 depicts how concentrations of hexavalent chromium are reduced as they are dispersed from the facility. The meteorological data used are from Pasadena.

Figure VII-1. Percent of Maximum Predicted Concentration of Hexavalent Chromium at Increasing Distances from the Source *

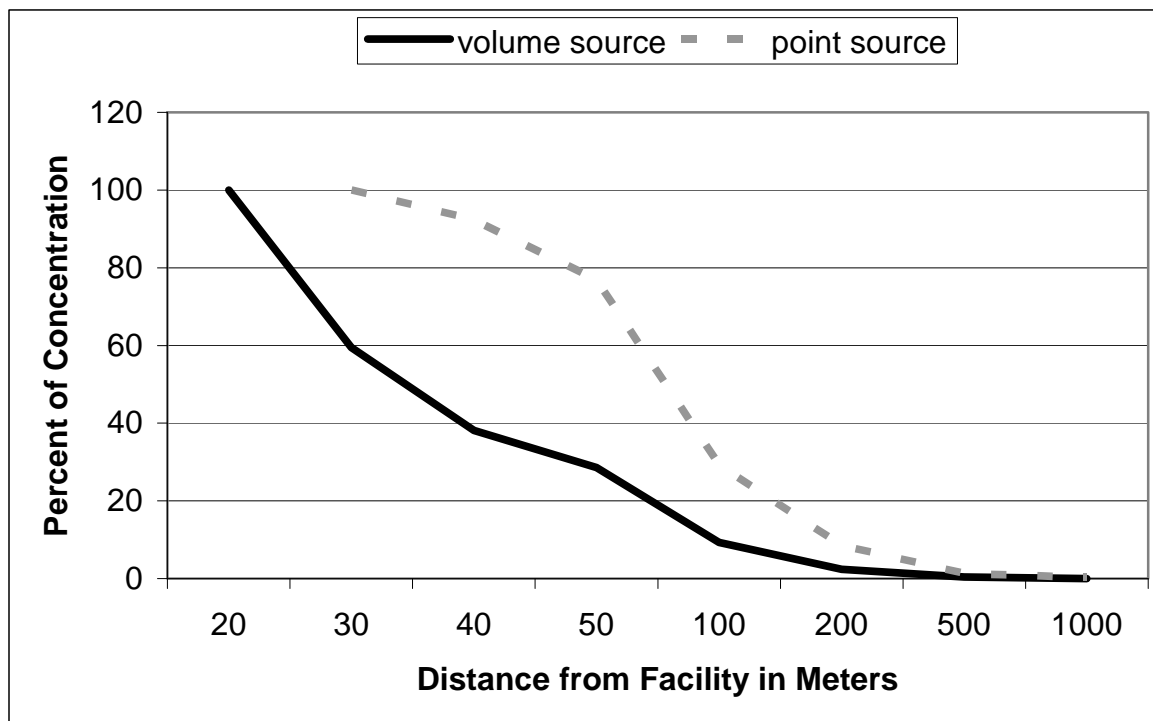

* Concentrations using Pasadena meteorological data set and small facility.

Figure VII-1 shows that concentrations of hexavalent chromium decrease rapidly as they are dispersed from a facility. For volume sources (facilities without add-on air pollution control devices), at 100 meters the concentration is reduced to 9 percent of the concentration at 20 meters. For point sources (facilities with add-on air pollution control devices), at 100 meters the concentration is reduced to about 30 percent of the concentration at 30 meters. Note also that at 150 meters the concentration from the point source has been reduced to about 20 percent of the initial concentration.

Because of the model's resolution, for volume sources a receptor is placed at 20 meters from the edge of the building. This is assumed to be the point of highest concentration, or as depicted in Figure VII-1, 100 percent. While it is true that the concentration of hexavalent chromium would be higher at ten meters from the edge of the building, the model has not been validated to provide an accurate concentration at a distance less than 20 meters. For the modeled emissions from a small point source, the maximum concentration of hexavalent chromium is 30 meters from the edge of the building. This distance is the point of highest concentration, or 100 percent. Although not shown, a larger point source with a higher stack would have the highest concentration of hexavalent chromium at a distance of 50 meters from the source.

These data indicate that emissions from chromium plating and chromic acid anodizing facilities are localized and cancer risk is highest for near-source receptors.

4. Risk Characterization

To characterize the health risk, the risk assessor combines information derived from the previous steps. Modeled pollutant concentrations from the exposure assessment are combined with the CPFs (for cancer risk) and RELs (for non cancer effects) derived from the dose-response assessment. Risk characterization integrates this information to quantify the potential cancer risk and non-cancer health effects.

For our assessment, Table VII-5 displays the parameters used to calculate both cancer and non-cancer health impacts.

Table VII-5. Key Parameters for Assessing Estimated Cancer and Non-Cancer Health Impacts for Chromium Plating and Chromic Acid Anodizing Facilities

	Point Source	Volume Source
Exposure	Residential	Residential
Breathing Rate	80 th percentile (302 l/kg)	80 th percentile (302 l/kg)
Meteorological data set	Pasadena	Pasadena
Operating Schedule	9 hrs/day, 7 days/week	9 hrs/day, 7 days/week
Facility Size	Small ($\leq 5,000,000$ ampere/hrs) Medium ($> 5,000,000$ $\leq 50,000,000$ ampere/hrs) Large ($> 50,000,000$ ampere/hrs)	Small (3,000 ft ²)
Maximum Individual Cancer Risk (MICR) Distance	30 meters for small, 40 meter for medium, 50 meters for large	20 meters
Release Height	9.1 meters (stack height) for small and medium 12.8 meters for large	2.5 meters (ground level)

Baseline emissions (2005) of hexavalent chromium for assessing cancer and non-cancer impacts from each facility were calculated by multiplying reported throughput (in ampere-hours) by the facility's emission rate. For volume source facilities in the SCAQMD, we used the emission rate for their certified chemical fume suppressants of 0.01 milligrams/ampere-hour. All other volume sources in the State were assigned a chemical fume suppressant emission rate of 0.04 milligrams/ampere-hour. This is consistent with results from our emissions testing program. For point sources, when source test data were available, the reported emission rate was used. For other point source facilities, emission rates were assigned based on regulatory requirements.

Based on these assumptions, statewide baseline hexavalent chromium emissions for 2005 were estimated to be four pounds per year.

C. **Factors that Affect Health Risk Assessments**

The results of an HRA include an evaluation of potential adverse health impacts from exposure to a TAC. It is a complex process that requires the analysis of many variables to simulate real-world situations. For our purposes, we conducted health risk assessment

analyses in a manner which is very health protective in estimating cancer risks for a range of reasonably foreseeable exposure scenarios. A recent study, funded by ARB, indicted that the model employed in this analysis may actually under-predict near-source concentrations (UCR, 2003). Staff believe this health protective approach is necessary due to the very high potency and resultant serious health hazards associated with exposure to hexavalent chromium emissions. There are a variety of factors that can affect the results of the HRA for chromium plating and chromic acid anodizing facilities. These include:

- Toxicity of hexavalent chromium;
- Emission rate of hexavalent chromium from the facility in milligrams/ampere-hour;
- Source release characteristics (e.g., height of stack, stack configuration, flow rate, and building dimensions);
- Facility operating schedule (duration of exposure);
- Local meteorological conditions;
- Distance to the receptor;
- Duration of exposure; and
- Inhalation rate of the receptor.

A combination of these factors will determine the potential health impacts. Due to the variability of these factors, the potential health impacts can also vary. For example, if the inhalation rate of the receptor were to increase (we have assumed the 80th percentile breathing rate), and all other factors were held constant, the resulting potential health impacts would also increase. The estimated cancer risks presented are representative of the maximum individual cancer risk (MICR). This implies calculation of a cancer risk where the concentration of hexavalent chromium is at its maximum upon being emitted from a facility. There may or may not be a receptor at this location.

D. Cancer Risk Assessment

While the 4.0 pounds (1,800 grams) per year of emissions seems low, even a very small amount of hexavalent chromium can result in a substantial cancer risk. For example, staff found that as little as two grams of annual emissions would yield an estimated cancer risk of ten per million people exposed. As shown in Table VII-6, the maximum individual cancer risk (MICR) was determined for each chromium plating and chromic acid anodizing facility in California based on these 4.0 pounds of emissions. It should be noted that the MICR is calculated using the highest concentration of hexavalent chromium downwind of a facility that is predicted by an air quality model. People may not be living at the MICR point. Table VII-6 reflects implementation of the current ATCM and air district rules, including Rule 1469 for facilities in the South Coast Air Basin.

Table VII-6. Sixty-three Facilities have Estimated Cancer Risk of Over 10 per Million Exposed People (2005 Baseline)

Number of Facilities by Cancer Risk				
	≤1 per million	>1 ≤10 per million	>10 ≤100 per million	>100 per million
Baseline 2005	90	67	57	6

As shown in Table VII-6, 90 facilities (about 41 percent) have estimated cancer risk less than one per million exposed people. However, Table VII-6 also shows that 57 facilities (about 26 percent) have an estimated cancer risk of over ten per million exposed people. Six facilities (about 3 percent) may have an estimated cancer risk of over 100 per million people exposed.

Implementation of Rule 1469 in the South Coast Air Basin provided an improvement in cancer risk reduction for facilities located there. In 2003, we estimate that 30 percent of facilities had estimated cancer risk of less than one per million exposed people. Overall, about 55 percent of facilities had estimated cancer risks below ten per million exposed people. Eleven percent of facilities had estimated cancer risk of over 100 per million people exposed. These data are not shown graphically.

Based on these results staff has determined that while Rule 1469 reductions provided risk reduction benefits in the SCAQMD it had no impact in reducing cancer risk in other areas of the State. We also believe Rule 1469 did not achieve the maximum reduction feasible because BACT was not required for all facilities. The staff's proposal to reduce the cancer risk from chromium plating and chromic acid anodizing facilities is described in Chapter VIII.

E. Non-Cancer Risk Assessment

Non-cancer impacts linked to hexavalent chromium exposure include respiratory irritation, severe nasal and skin ulcerations and lesions, perforation in the nasal septum, liver and kidney failure, and birth defects (ARB, 1985). We performed a non-cancer risk assessment to evaluate potential non-cancer health impacts based on 2005 emissions. This year reflects implementation of Rule 1469 in the South Coast Air Basin. The assessment included potential impacts from long-term (chronic) exposures. Potential chronic and acute health impacts are expressed in terms of a hazard quotient (for a single substance.) Typically, a hazard quotient or hazard index that is greater than 1.0 is considered to be unacceptable. The parameters that were used to model emissions and estimate cancer risk are contained in Tables VII-3, VII-4, and VII-5.

The analysis indicated that no facility's hazard index exceeded 1.0 for either worker or residential exposure scenarios. In fact, no facility's hazard index exceeded 0.01. Therefore, staff has concluded that no additional measures would be necessary to reduce potential chronic non-cancer impacts related to long-term exposure to hexavalent chromium from chromium plating and chromic acid anodizing facilities.

We also analyzed the throughput threshold, in ampere-hours, that could result in a hazard index of 1.0. If we evaluate the hazard index for a generic facility and assume ampere-hours of 100,000,000 (higher than any facility's throughput in the State) and use the assumed emission rate of 0.0015 milligrams/ampere-hour (HEPA level of control), ampere-hours would have to increase 100-fold to reach a hazard index of 1.0.

REFERENCES

ARB, 1985. Air Resources Board. “Staff Report: Initial Statement of Reasons for Proposed Rulemaking – Identification of Hexavalent Chromium as a Toxic Air Contaminant”. 1985.

IARC, 1997. World Health Organization – International Agency for Research on Cancer. Volume 49: “Chromium, Nickel and Welding, Summary of Data Reported and Evaluation”. 1997.

OEHHA, 1999. Office of Environmental Health Hazard Assessment. “Air Toxics Hot Spots Program Risk Assessment Guidelines, Part I, The Determination of Acute Reference Exposure Levels for Airborne Toxicants”. 1999.

OEHHA, 2002. Office of Environmental Health Hazard Assessment. “Air Toxics Hot Spots Program Risk Assessment Guidelines, Part II, Technical Support Document for Describing Available Cancer Potency Factors”. 2002.

OEHHA, 2003. Office of Environmental Health Hazard Assessment. “Air Toxics Hot Spots Program Risk Assessment Guidelines, The Air Toxics Hot Spots Program Guidance Manual for Preparation of Health Risk Assessments”. 2003.

UCR, 2003. Department of Mechanical Engineering, University of California, Riverside. “Draft Final Report: Validation of Concentrations Estimated from Air Dispersion Modeling for Source-Receptor Distances of less than 100 Meters”. 2003.

VIII. Proposed Risk Reduction Approach and Benefits

Despite significant reductions in hexavalent chromium emissions, the cancer risks for some chromium plating and chromic acid anodizing facilities is still unacceptably high. This is largely due to the potent carcinogenicity of hexavalent chromium. As little as two grams of annual emissions can elevate the estimated cancer risk to ten per million exposed people. The location of many of the facilities also indicates that some low income and ethnically diverse communities in the State are disproportionately impacted by the emissions. This is of special concern given that 43 percent of facilities are located within 100 meters of people. These factors compel staff to evaluate emission reduction scenarios that minimize or eliminate the cancer risks.

As described in Chapter VI, staff has evaluated various alternative processes for hexavalent chromium plating and chromic acid anodizing to determine if cancer risk could be eliminated. While alternatives exist for some applications, their use is limited. Thus, we conclude that alternative technologies are not available to require a phase-out of the hexavalent chromium process at this time. However, our analysis also shows that effective emission reduction alternatives are readily available and these approaches minimize the cancer risk to the extent technology allows.

A. Best Available Control Technology

Staff has evaluated BACT for chromium plating and chromic acid anodizing facilities. We also have evaluated the effectiveness of chemical fume suppressants through our emissions testing program. We have determined that add-on air pollution control devices with the final capture device being high efficiency particulate arrestor (HEPA) filters represents BACT for larger facilities, while use of chemical fume suppressants represents BACT for very small facilities. As described in Chapter VI, HEPA filters are rated at 99.97 percent efficient for collecting particles of 0.3 micrometers in diameter. Use of BACT for larger facilities would reduce hexavalent chromium emissions to no more than 0.0015 milligrams/ampere-hour. There is ample evidence to demonstrate that this is an effective method to reduce cancer risk. HEPA filter technology is already used in over 30 percent of the facilities to reduce hexavalent chromium emissions. In fact, we are aware that facilities currently using various combinations of controls, including HEPA filters, have emission rates lower than 0.0015 milligrams/ampere-hour.

By establishing this level of control, staff has found that emissions, and therefore cancer risk, can be minimized. This level of control is 85 percent more effective than the emission reductions achieved through use of chemical fume suppressants that have been shown to reduce emissions to no more than 0.01 milligrams/ampere-hour. Figure VIII-1 shows graphically the effectiveness of HEPA filters compared to chemical fume suppressants.

Figure VIII-1. Comparison of Cancer Risks (MICR) Remaining After Application of Controls at Various Throughputs *

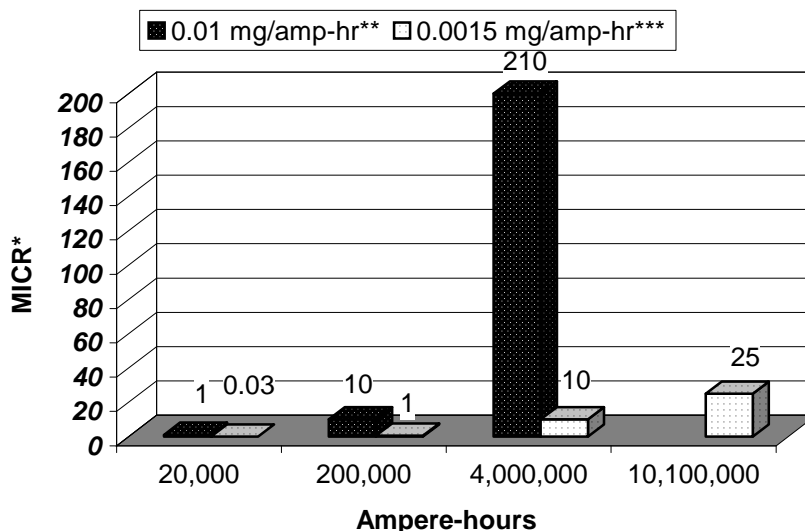

- * Results are for the inhalation pathway and calculated for a residential receptor with a 70-year exposure duration, 80th percentile daily breathing rate and Pasadena meteorological data set
- ** Emission rate of a chemical fume suppressant (emission rate 0.01 mg/amp-hr) modeled using a small volume source
- *** Emission rate of a HEPA filtering system, (emission rate of 0.0015 mg/amp-hr) modeled using a small point source

Figure VIII-1 shows various throughputs and compares the estimated MICRs resulting if emissions are reduced using chemical fume suppressants and by using HEPA filters or equivalent controls. Note that a facility using a chemical fume suppressant with throughput of 20,000 ampere-hours per year would pose a cancer risk of no more than one per million exposed people. This is based on the maximum exposed individual, which for volume sources is at 20 meters. At this risk level, chemical fume suppressants represent BACT.

A facility using a chemical fume suppressant and operating 200,000 ampere-hours per year poses a cancer risk of ten per million exposed people. However, when BACT for intermediate and larger-sized facilities is used, estimated cancer risk is reduced to less than one per million exposed persons. HEPA filters or equivalent controls meeting the 0.0015 milligrams/ampere-hour limit represents BACT.

Figure VIII-1 also shows that a facility with throughput of 4.0 million ampere-hours would have an estimated cancer risk of 200 per million exposed persons if emissions were controlled with chemical fume suppressants alone. However, if BACT is used, cancer risk would be reduced to ten per million exposed people.

Finally, Figure VIII-1 shows that once a facility's throughput exceeds 10.0 million ampere-hours, even after application of BACT, estimated cancer risk is greater than 25 per million exposed persons. This indicates that other risk reduction measures may be necessary for some facilities.

B. Emissions and Cancer Risk Reduction Benefits

Staff is proposing to amend the Chromium Plating ATCM by phasing in BACT. The timing for the application of BACT would be related to throughput and proximity to sensitive receptors. BACT for very small facilities would be defined as use of chemical fume suppressants.

The proposed amendments to the Chromium Plating ATCM are found in Appendix A to this report and are described in plain English in Chapter IX. As described below, staff estimates that by adopting this proposal estimated cancer risk from hexavalent chromium emissions could be reduced by up to 85 percent.

Very low throughput (less than 20,000 ampere-hours per year) facilities would be allowed to reduce hexavalent chromium emissions through use of specified chemical fume suppressants to lower surface tension of the plating or anodizing bath. This has been determined to be BACT for these facilities. Using specified chemical fume suppressants to lower surface tension reduces hexavalent chromium emissions to 0.01 milligrams/ampere-hour. Remaining cancer risk for these facilities would be no more than one per million exposed people.

Application of BACT for all other facilities would require use of control technologies rated at 99.97 percent efficient for collecting particles of 0.3 micrometers in diameter. This is the control efficiency achieved through installation of a HEPA filter add-on air pollution control device. The emission limitation equivalent to this level of control would be 0.0015 milligrams/ampere-hour.

Intermediate-sized facilities (greater than 20,000 but less than 200,000 ampere-hours per year) would have five years to comply with the emission limitation if the facility is located more than 100 meters from a sensitive receptor. This would allow some small businesses more time to secure the necessary capital to purchase the needed equipment. To provide earlier protection for sensitive receptors, other intermediate-sized facilities located at or within 100 meters of a sensitive receptor would be required to meet the emission limitation in two years.

Industry representatives have indicated that combinations of in-tank controls such as chemical fume suppressants and polyballs may, in some cases, be able to reduce emissions to no more than 0.0015 milligrams/ampere-hour. Therefore, all intermediate-sized facilities would be given the option to demonstrate compliance with the emission limitation without installation of add-on air pollution control devices. This proposal could reduce compliance costs for some small businesses. However, performance testing would be required to demonstrate compliance. After full implementation, all intermediate-sized facilities would have remaining cancer risk of no more than two per million exposed people.

The largest facilities (more than 200,000 ampere-hours per year) would be required to comply with the emission limitation of 0.0015 milligrams/ampere-hour within two years using an add-on air pollution control device(s). Remaining cancer risk for these facilities would range from ten to no more than 61 per million exposed people. However, facilities with remaining cancer risk over 25 per million exposed people, would be required to conduct a refined assessment of their facility's risk to determine if further risk reduction measures would be necessary.

Table VIII-1 below shows how excess cancer risk would be reduced beyond the risk reduction achieved by implementation of the current ATCM and air district rules.

Table VIII-1. Adoption of Staff's Proposal Significantly Reduces the Estimated Cancer Risk from Hexavalent Chromium Emissions

Number of Facilities by Cancer Risk				
	≤1 per million	>1 ≤10 per million	>10 ≤100 per million	>100 per million
Staff Proposal	162	41	17	0
Baseline	90	67	57	6

As shown in Table VIII-1, by adopting the staff's proposal about 162 facilities (74 percent) would have remaining cancer risk of no more than one per million exposed persons. This represents an additional 72 facilities compared to the baseline. Only 17 facilities (about 8 percent) would have estimated cancer risk of over ten per million exposed people. No facilities would have cancer risk exceeding 100 per million exposed people. Under the staff's proposal each facility with residual cancer risk over 25 per million exposed people would need to do a site specific analysis to determine if further control measures are needed. Total hexavalent chromium emissions from all chromium plating and chromic acid anodizing facilities would decrease, by 55 percent, to 1.8 pounds per year.

Off-site worker cancer risks were also evaluated. Table VIII-2 shows the remaining cancer risk for exposed off-site workers if the staff's proposal were to be adopted.

Table VIII-2. Adoption of Staff's Proposal Significantly Reduces the Estimated Cancer Risk from Hexavalent Chromium Emissions for Off-Site Workers

Number of Facilities by Cancer Risk				
	≤1 per million	>1 ≤10 per million	>10 ≤100 per million	>100 per million
Staff Proposal	203	14	3	0
Baseline	113	70	36	1

In addition to reducing cancer risk for everyone living near hexavalent chromium and chromic acid anodizing facilities, as shown in Table VIII-2, the proposal would also provide health benefits for off-site workers. As shown, 92 percent or 203 facilities would have cancer risk of no more than one per million exposed off-site workers. This is an additional 90 facilities compared to the 2005 baseline.

These estimates of cancer risk remaining after implementation of the staff's proposal could be either higher or lower. Factors such as meteorology and release characteristics of a facility could change the outcome. Additionally, the cancer risk estimates are based on a fixed distance, and a facility may or may not have a receptor at that location. If a receptor were located less than 20 meters from a facility, their cancer risk could be higher. If a receptor were located more than 20 meters from a facility, their cancer risk could be lower. Twenty meters is the minimum air dispersion modeling distance used by the ARB in the Air Toxics Program.

C. Other Aspects of the Staff's Proposal

Another goal of the amendments is to ensure that new facilities are isolated from sensitive receptors. As discussed previously, we have learned that emissions of hexavalent chromium have the greatest impact on people living near chromium plating and chromic acid anodizing facilities. Our data show that 43 percent of the chromium plating and chromic acid anodizing facilities are located within 100 meters of a sensitive receptor. To prevent future situations such as this, staff is proposing that any new chromium plating or chromic acid anodizing facility not be allowed to operate in an area zoned residential or mixed use or within 150 meters of an area zoned residential or mixed use. At this distance, 150 meters, (~500 feet), modeling for point sources shows that the hexavalent chromium concentration has dropped off by about 80 percent.

Nevertheless, staff is also proposing that facilities would have to conduct a site specific health risk assessment to ensure that public exposure to emissions from the new source, will be below the air districts' levels of significance contained in health risk rules and policies. This proposal provides a margin of safety and accounts for situations where receptors may move in closer to a facility.

While they cannot be quantified because of variation from facility to facility, fugitive dust emissions also likely impact people residing near chromium plating and chromic acid anodizing facilities. Information on fugitive dust emissions is contained in Chapter V. Therefore, staff is proposing that all facilities would need to implement housekeeping measures to reduce dust emissions. We have found that fugitive emissions related to poor housekeeping can be an additional source of hexavalent chromium emissions.

Training explaining the Chromium Plating ATCM and the requirements, conducted by ARB staff, would be required every two years for employees responsible for compliance at chromium plating and chromic acid anodizing facilities. An exception to this requirement would be personnel that had attended the SCAQMD's training class for Rule 1469.

The proposal would also prohibit the sale or use of chromium plating or chromic acid anodizing materials unless sold or used by individuals or businesses under air district permit to conduct such operations.

All of these proposals, as well as the provisions necessary to implement them, are described further in Chapter IX.

IX. Proposed Amendments and Alternatives

Staff is proposing to amend the Chromium Plating ATCM (title 17, California Code of Regulations, section 93102). As described below, the amended ATCM will now be contained in sections 93102 through 93102.16. The amendments are being proposed to further reduce the public's exposure to emissions of hexavalent chromium. If adopted, the staff's proposal would reduce the estimated cancer risk by up to 85 percent. This Chapter is provided to describe, in "plain English," the changes being proposed. The rationale for the proposal is also described. The text of the proposed amendments to the ATCM can be found in Appendix A to this staff report. This Chapter also discusses alternative emission reduction approaches that were evaluated.

A. Summary of the Existing Airborne Toxic Control Measure

Chromium plating and chromic acid anodizing facilities have been regulated to control hexavalent chromium emissions since 1988 when the ATCM was first adopted. The regulation established different limits based on facility throughput and type of operation. Hard chromium plating and chromic acid anodizing facilities, except for small hard chromium plating facilities, were required to control hexavalent chromium emissions by meeting emission limitations using add-on air pollution control devices. The stringency of the limits depended on throughput, with the highest volume facilities meeting the most restrictive limit. Decorative chromium plating facilities, on the other hand, were required to control hexavalent chromium emissions, but to a lesser extent than hard chromium plating facilities. Most decorative chromium plating facilities chose to comply by using chemical fume suppressants.

The regulation was amended in 1998 to incorporate changes necessary for equivalency with the federal Chromium Plating NESHAP. This included changing the requirements for chromic acid anodizing facilities to harmonize them with the requirements for decorative chromium plating facilities, and requiring control of emissions from trivalent chromium plating facilities.

B. Summary of the Proposed Amendments

The staff is proposing a complete renumbering of the Chromium Plating ATCM. Rather than having alphabetized subsections to section 93102, staff is proposing to number sections consecutively in order to make the regulation easier to read. For example, previous subsection (a) would be renumbered to section 93102.1. This convention would be followed throughout the ATCM.

Section 93102 would set forth the organization of the regulation and clarify where requirements pertaining to a specific facility could be found. The reorganized ATCM would be contained in sections 93102 through 93102.16.

1. Section 93102.1--Applicability

Applicability requirements were previously contained in subsection (a). We are proposing a modification to the Applicability section. Originally the regulation's applicability was to "each chromium electroplating or chromic acid anodizing tank at a facility." Staff is proposing that the regulation applies to any owner or operator of a facility performing hard chromium electroplating, decorative chromium electroplating, or chromic acid anodizing. We are proposing this change to clarify that the requirements apply facility-wide. Ultimately, compliance responsibility is placed upon the owner or operator, therefore, this change would provide clarification.

Other changes are proposed to section 93102.1. We are also proposing to extend the applicability of the ATCM to manufacturers or distributors of chromium plating or chromic acid anodizing kits. This is necessary to implement other provisions of the proposal.

Staff is proposing a provision that would allow the ATCM to remain in effect if an individual part of the ATCM is found to be invalid. This severability provision is contained in many ARB regulations and is designed to insure that the control of hexavalent chromium emissions will continue even if a particular provision of the ATCM is held to be invalid by a court.

2. Section 93102.2--Exemptions

Exemptions were previously contained in subsection (a). We are not proposing any new exemptions within the ATCM. The proposal would move the existing exemptions to their own section. Generally, the exemptions exclude process tanks where chromium plating or chromic acid anodizing does not occur. The exemptions also clarify that the provisions for inspection and maintenance do not apply during breakdown conditions.

3. Section 93102.3--Definitions

Definitions were previously contained in subsection (b). Staff is proposing to modify a number of definitions, and is also proposing several new definitions necessary to implement other proposals in the regulation. The modified definitions are intended to further clarify the existing definitions. The proposed amended definitions are shown in Table IX-1 below.

Table IX-1. Definitions Proposed for Modification

Base metal	Modification
Chromic acid anodizing	Foam blanket
Chromium electroplating or chromic acid anodizing tank	Hard chromium electroplating or industrial chromium electroplating
Composite mesh-pad system	High Efficiency Particulate Arrestor (HEPA) filter
Decorative chromium electroplating	Mechanical fume suppressant
Emission limitation	Packed-bed scrubber
Facility	Stalagmometer
Fiber-bed mist eliminator	Tensiometer

One definition proposed for amendment, “Modification,” warrants a further explanation. The definition for “Modification” is intended to describe changes to a facility that would trigger additional requirements. Presently, a facility is not considered “Modified” if throughput increases, as long as the maximum design capacity of the equipment is not exceeded. One amendment proposed by staff would define a modification as a change in throughput that would cause a facility to be subject to a different emission limitation. We are also proposing that changes to a permit unit or addition of a permit unit that does not increase hexavalent chromium emissions would not be considered a modification. These changes are necessary to implement the emission limit requirements in section 93102.4.

Several new definitions are proposed to implement other proposals in the Chromium Plating ATCM. Other definitions are proposed to further clarify the ATCM. The proposed new definitions to be added are shown in Table IX-2.

Table IX-2. New Definitions Proposed for Addition

Annual Permitted Ampere-hour	Modified Facility
Dragout	New Facility
Enclosed storage area	Owner or Operator
Enclosed hexavalent chromium electroplating tank	Permitting Agency
Existing Facility	Person
Fugitive dust	Sensitive receptor
Initial start-up	Tank

Most of these proposed new definitions are necessary to implement housekeeping requirements and other measures designed to reduce emissions of hexavalent chromium laden fugitive dust. Other proposed definitions are designed to clarify what constitutes an existing, new or modified facility, and others define those responsible for compliance or oversight.

One new definition proposed, “Sensitive receptor,” warrants further explanation. A sensitive receptor is proposed to be defined as “any residence including private homes, condominiums, apartments, and living quarters; education resources such as preschools

and kindergarten through grade twelve (K-12) schools; daycare centers; and health care facilities such as hospitals or retirement and nursing homes. A sensitive receptor includes long term care hospitals, hospices, prisons, and dormitories or similar live-in housing.” This is the same definition used in the ATCM to Reduce Emissions of Hexavalent Chromium and Nickel from Thermal Spraying (title 17, CCR, section 93102.5), which was adopted by the Board in 2005. The definition is necessary to implement the proposed hexavalent chromium emission limit requirements in subsection 93102.4. As will be explained below, the requirements to control hexavalent chromium emissions will be phased in on different dates depending on a facility’s distance to a sensitive receptor. Data show that sensitive receptors located in close proximity to hexavalent chromium plating or chromic anodizing facilities are at greater risk of exposure to elevated levels of hexavalent chromium. Note that as proposed, a residence would be considered a sensitive receptor. This is because children, the elderly, and other health-compromised individuals are often located in residences.

4. Section 93102.4--Emission Limits

Emission limitations for hexavalent chromium were previously contained in subsection (c) and would now be contained in section 93102.4. A number of organizational changes are proposed including renaming the section to “Requirements for Existing, Modified, and New Hexavalent Chromium Plating and Chromic Acid Anodizing Facilities.” Other organizational changes are necessary to clarify that the existing limits would remain in effect until the proposed new limits would become effective. The section would be divided into requirements that continue to apply until the new requirements become effective.

a. Proposed subsection (a), Existing Hexavalent Chromium Limits

In section 93102.4, clarifying language is proposed to help the owner or operator to understand when the existing limits would no longer be effective and when compliance with the newly proposed limits would be required. As proposed, subsection 93102.4(a) would contain the current limits for existing hexavalent chromium facilities, and the limits for new or modified facilities up until the effective date of the new limits. Subsection (a)(1) applies to hard chromium plating facilities while subsection (a)(2) applies to decorative chromium plating and chromic acid anodizing facilities. Language is also proposed to specifically list all of the sections that contain other requirements that must be complied with, in addition to the limits set forth in section 93102.4.

b. Proposed subsection (b), New Hexavalent Chromium Limits

Proposed subsection (b) would contain the proposed new requirements for existing hexavalent chromium facilities to reduce emissions. Rather than continued bifurcation of requirements, staff is proposing that all facilities using the hexavalent chromium process, whether they perform decorative plating, hard plating, or chromic acid anodizing, would be subject to the same requirements. Based on emissions testing results, staff believes that uncontrolled emissions from these sources are similar and that each source of hexavalent chromium emissions should be controlled in the same manner and to the

same degree. Also, based on our analysis of health risks in Chapter VIII, staff is also proposing that limits be phased in based on throughput, cancer risk, and proximity to sensitive receptors.

The proposed amendments to the ATCM would require best available control technology (BACT) to further reduce the public's exposure to hexavalent chromium from chromium plating and chromic acid anodizing facilities. BACT would apply to all facilities over time. For very small facilities BACT is use of specific chemical fume suppressants. BACT for all other facilities is a HEPA filtration system, or equivalent control. The requirements that would apply to each class of facility are specified in Table 93102.4, and are described below.

Very low throughput ($\leq 20,000$ ampere-hours per year) facilities would be allowed to reduce hexavalent chromium emissions through use of specified chemical fume suppressants to lower surface tension of the plating or anodizing bath. This represents BACT for these facilities. Using specified chemical fume suppressants to lower surface tension reduces hexavalent chromium emissions to 0.01 milligrams/ampere-hour. Alternatively, these facilities may choose to comply by installing add-on air pollution control devices. Staff estimates that using specified chemical fume suppressants would result in a remaining cancer risk of no more than one per million people exposed. The chemical fume suppressants to be used for compliance are displayed in Table 93102.8 of section 93102.8.

Application of BACT for all other facilities would require use of control technologies rated at 99.97 percent efficient for collecting particles of 0.3 micrometers in diameter. This is the control efficiency achieved through installation of a HEPA filter add-on air pollution control device. The emission limitation equivalent to this level of control would be 0.0015 milligrams/ampere-hour. Staff is also proposing that intermediate-sized facilities be allowed to control emissions with devices other than HEPA filters, as long as a performance test demonstrates hexavalent chromium emissions to be no more than 0.0015 milligrams/ampere-hour. The timing for requiring compliance would be based on annual ampere-hours, health risk, and proximity to sensitive receptors.

Intermediate-sized facilities ($> 20,000$ and $\leq 200,000$ ampere-hours per year) would have five years to comply with the emission limitation if the facility is located more than 100 meters from a sensitive receptor. To protect sensitive receptors, other intermediate-sized facilities located at or within 100 meters of a sensitive receptor would be required to meet the emission limitation in two years. All intermediate-sized facilities would be given the option to demonstrate compliance with the emission limitation without installation of add-on air pollution control devices. These proposals are designed to potentially reduce compliance costs for smaller businesses. Staff estimates that meeting the emission limit of 0.0015 milligrams/ampere-hour would result in a remaining cancer risk of no more than one per million people exposed.

The largest facilities ($> 200,000$ ampere-hours per year) would be required to comply with the emission limitation of 0.0015 milligrams/ampere-hour within two years using an add-on air pollution control device(s). After meeting the emission rate, we estimate that

85 percent of larger facilities would have a remaining cancer risk of less than 10 per million people exposed. Less than one percent of facilities would have cancer risk of more than 25 per million people exposed. Those facilities with cancer risk of over 25 per million would be required to conduct an additional risk analysis, based on the individual facility's specific conditions and parameters to determine if further risk reduction would be required. Staff estimates that about 15 grams of emissions from a small point source would result in a cancer risk of over 25 per million people exposed. This site specific analysis could lead to measures to further reduce cancer risk.

Table IX-3 summarizes the requirements for compliance with the emission limitations. In the regulation, this table is labeled "Table 93102.4" and is set forth in section 93102.4.

Table IX-3. Proposed Hexavalent Chromium Emission Limits for Existing Facilities

Tiers of Annual Permitted Ampere-Hours	Sensitive Receptor Distance ¹	Emission Limitation	Effective Date
Tier 1 < 20,000	Any	Use Chemical Fume Suppressant as specified in section 93102.8 ²	[Six Months after Effective Date]
Tier 2 > 20,000 and < 200,000	≤ 100 Meters	0.0015 milligrams/ampere-hour ³	[Two Years after Effective Date]
Tier 3 > 20,000 and < 200,000	> 100 Meters	0.0015 milligrams/ampere-hour ³	[Five Years after Effective Date]
Tier 4 > 200,000	Any	0.0015 milligrams/ampere-hour ^{4, 5}	[Two Years after Effective Date]

¹ Distance shall be evaluated by the permitting agency.

² Alternatively, [Two Years after Effective Date] facility shall comply with the requirement for facilities with > 20,000 and ≤ 200,000 annual permitted ampere-hours.

³ Emission limit compliance can be demonstrated without add-on air pollution control device.

⁴ Measured after add-on air pollution control device.

⁵ When actual annual emissions exceed 15 grams, a site specific analysis must be conducted in accordance with the permitting agency's procedures.

In proposed subsection 93102.4(b)(2), language is provided to explicitly indicate that facilities within Tier 2 or Tier 3 can demonstrate compliance without using an add-on air pollution control device. However, at a minimum, these facilities would have to use the chemical fume suppressants specified in section 93102.8. This subsection would also specify that facilities in Tier 4 would be required to use an add-on air pollution control device to demonstrate compliance.

c. Proposed subsection (c), Modified Facilities

As mentioned above in the 'Definitions' section, staff is proposing to change the definition of 'Modification' to include increases in throughput (measured as ampere-hours) that would result in the facility moving to a different tier of control. To protect public health, a facility wishing to modify operations would be required to control hexavalent chromium emissions by installing an add-on air pollution control device to reduce hexavalent chromium emissions to a rate of no more than 0.0015 milligrams/ampere-hour.

To evaluate if a facility continues to pose an unacceptable health risk after installation of state-of-the-art add-on air pollution control devices, an additional requirement is proposed. Facilities whose emissions exceed 15 grams per year would need to conduct a site specific analysis to determine if further risk reduction measures are necessary. Staff estimates that about 15 grams of emissions from a small point source would result in a cancer risk of over 25 per million people exposed.

d. Proposed subsection (d), New Facilities

As explained in Chapter I, chromium plating and chromic acid anodizing operations can create "Hot Spots," with emissions that have a maximum impact near-source. Our data also show that 43 percent of existing facilities are located near people, which has led to unacceptable exposures to hexavalent chromium emissions. To avoid future situations where residential units or sensitive receptors are located in very close proximity to a chromium plating or chromic acid anodizing facility, staff is proposing that a new facility cannot operate in an area zoned for residential or mixed use. In addition, the facility also could not operate within 150 meters from the boundary of any area zoned as residential or mixed use. Modeling results indicate that at this distance the concentration of the hexavalent chromium emissions has been reduced to about 20 percent of the original near source concentration.

However, staff is proposing to include provisions that the new facility would be deemed to meet this requirement as long as the facility met the separation requirement when the authority to construct was issued by the permitting agency (and substantial use of the authority to construct takes place within one year after it is issued), or met the requirement before any land use zoning changes occur.

Even with this separation requirement, staff is proposing that any new facility would be required to control hexavalent chromium emissions by installing a HEPA add-on air pollution control device and demonstrate that the hexavalent chromium emission rate after the HEPA add-on air pollution control device is no more than 0.0015 milligrams/ampere-hour. Under the proposal, all new facilities would be required to conduct a site-specific analysis to determine if further risk reduction measures are necessary.

e. Proposed subsection (e), Notification Requirements for New and Modified Sources

The requirements of proposed subsection 93102.4(e) have been moved from former subsection (j). Minor modifications to the language were also made to improve clarity. These requirements, relating to new and modified facilities, specify other requirements that must be met prior to a facility undergoing modification or prior to a new facility beginning operation.

5. Proposed Section 93102.5--Additional Requirements

Within new section 93102.5, requirements are proposed that apply to all hexavalent chromium plating and chromic acid anodizing facilities (*i.e.*, all existing, modified, and new facilities).

Staff is proposing, in subsection (a), that any facility with an add-on air pollution control device(s) could not remove the device, unless it is replaced with an add-on air pollution control device(s) meeting an emission rate of 0.0015 milligrams/ampere-hour. Requiring that the add-on air pollution control device remain in place provides an extra margin of safety.

ARB staff recognizes that the ATCM has many requirements that may be difficult to understand or carry out correctly without training. Staff also knows that following the requirements are necessary to control hexavalent chromium emissions effectively. Therefore, in subsection (b), we are proposing that every two years personnel designated by the owner or operator as responsible for environmental compliance must attend an ARB training class explaining how to comply. An exception to this requirement would be personnel that had attended the SCAQMD's training class for Rule 1469, which is also required every two years.

Fugitive emissions, essentially dust containing hexavalent chromium, can be an important contributor a facility's overall emission impact. While these emissions are difficult to quantify, we nevertheless believe measures are necessary to minimize these fugitive emissions. We are therefore proposing housekeeping measures in subsection (c) to reduce the mechanisms by which hexavalent chromium may be accidentally splashed or spilled, and are also proposing housekeeping measures to reduce dust that may become re-entrained into the ambient air.

To limit the generation of hexavalent chromium dust, staff's proposal includes:

- Storing chemicals such as chromic acid in closed containers in enclosed storage areas;
- Transporting chemicals to the plating or anodizing bath in closed containers;
- Cleaning up or containing liquid or solid spills that may contain hexavalent chromium within an hour of the spill occurring;
- Minimizing dragout by:
 - For automated lines: requiring drip trays between tanks;

- For manual lines: requiring that dragout be minimized. When parts are sprayed off over the tank with fresh water, a splash guard would be required to ensure water from the part rinsing is returned to the tank;
- Cleaning of surfaces, such as floors, walkways around tanks, and storage areas that potentially are contaminated with hexavalent chromium at least once every seven days;
- Installing a barrier, such as plastic strip curtains, to separate buffing and grinding areas from the plating tank area; and
- Requiring that all waste/dust from housekeeping practices be disposed of properly as hazardous waste.

6. Proposed Section 93102.6--Requirements for Trivalent Chromium Baths and Enclosed Hexavalent Chromium Electroplating Facilities

The requirements for trivalent chromium plating facilities were previously contained in subsection (c). Proposed new section 93102.6 would specify the requirements for facilities electroplating with the trivalent chromium process and for facilities employing an enclosure around the plating tank to control hexavalent chromium emissions.

Generally, the requirements for facilities plating with trivalent chromium would be unchanged (subsection (a)). However, even though trivalent chromium is not considered a carcinogen, its use is not without some health impacts. Therefore, we are proposing that the separation requirements (in section 93102.4(d)(1)) for new hexavalent chromium facilities also apply to new trivalent chromium plating facilities.

Like the provision for new hexavalent chromium plating or chromic acid anodizing facilities, no new trivalent chromium facility could operate if it were located within an area zoned residential or mixed use, or if it were to be located within 150 meters from the boundary of any area zoned residential or mixed use.

Subsection 93102.6(a) also specifies which requirements of the ATCM an owner or operator of a trivalent chromium plating facility does not need to comply with.

The requirements in subsection (b) relating to enclosed hexavalent chromium tanks are being proposed to incorporate changes to the federal Chromium Plating NESHAP. As described by U.S. EPA, ventilation rates for enclosed tanks are considerably lower than ventilation rates for conventional ventilated facilities. Because of this, some facilities with enclosed tanks had difficulty meeting the chromium emission concentration limit specified in the Chromium Plating NESHAP, even when emissions from those tanks are well controlled. To rectify the situation, U.S. EPA adopted a separate alternative mass emission rate limit for chromium electroplating tanks equipped with enclosing hoods (U.S. EPA, 2004). We are proposing to add these provisions to the Chromium Plating ATCM.

Alternatively, these facilities may opt to comply with an emission rate of 0.0015 milligrams per dry standard cubic meter of air as measured after the add-on air pollution control device, or use a specified chemical fume suppressant.

New enclosed hexavalent chromium plating facilities would also be subject to the separation requirements described above for new trivalent chromium plating facilities.

7. Proposed Section 93102.7--Performance Testing and Test Methods

Performance testing and test methods were previously contained in subsection (d). Many of the proposed new regulatory requirements require facilities to determine the actual hexavalent chromium emission rate after the add-on air pollution control device(s). In this subsection, we are specifying the facilities that would have to conduct a performance (source) test to demonstrate compliance. As proposed, the following types of facilities would need to conduct a source test:

- Existing facilities demonstrating compliance with the 0.0015 milligrams/ampere-hour hexavalent chromium emission limitation;
- Facilities that undergo modification;
- Any new facility; and
- Trivalent chromium plating facilities meeting the emission rate in subsection 93102.6(a)(1).

All of these types of facilities would have to conduct the performance test within 60 days of initial start-up using an approved test method.

Facilities would be able to use an existing source test if it was conducted after January 1, 2000, and the test demonstrated an emission rate of 0.0015 milligrams/ampere-hour, or less. The test would need to have been approved by the permitting agency using an approved test method. The test results would also need to be representative of the air pollution control device(s) currently in use.

Minor modifications are proposed to subsections (c) and (d). One modification to the Approved Test Methods in subsection (c) would clarify that any performance test must include three test runs. Under another proposal, to measure surface tension with a tensiometer continued use of U.S. EPA Method 306-B would be required. When measuring surface tension with a stalagmometer, the method in new proposed Appendix 8, or a method approved by the permitting agency would need to be used. Identifying a specific procedure will provide more accurate and uniform results. In subsection (d), clarifying language is proposed to identify that the pre-test protocol is to be submitted to the permitting agency.

8. Proposed Section 93102.8--Chemical Fume Suppressants Used for Compliance

Results of our emissions testing program, along with results from the SCAQMD certification program, demonstrated that certain chemical fume suppressants were more efficient than others at reducing hexavalent chromium emissions. To ensure maximum reduction of hexavalent chromium from facilities using chemical fume suppressants, staff is proposing to specify the types of chemical fume suppressants that could be used to reduce surface tension. The chemical fume suppressants that could be used are listed

below in Table IX-4, along with the surface tension at which they must be used. Based on our emissions testing program and analysis of results from the SCAQMD Fume Suppressant Certification Program (SCAQMD, 2004), staff has determined that the chemical fume suppressants listed in Table IX-4 are most efficient for preventing emissions of hexavalent chromium. In the regulation, Table IX-4 is labeled “Table 93102.8” and is set forth in section 93102.8(a).

Table IX-4. Chemical Fume Suppressants Approved for Use at Specified Surface Tensions

Chemical Fume Suppressant and Manufacturer	Stalagmometer Measured Surface Tension (dynes/centimeter)	Tensiometer Measured Surface Tension (dynes/centimeter)
Benchbrite CR 1800® Benchmark Products	< 40	< 35
Clepo Chrome® MacDermid	< 40	< 35
Fumetrol 140® Atotech U.S.A.	< 40	< 35

Staff is also proposing that additional chemical fume suppressants may be used upon approval by the ARB Executive Officer, if specified criteria are met. A provision to revoke use of a specified chemical fume suppressant, if it is found to no longer meet an emission rate of 0.01 milligrams/ampere-hour or less, is also proposed. This provision is necessary to protect public health.

9. Proposed Section 93102.9--Parameter Monitoring

Parameter monitoring requirements were previously contained in subsection (e). Minor changes are proposed to section 93102.9, Parameter Monitoring, to clarify existing provisions.

10. Proposed Section 93102.10--Inspection and Maintenance Requirements

Inspection and maintenance requirements were previously contained in subsection (f). Changes are proposed to section 93102.10, Inspection and Maintenance Requirements, to consolidate the requirements where appropriate. A new provision is proposed for facilities that have custom designed add-on air pollution control devices. The owner or operator of such a facility would be required to develop operation and maintenance requirements for review and approval by the permitting agency.

11. Proposed section 93102.11--Operation and Maintenance Plan Requirements

Operation and maintenance plan requirements were previously contained in subsection (g). Minor modifications are proposed to section 93102.11. The proposed changes are necessary to update citations for other subsections which have been reorganized.

12. Proposed section 93102.12--Recordkeeping

Recordkeeping requirements were previously contained in subsection (h). Minor modifications are proposed to section 93102.12, Recordkeeping. Most of the modifications clarify the provisions or update citations within the ATCM. Also, as proposed, section 93102.12, would be modified to specify additional records that must be kept. Facilities would be required to maintain monthly records of total ampere-hour usage per calendar year to verify compliance with the emission limit that corresponds to the ampere-hour thresholds. In addition, facilities would be required to keep records documenting that the proposed housekeeping requirements are met.

13. Proposed section 93102.13--Reporting

Reporting requirements were previously contained in subsection (i). Minor changes are proposed to subsections (a) through (d) of section 93102.13, Reporting. These changes would clarify the information to be reported or specify when reports are to be submitted to the permitting agency. The staff is proposing to modify subsection (e) to identify the information that must be submitted to the permitting agency for existing facilities using trivalent chromium and for new facilities using the trivalent chromium process.

14. Proposed section 93102.14--Procedure for Establishing Alternative Requirements

Procedures for establishing alternative requirements were previously contained in subsection (k). Minor modifications are proposed in subsections (a) through (e) of section 93102.14, Procedure for Establishing Alternative Requirements. In subsection (f), we are proposing that waivers obtained from U.S. EPA for alternative compliance with the emission limits will no longer be valid after the date of the requirements in section 93102.4(b) become effective for a particular facility. This modification is necessary to ensure all facilities meet the new requirements. We are also proposing that ARB would have to concur on any waivers associated with alternatives to compliance with section 93102.4, Requirements for Existing, Modified, and New Hexavalent Chromium Plating and Chromic Acid Anodizing Facilities.

15. Proposed section 93102.15--Requirements Related to Chromium Plating or Chromic Acid Anodizing Kits

Staff is proposing requirements related to chromium plating kits. We are aware that these kits are currently offered for sale over the Internet. Because no restrictions exist on who

may buy these kits, they may be sold or supplied to a person that is not trained or aware of the hazards associated with chromium plating or chromic acid anodizing. These kits also could be a source of uncontrolled hexavalent chromium emissions. This could lead to unacceptable exposures for the individual performing the chromium plating or chromic acid anodizing, or for near-by sensitive receptors.

Because of these hazards, staff is proposing that these chromium plating or chromic acid anodizing kits could not be sold, supplied, offered for sale, or manufactured for sale in California. However, this provision would not apply if the kit was sold to the owner or operator of a permitted chromium plating or chromic acid anodizing facility.

These kits also could not be used unless the kit is used at a permitted chromium plating or chromic acid anodizing facility that is in full compliance with the ATCM.

We are also proposing that for the purposes of these provisions a “chromium electroplating or chromic acid anodizing kit” means chemicals and associated equipment for conducting chromium electroplating or chromic acid anodizing, including, but not limited to, internal and external tank components.

16. Proposed section 93102.16--Appendices

Staff is proposing that the Appendices to the Chromium Plating ATCM be contained within a new section, 93102.16. There are eight appendices. Most of these have been part of the Chromium Plating ATCM since 1998. Only the Appendices proposed for modification or addition are described. Appendix 1, Content of Performance Test Reports, is proposed for modification to indicate that test results must be provided in milligrams/ampere-hour.

Appendices 2 and 3, Content of Initial Compliance Status Reports, and Content of Ongoing Compliance Status Reports, respectively, are being modified to ensure that the permitting agency has all of the necessary information to ensure facilities are complying with all of the newly proposed provisions and requirements.

We are proposing to add a requirement to Appendix 4, Notification of Construction Reports, to ensure that any new facility is complying with the provisions for new facilities in section 93102.4(d), such as the separation requirements.

We are proposing to add Appendix 7, Alternative Requirements for Enclosed Hexavalent Chromium Electroplating Facilities- Mass Emission Rate Calculation Procedure. The calculation method shown in the appendix is used to demonstrate compliance with the alternative emission limit for enclosed tanks specified in subsection 93102.6(b)(1)(C).

We are also proposing to add Appendix 8, Surface Tension Procedure for a Stalagmometer. This appendix outlines a method to be followed to ensure accurate and consistent measurement of surface tension with a stalagmometer.

17. When the Proposed Amendments Become Legally Effective

In addition, we would like to clarify that the proposed amendments to the ATCM do not impose retroactive requirements on chromium plating and anodizing facilities. California law is clear that the proposed amendments to the ATCM cannot become legally effective until it is adopted by the ARB and is approved by the Office of Administrative Law. Until then, chromium plating and chromic acid anodizing facilities are not required to comply with any requirement specified in the amended ATCM, unless an air district independently imposes the same or similar requirement pursuant to its own local rules or permitting authority.

C. Basis for the Proposed Amendments

The proposed amendments to the Chromium Plating ATCM are based on our reevaluation of BACT for reducing hexavalent chromium emissions from chromium plating and chromic acid anodizing facilities, in consideration of health risk and cost. In reevaluating BACT, we analyzed information from ARB's 2003 chromium plating and chromic acid anodizing facility survey, available source test data, and data from the emissions testing program.

As a basis for the proposal, staff conducted the HRA to determine estimated cancer risks in a manner which is very health protective in estimating cancer risks for a range of reasonably foreseeable exposure scenarios. Staff believes this health protective approach is necessary due to the very high potency and resultant serious health hazards associated with exposure to hexavalent chromium emissions.

Based on the information collected, the health protective analyses conducted, and discussions with air districts, industry, and control equipment manufacturers, we determined that reliable control devices are readily available and widely used. Further, the application of BACT, as proposed by staff, will result in potential cancer risk levels being reduced to no more than one per one million people for 162 facilities (about 75 percent). An additional 41 facilities (about 20 percent), would have estimated cancer risk of no more than ten per million exposed people. Moreover, only six facilities would have a remaining cancer risk greater than 25 per million exposed people. Staff's proposal to require a site specific analysis, for review by the air districts, could result in further cancer risk reduction from these facilities. Overall 92 percent of the facilities would have cancer risk of no more than ten per million exposed people. In addition, the proposed amendments would ensure that the chronic hazard indices for all facilities would not exceed one.

D. Alternatives to the Proposed Amendments

California Government Code section 11346.2 requires the ARB to consider and evaluate reasonable alternatives to the proposed amendments to the ATCM and to provide reasons for rejecting these alternatives. Staff considered the following alternatives to the proposed amendments to the ATCM:

1. **Alternative 1: Require Decorative Chromium Plating Facilities to Use the Trivalent Chromium Plating Process**

One alternative to the staff's proposal would be to require the use of the trivalent chromium plating process for all decorative chromium plating facilities. The process is already in use successfully in ten businesses (six facilities only conduct trivalent chromium plating and four facilities conduct both trivalent and hexavalent chromium plating) in California. Requiring all decorative chromium facilities to use the trivalent chromium process would eliminate the remaining cancer risk from the hexavalent chromium emissions from decorative chromium plating facilities. In fact, the switch to the trivalent chromium process could be more cost effective than the staff's proposal, which would require installation of BACT (HEPA add-on air pollution control device). As estimated, installation and annual operating costs for a HEPA system are estimated at about \$89,000 and \$33,500 respectively. Our cost estimate for converting to trivalent chromium includes a one-time cost of about \$41,500 and ongoing costs of \$23,000. Under the staff's proposal, there will be residual cancer risk. However, 162 facilities would have estimated cancer risks of one or less per million exposed people after adoption of the staff's proposal. Overall, 92 percent of facilities would have cancer risk of less than ten per million exposed people.

Staff has evaluated the trivalent chromium process and has determined that it is not a universal replacement for all decorative chromium plating applications. Also, use of the trivalent chromium process would create business competitiveness issues between California businesses and those in other States, and between California businesses and those off-shore. Therefore, staff has determined this is not a technologically feasible alternative.

Nevertheless, businesses may make the decision to convert to the trivalent chromium process, if it is a viable option for their application.

2. **Alternative 2: Require HEPA, or the Equivalent, Add-On Air Pollution Control Device for All Facilities**

Another alternative would be to require installation of HEPA, or equivalent, add-on air pollution control devices for all facilities. This technology is the most effective option. Implementation of this proposal would reduce the remaining cancer risk from about 48 facilities that presently have throughput below 20,000 annual ampere-hours. Staff chose not to pursue this alternative. The staff's proposal represents a balance between health risk and cost. For these facilities, chemical fume suppressants represent BACT. Adoption of the staff's proposal will result in these facilities having estimated cancer risks below one per million people. This alternative would result in no appreciable additional benefit and would add additional equipment costs of over \$4.0 million. Individual businesses would have annual costs of about \$46,000. About half of these facilities are small businesses with annual revenue of less than \$1,000,000.

3. Alternative 3: Adopt the Provisions of Rule 1469 Statewide

Industry representatives have asked staff to evaluate the adoption of SCAQMD Rule 1469 statewide. Rule 1469, Control of Hexavalent Chromium Emissions from Chrome Plating and Chromic Acid Anodizing Operations, is now in full effect in the SCAQMD. Rule 1469 requires hexavalent chromium facilities located within 25 meters from a sensitive receptor or within 100 meters from a school to reduce hexavalent chromium emissions such that the residential cancer risk will be no more than ten chances per million people. The rule also requires facilities located greater than 25 meters from a sensitive receptor or 100 meters from a school to reduce emissions such that off-site worker cancer risk would be no more than 25 chances per million people.

Staff has evaluated this alternative and has found it does not provide the level of protection that would be achieved through adoption of the staff's proposal. This is because BACT is not required for all facilities. By using off-site worker scenarios to calculate cancer risk, rather than residential, the risk to people and children living near the facility is underestimated by one-third. This means that estimated cancer risk for residents is 33 per million people exposed, rather than 25 per million people exposed. ARB could not use this scenario because it does not follow standard risk assessment methodologies developed by OEHHA and employed by ARB.

If Rule 1469 were implemented statewide, 75 percent of facilities would have estimated cancer risk of less than ten per million exposed people. This offers very little benefit over the baseline in which 71 percent of facilities were found to have estimated cancer risk of ten per million exposed people. The staff's proposal would result in 92 percent of facilities having estimated cancer risk of less than ten per million exposed people. In addition, if Rule 1469 were adopted statewide, eight percent of facilities would have cancer risk of over 25 per million exposed people. Two facilities' risk would exceed 100 per million exposed people. This is not health protective given the availability of BACT. If the staff's proposal were adopted, no facilities would have cancer risks over 100 per million exposed people. A comparison of the benefits of adopting Rule 1469 statewide and the benefits of the staff's proposal as shown in Figure IX-1.

Adoption of Rule 1469 statewide would, however, result in cost savings over the staff's proposal. Equipment costs would be about \$600,000 because only seven additional facilities would need to install add-on air pollution control devices.

4. Alternative 4: Require No Further Control

Alternative 4 would be to require no additional control beyond what the existing ATCM, in combination with implementation of Rule 1469 in the SCAQMD, has achieved. This would be equivalent to the 2005 baseline cancer risk. This would result in allowing the maximum incremental cancer risks from some facilities to exceed 100 per million people and for 29 percent of facilities to have cancer risk in excess of ten per million people. Only 41 percent of facilities would have estimated cancer risk below one per million exposed people. Requiring no further control would, of course, result in cost savings

because the staff’s proposal is estimated to cost \$14.2 million dollars. Of this amount, about \$9.6 million would be related to purchasing HEPA filtering add-on air pollution control devices.

Staff does not believe the *status quo* is protective of public health especially considering that 43 percent of facilities are located within 100 meters of a sensitive receptor. Our goal is to achieve the maximum feasible health protection using the most effective controls. This is especially important when people are living, learning, working, or playing near chromium plating and chromic acid anodizing facilities. Thus, staff did not choose Alternative 4.

5. Summary

Table IX-5 compares alternatives three and four with the staff’s proposal. Alternatives one and two are not presented. Alternative one is not technologically feasible. Alternative two essentially offers no benefit beyond the staff’s proposal.

Table IX-5. Adoption of Staff’s Proposal Offers the Greatest Reduction in Significant Community Cancer Risk

	Number of Facilities by Cancer Risk			
	≤1 per million	>1 ≤10 per million	>10 ≤100 per million	>100 per million
Staff Proposal	162	41	17	0
Rule 1469 Statewide	98	67	53	2
Baseline	90	67	57	6

Table IX-5 shows that the staff’s proposal offers the best health protection. As shown, adopting the provisions of SCAQMD Rule 1469 statewide would result in 98 facilities (about 45 percent) with remaining cancer risk of no more than one per million exposed persons. This represents an additional 8 facilities compared to the baseline. Adoption of the staff’s proposal would reduce the estimated cancer risk for 162 facilities (about 74 percent) to no more than one per million exposed persons.

6. Conclusion

We evaluated each of the alternatives and determined that the alternatives did not meet the objective of Health and Safety Code section 39666 to reduce emissions to the lowest level achievable through the application of BACT, or a more effective control method, in consideration of cost, health risk, and environmental impacts.

E. Recommendation

Based on the forgoing, staff recommends that the Board adopt the proposed amendments to the Chromium Plating ATCM (Appendix A). Requiring BACT for all facilities provides the greatest reductions in significant community cancer risk. The staff's proposal, compared to the 2005 baseline, would result in up to an 85 percent reduction in estimated cancer risk for individual facilities. Staff predicts the proposal would reduce 162 facilities' (about 74 percent) cancer risk to no more than one per million exposed people, and reduce cancer risk to no more than ten per million for over 92 percent of facilities. The proposal would also directly benefit low income and ethnically diverse communities that have been disproportionately impacted by emissions from chromium plating and chromic acid anodizing facilities.

REFERENCES:

SCAQMD, 2004. South Coast Air Quality Management District. Certified List of Fume Suppressants for Facilities Performing Chrome Plating and Chromic Acid Anodizing Operations. 2004 (<http://www.aqmd.gov/prdas/ChromePlating/ChromePlating.htm>)

U.S. EPA, 2004. U.S. Environmental Protection Agency. 40 CFR Part 63: “National Emission Standards for Chromium Emissions From Hard and Decorative Chromium Electroplating and Chromium Anodizing Tanks”. 2004.

X. Economic Impacts

ARB staff has evaluated the estimated costs and economic impacts associated with implementation of the proposed amendments to the Chromium Plating ATCM. This Chapter summarizes the results of our findings. The expected first year estimated costs, capital costs and annual recurring costs that would be expended to comply with the proposed amendments are described. Staff has conducted a conservative analysis of potential costs to be incurred. We have estimated that all facilities needing to demonstrate compliance with the 0.0015 milligrams/ampere-hour limit would install a HEPA add-on air pollution control device. This may not be the case. Some facilities may be able to demonstrate compliance with alternative, cheaper methods. The costs and associated economic impacts are given for private companies and California governmental agencies.

A. Summary of the Economic Impacts

The proposed amendments to the Chromium Plating ATCM are not expected to have a significant adverse impact on the profitability of most owners or operators of chromium plating and chromic acid anodizing facilities in California. However, staff has determined that costs for some individual businesses are expected to be significant and would adversely impact their profitability. The effect of compliance costs on profitability impacts were estimated by calculating the decline in the return on owner's equity (ROE). A decline in ROE of 10 percent or more indicates a significant adverse impact. The proposed amendments to the ATCM are expected to result in an average ROE decline of nine percent which is not considered to be a significant impact on the profitability of most affected businesses. However, the ROE for some individual businesses exceeds ten percent. We estimate that businesses' profitability impacts range from less than one percent to 41 percent.

When considering the entire industry, we expect the proposed amendments to have no significant impact on employment; business creation, elimination or expansion; or business competitiveness in California. However, some individual businesses, including small businesses, could be significantly impacted, which could result in business closures and lost jobs. We expect no significant adverse fiscal impacts on any local or State agencies.

Of the 226 facilities affected by the proposed amendments to the ATCM, up to 89 facility owners would be required to expend significant capital to meet the requirements. Some of these operators may have difficulty securing the required capital to finance the cost of the add-on air pollution control devices that would be required for compliance with the proposed amendments to the ATCM. However, in 2005, the Governor signed legislation to establish a loan guarantee program for decorative chromium plating operations to purchase pollution control equipment. The program is administered by the Business, Transportation, and Housing Agency. The program provides loan guarantees of up to \$100,000 to owners of decorative chromium plating small businesses that may not be able to qualify for a conventional loan. In July of this

year, the Governor signed into law amendments to the loan guarantee program. The loan guarantee program is now available for all metal plating facilities.

During the first year, all facilities would have compliance costs. Costs would vary depending on the extent an individual business was already in compliance with the proposed amendments. About 40 percent of facilities are already controlled with HEPA filtration systems, or equivalent; they would incur no capital costs. Another 20 percent of facilities would use chemical fume suppressants as sole control. Therefore, these facilities compliance costs will be low, as well. Compliance costs for trivalent chromium plating facilities would also be low. The proposed amendments would only require these facilities to file an initial compliance status report.

We estimate that costs in the first year would range from \$450 to \$217,000 with an average cost of \$23,000. Median cost would be \$8,500. In subsequent years, costs would range from essentially no cost to \$217,000 with an average cost of \$53,000. Median cost in subsequent years would be \$46,000. After the first year, 60 percent of the facilities would have no additional compliance costs. Costs for all facilities include completion of an initial compliance status report. Other costs incurred by some, but not all facilities, include permit fees, performance testing, site specific analyses, housekeeping costs, capital equipment costs (amortized), and ongoing (recurring) costs. The assumptions from which these costs are estimated as described below.

B. Economic Impact Analysis

1. Legal Requirements

Section 11346.3 of the Government Code requires State agencies to assess the potential for adverse economic impacts on California business enterprises and individuals when proposing to adopt or amend any administrative regulation. The assessment must include a consideration of the impact of the proposed regulation on California's jobs, business expansion, elimination or creation, and the ability of California businesses to compete with businesses in other states.

In addition, State agencies are required to estimate the cost or savings to any State or local agency and school district in accordance with instructions adopted by the Department of Finance. The estimate shall include any non-discretionary cost or savings to local agencies and the cost or savings in federal funding to the State.

Health and Safety Code section 57005 requires the ARB to perform an economic impact analysis of submitted alternatives to a proposed regulation before adopting any major regulation. The proposed amendments to the Chromium Plating ATCM are considered to be a "major regulation", because the estimated cost to California business enterprises exceeds \$10 million in the first year.

2. Affected Businesses

Any business conducting chromium plating, chromic acid anodizing, or business selling chromium plating kits to non-permitted facilities would be affected by the proposed amendments to the ATCM. Also potentially affected are businesses that are customers of chromium plating or chromic acid anodizing facilities, such as the aerospace and automotive industries. The focus of this analysis, however, will be chromium plating and chromic acid anodizing facilities because these businesses would be most affected by the proposed amendments to the ATCM.

The affected businesses generally fall under a Standard Industrial Classification (SIC) code of 34, Fabricated Metal Industry, and more specifically, SIC 3471, Plating and Polishing, or North American Industry Classification System (NAICS) 332813.

3. Potential Impacts on Profitability for Affected Businesses

The approach used in evaluating the potential economic impact of the proposed amendments to the ATCM on California businesses is as follows:

- All affected facilities are identified from responses to the ARB's 2003 Chromium Plating and Anodizing Facility Survey.
- Financial data and net profit data are obtained for a typical business engaged in plating and polishing businesses from Dun's Financial Profile; SIC 3471 Industry Profiles (D&B, 2005) and Dun and Bradstreet Business Information Report. (D&B, 2006)
- The annual cost of compliance is estimated for the businesses that are affected by the proposed amendments to the ATCM.
- The annual cost of compliance for each business is adjusted for both federal and state taxes. It is assumed affected businesses are subject to federal and State tax rates of 35 percent and 9.3 percent, respectively.
- These adjusted costs are subtracted from net profit data and the results are used to recalculate the ROE.
- The resulting ROE is then compared with the ROE before the subtraction of the adjusted costs to determine the impact on the profitability of the businesses. A reduction of more than 10 percent in profitability is considered to indicate a potential for significant adverse economic impacts. This threshold is consistent with the thresholds used by the U.S. EPA and ARB in previous regulations.
- Affected businesses absorb the costs of the proposed amendments to the ATCM instead of increasing the prices of their products or lowering their costs of doing business through cost-cutting measures.

All of the chromium plating and chromic acid anodizing businesses affected by these proposed amendments are California businesses. These businesses are affected to the extent that implementation of the proposed amendments reduces their profitability. Using ROE to measure profitability, we estimate the decline in ROE for most affected

businesses would be less than ten percent based on 2002-2004 financial data. This is based on an average compliance cost for all facilities of \$23,000. This does not represent a noticeable decline in the profitability of most affected businesses.

However, for the 89 businesses that would likely need to install or upgrade add-on air pollution control devices, the estimated decline in profitability ranges from 3 to 41 percent. The average estimated compliance costs for these facilities is \$53,000.

Of the 89 facilities, 28 small businesses may need to install add-on air pollution control devices. This could result in a potential significant adverse cost impact. These businesses' profitability could decline by 33 percent in order to comply with the proposed amendments. Some marginal businesses would likely face a difficult business decision as to whether to continue operating the chromium plating portion of their operation. However, this cost analysis is based on the assumption that these small businesses would have to install add-on air pollution control devices. Some of these businesses may be able to demonstrate compliance without the use of an add-on air pollution control device. Others may decide to cease chromium plating, but retain other aspects of their operations and remain viable. In these instances, the ROE estimated here would be much lower. Some of these businesses may also qualify for a loan guarantees of up to \$100,000 to purchase pollution control equipment.

The remaining 137 businesses would have average compliance costs of about \$4,000. The decline in profitability for these businesses is not considered to be significant. The change in ROE ranges from less than one percent to nine percent.

4. Assumptions for Facility Cost Estimates

Seventy-five percent of the facilities are located in the SCAQMD. These facilities have already complied with Rule 1469 and are familiar with how the air district estimated costs for compliance with that rule. To allow for a comparison ARB staff generally used the SCAQMD's cost methodology, except that costs were grown from 2003 to 2006 dollars at a rate of 5 percent (factor of 1.158). Using this factor provides for a 'worst case' cost estimate because the inflation rate has been about three percent over this period of time (CPI, 2006). The costs estimated for each compliance requirement are summarized below in Tables X-1 and X-2. In addition, chemical fume suppressant cost was estimated at \$185/gallon at a use rate of 1.98×10^{-6} gallons/ampere-hour.

Table X-1. Estimated Compliance Costs (Other than Those for Add-On Air Pollution Control Devices)**

Initial Compliance Plan	Drip Trays	Plastic Strip Curtains	Permit fee *	Source Test	Site Specific Analysis
\$450	2 @ \$350	\$1,138	\$700/\$2,232	\$7,335	\$11,500

* Permit fee of \$2,232 for initial HEPA permit (cost estimate from ARB's Thermal Spraying Report).

** Costs are rounded.

Table X-2 displays the cost estimates used to estimate costs associated with hexavalent chromium add-on air pollution control devices.

Table X-2. Costs for HEPA Add-on Air Pollution Control Devices

System size Based on Fan Size	Freight	Equipment	Installation	Recurring
Small (5,000 Cubic Feet per Minute (CFM))	\$1,580	\$33,047	\$54,129	\$33,513
Medium (10,000 CFM)	\$2,328	\$48,705	\$79,313	\$39,850
Large (20,000 CFM)	\$3,843	\$80,396	\$129,882	\$57,570

For consistency, ARB staff calculated the cost of add-on air pollution controls as per the SCAQMD method. It was assumed that each tank at a facility is 36 square feet and is ventilated at 150 CFM per square foot. One tank, would require 5,400 CFM to be properly ventilated. The number of tanks at a facility was then multiplied by 5,400 to arrive at the total amount of ventilation required (SCAQMD, 2003a and SCAQMD, 2003b).

For example: 6 tanks @ 36 square feet X 5,400 CFM = 32,400 total CFM

In this example, it is assumed the facility would need to purchase one 5,000 CFM system @ \$88,756, one 10,000, system @ \$130,346, and one 20,000 CFM system @ \$214,121. The total cost would be \$433,223. In like fashion, recurring costs would be \$130,933.

When actual tank numbers were known, this information was used to estimate cost. When this information was not available, staff estimated the number of tanks needing ventilation based on facilities with similar ampere-hours where the number of tanks was known. The size of the system does not necessarily relate to throughput. An intermediate-sized facility (no more than 200,000 ampere-hours) may have multiple tanks requiring ventilation, such that a larger system 10,000 CFM system is needed. Other very large throughput facilities may only have one tank requiring ventilation. In this case, the larger facility would have cheaper compliance costs as only a 5,000 CFM system may be needed. However, staff has estimated that of the 89 facilities required to install HEPA systems, 80 out of 89 would be 5,000 CFM systems.

We annualized non-recurring fixed costs using the Capital Recovery Method. Using this method, we multiplied the non-recurring fixed costs by the Capital Recovery Factor (CRF) to convert these costs into equal annual payments over a ten year project horizon at a discount rate of five percent. The Capital Recovery Method for annualizing fixed costs is recommended by the California Environmental Protection Agency (Cal/EPA) (Cal/EPA, 1996), and is consistent with the methodology used in previous cost analyses for ARB regulations (ARB, 2000).

The CRF is calculated as follows:

$$CRF = \frac{i(1+i)^n}{(1+i)^n - 1}$$

where,

CRF = Capital Recovery Factor

i = discount interest rate (assumed to be 5 percent)

n = project horizon or useful life of equipment

All costs of the add-on air pollution control devices were annualized over 10 years. These values are based on a conservative estimate of the expected lifetime of the equipment. The total annualized cost was obtained by adding the annual recurring costs to the annualized fixed costs derived by the Capital Recovery Method.

Capital costs include the cost of the add-on air pollution control device, installation, freight, source test, and instrumentation.

Recurring costs include replacement filters, disposal of filters as hazardous waste, electrical usage, labor, property tax, insurance, and reporting costs.

5. Potential Economic Impacts for Individual Chromium Plating and Anodizing Facilities

From our industry survey we have identified 226 chromium plating and chromic acid anodizing facilities in California. Of these businesses, two are federal government facilities, the U.S. Naval Aviation Depot, in the SDCAPCD, and the United States Mint in the BAAQMD.

We estimate that 71 of the affected businesses are small businesses with gross annual revenue of less than \$1.0 million (U.S. EPA, 1995a). Of these, 28 businesses would likely incur costs associated with purchase and operation of add-on air pollution control devices.

In terms of estimating compliance costs, facilities can be divided into 4 groups: trivalent chromium plating facilities; hexavalent chromium plating and chromic acid anodizing facilities with throughput of less than or equal to 20,000 annual ampere-hours; hexavalent chromium plating and chromic acid anodizing facilities with throughput of more than 20,000 but less than or equal to 200,000 annual ampere-hours; and hexavalent chromium plating and chromic acid anodizing facilities with throughput of more than 200,000 annual ampere-hours. There are also hexavalent chromium plating and chromic acid anodizing facilities with throughput of more than 20,000 that are already in substantial compliance with the proposal. Costs for these facilities will be estimated separately from those needing to expend significant capital to comply.

a. Trivalent Chromium Plating Facilities

Six facilities conduct only trivalent chromium plating. These facilities would incur costs associated with submitting an initial compliance status report. This cost has been estimated at \$450 per facility. Beyond this one-time cost, compliance with the proposed amendments would result in no additional cost for these facilities.

b. Hexavalent Chromium Plating and Chromic Acid Anodizing Facilities with Throughput of Less Than or Equal to 20,000 Annual Ampere-Hours

Forty-eight facilities have been identified with throughput of less than or equal to 20,000 annual ampere-hours. Under the proposed amendments these facilities would be allowed to control hexavalent chromium emissions by reducing surface tension of the plating/anodizing bath by using specified chemical fume suppressants. Compliance costs for these facilities are estimated to average about \$2,000. The costs were estimated as described below.

Based on 2003 calendar year data, only ten of these 48 facilities were not using the specified chemical fume suppressants. Costs for these ten facilities to begin using specified chemical fume suppressants would result in no significant cost increase. All 48 of these facilities however, would need to complete an initial compliance status report estimated to cost \$450. It is also assumed that these facilities would have permit renewal fees of \$700. For facilities with buffing, grinding or polishing operations we estimated costs associated with purchase of plastic strip curtains at \$1,100. Costs for purchase of drip trays for facilities with automated lines were estimated to cost \$700. Thus, costs for these facilities range from \$1,150 to \$2,600, with average compliance costs of \$2,000. After the first year, 38 of these facilities would have no additional compliance costs beyond housekeeping and recordkeeping. Ten facilities would have annual recurring costs, but they are near zero.

c. Hexavalent Chromium Plating and Chromic Acid Anodizing Facilities with Throughput of More Than 20,000 but Less Than or Equal to 200,000 Annual Ampere-Hours

Sixty facilities have been identified with more than 20,000 but less than or equal to 200,000 annual ampere-hours. Of these, 45 facilities would need to take actions to demonstrate compliance with the emission limit of 0.0015 milligrams/ampere-hour; the other 15 facilities are already in substantial compliance. Generally, to meet the 0.0015 milligrams/ampere-hour limit requires use of a HEPA add-on air pollution control device. However, the requirement would be phased in based on throughput and proximity to sensitive receptors. [The other 15 facilities' costs are estimated as described in part e., below.] Total capital costs for these facilities are estimated to be about \$4.0 million. Total annualized costs (amortized plus recurring costs) are estimated to be \$2.1 million. The costs were estimated as described below.

Twenty-eight of these facilities are located within 100 meters of a sensitive receptor and would be required to demonstrate compliance within two years. The other 17 facilities would have five years to demonstrate compliance with the emission limit because they do not have sensitive receptors located within 100 meters. Some of these 45 facilities may be able to demonstrate compliance with the emission limit without installation of a HEPA add-on air pollution control device. However, most are expected to need to install a HEPA add-on air pollution control device to meet the 0.0015 milligrams/ampere-hour limit. Costs were estimated based on installation of a HEPA add-on air pollution control device for all of these facilities.

All of these facilities would need to complete an initial compliance status report estimated to cost \$450. It is also assumed that these facilities would have permit fees associated with installation a HEPA add-on air pollution control device. This cost is estimated to be \$2,200. Ongoing permit renewal fees are estimated at \$700. For facilities with buffing, grinding or polishing operations we estimated costs associated with purchase of plastic strip curtains at \$1,100. Costs for purchase of drip trays for facilities with automated lines were estimated to cost \$700. Performance tests would be required of all facilities, which is included in the cost of purchasing and installing a HEPA add-on air pollution control device.

The cost to purchase an add-on air pollution control device is estimated to be \$89,000 in initial capital costs (including installation, source testing, and freight). For these facilities, we amortized the costs of purchasing the add-on air pollution control devices over ten years. We also amortized the costs for permit fees, and purchase of plastic strip curtains and/or drip trays when required. Total costs to be amortized are estimated to be \$92,000. This equates to an annualized capital cost of about \$12,000 (in 2006 dollars) over the life of the equipment.

Annual recurring costs associated with equipment maintenance and ongoing permit fee renewals are estimated at \$34,000. Combining these annual costs with amortized costs results in an annual cost of about \$46,000 for purchase, installation, reports, fees, analyses, and maintenance of the equipment.

d. Hexavalent Chromium Plating and Chromic Acid Anodizing Facilities with Throughput of More Than 200,000 Annual Ampere-Hours

One hundred twelve facilities have been identified with more than 200,000 annual ampere-hours. Of these, 44 facilities would need to take actions to demonstrate compliance with the emission limit of 0.0015 milligrams/ampere-hour, as measured after an add-on air pollution control device. Generally, this requires use of a HEPA add-on air pollution control device. Costs were estimated for these facilities based on installation of a HEPA add-on air pollution control device. These facilities would be required to demonstrate compliance within two years. [The other 68 facilities' costs are estimated as described in part e., below.] Total capital costs for 44 facilities are estimated to be \$5.6 million. Total annualized costs (amortized plus recurring costs) are estimated to be \$2.7 million. The costs were estimated as described below.

All of these facilities would need to complete an initial compliance status report estimated to cost \$450. It is also assumed that these facilities would have permit fees associated with installation a HEPA add-on air pollution control device. This cost is estimated to be \$2,200. Ongoing permit renewal fees are estimated at \$700. For facilities with buffing, grinding or polishing operations we estimated costs associated with purchase of plastic strip curtains at \$1,100. Costs for purchase of drip trays for facilities with automated lines were estimated to cost \$700. Performance tests would be required of all facilities, which is included in the cost of purchasing and installing a HEPA add-on air pollution control device. After meeting the 0.0015 milligrams/ampere-hour limits, one facility would be required to conduct an additional assessment to determine if further risk reduction was needed. Cost for site specific analysis is estimated to cost \$11,500.

The costs to purchase add-on air pollution control devices are estimated to range from \$89,000 to about \$500,000 in initial capital costs (including installation, source testing, and freight). Average capital cost is about \$130,000. For these facilities, we amortized the costs of purchasing the add-on air pollution control devices over ten years. We also amortized the costs for permit fees, and purchase of plastic strip curtains and/or drip trays when required. Total costs to be amortized range from about \$90,000 to \$500,000. This equates to an annualized capital cost of about \$12,000 to \$68,000 (in 2006 dollars) over the life of the equipment.

Annual recurring costs associated with equipment maintenance and ongoing permit fee renewals are estimated to range from \$34,000 to \$150,000, with an average of about \$43,000. Combining these annual costs with amortized costs results in an annual cost of about \$46,000 to \$217,000 for purchase, installation, reports, fees, analyses, and maintenance of the equipment. The mean cost would be about \$61,000.

e. Hexavalent Chromium Plating and Chromic Acid Anodizing Facilities with Throughput of More Than 20,000 Annual Ampere-Hours Already in Substantial Compliance with the Proposal

Eighty-three facilities have been identified with throughput of more than 20,000 annual ampere-hours that already meet the emission limit. These facilities would incur compliance costs in the first year only. The average compliance cost for these facilities is about \$5,500. The costs for these facilities were estimated as described below.

All of these facilities would need to complete an initial compliance status report estimated to cost \$450. It is also assumed that these facilities would have permit renewal fees of \$700. For facilities with buffing, grinding or polishing operations we estimated costs associated with purchase of plastic strip curtains at \$1,100. Costs for purchase of drip trays for facilities with automated lines were estimated to cost \$700. Performance tests would be required of 31 facilities with an estimated cost of \$7,500 each. Based on 2003 data, five facilities would be required to conduct an additional assessment to determine if further risk reduction was needed. Cost for this site specific analysis is estimated to cost \$11,500. Thus, costs for these facilities range from \$1,150 to \$21,000, with average

compliance costs of about \$5,000. Beyond the first year, these facilities would have no additional compliance costs beyond housekeeping and recordkeeping.

6. Potential Impact on Manufacturers and Suppliers of Chromium Plating and Chromic Acid Anodizing Equipment and Chemicals

We do not expect manufacturers of chromium plating and chromic acid anodizing materials to incur any costs. However, the staff's proposal to prohibit sales of chromium plating kits to non-permitted facilities may result in lost revenue for these businesses. The proposed amendments would potentially impact the chemical manufacturers in a positive way through increased sale of chemical fume suppressants. Add-on air pollution control device manufacturers, as well as the metal fabricating industry, would also benefit from the proposed amendments as controls and ductwork for ventilation systems are purchased.

7. Potential Impact on Consumers

The potential impact of the proposed amendments to the ATCM on consumers depends upon the extent to which affected businesses are able to pass on the increased cost to consumers in terms of higher prices for their goods and services. If all costs are passed onto the consumers, we expect the cost per ampere-hour to increase by between \$0.01 to \$2.21 per ampere-hour. These costs are estimated based on facilities that would have to install add-on air pollution control devices. The lower end of this cost would represent a large facility, while the upper end cost would represent a small facility.

To put these costs into perspective consider that chromium plating an automobile bumper (a decorative chromium application) requires 10 to 12 ampere-hours (Walker, 2006). Using the cost per ampere-hour above, this would mean the increased cost of a bumper would be between \$0.12 to \$26.52. A larger automobile bumper would require 50 ampere-hours to chromium plate (Walker, 2006). This would mean the increased cost to plate a larger bumper would be under a dollar to as much as \$110 more. One current cost estimate to re-plate a bumper is \$400. Because the majority of plating is done at larger facilities we anticipate the net impact on consumers to be negligible to minor.

8. Potential Impact on Employment

Of the 226 affected businesses, 86 percent responded to our survey and provided calendar year 2003 employee data. Fifty percent reported employing 25 or fewer people. Another 30 percent reported employing between 26 to 100 people. Four businesses reported employing 1,000 or more employees. Generally, facilities with large numbers of employees have a chromium plating or anodizing process as part of the overall facility's operation. It is likely only a small number of these employees would be dedicated to conducting plating or anodizing. An example of this situation would be an aerospace company. About 25 facilities that would have substantial compliance costs employ ten or fewer people.

We expect the proposed amendments to the ATCM to adversely impact some employees.

9. Potential Impact on Business Creation, Elimination or Expansion

The proposed amendments to the ATCM would have an impact on the status of some California businesses. The compliance costs of the proposed amendments to the ATCM are expected to be significant for marginal chromium plating and chromic acid anodizing facilities as shown by the estimated impacts on the profitability of some affected businesses. The businesses subject to control requirements are expected to pass the compliance costs on to their customers, or make a business decision as to whether or not to continue operations.

10. Potential Impact on Business Competitiveness

The proposed amendments to the ATCM will not have a significant, statewide adverse impact on the ability of California businesses to compete with businesses in other states, although the competitiveness of some individual business would be adversely impacted. No other state controls emissions of hexavalent chromium from chromium plating and chromic acid anodizing businesses as stringently as does California. Most other states' requirements are limited to those of the federal Chromium Plating NESHAP, which is less stringent than the existing ATCM. Therefore, the existing ATCM creates a competitive disadvantage for some California businesses because they generally do not have compliance costs as high as out-of-state businesses.

The proposed amendments would make this existing competitive disadvantage worse for some individual businesses (i.e., those chromium plating and chromic acid anodizing businesses that would have to spend significant amounts of money to comply with the amended ATCM). However, approximately 60 percent of the existing businesses are in substantial compliance with the requirements that would be established by the proposed amendments, and would have to spend very little additional money to comply. The proposed amendments would not have a significant adverse impact on the existing competitive position of these businesses. In addition, many chromium plating and chromic acid anodizing businesses in California compete only with other California businesses. The competitive position of these businesses would also not be significantly impacted by the proposed amendments.

11. Costs to Public Agencies

Health and Safety Code section 39666 requires that, once the Board adopts the proposed amendments, the air districts implement and enforce the ATCM or adopt an equally effective or more stringent regulation. Because the air districts will have primary responsibility for implementing and enforcing the proposed amendments to the ATCM, we evaluated the potential cost to the air districts. We also evaluated the potential cost to

local and State agencies. This section provides the conclusions we reached and the basis for those conclusions.

The chromium plating and anodizing facilities affected by the proposed amendments to the ATCM are located in eight air districts, as shown in Table X-3.

Table X-3. Number of Affected Hexavalent Chromium Plating and Chromic Acid Anodizing Facilities by Air District

Location	# Affected Facilities	# Facilities Installing or Upgrading Controls	Percent of Facilities
Bay Area AQMD	18	12	8
Feather River AQMD	1	0	<1
Sacramento Metro AQMD	5	3	<1
South Coast AQMD	173	60	76
San Diego APCD	9	2	4
San Joaquin Valley APCD	17	12	8
Shasta County APCD	2	0	<1
Ventura County APCD	1	0	<1
Total	226	89	

New costs the air districts would incur as a result of the proposed amendments would be reviewing initial compliance status reports; reviewing permit modifications for facilities adding or upgrading to HEPA, or an equivalent level of control; reviewing source test protocols and results; and reviewing site specific analyses, if necessary. The air districts already review ongoing compliance status reports and permit renewals. Facilities are also regularly inspected. Therefore, we do not expect any additional costs to be incurred for performing these functions. We estimate the new costs to air districts resulting from the proposed amendments to the ATCM to be approximately \$685,000.

However, air districts can recover these costs through fees charged to the facilities. The costs to the air districts can be recovered under the fee provisions authorized by Health and Safety Code sections 42311 and 40510. Therefore, the proposed amendments to the ATCM would impose no costs on the air districts that would require the State to reimburse them pursuant to Section 6 of Article XIII B of the California Constitution and Part 7 (commencing with section 17500), division 4, title 2 of the Government Code. We are also aware that some air districts may assess costs differently than how costs were estimated for this rulemaking. However, any additional costs are also recoverable from fees assessed on facilities within their air district.

The proposed amendments to the Chromium Plating ATCM would not affect any State agency or program other than ARB. Although the air districts will have primary responsibility for enforcing the proposed amendments to the ATCM, the ARB may, at the request of an air district, provide assistance in the form of technical expertise, legal support, or other enforcement support. We estimate that providing assistance to air

districts as they adopt the proposed amendments to the ATCM would require about one-quarter person year or \$25,000 over the next three fiscal years. Review and approval of chemical fume suppressants data to affirm the chemicals meet the 0.01 milligram/ampere-hour limit would require about two person months each, or \$17,000. We expect the number of reviews to be small. These costs are absorbable within the existing ARB budget.

We also anticipate no fiscal effect on federal funding of State programs.

12. Total Cost of the Proposed Amendments to the Airborne Toxic Control Measure

Based on information provided in the ARB's 2003 Chromium Plating and Chromic Acid Anodizing Facility Survey, and applying similar compliance costs to those estimated for compliance with SCAQMD Rule 1469 (2003 dollars grown to 2006 dollars at a rate of 5 percent per year), we estimated the total cost of compliance with the proposed amendments to the ATCM. Total capital costs for purchase of add-on air pollution control devices are estimated at \$9.6 million. Total recurring costs are estimated at \$3.6 million. An additional \$1.0 million in costs are estimated for reports, source testing, permit fees, and site specific analyses. In total, costs are estimated to be \$14.2 million.

During the first year, all facilities would have compliance costs. Costs would vary depending on the extent an individual business was already in compliance with the proposed amendments. We estimate that costs in the first year would range from \$450 to about \$217,000 with an average cost of about \$23,000. In subsequent years, costs would range from near zero to \$217,000, with an average cost of \$53,000. Nine facilities would have ongoing costs over \$50,000. After the first year, 60 percent of the facilities would have no additional compliance costs.

REFERENCES

ARB, 2000. Air Resources Board. “Staff Report: Initial Statement of Reasons for Proposed Amendments to the Vapor Recovery Certification and Test Procedures for Gasoline Loading and Motor Vehicle Gasoline Refueling at Service Stations.” 2000.

Cal/EPA, 1996. California Environmental Protection Agency. Memorandum from Peter M. Rooney, Undersecretary, to Cal/EPA Executive Officers and Directors. “Economic Analysis Requirements for the Adoption of Administrative Regulations.” Appendix C (“Cal/EPA Guidelines for Evaluation Alternatives to Proposed Major Regulations”). 1996.

CPI, 2006. InflationData.com. Current Consumer Price Index. 2006 (http://www.inflationdata.com/inflation/consumer_price_index/currentCPI.asp)

D&B, 2005. Dun and Bradstreet. Duns Financial Profile - Industry Profile; SIC 3471. 2005

D&B, 2006. Dun and Bradstreet. D&B’s Business Information Report – Various Businesses. 2006

SCAQMD, 2003b. South Coast Air Quality Management District. “Draft Socioeconomic Assessment for Proposed Amendments to Rule 1469-Hexavalent Chromium Emissions from Chrome Plating and Chromic Acid Anodizing Operations and Proposed Rule 1426-Emissions from Metal Finishing Operations”. 2003

SCAQMD, 2003a. South Coast Air Quality Management District. “Draft Staff Report for Proposed Amended Rule 1469-- Hexavalent Chromium Emissions from Chrome Plating and Chromic Acid Anodizing Operations and Proposed Rule 1426- Emissions from Metal Finishing Operations.” 2003

U.S. EPA, 1995a. U.S. Environmental Protection Agency, “EPA Office of Compliance Sector Notebook Project – Profile of the Fabricated Metal Products Industry”. 1995

Walker, 2006. Air Resources Board staff telephone conversation with Howard Walker, Walker’s Custom Chrome. 2006

XI. Environmental Impacts

The main goal of these proposed amendments is to reduce the public's exposure to hexavalent chromium by achieving the maximum reduction in emissions. This is done by proposing a phase-in of HEPA filters, or equivalent for the intermediate and large size facilities, and use of chemical fume suppressants for very small facilities. The proposed amendments are especially designed to reduce exposures when chromium plating and chromic acid anodizing facilities are located near where children and people live, learn, work, and play. The proposal is also designed to have direct benefit for low income and non-white communities that have been disproportionately impacted by hexavalent chromium emissions from chromium plating and chromic acid anodizing operations. A further goal is to isolate people from any new chromium plating or chromic acid anodizing facility.

The primary benefit from the proposed amendments is a large reduction in excess cancer risk from emissions of hexavalent chromium. We estimate cancer risk would be reduced by up to 85 percent. Almost 75 percent of facilities would have cancer risk of less than one per million people exposed. About 92 percent of facilities would have cancer risk of less than ten per million people exposed.

While the reduction in cancer risk is substantial, the overall air quality benefit, in terms of mass, is negligible. Moreover, reducing the cancer risk through adoption of the proposed amendments may have an affect on other environmental factors. As described below, while there may be some potential adverse impacts, ARB staff has determined that they are not significant.

The legal requirements imposed on ARB to assess environmental impacts and our overall evaluation of the environmental impacts of the proposal are summarized below. We evaluated the potential impacts that the proposed amendments to the ATCM may have on air quality, wastewater treatment, and hazardous waste disposal.

A. Legal Requirements

The California Environmental Quality Act (CEQA) and ARB policy require an analysis to determine the potential environmental impacts of proposed regulations. ARB's program for adopting regulations has been certified by the Secretary of Resources, pursuant to Public Resources Code section 21080.5. Consequently, the CEQA environmental analysis requirements may be included in the ISOR for this rulemaking. In the ISOR, the ARB must include a functionally equivalent document, rather than adhering to the format described in CEQA of an Initial Study, a Negative Declaration, and an Environmental Impact Report. In addition, staff will respond in the Final Statement of Reasons for the proposed amendments to the ATCM to all significant environmental issues raised by the public during the 45-day public review period or at the Board hearing.

Public Resources Code section 21159 requires that the environmental impact analysis conducted by ARB include the following:

- An analysis of reasonably foreseeable environmental impacts of the methods of compliance;
- An analysis of reasonably foreseeable feasible mitigation measures; and
- An analysis of reasonably foreseeable alternative means of compliance with the proposed amendments to the ATCM.

Compliance with the proposed amendments to the Chromium Plating ATCM is expected to directly affect air quality and potentially affect other environmental media as well. Our analysis of the reasonably foreseeable environmental impacts of the methods of compliance is presented below.

B. Analysis of Reasonably Foreseeable Environmental Impacts

The proposed amendments reduce the public's exposure to hexavalent chromium emissions from chromium plating and chromic acid anodizing facilities. The methods used to reduce the public's exposure, however, will impact the environment. Our analysis of how the environment would be impacted follows.

1. Potential Air Quality Impacts

As previously discussed, hexavalent chromium is found in the particulate emissions from chromium plating and chromic acid anodizing facilities. However, the small reduction in hexavalent chromium emissions achieved from this proposal would have a negligible effect on ambient particulate levels. While the proposed amendments reduce emissions of hexavalent chromium by about 55 percent, the actual reduction in mass is about 2.2 pounds per year. Remaining emissions are estimated to be 1.8 pounds per year. However, by reducing 2.2 pounds per year of hexavalent chromium, near source cancer risk impacts would be reduced by up to about 85 percent. These reductions will occur in eight air districts, with the greatest benefits occurring in the SCAQMD.

The proposed amendments to the Chromium Plating ATCM are based on our reevaluation of BACT for reducing hexavalent chromium emissions from chromium plating and chromic acid anodizing facilities, in consideration of health risk and cost. The staff's proposal would phase-in BACT over time. The timing for application of BACT would be related to throughput and proximity to sensitive receptors.

By requiring BACT for all facilities, remaining cancer risks would be reduced by up to 85 percent. We also estimate that adoption of the staff's proposal will reduce the estimated cancer risk for 92 percent of facilities to less than or equal to ten per million exposed persons. The proposal would also isolate any new chromium plating or chromic acid anodizing facility from residential or mixed use zones by not allowing new facilities to operate in these areas. The new facility also could not operate within 150 meters of an area so zoned.

Additional indirect air quality impacts will result from the implementation of the proposed amendment to the ATCM. It is anticipated that there will be a temporary increase in emissions of criteria pollutants due to construction related activity involved in the installation of new add-on air pollution controls and the possible dismantling of current controls. Staff finds that this short-term impact will not be significant.

2. Potential Water and Wastewater Impacts

Many of the add-on air pollution control devices required by the proposed amendments require periodic water washdown to clean and maintain the integrity of the system. Implementation of housekeeping measures would likely require fresh water usage as well. This will increase the amount of freshwater used at these facilities. The increased water usage is difficult to quantify, however, we do not expect the increased use to be significant. A total of 89 facilities may increase water usage by installing add-on air pollution control devices. All of this freshwater becomes hazardous wastewater. However, water used to washdown control devices is often returned to the plating tank to reduce generation of hazardous waste.

The State Water Resources Control Board (SWRCB) regulates wastewater in California. It is illegal to dispose into the sewer system, wastewater containing hazardous substances such as hexavalent chromium. Chromium plating and chromic acid anodizing facilities are subject to these regulations. While we expect the amount of wastewater to increase due to the proposed amendments related to housekeeping and equipment maintenance, by compliance with SWRCB regulations, we do not expect this hexavalent chromium to be discharged to lakes, rivers, bays, or oceans.

Some facilities 'treat' their wastewater on site to precipitate the chromium from the water. This sludge, is also hazardous waste, but may be reused in the manufacture of stainless steel, thus further reducing the hazardous waste stream.

3. Potential Hazardous Waste Impacts

Hazardous waste is regulated in California by federal and State laws. In California, all hazardous waste must be disposed of at a facility that is registered with the Department of Toxic Substances Control (DTSC). Chromium plating and chromic acid anodizing facility wastes are classified as hazardous waste because they contain hexavalent chromium.

The proposed amendments, through housekeeping measures and disposal of HEPA filters and other pre-filters from the add-on air pollution control devices that capture hexavalent chromium, would increase the hazardous waste stream.

The use of HEPA systems is already in wide use in the chromium plating and chromic acid anodizing industry in California. These filters, as well as pre-filters designed to increase the useful life of HEPA filters, are considered hazardous waste to be disposed of in Class A landfills. The proposed amendments would require an additional 89 facilities to

begin using add-on air pollution control devices with the final collection mechanism likely to be HEPA filters. HEPA filters are usually replaced at least annually, but replacement schedules depend upon the individual operation. Pre-filters are replaced more often.

We have estimated the impact of the incremental increase in the disposal of used filters due to the implementation of the proposed ATCM as follows: For our analysis, we assumed that each of the 89 affected facilities will be disposing of three filters per year, or $89 \times 3 = 267$ filters per year. Assuming a typical filter volume of 4 cubic feet each, the resulting volume of hazardous waste generated will be 1,068 cubic feet per year (SCAQMD, 2003c). This corresponds to 2.9 cubic feet per day. We do not consider this to be a significant increase in the amount of hazardous waste to be landfilled. Moreover, staff has determined that the expected reduction in cancer risk from the proposed amendments overrides this increase in hazardous waste.

4. Potential Effect on the Environment due to Use of Persistent and Bioaccumulative Perfluorooctyl Sulfonates (PFOS)

One of the hexavalent chromium control technologies in use today employs the use of chemical fume suppressants. The most common types of surfactants used in chromium electroplating and chromic acid anodizing are fluorinated or perfluorinated compounds, or simply, fluorosurfactants (U.S. EPA, 1998).

The fluorosurfactants used as active ingredients in chemical fume suppressants are often referred to as perfluorooctyl sulfonates (PFOS). While these products are highly effective at reducing hexavalent chromium emissions by reducing plating bath surface tension the compounds have been shown to be persistent, bioaccumulative, and toxic to mammals (U.S. EPA, 2006).

Studies indicate that PFOS may have potential developmental, reproductive, and systemic toxicity. PFOS compounds have been shown to be readily absorbed orally and distribute primarily to the serum and liver. Epidemiologic studies have also shown a link between exposure and the incidence of bladder cancer. PFOS compounds have also been shown to exhibit moderate toxicity in fish, aquatic plants, invertebrates, amphibians and birds (U.S. EPA, 2006).

For these reasons, on March 10, 2006, U.S. EPA published at 40 CFR Part 721.9582, a proposal to add certain PFOS into their Significant New Use Rule for perfluoroalkyl sulfonates (PFAS). The PFOS proposed for addition include the PFOS commonly used in chemical fume suppressants.

Our survey of the industry for calendar year 2003 indicated that 190 operations were using chemical fume suppressants as a mechanism to control hexavalent chromium emissions. Almost all of these facilities are using a chemical fume suppressant using PFOS as the active ingredient. We estimate that annually, over 800 gallons of chemical fume suppressant are currently used. The staff's proposal does not require use of chemical fume suppressants except for very small operations. It is also possible that

some facilities would cease to use chemical fume suppressants as a result of the staff's proposal. However, when applications allow use of chemical fume suppressants, we expect facilities to continue using them to aid in emission reduction and to lengthen the useful life of HEPA filters.

The proposed amendments would require an additional ten facilities with throughput below 20,000 ampere-hours to either begin using chemical fume suppressants or increase use of chemical fume suppressant to reduce surface tension to below 40 dynes/centimeter. In total, we estimate the initial amount of chemical fume suppressant required to be 0.15 gallons. This is based on total ampere-hours (77,000) and the estimated use of 1.98×10^{-6} gallons of chemical fume suppressant per ampere-hour (SCAQMD, 2003b). Up to eight additional intermediate-sized facilities may begin using chemical fume suppressants if they choose to demonstrate compliance without use of an add-on air pollution control device. At most, the additional amount of chemical fume suppressant used would be three gallons. The chemical fume suppressant is usually supplied at concentrations of 5 to 10 percent PFOS. Typically, in plating/anodizing operations the concentration of PFOS in the plating/anodizing bath is 100 ppm (Atotech, 2006a).

Staff believes this estimate of additional chemical fume suppressant use to be negligible, and expect no significant impact to result from the staff's proposal.

The PFOS chemicals are not present on the finished plated part. Chemical fume suppressants are also known to break down in the plating/anodizing bath (Atotech, 2006a), although the major loss of fume suppressant is due to dragout. Dragout can be reduced by part rinsing over the tank. It has been estimated that about ten percent of the chemical fume suppressant is discharged with wastewater (Atotech, 2006a). Thus, the potential of the general public's exposure to PFOS compounds in the environment from plating and anodizing activities is low.

Staff is not aware of any product other than PFOS that would be as effective at reducing hexavalent chromium while not damaging the plated part. To eliminate the potential of PFOS from chromium plating and chromic acid anodizing activities would require use of add-on air pollution control devices for all facilities, which we have concluded is not appropriate due to costs. Therefore, staff believes that the benefit from the reduction in excess cancers through the use of chemical fume suppressants containing PFOS outweighs the potential adverse impact to the environment due to use of PFOS.

C. Reasonably Foreseeable Mitigation Measures

The California Environmental Quality Act requires an agency to identify and adopt feasible mitigation measures that would minimize any significant adverse environmental impacts described in the environmental analysis. The ARB staff has concluded that no significant adverse environmental impacts should occur from adoption of and compliance with the proposed amendments to the ATCM. Because no significant adverse impacts have been identified, no specific mitigation measures would be necessary.

D. Reasonably Foreseeable Alternative Means of Compliance

Alternatives to the proposed amendments to the Chromium Plating ATCM are discussed in Chapter IX of this report. ARB staff has concluded that the proposed amendments to the ATCM provide the most effective and least burdensome approach to reducing the public's exposure to hexavalent chromium emitted from chromium plating and chromic acid anodizing facilities.

E. Community Health and Environmental Justice

Environmental Justice is defined as the fair treatment of people of all races, cultures, and incomes with respect to the development, adoption, implementation, and enforcement of environmental laws, regulations, and policies. The ARB is committed to integrating environmental justice into all of our activities. ARB's "Policies and Actions for Environmental Justice," (Policies) establish our framework for incorporating Environmental Justice into the ARB's programs, consistent with the directive of California state law (ARB, 2001b). These Policies apply to all communities in California. However, environmental justice issues have been raised specifically in the context of low-income areas and non-white communities.

The Policies are intended to promote the fair treatment of all Californians and cover the full spectrum of the ARB's activities. Underlying these Policies is a recognition that the agency needs to engage community members in a meaningful way as it carries out its activities. People should have the best possible information about the air they breathe and what is being done to reduce unhealthy air pollution in their communities. The ARB recognizes its obligation to work closely with all communities, environmental and public health organizations, industry, business owners, other agencies, and all other interested parties to successfully implement these Policies.

During the development of the proposed amendments, ARB staff proactively identified and contacted chromium plating and chromic acid anodizing facility owners, environmental organizations, and other parties interested in chromium plating and chromic acid anodizing. These individuals participated by providing data, reviewing draft regulations, and attending public meetings in which staff directly addressed their concerns.

Staff has found, through modeling analyses, that the health risks from hexavalent chromium emissions from chromium plating and chromic acid anodizing operations tend to be localized, and have the greatest impact on near-source receptors. For these reasons, staff has proposed amendments to reduce exposures to people and children by requiring highly effective controls, and phasing in these controls most quickly at larger facilities and those located nearer to sensitive receptors. Only very small operations (less than 20,000 ampere-hours) would not be required to meet an emission rate of 0.0015 milligrams/ampere-hour. BACT for these facilities is specific chemical fume suppressants

capable of reducing emissions to 0.01 milligrams/ampere-hour. However, these small facilities would pose a cancer risk of no more than one per million exposed people. All other facilities would need to demonstrate compliance with the 0.0015 milligram/ampere-hour limit.

For facilities when application of BACT does not reduce cancer risk to below 25 per million exposed people, staff has proposed additional measures to require facilities to conduct a site specific analysis of emissions and health risk. The air districts will use this information to determine if further reductions are necessary. We estimate cancer risk would be reduced by up to 85 percent if the staff's proposal were adopted.

The proposed amendments to the ATCM are consistent with our Policies to reduce health risks from toxic air pollutants in all communities, including those with low-income and non-white populations, regardless of location. Potential health risks from hexavalent chromium emissions from chromium plating and chromic acid anodizing operations can affect both urban and rural communities. Therefore, reducing hexavalent chromium emissions from chromium plating and chromic acid anodizing operations will provide air quality benefits to urban and rural communities in the State, including low-income areas and non-white communities.

We have identified several communities that may be disproportionately impacted from hexavalent chromium emissions from chromium plating and chromic acid anodizing operations. As an example, Appendix I, Chart 1 depicts chromium plating and chromic acid anodizing facilities in the Los Angeles/Orange County area. About 160 facilities are depicted on this Chart. The area shown within the box is magnified in Chart 2. Twenty-four facilities are located within this small area. This is almost 15 percent of all facilities represented in Chart 1. In Chart 2 we have identified those areas where over 30 percent of the residents have incomes below the poverty level (hatched areas). Six facilities are located within this area. Table XI-1 shows the number of facilities located in non-white areas and in areas with a high poverty rate.

Table XI-1. Distribution of Chromium Plating and Chromic Acid Anodizing Facilities in the Los Angeles and Orange County Areas

Location	Total Number of Facilities	30 to 100% Below Poverty	Over 90% Non-white*	Combined 30 to 100% Below Poverty and Over 90% Non-white
Los Angeles and Orange Counties	160	38	80	38
Compton Area	24	6	20	6

* Non-white is defined as the sum of all other races that are not included in the "white-alone" one race category in the 2000 census data prepared by the U.S. Census Bureau.

Table XI-1 shows that half of the facilities in the Los Angeles and Orange County areas are located in areas where over 90 percent of the population is non-white. In our analysis of 2000 U.S. census data, we created the category percent non-white to serve as measure of ethnic diversity on a census tract. The percent non-white value is calculated

from the sum of all other races that are not included in the “white-alone” one-race category in the 2000 census data prepared by the U.S. Census Bureau. Of these, 38 facilities (almost 25 percent) are located in areas where the poverty level is 30 percent or more. Similarly for the Compton area, 20 facilities (about 80 percent of the facilities shown in Chart 2) are located in non-white areas, with six of these facilities located in areas where the poverty level exceeds 30 percent. Staff believes this concentration of plating/anodizing operations in low-income and non-white communities has created disproportionate impacts from hexavalent chromium emissions from chromium plating and chromic acid anodizing facilities. Because the proposed amendments to the ATCM would greatly reduce these emissions in residential areas, these communities would realize a major portion of the benefits from the proposal.

To further address environmental justice and the public’s concern about developing cancer from exposure to hexavalent chromium emissions at all locations, including currently heavily impacted communities, the proposed amendments to the ATCM establish criteria for the operation of new chromium plating and anodizing facilities. Staff is proposing that any new facility would not be able to operate in any area zoned as residential or mixed use, or within 150 meters of a residential or mixed use zone. Also, new chromium plating and chromic acid anodizing facilities would be required to install add-on air pollution control devices that provide the maximum hexavalent chromium reduction and undergo a site-specific analysis to ensure adequate protection of public health. These criteria will help ensure that new chromium plating and chromic acid anodizing facilities are not operated in areas where people live.

We believe these criteria are necessary to protect people from exposures to hexavalent chromium, an extremely potent, known human carcinogen. While we believe these precautions are necessary in this case, similar requirements may not be appropriate for sources of other TACs. Each TAC should be evaluated on a case by case basis to determine the appropriate methods to protect public health and reduce exposure.

REFERENCES

ARB, 2001b. Air Resources Board. "Policies and Actions for Environmental Justice". 2001

Atotech, 2006a. Atotech USA Inc, GW Walker. Draft Letter to US EPA regarding proposed amendments to the Significant New Use Rule (SNUR) for perfluoroalkyl sulfonates (Docket ID: EPA-HQ-OPPT-2005-0015). 2006.

SCAQMD, 2003b. South Coast Air Quality Management District. "Draft Socioeconomic Assessment for Proposed Amendments to Rule 1469-Hexavalent Chromium Emissions from Chrome Plating and Chromic Acid Anodizing Operations and Proposed Rule 1426-Emissions from Metal Finishing Operations". 2003

SCAQMD, 2003c. South Coast Air Quality Management District, "Final Environmental Assessment: Proposed Rule 1426 – Emissions from Metal Finishing Operations; and, Proposed Amended Rule 1469 – Hexavalent Chromium Emissions from Chrome Plating and Chromic Acid Anodizing Operations." 2003

U.S. EPA, 1998. U.S. Environmental Protection Agency. EPA/625/R-98/002: "Capsule Report Hard Chrome Fume Suppressants and Control Technologies". 1998.

U.S. EPA, 2006. U.S. Environmental Protection Agency. 40 CFR Part 721: "Perfluoroalkyl Sulfonates; Proposed Significant New Use Rule." 2006.

